

Oracle Financial Services Customer Screening

Administration Guide

Release 8.1.2.3.0

September 2023

F22546-01

ORACLE®

Financial Services

Customer Screening Administration Guide

Copyright © 2023 Oracle and/or its affiliates. All rights reserved.

This software and related documentation are provided under a license agreement containing restrictions on use and disclosure and are protected by intellectual property laws. Except as expressly permitted in your license agreement or allowed by law, you may not use, copy, reproduce, translate, broadcast, modify, license, transmit, distribute, exhibit, perform, publish, or display any part, in any form, or by any means. Reverse engineering, disassembly, or decompilation of this software, unless required by law for interoperability, is prohibited.

The information contained herein is subject to change without notice and is not warranted to be error-free. If you find any errors, please report them to us in writing.

If this is software or related documentation that is delivered to the U.S. Government or anyone licensing it on behalf of the U.S. Government, then the following notice is applicable:

U.S. GOVERNMENT END USERS: Oracle programs, including any operating system, integrated software, any programs installed on the hardware, and/or documentation, delivered to U.S. Government end users are “commercial computer software” pursuant to the applicable Federal Acquisition Regulation and agency-specific supplemental regulations. As such, use, duplication, disclosure, modification, and adaptation of the programs, including any operating system, integrated software, any programs installed on the hardware, and/or documentation, shall be subject to license terms and license restrictions applicable to the programs. No other rights are granted to the U.S. Government.

This software or hardware is developed for general use in a variety of information management applications. It is not developed or intended for use in any inherently dangerous applications, including applications that may create a risk of personal injury. If you use this software or hardware in dangerous applications, then you shall be responsible to take all appropriate fail-safe, backup, redundancy, and other measures to ensure its safe use. Oracle Corporation and its affiliates disclaim any liability for any damages caused by use of this software or hardware in dangerous applications.

Oracle and Java are registered trademarks of Oracle and/or its affiliates. Other names may be trademarks of their respective owners.

Intel and Intel Xeon are trademarks or registered trademarks of Intel Corporation. All SPARC trademarks are used under license and are trademarks or registered trademarks of SPARC International, Inc. AMD, Opteron, the AMD logo, and the AMD Opteron logo are trademarks or registered trademarks of Advanced Micro Devices. UNIX is a registered trademark of The Open Group.

This software or hardware and documentation may provide access to or information about content, products, and services from third parties. Oracle Corporation and its affiliates are not responsible for and expressly disclaim all warranties of any kind with respect to third-party content, products, and services unless otherwise set forth in an applicable agreement between you and Oracle. Oracle Corporation and its affiliates will not be responsible for any loss, costs, or damages incurred due to your access to or use of third-party content, products, or services, except as set forth in an applicable agreement between you and Oracle.

For information on third party licenses, click [here](#).

Document Control

Table 1: Document Control

Version Number	Revision Date	Change Log
8.1.2.3.3	May 2022	<ul style="list-style-type: none">Added Appendix P: Configurations Required to Open ECM Case or CSAM Alert from RT Screening if RT Screening and ECM/CSAM are in Different Servers section.Added Appendix O: CS and ECM Table Mapping for Alert Status Customization section.
8.1.2.3.0	December 2022	<ul style="list-style-type: none">Added Appendix N: Adding New Alert Level Action and Standard Comments section.Added Configuring the New Priority section.Added information about enhanced UI experience in the Queue, Alert List, and Alert Details which support more than the high, medium, and low classifications per queue in Grid View section.

Table of Contents

1	About This Guide.....	9
1.1	Intended Audience.....	9
1.2	Access to Oracle Support	9
1.3	How this Guide is Organized.....	9
1.4	Where to Find More Information	10
1.5	Conventions Used in This Guide.....	10
2	Introduction	12
2.1	Architecture Overview.....	12
3	Getting Started.....	13
3.1	Accessing the Financial Services Analytical Applications Customer Screening Home Page	13
3.2	Managing the Oracle Financial Services Analytical Applications (OFSAA) Page	14
3.3	Queue Management.....	14
3.3.1	<i>List View</i>	15
3.3.2	<i>Grid View</i>	16
3.3.3	<i>Configuring the New Priority</i>	17
3.3.4	<i>Archiving a Queue</i>	20
3.4	Troubleshooting Your Display.....	22
3.4.1	<i>Enabling JavaScript</i>	22
3.4.2	<i>Enabling Cookies</i>	23
3.4.3	<i>Enabling Temporary Internet Files</i>	23
3.4.4	<i>Enabling File Downloads</i>	23
3.4.5	<i>Setting Printing Options</i>	23
3.4.6	<i>Enabling the Pop-Up Blocker</i>	23
3.4.7	<i>Setting Preferences</i>	24
4	General Configurations	25
4.1	Due Date and Time Configuration.....	25
4.2	Setting the Priority.....	28
4.3	Security Mapping	28
4.4	Preparing Watch List Data.....	29
4.4.1	<i>Example - Preparing the Accuity List</i>	30

4.4.2	<i>Example - Enable Phases for Download and Staging</i>	30
4.5	Private Watch List Set Up	30
4.6	Showing the Hidden Watch List Staged Data or Snapshots in the Server Console Interface.....	31
4.7	Analyzing Watch List Data.....	32
4.7.1	<i>Analyzing Data Quality</i>	32
4.8	Configuring Match Rules and Clusters for Customers and External Entities.....	32
4.9	Real-Time and Batch Screening Set Up	33
4.10	Extracting the Output of Matches into CSV Files	33
4.11	Filtering Watch List Data.....	33
4.11.1	<i>Enabling Watch List Filtering</i>	33
4.11.2	<i>Configuring Watch List Filtering</i>	34
4.11.3	<i>Primary Filters, Secondary Filters, and Filters for Linked Profiles</i>	36
4.11.4	<i>Setting Multiple Values for Primary and Secondary Filters</i>	37
4.11.5	<i>Screening All Sanctions Data</i>	42
4.11.6	<i>Match Persistence and Flag Keys</i>	42
4.12	Risk Scoring in Watch Lists	43
4.12.1	<i>Adjusting the Risk Scores</i>	43
4.12.2	<i>Editing the Risk Element Scores</i>	43
4.13	Scheduling the Customer Screening Run Job	48
4.14	Enabling L2 Investigation for Customer Screening	50
4.15	Loading Data	52
4.15.1	<i>Loading Data into the Customer Tables (Full Load)</i>	52
4.15.2	<i>Loading Data into the Customer Tables (Delta Load)</i>	53
4.15.3	<i>Creating and Running Parallel Batches</i>	56
4.16	Configurations for General Data Protection Regulation (GDPR)	61
4.17	Optional Configurations	64
4.17.1	<i>Data Quality Check</i>	64
4.17.2	<i>Sorting Real-Time Watchlist Details</i>	65
5	Integrations with Enterprise Case Management	66
5.1	Case Class in ECM	66
5.2	Case Types under Case Class	67

5.3	Case Correlation, Linked Cases, and Searching for Cases	67
5.4	Creating Workflows for Case Types	68
5.5	Workflow Diagrams	68
5.5.1	<i>SAN and PRB Workflow</i>	68
5.5.2	<i>PEP and EDD Workflow</i>	69
5.6	Taking Actions on Customer Screening-related Cases	69
5.7	Setting Thresholds for Case Priorities	70
5.8	Merging Case Types	70
6	Real-Time Screening.....	74
6.1	Configuring the EDQ URL.....	75
6.2	Screening Watch List Records in Real-Time	77
6.2.1	<i>Field Descriptions</i>	82
6.3	Running the Real-Time Screening Job.....	82
6.4	Adding a New Field in a Webservice	83
7	Batch Screening.....	88
7.1	Configuring the EDQ URL.....	89
7.2	Staging Database Connection Details.....	90
7.3	Enabling Customer and External Entity Tables	92
7.4	Data Preparation in FCDM.....	93
7.4.1	<i>Establishing a JDBC Database Connection using WebLogic</i>	93
7.5	Analyzing the Data Quality of Customer Data and External Entity	96
7.5.1	<i>Data Quality Errors</i>	100
7.6	Extract Transform Load (ETL) Database Connection Details.....	101
7.7	Running the Batch Screening Job	104
7.8	Generating Alerts	105
7.9	Suppression of Alerts	107
7.10	Configuring Additional Columns on the Alert List page.....	107
8	Appendix A: Screening Non-Latin Character Sets.....	109
8.1	Original Script Matching.....	109
9	Appendix B: Reference Data Tables for Watch Lists	111
10	Appendix C: Preconfigured Watch List Information	113

10.1	HM Treasury Watch List	113
10.2	OFAC Watch List.....	113
10.3	EU Watch List	113
10.4	UN Consolidated Watch List	114
10.5	World-Check Watch List	114
10.6	Dow Jones Watch List	115
10.7	Dow Jones Anti-Corruption Watch List.....	118
10.8	Accuity Watch List.....	121
10.8.1	<i>Using the Accuity Group File</i>	<i>121</i>
10.8.2	<i>Configuring the .sh File</i>	<i>124</i>
10.9	Delta Watch List Configurations for the Dow Jones Watch List.....	127
10.9.1	<i>Configurations for the Full and Delta Watch Lists</i>	<i>128</i>
10.9.2	<i>Running the Full Watch list</i>	<i>128</i>
10.9.3	<i>Running the Delta Watch List</i>	<i>129</i>
10.9.4	<i>Merging the Delta Watch List to the Full Watch List</i>	<i>129</i>
10.10	Delta Watch List Configurations for the World-Check Watch List.....	129
10.10.1	<i>Configurations for the Full and Delta Watch Lists</i>	<i>130</i>
10.10.2	<i>Running the Full Watch list</i>	<i>130</i>
10.10.3	<i>Running the Delta Watch List</i>	<i>131</i>
10.10.4	<i>Merging the Delta Watch List to the Full Watch List</i>	<i>132</i>
11	Appendix D: Splitting Jobs Using Multiple EDQ Servers	133
11.1	Adding Input Parameters for the CalledEQ Task	141
12	Appendix E: Viewing Snapshots of Tables in EDQ.....	143
13	Appendix F: Configurations for the Bearer Token	146
13.1	Generate User Password.....	146
13.2	Change Token Validity.....	148
13.3	Generate Token	149
13.4	Send Requests	150
14	Appendix G: Error Logs.....	152
14.1	EDQ Failure.....	152
14.2	Data Model Failure.....	152

14.3	Batch Failure.....	152
14.4	DM Utility Failure.....	152
15	Appendix H: Out Of Box process to move Alerts from CS_ALERTS of one DB instance to FCC_ZCS_ALERTS of another DB instance	153
16	Appendix I: API to create the Alerts in the Zipper Alerts table (FCC_ZCS_ALERTS)	155
17	Appendix J: PMF Configurations for Pool of Analyst.....	156
17.1	List of Attributes Passed to Workflow.....	164
17.2	Attribute to Configure the Auto Refresh in Queue Management	165
18	Appendix K: Invoking the PMF Workflow from backend.....	1
19	Appendix L: Mapping the PMF Workflow for Different Jurisdiction and domain.....	1
20	Appendix M: User Group Customization	1
21	Appendix N: Adding New Alert Level Action and Standard Comments.....	1
22	Appendix O: CS and ECM Table Mapping for Alert Status Customization.....	1
23	Appendix P: Configurations Required to Open ECM Case or CSAM Alert from RT Screening if RT Screening and ECM/CSAM are in Different Servers	1
23.1	Configure REFERRER-POLICY-ENABLED	1
23.2	Configure ALLOWED-REFERRER-URLS.....	1
24	OFSAA Support	2
25	Send Us Your Comments.....	3

1 About This Guide

This guide explains the concepts of Oracle Financial Services Customer Screening (OFS CS) and provides step-by-step instructions to navigate to the Customer Screening web pages, analyzing, acting on, and researching the business information.

1.1 Intended Audience

The instructions in this guide are written with the assumption that the user has a good understanding of Enterprise Case Management (ECM), Financial Crime Data Model (FCDM), Oracle Enterprise Data Quality (OEDQ) and has knowledge of Sanctions (SAN), Politically Exposed Persons (PEP), Enhanced Due Diligence (EDD), and Country Prohibition Screening (PRB). The Customer Screening User Guide is designed for the following users:

- **Analyst:** This user works on the alerts within the application frequently. This user's specific role determines what they can view and perform within the application.
- **Supervisor:** This user works on the alerts within the application daily and is typically a higher-level Analyst or Compliance Officer.

1.2 Access to Oracle Support

Oracle customers have access to electronic support through [My Oracle Support \(MOS\)](#). For information, visit <http://www.oracle.com/pls/topic/lookup?ctx=acc&id=info> Or visit <http://www.oracle.com/pls/topic/lookup?ctx=acc&id=trs> if you are hearing-impaired.

1.3 How this Guide is Organized

The Customer Screening User Guide includes the following chapters:

- [Introduction](#) provides an overview of Customer Screening and the architecture used.
- [Getting Started](#) explains common elements of the interface and how to configure the **Financial Services Analytical Applications Customer Screening** home page.
- [General Configurations](#) provides information on how to prepare watch list data, configure the different property files in Customer Screening, how to download the full and delta watch lists, how to filter watch list data, and how to configure General Data Protection Regulations (GDPR) for users.
- [Integrations with Enterprise Case Management](#) provides information on the different cases classes used for Customer Screening in Enterprise Case Management, view the correlation rules, what cases are linked to the case being investigated, and the workflows used for the different case types.
- [Real-Time Screening](#) shows the real-time user interface used for Customer Screening and how to run the real-time screening job using the Financial Data Crime Model (FCDM).
- [Batch Screening](#) provides information on how to prepare and analyze data and how to run the batch screening job using the Financial Data Crime Model (FCDM).
- [Appendix A: Screening Non-Latin Character Sets](#) provides information on how to perform matching for non-Latin data.
- [Appendix B: Risk Scoring Reference Data](#) shows the different reference data tables used to calculate risk scores in Customer Screening.

- [Appendix C: Preconfigured Watch List Information](#) provides information on the different watch lists used in Customer Screening.
- [Appendix D: Splitting Jobs Using Multiple EDQ Servers](#) provides information on splitting jobs across multiple servers.
- [Appendix E: Viewing Snapshots of Tables in EDQ](#) provides information on the EDQ table UI.
- [Appendix F: Configurations for the Bearer Token](#) provides information on the Bearer Token configuration.
- [Appendix G: Error Logs](#) provides information on the types of failure encounters.
- [Appendix H: Out Of Box process to move Alerts from CS_ALERTS of one DB instance to FCC_ZCS_ALERTS of another DB instance](#) provides information on
- [Appendix I: API to create the Alerts in the Zipper Alerts table \(FCC_ZCS_ALERTS\)](#) provides information on steps to configure system to create Zipper Alerts.
- [Appendix J: PMF Configurations for Pool of Analyst](#) provides information on PMF configuration.
- [Appendix K: Invoking the PMF Workflow from backend](#) provides information on invoking the PMF Workflow from backend for the Alert.

1.4 Where to Find More Information

For more information about Oracle Financial Services Customer Screening, see the following Customer Screening application documents, which can be found on the [Oracle Help Center](#) page:

- Oracle Financial Services Customer Screening Matching Guide
- Oracle Financial Services Customer Screening Data Interfaces Guide

To find additional information about how Oracle Financial Services solves real business problems, see our website at [Oracle for Financial Services home page](#).

1.5 Conventions Used in This Guide

The following table mentions the conventions used in this guide.

Table 1: Conventions Used

Conventions	Meaning
<i>Italics</i>	Names of books as references Emphasis Substitute input values
Bold	Menu names, field names, options, button names Commands typed at a prompt User input
Monospace	Directories and subdirectories File names and extensions Code sample, including keywords and variables within text and as separate paragraphs, and user-defined program elements within text
Hyperlink	Hyperlink type indicates the links to external websites, internal document links to sections.

Table 1: Conventions Used

Conventions	Meaning
Asterisk (*)	Mandatory fields in User Interface
<Variable>	Substitute input value

2 Introduction

Oracle Financial Services Customer Screening (OFS CS) enables organizations to effectively and efficiently screen their customers so that they can successfully meet anti-bribery, anti-corruption, export control, and other legal regulations as well as to meet anti-money laundering and counter-terrorist financing legislations. Screening customers enables organizations to keep track of and avoid the risk of being exposed to suspicious or sanctioned individuals and organizations. Customer Screening uses the Oracle Enterprise Data Quality (OEDQ) platform to manage watch list data and apply match rules, Process Modelling Framework (PMF) to generate alerts, and Enterprise Case Management (ECM) to investigate cases generated from the alerts based on the match rules.

2.1 Architecture Overview

This image shows the movement of data from a real-time data source, data from watch list sources such as OFAC, HM Treasury, and Dow Jones. This data then moves to the Customer Screening user interface where it is prepared and screened. Finally, cases are generated based on the matches in Enterprise Case Management (ECM). We have also introduced Alert Management for L1 investigation for rapid dispositioning of Alerts (optional).

Figure 1: Customer Screening Architecture

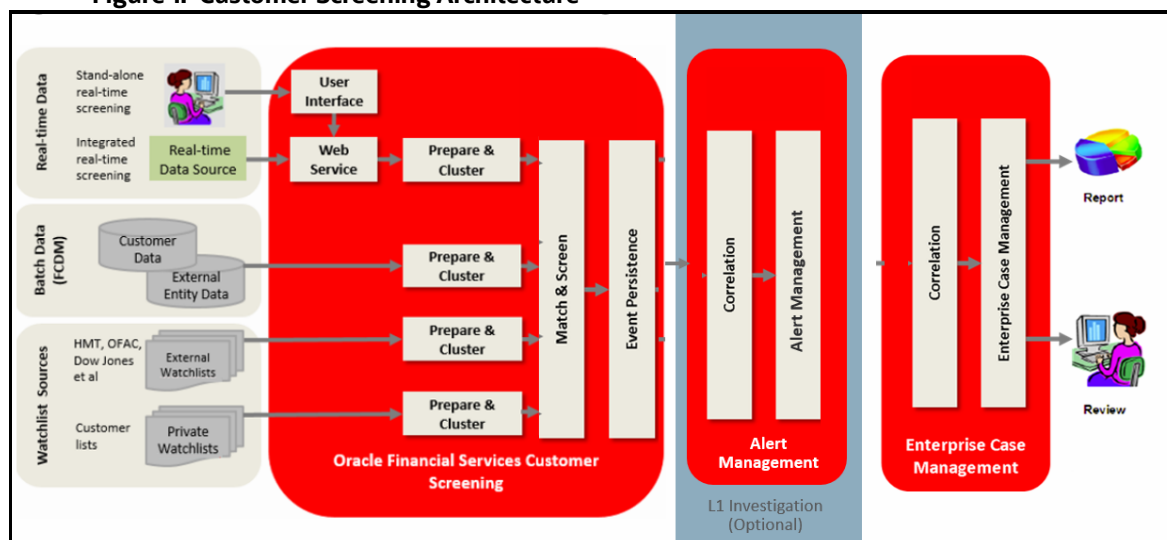

3 Getting Started

This chapter provides step-by-step instructions to login to the Oracle Financial Services Customer Screening (OFS CS) application and the different features of the application.

3.1 Accessing the Financial Services Analytical Applications Customer Screening Home Page

Access to the Customer Screening application depends on the Internet or Intranet environment. The system administrator provides the intranet address uniform resource locator (URL), User ID, and Password.

NOTE The first time you log in, you will be prompted to change your password.

To access the Oracle **Financial Services Analytical Applications Customer Screening** home page, follow these steps:

1. Enter the URL into your browser using the following format:

```
<scheme/ protocol>://<ip address/ hostname>:<port>/<context-name>/login.jsp
```

For example: `https://myserver:9080/ofsaapp/login.jsp`

The **Oracle Financial Services Analytical Applications (OFSAA)** login page is displayed.

Figure 2: Oracle Financial Services Analytical Applications (OFSAA) Login Page

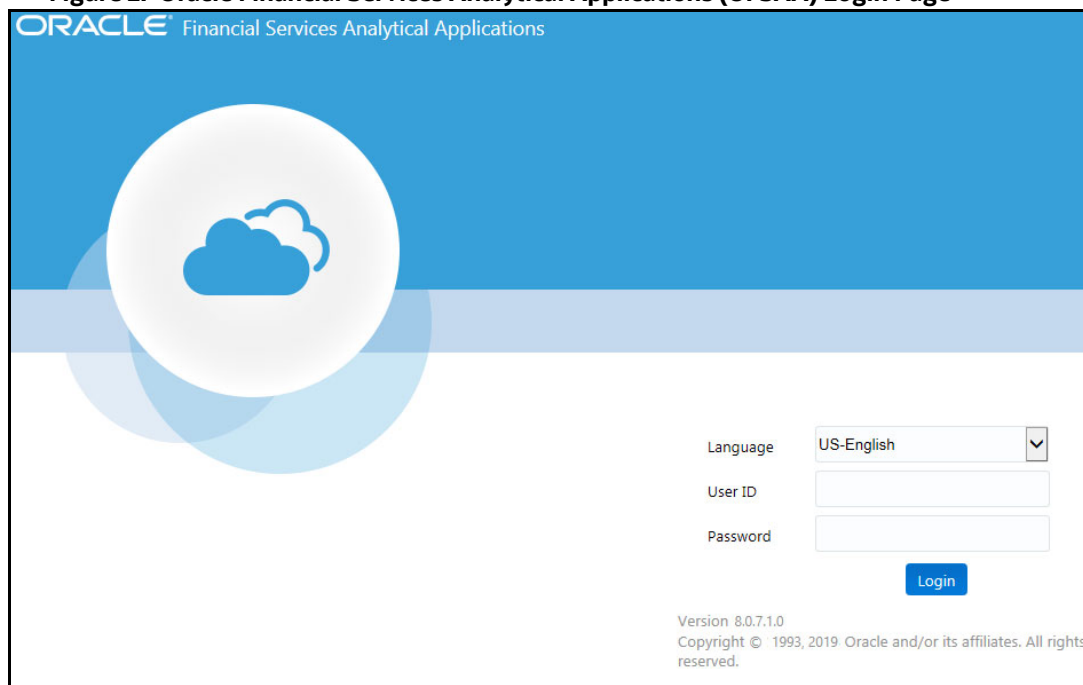

2. Select the language from the **Language** drop-down list. This allows you to use the application in the language of your selection.
3. Enter your User ID and Password in the respective fields.
4. Click **Login**. The **Financial Services Analytical Applications Customer Screening** home page is displayed.

Figure 3: Financial Services Analytical Applications Customer Screening Home Page

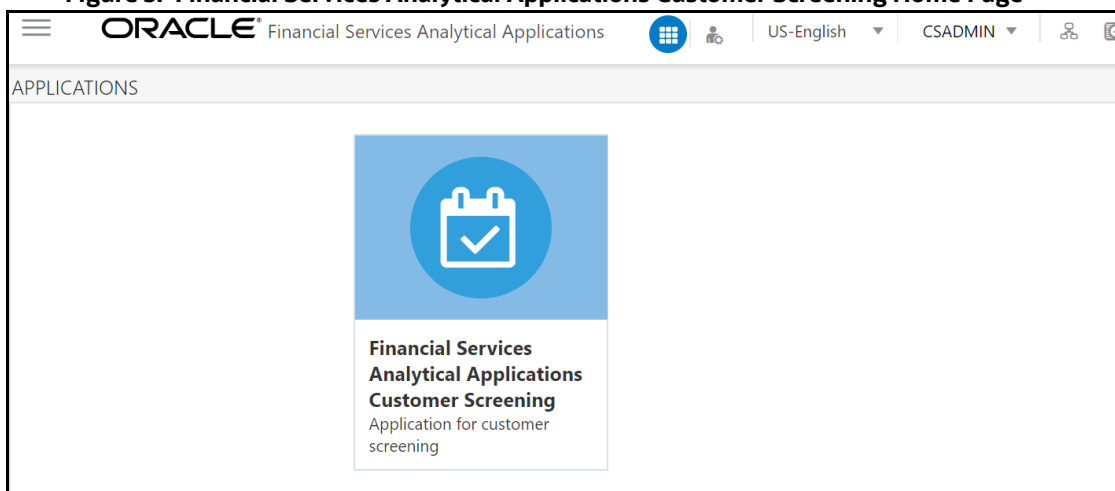

Click the **Financial Services Analytical Applications Customer Screening** tile to open the OFS CS home page.

3.2 Managing the Oracle Financial Services Analytical Applications (OFSAA) Page

From the OFSAA application page, you can access the menus for the different message configurations. For information on the different menus, see [Oracle Financial Services Analytical Applications Infrastructure Administration and Configuration Guide](#).

NOTE

To create, edit user definitions, view, manage, modify, and delete user information, see the User Maintenance section in the [Oracle Financial Services Advanced Analytical Applications Infrastructure User Guide 8.11.0.0](#).

3.3 Queue Management

Queue Management is a common dashboard where the following users can see queues related to CS and TF that are created by the Queue Administrator and the system (Out Of Box):

- Analyst
- Supervisor
- Senior Supervisor
- Queue Administrator

You can view the Queue details in the following formats:

- [List View](#)

- **Grid View**

By default, queue details are displayed in the List View. Only queue admin can assign the user groups for the queues in the Grid View.

For more information on Queue Administrator, see the **OFS Sanctions Queue Management User Guide**.

3.3.1 List View

1. Log in to the application as Analyst, Supervisor, or Senior Supervisor.
2. Select the Financial Services Analytical Applications Transaction Filtering.
3. From the Application Navigation List, select Queue Management.









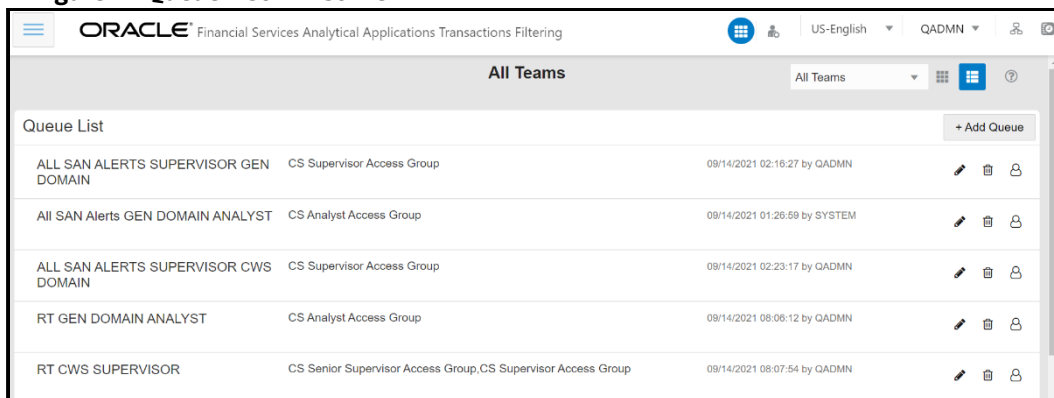





You can select the **hamburger**  icon to view the **Queue List** for **All Teams** in List View.

By default, queue details are displayed in the List View.

Queue List displays the queues assigned to all user groups and the value. **All Team** is selected in the drop-down list and is disabled. It is displayed as the title for Queue List.

Figure 4: Queue List in List View



All Teams			
Queue List			+ Add Queue
ALL SAN ALERTS SUPERVISOR GEN DOMAIN	CS Supervisor Access Group	09/14/2021 02:16:27 by QADMN	  
All SAN Alerts GEN DOMAIN ANALYST	CS Analyst Access Group	09/14/2021 01:26:59 by SYSTEM	  
ALL SAN ALERTS SUPERVISOR CWS DOMAIN	CS Supervisor Access Group	09/14/2021 02:23:17 by QADMN	  
RT GEN DOMAIN ANALYST	CS Analyst Access Group	09/14/2021 08:06:12 by QADMN	  
RT CWS SUPERVISOR	CS Senior Supervisor Access Group, CS Supervisor Access Group	09/14/2021 08:07:54 by QADMN	  

The following details are displayed in the List View for **All Team**:

- Queue Name
- User Group names (that are assigned by the Queue Administrator)
- Date Time Created By (For example, 09/09/2021 14:06:39 by QADMIN/SYSTEM)
- Queue Action

You can view ten queues in Queue List and use the navigation to view the next set of queues.

You can perform the following actions on each queue:

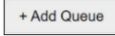
- **+Add Queue:** Click  button top-right in the Queue List to add a new queue. (only for Queue Admin.)
- **Delete:** Click the Ellipsis menu and then select Delete and click **Yes** to delete the queue.
- **Edit:** Click the Ellipsis menu and then select Edit to edit the queue details and click **Finish**.
- **Open:** Click the Ellipsis menu and then select Open to open the queue to see its details.
- **Assign:** Click the Ellipsis menu and then select Assign to assign the queue to Groups. (only for Queue Admin)

- Select the **Groups** to assign the queue.
- Click **Assign**.

You can change the order of queues as follows:

- According to your requirement, you can select the Queue to change the order, drag and drop in the list.
- Perform the following steps:
 - a. Select the Queue and right-click. The menu options are displayed as **Cut**, **Paste Before**, and **Paste After**. The only **Cut** is enabled.
 - b. Select **Cut**.
 - c. Locate the cursor wherever it needs to be added and right-click. The menu options are **Cut**, **Paste Before**, and **Paste After**. Only **Paste Before** and **Paste After** are enabled.
 - d. Select the **Paste Before** or **Paste After** to place the Queue.

3.3.2 Grid View

You can select the **thumbview**  icon to view the **Queue List** for **All Teams** in Grid View.

Queue List displays the queues assigned to all user groups and the value. **All Team** is selected in the drop-down list and is disabled. It is displayed as the title for Queue List.

Figure 5: Queue List in Grid View

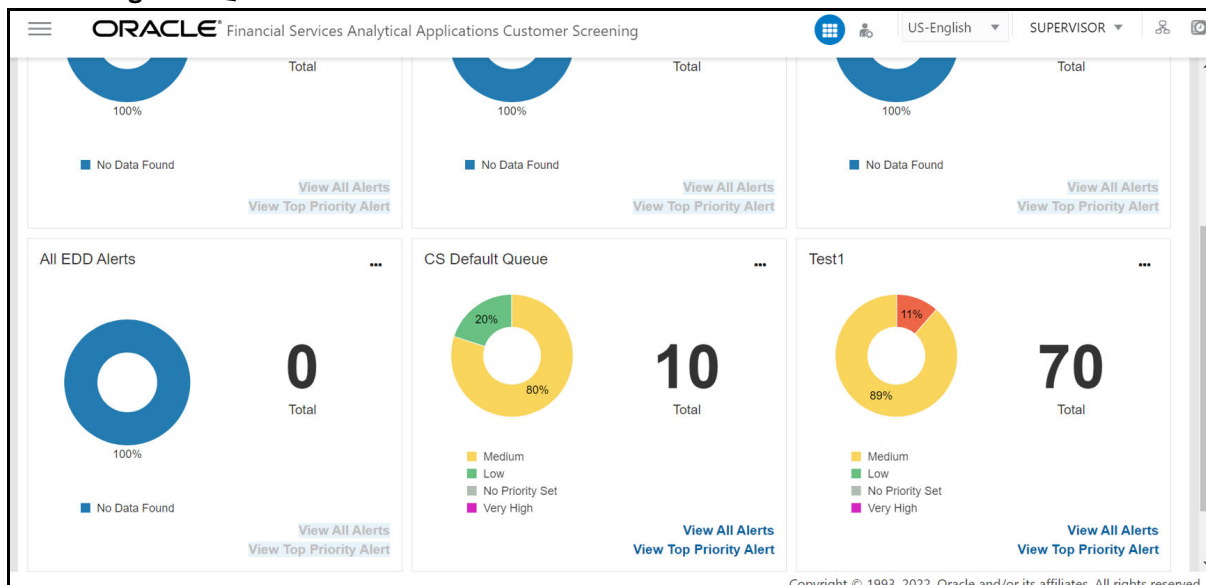

NOTE

Only Analyst/Supervisor/Senior Supervisor can view the number of alerts details in each Queue.

The Queue List appears in doughnut charts displays each cell's data as a slice of a doughnut. A pie chart data visualization uses a single circle divided into "slices," each slice representing a numerical proportion of the whole circle's value. Hover over the slices to see the details of the **Series** and the **Value** of the queue.

By default, the color-coding displayed for three priorities of the alerts and the **Total** numeric value indicates the number of alerts in that Queue.

The following are the default priorities in the application:

- High
- Medium
- Low

An admin can configure any number of priorities and color code that needs to be displayed on the Queue Management Dashboard against each of the priority based on their requirement in the backend based on the match score, screening type, event type, jurisdiction and business domain.

The Queue Management dashboard displays all the priorities defined by the admin and the number of alerts meeting the priority condition. If there are alerts which doesn't fall under any priority criteria are displayed as **No Priority Set**.

To configure the priorities and color code see [Configuring the New Priority](#) section.

Priority configuration for all the alerts to be defined before customer screening.

You can view six queues in Queue List and use the navigation to view the next set of queues.

You can perform the following actions on each queue:

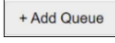
- **+Add Queue:** Click  button top-right in the Queue List to add a new queue. (only for Queue Admin.)
- **Delete:** Click the Ellipsis menu and then select Delete and click **Yes** to delete the queue.
- **Edit:** Click the Ellipsis menu and then select Edit to edit the queue details and click **Finish**.
- **Open:** Click the Ellipsis menu and then select Open to open the queue to see its details.
- **Assign:** Click the Ellipsis menu and then select Assign to assign the queue to Groups. (only for Queue Admin)
 - Select the **Groups** to assign the queue.
 - Click **Assign**.

3.3.3 Configuring the New Priority

To configure the priority and color code for the alerts, follow the below steps:

1. Access the Atomic Schema and access the `FCC_ZCS_ALERT_PRIORITY_DIM` table.
2. Change the following parameter value:
 - `N_ALERT_PRIORITY_ID`
 - `V_ALERT_PRIORITY_CODE`
 - `V_ALERT_PRIORITY_NAME`
 - `V_ALERT_PRIORITY_DSPLY_COLR`

Figure 6: FCC_ZCS_ALERT_PRIORITY_DIM Table

N_ALERT_PRIORITY_ID	V_ALERT_PRIORITY_CODE	V_ALERT_PRIORITY_NAME	V_ALERT_PRIORITY_DSPLY_COLR
1	H	High	#ED6647
2	M	Medium	#FAD55C
3	L	Low	#68C182
4	NP	No Priority Set	#B2BEB5
5	Z	Very High	#D625C0

```

MERGE INTO FCC_ZCS_ALERT_PRIORITY_DIM T USING (
    SELECT '4' N_ALERT_PRIORITY_ID, 'B' V_ALERT_PRIORITY_CODE, 'Lower
Medium' V_ALERT_PRIORITY_NAME, '#25C0D6' V_ALERT_PRIORITY_DSPLY_COLR
FROM DUAL) S
    ON ( T.N_ALERT_PRIORITY_ID = S.N_ALERT_PRIORITY_ID )
    WHEN MATCHED THEN UPDATE SET T.V_ALERT_PRIORITY_CODE =
S.V_ALERT_PRIORITY_CODE, T.V_ALERT_PRIORITY_NAME =
S.V_ALERT_PRIORITY_NAME, T.V_ALERT_PRIORITY_DSPLY_COLR =
S.V_ALERT_PRIORITY_DSPLY_COLR
    WHEN NOT MATCHED THEN INSERT
(N_ALERT_PRIORITY_ID,V_ALERT_PRIORITY_CODE,V_ALERT_PRIORITY_NAME,V_ALERT
_PRIORITY_DSPLY_COLR)
VALUES
(S.N_ALERT_PRIORITY_ID,S.V_ALERT_PRIORITY_CODE,S.V_ALERT_PRIORITY_NAME,S
.V_ALERT_PRIORITY_DSPLY_COLR)
/

```

3. Access the FCC_ZCS_ALERT_PRIORITY_TL table.
4. Change the following parameter value:
 - V_ALERT_PRIORITY_CODE
 - V_ALERT_PRIORITY_NAME
 - V_LOCALE

NOTE

The FCC_ZCS_ALERT_PRIORITY_DIM table and FCC_ZCS_ALERT_PRIORITY_TL table must have the same parameter value entry.

Figure 7: FCC_ZCS_ALERT_PRIORITY_TL Table

	V_ALERT_PRIORITY_CODE	V_ALERT_PRIORITY_NAME	V_LOCALE
1	H	High	en_US
2	M	Medium	en_US
3	L	Low	en_US
4	A	Very Low	en_US
5	NP	No Priority Set	en_US
6	Z	Very High	en_US

```

MERGE INTO FCC_ZCS_ALERT_PRIORITY_TL T USING (
    SELECT 'B' V_ALERT_PRIORITY_CODE, 'Lower Medium' V_ALERT_PRIORITY_NAME,
    'en_US' V_LOCALE FROM DUAL) S
    ON ( )
    WHEN MATCHED THEN UPDATE SET T.V_ALERT_PRIORITY_CODE =
    S.V_ALERT_PRIORITY_CODE, T.V_ALERT_PRIORITY_NAME =
    S.V_ALERT_PRIORITY_NAME, T.V_LOCALE = S.V_LOCALE
    WHEN NOT MATCHED THEN INSERT
    (V_ALERT_PRIORITY_CODE,V_ALERT_PRIORITY_NAME,V_LOCALE)
    VALUES
    (S.V_ALERT_PRIORITY_CODE,S.V_ALERT_PRIORITY_NAME,S.V_LOCALE)
/

```

The priority for the new alerts are decided based on the score configured for the priority.

To define the priority and color code for the new alerts created based on the score, follow the below steps:

1. Access the Atomic Schema and access the `FCC_ZCS_ALERT_PRIORITY_CONF` table.
2. Change the following parameter value:
 - `N_ALERT_PRIORITY_SEQ`
 - `V_ALERT_PRIORITY_CODE`
 - `N_ALERT_PRIORITY_MIN_SCORE`
 - `N_ALERT_PRIORITY_MAX_SCORE`
 - `V_ALERT_TYPE_CODE`

Figure 8: FCC ZCS ALERT PRIORITY CONF Table

N_ALERT_PRIORITY_SEQ	V_ALERT_PRIORITY_CODE	N_ALERT_PRIORITY_MIN_SCORE	N_ALERT_PRIORITY_MAX_SCORE	V_ALERT_TYPE_CODE	V_JRSDCN_CD	V_BUS_DMN_LIST_TX
1	47 A	0		01 CS_EE_EDD	AMEA	a
2	38 A	0		01 CS_PEP	AMEA	a
3	42 A	0		01 CS_EE_PEP	AMEA	a
4	46 A	0		01 CS_EE_PFB	AMEA	a
5	44 A	0		01 CS_RT_PEP	AMEA	a
6	41 A	0		01 CS_EE_SAN	AMEA	a
7	48 A	0		01 CS_RT_PFB	AMEA	a
8	43 A	0		01 CS_RT_EDD	AMEA	a
9	39 A	0		01 CS_SAN	AMEA	a
10	40 A	0		01 CS_PFB	AMEA	a
11	37 A	0		01 CS_EDD	AMEA	a
12	24 H	91		100 CS_EE_PFB	AMEA	a

```

MERGE INTO FCC_ZCS_ALERT_PRIORITY_CONF T USING (
    SELECT '37' N_ALERT_PRIORITY_SEQ, 'B' V_ALERT_PRIORITY_CODE, '81'
    N_ALERT_PRIORITY_MIN_SCORE, '85' N_ALERT_PRIORITY_MAX_SCORE, 'CS_RT_SAN'
    V_ALERT_TYPE_CODE, 'AMEA' V_JRSDCN_CD, 'a' V_BUS_DMN_LIST_TX FROM DUAL)
S
    ON ( T.N_ALERT_PRIORITY_SEQ = S.N_ALERT_PRIORITY_SEQ )
    WHEN MATCHED THEN UPDATE SET T.V_ALERT_PRIORITY_CODE =
    S.V_ALERT_PRIORITY_CODE, T.N_ALERT_PRIORITY_MIN_SCORE =
    S.N_ALERT_PRIORITY_MIN_SCORE, T.N_ALERT_PRIORITY_MAX_SCORE =
    S.N_ALERT_PRIORITY_MAX_SCORE, T.V_ALERT_TYPE_CODE = S.V_ALERT_TYPE_CODE,
    T.V_JRSDCN_CD = S.V_JRSDCN_CD, T.V_BUS_DMN_LIST_TX = S.V_BUS_DMN_LIST_TX
    WHEN NOT MATCHED THEN INSERT
        (N_ALERT_PRIORITY_SEQ,V_ALERT_PRIORITY_CODE,N_ALERT_PRIORITY_MIN_SCORE,N
        _ALERT_PRIORITY_MAX_SCORE,V_ALERT_TYPE_CODE,V_JRSDCN_CD,V_BUS_DMN_LIST_T
        X)
        VALUES
            (S.N_ALERT_PRIORITY_SEQ,S.V_ALERT_PRIORITY_CODE,S.N_ALERT_PRIORITY_MIN_S
            CORE,S.N_ALERT_PRIORITY_MAX_SCORE,S.V_ALERT_TYPE_CODE,S.V_JRSDCN_CD,S.V
            BUS_DMN_LIST_TX)
    /

```

3.3.4 Archiving a Queue

To archive inactive queues, follow these steps:

1. Log on to the Customer Screening application.
2. Click **Common Tasks**, then click **Rule Run Framework**, and then click **Process**. The **Process** page appears.
3. Search for **Queue** in the **Code** field and select **QueueArchive**.

Figure 9: Process Page

Process

Code queue Version 0

Name Active Yes

Folder

+ New View Edit Copy Remove Authorize Export Trace Definition

Code	Name	Folder	Version	Active
<input checked="" type="checkbox"/>	QueueArchive	TFLSEGMENT	0	Yes

Page 1 of 1 (1-15 of 1 items) Records Per Page 1

4. Click **Edit** . The **Process** page opens in **Edit** mode.

Figure 10: Process Definition (Edit Mode)

Process

Save Close

Process Definition(Edit Mode)

Linked to

Folder TFLSEGMENT

Master Information Properties

ID 1633605741491 Version 0

Code QueueArchive Active Yes

Name QueueArchive Type Process Tree

Executable Route Execution to High Precedence Node

Subprocess Component Precedence Move Remove Show Details Merge Rules Edit Subprocess

Process	Object	Precedence	Type	Parameter	Executable
QueueArchival	<input checked="" type="checkbox"/>	QueueArchival	Data Transformation	"CS"	<input checked="" type="checkbox"/>

5. Select the `QueueArchival` object and then select **Component**.
6. In the **Parameters** window, select the `QueueArchival` task and then click **drop-down list** . By default the parameter value will be selected as "TF". Change the parameter to "CS".

Figure 11: Component Selector Window

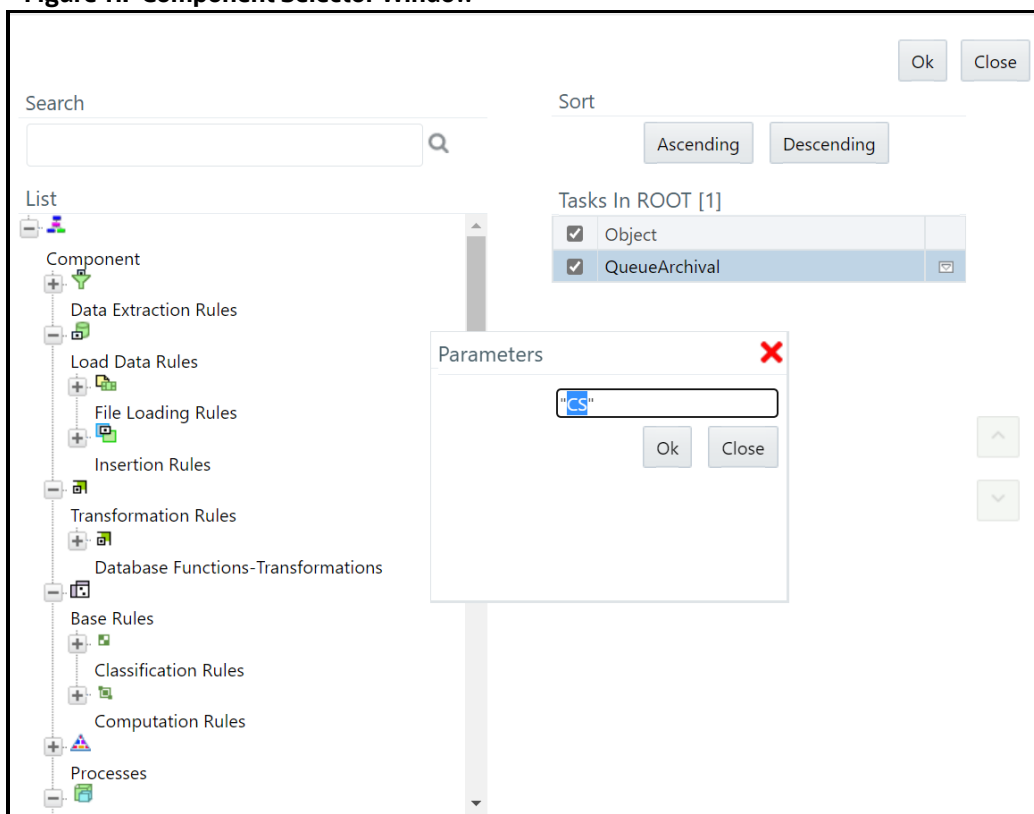

7. Click **OK** to close the **Parameters** window.
8. Click **OK**.
9. Click **Save**.

A confirmation message appears, click **Yes** to save the definition as a new version. A successful message appears, click **Close**.

3.4 Troubleshooting Your Display

If you experience problems logging into Oracle Financial Services Customer Screening or with your display, the browser settings may be incompatible with running OFSAA applications. The following sections provide instructions to set your Web display options for OFSAA applications.

3.4.1 Enabling JavaScript

This section describes how to enable JavaScript using the **Scripting** setting. To do this, follow these steps:

1. Navigate to the **Tools** menu.
2. Click **Internet Options**. The **Internet Options** dialog box is displayed.
3. Click the **Security** tab and then click **Local Intranet**.
4. Click **Custom Level**. The **Security Settings** dialog box is displayed.
5. In the **Settings** list and under the **Scripting** setting, enable **all options**.
6. Click **OK**, then click **OK** again to exit the **Internet Options** dialog box.

3.4.2 Enabling Cookies

Cookies must be enabled. If you have problems troubleshooting your display, contact your System Administrator.

3.4.3 Enabling Temporary Internet Files

Temporary Internet files are pages that you view on the Internet and store in a folder for quick viewing later. You must adjust this setting to always check for new versions of a stored page.

To enable Temporary Internet Files, follow these steps:

1. Navigate to the **Tools** menu.
2. Click **Internet Options**. The **Internet Options** dialog box is displayed.
3. In the **General** tab, click **Settings**. The **Settings** dialog box is displayed.
4. Select **Every visit to the page**. Selecting this option ensures that the temporary files are cleared every time.
5. Click **OK**, then click **OK** again to exit the **Internet Options** dialog box.

3.4.4 Enabling File Downloads

This section describes how to enable file downloads with the following steps:

1. Navigate to the **Tools** menu.
2. Click **Internet Options**. The **Internet Options** dialog box is displayed.
3. Click the **Security** tab and then click **Local Intranet**.
4. Click **Custom Level**. The **Security Settings** dialog box is displayed.
5. In the **Downloads** section, ensure that the **Enable** check box is selected for all options.
6. Click **OK**, then click **OK** again to exit the **Internet Options** dialog box.

3.4.5 Setting Printing Options

This section explains how to enable printing background colors and images with the following steps:

1. Navigate to the **Tools** menu.
2. Click **Internet Options**. The **Internet Options** dialog box is displayed.
3. In **Settings**, click the **Advanced** tab.
4. In the **Printing** tab, click **Print background colors and images**.
5. Click **OK** to exit the **Internet Options** dialog box.

NOTE

For best display results, use the default font settings in your browser.

3.4.6 Enabling the Pop-Up Blocker

You may have trouble running the Customer Screening application when the IE Pop-up Blocker is enabled. It is recommended to add the URL of the application to the list of allowed sites in the Pop-up Blocker Settings in the IE Internet Options.

To enable the Pop-up Blocker, follow these steps:

1. Navigate to the **Tools** menu.
2. Click **Internet Options**. The **Internet Options** dialog box is displayed.
3. Click the **Privacy** tab. In the **Pop-up Blocker** setting, select **Turn on Pop-up Blocker**.
4. Click **Settings** to open the **Pop-up Blocker Settings** dialog box.
5. In the **Pop-up Blocker Settings** dialog box, enter the URL of the application in the text area.
6. Click **Add**. The URL appears in the **Allowed Sites** list.
7. Click **Close**, then click **Apply** to save the settings.
8. Click **OK** to exit the Internet Options dialog box.

3.4.7 Setting Preferences

Use the **Preferences** section to set the **Financial Services Analytical Applications Customer Screening** home page.

To access this section, follow these steps:

1. In the **Financial Services Analytical Applications Customer Screening** home page, select **Preferences** from the user name drop-down list to open the **Preferences** page.

Figure 12: Preferences Page

Property Name	Property Value
Set My Home Page	Default Screen ▼
Date Format	-- Select -- ▼

Save Cancel

2. In the **Set My Home Page** drop-down list, select the window that you want to view when you log in.
When a new application is installed, the related window for that application is found in the drop-down list.
3. In the **Date Format** drop-down list, select the date format that you want to see. The options available are `dd/mm/yyyy` or `mm/dd/yyyy`.
4. Click **Save** to save your preferences.

4 General Configurations

Some configurations must be done before screening customer or external entity data, such as configuring run profiles to control elements of the watch lists and how screening is performed, preparing private watch lists using the Private List Interface (PLI) and use them for screening, analyzing watch list data, configuring match rules and clusters, configuring real-time and batch screening, configuring risk scores in watch lists and scheduling the Customer Screening run job. You can also configure the delta watch lists for the Dow Jones watch list, enable the General Data Protection Regulation (GDPR), and enable or disable the Data Quality (DQ) check.

The Watch List Management, Customer Screening, External Entity, and Real-time screening property files can be configured using run profiles in the `FICDB/conf` directory. You can use run profiles to specify the configuration settings that will override the default settings.

The following run profiles are available in the `<domain_name>/edq/oedq.local.home/runprofiles/` directory when you log in to the WinSCP server:

- `watch list-management.properties`
- `customer-screening.properties`
- `external-entity-screening.properties`
- `customer-screening-real-time.properties`

The `watch list-management.properties` run profile controls the following attributes:

- which watch lists are downloaded
- how filtering is applied to the watch lists
- how to apply the Data Quality check to the watch lists

The `customer-screening.properties` and `external-entity-screening.properties` run profiles control the screening of customers and external entities respectively in batches.

The `customer-screening-real-time.properties` run profile controls the screening of customers in real-time.

4.1 Due Date and Time Configuration

Users with the Customer Screening Administrator role can use the **Due Date and Time Configuration** section to set the alerts' due date and time. The alerts will be prioritized based on these configuration values.

NOTE

- The Due Date and Time Configuration is applicable only for Alert Management in the L1 investigation.

To access **Due Date and Time Configuration** section, follow these steps:

1. Click the **hamburger** icon  to view the Application Navigation List.
2. From the **Application Navigation List**, select **Due Date and Time Configuration**. The **Due Date and Time Configuration** page appears.

Figure 13: Due Date and Time Configuration

Due Date and Time Configuration

Jurisdiction * Americas Business Domain * C/WS Entity Type * Customer

Alert Type * Customer Enhanced Due Di... Priority * High

Due Date * Days 120 Hours 0 Minutes 0

Add Update Remove Reset

Jurisdiction	Business Domain	Entity Type	Alert Type	Priority	Due Date
No data to display.					

Page 1 (0 of 0 items) < 1 >

3. Provide details in the following mandatory fields in [Table 2](#):

Table 2: Conventions Used

Fields	Description
Jurisdiction	Select the jurisdiction value from the drop-down list.
Business Domain	Select the business domain to which the individual or entity belongs to.
Entity Type	Select the Entity Type as Customer, External Entity or Real-Time from the drop-down list.
Alert Type	Select the Alert Type value from the drop-down list. The values appear based on the selected entity type.
Priority	Select the alert priority value from the drop-down list.
Due Date	Select the due date values for the alert.

4. Click **Add**. The Due Date Configuration is added to the list.
 - Click **Reset** if you want to clear all the fields and enter new values.

Figure 14: Due Date and Time Configuration

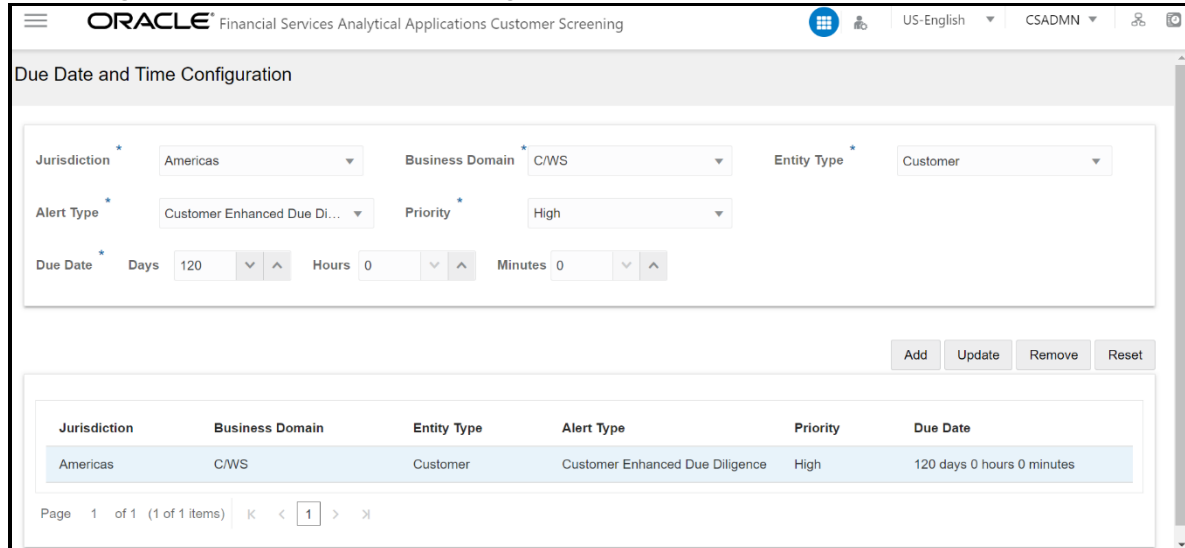

5. You can perform the following actions on the existing configurations:
 - **Update:** Select the configuration from the list, change any field values, and then click **Update**.
 - **Remove:** Select the configuration from the list and then click **Remove**.
 - **Reset:** Select the configuration from the list and then click **Reset** to reset the given field values.

NOTE If the Due Date is not configured, the alerts will be prioritized based on the default configuration with Due Date as 120 days. You can reset the default Due Date with the CS_appln_params table.

6. To change the Default Due Date configuration, you have to access the Atomic Schema and access the CS_appln_params table and change the ZCS_DEFAULT_DUE_DATE parameter value.

Figure 15: CS_appln_params table

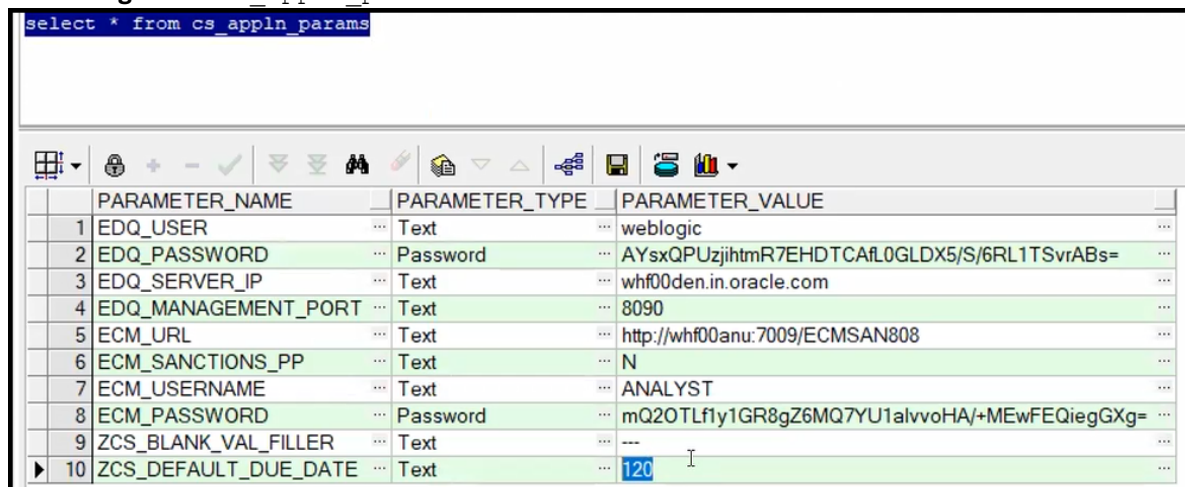

4.2 Setting the Priority

The Setting the Priority section describes how to set the alert priority as per your requirement. To set the priority of the alert, follow these steps.

1. Access the Atomic Schema and access the `FCC_ZCS_ALERT_PRIORITY_CONF` table.
2. Change the following parameter values:

NOTE Setting the Priority is applicable only for Alert Management in the L1 investigation.

- `n_alert_priority_min_score`
- `n_alert_priority_max_score`
- `v_jrscdn_cd`
- `v_bus_dmn_list_tx`

Figure 16: FCC_ZCS_ALERT_PRIORITY_CONF table

V_ALERT_PRIORITY_DESC	N_ALERT_PRIORITY_MIN_SCORE	N_ALERT_PRIORITY_MAX_SCORE	V_ALERT_TYPE	V_JRSDCN_CD	V_BUS_DMN_LIST_TX
3 Priority is Low	0	80	CS_SAN	AMEA	a
1 Priority is Medium	81	90	CS_SAN	AMEA	a
2 Priority is High	91	100	CS_SAN	AMEA	a

4.3 Security Mapping

The Security Mapping section describes how to change the security mapping. To change the security mapping, follow these steps.

1. Access the Atomic Schema and access the `FCC_ZCS_SECURITY_ATTR_GRP_MAP` table.
2. Provide the values for the following columns:

NOTE The Security Mapping is applicable only in the L1 Investigation for Alert Management.

- `V_GROUP_CODE`
- `V_JRSDCN_CD`
- `V_BUS_DMN_LIST_TX`
- `V_ALERT_TYPE`
- `V_STATUS`

The sample data is provided in the installer.

Figure 17: FCC_ZCS_SECURITY_ALERT_GRP_MAP table.

```
select * from FCC_ZCS_SECURITY_ATTR_GRP_MAP t |
```

	V_GROUP_CODE	V_JRSDCN_CD	V_BUS_DMN_LIST_TX	V_ALERT_TYPE	V_STATUS
1	CSSUPERVISORGRP	All	All	All	All
2	CSANALYSTGRP	All	All	All	All
3	CSSNRRSUPERVISORGRP	All	All	All	All

4.4 Preparing Watch List Data

Customer Screening is preconfigured to handle reference data from the following sources:

- HM Treasury
- OFAC
- EU consolidated list
- UN consolidated list
- World-Check
- Dow Jones Watch list
- Dow Jones Anti-Corruption List
- Accuity

You can also use your private watch list using the Private List Interface (PLI). For more information, see **The Private List Interface (PLI)** chapter in the [Oracle Financial Services Data Interfaces Guide](#).

NOTE

1. Watch lists can be downloaded automatically by setting the appropriate values in the run profile, or by downloading the watch list from the watch list provider's website. For information on downloading the watch lists, see [Appendix C: Preconfigured Watch List Information](#).
2. The first time a watch list is downloaded, the staging value must be set to **Y**. This ensures that data in the staging tables is refreshed every time the watch list is downloaded.
3. The Accuity, Dow Jones, Dow Jones Anti-Corruption, and World-Check watch lists are provided as paid services. To use a watch list, you must register for an account on the watch list provider's website.

4.4.1 Example - Preparing the Accuity List

This example describes how to edit the `watch list-management.properties` run profile to allow you to download and configure the Accuity list. The run profile is available in the `<domain_name>/edq/oedq.local.home/runprofiles/` directory when you log in to the WinSCP server.

NOTE You can also use the steps provided to download and configure the other watch lists.

4.4.2 Example - Enable Phases for Download and Staging

This example describes how to edit the `watch list-management.properties` run profile to allow you to download and configure the Accuity list.

To automatically download the Accuity list, set the following values in the `watch list-management.properties` run profile:

```
phase.ACY\ -\ Download.enabled = Y
phase.ACY\ -\ Stage\ reference\ lists.enabled = Y
```

To manually download the Accuity watch list using the Oracle Enterprise Data Quality (OEDQ) server, you must first set `phase.ACY\ -\ Download.enabled` and `phase.ACY\ -\ Stage\ reference\ lists.enabled = N` and click [sftp://username:password@ftp.financialgo.net/PIDGWL.ZIP](ftp://username:password@ftp.financialgo.net/PIDGWL.ZIP) to connect to the WinSCP client. Enter your user name and password and download the watch list from the `config/landingarea/Accuity` directory.

If the OEDQ server is connected to the internet through a proxy server, you must provide values for the following attributes in the proxy server:

- `proxy_host`. For example, `proxy.example.microsoft.com`.
- `proxy_port`. For example, `80`.
- `proxy_username`. For example, `username`.
- `proxy_password`. For example, `password`.

4.4.2.1 Filtering

To prepare the Accuity list without filtering, set the following value in the `watch list-management.properties` run profile:

```
phase.ACY\ -\ Prepare\ without\ filtering.enabled = Y
```

To prepare the Accuity list with filtering, set the following values in the `watch list-management.properties` run profile:

```
phase.ACY\ -\ Prepare\ with\ filtering\ (Part\ 1).enabled = Y
phase.ACY\ -\ Prepare\ with\ filtering\ (Part\ 2).enabled = Y
```

4.5 Private Watch List Set Up

Oracle Financial Services Customer Screening is preconfigured to work with commercially-available and government-provided watch lists. However, you can also screen data against your private watch lists. Sample private watch lists are provided in the `config/landingarea/Private` directory for

individuals and entities in the `privateindividuals.csv` and `privateentities.csv` files respectively.

NOTE OEDQ release 12c has a base config folder and a local config folder. The base config folder is called `oedqhome` and the local config folder is called `oedqlocalhome`. The names can differ in some cases. For example, dots or underscores can be used in the names, such as `oedq_local_home`.

To screen data against a private watch list, you must first replace the data in the ready-to-use files with your data and then enable the private watch list properties in the `watch list-management.properties` run profile.

To replace the data, replace the data in the `privateindividuals.csv` and `privateentities.csv` files with your private watch list data.

NOTE The files must be saved in UTF-8 format.

To enable the staging and preparation of the private watch list in the `watch list-management.properties` run profile, follow these steps:

1. Set `phase.PRIV\ -\ Stage\ reference\ lists.enabled = Y` to move your private watch list data to the staging tables.
2. Set `phase.PRIV\ -\ Prepare\ without\ filtering.enabled = Y` to prepare the private watch list without filtering.
3. Set `phase.PRIV\ -\ Prepare\ with\ filtering\ (Part\ 1).enabled = Y` and `phase.PRIV\ -\ Prepare\ with\ filtering\ (Part\ 2).enabled = Y` to prepare the private watch list with filtering.

4.6 Showing the Hidden Watch List Staged Data or Snapshots in the Server Console Interface

The following staged data and snapshots are hidden in the Server Console interface by default:

- Watch list snapshots
- Intermediate filtered watch list staged data
- Centralized Reference Data staged data or snapshots

To show this data, set the corresponding visibility property value in the run profile to **Y**.

For example, to view all Accuity watch list snapshots generated during Watch list Management, set the following properties in the `watch list-management.properties` run profile. The run profile is available in the `<domain_name>/edq/oedq.local.home/runprofiles/` directory when you log in to the WinSCP server.

```
stageddata.ACY\Sources.visible = Y
```

```
stageddata.ACY_All.visible = Y
```

```
stageddata.ACY_Sources.visible = Y
```

4.7 Analyzing Watch List Data

Customer Screening has a process called Data Quality (DQ) that checks the quality of the downloaded watch list data which is later used for screening. This process can be run independently of the watch list screening process.

4.7.1 Analyzing Data Quality

Before you analyze your watch list data, follow these steps:

1. Ensure that your data is loaded into FCDM and the `watch list-screening` project has the correct database parameters.
2. Run the `CS_EDQ_Watch list_Analyze` job. The job checks your watch list data for any quality issues that affect have a negative impact on the screening process.

To analyze the data for watch lists, set the following properties in the `watch list-management.properties` run profile:

NOTE The attributes shown are for the Accuity watch list. You must set the corresponding properties for the watch list for which you want to analyze data.

- `phase.DQ\ -\ Stage\ ACY\ reference\ lists.enabled = Y`
- `phase.DQ\ -\ ACY\ reference\ data\ quality\ analysis.enabled = Y`
- `stageddata.DQ\ ACY\ -\ Invalid\ Standard\ Country\ in\ Accuity\ Nationality\ to\ Standard\ Country.visible = Y`
- `stageddata.DQ\ ACY\ -\ Missing\ Source\ in\ Accuity\ Source\ Risk\ Scores\ Reference\ Data.visible = Y`
- `stageddata.DQ\ ACY\ -\ Obsolete\ Source\ in\ Accuity\ Source\ Risk\ Scores\ Reference\ Data.visible = Y`

4.8 Configuring Match Rules and Clusters for Customers and External Entities

You can configure match rules and clusters by adding a property value to the `customer-screening.properties` and `external-entity-screening.properties` run profiles.

For example, to disable the **Exact name only** rule, that is, `[I0100]`, for batch and real-time sanctions screening, add the following property value in the `customer-screening.properties` and `external-entity-screening.properties` run profiles:

```
phase.*.process.*.[I0100]\ Exact\ name\ only.san_rule_enabled = false
```

The `*` character denotes a wildcard, which indicates that the following rule applies to all phases and processes. If the `[I0100]` rule is disabled for batch screening only, the following is the new property value:

```
phase.Batch\ screening.process.*.[I0100]\ Exact\ name\ only.san_rule_enabled = false
```

NOTE The property value is case-sensitive.

For information on the match rules and clusters used in Customer Screening, see the [Oracle Financial Services Customer Screening Matching Guide](#).

4.9 Real-Time and Batch Screening Set Up

By default, real-time and batch screening is enabled for SAN (sanctioned), PEP (Politically Exposed Persons), and EDD (Enhanced Due Diligence) records. This is controlled by the real-time and batch screening properties in the `customer-screening.properties`, `Customer-Screening-real-time.properties`, and `external-entity-screening.properties` run profiles. You can use these run profiles to enable or disable real-time or batch screening for all records or a specific record type.

For example, to run real-time screening for PEP and EDD individual and entity records, disable the following property values in the `customer-screening.properties` and `external-entity-screening.properties` run profiles:

```
phase.Start\ Batch\ Screening.enabled = N
phase.Real-time\ Screening.process.Individual\ Real-time\
Screening.san_enabled = N
phase.Real-time\ Screening.process.Entity\ Real-time\ Screening.san_enabled =
N
```

Ensure that all other real-time screening properties are set to **Y**.

4.10 Extracting the Output of Matches into CSV Files

Customer Screening identifies possible relationships or matches between individuals and entities in your customer data and the external entities on watch lists. These matches form the basis of the cases that are investigated in Enterprise Case Management. When you perform batch screening and move these matches into the Customer Screening data layer, you can extract the output into the `.csv` files. This is useful if you want to use Customer Screening to identify the matches or if you want to review the matches using another case management system.

To extract the output of the matches into the `.csv` files, set the following values in the **Batch Screening Setup** section of the `customer-screening.properties` and `external-entity-screening.properties` run profiles. The run profiles are available in the `<domain_name>/edq/oedq.local.home/runprofiles/` directory in the WinSCP server.

```
phase.*.process.*.output_relationships = Y
phase.Export\ Batch\ Relationships.enabled = Y
```

When you run Customer Screening with these run profile parameters enabled, two files are created:

- `relns-ent-batch.csv`. This file holds the match data for entities.
- `relns-ind-batch.csv`. This file holds the match data for individuals.

4.11 Filtering Watch List Data

The following sections provide information about how to enable watch list filtering, configure watch list filtering, how to use primary filters, secondary filters, linked records, and how to screen all watch list records.

4.11.1 Enabling Watch List Filtering

To enable filtering for a specific watch list, set the `Prepare with Filtering` phase in the appropriate run profile to **Y**, and the `Prepare Without Filtering` phase to **N**. For more information, see the example provided in [Setting Filtering Options in the Run Profiles](#).

4.11.2 Configuring Watch List Filtering

Watch list filtering is controlled by configuring reference data in the watch list projects.

NOTE

1. The reference data sets in the `Watch list Management` and `Customer-Screening` projects are identical. This is to support installations that require filtering at different stages. For example, if a company wants to initially filter the prepared watch list data and then run several screening projects to filter specific parts of the data.
2. Once data is filtered out from the watch list, it is not possible to view the filtered data in another project. If, for example, all entities are filtered out in the `Watch list Management` project, then the `Customer-Screening` project will not display the entities in the screening results

The first level of filtering is controlled by editing the following filters in the `Watch list Management` project:

1. Go to the EDQ URL and open the **Director** menu. The **Director** landing page appears.

Figure 18: Director Menu in EDQ

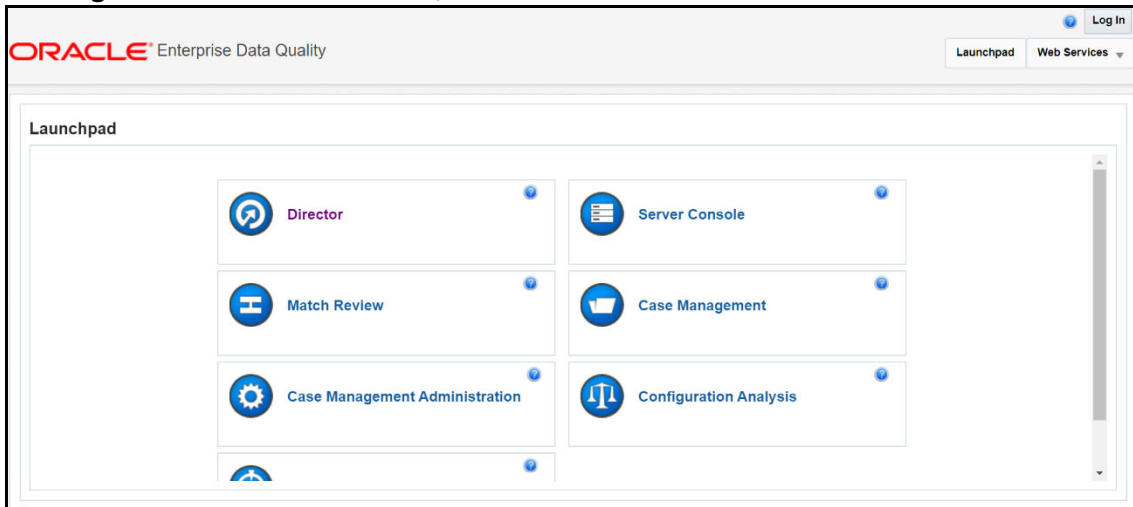

2. In the **Director** landing page, expand the **Watch list Management** project in the **Project Browser** pane.

Figure 19: Project Browser Pane

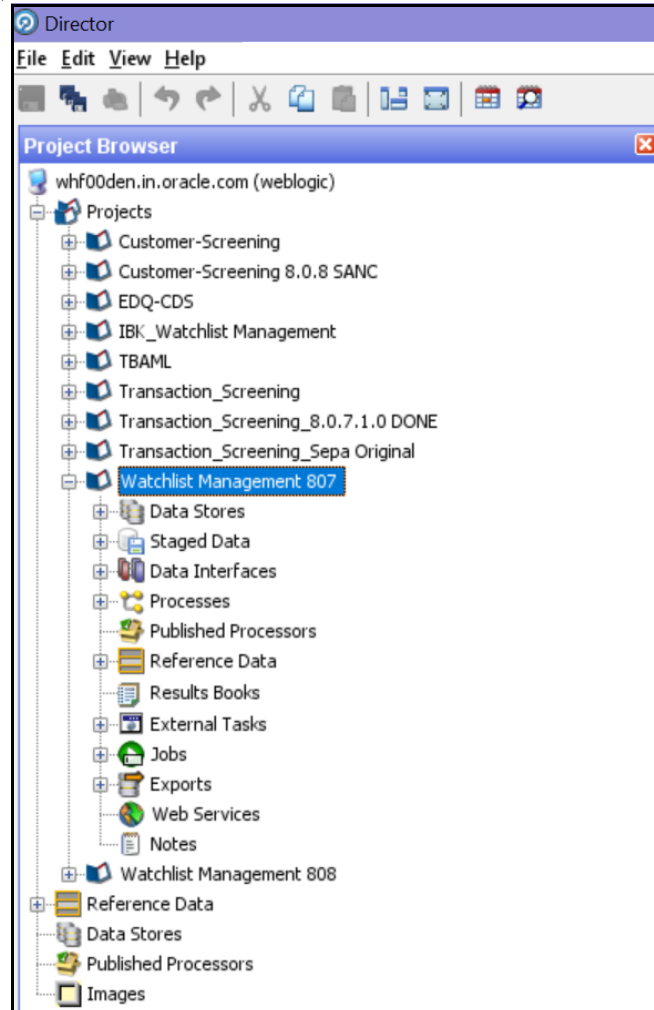

3. Expand the **Reference Data** node and open **Filter - Settings**. The **Reference Data Editor – Filter - Settings** window appears.

Figure 20: Reference Data Editor – Filter - Settings Window

List Key	List Sub Key	List/sub-lis...	Individuals...	Entities (Pr...	Vessels (P...	All origins ...	All origin r...	All origin s...	All name ty...
ACY	ACY-SAN	Y	Y	Y	Y	Y	Y	Y	Y
ACY	ACY-PEP	Y	Y	Y	Y	Y	Y	Y	Y
ACY	ACY-EDD	Y	Y	Y	Y	Y	Y	Y	Y
HMT	HMT-CONS	Y	Y	Y	Y	Y	Y	Y	Y
HMT	HMT-IB	Y	Y	Y	Y	Y	Y	Y	Y
EU	EU	Y	Y	Y	Y	Y	Y	Y	Y
DJW	DJW-SAN	Y	Y	Y	Y	Y	Y	Y	Y
DJW	DJW-PEP	Y	Y	Y	Y	Y	Y	Y	Y
DJW	DJW-EDD	Y	Y	Y	Y	Y	Y	Y	Y
OFAC	OFAC-SDN	Y	Y	Y	Y	Y	Y	Y	Y
OFAC	OFAC-NS-PLC	Y	Y	Y	Y	Y	Y	Y	Y
UN	UN-ALQ	Y	Y	Y	Y	Y	Y	Y	Y
UN	UN-TAL	Y	Y	Y	Y	Y	Y	Y	Y
WC	WC-SAN	Y	Y	Y	Y	Y	Y	Y	Y
WC	WC-PEP	Y	Y	Y	Y	Y	Y	Y	Y
WC	WC-EDD	Y	Y	Y	Y	Y	Y	Y	Y
PRIV		Y	Y	Y	Y	Y	Y	Y	Y
DJAC	DJAC-SAN	Y	Y	Y	Y	Y	Y	Y	Y
DJAC	DJAC-PEP	Y	Y	Y	Y	Y	Y	Y	Y
DJAC	DJAC-EDD	Y	Y	Y	Y	Y	Y	Y	Y

All the reference data filters except the Linked Profiles filter is set to **Y** by default. Unless these settings are changed, no actual filtering is performed on the watch list data. In the filter settings, a value of **Y** indicates that all records are included, that is, no filters are applied.

Watch list filtering falls into four categories:

- By list and list subkey
- By list record origin characteristics
- By list profile record characteristics
- By linked profiles

For more information, see the example provided in [Setting Primary Filters and Linked Profile Filters in the Watch list Management Project](#).

4.11.3 Primary Filters, Secondary Filters, and Filters for Linked Profiles

Primary filters are filters that are used to display all profiles that match the criteria specified. Filters for linked profiles are used to display profiles that are linked to the primary filter.

NOTE

You can filter linked profiles only for the World-Check and Dow Jones watch lists.

An example of a primary filter is a filter that is configured to capture all sanctions data. For the primary filter, a filter is configured for the related PEP data.

Secondary filters are applied to filter data that is displayed for linked profiles. For example, the secondary filter for PEP data is occupation or nationality.

Primary and secondary filters are set in one project (Watch list Management/Customer-Screening), and secondary filters are set in another project (Watch list Management/Customer-Screening).

4.11.4 Setting Multiple Values for Primary and Secondary Filters

Further configurations must display the following records:

- Origins
- Origin Regions
- Origin Statuses
- Primary and Secondary Name Qualities
- Primary and Secondary Name Types
- Primary and Secondary PEP Classifications

To filter data using one or more of these options, set the relevant value in the `Filter - Settings` reference data to **N**, and then make further changes to the corresponding reference data. When you set the value in the `Filter - Settings` reference data to **N**, only the records that match these values are included.

For example, if you set the value of the `All name qualities (Primary)?` filter to **N**, then you can determine which name qualities must be included for each watch list in the `Filter - Primary Name Qualities` reference data. Suppose you include a row for high-quality names in the EU watch list, but you do not include rows for medium-quality and low-quality names in this watch list, then only records with high-quality names are included in the watch list data.

NOTE

Some reference data sets are prepopulated with rows that usually contain data which is supplied by each watch list provider and can be viewed in the `Watch List Management` project. For example, to view all possible stop keywords for World-Check data, open the `WC Keyword` reference data in the `Watch list Management` project as mentioned in the following section.

4.11.4.1 Example - Filtering World-Check Data

This example describes the configurations which must be done to use primary and linked profile filters in the World-Check watch list in the `Watch list Management` project and how to set secondary filters in the `Customer-Screening` project. The following tasks are described:

- how to enable filtering in the `watch list-management.properties` run profile. For more information on enabling filtering, see [Setting Filtering Options in the Run Profiles](#).
- how to configure the primary filters and enable the filters for linked profiles in the `Watch list Management` project to return the active records for sanctioned individuals originating from the EU list. For more information, see [Setting Primary Filters and Linked Profile Filters in the Watch list Management Project](#).

- how to configure the secondary filters in the `Customer-Screening` project to filter out all the Linked Profiles of deceased individuals. For more information, see [Setting Secondary Filters in the Customer Screening project](#).

4.11.4.1.1 Setting Filtering Options in the Run Profiles

In the `watch list-management.properties` run profile, set the World-Check filtering phases as follows. This file is available in the `<domain_name>/edq/oedq.local.home/runprofiles/` directory in the WinSCP server.

- `phase.WC\ -\ Prepare\ without\ filtering.enabled = N`
- `phase.WC\ -\ Prepare\ with\ filtering\ (Part\ 1).enabled = Y`
- `phase.WC\ -\ Prepare\ with\ filtering\ (Part\ 2).enabled = Y`
- `phase.WC\ -\ Load\ without\ filtering.enabled = N`
- `phase.WC\ -\ Load\ with\ filtering\ (Part\ 1).enabled = Y`
- `phase.WC\ -\ Load\ with\ filtering\ (Part\ 2).enabled = Y`

4.11.4.1.2 Setting Primary Filters and Linked Profile Filters in the Watch list Management Project

Follow these steps to set primary filters and linked profiles in the project:

1. Go to the EDQ URL and open the **Director** menu. The **Director** landing page appears.

Figure 21: Reference Data Filters

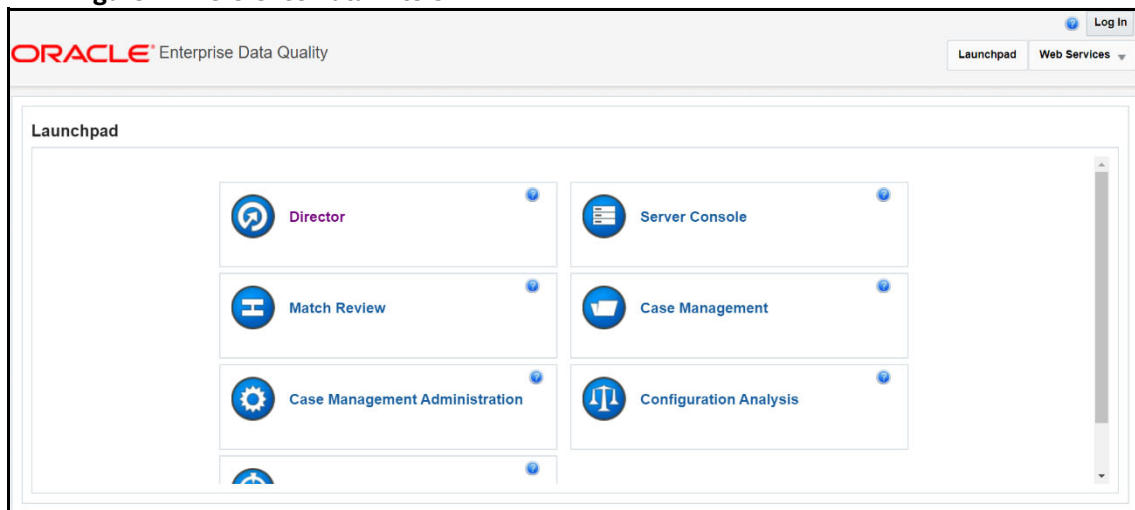

2. In the **Director** landing page, expand the **Watch list Management** project in the **Project Browser** pane.

Figure 22: Reference Data Filters

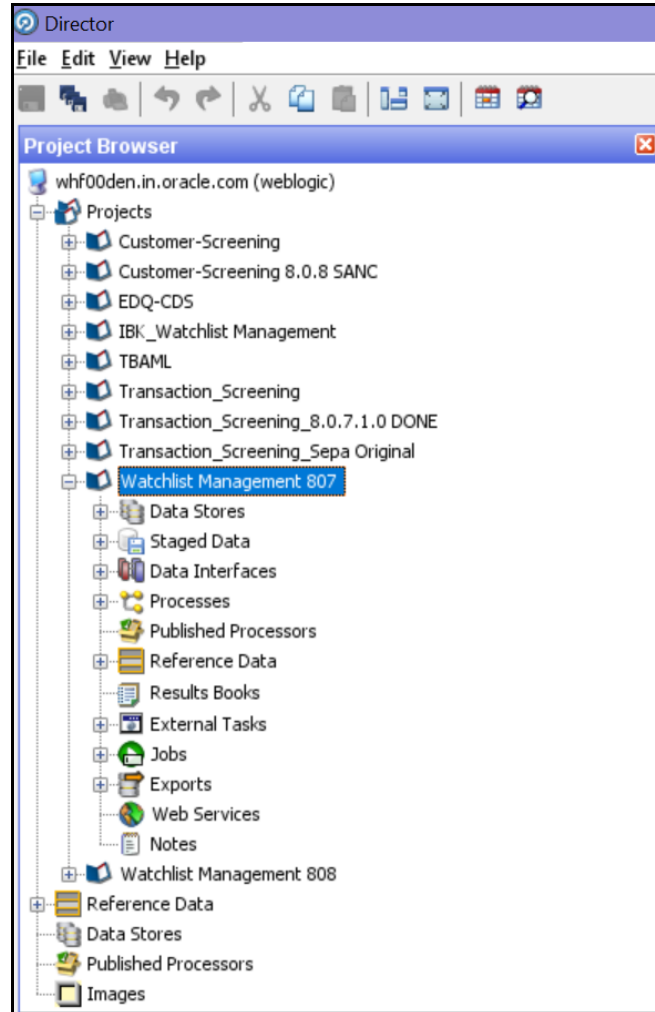

3. Expand the **Reference Data** node and open **Filter - Settings**. The **Reference Data Editor – Filter - Settings** window appears.

Figure 23: Reference Data Filters

List Key	List Sub Key	List/sub-list (...)	Individuals (...)	Entities (Prim...)	Vessels (Prim...)	All origins (Pr...)	All origin regi...	All origin stat...	All name typ...	All r
ACY	ACY-SAN	Y	Y	Y	Y	Y	Y	Y	Y	Y
ACY	ACY-PEP	Y	Y	Y	Y	Y	Y	Y	Y	Y
ACY	ACY-EDD	Y	Y	Y	Y	Y	Y	Y	Y	Y
HMT	HMT-CONS	Y	Y	Y	Y	Y	Y	Y	Y	Y
HMT	HMT-IB	Y	Y	Y	Y	Y	Y	Y	Y	Y
EU	EU	Y	Y	Y	Y	Y	Y	Y	Y	Y
DJW	DJW-SAN	Y	Y	Y	Y	Y	Y	Y	Y	Y
DJW	DJW-PEP	N	Y	Y	Y	Y	Y	Y	Y	Y
DJW	DJW-EDD	N	Y	Y	Y	Y	Y	Y	Y	Y
OFAC	OFAC-SDN	Y	Y	Y	Y	Y	Y	Y	Y	Y
OFAC	OFAC-NS-PLC	Y	Y	Y	Y	Y	Y	Y	Y	Y
UN	UN-ALQ	Y	Y	Y	Y	Y	Y	Y	Y	Y
UN	UN-TAL	Y	Y	Y	Y	Y	Y	Y	Y	Y
WC	WC-SAN	Y	Y	Y	Y	Y	Y	Y	Y	Y
WC	WC-PEP	Y	Y	Y	Y	Y	Y	Y	Y	Y
WC	WC-EDD	Y	Y	Y	Y	Y	Y	Y	Y	Y
PRIV		Y	Y	Y	Y	Y	Y	Y	Y	Y
DJAC	DJAC-SAN	Y	Y	Y	Y	Y	Y	Y	Y	Y
DJAC	DJAC-PEP	Y	Y	Y	Y	Y	Y	Y	Y	Y
DJAC	DJAC-EDD	Y	Y	Y	Y	Y	Y	Y	Y	Y

4. In the **Reference Data Editor – Filter - Settings** window, configure the following parameters. Double-click a value to update it.
 - a. Set the **List/sub-list (Primary?)** value in the **WC-SAN** row to **Y**.
 - b. Set the **Entities (Primary) ?** value in the **WC-SAN** row to **N**.
 - c. Set the **Inactive (Primary) ?** value in the **WC-SAN** row to **N**.
 - d. Set the **All Origins (Primary) ?** value in the **WC-SAN** row to **N**.
 - e. Set all other values in the **WC-SAN** row to **Y**.
 - f. Add a new row with the following values:
 - i. List Key - WC
 - ii. List Sub Key - WC-SAN
 - iii. Origin - EU
 - g. Set the **Linked Profiles?** value in the **WC-SAN** row to **Y**.
5. Click **OK** to close the window and save your changes.

4.11.4.1.3 Setting Secondary Filters in the Customer Screening project

Follow these steps to set secondary filters in the project:

1. Go to the EDQ URL and open the **Director** menu. The **Director** landing page appears.

Figure 24: Reference Data Filters

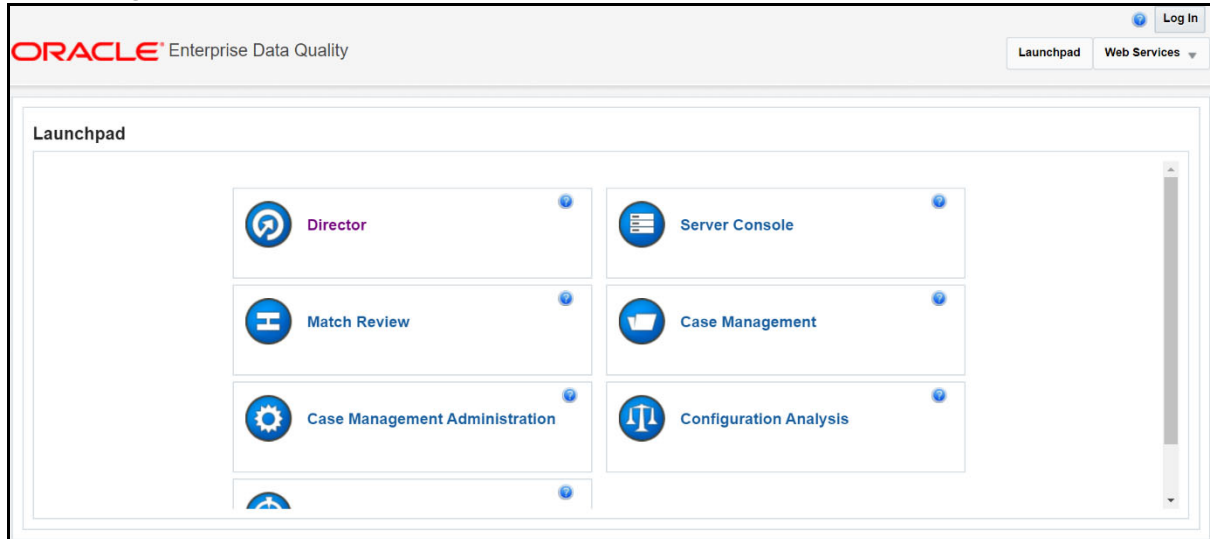

2. In the **Director** landing page, expand the **Watch list Management** project in the **Project Browser** pane.

Figure 25: Reference Data Filters

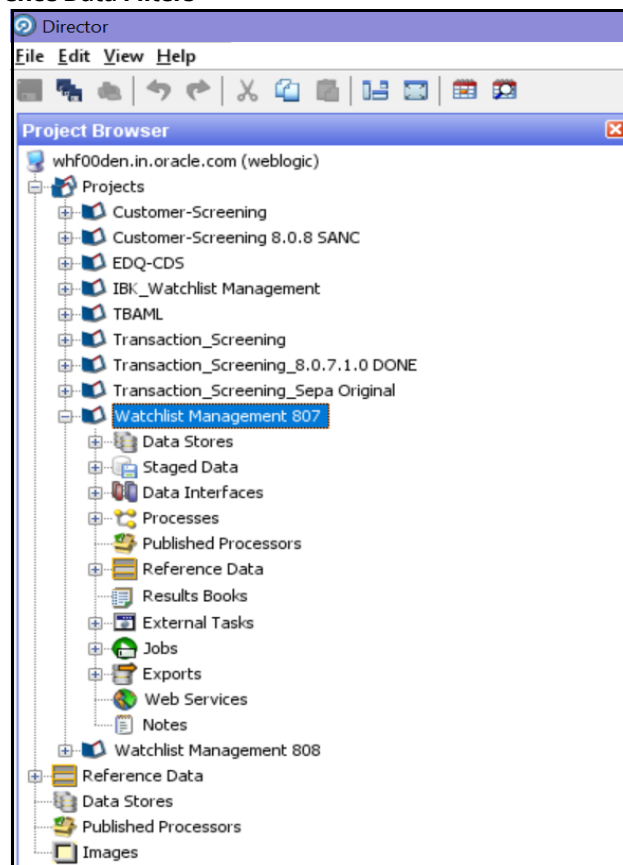

3. Expand the **Reference Data** node and open **Filter - Settings**. The **Reference Data Editor - Filter - Settings** window appears.

Figure 26: Reference Data Filters

List Key	List Sub Key	List/sub-list (...)	Individuals (...)	Entities (Prim...)	Vessels (Prim...)	All origins (Pr...)	All origin regi...	All origin stat...	All name typ...	All r
ACY	ACY-SAN	Y	Y	Y	Y	Y	Y	Y	Y	Y
ACY	ACY-PEP	Y	Y	Y	Y	Y	Y	Y	Y	Y
ACY	ACY-EDD	Y	Y	Y	Y	Y	Y	Y	Y	Y
HMT	HMT-CONS	Y	Y	Y	Y	Y	Y	Y	Y	Y
HMT	HMT-IB	Y	Y	Y	Y	Y	Y	Y	Y	Y
EU	EU	Y	Y	Y	Y	Y	Y	Y	Y	Y
DJW	DJW-SAN	Y	Y	Y	Y	Y	Y	Y	Y	Y
DJW	DJW-PEP	N	Y	Y	Y	Y	Y	Y	Y	Y
DJW	DJW-EDD	N	Y	Y	Y	Y	Y	Y	Y	Y
OFAC	OFAC-SDN	Y	Y	Y	Y	Y	Y	Y	Y	Y
OFAC	OFAC-N5-PLC	Y	Y	Y	Y	Y	Y	Y	Y	Y
UN	UN-ALQ	Y	Y	Y	Y	Y	Y	Y	Y	Y
UN	UN-TAL	Y	Y	Y	Y	Y	Y	Y	Y	Y
WC	WC-SAN	Y	Y	Y	Y	Y	Y	Y	Y	Y
WC	WC-PEP	Y	Y	Y	Y	Y	Y	Y	Y	Y
WC	WC-EDD	Y	Y	Y	Y	Y	Y	Y	Y	Y
PRIV		Y	Y	Y	Y	Y	Y	Y	Y	Y
DJAC	DJAC-SAN	Y	Y	Y	Y	Y	Y	Y	Y	Y
DJAC	DJAC-PEP	Y	Y	Y	Y	Y	Y	Y	Y	Y
DJAC	DJAC-EDD	Y	Y	Y	Y	Y	Y	Y	Y	Y

- In the **Reference Data Editor – Filter - Settings** window, Set the Deceased (Secondary) ? value in the WC-SAN row to **N**.
- Click **OK** to close the window and save your changes.

4.11.5 Screening All Sanctions Data

By default, data is routed from the Watch list Management project to the different screening processes depending on their record type, which can be Sanctions (SAN), Politically Exposed Persons (PEP), or Enhanced Due Diligence (EDD) records. This allows different rules to be applied according to the risk appetite of the record that is being screened.

However, if you want to use the same screening logic for all watch list records and do not want to maintain separate rulesets, you can move all watch list records to the SAN screening processes. To do this, set `phase.*.process.*.Screen\ all\ as\ SAN?` value in the `customer-screening.properties = Y`. This file is located in the `<domain_name>/edq/oedq.local.home/runprofiles/` directory in the WinSCP server.

4.11.6 Match Persistence and Flag Keys

Customer Screening parses all customer records against all watch list records daily. This allows new alerts to be created due to changes in either the customer or the watch list data. When there is no change to the customer or the watch list record and the match is identical to a previously generated relationship, no new alerts are created.

Many attributes can change on a customer or watch list record but not all changes result in a new alert. These attributes are controlled based on the flag key value.

NOTE If a new alias name that matches the customer record is added to a watch list, then this results in a new alert.

An example of a flag key is `date of birth`. Some potential matches are eliminated because the value the customer has provided and the value in the watch list records are different. So, if the value changes,

then any potential matches related to the `date of birth` must be rereviewed. An example of a field that is not included in the flag key is `account balance`. This value changes frequently and does not impact the match decision. Flag keys are set in individual match processes, and a hash value is generated which is used for comparison.

NOTE The order of fields in the flag key is important. If the order changes, this will result in a new alert.

4.12 Risk Scoring in Watch Lists

Customer Screening includes a feature to estimate the relative risk of doing business with a given entity or individual. For each watch list, a risk score is calculated for an individual or entity based on various attributes such as country of residence, operating country, and associated regime. The risk scores for watch lists are available in the reference data tables for the specific watch list. For more information, see [Appendix B: Reference Data Tables for Watch Lists](#).

NOTE The risk scores must be evaluated and tuned by a risk and compliance expert with knowledge of your business requirements and the relevant legislation.

4.12.1 Adjusting the Risk Scores

Customer Screening calculates a risk score and a Politically Exposed Person (PEP) risk score for every alert created during screening. The risk score is a relative measure of the risk posed by an individual or entity out of a maximum score of 100. The PEP risk score identifies the relative risk of the individual or entity when the individual or entity is considered as a PEP. Since the risk score can be different from the PEP risk score, the same algorithm is used to derive the risk score and PEP risk score but the underlying scores and weightings on which the calculations are based are different.

The overall risk score of a potential match is calculated as a weighted average of the risk scores generated for the watch list, customer, and external entity records in the match. The risk scores for the watch list, customer, and external entity records are calculated as a weighted average of the risk scores of the contributing risk elements. A risk element is a data field, such as Country of Operation or Occupation, and a risk score is assigned to the risk elements based on its value.

You can adjust the following attributes to customize the overall risk score:

- Risk scores and relative weightings of the risk elements.
- Relative weight of the watch list risk score, customer risk score, and external entity risk score.
- Reference data tables of the specific watch list used in the screening process.

4.12.2 Editing the Risk Element Scores

You can adjust the risk element scores by editing the risk element in Enterprise Data Management (EDQ). The risk elements that are considered during the risk score calculation depend on the fields that are present in the watch list or customer record.

4.12.2.1 Example – Accuity Watch List

The following steps explain how to edit the risk element scores for the Accuity watch list:

1. Go to the EDQ URL and open the **Director** menu. The **Director** landing page appears.

Figure 27: Director Menu in EDQ

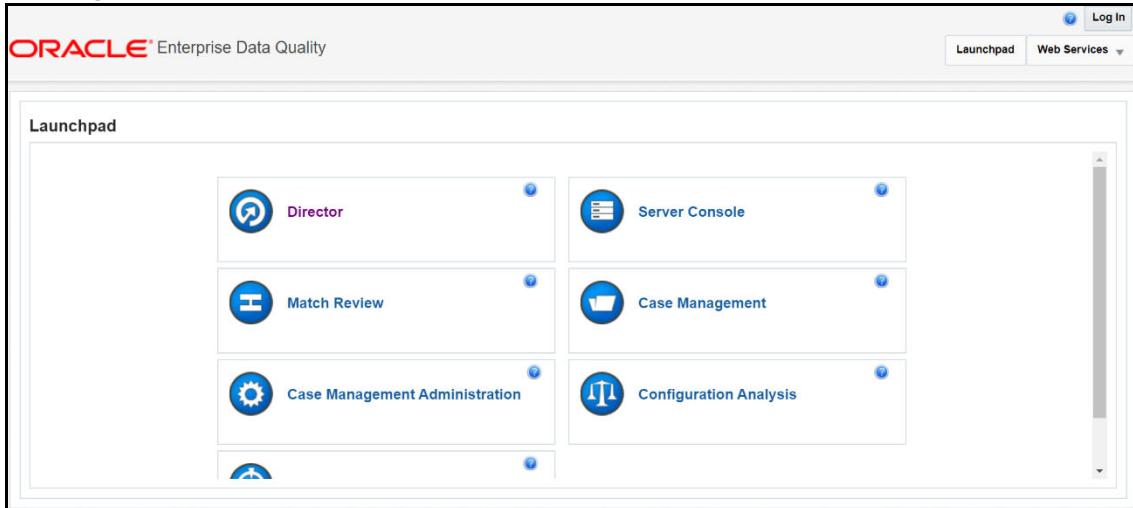

2. In the **Director** landing page, expand the **Watch list Management** project in the **Project Browser** pane.

Figure 28: Project Browser Pane

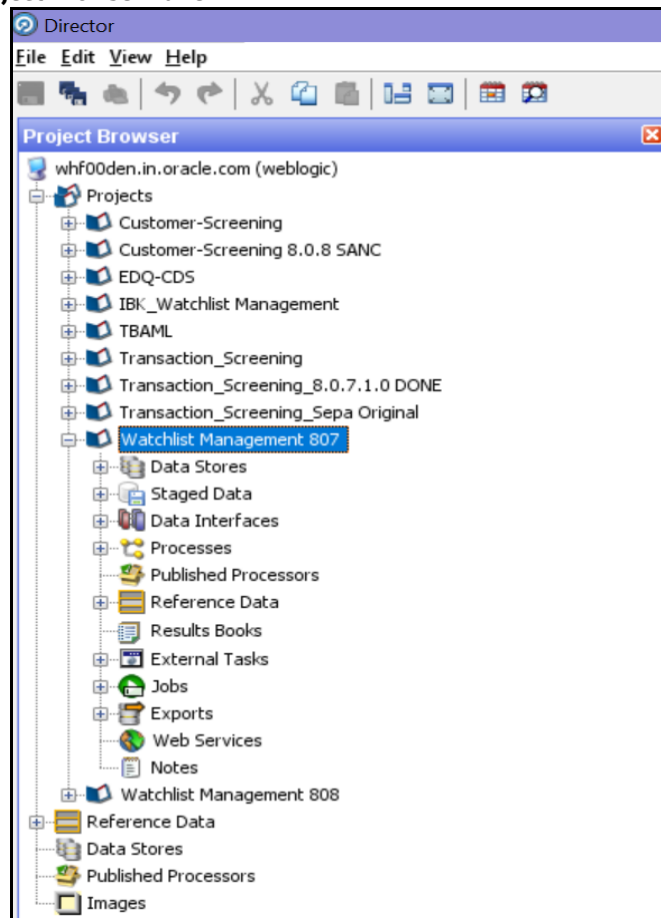

3. Expand the **Reference Data** node.
4. Right-click **Accuity Source Risk Scores** and select **Edit data**.

Figure 29: Accuity Source Risk Scores

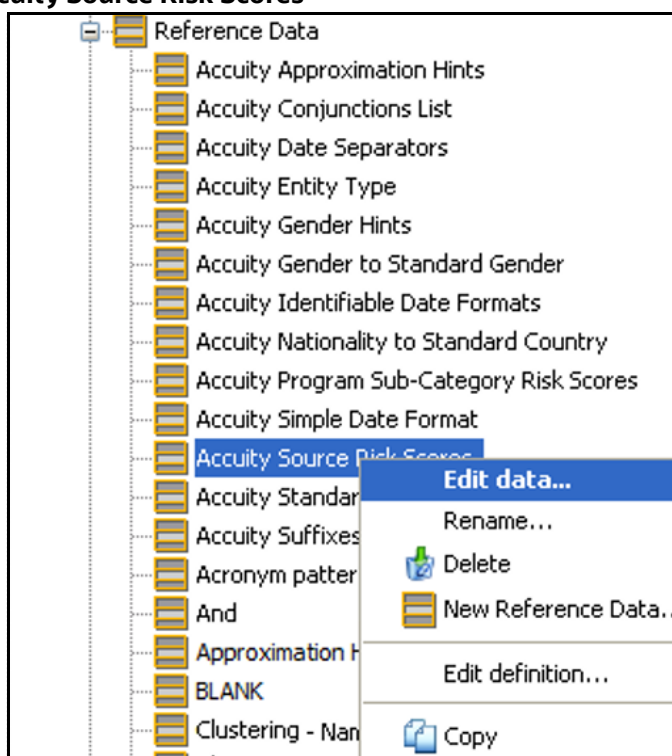

5. In the **Reference Data Editor – Accuity Source Risk Scores** window, the risk score appears in editable mode.

Figure 30: Reference Data Filters for Accuity

Name	RiskScore	Comment	State	Modified By	Modified On
PEP	25		Active	dnadmin	22-Jul-2010 17:08:47
USP	25		Active	dnadmin	22-Jul-2010 17:08:47
EDI	50		Active	dnadmin	22-Jul-2010 17:08:47
ELA	50		Active	dnadmin	22-Jul-2010 17:08:47
ELA	50		Active	dnadmin	22-Jul-2010 17:08:47
ESA	50		Active	dnadmin	22-Jul-2010 17:08:47
EDA	50		Active	dnadmin	22-Jul-2010 17:08:47
ELK	50		Active	dnadmin	22-Jul-2010 17:08:47
EDC	50		Active	dnadmin	22-Jul-2010 17:08:47
EDE	50		Active	dnadmin	22-Jul-2010 17:08:47
311	75		Active	dnadmin	22-Jul-2010 17:08:47
ACB	75		Active	dnadmin	22-Jul-2010 17:08:47
ARG	75		Active	dnadmin	22-Jul-2010 17:08:47
AU	75		Active	dnadmin	22-Jul-2010 17:08:47
BEL	75		Active	dnadmin	22-Jul-2010 17:08:47
BES	75		Active	dnadmin	22-Jul-2010 17:08:47
BofE	100		Active	dnadmin	22-Jul-2010 17:08:47
CNA	75		Active	dnadmin	22-Jul-2010 17:08:47
CSL	75		Active	dnadmin	22-Jul-2010 17:08:47
DNS	75		Active	dnadmin	22-Jul-2010 17:08:47
DTC	75		Active	dnadmin	22-Jul-2010 17:08:47
ES	75		Active	dnadmin	22-Jul-2010 17:08:47
EU	100		Active	dnadmin	22-Jul-2010 17:08:47
PMJ	75		Active	dnadmin	22-Jul-2010 17:08:47
FR	75		Active	dnadmin	22-Jul-2010 17:08:47
HK	75		Active	dnadmin	22-Jul-2010 17:08:47
IA	75		Active	dnadmin	22-Jul-2010 17:08:47
ISN	75		Active	dnadmin	22-Jul-2010 17:08:47
ITL	75		Active	dnadmin	22-Jul-2010 17:08:47
JMF	75		Active	dnadmin	22-Jul-2010 17:08:47
NET	75		Active	dnadmin	22-Jul-2010 17:08:47

NOTE

If you edit the risk scores, you must rerun the **Download, Prepare, Filter and Export All Lists** jobs in the **Watch list Management** project and the **MAIN** job in the **Customer-Screening** project in EDQ. Until this is done, the generated matches will not show the new risk scores. For more information on how to view the jobs, see [Analyzing the Data Quality of Customer Data and External Entity](#).

4.12.2.2 Editing the Risk Element Weightings

You can edit the default weightings assigned to each risk element in the **Reference Data Editor – Risk – Risk Element Weightings** window. This reference data set specifies which fields in that record contribute to the risk score calculation for each type of record and to what degree (weightage).

The following steps explain how to view the risk element weightings for all watch lists:

1. Go to the EDQ URL and open the **Director** menu. The **Director** landing page appears.

Figure 31: Director Menu in EDQ

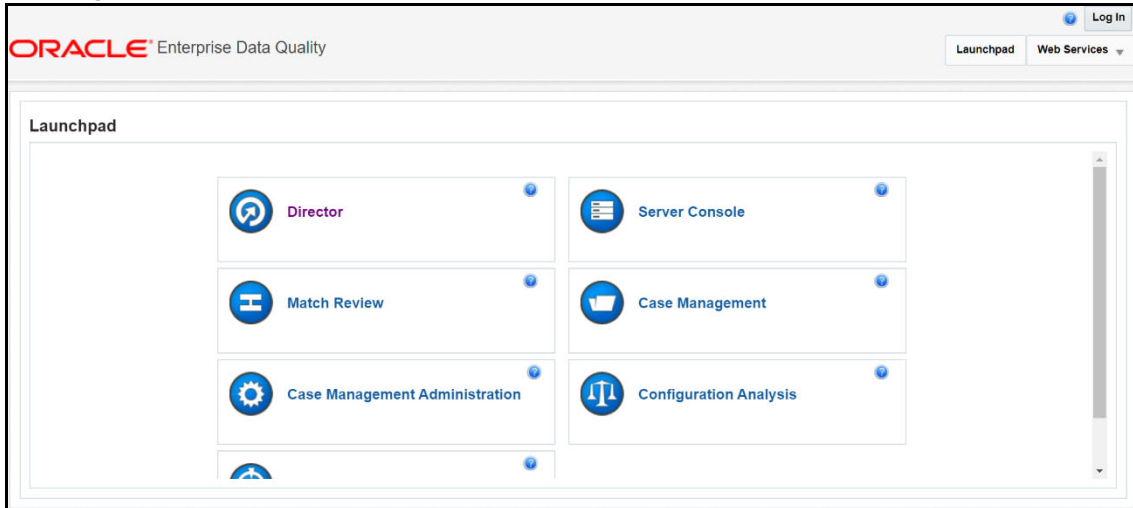

2. In the **Director** landing page, expand the **Watch list Management** project in the **Project Browser** pane.

Figure 32: Project Browser Pane

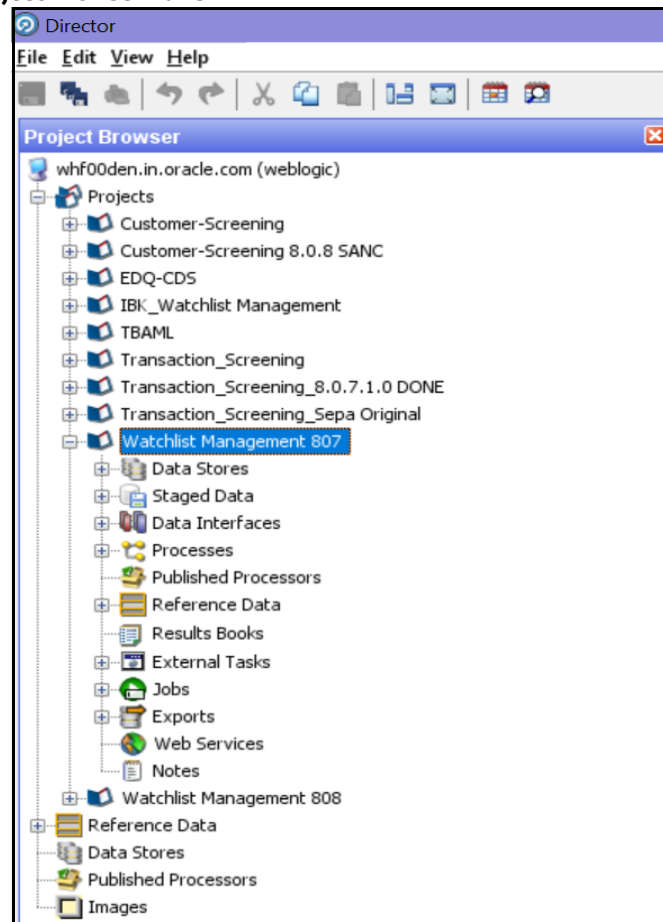

- Expand the **Reference Data** node.
- Right-click **Risk - Risk Element Weightings** and select **Edit data**.

Figure 33: Reference Data Filters for Risk Element Weightings

RecordType	ResOpeCo...	NatRegCo...	Membership	Category	Occupation	Deceased	Active	ExternalRisk	Comment
HMT_I	0.2	0.2	0.3	0.3	0	0	0	0	Acti
HMT_E	0.3	0.3	0.3	0.1	0	0	0	0	Acti
OFAC_I	0.2	0.2	0.3	0.3	0	0	0	0	Acti
OFAC_E	0.3	0.3	0.3	0.1	0	0	0	0	Acti
EU_I	0.3	0.3	0.4	0	0	0	0	0	Acti
EU_E	0.3	0.3	0.4	0	0	0	0	0	Acti
UN_I	0.3	0.3	0.3	0.1	0	0	0	0	Acti
UN_E	0.3	0.3	0.3	0.1	0	0	0	0	Acti
WC_I	0.2	0.2	0.3	0.2	0	0.1	0	0	Acti
WC_E	0.3	0.3	0.3	0.1	0	0	0	0	Acti
WC_FEP_I	0.2	0.2	0.3	0	0	0.3	0	0	Acti
WC_FEP_E	0.3	0.3	0.4	0	0	0	0	0	Acti
DJW_I	0.2	0.2	0.2	0.1	0.1	0.1	0.1	0	Acti
DJW_E	0.2	0.2	0.3	0.1	0	0	0.2	0	Acti
DJW_FEP_I	0.2	0.2	0.2	0.1	0.1	0.1	0.1	0	Acti
CUST_I	0.5	0.5	0	0	0	0	0	0	Acti
CUST_E	0.5	0.5	0	0	0	0	0	0	Acti
Accuity_I	0.2	0.2	0.3	0.3	0	0	0	0	Acti
Accuity_E	0.3	0.3	0.3	0.1	0	0	0	0	Acti
Accuity_FEP_I	0.2	0.2	0.3	0.3	0	0	0	0	Acti
Accuity_FEP_E	0.3	0.3	0.3	0.1	0	0	0	0	Acti
PRIV_I	0.5	0.5	0	0	0	0	0	0	Acti
PRIV_E	0.5	0.5	0	0	0	0	0	0	Acti
PRIV_FEP_I	0.5	0.5	0	0	0	0	0	0	Acti
PRIV_FEP_E	0.5	0.5	0	0	0	0	0	0	Acti
DJAC_I	0.2	0.2	0.2	0.1	0.1	0.1	0.1	0	Acti
DJAC_FEP_I	0.2	0.2	0.2	0.1	0.1	0.1	0.1	0	Acti
DJAC_E	0.2	0.2	0.3	0.1	0	0	0.2	0	Acti
DJAC_FEP_E	0.3	0.3	0.4	0	0	0	0	0	Acti

The format for the value in the **RecordType** column is the watch list and a suffix specifying whether the record represents an individual (**_I**) or an entity (**_E**). For example, **HMT_I**. Customer data have a record type of **CUST_I** for individual records and **CUST_E** for entity records.

The higher the weighting number, the more the corresponding risk element contributes to the overall risk score. The weighting scores for each row must add up to 1.

The overall risk score calculation for a record containing n elements is as follows:

$$\text{Risk Score} = E1w1 + E2w2 + \dots + Enwn$$

Where the risk element score for element x is represented by E_x and the weighting for element x is represented by w_x .

The total of all weightings must add up to 1, that is, $(w1 + w2 + \dots + wn = 1)$.

NOTE If there is no data for a risk element, it must not be included in the risk score calculation.

4.13 Scheduling the Customer Screening Run Job

To execute a Customer Screening Run job, follow these steps:

- Navigate to the `FCI_DB_HOME/bin` directory.
- Execute the command `/EDQInsert.sh <INFODOM NAME>`. This step is used to register the EDQ server details. You must replace the `INFODOM NAME` placeholder with your domain name.
- Enter the following details in the console where the command is run:

- EDQ Server IP
- EDQ Server Direct Port number (JMX port number). This value must be 8090.
- EDQ Server User Name
- EDQ Password details

Figure 34: EDQ Details

```

/scratch/ofsaadb/ES807AX/ES807AX/ficdb/bin>./EDQInsert.sh ES807AXINFO
Started finding Jars
Ended finding Jars
Classpath Created
Calling EDQ Main Method
Inside EDQ insert method
Enter EDQ Server IP:
10.184.152.8
Enter EDQ Server Director Port:
8090
Enter EDQ Server User Name:
weblogic
Enter EDQ Password:
Encrypting password
Enter ECM URL:
https://whf00avg.in.oracle.com:4752/ES807AX
Is Enterprise Case Management Application in the same installation? (Y/N)
N
Enter ECM User Name:
CSConnect
Enter ECM Password:
Encrypting password

```

4. Create and authorize a new ECM user who has no case privileges. For example, CSConnect. For information on how to create or add and authorize a user, see the *User Administrator* section in the [Oracle Financial Services Analytical Applications Infrastructure User Guide](#).

NOTE

In the first login as a new user, you are prompted to change the password.

5. Execute the command `/EDQInsert.sh <INFODOM NAME>` again only if you are doing a pack-on-pack installation of Enterprise Case Management (ECM) on Sanctions and the ECM URL is unavailable. An entry is made in the ATOMIC schema in the `cs_appln_params` table.
6. Copy the following run profiles from the `<domain_name>/edq/oedq.local.home / runprofiles/` directory in the WinSCP server to the `FIC_DB_HOME/conf` directory:
 - `watch list-management.properties`
 - `customer-screening.properties`
 - `external-entity-screening.properties`
 - `customer-screening-real-time.properties`
7. Load the stage table data for the customer-related tables. For more information, see [Loading Data](#).

8. In the **Run** page, select the `CS_Data_Load_Event_Generation` run and click **Fire Run** . The batches must be run in the order mentioned in [Table 3](#). It is not mandatory to run all the batches.

Table 3: Sequence of Batches to be Run

Sequence	Batch Name	Description
1	CS_EDQ_Watch list_Management	This job is used to run the watch list management project and start real-time screening in EDQ based on the run profile parameters. This job must be run daily.
2	CS_EDQ_Watch list_Analyze	This job is used to check the data quality of the downloaded watch list.
3	CSBusinessDataLoad	This job is used to load data from the staging tables to the business tables.
4	CS_Data_Load_Event_Generation	This job is used to match customer data with the downloaded watch list data and to generate alerts.
5	Oracle_CS_Zipper_Processing	This job will move the data from the source database to the consolidated database and create an alert based on the Customer. NOTE: The Oracle_CS_Zipper_Processing batch is only applicable in the L1 Investigation.

Figure 35: Run Page

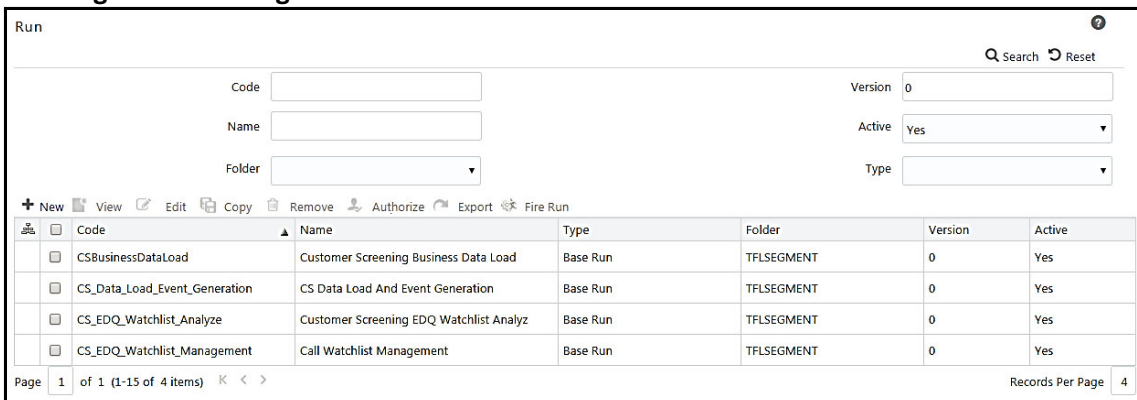

The screenshot shows the 'Run' page interface. At the top, there are search filters for Code, Name, Folder, Version, Active, and Type. Below the filters is a toolbar with actions like New, View, Edit, Copy, Remove, Authorize, Export, and Fire Run. The main area contains a table with columns: Code, Name, Type, Folder, Version, and Active. The table lists four runs: CSBusinessDataLoad, CS_Data_Load_Event_Generation, CS_EDQ_Watchlist_Analyze, and CS_EDQ_Watchlist_Management. The page footer shows 'Page 1 of 1 (1-15 of 4 items)' and 'Records Per Page 4'.

Code	Name	Type	Folder	Version	Active
CSBusinessDataLoad	Customer Screening Business Data Load	Base Run	TFLSEGMENT	0	Yes
CS_Data_Load_Event_Generation	CS Data Load And Event Generation	Base Run	TFLSEGMENT	0	Yes
CS_EDQ_Watchlist_Analyze	Customer Screening EDQ Watchlist Analyz	Base Run	TFLSEGMENT	0	Yes
CS_EDQ_Watchlist_Management	Call Watchlist Management	Base Run	TFLSEGMENT	0	Yes

4.14 Enabling L2 Investigation for Customer Screening

To enable L2 Investigation for Customer Screening follow these steps:

1. Navigate to the `FCI_DB_HOME/bin` directory.
2. Execute the command `./EDQInsert.sh <INFODOM NAME>`. This step is used to register the EDQ server details. You must replace the `INFODOM NAME` placeholder with your domain name.
3. Enter the following details in the console where the command is run:
 - EDQ Server IP

- EDQ Server Direct Port number (JMX port number). This value must be 8090.
- EDQ Server User Name
- EDQ Password details

Figure 36: EDQ Details

```

/scratch/cs812ut/sanc_812/sanc_812/ficdb/bin>./EDQInsert.sh SANC812INFO
Started finding Jars
Ended finding Jars
Classpath Created
Calling EDQ Main Method
Inside EDQ insert method
Enter EDQ Server IP:
whf00plg.in.oracle.com
Enter EDQ Server Director Port:
8090
Enter EDQ Server User Name:
dnadmin
Enter EDQ Password:
Encrypting password
Do you want Enterprise Case Management Application(ECM) or Customer Screening Alert Management(CSAM) as
per ECM/CSAM)
CSAM
Enter Customer Screening Alert Management(CSAM) URL:
http://fsgbu-mum-236.snbonprshared1.gbucdsint02bom.oraclevcn.com:7001/SANC812/
Is Customer Screening Alert Management(CSAM) Application in the same installatio
n? (Please enter Y/N)
Y
Is L2INVETSIGAION required? (Please enter Y/N)
Y
Enter Enterprise Case Management Application(ECM) URL:
http://100.76.133.239:7002/ECM812
Is Enterprise Case Management Application (ECM) in the same installation? (Pleas
e enter Y/N)
N
Enter Enterprise Case Management Application(ECM) User Name:
supervisor
Enter Enterprise Case Management Application(ECM) Password:
Encrypting password
configurationPath:::/scratch/cs812ut/sanc_812/sanc_812
FIC_HOME:/scratch/cs812ut/sanc_812/sanc_812/
L2INVESTIGATION has been enabled
configurationPath:::/scratch/cs812ut/sanc_812/sanc_812
Successfully inserted/ updated edq details
0
Exited with no errors.
/scratch/cs812ut/sanc_812/sanc_812/ficdb/bin>

```

4. Enter the input as CSAM for the L1 investigation and then press Enter.
5. Enter the Customer Screening URL and then press Enter.
6. Enter Y if the Customer Screening installed in the same installation or else N and then press Enter.
7. Enter Y to enable the L2 Investigation or else N and then press Enter.
8. Enter Y if Case Management is installed on the same installation of Customer Screening or else N.

Figure 37: EDQ Details

```

/scratch/cs812ut/sanc_812/sanc_812/ficdb/bin>./EDQInsert.sh SANC812INFO
Started finding Jars
Ended finding Jars
Classpath Created
Calling EDQ Main Method
Inside EDQ insert method
Enter EDQ Server IP:
whf00plg.in.oracle.com
Enter EDQ Server Director Port:
8090
Enter EDQ Server User Name:
dnadmin
Enter EDQ Password:
Encrypting password
Do you want Enterprise Case Management Application(ECM) or Customer Screening Alert Management(CSAM) as
er ECM/CSAM)
CSAM
Enter Customer Screening Alert Management(CSAM) URL:
http://fsgbu-mum-236.snbomprsharedl.gbucdsint02bom.oraclevcn.com:7001/SANC812/
Is Customer Screening Alert Management(CSAM) Application in the same installatio
n? (Please enter Y/N)
Y
Is L2INVETSIGAION required? (Please enter Y/N)
Y
Enter Enterprise Case Management Application(ECM) URL:
http://100.76.133.239:7002/ECM812
Is Enterprise Case Management Application (ECM) in the same installation? (Pleas
e enter Y/N)
N
Enter Enterprise Case Management Application(ECM) User Name:
supervisor
Enter Enterprise Case Management Application(ECM) Password:
Encrypting password
configurationPath:::/scratch/cs812ut/sanc_812/sanc_812
FIC HOME:/scratch/cs812ut/sanc_812/sanc_812/
L2INVESTIGATION has been enabled
configurationPath:::/scratch/cs812ut/sanc_812/sanc_812
Successfully inserted/ updated edq details
0
Exited with no errors.
/scratch/cs812ut/sanc_812/sanc_812/ficdb/bin>

```

9. If the input for the above step 8 is N, provide the User Name and Password of the Case Management.

4.15 Loading Data

This section explains how to load customer data from staging tables to the business table.

The following are the types of data loading:

- [Loading Data into the Customer Tables \(Full Load\)](#)
- [Loading Data into the Customer Tables \(Delta Load\)](#)

4.15.1 Loading Data into the Customer Tables (Full Load)

The full load allows you to move the complete list of data from the staging table to the business table.

To load data into the Customer tables, follow these steps:

1. Log on to the Customer Screening application.
2. Click **Common Tasks**, then click **Rule Run Framework**, and then click **Run**. The **Run** page appears.

Figure 38: Run Page

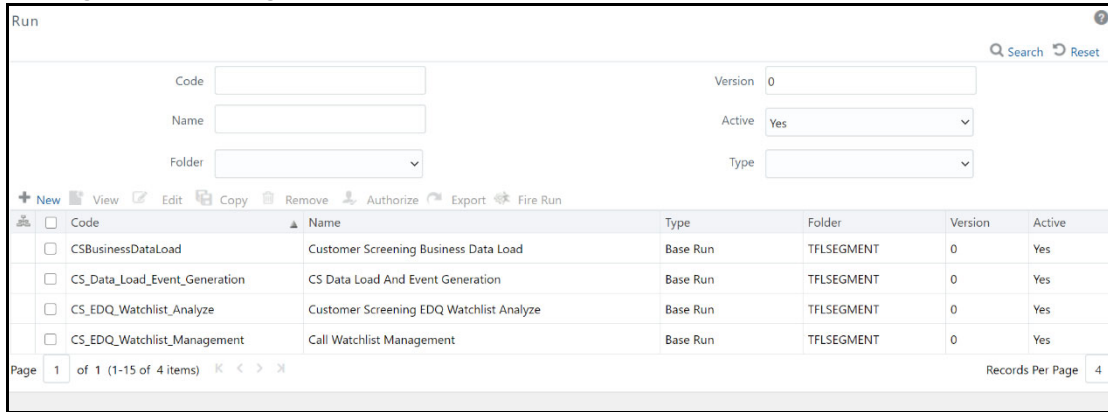

3. In the **Run** page, select the `CSBusinessDataLoad` checkbox and click **Fire Run**. Select the Date and click **OK**.

4.15.2 Loading Data into the Customer Tables (Delta Load)

The delta load allows you to move only the changed or enhanced data from the staging table to the business table.

If any customer data is changed in stage data only those data is moved in business. Based upon the date you run the batch.

For example, if any new entry has come for the same customer ID on a different date. Only those customer details are pushed to the business table.

The following workflow explains the external entity data movement from stage tables to business tables.

Figure 39: Delta Load Workflow

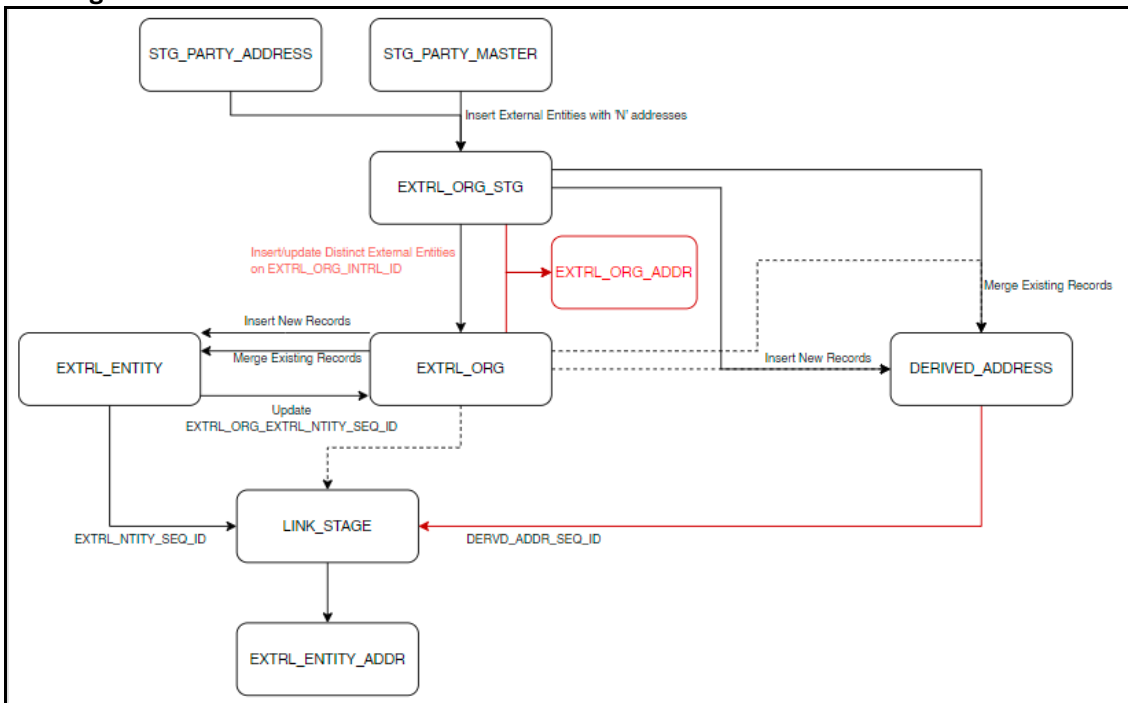

To load data into the Customer tables, follow these steps:

1. Log on to the Customer Screening application.
2. Click **Common Tasks**, then click **Rule Run Framework**, and then click **Run**. The **Run** page appears.

Figure 40: Run Page

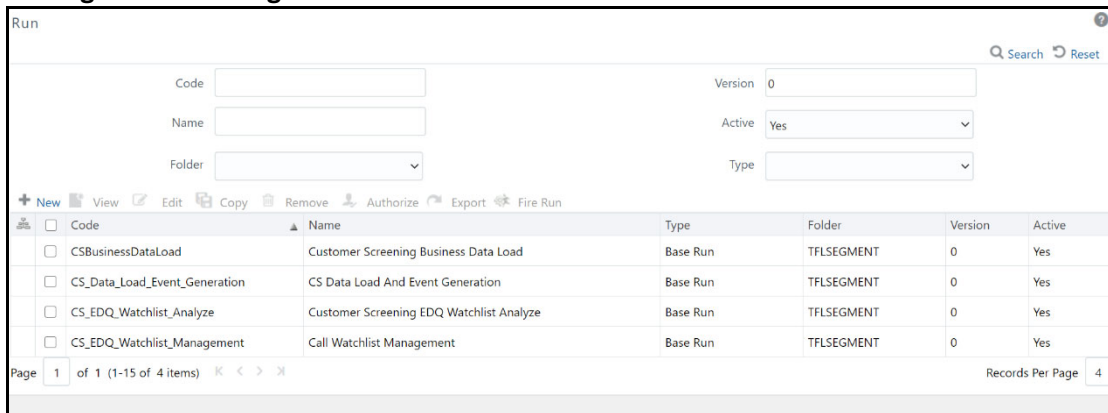

3. In the **Run** page, select the `CSBusinessDataLoad` checkbox and click **Edit**. The **Run** page appears in edit mode.

Figure 41: Run Definition (Edit Mode)

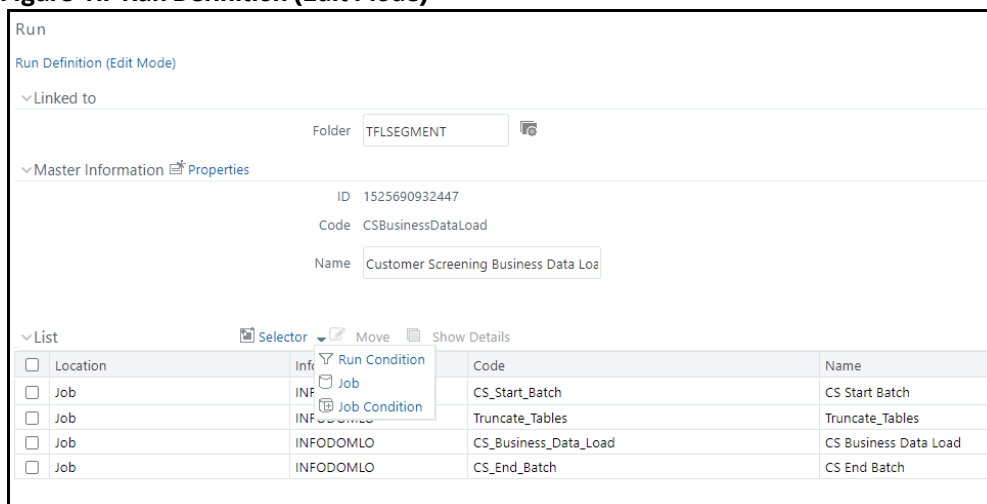

4. Click **Selector** and then select **Job**. The **Component Selector** window appears.
5. Select the `Truncate_Tables` task and then click **drop-down list**.

Figure 42: Component Selector Window

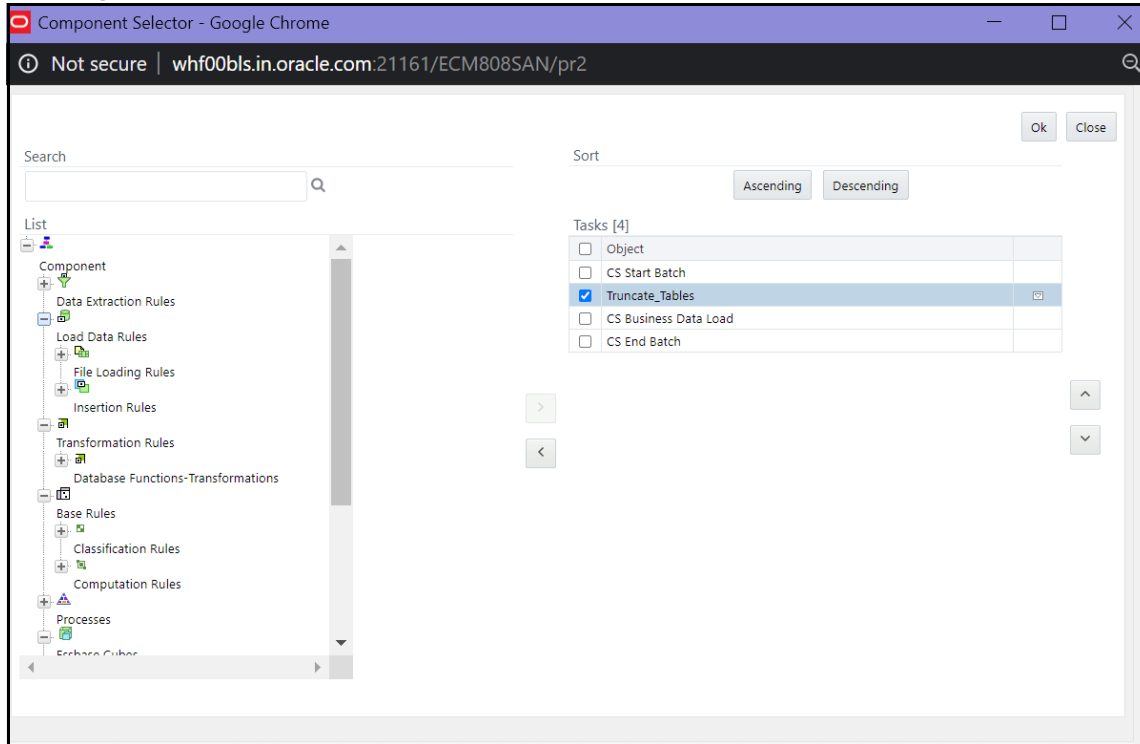

6. Change the parameter value to **N** and click **OK** to close the **Parameters** window.

Figure 43: Parameters Window

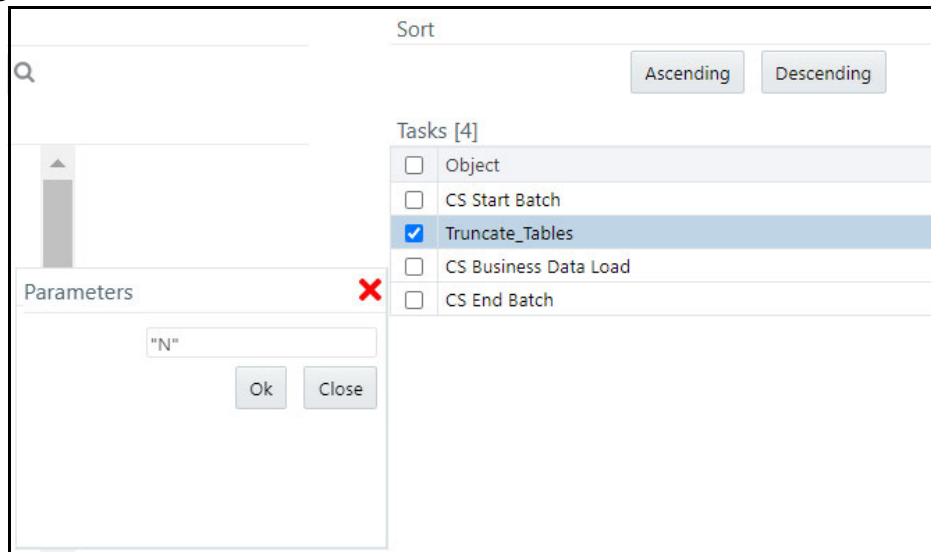

NOTE By default it is “Y”, if delta mode to be supported, update from “Y” to “D”.

7. Click **OK** to close the **Component Selector** window.
8. Click **Next**.
9. Click **Save**.

4.15.3 Creating and Running Parallel Batches

Parallel batches can be run in CS if you want to run batches with different jurisdictions at the same time. To run parallel batches, run the `CS_Data_Load_Event_Generation` task for each jurisdiction.

To create parallel batches, follow these steps:

4.15.3.1 Create a process

To create a process, follow these steps:

1. Make an entry in the `cs_processing_group` table in the `N_GROUP_ID` and `V_GROUP_NAME` columns. For ex, 102 and `GROUP_US`.

Figure 44: Developer Window

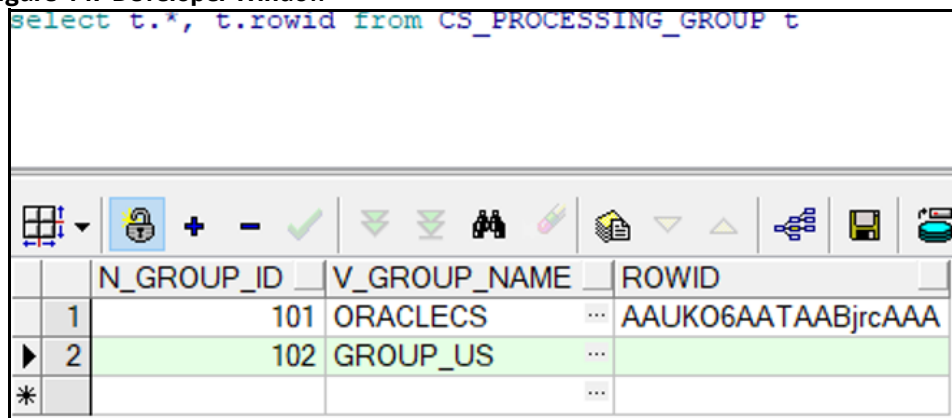

The screenshot shows a SQL query in a text area: `select t.*, t.rowid from CS_PROCESSING_GROUP t`. Below the query is a toolbar with various icons. The results are displayed in a table with the following data:

	N_GROUP_ID	V_GROUP_NAME	ROWID
1	101	ORACLECS	AAUKO6AATAABjrcAAA
2	102	GROUP_US	
*			

2. Log on to the Customer Screening application.
3. Click **Common Tasks**, then click **Rule Run Framework**, and then click **Process**. The **Process** page appears.
4. Search for *Start* in the **Code** field and select `CS_E2E_Start_Batch`.

Figure 45: Process Page

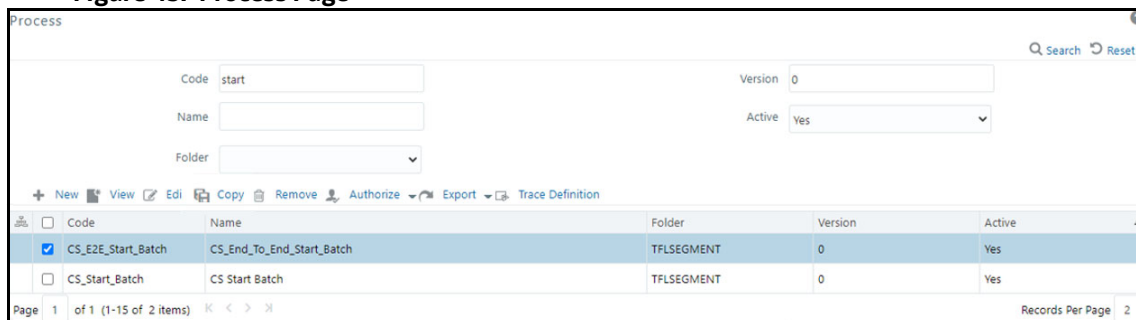

The screenshot shows the 'Process' page with search filters and a table of results. The search filters are: Code: start, Version: 0, Name: (empty), Active: Yes, Folder: (dropdown). The table below shows the search results:

Code	Name	Folder	Version	Active
<input checked="" type="checkbox"/> CS_E2E_Start_Batch	CS_End_To_End_Start_Batch	TFLSEGMENT	0	Yes
<input type="checkbox"/> CS_Start_Batch	CS Start Batch	TFLSEGMENT	0	Yes

Page 1 of 1 (1-15 of 2 items) Records Per Page 2

5. Click **Copy** . The **Process** page opens in *Copy* mode.

Figure 46: Process Definition (Copy Mode)

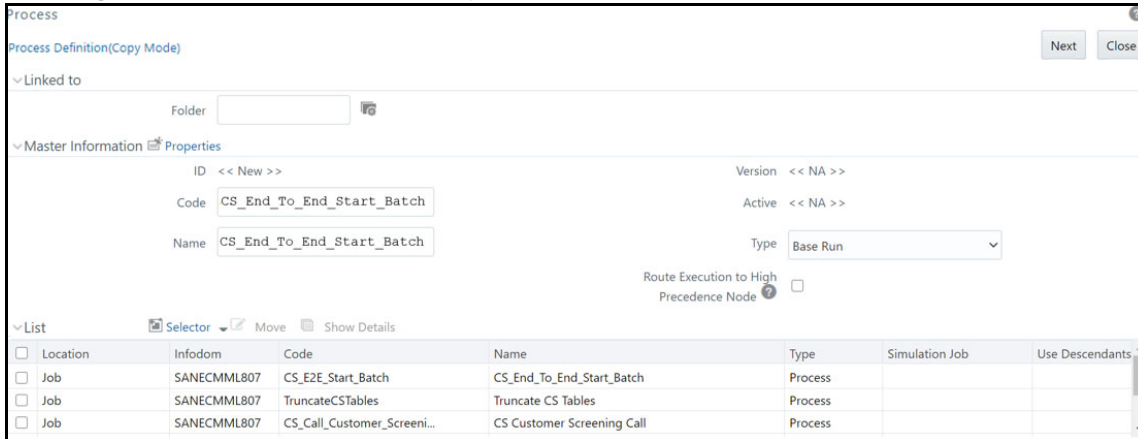

6. In the **Folder** field, click **Folder** and then select **TFLSEGMENT**.

Figure 47: Folder Selector



7. In the Name field, change the job name to include the Jurisdiction Code. For example, CS_Data_Load_Event_Generation_US.

8. Select F_CS_BATCH_RUN.

Figure 48: Process Definition (Copy Mode)

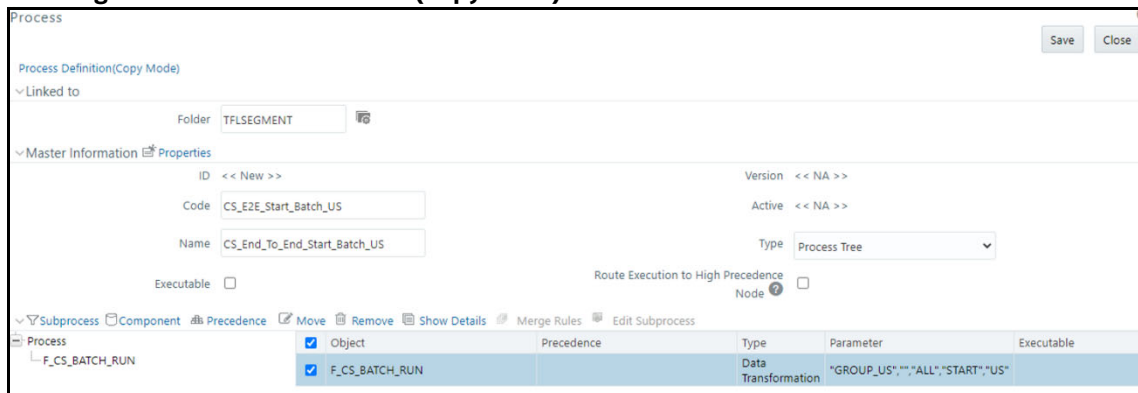



9. Select **Component**.

10. In the **Parameters** window, select the F_CS_BATCH_RUN task and then click **drop-down list**. Change the parameter ORACLECS to the entry made in the cs_processing_group table and the parameter CS to the Jurisdiction Code. For example, "GROUP_US", "", "ALL", "START", "US".

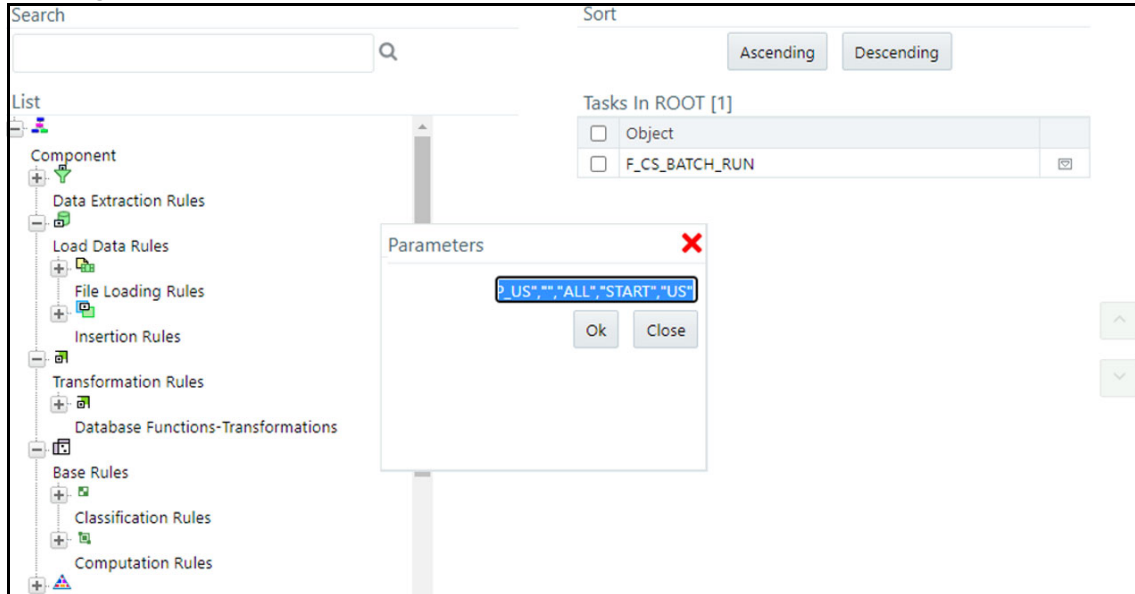
Figure 49: Component Selector Window



11. Click **OK** to close the **Parameters** window.
12. Click **OK**.
13. Click **Save**.
14. Search for *End* in the **Code** field and select CS_End_To_End_End_Batch.
15. Click **Copy** . The **Run** Page opens in **Copy** mode.
16. In the **Folder** field, first click **Folder**  and then select **TFLSEGMENT**.
17. In the **Name** field, change the job name to include the Jurisdiction Code. For example, CS_Data_Load_Event_Generation_US.
18. Select F_CS_BATCH_RUN.
19. Select **Component**.
20. In the **Parameter** field, change the parameter ORACLECS to the entry made in the cs_processing_group table, for example, GROUP_US, and the parameter CS to the Jurisdiction Code, for example, US.
21. Click **OK**.
22. Click **OK**.
23. Click **Save**.

A confirmation message appears. The new parameter is now displayed in the **Run** page.

NOTE

In the example shown, the new processing batch name has been changed from CS to US. If this change is not made, no data is loaded in the tables.

4.15.3.2 Creating a Run

To create a run, follow these steps:

1. Log on to the Customer Screening application.
2. Click **Common Tasks**, then click **Rule Run Framework**, and then click **Run**. The **Run Page** appears.

Figure 50: Run Page

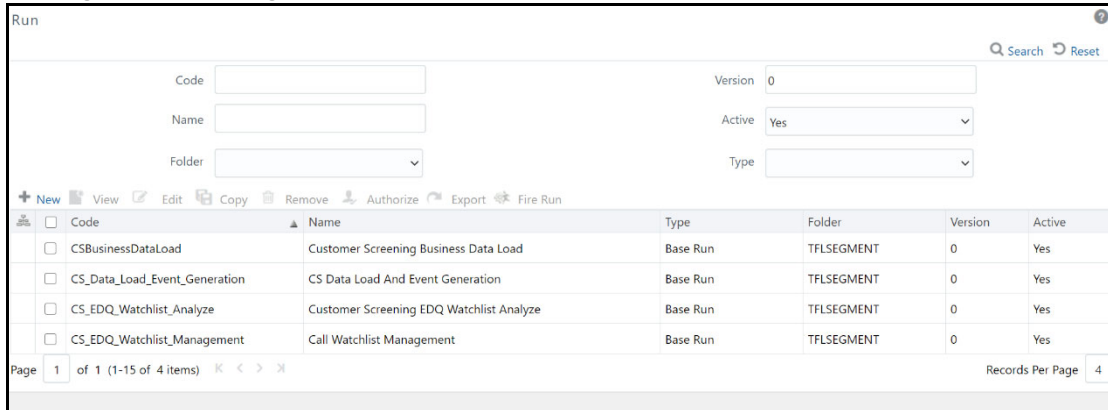

3. Search for *Start* in the **Code** field and select CS_End_To_End_Start_Batch.
4. Click **Copy** . The **Run Page** opens in **Copy** mode.

Figure 51: Run Definition (Copy Mode) Page

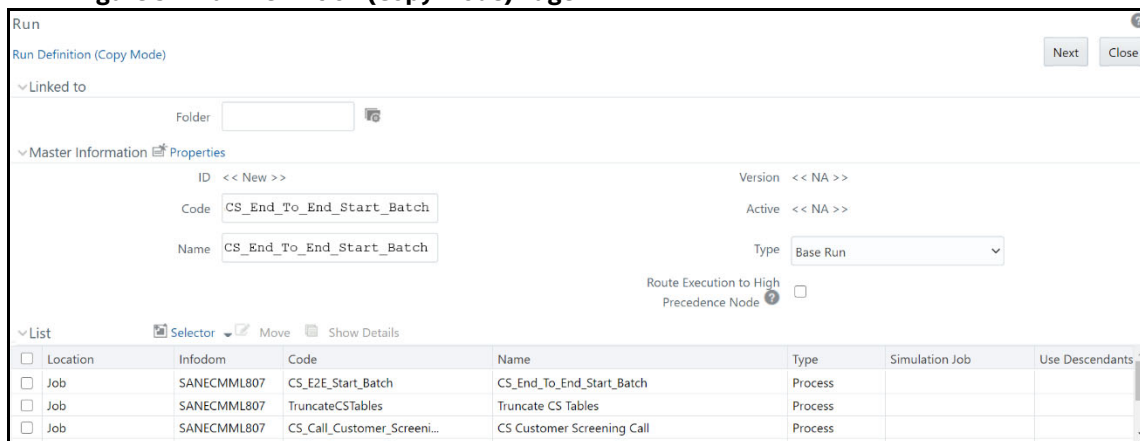

5. In the **Folder** field, click **Folder** and then select **TFLSEGMENT**.

Figure 52: Folder Selector

Name	Code
<input type="checkbox"/> TFLSEGMENT	TFLSEGMENT

- In the **Name** field, change the job name to include the Jurisdiction Code. For example, CS_Data_Load_Event_Generation_US.
- Click **Selector** list and select **Job**.
- In the **Component Selector** page, first select the CS_End_To_End_Start_Batch, CS_End_To_End_End_Batch, and Truncate CS Tables tasks (in that order) from the **Tasks** table and then click to move them to the **List** table. The tasks are moved to the **Processes** node.

Figure 53: Component Selector

	Tasks [6]	
<input type="checkbox"/>	Object	
<input checked="" type="checkbox"/>	CS_End_To_End_Start_Batch	
<input checked="" type="checkbox"/>	Truncate CS Tables	
<input type="checkbox"/>	CS Customer Screening Call	
<input type="checkbox"/>	CS External Entity Screening Call	
<input type="checkbox"/>	CS Event Creation	
<input checked="" type="checkbox"/>	CS_End_To_End_End_Batch	

WARNING Ensure that you remove the Truncate CS Tables job to prevent the removal of data. If, by mistake, you run the Truncate CS Tables job, you can run the CSBusinessDataLoad job to reload data in the table.

- Replace these tasks with the task created in [Step 17](#), that is, CS_Data_Load_Event_Generation_US. If you do not make this change, no data is loaded in the tables.
- Click **OK**.

11. Click **OK**.
12. Click **Save**.

The new job is displayed in the **Run** page.

NOTE

These steps must also be done in the ECM setup. The processes and runs created in Customer Screening create alerts, and the processes and runs created in ECM fetch the alerts. Cases are generated from these alerts. An example of a process created for ECM is `Oracle_CS_Event_Processing` and an example of a run created for ECM is `Oracle_CS_Event_Processing_US`.

4.16 Configurations for General Data Protection Regulation (GDPR)

GDPR is a set of data protection rules. The main aim of GDPR is to give control to individuals over their data.

To enable GDPR, perform the following configurations:

1. Create a user who will do the GDPR configurations in the same database, for example, GDPR.
2. Assign the `OFS_NOSEC_DATA` privilege to the user by executing the following grant:

```
GRANT OFS_NOSEC_DATA to GDPR
```

3. Follow these steps to connect to the user:
 - a. Create a synonym called `cs_customer` for the user by executing the following command:

```
CREATE PUBLIC SYNONYM cs_customer FOR {dbname}.cs_customer
```

{dbname} is the user for whom the `CUST` data and GDPR is applied

Go to the EDQ URL and open the **Director** menu. The **Director** landing page appears.

Figure 54: Director Menu in EDQ

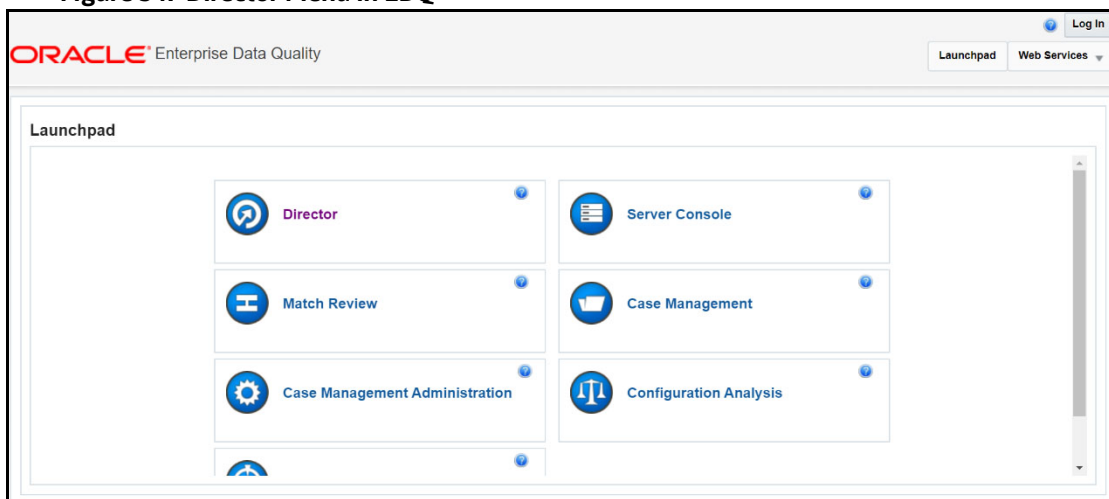

- b. In the **Director** landing page, expand the **Customer-Screening** project in the **Project Browser** pane.

Figure 55: Project Browser Pane

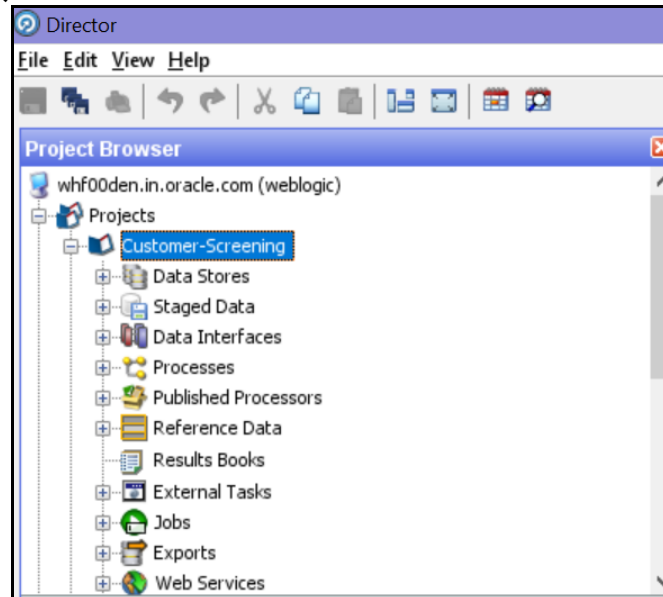

- c. Expand the **Data Stores** node and open **FCDM Batch Data**. The **Edit Data Store** window appears.

Figure 56: Edit Data Store Window

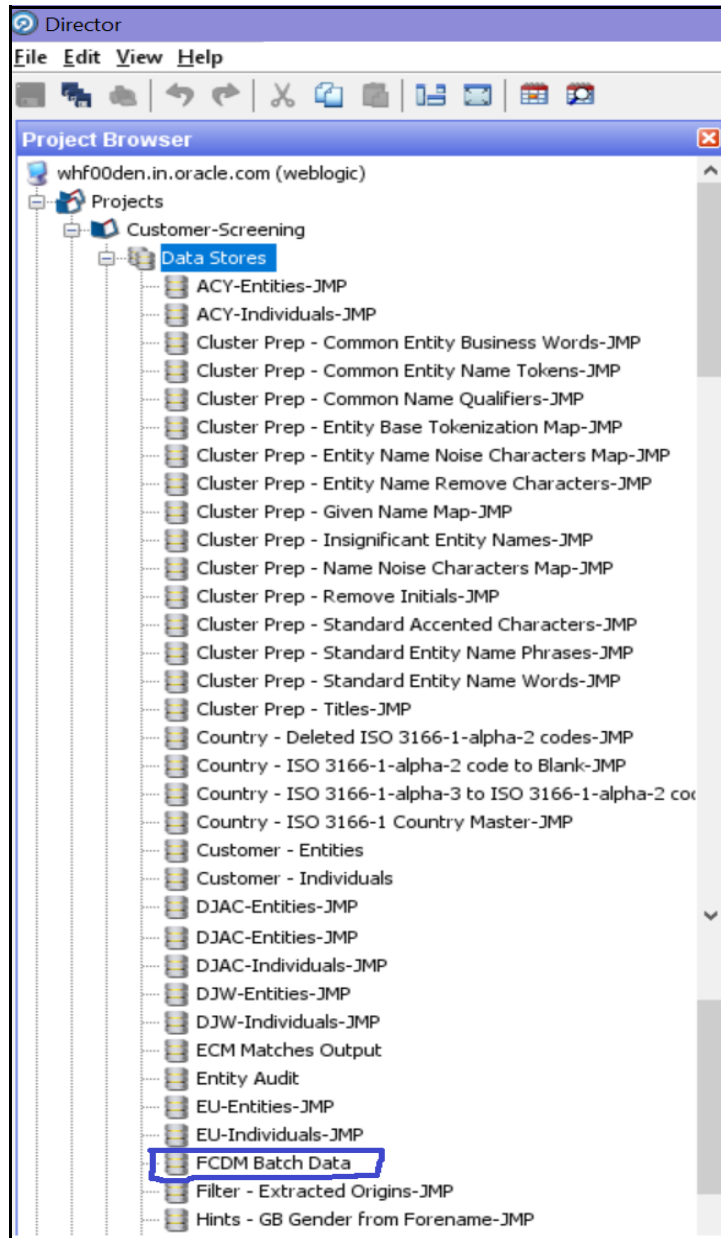

- d. In the **Edit Data Store** window, enter the **Database host, Port, Database name, User name,** and **Password**.

Figure 57: Edit Data Store for Staging Database Connection

The GDPR configurations are now enabled for the GDPR user. You can view the applicable data in the CUST table.

4.17 Optional Configurations

You can perform the following optional configurations:

4.17.1 Data Quality Check

- To run the Data Quality (DQ) check, set the following values in the `watch list-management.properties` file. This file is located in the `<domain_name>/edq/oedq.local.home/runprofiles/` directory in the WinSCP server.
 - `phase.DQ\ -\ Stage\ DJW\ reference\ lists.enabled = Y`
 - `phase.DQ\ -\ DJW\ reference\ data\ quality\ analysis.enabled = Y`
 - `stageddata.DQ\ DJW\ -\ Invalid\ Standard\ Country\ in\ DJ\ Country\ to\ Standard\ Country.visible = Y`
 - `stageddata.DQ\ DJW\ -\ Missing\ Category\ in\ DJW\ SI\ Category.visible = Y`
 - `stageddata.DQ\ DJW\ -\ Missing\ Category\ in\ DJW\ SI\ Category\ Description.visible = Y`
 - `stageddata.DQ\ DJW\ -\ Missing\ DJW\ Country\ in\ DJ\ Country\ to\ Standard\ Country.visible = Y`
 - `stageddata.DQ\ DJW\ -\ Missing\ Name\ in\ DJW\ List\ Provider\ Reference\ Data.visible`
 - `stageddata.DQ\ DJW\ -\ Missing\ Occupation\ Name\ in\ DJW\ Occupation\ Category.visible`

- stageddata.DQ\ DJW\ -\ Obsolete\ Category\ in\ DJW\ SI\ Category.visible
- stageddata.DQ\ DJW\ -\ Obsolete\ Category\ in\ DJW\ SI\ Category\ Description.visible
- stageddata.DQ\ DJW\ -\ Obsolete\ DJW\ Country\ in\ DJW\ Country\ to\ Standard\ Country.visible
- stageddata.DQ\ DJW\ -\ Obsolete\ Name\ in\ DJW\ List\ Provider\ Reference\ Data.visible
- stageddata.DQ\ DJW\ -\ Obsolete\ Occupation\ Name\ in\ DJW\ Occupation\ Category.visible
- To move data from the Windows batch file to the Linux shell script, follow these steps in the `watch list-management.properties` file:
 - Comment out `phase.DJW\ -\ Download.externaltasks.Download\ Dow\ Jones\ Watch list.command = download-djw.bat`
 - Uncomment `phase.DJW\ -\ Download.externaltasks.Download\ Dow\ Jones\ Watch list.command = download-djw.sh`

4.17.2 Sorting Real-Time Watchlist Details

The order of Watchlist details displayed on the UI for Real-Time Screening alerts in CSAM or Case in ECM can be configured in this table:

`cs_rt_watchlistdetails_order`

The Order can be defined for Individual and Entity separately.

NOTE	If you want to insert any new field in between the order list, make sure <code>N_ORDER</code> column is properly sorted.
-------------	--

This change gets reflected in the following UIs:

- On click of Watchlist ID in Real-time Screening UI
- Watchlist Details in Alert Details page in CSAM
- Watchlist Details in Case Details page in ECM

5 Integrations with Enterprise Case Management

Customer Screening uses the Enterprise Case Management (ECM) application to investigate and manage cases generated by the matching process in Customer Screening.

The following sections describe the default case types and workflows provided with **Oracle Financial Services Enterprise Case Management**. For more information, see [Oracle Financial Services Enterprise Case Management Admin Guide](#).

5.1 Case Class in ECM

For Customer Screening Application, the following case classes have been added in the Oracle Financial Services Enterprise Case Management Application:

- CS
- CS_EE
- CS_RT

To add new case classes, follow the steps in the **Adding Case Class** section in the [Oracle Financial Services Enterprise Case Management Admin Guide](#).

Figure 58: Case Designer Page

The screenshot displays the Oracle Case Designer interface. On the left, a sidebar lists various case types, with 'CS_EE_EDD' selected. The main area is titled 'Case Type Definition' and shows the configuration for the selected case type. The 'Case Class' is set to 'CS' and the 'Description' is 'External Entity EDD'. The 'Case Type' is 'CS_EE_EDD'. Below this, there are tabs for 'Attributes', 'Entities', and 'Workflow'. The 'Attributes' tab is active, showing a list of 'Available Attributes' (Document Control #, Scenario Class, Risk Score, Next Periodic Review Date, KYC Risk Score Expiration) and a list of 'Selected Attributes' (Case ID, Class, Type, Status, Title, Jurisdiction, Business Domain, Priority, Created). Below the attribute lists, there is a form for defining the case type attributes, including fields for Case ID, Type, Title, Business Domain, Created, Due, Closed, Description, Class, Status, Jurisdiction, Priority, Owner Organization, Owner, and Assignee. The 'Entities' and 'Workflow' sections are currently collapsed. At the bottom right, there are 'Save' and 'Cancel' buttons.

5.2 Case Types under Case Class

The following case types are created for the CS case class:

- **CS_EDD:** Enhanced Due Diligence (EDD)
- **CS_PRB:** Prohibition (PRB)
- **CS_SAN:** Sanctions (SAN)
- **CS_EE_EDD:** Enhanced Due Diligence (EDD) for External Entity screening
- **CS_EE_PEP:** Politically Exposed Person (PEP) for External Entity screening
- **CS_EE_PRB:** Prohibition (PRB) for External Entity screening
- **CS_EE_SAN:** Sanctions (SAN) for External Entity screening
- **CS_PEP:** Politically Exposed Person (PEP)
- **CS_RT_EDD:** Enhanced Due Diligence (EDD) for Real-Time screening
- **CS_RT_PEP:** Politically Exposed Person (PEP) for Real-Time screening
- **CS_RT_PRB:** Prohibition (PRB) for Real-Time screening
- **CS_RT_SAN:** Sanctions (SAN) for Real-Time screening

For each Case Type, default Entities are mapped. If additional Entities are required, see the **Adding Optional Entities to the Case Type** section in [Oracle Financial Services Enterprise Case Management Admin Guide](#).

5.3 Case Correlation, Linked Cases, and Searching for Cases

After the Customer Screening batch is run, alerts are correlated into cases based on the watch list record type. More than one case can be generated for a single alert, one each for Sanctions (SAN), Country Prohibitions (PRB), Politically Exposed Persons (PEP), and Enhanced Due Diligence (EDD).

You can view the case which is linked with the case being investigated. The following image shows the fields:

Figure 59: Link Cases Window

The screenshot shows a window titled "Link Cases" with a close button (X) in the top right corner. The window contains three main sections:

- Selected Cases:** A text field containing the value "CA101".
- Action:** A dropdown menu with the text "Select a value" and a downward arrow.
- Comments:** A large, empty text area for entering notes.

 At the bottom right of the window, there are two buttons: "Save" and "Cancel".

You can configure the correlation rules for an alert in the **Correlation** tab, or view the cases linked to the case being investigated in the **Relationship** tab. For more information, see the **Using Operational Data Tabs** section in [Oracle Financial Services Enterprise Case Management User Guide](#).

There are certain ready-to-use Customer Screening case type search criteria. They can be viewed in the **Search Cases** tab in ECM. For more information, see the **Searching Cases** section in [Oracle Financial Services Enterprise Case Management User Guide](#).

Figure 60: Search Cases Window

Home > Search Cases

Case Search [Less Search Criteria](#) Views [Select a View](#) [Save View](#) Search By [Case ID](#)

Created From

Class

Title

Entity Type

Action Type Workflow Operational

Action From

Due From

Closed From

Event Type

Standard Comments

Created By

To

Type

Jurisdiction

Entity ID

Case Action

To

To

To

Scenario

Narrative/Comments

[Search](#) [Reset](#)

5.4 Creating Workflows for Case Types

Each of the Sanctions (SAN), Country Prohibitions (PRB), Politically Exposed Persons (PEP), and Enhanced Due Diligence (EDD) cases go through a workflow. The SAN and PRB cases have the same ready-to-use workflow, and the PEP and EDD cases have the same workflow.

5.5 Workflow Diagrams

The following diagrams represent the workflows for the Sanctions (SAN), Politically Exposed Persons (PEP), Country Prohibition (PRB), or Enhanced Due Diligence (EDD) records:

5.5.1 SAN and PRB Workflow

The workflow for the sanctions and country prohibition records are as follows:

Figure 61: SAN and PRB Workflow

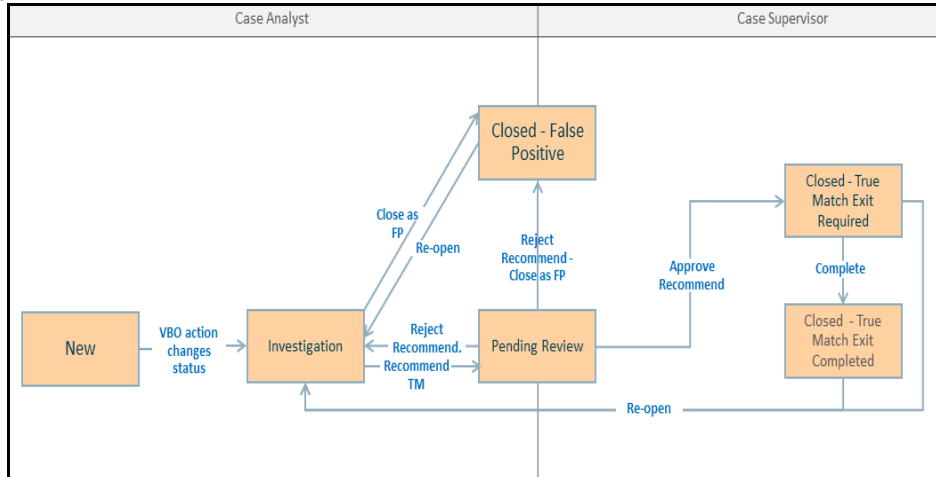

5.5.2 PEP and EDD Workflow

The workflow for the Politically Exposed Persons and Enhanced Due Diligence records are as follows:

Figure 62: PEP and EDD Workflow

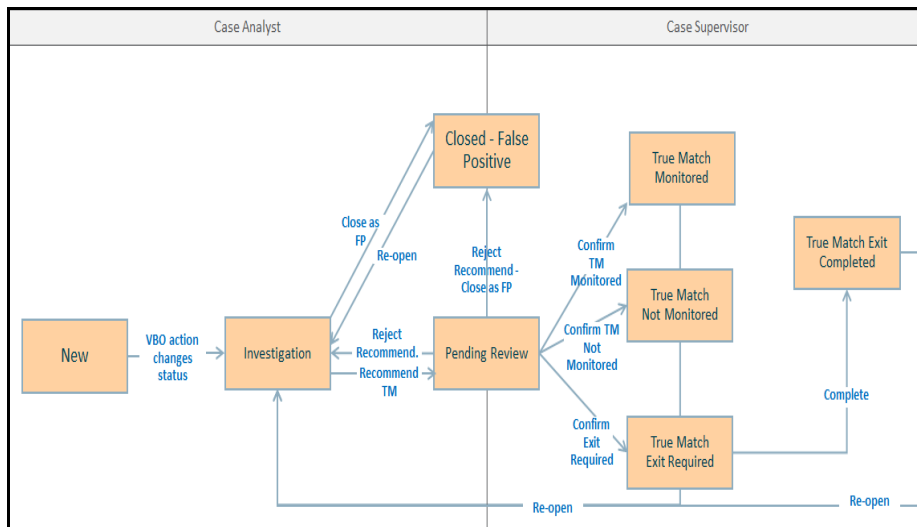

5.6 Taking Actions on Customer Screening-related Cases

You can take an action on a case depending on the workflow status, case type, and user. You can also add a comment and attach a document To take an action on a case, see the **Using Take Action Window** section in [Oracle Financial Services Enterprise Case Management User Guide](#).

The following figure shows a sample of an EDD workflow that has a Pending Review status and Supervisor user.

Figure 63: Take Action Window
NOTE

When a match decision is taken for an alert, you can make the comments mandatory or optional.

- To make comments mandatory, set the values of the REQ_CMNT_FL column in the KDD_ACTION table to **Y**. Run `select t.action_cd,t.action_nm from kdd_action t` and update the value. You cannot take an action until you provide a comment.
- To make comments optional, set the values of the REQ_CMNT_FL column in the KDD_ACTION table to **N**. You can take an action even if you do not provide a comment.

5.7 Setting Thresholds for Case Priorities

The case priority is based on the case type and risk score. You can set the case priority in the FCC_CASE_PRIORITY table. By default, if you do not set the case priority, it is set to **High**.

5.8 Merging Case Types

Alerts are correlated into cases based on the watch list record type when you run the Customer Screening batch. The record types Sanctions (SAN), Country Prohibitions (PRB), Politically Exposed Persons (PEP), and Enhanced Due Diligence (EDD) are merged under a single case ID based on the configuration. To merge ECM case types follow the below steps:

1. Create new case type under case the class CS in ECM from Case Designer. For example consider the case type CS_RT. Map the entities and workflow from the user interface while creating the

case type. see the **Managing Case Designer** section in **Oracle Financial Services Enterprise Case Management Admin Guide**.

2. Update the entries 12, 13, 14, and 15 in the FCC_CORRELATION_CASE_TYPE_MAP table with new case type CS_RT created in step 1. See **Figure 64**.

Figure 64: FCC_CORRELATION_CASE_TYPE_MAP table

N_CORRELATION_RULE_SKEY	V_CASE_TYPE
12	CS_RT
13	CS_RT
14	CS_RT
15	CS_RT

update FCC_CORRELATION_CASE_TYPE_MAP set v_case_type = 'CS_RT' where N_CORRELATION_RULE_SKEY in (12,13,14,15);

3. Add a new entry in the FCC_RT_EVENTTYPE_PTC table for the newly created case type CS_RT.

Figure 65: FCC_RT_EVENTTYPE_PTC Table

V_CASE_TYPE	N_SEQUENCE	V_T2T_CODE
CS_RT	5	CS_RT_KDD_CASE_RT_EXT_ID

insert into FCC_RT_EVENTTYPE_PTC select 'CS_RT', '5', 'CS_RT_KDD_CASE_RT_EXT_ID' from FCC_RT_EVENTTYPE_PTC where V_CASE_TYPE = 'CS_RT_SAN';

4. Update the entries 12, 13, 14, and 15 in FCC_CORRELATION_RULE table to reflect the new title for the case type CS_RT.

Figure 66: FCC_CORRELATION_RULE table

N_CORRELATION_RULE_SKEY	V_RULE_NAME	N_PATH_PRECEDENCE	V_EVENT_FILTER_OPERATIONS	V_EVENT_LINK_OPERATIONS
12	RT Screening	999	source.V_EVENT_TYPE='CS_RT_SAN'	(null)
13	RT Screening	999	source.V_EVENT_TYPE='CS_RT_PEP'	(null)
14	RT Screening	999	source.V_EVENT_TYPE='CS_RT_EDD'	(null)
15	RT Screening	999	source.V_EVENT_TYPE='CS_RT_PRB'	(null)

update FCC_CORRELATION_RULE set V_RULE_NAME = 'RealTime Screening' where N_CORRELATION_RULE_SKEY in (12,13,14,15);

5. In the Case Summary page, insert the status ID entries in the FCC_CASETYPE_EVENT_STATUS_MAP table for the new case type CS_RT to get the event decisions in the Set Event Decision window.

Figure 67: FCC_CASETYPE_EVENT_STATUS_MAP Table

V_CASE_TYPE_SUBTYPE_CD	N_STATUS_ID
CS_RT	3
CS_RT	4

insert into FCC_CASETYPE_EVENT_STATUS_MAP select 'CS_RT', n_status_id from FCC_CASETYPE_EVENT_STATUS_MAP where V_CASE_TYPE_SUBTYPE_CD = 'CS_RT_SAN';

6. To get the details in Take Action Pop-up window, insert the below entries in the KDD_CASETYPE_ACTION_MAP-SEQ table for the new case type CS_RT.

Figure 68: KDD_CASETYPE_ACTION_MAP-SEQ Table

CASE_CASETYPE_ACTION_MAP_SEQ	ACTION_CD	CASE_TYPE_SUBTYPE_CD
1	1702 CA6	CS_RT
2	1703 CA921	CS_RT
3	1704 CA922	CS_RT
4	1705 CA934	CS_RT
5	1706 CA935	CS_RT
6	1707 CA936	CS_RT
7	1708 CA937	CS_RT
8	1709 CA938	CS_RT
9	1710 CA939	CS_RT
10	1711 CA961	CS_RT
11	1712 CA8	CS_RT

```
Insert into KDD_CASETYPE_ACTION_MAP
(CASE_CASETYPE_ACTION_MAP_SEQ,ACTION_CD,CASE_TYPE_SUBTYPE_CD) values ((select
max(CASE_CASETYPE_ACTION_MAP_SEQ) from
kdd_casetype_action_map)+1, 'CA6', 'CS_RT');
```

```
Insert into KDD_CASETYPE_ACTION_MAP
(CASE_CASETYPE_ACTION_MAP_SEQ,ACTION_CD,CASE_TYPE_SUBTYPE_CD) values ((select
max(CASE_CASETYPE_ACTION_MAP_SEQ) from
kdd_casetype_action_map)+1, 'CA921', 'CS_RT');
```

```
Insert into KDD_CASETYPE_ACTION_MAP
(CASE_CASETYPE_ACTION_MAP_SEQ,ACTION_CD,CASE_TYPE_SUBTYPE_CD) values ((select
max(CASE_CASETYPE_ACTION_MAP_SEQ) from
kdd_casetype_action_map)+1, 'CA922', 'CS_RT');
```

```
Insert into KDD_CASETYPE_ACTION_MAP
(CASE_CASETYPE_ACTION_MAP_SEQ,ACTION_CD,CASE_TYPE_SUBTYPE_CD) values ((select
max(CASE_CASETYPE_ACTION_MAP_SEQ) from
kdd_casetype_action_map)+1, 'CA934', 'CS_RT');
```

```
Insert into KDD_CASETYPE_ACTION_MAP
(CASE_CASETYPE_ACTION_MAP_SEQ,ACTION_CD,CASE_TYPE_SUBTYPE_CD) values ((select
max(CASE_CASETYPE_ACTION_MAP_SEQ) from
kdd_casetype_action_map)+1, 'CA935', 'CS_RT');
```

```
Insert into KDD_CASETYPE_ACTION_MAP
(CASE_CASETYPE_ACTION_MAP_SEQ,ACTION_CD,CASE_TYPE_SUBTYPE_CD) values ((select
max(CASE_CASETYPE_ACTION_MAP_SEQ) from
kdd_casetype_action_map)+1, 'CA936', 'CS_RT');
```

```
Insert into KDD_CASETYPE_ACTION_MAP
(CASE_CASETYPE_ACTION_MAP_SEQ,ACTION_CD,CASE_TYPE_SUBTYPE_CD) values ((select
max(CASE_CASETYPE_ACTION_MAP_SEQ) from
kdd_casetype_action_map)+1, 'CA937', 'CS_RT');
```

```
Insert into KDD_CASETYPE_ACTION_MAP
(CASE_CASETYPE_ACTION_MAP_SEQ,ACTION_CD,CASE_TYPE_SUBTYPE_CD) values ((select
max(CASE_CASETYPE_ACTION_MAP_SEQ) from
kdd_casetype_action_map)+1, 'CA938', 'CS_RT');
```



```

Insert into KDD_CASETYPE_ACTION_MAP
(CASE_CASETYPE_ACTION_MAP_SEQ,ACTION_CD,CASE_TYPE_SUBTYPE_CD) values ((select
max(CASE_CASETYPE_ACTION_MAP_SEQ) from
kdd_casetype_action_map)+1, 'CA939', 'CS_RT');

```

```

Insert into KDD_CASETYPE_ACTION_MAP
(CASE_CASETYPE_ACTION_MAP_SEQ,ACTION_CD,CASE_TYPE_SUBTYPE_CD) values ((select
max(CASE_CASETYPE_ACTION_MAP_SEQ) from
kdd_casetype_action_map)+1, 'CA961', 'CS_RT');

```

```

Insert into KDD_CASETYPE_ACTION_MAP
(CASE_CASETYPE_ACTION_MAP_SEQ,ACTION_CD,CASE_TYPE_SUBTYPE_CD) values ((select
max(CASE_CASETYPE_ACTION_MAP_SEQ) from
kdd_casetype_action_map)+1, 'CA8', 'CS_RT');

```

- To get the values in standard comments drop down, insert below entries in KDD_CASE_TYPE_CMMNT table for the new case type CS_RT.

Figure 69: KDD_CASE_TYPE_CMMNT Table

	⚙ CASE_TYPE_CD	⚙ CMMNT_ID
1	CS_RT	8155
2	CS_RT	8156
3	CS_RT	8157
4	CS_RT	8158
5	CS_RT	8159

```

insert into kdd_case_type_cmmnt select 'CS_RT', CMMNT_ID from
kdd_case_type_cmmnt where CASE_TYPE_CD = 'CS_RT_SAN';

```

- Map the OWNER_SEQ_ID table entry with the new case type CS_RT created in the KDD_REVIEW_OWNER_CASE_TYPE table and restart the server.

Figure 70: OWNER_SEQ_ID Table

	⚙ OWNER_SEQ_ID	⚙ CASE_TYPE_CD
1	10008	CS_RT

```

INSERT INTO KDD_REVIEW_OWNER_CASE_TYPE (OWNER_SEQ_ID, CASE_TYPE_CD) VALUES
($OWNER_SEQ_ID$, 'CS_RT')

```

6 Real-Time Screening

There are two ways to perform screening in the Customer Screening application: real-time screening and batch screening.

Real-time screening is the screening of individuals and entities that occur when you enter data in the Real-Time Screening page and click **Scan** (Analyst & Supervisor) and **Scan & Investigate** (Analyst & Supervisor) to see the screening results and details of Alert generation or Case creation. You can also view the Alert details or Case details from screening results. For more information, see [Running the Real-Time Screening Job](#). To enable scan & Investigate, map the role Scan & Investigate to CSRTGRP group.

Batch screening is the screening of individuals and entities that occur when you run the batch screening job. Before you run the job, you must first configure the Enterprise Data Quality (Director) details and then prepare and analyze the customer screening and external entity data in the Financial Crime Data Model (FCDM). For more information, see [Running the Batch Screening Job](#).

The following image shows the different components involved during the Real-time screening process:

Figure 71: Real-Time Screening Workflow

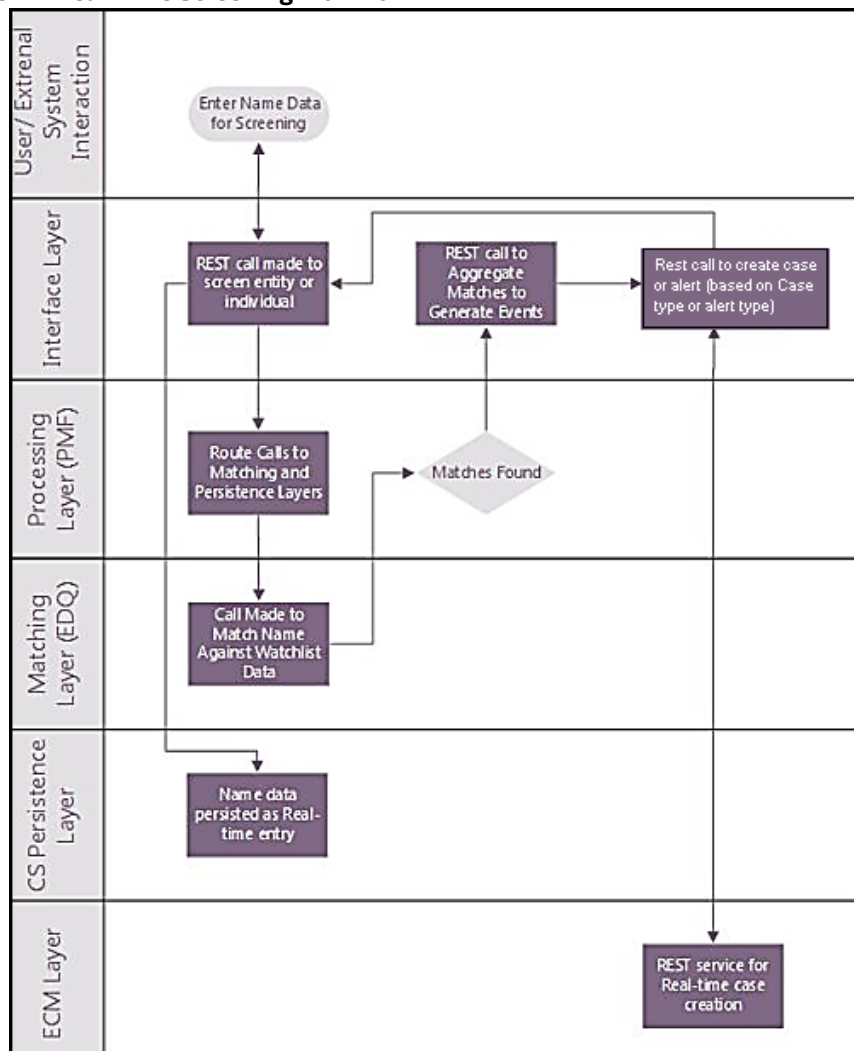

After you provide data on the **Real-Time Screening** page, a REST call is made to the individual or entity being screened in the real-time screening user interface. The call is then routed to the **Enterprise**

Data Quality (EDQ) system through the **Process Modelling Framework** (PMF) application. The information is then matched against the watch list data. Data is also persisted as external entities in the `FCT_RTSCR_REQUEST` table.

If a match is found, the matches are aggregated. The aggregated matches are used to create alerts and cases for external entities in Financial Crime Data Model (FCDM) and Analytical Application Infrastructure (AAI) and generate responses in PMF. The alerts or cases are displayed in the **Case Summary** page in L1 Alert Management or Enterprise Case Management (ECM) for investigation.

NOTE

- Real-time screening can be performed only when the real-time screening job in EDQ is running.
- To cancel the real-time screening process, select **Shutdown web services** in the **Cancel Individual Real-time Screening web services** dialog box.
- The Real-time access group must only be mapped to the case supervisor or the case analyst users and must not be mapped to the admin user.

6.1 Configuring the EDQ URL

The Configuring the EDQ URL section describes the detailed process to configure the EDQ URL in Real-Time Screening with Customer Screening Alert Management (CSAM) and Enterprise Case Management (ECM) in the server.

To configure the EDQ URL for Real-time screening, follow these steps:

1. Navigate to the `FCI_DB_HOME/bin` directory.
2. Execute the command `/EDQInsert.sh <INFODOM NAME>`. This step is used to register the EDQ server details. You must replace the `INFODOM NAME` placeholder with your domain name.
3. Enter the following details in the console where the command is run:
 - EDQ server IP: An example of the EDQ URL is `<Host Name>:Port`. Replace this with your EDQ server's URL.
 - EDQ Server Direct Port number: This is the JMX port number. This value must be 8090.
 - EDQ Server User Name: An example of the EDQ server user name is `weblogic`. Replace this with your EDQ server's user name.
 - EDQ Password: An example of the EDQ password is `weblogic1`. Replace this with your EDQ server's password.
4. Enter `CSAM` for alert management if the Customer Screening Alert Management (CSAM) is as L1 investigation for Real Time Screening.
5. If the Customer Screening Alert Management application is in the same server, see [Figure 72](#). If not, see [Figure 73](#).

Figure 72: Configure the EDQ URL in Real-time Screening with Customer Screening Alert Management (CSAM) in the same Server

```

/scratch/ofsaaaweb/ZIPPER/ZIPPER/110db/din>./EDQinsert.sh INFOZIPBEH
Started finding Jars
Ended finding Jars
Classpath Created
Calling EDQ Main Method
Inside EDQ insert method
Enter EDQ Server IP:
whf00ath.in.oracle.com
Enter EDQ Server Director Port:
8090
Enter EDQ Server User Name:
weblogic
Enter EDQ Password:
Encrypting password
Do you want Enterprise Case Management Application(ECM) or Customer Screening Alert Management(CSAM) as L1 investigation for Real Time Screening? (Please enter ECM/CSAM)
)
CSAM
Enter Customer Screening Alert Management (CSAM) URL:
http://whf00ath:8010/zipper
Is Customer Screening Alert Management(CSAM) Application in the same installation? (Please enter Y/N)
Y

```

Figure 73: Configure the EDQ URL in Real-time Screening with Customer Screening Alert Management (CSAM) in different Server

```

/scratch/ofsaaaweb/ZIPPER/ZIPPER/110db/bin>./EDQinsert.sh INFOZIPBEH
Started finding Jars
Ended finding Jars
Classpath Created
Calling EDQ Main Method
Inside EDQ insert method
Enter EDQ Server IP:
whf00ath.in.oracle.com
Enter EDQ Server Director Port:
8090
Enter EDQ Server User Name:
weblogic
Enter EDQ Password:
Encrypting password
Do you want Enterprise Case Management Application(ECM) or Customer Screening Alert Management(CSAM) as L1 investigation for Real Time Screening? (Please enter ECM/CSAM)
)
CSAM
Enter Customer Screening Alert Management (CSAM) URL:
http://whf00ath:8010/zipper
Is Customer Screening Alert Management(CSAM) Application in the same installation? (Please enter Y/N)
N
Enter Customer Screening Alert Management (CSAM) User Name:
csanalyst
Enter Customer Screening Alert Management (CSAM) Password:
Encrypting password
configurationPath:::/scratch/ofsaaaweb/ZIPPER/ZIPPER
FTC HOME:/scratch/ofsaaaweb/ZIPPER/ZIPPER/

```

6. Enter ECM for case creation if the Enterprise Case Management (ECM) is as L1 investigation for Real Time Screening.
 - a. If the Enterprise Case Management application is in the same server, see Figure 58. If not, see Figure 59.

Figure 74: Configure the EDQ URL in Real-time Screening with Enterprise Case Management (ECM) in the same Server

```

/scratch/ofsaaaweb/ZIPPER/ZIPPER/110db/din>./EDQinsert.sh INFOZIPBEH
Started finding Jars
Ended finding Jars
Classpath Created
Calling EDQ Main Method
Inside EDQ insert method
Enter EDQ Server IP:
whf00ath.in.oracle.com
Enter EDQ Server Director Port:
8090
Enter EDQ Server User Name:
weblogic
Enter EDQ Password:
Encrypting password
Do you want Enterprise Case Management Application(ECM) or Customer Screening Alert Management(CSAM) as L1 investigation for Real Time Screening? (Please enter ECM/CSAM)
)
ECM
Enter Enterprise Case Management Application(ECM) URL:
http://whf00ath:7009/ECHSANS08
Is Enterprise Case Management Application (ECM) in the same installation? (Please enter Y/N)
Y
configurationPath:::/scratch/ofsaaaweb/ZIPPER/ZIPPER
FTC HOME:/scratch/ofsaaaweb/ZIPPER/ZIPPER/

```

Figure 75: Configure the EDQ URL in Real-time Screening with Enterprise Case Management (ECM) in the different Server

```

/scratch/ofsaweb/ZIPPER/ZIPPER/ficdb/bin/./EDQInsert.sh INFOZIPBEH
Started finding Jars
Ended finding Jars
Classpath Created
Calling EDQ Main Method
Inside EDQ insert method
Enter EDQ Server IP:
whf00ath.in.oracle.com
Enter EDQ Server Director Port:
3090
Enter EDQ Server User Name:
weblogic
Enter EDQ Password:
Encrypting password
Do you want Enterprise Case Management Application (ECM) or Customer Screening Alert Management (CSAM) as LI investigation for Real Time Screening? (Please enter ECM/CSAM)
ECM
Enter Enterprise Case Management Application (ECM) URL:
http://whf00anu:7009/ECMSAN808
Is Enterprise Case Management Application (ECM) in the same installation? (Please enter Y/N)
Y
Enter Enterprise Case Management Application (ECM) User Name:
analyst
Enter Enterprise Case Management Application (ECM) Password:
Encrypting password
configurationPath:::/scratch/ofsaweb/ZIPPER/ZIPPER
FIC HOME:/scratch/ofsaweb/ZIPPER/ZIPPER/

```

7. Configure the EDQ URL in the CONFIG schema. To do this, run the following script and replace the placeholders in the `v_method_name` and `v_param_1` columns with the EDQ URL, EDQ user name, and EDQ password respectively:

```

select t.*,t.rowid from aai_wf_application_api_b t where
t.v_process_id='CSRT' and t.v_app_api_id in
('1521535704140','1521535760435')

```

6.2 Screening Watch List Records in Real-Time

Real-time screening is the screening of individuals and entities that occur when you enter data in the Real-Time Screening page and click Scan (Analyst & Supervisor) and Scan & Investigate (Analyst & Supervisor) to see the screening results and details of Alert generation or Case creation. You can also view the Alert details or Case details from screening results.

NOTE

Creating an Alert or Case is configurable. The Alert or Case will be generated when you select **CSAM** or **ECM**, respectively, while configuring EDQ URL. For more details, see [Configuring the EDQ URL](#) section.

To screen watch list records, follow these steps:

1. Log on to the Customer Screening application.
2. Click **Real-Time Screening** is displayed.

Figure 76: Real-Time Screening Page

The screenshot shows the Real-Time Screening page with the following fields and controls:

- Search type: Individual Entity
- Given Names *
- Family Names *
- Original Script Name
- Date of Birth (mm/dd/yy)
- Jurisdiction * (Americas)
- Business Domain * (GEN)
- City
- Passport Number
- Address Country
- Residency Country
- Nationalities
- Passport Issuing Country
- Country of Birth
- External ID Type
- External ID
- Identification Numbers
- Buttons: Scan, Scan & Investigate, Clear

3. In the **Real-Time Screening** page, select the search type as **Individual** or **Entity**.

NOTE

- When L1 Investigation is CSAM, the `fcc_zcs_security_attr_grp_map` table must be populated to populate the business domain and jurisdiction.
- When L1 Investigation is ECM, the ECM security mapper batch must be executed to populate the business domain and jurisdiction.

4. The following fields appear if the search type is **Individual**.

Figure 77: Individual Search Type

The screenshot shows the Oracle Financial Services Analytical Applications Customer Screening interface. At the top, it says "ORACLE Financial Services Analytical Applications Customer Screening" and "US-English". Below this, there are two radio buttons for "Individual" (selected) and "Entity". The form is divided into several sections with input fields:

- Given Names ***: Text input field.
- Family Names ***: Text input field.
- Original Script Name**: Text input field.
- Date of Birth**: Text input field with a calendar icon and a date format "mm/dd/yyyy".
- Source Request ID**: Text input field.
- Jurisdiction ***: Dropdown menu with "Americas" selected.
- Business Domain ***: Dropdown menu with "GEN" selected.
- City**: Text input field.
- Passport Number**: Text input field.
- Address Country**: Text input field.
- Residency Country**: Text input field.
- Nationalities**: Text input field.
- Passport Issuing Country**: Text input field.
- Country of Birth**: Text input field.
- External ID Type**: Dropdown menu.
- External ID**: Text input field.
- Identification Numbers**: Text input field.

At the bottom of the form, there are three buttons: "Scan", "Scan & Investigate", and "Clear".

Enter/Select values for the Individual Search Type fields:

- Given Names
- Jurisdiction
- Business Domain
- Family Names
- Address Country
- Country of Birth
- Residency Country
- External ID Type
- Original Script Name
- City
- Nationalities
- External ID
- Date of Birth
- Passport Number
- Passport Issuing Country
- Identification Numbers

- Source Request ID

NOTE

- The combination of Given Name and Family Name or Original Script Name or Passport Number along with Jurisdiction and Business Domain must provide to scan.
- The Source request ID is used to reconfigure and suppress the duplication of RT screening and Batch screening generated cases. For more information see [Suppression of Alerts](#).

5. The following fields appear if the search type is **Entity**.

Figure 78: Entity Search Type

The screenshot shows the Oracle Financial Services Analytical Applications Customer Screening interface. The search type is set to 'Entity'. The form contains the following fields:

- Given Names *
- Family Names *
- Original Script Name
- Date of Birth (mm/dd/yyyy)
- Source Request ID
- Jurisdiction * (Americas)
- Business Domain * (GEN)
- City
- Passport Number
- Address Country
- Residency Country
- Nationalities
- Passport Issuing Country
- Country of Birth
- External ID Type
- External ID
- Identification Numbers

Buttons: Scan, Scan & Investigate, Clear

Provide details in the following mandatory fields:

- Entity Name
- Jurisdiction
- Business Domain
- Address Country
- Operating Countries
- Registration Country
- External ID Type
- Original Script Name
- City
- External ID
- Identification Numbers
- Source Request ID

NOTE

- The combination of Entity Name or Original Script Name along with Jurisdiction and Business Domain must be provided to Scan.
- The Source request ID is used to reconfigure and suppress the duplication of RT screening and Batch screening generated cases. For more information see [Suppression of Alerts](#).

For more details on fields, see the [Field Descriptions](#) section.

6. Perform the following for **Individual** or **Entity**:
7. Click **Scan**. The screened watch list records are displayed.
 - a. For Analyst & Supervisor:

Click **Scan**. The screened watch list records are displayed without creating an Alert in the L1 Investigation or case in ECM.

Figure 79: Scanning Real-time Screening Records Table

Select the search type: Individual Entity

Given Names *
MUHAMMAD

Family Names *
MUHAMMAD

Original Script Name

Date of Birth
mm/dd/yy

Jurisdiction *
Americas

Business Domain *
GEN

City

Passport Number

Address Country

Residency Country

Nationalities

Passport Issuing Country

Country of Birth

External ID Type

External ID

Identification Numbers

Buttons: Scan, Scan & Investigate, Clear

List Key	Name Type	Primary Name	Full Name
UN	Alias	MOHAMMAD BAQER ZOLQADR	MOHAMMAD BAKR ZOLQADR MOHAMMAD BAKR ZOLKADR MOHAMMAD BAQER ZOLQADR MOHAMMAD BAQER ZOLQADR

Page 1 of 1 (1 of 1 items)

- b. For Analyst & Supervisor:

Click **Scan**. It displays the screened watch list records.

Click **Scan & Investigate**. It generates an alert in the L1 Investigation or case in ECM based on the configurations.

The alert ID or Case ID results are displayed.

Figure 80: Scanning Real-time Screening – Individual (Supervisor)

Select the search type: Individual Entity

Given Names *
Robert

Family Names *
Mugabe

Original Script Name

Date of Birth
mm/dd/yy

Jurisdiction *
Americas

Business Domain *
GEN

City

Passport Number

Address Country

Residency Country

Nationalities

Passport Issuing Country

Country of Birth

External ID Type

External ID

Identification Numbers

Buttons: Scan, Scan & Investigate, Clear

1 Alert created with 2 events

Alert ID: 1002 | Record Type: SAN

List Key	Name Type	Primary Name	Full Name	Original Script Name	Watchlist ID	Match Rule	Match Score	Country	Nationality
OFAC	Primary	Robert Gabriel MUGABE	ROBERT GABRIEL MUGABE		7480	[06600] Abbreviated standardized given name only	81		
EU	Primary	ROBERT GABRIEL MUGABE	ROBERT GABRIEL MUGABE		1	[06600] Abbreviated standardized given name only	81		

Page 1 of 1 (1-2 of 2 items)

Copyright © 1998, 2020, Oracle and/or its affiliates. All rights reserved.

You can define and merge all the different events or record type under the same case type based on the highest priority event type.

To merge different event types or record type in the same case ID, you must access the Atomic Schema and access the **CS_appln_params** table and change the

ECM_MERGE_EVENT_TYPE parameter value from N to Y. See [Merging Case Types](#) for more information.

NOTE By default, ECM_MERGE_EVENT_TYPE parameter value is N.

Figure 81: Merging Different Event Types in Same Case – Individual (Supervisor)

Select the search type: Individual Entity

Given Names *
MONIER SALEH

Family Names *
SABET

Original Script Name

Date of Birth
mm/dd/yyyy

Source Request ID

Jurisdiction *
Americas

Business Domain *
GEN

City

Passport Number

Address Country

Residency Country

Nationalities

Passport Issuing Country

Country of Birth

External ID Type

External ID

Identification Numbers

Scan

1 Cases created with 2 events

Case ID: C6447

List Key	Record Type	Name Type	Primary Name	Full Name	Original Script Name	Watchlist ID	Match Rule	Match Score	Country	Nationality
DJW	PEP	Spelling Variation	Mounir Thabet	MONIER SALEH SABET		550319	[0100] Exact name only	85	EG	EG
DJW	SAN	Spelling Variation	Mounir Thabet	MONIER SALEH SABET		550319	[0100] Exact name only	85	EG	EG

Page 1 of 1 (1-2 of 2 items)

- c. You can view generated alert ID or Case ID in the results and click **Alert ID** or **Case ID** to view the Alert Details or Case Details page, respectively.

Figure 82: Alert Details

Audit History Rotated Alerts

Alert 1006 Match Score

Alert Summary

Primary Name: STANDARD VACUUM REFINING CO OF INDIA
Alert Type: Real time Enhanced Due Diligence
Assignment: BBS
Screening Type: Online
Jurisdiction: Americas
Decision: **92** Match Score, **45** Risk Score, **1** Investigation, **High**
Created Date: 09/14/2021 07:51:44
Business Domain: General
Comments: Attachments
Due Date Time: 11:94 23h 47m 2s

Events

Pending

List Type	Event Type	Matched Rule Name	DJW	DJW-EOD	[EOD] Part-standardized name exact only	[EOD] Name without suffixes exact only	Watchlist Primary Name	Watchlist ID	Event ID	Match Score	Risk Score
								1010	1010	92	45

Page 1 of 1 (1 of 1 items)

Candidate Details

Jurisdiction: AMEA
Business Domain: a
Entity Name: STANDARD VACUUM REFINING CO OF INDIA

[View Full Comparison](#)

Watchlist Details

[View Full Comparison](#)

Alert Decision

?
You cannot make Alert Decision until all Events are reviewed

8. Click **Clear** to clear the field data and re-enter.

6.2.1 Field Descriptions

- **Given Name:** Enter the first name of the Individual.
- **Entity Name:** Enter the entity name.
- **Family Name:** Enter the family name of the Individual.
- **Jurisdiction:** Select the Jurisdiction to which the Individual or Entity belongs.
- **Business Domain:** Select the business domain to which the Individual or Entity belongs.
- You can also provide details in the following optional fields:
- **Address Country:** Enter the current address of the Individual or Entity.
- **Country of Birth:** Enter the country code in which the individual was born or the Entity originated. This field is applicable only when you select the search type as Individual.
- **Residency Country:** Enter the country code of residence of the Individual or Entity. This field is applicable only when you select the search type as Individual.
- **Operating Countries:** Enter the country codes the Entity operates in. To add more than one country code, add a comma between the countries. For example, the US, IN. This field is applicable only when you select the search type as Entity.
- **Registration Country:** Enter the country code the Entity is registered in. This field is applicable only when you select the search type as Entity.
- **External ID Type:** Select the external ID type of the Individual or Entity.
- **External Type:** Select the external type of Entity.
- **Original Script Name:** Enter the Individual or Entity's name in the original script if the script is a non-Latin script.
- **City:** Enter the city of residence of the Individual or Entity.
- **Nationalities:** Enter the nationality country code of the Individual. This field is applicable only when you select the search type as Individual.
- **External ID:** Enter the external ID unique to the Individual or Entity.
- **Date of Birth:** Enter the Date of birth of the Individual. This field is applicable only when you select the search type as Individual.
- **Passport Number:** Enter the passport number of the Individual.
- **Passport Issuing Country:** Enter the country code in which the passport is issued.
- **Identification Numbers:** Enter the identification numbers of the Individual or Entity.
- **Operating Countries:** Enter the operating country code of the Entity.

6.3 Running the Real-Time Screening Job

To source the data from the Financial Crime Data Model (FCDM) and run the FCDM data preparation process, disable the **MAIN_RT** real-time screening job phase and enable the FCDM job phases in the `customer screening-real time.properties` and `external-entity-screening.properties` run profiles. These files are available in the `<domain_name>/edq/oedq.local.home/runprofiles/` directory in the WinSCP server.

```
phase.Start\ Real-time\ Screening.enabled = Y
```

```
# Control single real-time screening types

phase.Real-time\ Screening.process.Individual\ Real-time\
Screening.san_enabled = Y

phase.Real-time\ Screening.process.Individual\ Real-time\
Screening.pep_enabled = Y

phase.Real-time\ Screening.process.Individual\ Real-time\
Screening.edd_enabled = Y

phase.Real-time\ Screening.process.Entity\ Real-time\ Screening.san_enabled =
Y

phase.Real-time\ Screening.process.Entity\ Real-time\ Screening.pep_enabled =
Y

phase.Real-time\ Screening.process.Entity\ Real-time\ Screening.edd_enabled =
Y
```

6.4 Adding a New Field in a Webservice

Currently, you can only search for the ready-to-use web service fields in the Real-time screening user interface. If you want to add a custom field to an existing web service, for example, full name, you must enter the field name in the applicable web service node and add the field to the applicable process. To do this, follow these steps:

1. In the **Director** landing page, expand the **Customer-Screening** project in the **Project Browser** pane.

Figure 83: Project Browser Pane

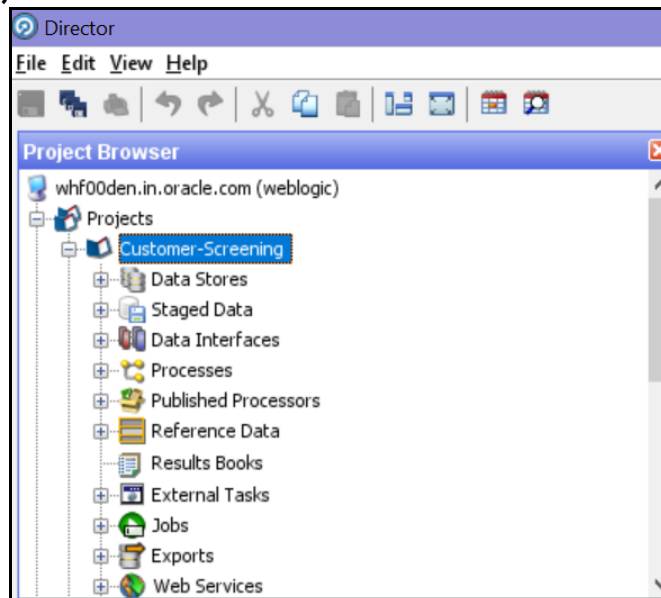

2. Expand the **Web Services** node and double-click the **IndividualScreen** web service.

Figure 84: Web Services Node

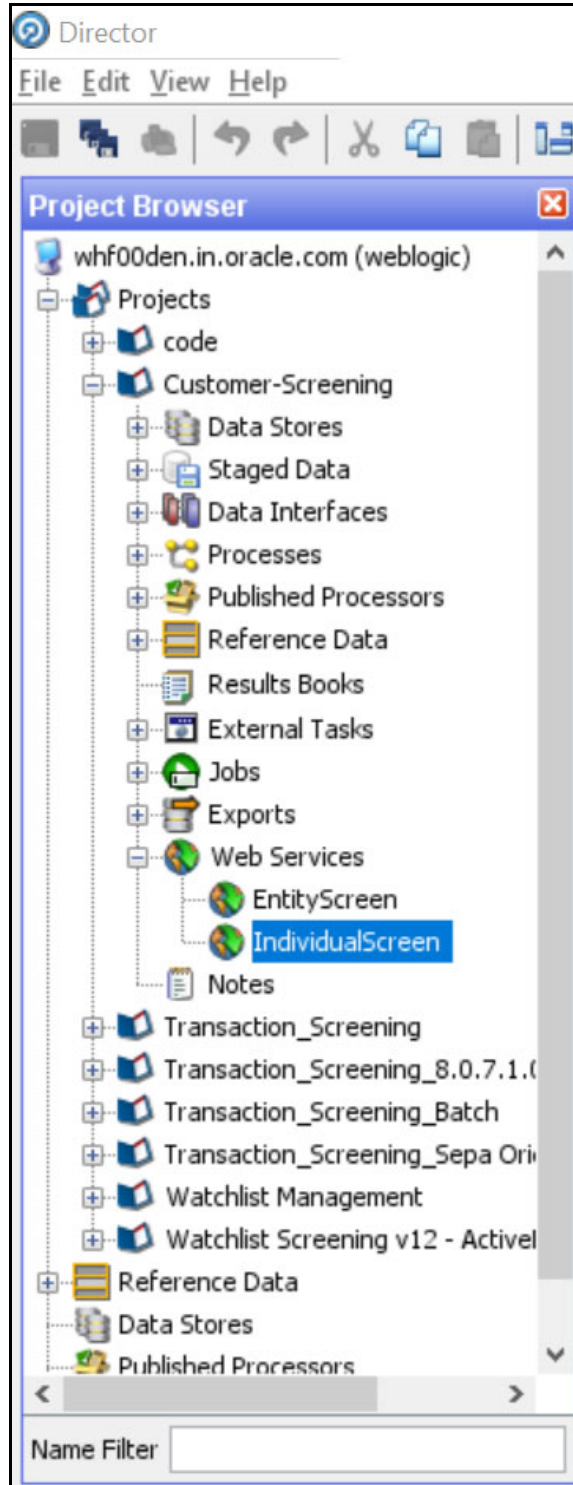

3. Click the **Plus** icon  in the **Web Service Inputs** window. A new row appears in the table.

Figure 85: Edit Web Service Window

Web Service Inputs
What should this web service expect?

Multi Record

Attribute Name	Attribute Type
CustomString40	STRING
CustomDate1	DATE
CustomDate2	DATE
CustomDate3	DATE
CustomDate4	DATE
CustomDate5	DATE
CustomNumber1	NUMBER
CustomNumber2	NUMBER
CustomNumber3	NUMBER
CustomNumber4	NUMBER
CustomNumber5	NUMBER
	STRING

Empty names not allowed

< Back Next > Cancel

4. Enter the name of the column, for example, **FullName**, and click anywhere inside the table to enable the **Next** button.
5. Click **Next** until you view the **Finish** button, and click **Finish**.
6. In the **Customer-Screening** project, expand the **Processes** node and double-click the **Individual Real time Screening** process.

Figure 86: Processes Node

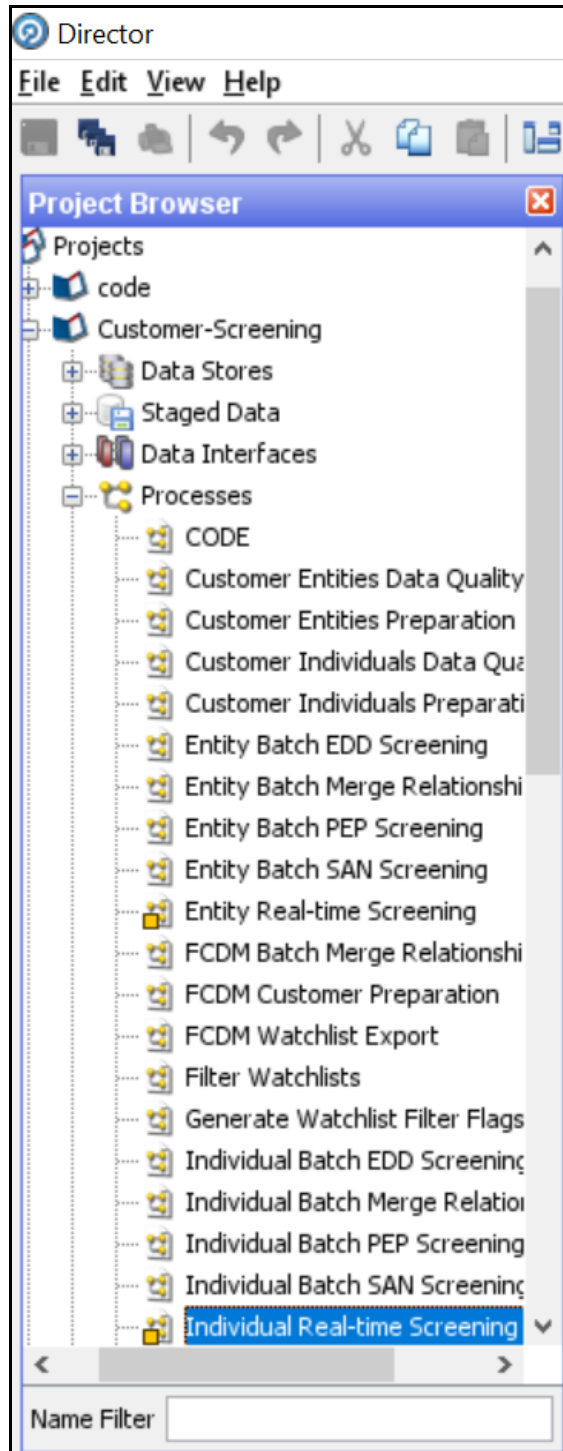

7. Click the **Individual Real-time Data** process icon in the **Individual Real-time Screening** window.
8. Search for **FullName** in the **Reader Configuration** window.

Figure 87: Reader Configuration window

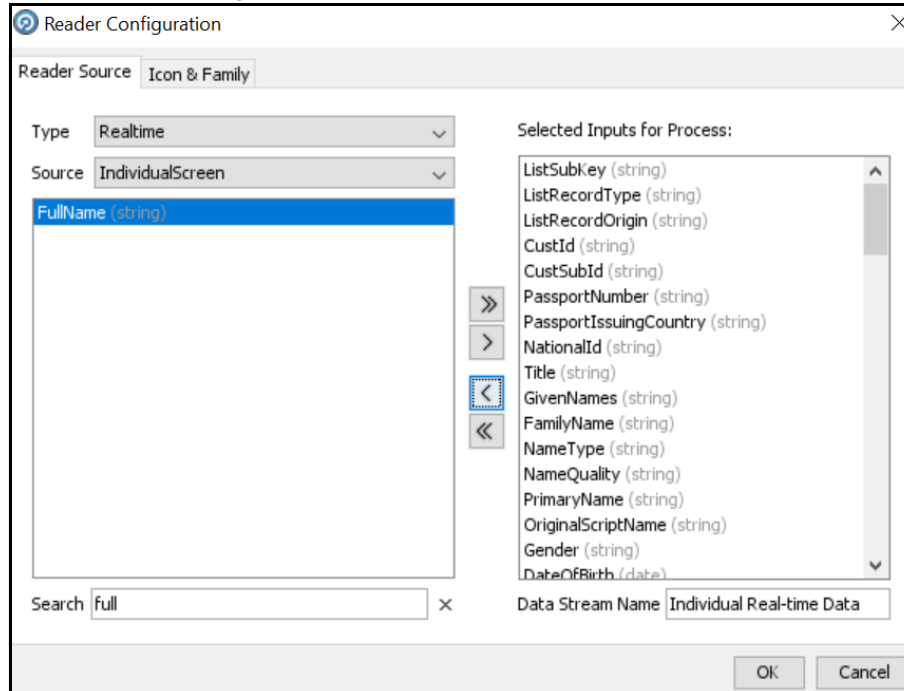

9. Select **FullName** and select the **Remove** icon **>** to move it to **Selected Inputs for Process**.
10. Click **OK**.

After you add the new field, you must integrate it with the Real-time screening user interface to display it in the user interface. To do this, follow these steps:

1. Open the **RTScreening.html** file from the `<Installed Sanctions Path>/js/views` directory. For example, `ECM808SAN.war path }/realTimeScreening/js/views`.
2. Change the external ID placeholders to **FullName**.

```
<oj-label for ="text-input">External ID</oj-label>
<oj-input-text id="externalId" value="{{ExternalId}}"></oj-input-text>
```
3. Copy the code with the new value.
4. Open the **RTScreening.js** file from the `<Installed Sanctions Path>/js/viewModels` directory. For example, `ECM808SAN.war path }/realTimeScreening/js/viewModels`.
5. Update the placeholder within `''` with the copied code with the same syntax as given in the id in the html file in the `self.Clear` function:

```
Document.getElementById("FullName").value = '';
```
6. Update the placeholder within `""` with the copied code with the same syntax as given in the id in the html file in the `self.IndividualScreenObject` array:

```
FullName: ""
```

7 Batch Screening

The following diagram describes the data movement from Customer Screening to Enterprise Case Management (ECM) during the batch screening process.

Figure 88: Batch Screening Workflow

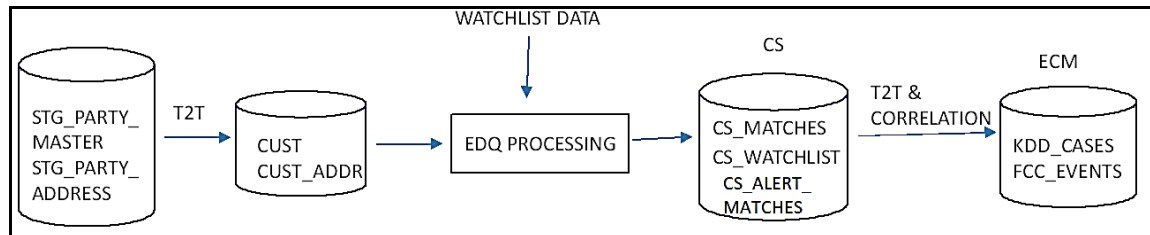
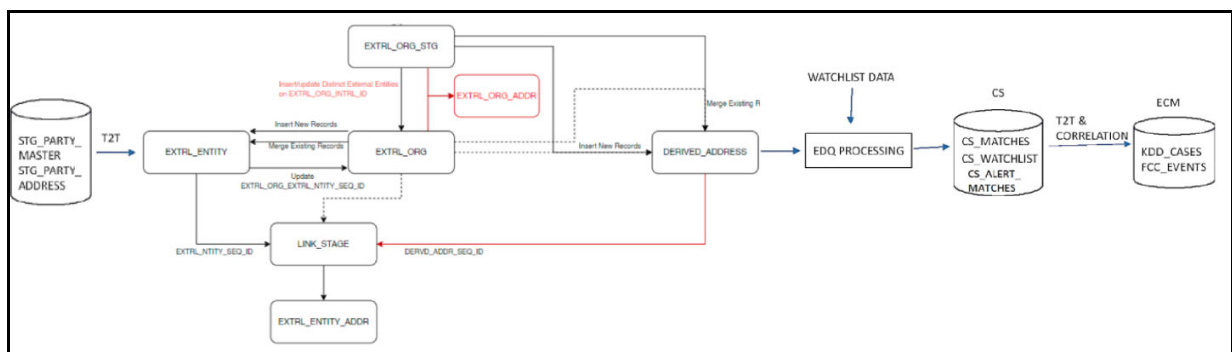

Figure 89: Batch Screening Workflow with EXTRNL_ORG table



The data movement in the workflow is as follows:

1. Data is moved from the STG_PARTY_MASTER, STG_PARTY_ADDRESS, STG_CASA, STG_LOAN_CONTRACTS, STG_PARTY_ACCOUNT_ROLE_MAP, STG_PARTY_ROLE_MAP, STG_TD_CONTRACTS, STG_TRADING_ACCOUNT, and STG_PARTY_OTHER_NAMES tables to the CUST, CUST_ADDR, ACCT, CUST_NAME and other associated customer tables using the Table-to-Table (T2T) mode. See [Figure 88](#) for batch screening workflow.

Data is moved from the STG_PARTY_MASTER, STG_PARTY_ADDRESS, STG_CASA, STG_LOAN_CONTRACTS, STG_PARTY_ACCOUNT_ROLE_MAP, STG_PARTY_ROLE_MAP, STG_TD_CONTRACTS, STG_TRADING_ACCOUNT, and STG_PARTY_OTHER_NAMES tables to the EXTRNL_ENTITY, EXTRNL_ORG, EXTRNL_ORG_STG, EXTRNL_ORG_ADDR, LINK_STAGE, EXTRNL_ENTITY_ADDR, DERIVED_ADDRESS, ACCT, CUST_NAME and other associated customer tables using the Table-to-Table (T2T) mode. See [Figure 89](#) for batch screening workflow with EXTRNL_ORG table.

2. The watch list data is downloaded from the watch list-management project in EDQ. The watch list data is matched with the data in the CUST and CUST_ADDR tables in the Customer-Screening project.
3. The matches are loaded into the CS_MATCHES table and the corresponding watch list data is loaded into the CS_WATCHLIST table.

- Data from the `CS_MATCHES_HIST` table is generated as alerts in the `CS_ALERTS` and `CS_ALERTS_MATCHES` tables.

NOTE

- The `CS_MATCHES_HIST` table contains all the matches made. Each time screening is run, the `CS_MATCHES` table is compared to the `CS_MATCHES_HIST` table and any new or updated matches are added to the `CS_MATCHES_HIST` table. This creates a new alert.
- Every time you run the Customer-Screening project, data is cleared from the `CS_MATCHES` table

- Data is correlated and loaded into the `KDD_CASES` and `FCC_EVENTS` tables in ECM.

7.1 Configuring the EDQ URL

To configure the EDQ URL for batch screening, follow these steps:

- Navigate to the `FCI_DB_HOME/bin` directory.
- Execute the command `/EDQInsert.sh <INFODOM NAME>`. This step is used to register the EDQ server details. You must replace the `INFODOM NAME` placeholder with your domain name.
- Enter the following details in the console where the command is run:
 - EDQ server IP: An example of the EDQ URL is `http://whf00bte.in.oracle.com:7008/edq`. Replace this with your EDQ server's URL.
 - EDQ Server Direct Port number: This is the JMX port number. This value must be 8090.
 - EDQ Server User Name: An example of the EDQ server user name is `weblogic`. Replace this with your EDQ server's user name.
 - EDQ Password: An example of the EDQ password is `weblogic1`. Replace this with your EDQ server's password.

Figure 90: Configure the EDQ URL in Batch Screening

```

/scratch/ofsaweb/ZIPPER/ZIPPER/ECM/DIN>/EDQINSERT.SH INFOZIPER
Started finding Jars
Ended finding Jars
classpath Created
Calling EDQ Main Method
Inside EDQ insert method
Enter EDQ Server IP:
whf00bte.in.oracle.com
Enter EDQ Server Director Port:
8090
Enter EDQ Server User Name:
weblogic
Enter EDQ Password:
Encrypting password
Do you want Enterprise Case Management Application(ECM) or Customer Screening Alert Management(CSAM) as LI investigation for Real Time Screening? (Please enter ECM/CSAM)
)
ECM
Enter Enterprise Case Management Application (ECM) URL:
http://whf00bte:7008/ECHSANS08
Is Enterprise Case Management Application (ECM) in the same installation? (Please enter Y/N)
Y
configurationPath::/scratch/ofsaweb/ZIPPER/ZIPPER
FTC HOME:/scratch/ofsaweb/ZIPPER/ZIPPER/

```

- Configure the EDQ URL in the `CONFIG` schema. To do this, run the following script and replace the placeholders in the `v_method_name` and `v_param_1` columns with the EDQ URL, EDQ user name, and EDQ password respectively:

```

select t.*,t.rowid from aai_wf_application_api_b t where
t.v_process_id='CSRT' and t.v_app_api_id in
('1521535704140','1521535760435')

```

7.2 Staging Database Connection Details

To run the customer screening jobs using the Financial Crime Data Model (FCDM) as a source of customer and external entity data, you must add the connection details of the staging database into which FCDM will place the data to be screened in EDQ.

To set the connection details for customer and external entity data, follow these steps:

1. Go to the EDQ URL and open the **Director** menu.

Figure 91: Director Menu in EDQ

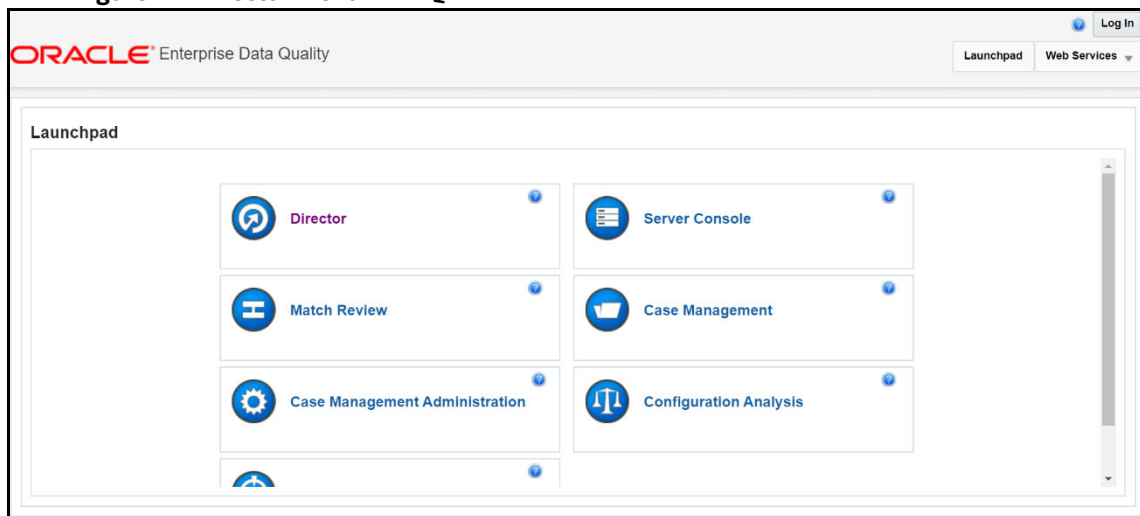

2. In the **Director** landing page, expand the **Customer-Screening** project in the **Project Browser** pane.

Figure 92: Project Browser Pane

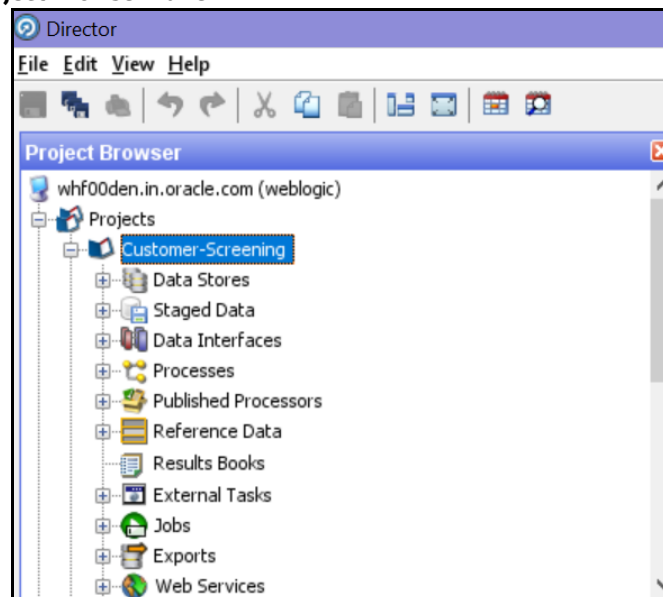

3. Expand the **Data Stores** node and open **FCDM Batch Data**. The **Edit Data Store** window appears.

Figure 93: Data Stores Node

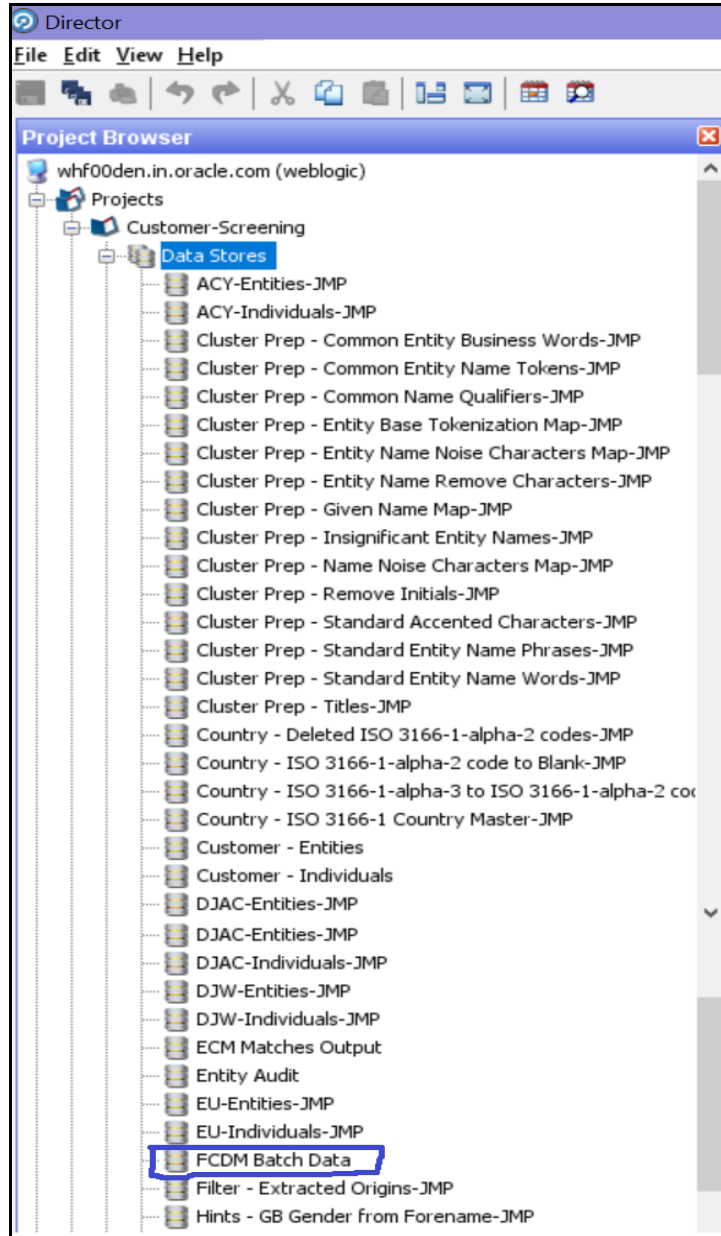

4. In the **Edit Data Store** window, enter the database host, database name, user name, and password.

Figure 94: Edit Data Store for Staging Database Connection

Edit Data Store

Oracle Configuration

Database host: Local Host

Port: 1521

Database name: Database Name

Name type: SID

User name: User Name

Password:

Schema:

The schema need not be entered if it is the default for the user

Test...

OK Cancel

NOTE

1. OEDQ release 12c has a base config folder and a local config folder. The base config folder is called `oedqhome` and the local config folder is called `oedqlocalhome`. The names may differ in some cases. For example, dots or underscores may be inserted in the names, such as `oedq_local_home`.
2. It is not necessary to enter the schema name if the user name mentioned is the schema owner.
3. The parameters can be passed as externalized values in the `runopsjob` command.

7.3 Enabling Customer and External Entity Tables

The FCDM Integration section of the `customer-screening.properties` and `external.entity.properties` run profile contains the following parameters. These files are available in the `<domain_name>/edq/oedq.local.home/runprofiles/` directory in the WinSCP server.

- `phase.Batch\ Screening\ FCDM.enabled`
- `phase.Snapshot\ External\ Entity\ Data.enabled`

To enable screening of the customer table, set `phase.Batch\ Screening\ FCDM.enabled` to **Y** and `phase.Snapshot\ External\ Entity\ Data.enabled` to **N**.

To enable screening of the external entity table, set `phase.Batch\ Screening\ FCDM.enabled` to **N** and `phase.Snapshot\ External\ Entity\ Data.enabled` to **Y**.

7.4 Data Preparation in FCDM

Before you prepare data for individuals and entities, there is an FCDM-specific data preparation process which needs to be performed. This process performs the following transformations:

- Splits records into individuals and entities based on Customer Type Code
- Creates additional rows of data for aliases
- Creates name attributes compatible with CDI
- Derives gender and year of birth for individuals

NOTE The FCDM Data Preparation job is built on expected population of data in FCDM. This must be validated for each specific implementation and the process adapted if required.

7.4.1 Establishing a JDBC Database Connection using WebLogic

To set up a database connection using the WebLogic server, follow these steps:

1. In the WebLogic server, provide the name of the JNDI directory in the **JNDI Name** field in the **General** subtab of the **Configurations** tab.

Figure 95: JNDI Name

The screenshot displays the 'Settings for SANCECH8071FNO' configuration page in the WebLogic Administration Console. The 'General' subtab is selected, and the 'JNDI Name' field is highlighted with a blue selection box, containing the value 'jdbc/SANCECH8071FNO'. Other fields include Name (SANCECH8071FNO), Datasource Type (GENERIC), and Scope (Global). The page also shows a 'Row Prefetch Enabled' checkbox and 'Stream Chunk Size' set to 256.

2. In the **Connection Pool** subtab, provide the connection details of the JDBC URL. Enter the JDBC URL in the **URL** field and the class name of the JDBC driver in the **Driver Class Name** field.

Figure 96: JDBC URL and Driver

The screenshot shows the 'Settings for SANCCEM07JFNO' configuration page. The 'Connection Pool' tab is active. The 'URL' field contains 'jdbc:oracle:thin:@whf00bik.in.oracle.com:1521:DBWHFI'. The 'Driver Class Name' field contains 'oracle.jdbc.OracleDriver'. The 'Properties' field is empty. The 'System Properties' field is empty. The 'Encrypted Properties' field is empty. The 'Password' field is masked with asterisks. The 'Confirm Password' field is also masked. The 'Initial Capacity' field contains the value '1'.

3. Go to the EDQ URL and open the **Director** menu. The **Director** landing page appears.

Figure 97: Director Menu in EDQ

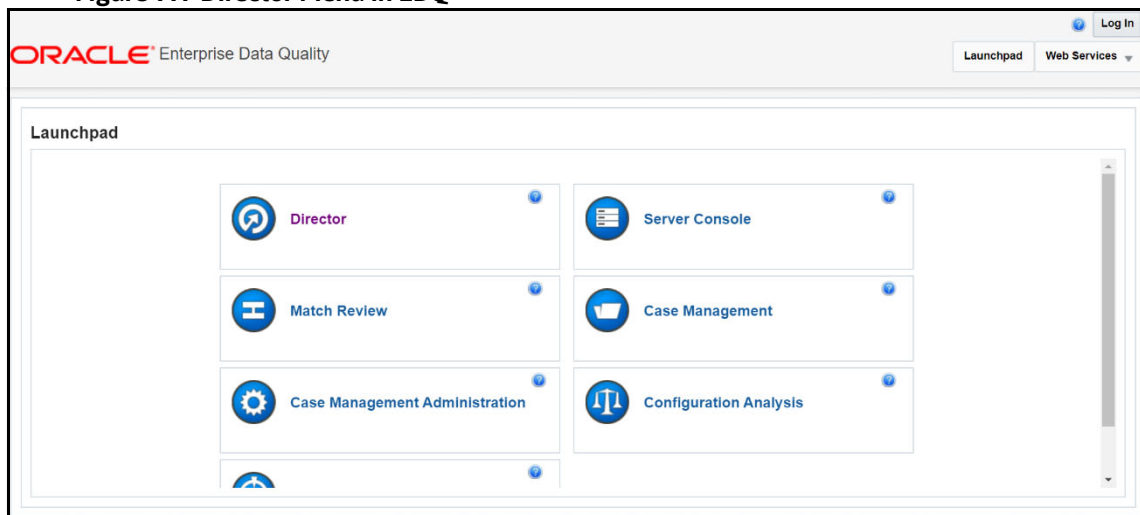

4. In the **Director** landing page, expand the **Customer-Screening** project in the **Project Browser** pane.

Figure 98: Project Browser Pane

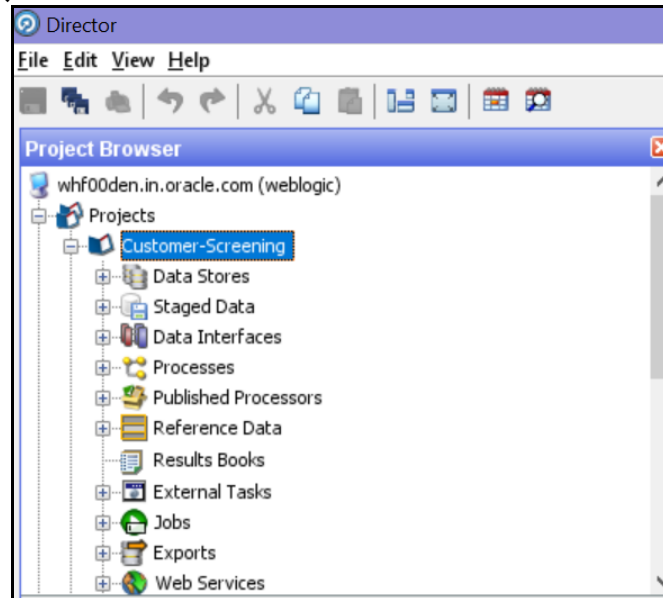

5. In the **Project Browser** pane, right-click **Data Stores** under the Customer-Screening project and then select **New Data Store**.

Figure 99: New Data Store

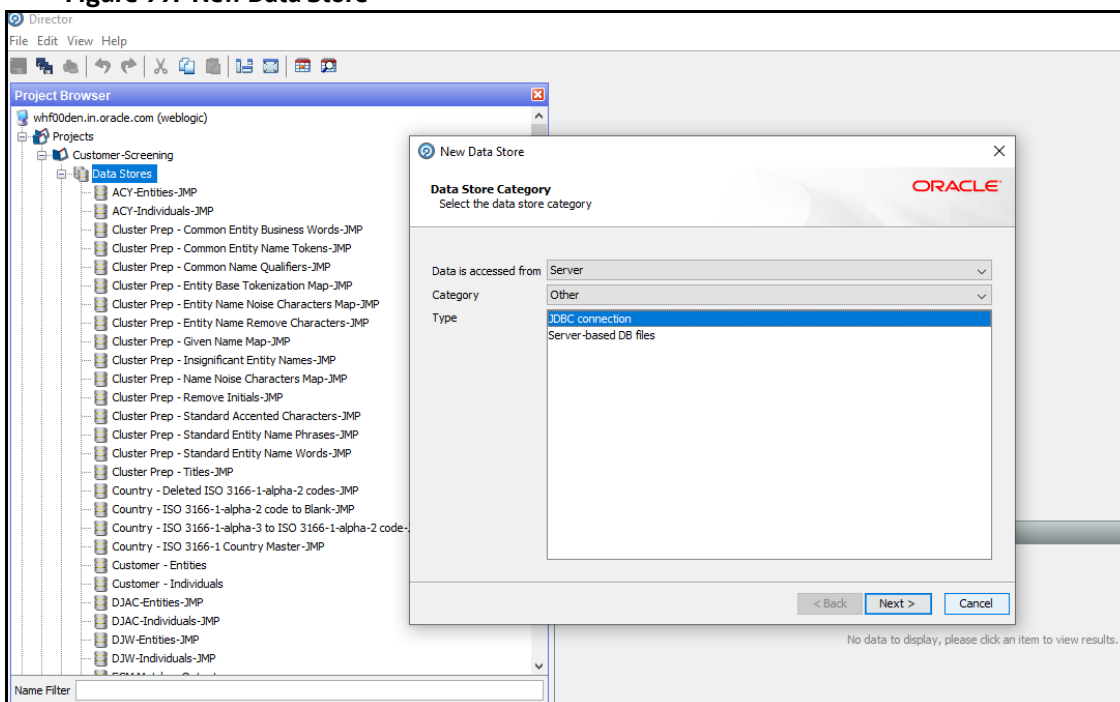

6. In the **New Data Store** window, select the type as **JDBC Connection** and click **Next**.

Figure 100: Edit Data Store

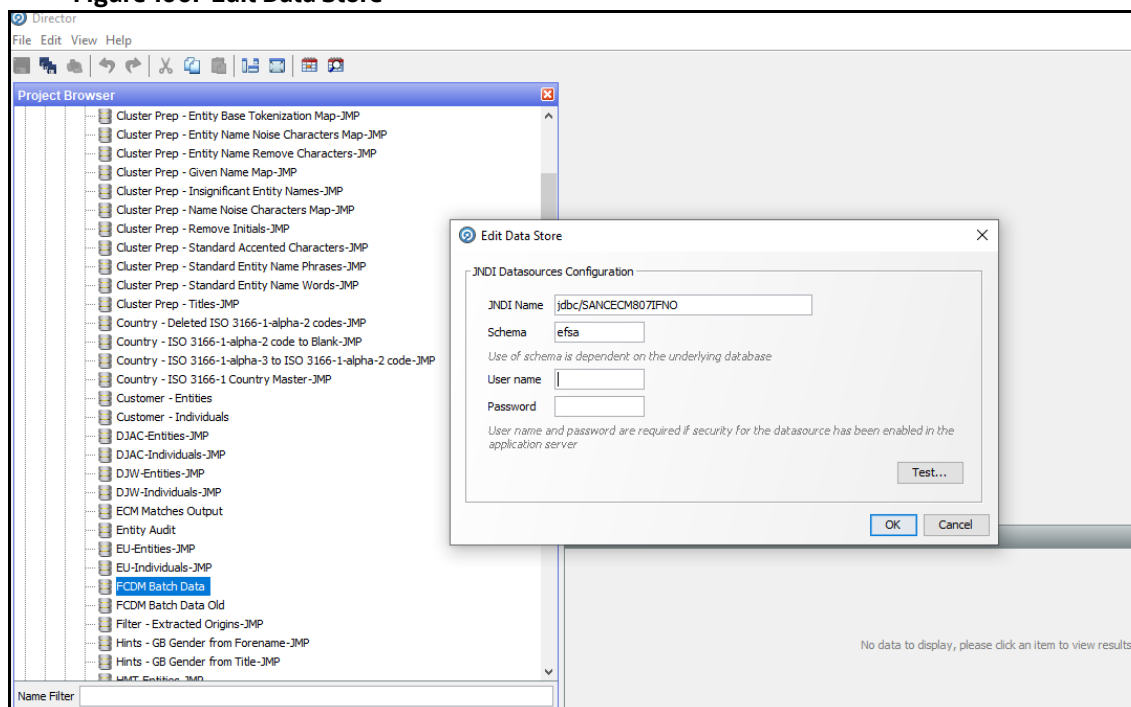

7. In the **Edit Data Store** window, enter the JDBC connection details.
8. Click **OK**.

You have now created a JDBC database connection.

7.5 Analyzing the Data Quality of Customer Data and External Entity

Customer Screening is integrated with a Data Quality (DQ) check process which checks the quality of data in FCDM for screening. This process is run independently of the screening process and identifies potential issues with the customer and external entity data quality that can affect the screening efficiency. Run the `Analyze FCDM Customer Data Quality` job to analyze the data quality. This job checks data for any quality issues that can affect the screening efficiency.

To analyze the customer data, follow these steps:

1. Ensure that data is loaded into FCDM and the **Customer-Screening** project has the correct database parameters.
2. Go to the EDQ URL and open the **Director** menu.

Figure 101: Director Menu in EDQ

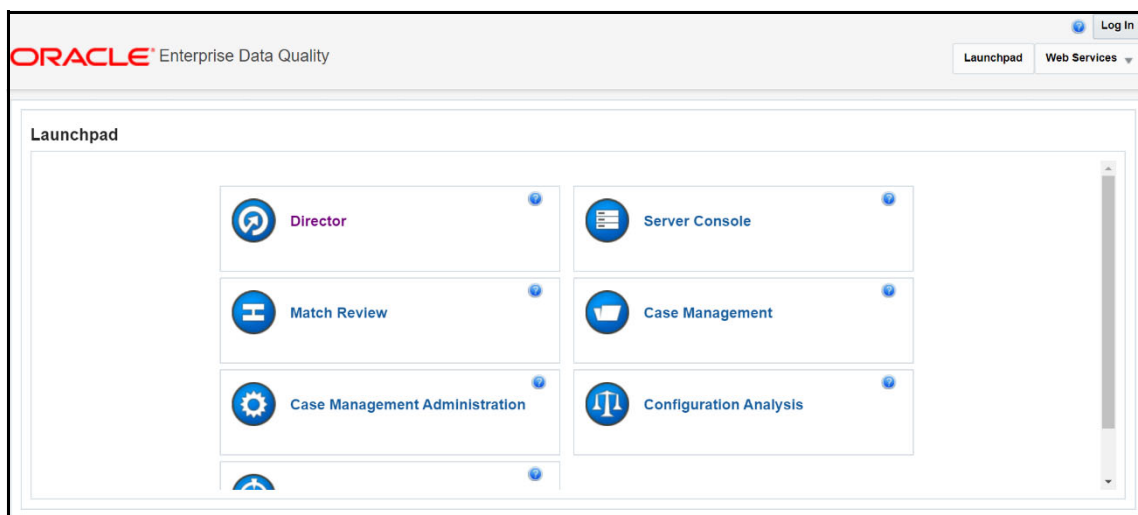

3. In the **Director** landing page, expand the **Customer-Screening** project in the **Project Browser** pane.

Figure 102: Project Browser Pane

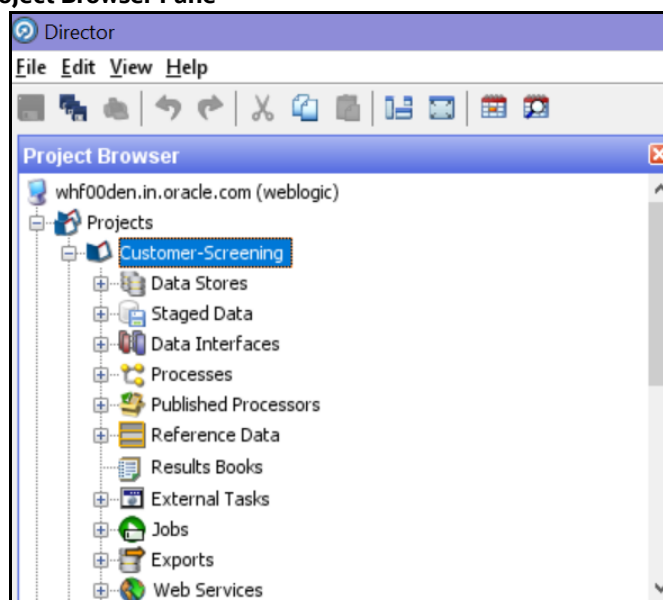

4. Expand the **Jobs** node.
5. Right-click the Analyze FCDM Customer Data Quality job and click **Run**.

Figure 103: Jobs Node

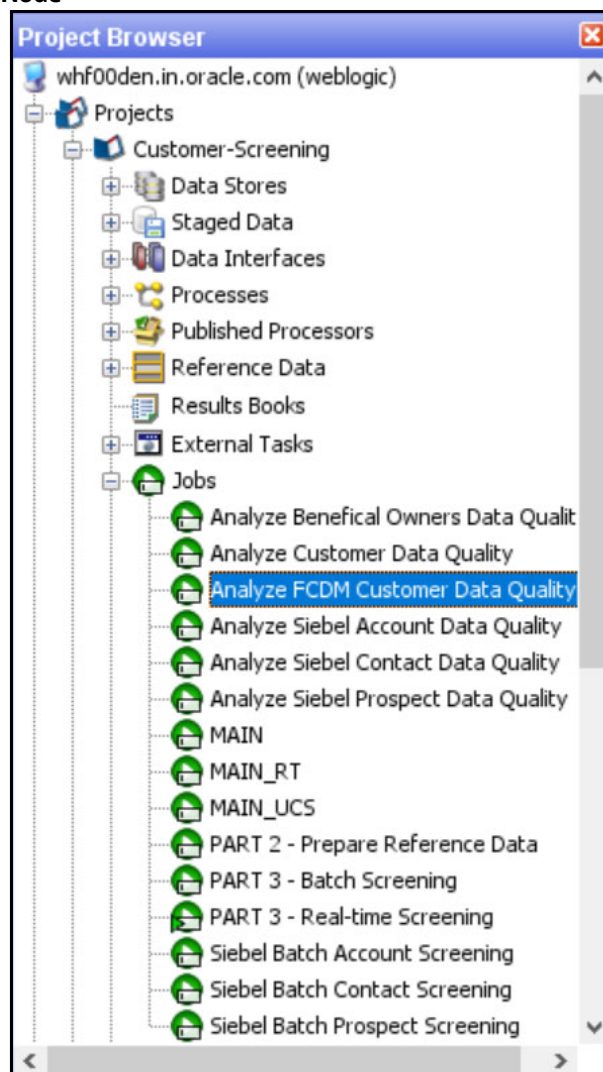

To analyze the external entity data, follow these steps:

1. Ensure that data is loaded into FCDM and the **Watch list Management** project has the correct database parameters.
2. Go to the EDQ URL and open the **Director** menu.

Figure 104: Director Menu in EDQ

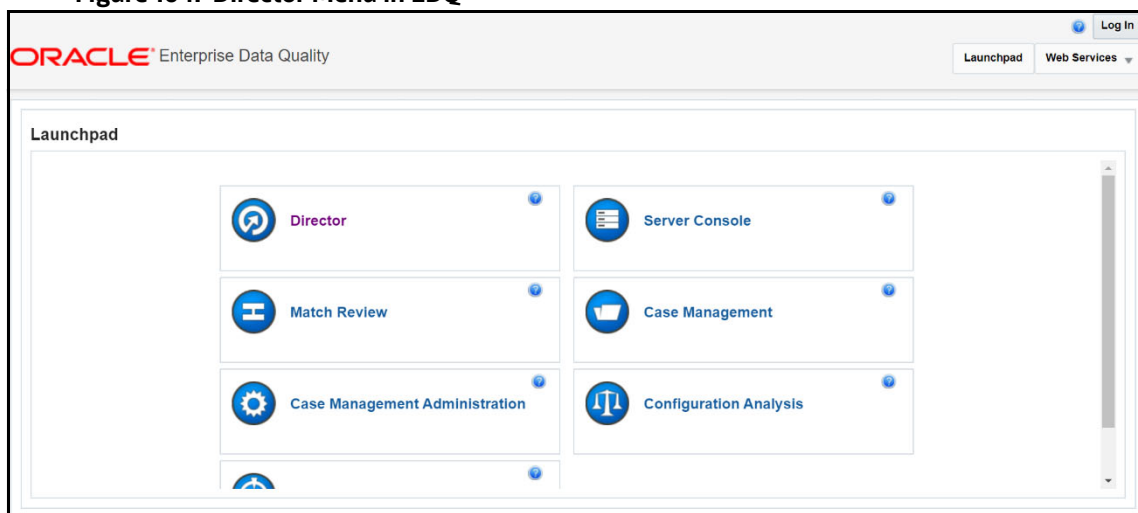

3. In the **Director** landing page, expand the **Watch list Management** project in the **Project Browser** pane.

Figure 105: Project Browser Pane

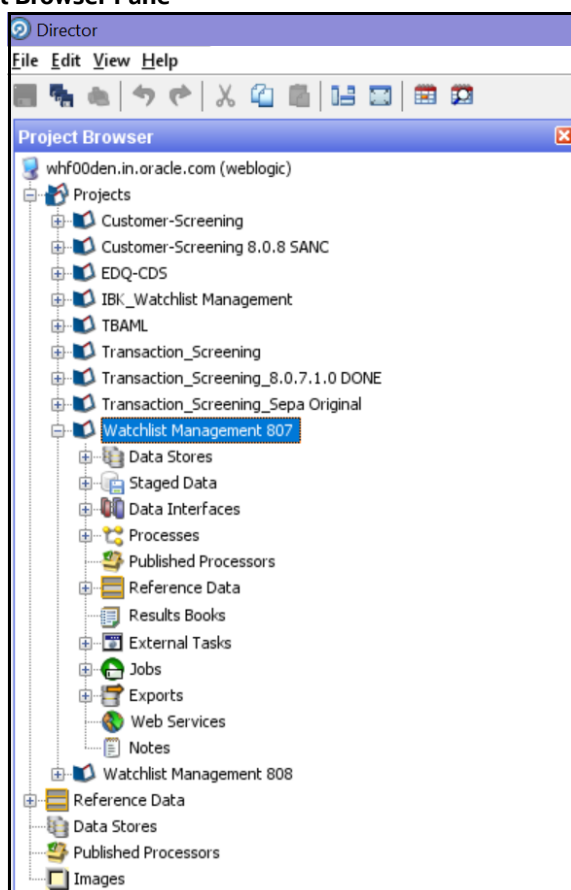

4. Expand the **Jobs** node.
5. Right-click the Analyze FCDM Customer Data Quality job and click **Run**.

Figure 106: Jobs Node

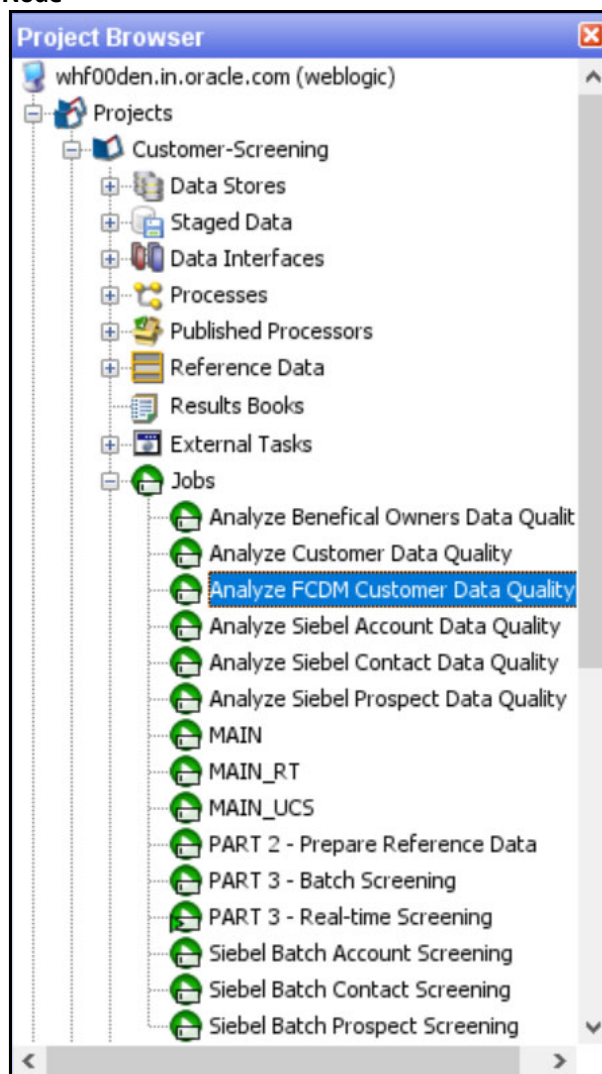

7.5.1 Data Quality Errors

For each Data Quality (DQ) error, a severity code is assigned, and it corresponds to the likely impact the issue will have on screening efficiency. The error codes and the associated messages that are displayed are based on the data analysis are shown in [Table 4](#).

Table 4: Severity Codes Assigned to Data Quality Errors

Severity Code	Data Quality Error
1	Severe data error which prevents screening.
2	Invalid data which will limit the effectiveness of screening.
3	Missing data which will limit the effectiveness of screening.
4	Invalid data which does not affect screening. Errors in this category will not affect the output of the match processor but can cause issues when manually evaluating any potential matches that are raised.

The data quality check analyses each row of data. If the analysis of any row results in a severity code of 1, it is rejected by the screening process. This is because there is a lack of data in the core attributes used by the screening process, and so screening cannot be performed.

The screening processes load data that cannot be screened into the `CUST_Individuals_Invalid` staged data or the `CUST_Entities_Invalid` staged data tables for the individual and external entity records, respectively. The error codes associated with each row are also stored in the database.

7.6 Extract Transform Load (ETL) Database Connection Details

After screening is run, relationships (matches) and watch list records are exported to the Customer Screening database, and this data is sent to ECM based on the connections configured in the data store.

To set the ETL database connection details, follow these steps

1. Go to the EDQ URL and open the **Director** menu.

Figure 107: Director Menu in EDQ

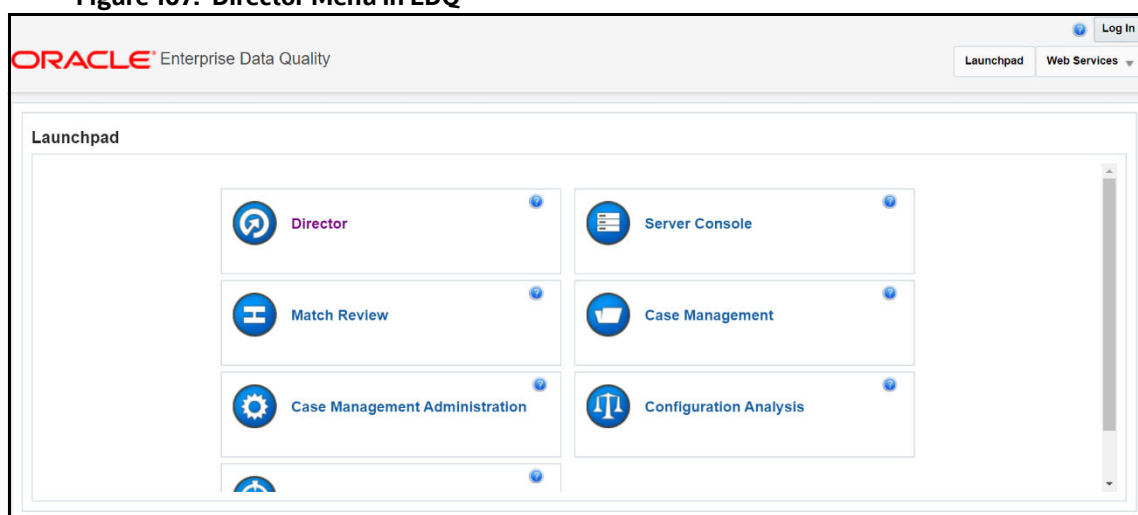

2. In the **Director** landing page, expand the **Customer-Screening** project in the **Project Browser** pane.

Figure 108: Project Browser Pane

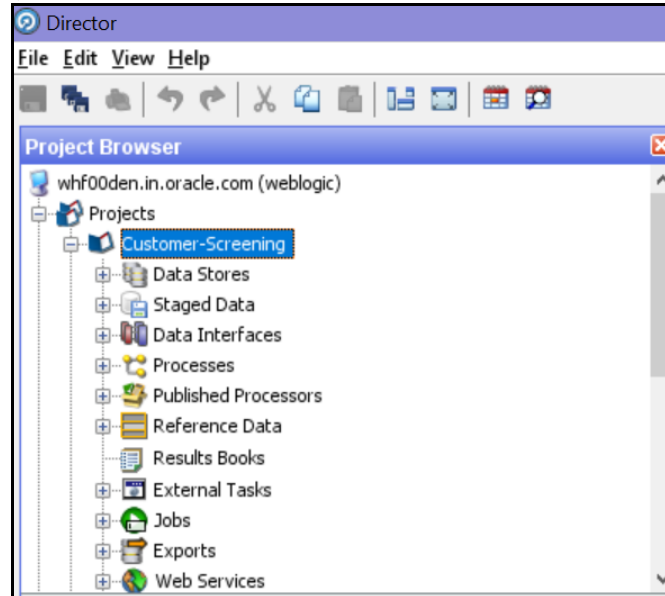

3. Expand the **Data Stores** node and open **FCDM Batch Data**. The **Edit Data Store** window appears.

Figure 109: Data Stores Node

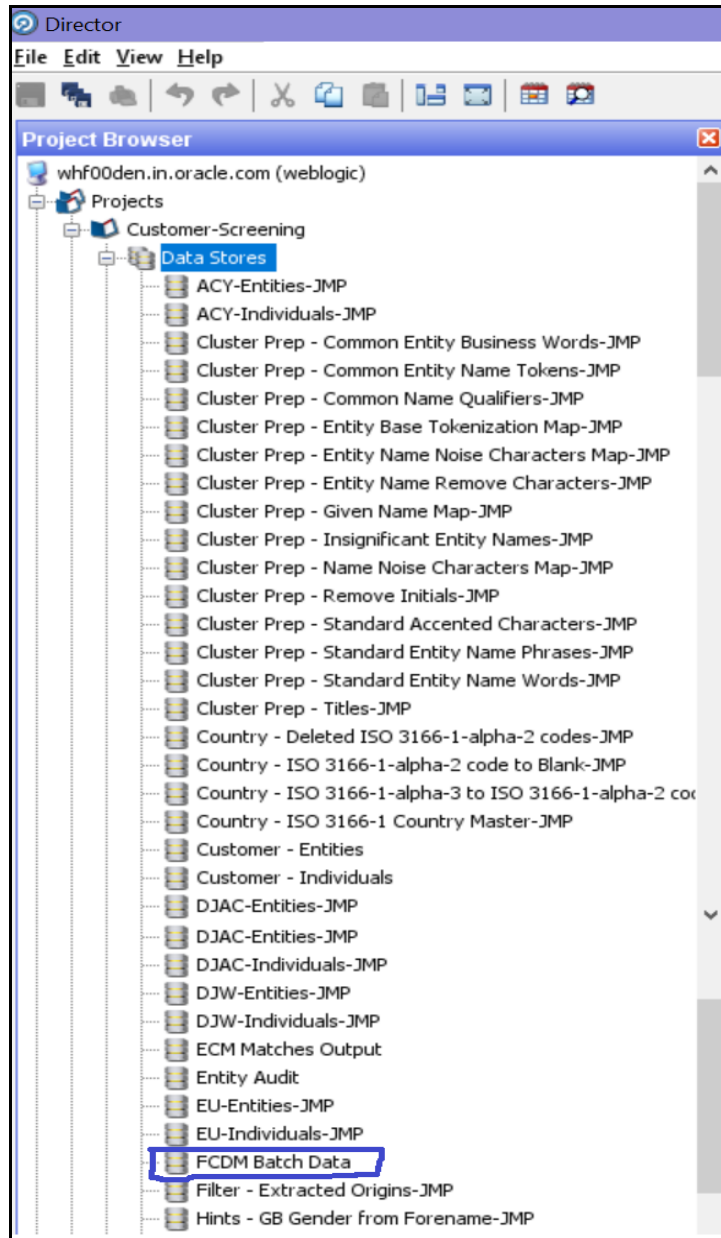

4. In the **Edit Data Store** window, enter the database host, database name, user name, and password.

Figure 110: Edit Data Store for Staging Database Connection

Oracle Configuration

Database host: Local Host

Port: 1521

Database name: Database Name

Name type: SID

User name: User Name

Password:

Schema:

The schema need not be entered if it is the default for the user

Test...

OK Cancel

NOTE

1. OEDQ release 12c has a base config folder and a local config folder. The base config folder is called `oedqhome` and the local config folder is called `oedqlocalhome`. The names may differ in some cases. For example, dots or underscores may be inserted in the names, such as `oedq_local_home`.
2. It is not necessary to enter the schema name if the user name mentioned is the schema owner.
3. The parameters can be passed as externalized values in the `runopsjob` command.

7.7 Running the Batch Screening Job

To source the data from the Financial Crime Data Model (FCDM) and run the FCDM data preparation process, disable the **MAIN** batch screening job phase and enable the FCDM version in the `customer_screening.properties` and `external-entity-screening.properties` run profiles:

```
# Globally turns on/off batch screening types
phase.Batch\ Screening.enabled = N
phase.Batch\ Screening\ FCDM.enabled = Y
```

To export the data to the Customer Screening database these job phases must also be enabled:

```
phase.ECM\ Export\ Matches.enabled = Y
phase.ECM\ Export\ Watch list.enabled = Y
```

7.8 Generating Alerts

This job will move the alerts data displayed in the L1 Investigation for Alert Management from different origins in the source database to the consolidated database.

The Customer and Watchlist data will be screened in Enterprise Data Quality (EDQ) server. If any Customer data is matched with Watchlist Data, then the events are created. Based on the Customer, the alerts are generated.

If any customer data is changed in source data, only that data is moved in the consolidated database. Based upon the date, you run the batch.

The following workflow explains the data movement from the source database to the consolidated database.

Figure 111: Generating Alerts Workflow

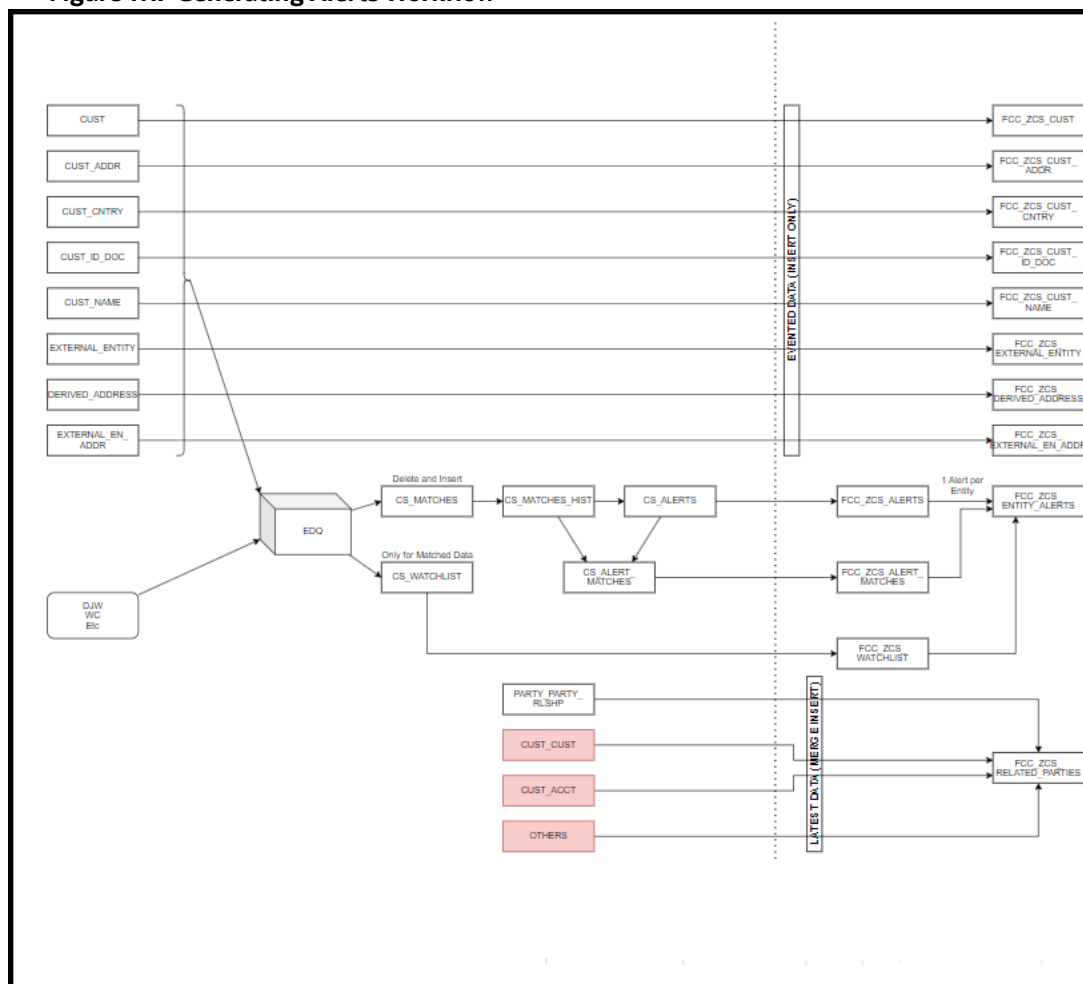

To run the batch to move data from the source database to the consolidated database, follow these steps:

1. Log In to the Customer Screening application.
2. Click **Common Tasks** the list of common tasks displayed. Then click **Rule Run Framework**, and then click **Run**. The **Run** page is displayed.

Figure 112: Run Page

Run

Code Version 0

Name Active Yes

Folder Type

+ New View Edit Copy Remove Authorize Export Fire Run

<input type="checkbox"/>	Code	Name	Type	Folder	Version	Active
<input type="checkbox"/>	CSBusinessDataLoad	Customer Screening Business Data Load	Base Run	TFLSEGMENT	0	Yes
<input type="checkbox"/>	CS_Data_Load_Event_Generation	CS Data Load And Event Generation	Base Run	TFLSEGMENT	0	Yes
<input type="checkbox"/>	CS_EDQ_Watchlist_Analyze	Customer Screening EDQ Watchlist Analyze	Base Run	TFLSEGMENT	0	Yes
<input type="checkbox"/>	CS_EDQ_Watchlist_Management	Call Watchlist Management	Base Run	TFLSEGMENT	0	Yes
<input type="checkbox"/>	Oracle_CS_Zipper_Processing	Oracle_CS_Zipper_Processing	Base Run	TFLSEGMENT	0	Yes
<input type="checkbox"/>	QueueArchival	QueueArchival	Base Run	TFLSEGMENT	0	Yes

Page 1 of 1 (1-15 of 6 items) Records Per Page 6

- In the **Run** page, select the `Oracle_CS_Zipper_Processing` checkbox and click **Fire Run** .

Figure 113: Run Page

OK Close

Run Definition

Name Oracle_CS_Zipper_Processing

Request Type Single

Execution Mode

Batch Create

Wait No

Others

Parameters " "

Filters

- In the Run Definition section, select **Request Type** from the drop-down list.
- In the **Execution Mode** section, select the Batch value as **Create** to create the batch or select **Create & Execute** to create the batch and execute it.
 - If you select Execution Mode as Create & Execute, then select **MIS Date**.
- Select the Wait as **No** if you want to create or create & execute the batch without any delay or select **Yes** and enter the duration value in seconds.

7. In the **Others** section, enter the **Parameters** and **Filters** if required.

7.9 Suppression of Alerts

This reconfigurability allows you to suppress the duplication of RT and Batch CS cases.

For any RT Screening, a new Real-time case is created. A new case is created for Batch Screening only if the customer matches with Watchlist information based on the rule configuration.

The subsequent batch runs will not create a new CS case against the customer until and unless any hash key attribute is changed on the customer or watchlist side.

To configure the Alert Suppression follow the these steps:

1. Access the Atomic Schema and access the CS_appln_params table. Change the parameter value from N to Y for ALERT_SUPPRESSION parameter name.

NOTE By default, the ALERT_SUPPRESSION parameter value is N.

2. The request ID for the respective customer name from the real-time screening must be copied for a match or scan.
3. Enter the copied request ID in the V_ORIG_PARTY_ID field in the STG_PARTY_MASTER table.

NOTE The suppression of alerts is only applicable for CS batch alerts and not applicable for RT case.

7.10 Configuring Additional Columns on the Alert List page

This configurability allows you to add additional column(s) on the Alert Search and List page and view additional information.

It also provides configurability to execute the customized query to fetch the data in the columns against each Alert ID and shows the new columns in the Columns drop-down list while saving the view.

To add a column on the Search and List page and filters, follow these steps:

1. Add an entry in this table "FCC_SANC_LIST_PAGE_CONFIG" to configure a new value in the column drop-down section for FCC_ZCS_ENTITY_ALERTS.

See [fcc_sanc_list_page_config.xlsx](#) file with sample entries for Case ID and Watchlist primary name.

NOTE Add an entry only for the DEFAULT view.
"TABLE_NAME" column must have 'FCC_ZCS_ENTITY_ALERTS' value
"COLUMN_NAME" column must have actual column name value in the parent table like V_CASE_ID, WATCHLIST_PRIMARY_NAME, and so on.

2. Add an entry in this table "FCC_SAN_LIST_CONFIG" to configure a new value in the filter search section for CS_LIST_FILTER.

See [fcc_san_list_config.xlsx](#) file with sample entries for Case ID and Watchlist primary name.

3. Add an entry in this table "FCC_SAN_LIST_CONFIG_TL" to configure a new value in the filter search section.

See [fcc_san_list_config_tl.xlsx](#) file with sample entries for Case ID and Watchlist primary name.

NOTE N_CONFIG_ID column value in this table must match with N_CONFIG_ID value in "fcc_san_list_config" table.

4. Update "v_query" column in this table "FCC_SANC_LIST_PAGE_QUERY_CONF" where "V_QUERY_IDENTIFIER" column value is 'CS_ALERT_LIST_GRID', with the new column details in select query to get the data for new column.
5. (Optional step) If you are trying to configure the column from the existing listed tables in the query. If not, follow the below step,

Update "v_query" column in this table "FCC_SANC_LIST_PAGE_QUERY_CONF" where "V_QUERY_IDENTIFIER " column value is 'CS_ALERT_LIST_COUNT' with the new column details in select query to get the updated count value.

8 Appendix A: Screening Non-Latin Character Sets

The reference data sources supported by Customer Screening are all provided in the Latin character set, and some in the original scripts. The screening process can also be used with non-Latin data. Non-Latin data can be screened against the Latin reference data sources which are supported by performing transliteration of data from the non-Latin character set to the Latin character set.

Non-Latin customer data can be screened against non-Latin reference data without any changes to the product, although certain fuzzy text matching algorithms may not be as effective when used to match data with the non-Latin character set. Text is processed on a left-to-right basis.

NOTE You may have to install additional language packs to display non-Latin data. For more information, contact [My Oracle Support \(MOS\)](#).

The following screenshot shows the transliteration of Cyrillic to the Latin character set:

Figure 114: Non-Latin Character Set

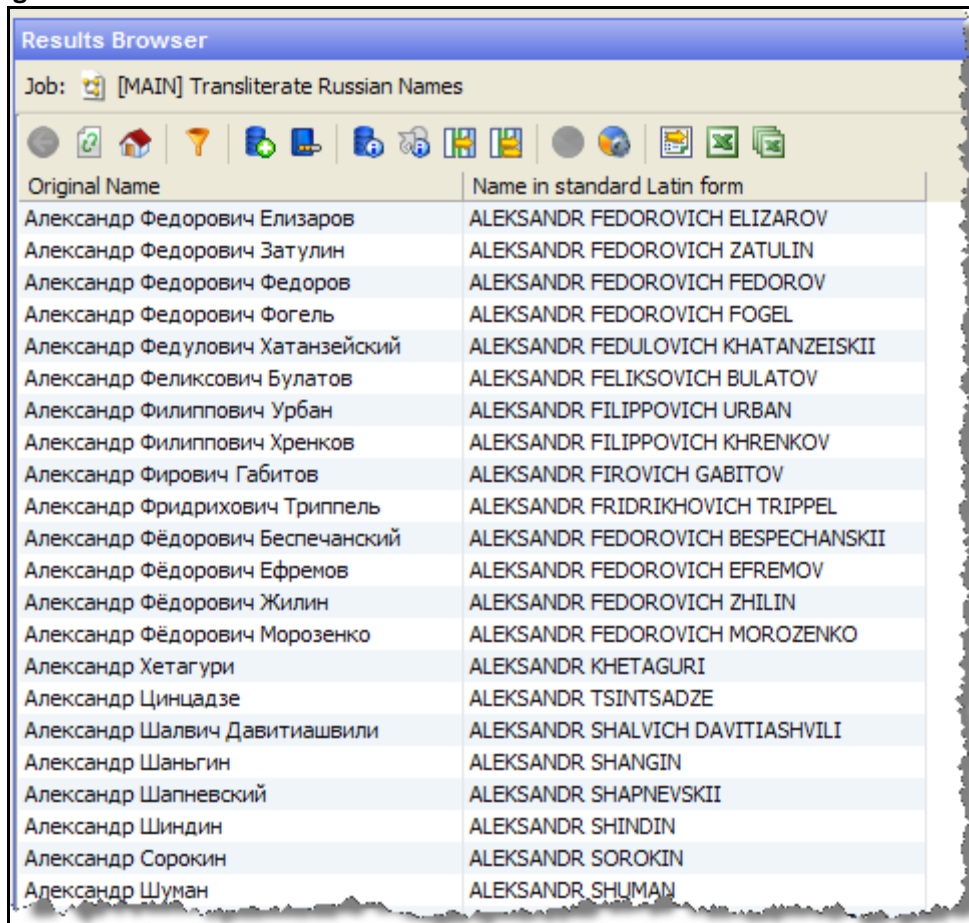

The screenshot shows a window titled "Results Browser" with a job name "[MAIN] Transliterate Russian Names". The window contains a table with two columns: "Original Name" and "Name in standard Latin form". The table lists 20 rows of Russian names and their corresponding Latin transliterations.

Original Name	Name in standard Latin form
Александр Федорович Елизаров	ALEKSANDR FEDOROVICH ELIZAROV
Александр Федорович Затулин	ALEKSANDR FEDOROVICH ZATULIN
Александр Федорович Федоров	ALEKSANDR FEDOROVICH FEDOROV
Александр Федорович Фогель	ALEKSANDR FEDOROVICH FOGEL
Александр Федулович Хатанзейский	ALEKSANDR FEDULOVICH KHATANZEISKII
Александр Феликсович Булатов	ALEKSANDR FELIKSOVICH BULATOV
Александр Филиппович Урбан	ALEKSANDR FILIPPOVICH URBAN
Александр Филиппович Хренков	ALEKSANDR FILIPPOVICH KHRENKOV
Александр Фирович Габитов	ALEKSANDR FIROVICH GABITOV
Александр Фридрихович Трипель	ALEKSANDR FRIDRIKHOVICH TRIPPEL
Александр Фёдорович Беспечанский	ALEKSANDR FEDOROVICH BESPECHANSKII
Александр Фёдорович Ефремов	ALEKSANDR FEDOROVICH EFREMOV
Александр Фёдорович Жилин	ALEKSANDR FEDOROVICH ZHILIN
Александр Фёдорович Морозенко	ALEKSANDR FEDOROVICH MOROZENKO
Александр Хетагури	ALEKSANDR KHETAGURI
Александр Цинцадзе	ALEKSANDR TSINTSADZE
Александр Шалвич Давитиашвили	ALEKSANDR SHALVICH DAVITIASHVILI
Александр Шаньгин	ALEKSANDR SHANGIN
Александр Шапневский	ALEKSANDR SHAPNEVSKII
Александр Шиндин	ALEKSANDR SHINDIN
Александр Сорокин	ALEKSANDR SOROKIN
Александр Шуман	ALEKSANDR SHUMAN

8.1 Original Script Matching

To match the original script data against reference data, follow these steps:

1. Prepare customer and external entity data such that non-Latin names are populated in the Original Script Name fields.

2. Enable Original Script Name match rules and clusters.

For more information, see the [Oracle Financial Services Customer Data Interfaces Guides](#).

NOTE

You must make changes to the FCDM Customer Preparation process to support original script matching. For more information, contact [My Oracle Support \(MOS\)](#).

9 Appendix B: Reference Data Tables for Watch Lists

This appendix lists the reference data tables which are available in Customer Screening. These tables contain data that is used to calculate the risk scores and PEP risk scores. The reference data tables are stored in the `Watch list Management` project.

The following table has information on the different reference data tables which contain risk score values used by each watch list.

Table 5: Reference Data Tables for Watch Lists

Screening Process or Watch List	Reference Data Table Used
Multiple screening processes	The following reference data table contains risk score values used by multiple screening processes: <ul style="list-style-type: none"> Risk - ISO 3166-1 Country to Risk Score (used by the lookup Risk - ISO 3166-1-alpha-2 code to Risk Score) is used to derive a risk score from a country code
Country prohibition screening process	The following reference data tables contain risk score values used in the country prohibition screening process: <ul style="list-style-type: none"> Country Prohibitions - Entities Country Prohibitions - Individuals
Dow Jones watch list (DJW)	The following reference data tables contain risk score values used when calculating risk scores for the Dow Jones watch list records: <ul style="list-style-type: none"> DJW Occupation Category DJW List Provider Risk Scores DJW SI Category Description DJW SI Category
Dow Jones Anti-Corruption (DJAC) watch list	The following reference data tables contain risk score values used when calculating risk scores for the Dow Jones watch list records: <ul style="list-style-type: none"> DJAC Occupation Category DJAC List Provider Risk Scores DJAC SI Category Description
EU watch list	There are no reference data tables containing risk score values used only for calculating risk scores for the EU watch list records.
HM Treasury watch list	The <code>HMT Regime</code> reference data table contains risk score values used when calculating risk scores for the HM Treasury watch list records.
OFAC watch list	The <code>OFAC SDN Program</code> reference data table contains risk score values used when calculating risk scores for the OFAC watch list records.
UN watch list	The <code>UN List Type</code> reference data table contains risk score values used when calculating risk scores for the UN watch list records.

Table 5: Reference Data Tables for Watch Lists

Screening Process or Watch List	Reference Data Table Used
World-Check (WC) watch list	<p>The following reference data tables contain risk score values used when calculating risk scores for the World-Check watch list records:</p> <ul style="list-style-type: none"> • WC Category • WC Keyword (used by the lookup WC Keyword - Risk Score Lookup)
Accuity watch list	<p>The following reference data tables contain risk score values used when calculating risk scores for the Accuity watch list records:</p> <ul style="list-style-type: none"> • Accuity Program Sub-Category Risk Scores • Accuity Source Risk Scores
NA	<p>The Risk - Risk Element Weighting reference data table contains the weightings used when calculating a record risk score from the various contributing elements.</p>

10 Appendix C: Preconfigured Watch List Information

This appendix contains details of each of the pre-configured watch lists that can be used by Customer Screening.

10.1 HM Treasury Watch List

The HM Treasury publishes a sanctions list that can be used for screening in Customer Screening. The sanctions list provides a consolidated list of targets listed by the United Nations, European Union, and the United Kingdom under legislation relating to current financial sanctions regimes. For more information, visit the [HM Treasury](#) website.

Customer Screening uses the watch list in a semi-colon delimited form. Click the following link to download the .csv file.

<https://ofsistorage.blob.core.windows.net/publishlive/ConList.csv>

10.2 OFAC Watch List

The US Treasury's Office of Foreign Assets Control (OFAC) administers and enforces economic and trade sanctions based on US foreign policy and national security goals against targeted foreign countries, terrorists, international narcotics traffickers, and those engaged in activities related to the proliferation of weapons of mass destruction. For more information, visit the [Treasury](#) website.

Customer Screening supports the OFAC Specially Designated Nationals and OFAC Consolidated Sanctions watch lists.

The OFAC Specially Designated Nationals (SDN) watch list must be downloaded in three parts:

<https://www.treasury.gov/ofac/downloads/sdn.csv>

<https://www.treasury.gov/ofac/downloads/add.csv>

<https://www.treasury.gov/ofac/downloads/alt.csv>

The OFAC Consolidated Sanctions List watch list must be downloaded in three parts:

https://www.treasury.gov/ofac/downloads/consolidated/cons_prim.csv

https://www.treasury.gov/ofac/downloads/consolidated/cons_add.csv

https://www.treasury.gov/ofac/downloads/consolidated/cons_alt.csv

10.3 EU Watch List

The European Union applies sanctions or restrictive measures to achieve certain objectives as mentioned in the Common Foreign and Security Policy (CFSP) and defined in Article 11 of the Treaty on the European Union. The European Commission offers a consolidated list containing the names and identification details of all persons, groups, and entities targeted by these financial restrictions. For more information, visit the [European Commission](#) website.

To download the consolidated list, follow these steps:

1. Go to <https://webgate.ec.europa.eu/europeaid/fsd/fsf#!/account> and create a user name and password to the site.
2. Navigate to <https://webgate.ec.europa.eu/europeaid/fsd/fsf#!/files> and open the settings for the crawler file.

3. Copy the URL for 1.0 XML (Based on XSD). This will be in the format `https://webgate.ec.europa.eu/europeaid/fsd/fsf/public/files/xmlFullSanctionsList/content?token=[username]`. You must replace the `[username]` placeholder with the user name you have created.
4. Enter this URL in your run profile or download task.

10.4 UN Consolidated Watch List

The United Nations (UN) or United Nations Security Council consolidated list is a watch list that includes all individuals and entities who are subject to sanctions measures imposed by the Security Council. For more information, visit the [UN Security Council](#) website.

Download the consolidated list from <https://www.un.org/sc/suborg/sites/www.un.org.sc.suborg/files/consolidated.xml>.

10.5 World-Check Watch List

The World-Check watch list provides a subscription-based service and offers a consolidated list of Politically Exposed Persons (PEPs) and entities and individuals appearing on the HM Treasury, OFAC, and other world lists. Three levels of subscription are provided: Standard, Premium, and Premium+. Some features of the World-Check lists are only available to users with a higher subscription level. For more information, visit the [World-Check](#) website.

To download the World-Check Premium+ feed subscription service, set the following values in the WC Setup section of the `watch_list-management.properties` run profile:

```
phase.WC\ -\ Download.enabled = Y
phase.WC\ -\ Download\ native\ aliases.enabled = Y
phase.WC\ -\ Stage\ reference\ lists.enabled = Y
phase.*.process.*.use_accelus_url = Y
```

To download the Standard or Premium feed subscription services, set the following values in the WC Setup section of the `watch_list-management.properties` run profile:

```
phase.WC\ -\ Download.enabled = Y
phase.WC\ -\ Download\ native\ aliases.enabled = N
phase.WC\ -\ Stage\ reference\ lists.enabled = Y
phase.*.process.*.use_accelus_url = Y
```

When the parameters are set to **Y**, the watch list data is downloaded from the following URL:

<https://app.accelus.com/#accelus/fsp/%7B%22location%22%3A%22%3Flocale%3Den-US%23fsp%2Fquickid%2F>

When the parameters are set to **N**, the watch list data is downloaded from the following URL:

<https://www.world-check.com/frontend/profile/>

NOTE

If your instance of Oracle Financial Services Customer Screening uses the WebLogic application server and you use the World-Check watch list to screen individuals and entities, then you must add the `-DUseSunHttpHandler=true` script to the Server Start arguments of your EDQ server to download the World-Check watch list data.

10.6 Dow Jones Watch List

The Dow Jones watch list provides a subscription-based service and offers a consolidated list of PEPs (Politically Exposed Persons) and entities and individuals appearing on the various sanctions lists. For more information, visit the [Dow Jones](#) website.

You can automate the download of the Dow Jones watch list using the following script files that are provided with Customer Screening to configure the download process:

```
download-djw.sh (for use on Unix platforms)
```

```
download-djw.bat (for use on Windows platforms)
```

The script files are used by the automated task to download the data files and copy them to the Oracle Enterprise Data Quality (OEDQ) landing area. The script files must be modified to provide the download URL and the proxy server details for your Internet connection as follows:

1. Go to the EDQ URL and open the **Director** menu.

Figure 115: Director Menu in EDQ

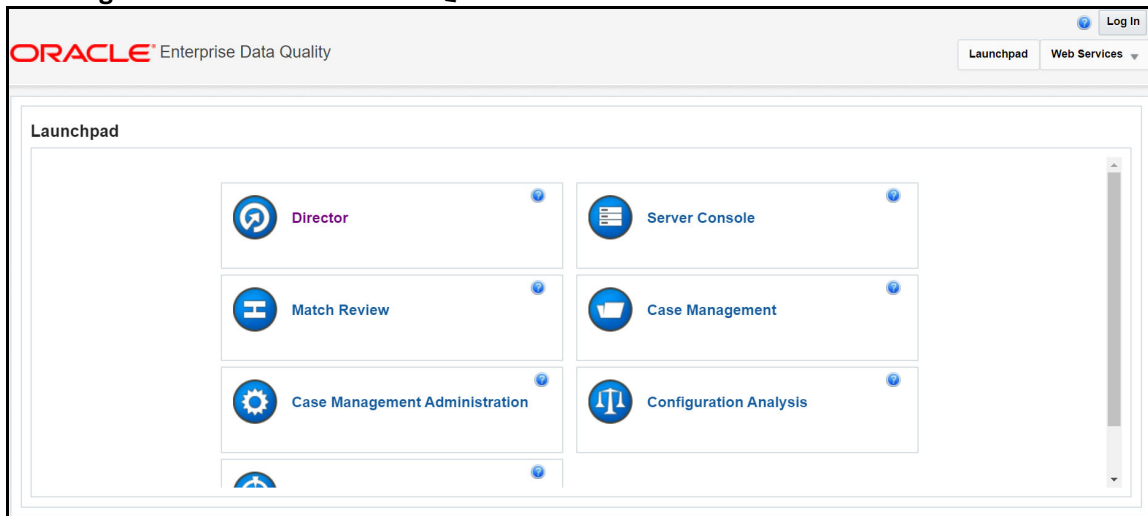

2. In the **Director** landing page, expand the **Watch list Management** project in the **Project Browser** pane.

Figure 116: Project Browser Pane

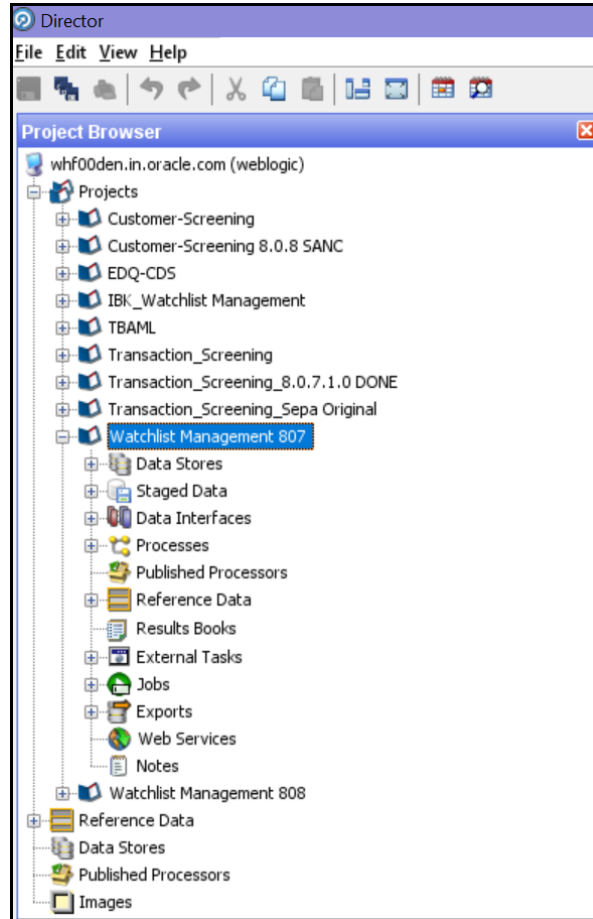

3. Expand the **External Tasks** node for the `Watch list Management` project and then double-click on the **Download Dow Jones Watch list** task.

Figure 117: External Tasks Node

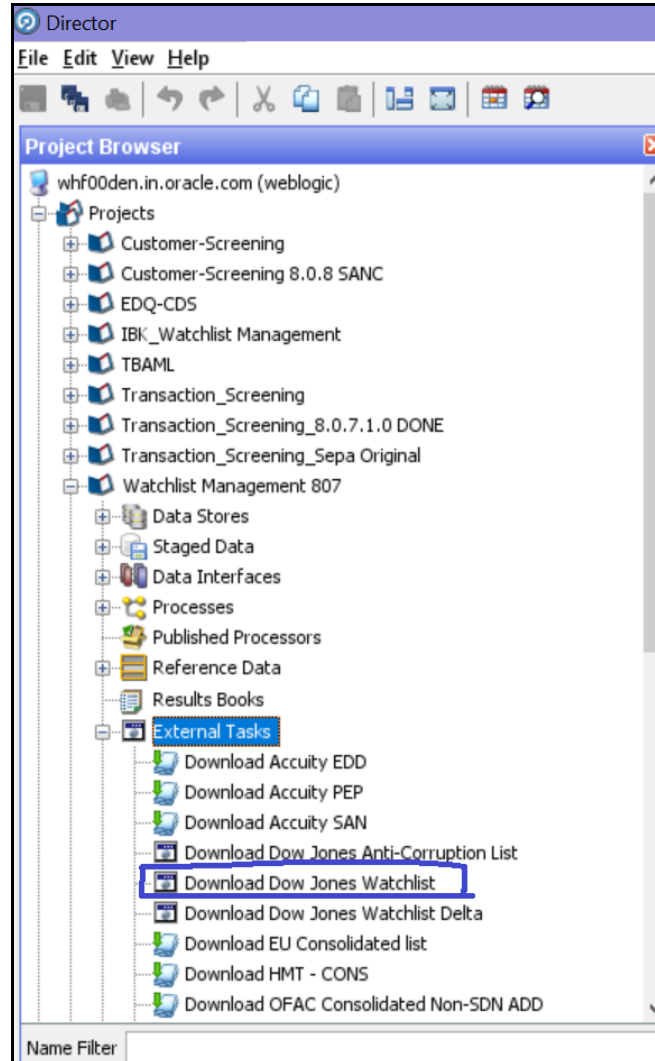

4. Configure the external task to call the batch or shell file by providing the directory and related command as shown:

Figure 118: Edit Task Window for the Dow Jones Watch List

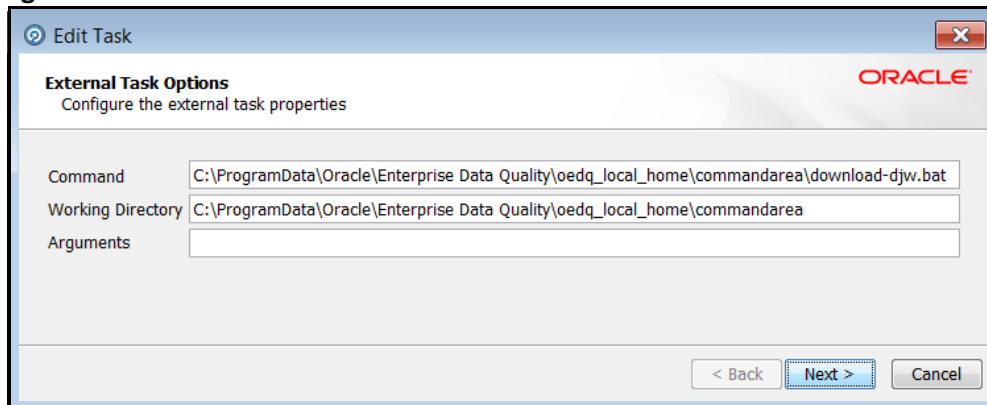

5. Configure your `PATH` system variable to include the path to your Java installation.
6. Add the user name and password and the proxy server configuration details for Dow Jones in the batch or script file.

10.7 Dow Jones Anti-Corruption Watch List

The Dow Jones Anti-Corruption watch list provides a subscription-based service that contains information to help you assess, investigate, and monitor third-party risk with regards to the anti-corruption compliance regulation. For more information, visit the [Dow Jones](#) website.

You can automate the download of the Dow Jones watch list using the following script files that are provided with Customer Screening to configure the download process:

`download-djac.sh` (for use on Unix platforms)

`download-djac.bat` (for use on Windows platforms)

The script files are used by the automated task to download the data files and copy them to the Oracle Enterprise Data Quality (OEDQ) landing area. The script files must be modified to provide the download URL and the proxy server details for your Internet connection as follows:

1. Go to the EDQ URL and open the **Director** menu.

Figure 119: Director Menu in EDQ

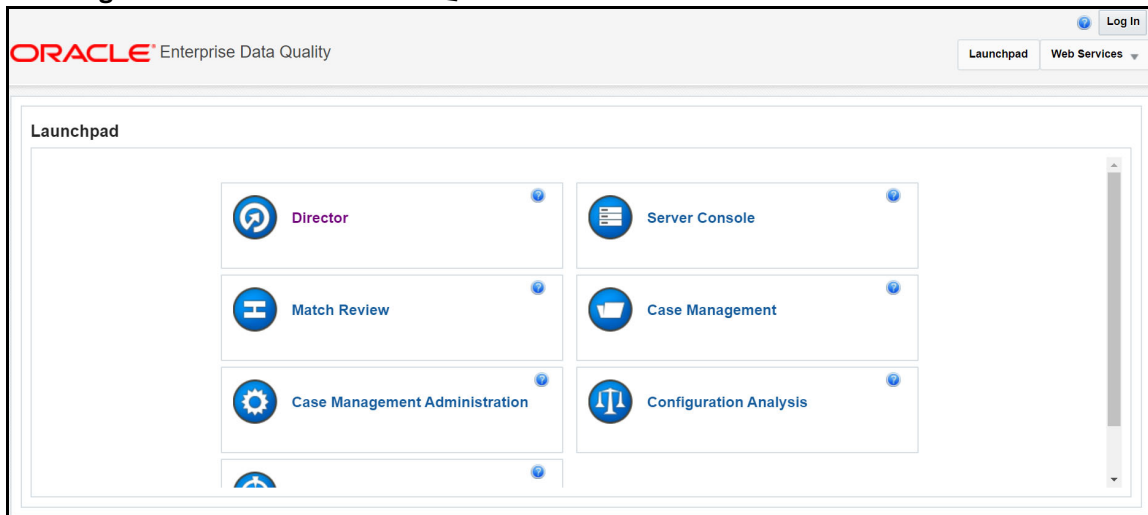

2. In the **Director** landing page, expand the **Watch list Management** project in the **Project Browser** pane.

Figure 120: Project Browser Pane

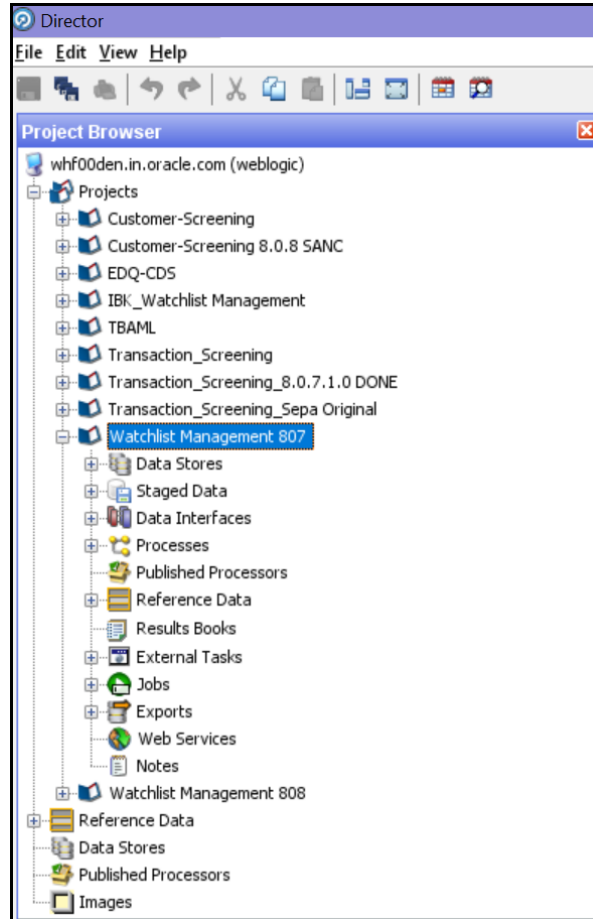

3. Expand the **External Tasks** node for the `Watch list Management` project and then double-click on the **Download Dow Jones Anti-Corruption List** task.

Figure 121: External Tasks Node

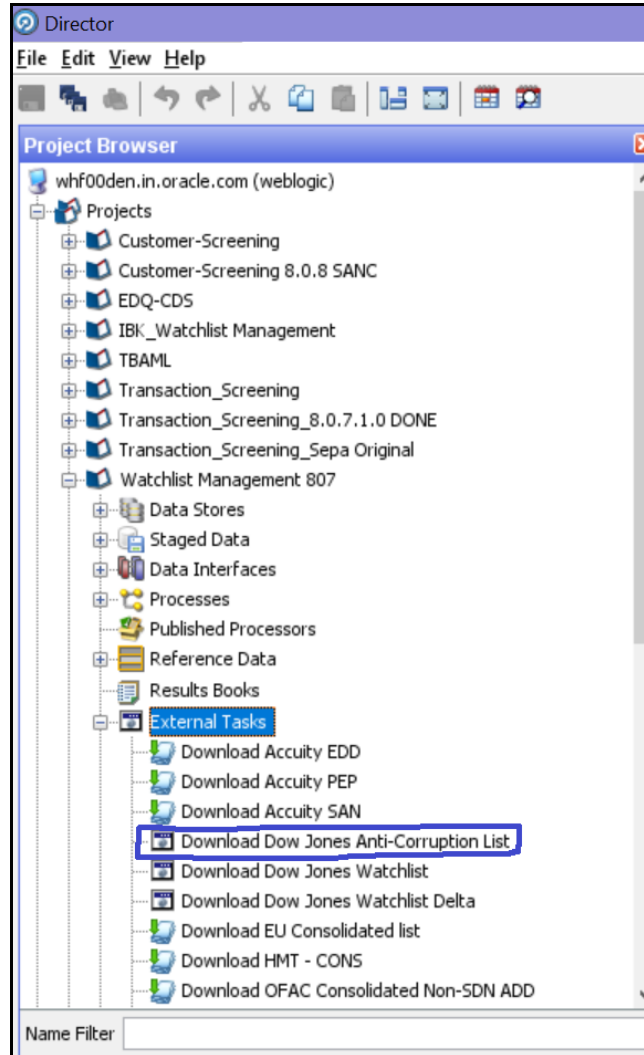

4. Configure the external task to call the batch or shell file by providing the directory and related command as shown:

Figure 122: Edit Task Window for the Dow Jones Anti-Corruption Watch List

5. Configure your `PATH` system variable to include the path to your Java installation.
6. Add the user name and password and the proxy server configuration details for Dow Jones Anti-Corruption in the batch or script file.

10.8 Accuity Watch List

The Accuity global watch list is a subscription-based service. The Accuity watch list's proprietary collection of watch list screening databases is an aggregation of specially designated individuals and entities compiled from dozens of regulatory and enhanced due diligence lists from around the world. This watch list provides the ideal framework for your customer screening and interdiction filtering processes. For more information, visit the [Accuity website](#).

Accuity provides aggregated data in the following watch lists:

- The Regulatory Due Diligence (RDD) watch list, which covers sanctioned entities and individuals. You can use the Accuity Group File with this list. For more information, see [Using the Accuity Group File](#).
- The Enhanced Due Diligence (EDD) watch list, which covers entities and individuals who are not part of the regulatory sanctions lists, but whose activity must be monitored.
- The Politically Exposed Persons (PEPs) Due Diligence Database watch list, which covers PEP individuals.

10.8.1 Using the Accuity Group File

The Accuity global Watch list is created by aggregating multiple watch lists. As such, any given individual or entity can be represented in the watch list by multiple entries using the `GROUP.XML` file.

In the `GROUP.XML` file, all records which represent the same individual or entity are collected into groups, and each group is assigned a unique group ID. The group ID has a unique identifier to differentiate it from the original record identifier in Enterprise Case Management (ECM). Records that are not included in the group use their original Accuity record ID with a different identifier to indicate that they are single records.

NOTE Only entities and individuals on the Regulatory Due Diligence (RDD) watch lists are included in the group file.

The group file allows you to generate cases on individuals who are grouped together, instead of generating cases on separate individuals. To use the group file for individuals, follow these steps:

1. Go to the EDQ URL and open the **Director** menu.

Figure 123: Director Menu in EDQ

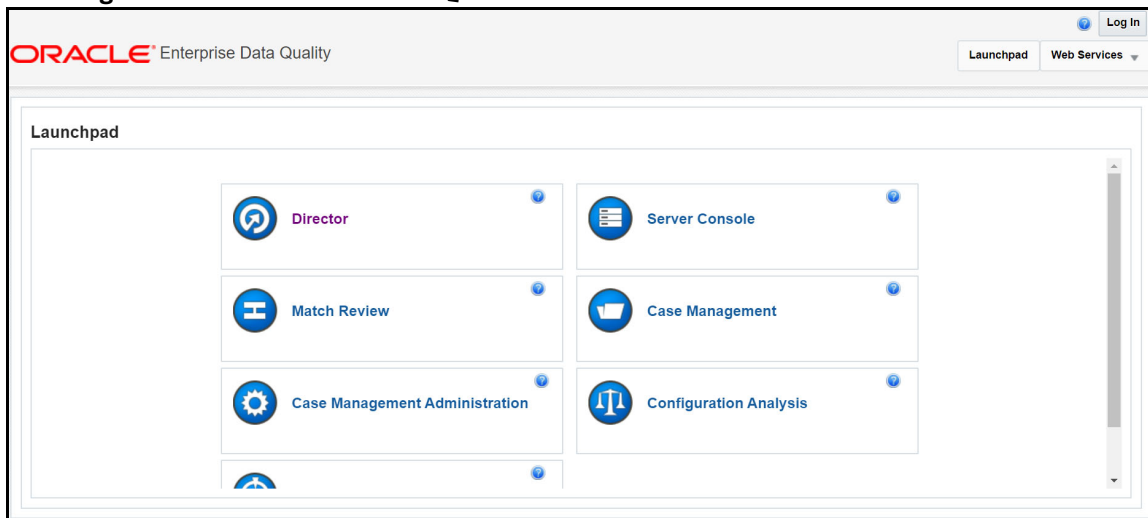

2. In the **Director** landing page, expand the **Customer-Screening** project in the **Project Browser** pane.

Figure 124: Project Browser Pane

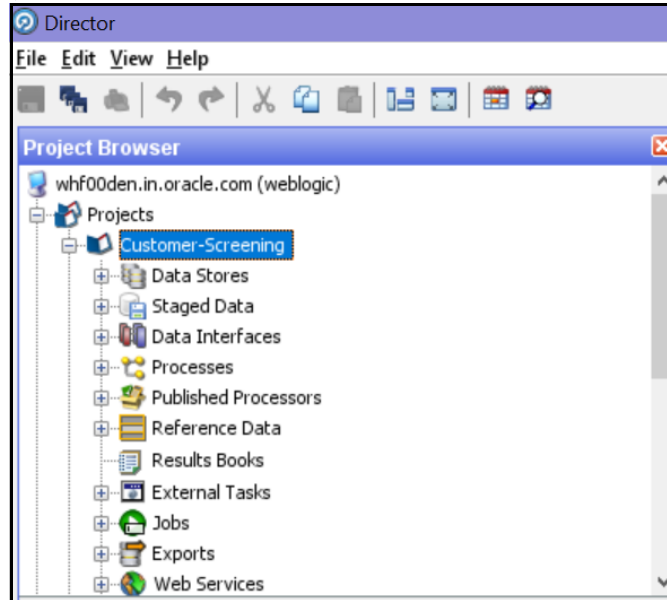

3. Expand the **Data Stores** node and then double-click the **ACY** node.

Figure 125: Data Stores Node

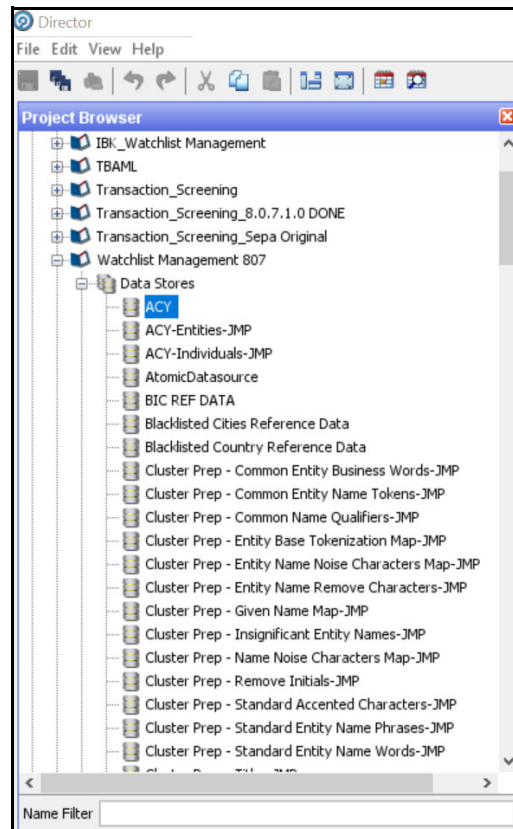

- In the **Edit Data Store** window, deselect the **Use groups** checkbox.

Figure 126: Edit Data Store Window for the Accuity Watch List

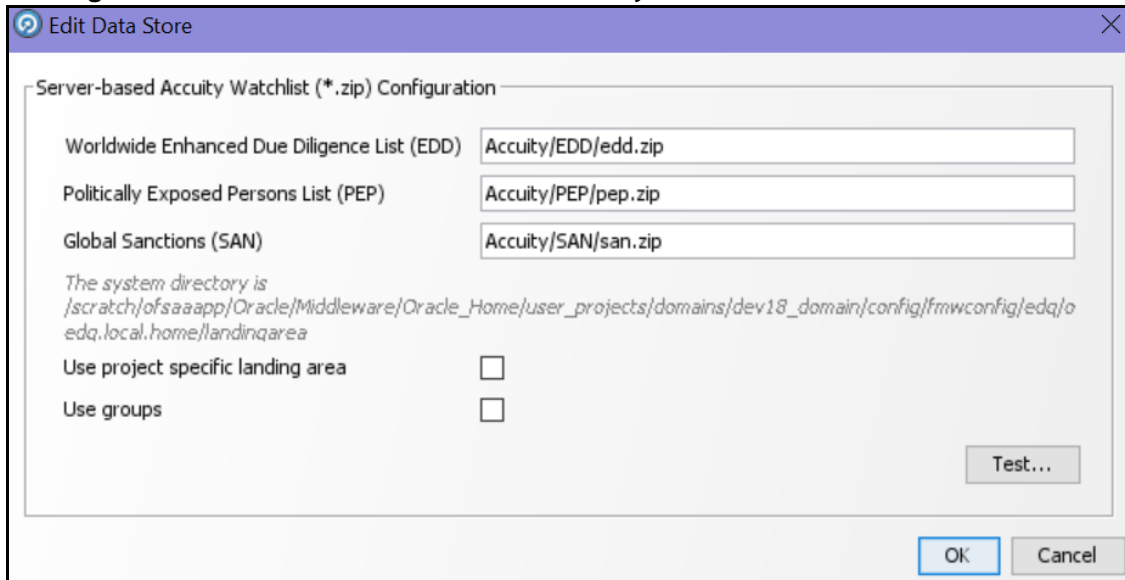

- Configure your `PATH` system variable to include the path to your Java installation.
- Add the user name and password and the proxy server configuration details for Accuity in the batch or script file.

NOTE If the **Use groups** checkbox is selected, you must have downloaded the `GROUP.XML` file

10.8.1.1 New Alerts Resulting from Use of the Group File

When you use the `GROUP.XML` file, the original record identifier for a record is replaced with the group ID of the record. Any change to the original record identifier will result in new alerts being generated for existing and known matches. This can happen in the following scenarios:

- If Individuals or entities are moved into, out of, or between groups, then new alerts are generated for existing matches.
- If the setting of the **Use groups** checkbox is changed after alerts or cases are generated.

WARNING Do not alter the setting of the **Use groups** checkbox during the implementation phase of the project.

10.8.2 Configuring the .sh File

You can automate the download of the Accuity watch list using the following script files that are provided with Customer Screening to configure the download process:

- `download-acy-edd.sh`
- `download-acy-pep.sh`
- `download-acy-san.sh`

The script files are used by the automated task to download the data files and copy them to the Oracle Enterprise Data Quality (OEDQ) landing area. The script files must be modified to provide the download URL and the proxy server details for your Internet connection as follows:

1. Go to the EDQ URL and open the **Director** menu.

Figure 127: Director Menu in EDQ

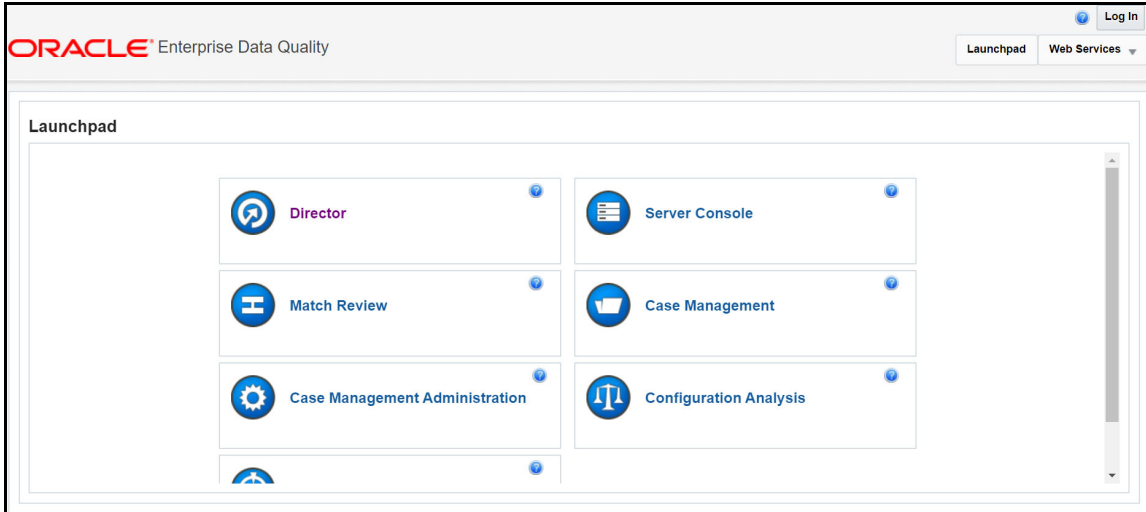

2. In the **Director** landing page, expand the **Customer-Screening** project in the **Project Browser** pane.

Figure 128: Project Browser Pane

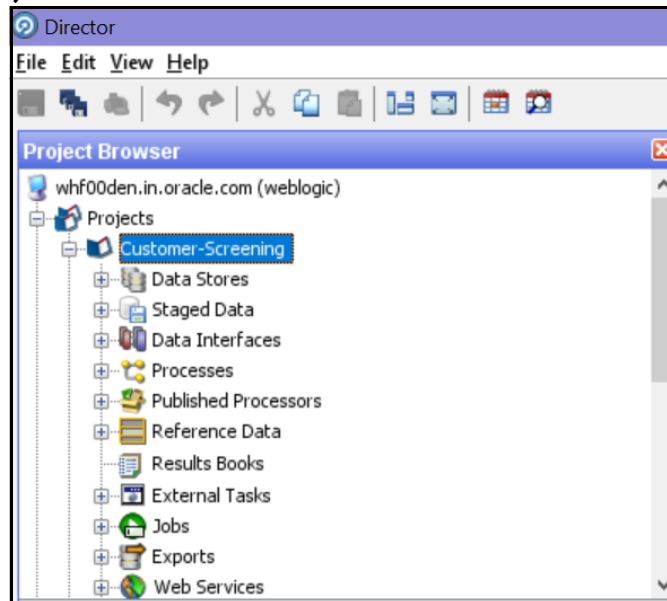

3. Expand the **External Tasks** node for the Watch list Management project and then double-click on the **Download Accuity EDD** task.

Figure 129: External Tasks Node

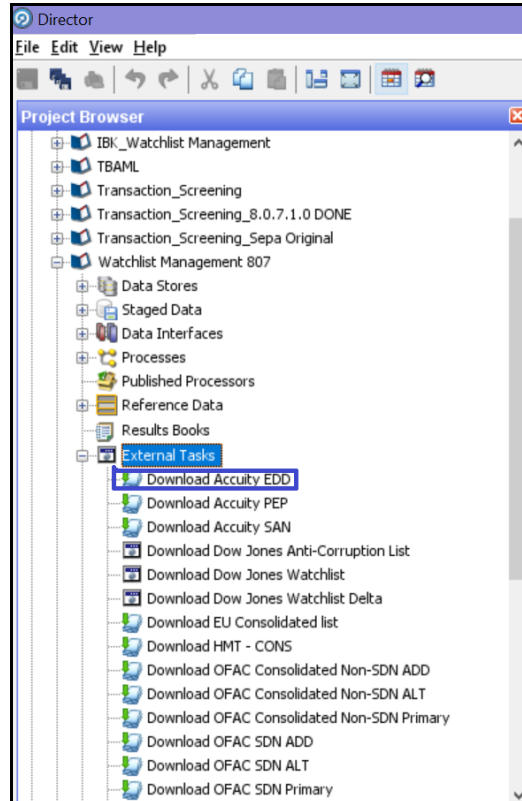

4. Replace the `EDQ_DOMAIN` placeholder with the installed domain path for the `EDD`, `PEP`, and `SAN` records.

Figure 130: Edit Task Window for the Accuity Watch List



5. Configure your `PATH` system variable to include the path to your Java installation.
6. Add the user name and password and the proxy server configuration details for Accuity in the `download-acy-edd.sh`, `download-acy-pep.sh`, and `download-acy-san.sh` script files.

NOTE

To ensure that you have the SFTP protocol enabled for automatic password recognition, you must install `sshpas`.

10.9 Delta Watch List Configurations for the Dow Jones Watch List

NOTE

These configurations are performed when you do not want to download the full watch list, and only want to download the delta watch list. This helps to reduce the download time and is not part of the screening process.

Customer Screening recommends that you always use the full watch list during the screening process. Due to the clustering strategy which is implemented in the screening process, you must not download the delta watch list. There are certain cases in which you must download the delta watch list files, for example, if the full watch list files are not yet available for download or if you want to save time.

Customers who download the delta watch list files must first download the full watch list files and then download the delta watch list files. The delta watch list is then merged into the full watch list before screening.

The following image shows the information flow for the delta watch list:

Figure 131: Flow for Delta Watch List

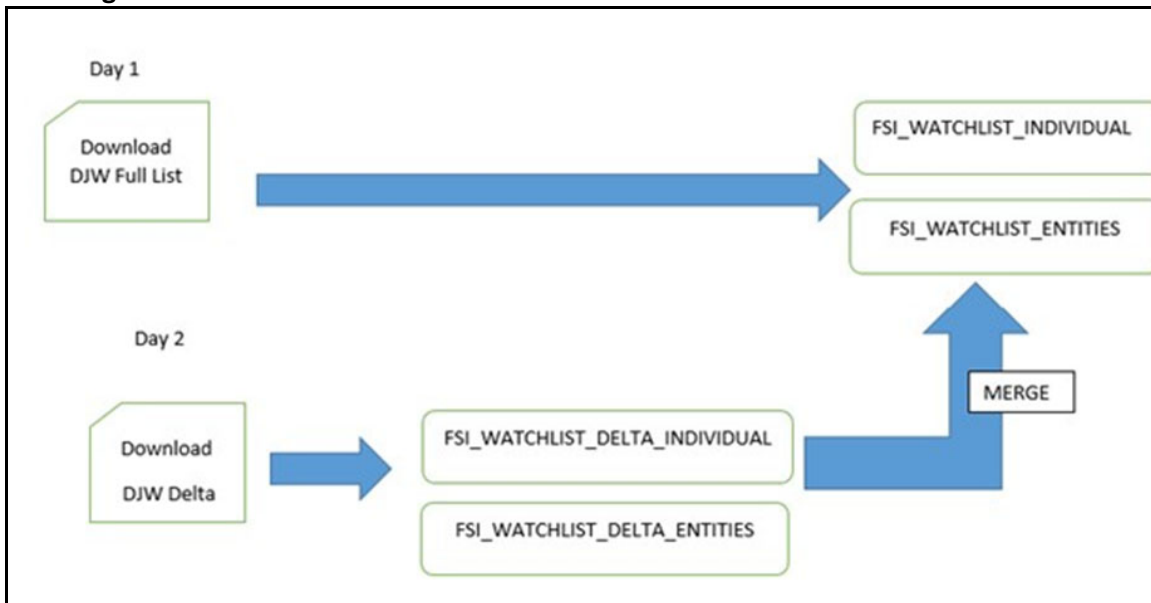

When you download the full watch list, data is stored in the `FSI_WATCHLIST_INDIVIDUAL` and `FSI_WATCHLIST_ENTITIES` tables. When you download the delta watch list, data is first stored in the `FSI_WATCHLIST_DELTA_INDIVIDUAL` and `FSI_WATCHLIST_DELTA_ENTITIES` tables. Then, based on the value in the `ACTION` Flag tag in the delta watch list, it merges with the full watch list.

The `ACTION` flag key is a non-editable value, and can be one of the following values:

- **new**: If the value is `new`, it means that these records are new and are added to the full watch list when the delta files are merged with the full watch list.
- **chg**: If the value is `chg`, it means that these records are modified and are added to the full watch list when the delta files are merged with the full watch list.

- **del:** If the value is `del`, it means that these records are no longer active and are removed from the full watch list when the delta files are merged with the full watch list.

NOTE

- You must always run the full watch list files before you run the delta watch list files. The full watch list files must be downloaded if, for example, the download of the delta watch list files has failed for multiple days. You can also run the full watch list once every week to ensure that the complete data has been processed.

10.9.1 Configurations for the Full and Delta Watch Lists

The following configurations must be done for both full and delta watch list updates in the `watch list-management.properties` run profile. The run profile is available in the `<domain_name>/edq/oedq.local.home/runprofiles/` directory when you log in to the WinSCP server.

- Set `phase.Initialise\ staged\ data.enabled = N` to disable the `.jmp` file updates.
- Set `phase.Initialise\ staged\ data\ DB.enabled = Y` to initialize the database.
- Set `phase.Initilize\ Prepared\ List\ Data.enabled = N` to disable the `.jmp` file updates.
- Set `phase.Initilize\ Prepared\ List\ Data\ DB.enabled = Y` to prepare the database.

10.9.2 Running the Full Watch list

To run the full watch list, follow these steps:

1. Set the following properties in the `watch list-management.properties` file:
 - `phase.DJW\ -\ Download.enabled = Y.`
 - `phase.DJW\ -\ Download\ Delta.enabled = N.`
 - `phase.DJW\ -\ Stage\ reference\ lists.enabled = Y.`
 - `phase.*.export.*.ind_table_name = FSI_WATCHLIST_INDIVIDUAL.`
 - `phase.*.export.*.entities_table_name = FSI_WATCHLIST_ENTITIES.`
2. Set the following properties in the `customer-screening.properties` file:
 - `phase.DJW\ -\ Load\ without\ filtering.enabled = N`
 - `phase.DJW\ -\ Load\ without\ filtering\ DB.enabled = Y`
 - `phase.DJW\ -\ Load\ with\ filtering\ (Part\ 1).enabled = N`
 - `phase.DJW\ -\ Load\ with\ filtering\ (Part\ 1)\ DB.enabled = Y`
 - `phase.DJW\ -\ Load\ with\ filtering\ (Part\ 2).enabled = Y`
3. Set the following properties in the `customer-screening-real-time.properties` file:
 - `phase.DJW\ -\ Load\ without\ filtering.enabled = N`
 - `phase.DJW\ -\ Load\ without\ filtering\ DB.enabled = Y`
 - `phase.DJW\ -\ Load\ with\ filtering\ (Part\ 1).enabled = N`

- `phase.DJW\ -\ Load\ with\ filtering\ (Part\ 1)\ DB.enabled = Y`
 - `phase.DJW\ -\ Load\ with\ filtering\ (Part\ 2).enabled = Y`
4. Set the following properties in the `external-entity-screening.properties` file:
- `phase.DJW\ -\ Load\ without\ filtering.enabled = N`
 - `phase.DJW\ -\ Load\ without\ filtering\ DB.enabled = Y`
 - `phase.DJW\ -\ Load\ with\ filtering\ (Part\ 1).enabled = N`
 - `phase.DJW\ -\ Load\ with\ filtering\ (Part\ 1)\ DB.enabled = Y`
 - `phase.DJW\ -\ Load\ with\ filtering\ (Part\ 2).enabled = Y`

10.9.3 Running the Delta Watch List

To run the delta watch list, follow these steps:

1. Set the following properties in the `watch_list-management.properties` file:
 - `phase.DJW\ -\ Download.enabled = N.`
 - `phase.DJW\ -\ Download\ Delta.enabled = Y.`
 - `phase.DJW\ -\ Stage\ reference\ lists.enabled = Y.`
2. Set `phase.*.export.*.ind_table_name = FSI_WATCHLIST_DELTA_INDIVIDUAL.`
3. Set `phase.*.export.*.entities_table_name = FSI_WATCHLIST_DELTA_ENTITIES.`

10.9.4 Merging the Delta Watch List to the Full Watch List

To merge the delta watch list with the full watch list, set the following properties in the `watch_list-management.properties` file:

- `phase.Delta\ Merge.enabled = Y.`
- `phase.Linked\ Profiles.enabled = Y.`

10.10 Delta Watch List Configurations for the World-Check Watch List

NOTE

These configurations are performed when you do not want to download the full watch list, and only want to download the delta watch list. This helps to reduce the download time and is not part of the screening process.

Customer Screening recommends that you always use the full watch list during the screening process. Due to the clustering strategy, which is implemented in the screening process, you must not download the delta watch list. There are certain cases in which you must download the delta watch list files, for example, if the full watch list files are not yet available for download or if you want to save time.

Customers who download the delta watch list files must first download the full watch list files and then download the delta watch list files. The delta watch list is then merged into the full watch list before screening.

The following image shows the information flow for the delta watch list:

Figure 132: Flow for Delta Watch List

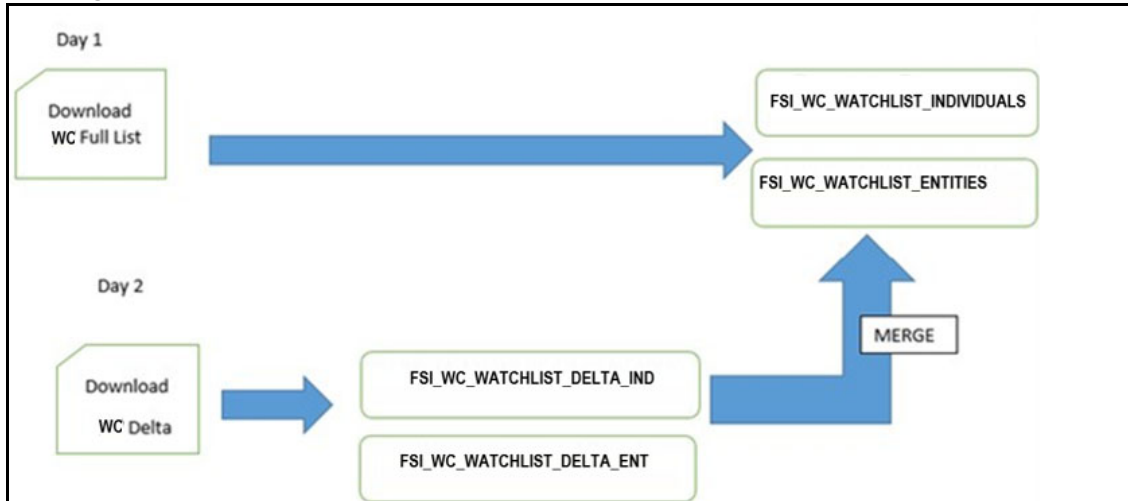

When you download the full watch list, data is stored in the `FSI_WC_WATCHLIST_INDIVIDUALS` and `FSI_WC_WATCHLIST_ENTITIES` tables. When you download the delta watch list, data is first stored in the `FSI_WC_WATCHLIST_DELTA_IND` and `FSI_WC_WATCHLIST_DELTA_ENT` tables. Then the data is merged into the main table. For more information, see [Merging the Delta Watch List to the Full Watch List](#).

NOTE

You must always run the full watch list files before you run the delta watch list files. The full watch list files must be downloaded if, for example, the download of the delta watch list files has failed for multiple days. You can also run the full watch list once every week to ensure that the complete data has been processed.

10.10.1 Configurations for the Full and Delta Watch Lists

The following configurations must be done for both full and delta watch list updates in the `watch list-management.properties` run profile. The run profile is available in the `<domain_name>/edq/oedq.local.home/runprofiles/` directory when you log in to the WinSCP server.

- Set `phase.Initialise\ staged\ data.enabled = N` to disable the `.jmp` file updates.
- Set `phase.Initialise\ staged\ data\ DB.enabled = Y` to initialize the database.
- Set `phase.Initilize\ Prepared\ List\ Data.enabled = N` to disable the `.jmp` file updates.
- Set `phase.Initilize\ Prepared\ List\ Data\ DB.enabled = Y` to prepare the data-base.

10.10.2 Running the Full Watch list

To run the full watch list, follow these steps:

1. Set the following properties in the `watch list-management.properties` file:
 - `phase.WC\ -\ Download.enabled = Y.`
 - `phase.WC\ -\ Download\ Delta.enabled = N.`
 - `phase.WC\ -\ Stage\ reference\ lists.enabled = Y.`
 - `phase.*.export.*.wc_ind_table_name=FSI_WC_WATCHLIST_INDIVIDUAL`

· \$ phase.*.export.*.wc_entities_table_name=FSI_WC_WATCHLIST_ENTITIES

To run the full watch list without filtering, set the following properties:

- phase.WC\ -\ Prepare\ without\ filtering.enabled = N
- phase.WC\ -\ Prepare\ without\ filtering\ Full\ DB.enabled = Y

To run the full watch list with filtering, set the following properties:

- phase.WC\ -\ Prepare\ with\ filtering\ (Part\ 1).enabled = N
- phase.WC\ -\ Prepare\ with\ filtering\ (Part\ 2).enabled = N
- phase.WC\ -\ Prepare\ with\ filtering\ Full\ DB.enabled = Y

To run the full watch list without filtering, set the following properties:

- phase.WC\ -\ Load\ without\ filtering.enabled = N
- phase.WC\ -\ Load\ without\ filtering\ DB.enabled = Y

To run the full watch list with filtering, set the following properties:

- phase.WC\ -\ Load\ with\ filtering\ (Part\ 1).enabled = N
- phase.WC\ -\ Load\ with\ filtering\ (Part\ 1)\ DB.enabled = Y
- phase.WC\ -\ Load\ with\ filtering\ (Part\ 2).enabled = Y

2. Set the following properties in the `customer-screening-real-time.properties` file:

- phase.WC\ -\ Load\ without\ filtering.enabled = N
- phase.WC\ -\ Load\ without\ filtering\ DB.enabled = Y
- phase.WC\ -\ Load\ with\ filtering\ (Part\ 1).enabled = N
- phase.WC\ -\ Load\ with\ filtering\ (Part\ 1)\ DB.enabled = Y
- phase.WC\ -\ Load\ with\ filtering\ (Part\ 2).enabled = Y

3. Set the following properties in the `external-entity-screening.properties` file:

- phase.WC\ -\ Load\ without\ filtering.enabled = N
- phase.WC\ -\ Load\ without\ filtering\ DB.enabled = Y
- phase.WC\ -\ Load\ with\ filtering\ (Part\ 1).enabled = N
- phase.WC\ -\ Load\ with\ filtering\ (Part\ 1)\ DB.enabled = Y
- phase.WC\ -\ Load\ with\ filtering\ (Part\ 2).enabled = Y

10.10.3 Running the Delta Watch List

To run the delta watch list, follow these steps:

1. Set the following properties in the `watch_list-management.properties` file:

- phase.WC\ -\ Download.enabled = N.
- phase.WC\ -\ Download\ Delta.enabled = Y.
- phase.WC\ -\ Stage\ reference\ lists.enabled = Y.
- phase.*.export.*.wc_ind_table_name=FSI_WC_WATCHLIST_DELTA_IND
- phase.*.export.*.wc_entities_table_name=FSI_WC_WATCHLIST_DELTA_ENT

2. To run the delta watch list without filtering, set the following properties:

- `phase.WC\ -\ Prepare\ without\ filtering.enabled = N`
- `set phase.WC\ -\ Prepare\ without\ filtering\ Delta\ DB.enabled = Y`

To run the delta watch list with filtering, set the following properties:

- `phase.WC\ -\ Prepare\ with\ filtering\ (Part\ 1).enabled = N`
- `phase.WC\ -\ Prepare\ with\ filtering\ (Part\ 2).enabled = N`
- `phase.WC\ -\ Prepare\ with\ filtering\ Delta\ DB.enabled = Y`

10.10.4 Merging the Delta Watch List to the Full Watch List

To merge the delta watch list with the full watch list, set the following properties in the `watch list-management.properties` file:

- `phase.WC\Delta\ Merge.enabled = Y.`
- `phase.WC\Linked\ Profiles.enabled = Y.`

11 Appendix D: Splitting Jobs Using Multiple EDQ Servers

You can split jobs across multiple servers to reduce the time taken to process many customers, for example, one million or more.

NOTE These steps are applicable only if you plan to use multiple EDQ servers for customer screening. If you want to use the default setup, that is, only a single EDQ server, see [Scheduling the Customer Screening Run Job](#).

Some examples are as follows:

- If one server is used to process the watch lists and another server is used to process the entity names.
- If one server is used to process data of individuals and another server is used to process data of entities during different times of day.

NOTE

1. Provide the EDQ user name and password in the `cs_appln_params` table.
2. Run the `select * from cs_edq_servers` query in your SQL query tool to verify the server details.

To split jobs using multiple servers, follow these steps:

1. Navigate to the `FIC_DB_HOME/bin` directory.
2. Execute `./EDQServerInsert.sh <INFODOM NAME>`. This step is used to register the EDQ server details. You must replace the `INFODOM NAME` placeholder with your domain name.
3. Enter the following details in the console where the command is run:
 - EDQ Server Name
 - EDQ server IP
 - EDQ Server Direct Port number (JMX port number). This value must be 8090.
 - EDQ Server User Name
 - EDQ Password details

Figure 133: EDQ Details

```

'ficdb/bin>./EDQServerInsert.sh SANC808TF
Started finding Jars
Ended finding Jars
Classpath Created
Calling EDQ Main Method
Inside EDQ insert method
Enter EDQ Server Name :
TESTING
Enter EDQ Server User Name:
weblogic
Enter EDQ Password:
Encrypting password
Enter EDQ Server Director Port:
8090
Enter EDQ Server IP:
whf00abc.in.oracle.com

```

4. Duplicate the `CS_Data_Load_Event_Generation` batch in the **Run** page. To do this, copy the `CS_Data_Load_Event_Generation` batch and create another batch.

Follow these steps to access the **Run** page:

- a. Login as the administrator. The **Financial Services Analytical Applications Customer Screening** home page appears.

Figure 134: Financial Services Analytical Applications Customer Screening Home Page

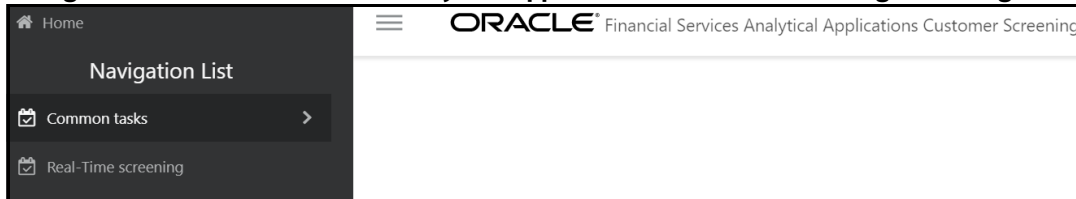

- b. Click the **hamburger** icon  to view the **Application Navigation List**.

Figure 135: Application Navigation List



- c. From the **Application Navigation List**, select **Common Tasks**, then select **Rule Run Framework**, and then select **Run**. The **Run page appears**.
5. In the **Run** page, follow these steps to create a duplicate batch:
 - a. Select the `CS_Data_Load_Event_Generation` run and click **Copy**. The **Run** page opens in copy mode.

NOTE

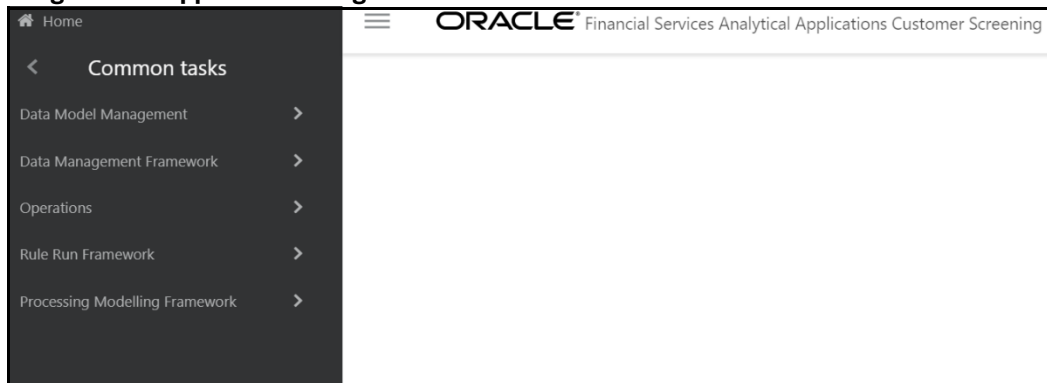
You must select the segment folder for the Sanctions pack in the **Folder** field to proceed.

Figure 136: Run Page in Copy Mode

Location	Infodom	Code	Name	Type	Simulation Job	Use Descendants
<input type="checkbox"/> Job	CSINFODOM	CS_E2E_Start_Batch	CS_End_To_End_Start_Batch	Process		
<input type="checkbox"/> Job	CSINFODOM	TruncateCSTables	Truncate CS Tables	Process		

- b. Enter a new run code or alter the existing value in the **Code** field. For example, code can be CS_Data_Load_Event_GenerationD.
- c. Enter a new run name or alter the existing value in the **Code** field. For example, name can be CS Data Load And Event Generation.

NOTE The run name and run code values can be the same.

- d. Click **Next** to go to the next page and confirm the name.
- e. Click **Save**.

After you click **Save**, the new run name appears in the **Run** page.

Figure 137: New Run Name in Run Page

Code	Name	Type	Folder	Version	Active
CSBusinessDataLoad	Customer Screening Business Data Load	Base Run	TFLSEGMENT	0	Yes
CS_Data_Load_Event_Generation	CS Data Load And Event Generation	Base Run	TFLSEGMENT	0	Yes
CS_Data_Load_Event_GenerationD	CS Data Load And Event Generation	Base Run	TFLSEGMENT	0	Yes
CS_EDQ_Watchlist_Analyze	Customer Screening EDQ Watchlist Analyze	Base Run	TFLSEGMENT	0	Yes
CS_EDQ_Watchlist_Management	Call Watchlist Management	Base Run	TFLSEGMENT	0	Yes

6. Duplicate the CS_E2E_Start_Batch, CS_Call_Customer_Screening, and CS_E2E_End_Batch processes in the **Process** page.

Figure 138: Process Page

Code	Name	Folder	Version	Active
<input type="checkbox"/>	CS_Business_Data_Load	TFLSEGMENT	0	Yes
<input type="checkbox"/>	CS_Call_Customer_Screening	TFLSEGMENT	0	Yes
<input type="checkbox"/>	CS_Call_Customer_Screening_den	TFLSEGMENT	0	Yes
<input type="checkbox"/>	CS_Call_Ext_Ent_Screening	TFLSEGMENT	0	Yes
<input type="checkbox"/>	CS_Call_Watchlist_Analyze	TFLSEGMENT	0	Yes
<input type="checkbox"/>	CS_Call_Watchlist_Download	TFLSEGMENT	0	Yes
<input type="checkbox"/>	CS_E2E_End_Batch	TFLSEGMENT	0	Yes
<input type="checkbox"/>	CS_E2E_End_Batch_den	TFLSEGMENT	0	Yes
<input type="checkbox"/>	CS_E2E_End_Batch_US	TFLSEGMENT	0	Yes
<input type="checkbox"/>	CS_E2E_Start_Batch	TFLSEGMENT	0	Yes
<input type="checkbox"/>	CS_E2E_Start_Batch_den	TFLSEGMENT	0	Yes
<input type="checkbox"/>	CS_End_Batch	TFLSEGMENT	0	Yes

7. Follow these steps to access the **Process** page:
 - f. Login as the administrator. The **Financial Services Analytical Applications Customer Screening** home page appears.

Figure 139: Financial Services Analytical Applications Customer Screening Home Page

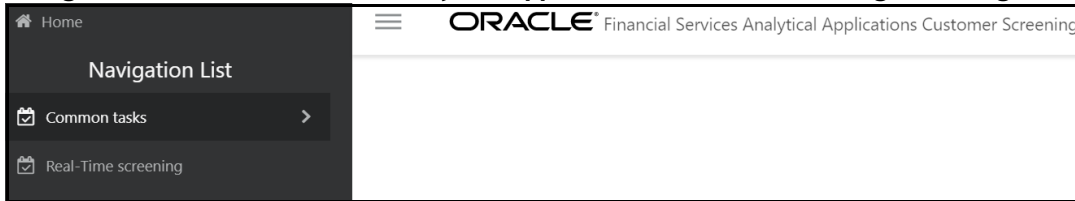

- g. Click the **hamburger** icon  to view the **Application Navigation List**.

Figure 140: Application Navigation List



- h. From the **Application Navigation List**, select **Common Tasks**, then select **Rule Run Framework**, and then select **Process**. The **Process** page appears.
8. To duplicate each process, follow these steps:
 - a. For the CS_E2E_Start_Batch process:

- i. In the **Process** page, select `CS_E2E_Start_Batch` and click **Copy**. The **Process** page opens in copy mode.

NOTE You must select the segment folder for the Sanctions pack in the **Folder** field to proceed.

- ii. Enter a new process code in the **Code** field and a new process name in the **Name** field. You can also alter the existing process code or name. For example, `CS_E2E_Start_Batch_den`.
 - iii. Click **Save**.
- b. For the `CS_Call_Customer_Screening` process:
 - i. In the **Process** page, select `CS_Call_Customer_Screening` and click **Copy**. The **Process** page opens in copy mode.
 - ii. Enter a new process code in the **Code** field and a new process name in the **Name** field. You can also alter the existing process code or name. For example, `CS_Call_Customer_Screening_den`.
 - iii. Click **Save**.
 - c. For the `CS_E2E_End_Batch` process:
 - i. In the **Process** page, select `CS_E2E_End_Batch` and click **Copy**. The **Process** page opens in copy mode.
 - ii. Enter a new process code in the **Code** field and a new process name in the **Name** field. You can also alter the existing process code or name. For example, `CS_E2E_End_Batch_den`.
 - iii. Click **Save**.

After you click **Save**, the new process names appear in the **Process** page.

Figure 141: New Process Names in Process Page

Process ? Search Reset

Code Version

Name Active

Folder

+ New View Edit Copy Remove Authorize Export Trace Definition

<input type="checkbox"/>	Code	Name	Folder	Version	Active
<input type="checkbox"/>	CS_Business_Data_Load	CS Business Data Load	TFLSEGMENT	0	Yes
<input type="checkbox"/>	CS_Call_Customer_Screening	CS Customer Screening Call	TFLSEGMENT	0	Yes
<input type="checkbox"/>	CS_Call_Customer_Screening_den	CS Customer Screening Call den	TFLSEGMENT	0	Yes
<input type="checkbox"/>	CS_Call_Ext_Ent_Screening	CS External Entity Screening Call	TFLSEGMENT	0	Yes
<input type="checkbox"/>	CS_Call_Watchlist_Analyze	Analyze Reference Data Quality	TFLSEGMENT	0	Yes
<input type="checkbox"/>	CS_Call_Watchlist_Download	Download, Prepare, Filter and Export All Lists	TFLSEGMENT	0	Yes
<input type="checkbox"/>	CS_E2E_End_Batch	CS_End_To_End_End_Batch	TFLSEGMENT	0	Yes
<input type="checkbox"/>	CS_E2E_End_Batch_den	CS_End_To_End_End_Batch den	TFLSEGMENT	0	Yes
<input type="checkbox"/>	CS_E2E_End_Batch_US	CS_End_To_End_End_Batch_US	TFLSEGMENT	0	Yes
<input type="checkbox"/>	CS_E2E_Start_Batch	CS_End_To_End_Start_Batch	TFLSEGMENT	0	Yes
<input type="checkbox"/>	CS_E2E_Start_Batch_den	CS_End_To_End_Start_Batch den	TFLSEGMENT	0	Yes

9. Update the group name for the CS_E2E_Start_Batch_den and CS_E2E_End_Batch_den processes. To do this, run the following query:

```
select * from cs_processing_group
```

10. Change the parameter for the CS_E2E_Start_Batch_den process. To do this, follow these steps:
- Select the duplicated process created in the earlier step and click **Edit**. The **Process** page opens in edit mode.
 - Click **Component**. The **Component Selector** window appears.
 - Click the drop-down list in line with the **F_CS_BATCH_RUN** task. The **Parameters** window appears.

Figure 142: Parameter for the CS_E2E_Start_Batch Process

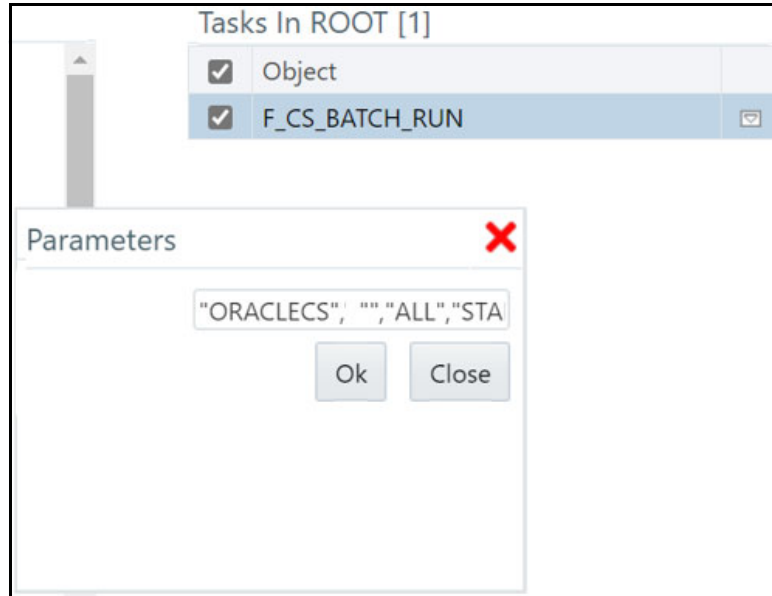

- d. Change the ORACLECS parameter to the applicable data origin or processing name.
11. Change the parameter for the CS_E2E_End_Batch_den process. To do this, follow these steps:
 - a. Select the duplicated process created in the earlier step and click **Edit**. The **Process** page opens in edit mode.
 - b. Click **Component**. The **Component Selector** window appears.
 - c. Select the drop-down list in line with the **F_CS_BATCH_RUN** task. The **Parameters** window appears.

Figure 143: Parameter for the CS_E2E_End_Batch Process

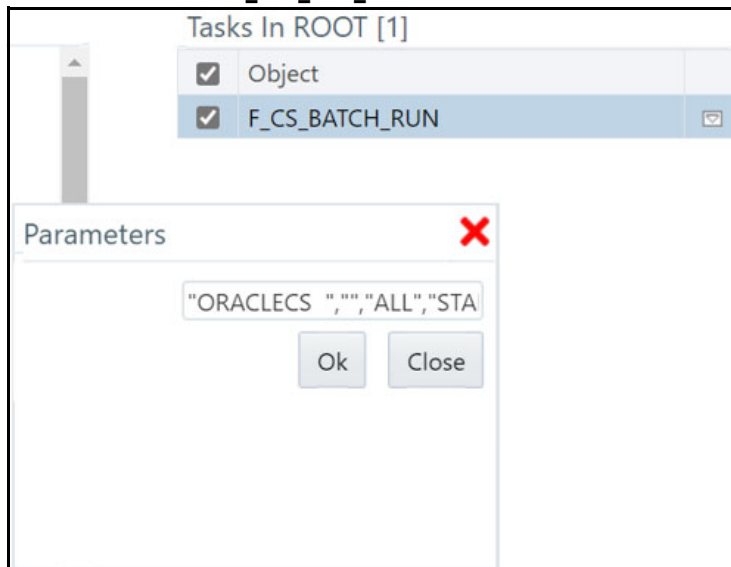

- d. Change the ORACLECS parameter to the data origin or processing name.
12. To change the parameters for the CS_Call_Customer_Screening_den process, follow these steps:

- a. Select the duplicated process created in the earlier step and click **Edit**. The **Process** page opens in edit mode.
- b. Click **Component**. The **Component Selector** window appears.
- c. Select the drop-down list in line with the **CalledEDQ** task. The **Parameters** window appears with the following values:

```
"runprofileName=customer-screening1.properties", "RunLabel=customer-screening", "JobName=MAIN", "ProjectName=Customer-Screening", "edqServerName=SERVER_2", "condition=and AGE_YR_CT>20 and BIRTH_DT <= @$~20 June 1972@$~"
```

Figure 144: Parameters for the CS_Call_Customer_Screening_den Process

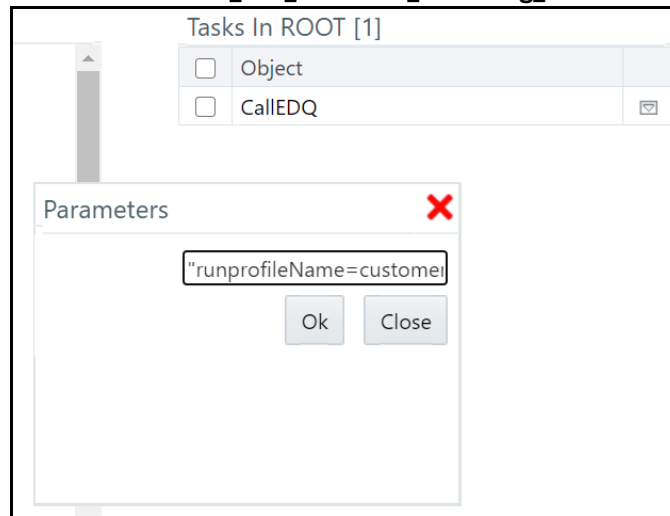

- d. Change the following parameters:
 - i. Run profile name.
Example: `runprofileName=customer-screening1.properties`
 - ii. EDQ server name. If you do not change the server name, it is replaced with the server name in the `cs_appln_params` table.
Example: `"edqServerName=SERVER_2"`
 - iii. Condition. By default, a single condition is provided. Use *and* to give more than one condition.
Example: `"condition=and AGE_YR_CT>20 and BIRTH_DT <= @$~20 June 1972@$~"`

NOTE

1. It is not mandatory to provide a condition.
2. Provide the expression `@$~` to use alphanumeric characters for fields such as customer birth date. For example, `"condition=and AGE_YR_CT>20 and BIRTH_DT <= @$~20 June 1972@$~"`.

13. Replace the new batches in the **Run** page. To do this, follow these steps:
 - a. Select `CS_Data_L_Event_Generation_Den` and click **Edit**. The **Run** page opens in edit mode.

- b. Click the **Selector** drop-down list and select **Job**. The **Component Selector** window appears.

Figure 145: Parameters for the CS_Call_Customer_Screening_den Process

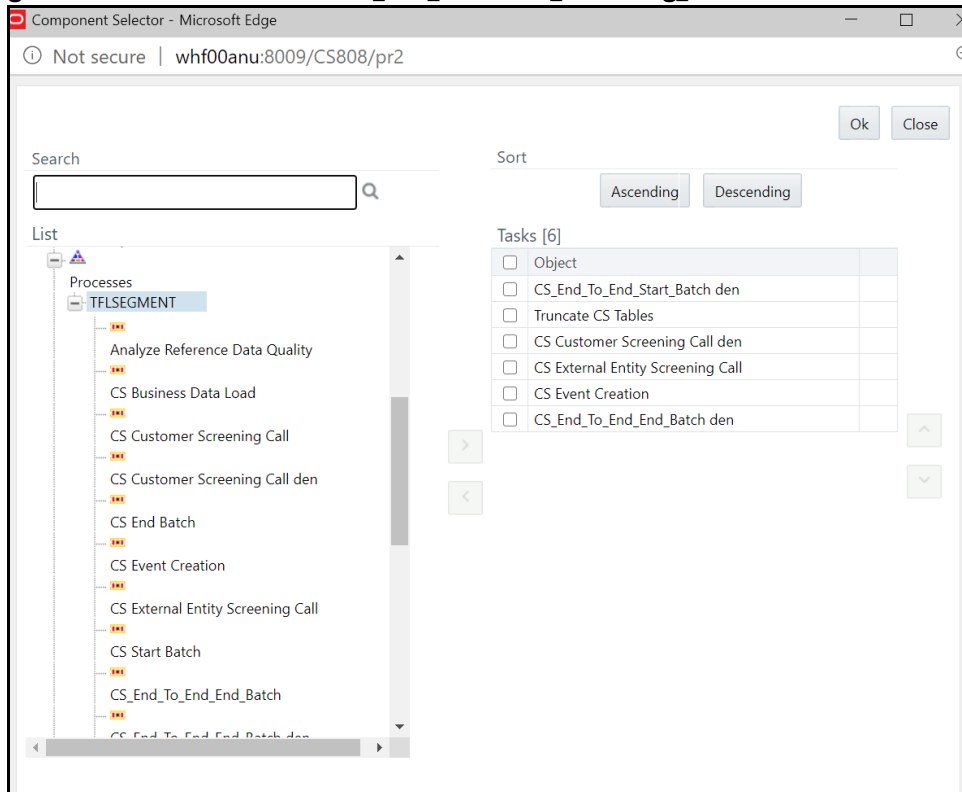

- c. In the **List** hierarchy window, expand the **Transformation Rules** node.
- d. Expand the **Processes** node and then the **TFLSEGMENT** node.
- e. In the **Tasks** table, select the original processes, which are `CS_End_To_End_Start_Batch`, `CS Customer Screening Call`, and `CS_End_To_End_End_Batch`. These processes must be selected one at a time.
- f. Click **Move** . The selected batches are displayed in the **TFLSEGMENT** node.
- g. In the **List** table, select the new processes, which are `CS_End_To_End_Start_Batch_den`, `CS Customer Screening Call den`, and `CS_End_To_End_End_Batch_den`.
- h. Click **Remove** . The selected batches are displayed in the **Tasks** table.
- i. Click **OK**.

The duplicate jobs are now split across servers using the `CS_End_To_End_Start_Batch`, `CS Customer Screening Call`, and `CS_End_To_End_End_Batch` batches.

11.1 Adding Input Parameters for the CalledEDQ Task

Finally, add the new EDQ server name and applicable condition as input parameters in the **Post Load Changes** page as shown in the following steps:

1. Click the **hamburger** icon to view the Application Navigation List.

- From the **Application Navigation List**, select **Common Tasks**, then select **Data Management Framework**, then select **Data Management Tools**, and then select **Post Load Changes**. The **Post Load Changes** page appears.

Figure 146: Post Load Changes Page

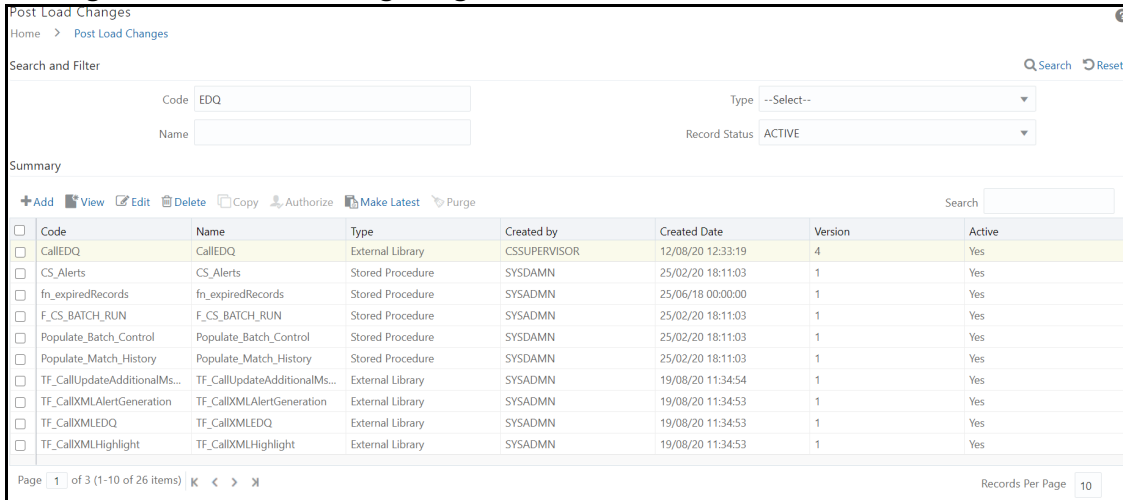

- Search for *CallEDQ* in the **Code** field and select it.
- Click **Edit**.
- In the **Transformation Process Flow** section, select **Input Parameters**. The Input parameters appear in the **Parameter Definition** section.
- Click **Add Row** to add a row. You must add two rows, one for the EDQ server name and one for the condition.

Figure 147: Adding Input Parameters

The screenshot shows the 'Parameter Definition' table with the following data:

Parameter Name	Data Type	Default Value
RUNID	Varchar2	null
PHID	Varchar2	null
EXEID	Varchar2	null
RUNSK	Varchar2	null
PropertiesFileName	Varchar2	null
RunLabel	Varchar2	null
JobName	Varchar2	null
ProjectName	Varchar2	null
edqServerName	Varchar2	null
condition	Varchar2	null

- Click **Finish**.

To verify the batch execution logs for the EDQ tasks, see the `FIC_HOME/ficdb/bin/CS_EDQ_CALL` log file.

12 Appendix E: Viewing Snapshots of Tables in EDQ

To view a snapshot of a selected table and associated columns in the **Results Browser** pane in Enterprise Data Quality (EDQ), follow these steps:

1. Go to the EDQ URL and open the **Director** menu. The **Director** landing page appears.

Figure 148: Director Menu in EDQ

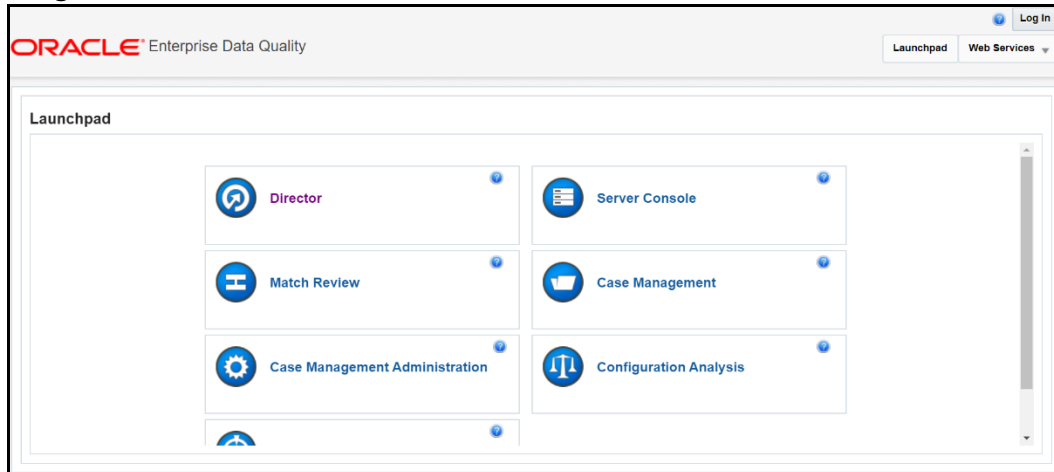

2. In the **Director** landing page, expand the **Customer-Screening** project in the **Project Browser** pane.

Figure 149: Project Browser Pane

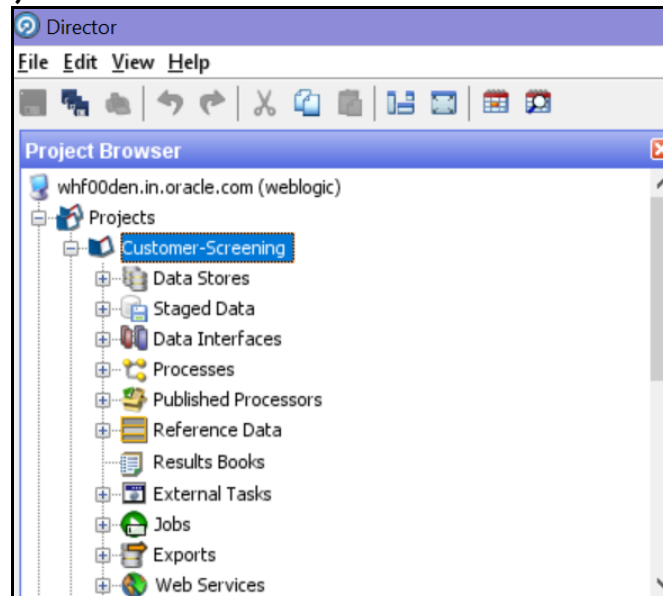

3. Expand the **Staged Data** node and double-click **FCDM Customer Data**.

Figure 150: FCDM Customer Data Node

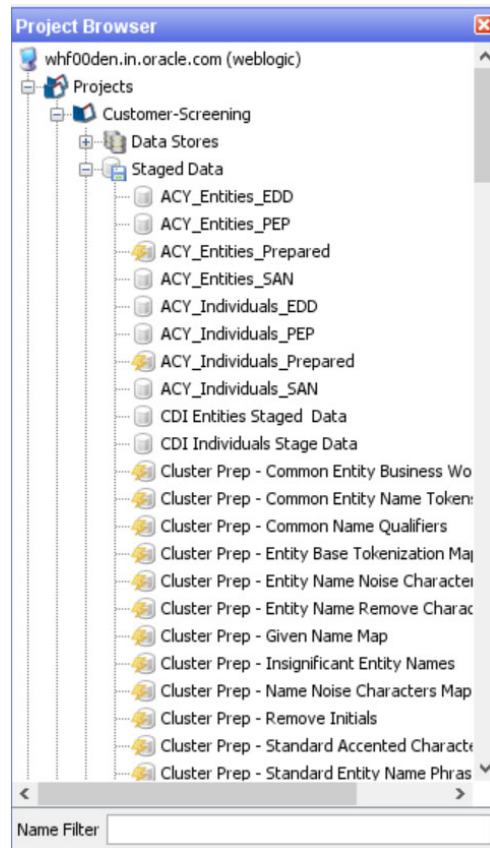

4. In the Setup Snapshot window, double-click **FCDM Batch Data**.

Figure 151: Setup Snapshot Window

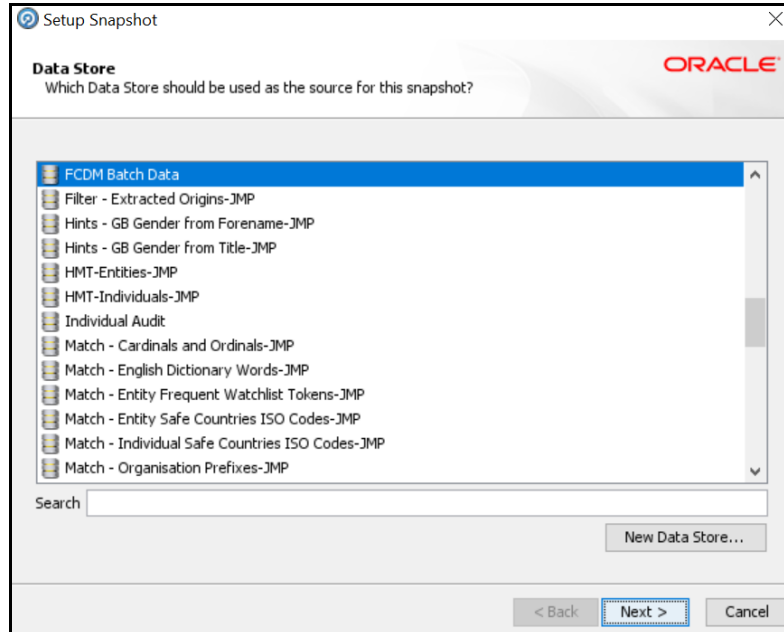

5. The default view is the SQL query. To change the view to a table view, select **Select Table or View**.

Figure 152: Select Table or View

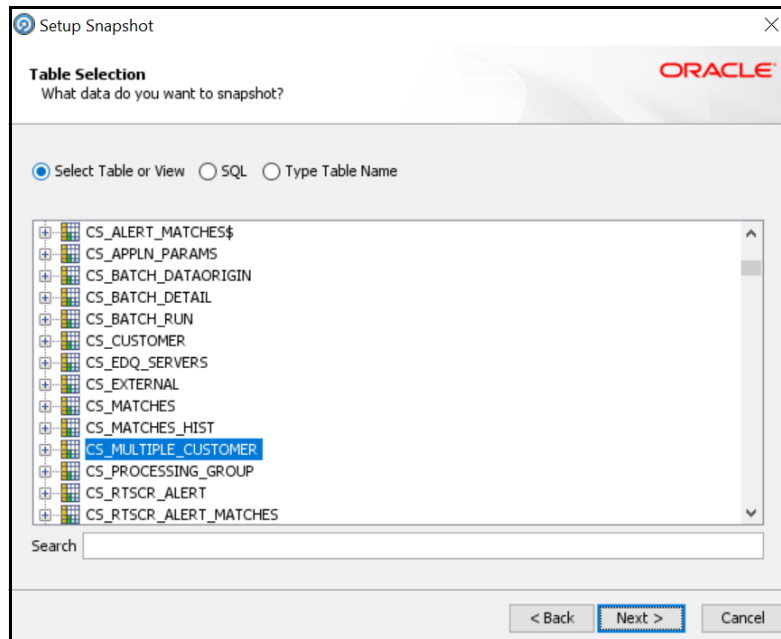

6. Click **Next** until you see the **Finish** button.
7. Click **Finish** to view a snapshot of the selected table in the **Results Browser**.

13 Appendix F: Configurations for the Bearer Token

- The following section takes you through the process of generating a token and using it to get the individual or entity JSON, depending on the API request. A token is used to authorize the request.
- You can begin by generating a password for the user who sends the request. After the password is generated, generate a token to authorize this request. The default time for token expiration is 3600 seconds (1 hour) and can be changed. To change the validity, see [Change Token Validity](#).

13.1 Generate User Password

To generate a password for the user, follow these steps:

1. Log in as a system administrator.
2. Click **System Configuration** in the **Administration** page and select **Configure Setup Access Token**. The **Configure Setup Access Token** window is displayed.

Figure 153: Administration Page

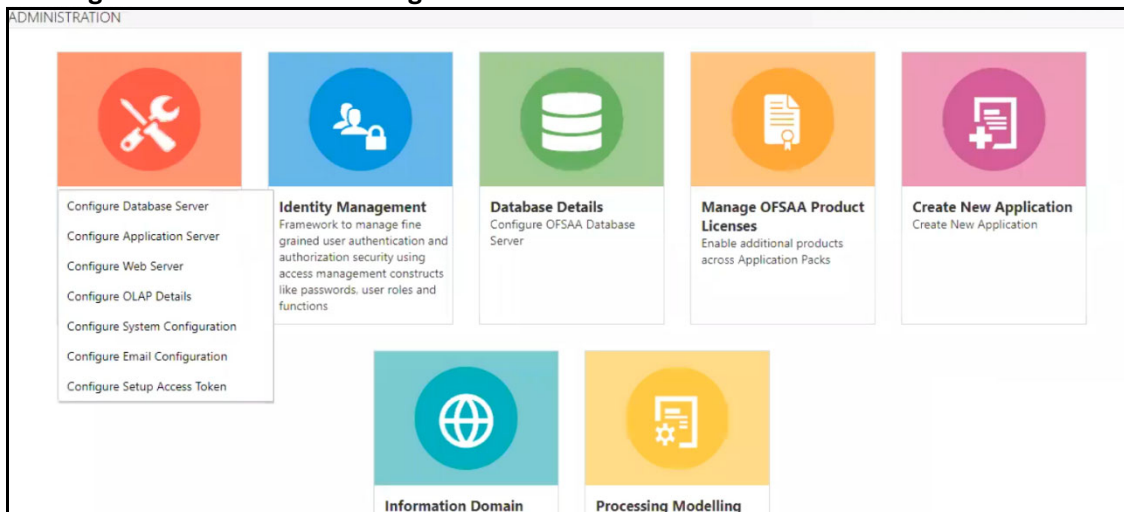

3. In the **Configure Setup Access Token** section, click **Add**. A new window is displayed.

Figure 154: Configure Setup Access Token

Configure Setup Access Token

Client Setup Name

Reset Search

Configure Setup Access Token

+ Add

Client Setup Name	Client Setup Access Token
KEY_REST_01	ce6d4b1a-6c2b-4e00-89df-a9f22853608d

4. Enter the username in the **Client Setup Name** field and click **Generate Token**. The token is displayed in the **Setup Access Token Details** section.

Figure 155: Generate Token Button

Configure Setup Access Token

* Client Setup Name

Generate Token Close

Setup Access Token Details

5. Copy and save the text generated in the **Setup Access Token Details** section.

Figure 156: Setup Access Token Details

Configure Setup Access Token

* Client Setup Name

Generate Token Close

Setup Access Token Details

STP_ACC_NM=KEY_REST_02
 STP_ENC_STR=S0VZX1JFU1RfMDi6MGVjNTRhNmEtODY2ZS00OWY2LWl0NWl0ODU3NGM2NTJhM2Uw
 STP_ACC_TKN=0ec54a6a-866e-49f6-b45b-8574c652a3e0

- The **STP_ACC_NM** field displays the username. The **STP_ACC_TKN** field displays the password.
6. Click **Close**  and log out as the system administrator.

13.2 Change Token Validity

To generate a password for the user, follow these steps:

1. Log in as a system administrator.
2. Click **System Configuration** in the **Administration** page and select **Configure System Configuration**. The **Configuration** window is displayed.

Figure 157: Administration Page

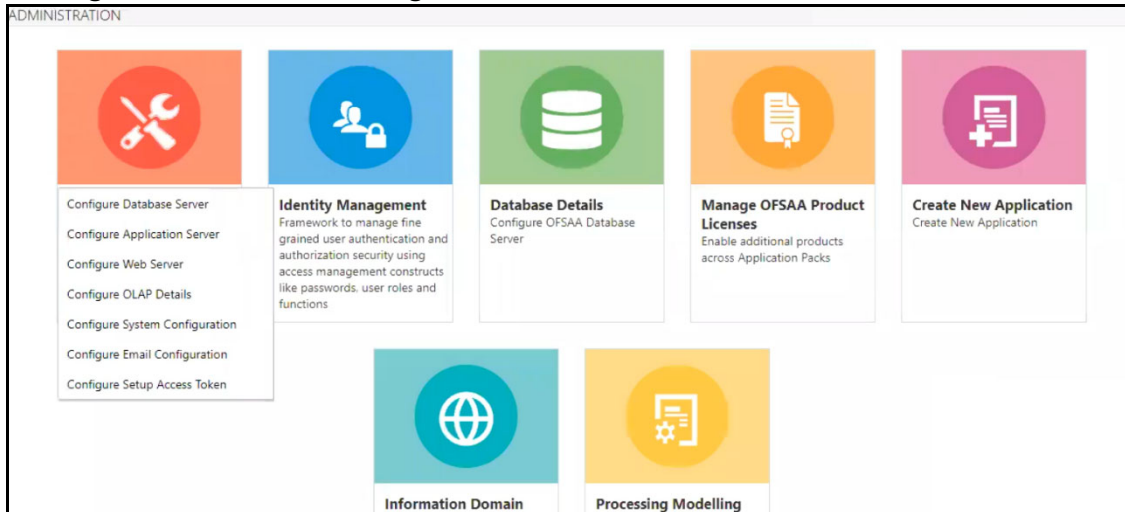

3. In the **Configuration** window, change the token validity time in the **API token validity** in **seconds** field.

Figure 158: Configuration window with the API token validity in seconds field shown

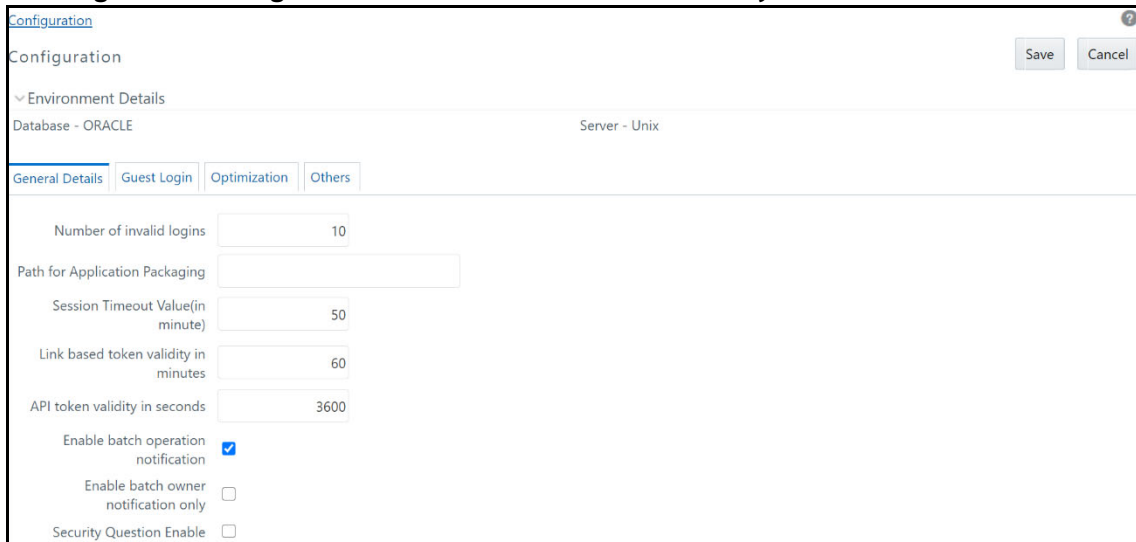

4. Click **Save**.

13.3 Generate Token

After the password is generated, you can generate the token. To generate the token, open your API client and follow these steps:

NOTE

- You may use the desktop version of the Postman client to perform these steps. Postman is an open-source, collaborative platform for API development. For more information, see [Postman Docs](#).
- You can also use any other API client, such as cURL. For more information, see [REST APIs for Oracle Database](#).
- In `weblogic server > Deployed > config.xml > after </node-manager-password-encrypted>`, you must add the tag `<enforce-valid-basic-auth-credentials>false</enforce-valid-basic-auth-credentials>`.

1. Open the Postman client and click **Create a request**.
2. Select the request type as **GET** and enter the request URL in the following format:

```
##APP_URL##/rest-api/auth/v1/token
```

Figure 159: Request

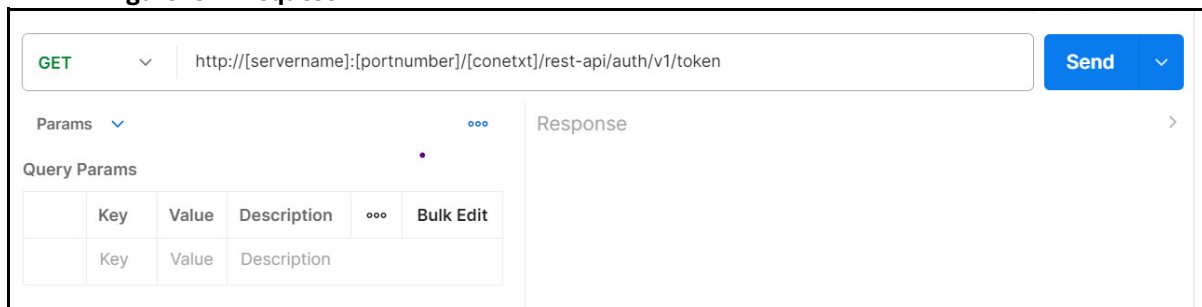

3. Select the **Authorization** menu and then select the **TYPE** as **Basic Auth**.

2. In the Postman client, select the request type as **POST** and enter the request URL in the following format:

```
http://[servername]:[portnumber]/[context]/rest-api/RTScreening/RTScreeningRestService/service/IndividualScreen/EntityScreen
```

Figure 162: Request

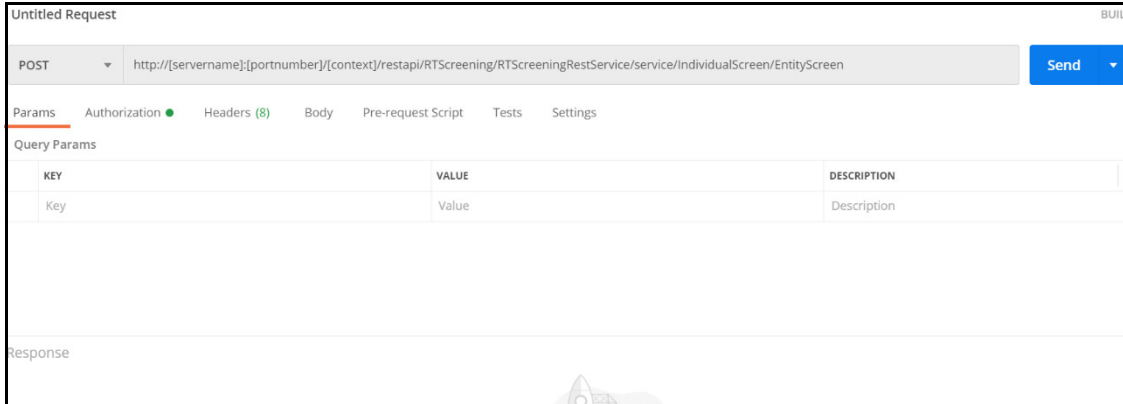

3. In the **Authorization** menu, select the **TYPE** as **Bearer Token**.

Figure 163: Authorization

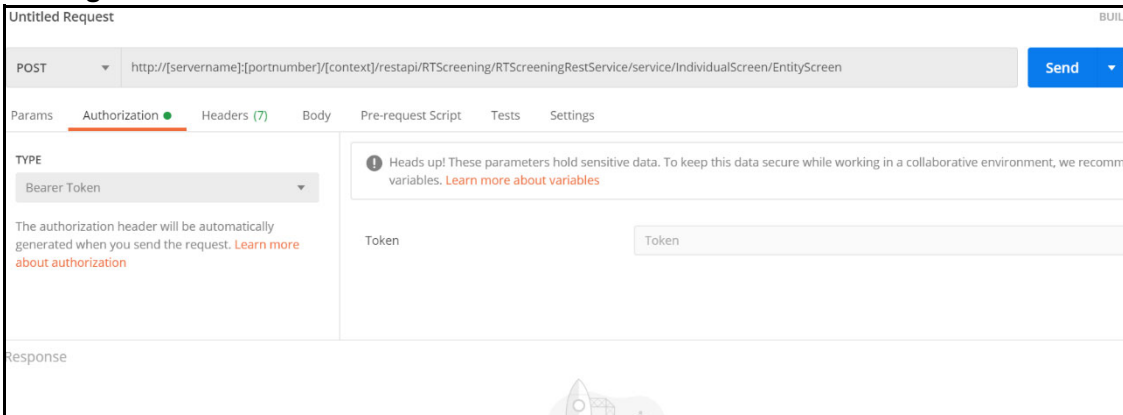

4. Paste the **token** generated in the **Token** field.
5. Click **Send**. The JSON is displayed in the **Response** field. A sample JSON is shown:

```
{
  "Jurisdiction": "AMEA",
  "BusinessDomain": "d",
  "FamilyName": "HAMMAD",
  "GivenNames": "Fathi Ahmad"
}
```

14 Appendix G: Error Logs

The following are the types of failures you may encounter:

- EDQ Failure
- Data Model Failure
- Batch Failure
- DM Utility Failure

14.1 EDQ Failure

If there is an EDQ failure, follow these steps.

1. Go to the following path, where the EDQ is installed.
`{domain_path}/servers/edq_server1/logs/edq/logs`
2. Open the file name (`main0.log`).
3. Rectify the errors that you find in the logs.

14.2 Data Model Failure

If there is a data model failure, follow these steps.

1. Go to the following path.
`{ftpshare_path}/{infodom}/logs`.
2. Check for the latest file and rectify the error according or raise an SR to support.

14.3 Batch Failure

If there is batch failure, follow these steps.

1. Go to the following path.
`{ftpshare_path}/logs/{BatchDate}/{infodom}/TRANSFORM DATA`.
2. Search for the log file with task ID. Rectify the relevant error.

14.4 DM Utility Failure

If there is DM Utility failure, follow these steps.

1. Log in to Atomic Schema and search for the table `FCC_DM_AUDIT`.
2. This table has all the logs for the current running batch.
3. Rectify the relevant error.

15 Appendix H: Out Of Box process to move Alerts from CS_ALERTS of one DB instance to FCC_ZCS_ALERTS of another DB instance

The `Oracle_CS_Zipper_Processing` run, present under the Run screen of Rule Run Framework, handles data movement from the `CS_ALERTS` to `FCC_ZCS_ALERTS`. It is configured to Out of Box (OOB) to move this data on the same instance.

The following are the steps to move data from one DB instance to another:

NOTE The following configurations must be done on the instance where the Zipper UI is present.

The `Oracle_CS_Zipper_Processing` run intern calls `Loading_Oracle_CS_Alerts` process, which is present under the Process screen of Rule Run Framework. This process is responsible for moving the `CS_ALERTS` data from the source system to the destination system.

1. Create a DB link in the Zipper UI database by giving the DB details of source system database details where `CS_ALERTS` are present.
2. Login with CS Admin in the Zipper UI instance and navigate to `Common Tasks > Rule Run Framework>Process`.
3. Select the check box for `Loading_Oracle_CS_Alerts` process name and click on **Edit**.
4. In the process details screen, you will see that in the parameters column, `SOURCENAME` and `LOADTYPE` is value is empty by default as shown in the below screenshot. Make sure to update these parameters with the following values.

SOURCE NAME: Enter the name of the DB link which is created in Step 1.

LOADTYPE: Enter the value as `DBLINK`.

Example: `"SOURCENAME=SOURCE1_DB_LINK_NAME","DATAMOVEMENTCODE=FCC_ZCS_CUST","LOADTYPE=DBLINK","DATAMOVEMENTOPERATION=IS"`.

Figure 164: Master Information

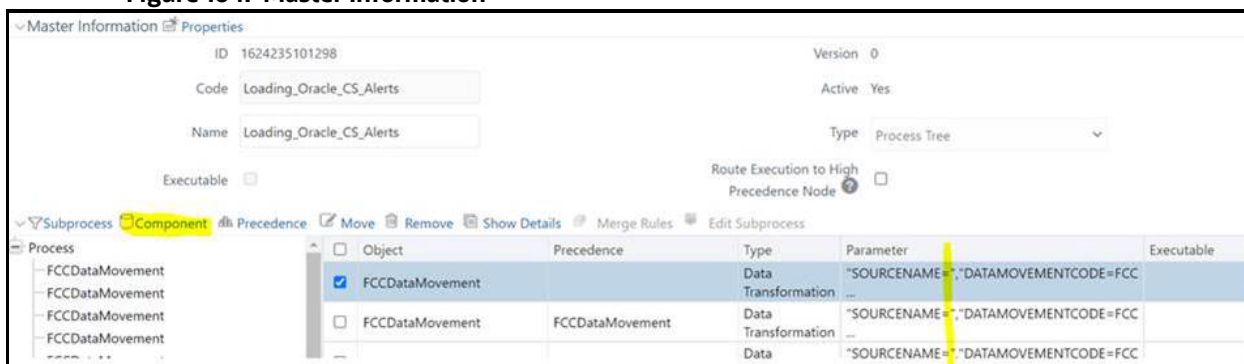

5. Click the **Component** button to edit the parameters.
6. In the **Component Selector** popup, on the **TASK** in the **ROOT** section on the right side, against each `FCCDataMovement`, click on the down arrow button to edit the parameters as shown in below screenshot.

Figure 165: Component Selector

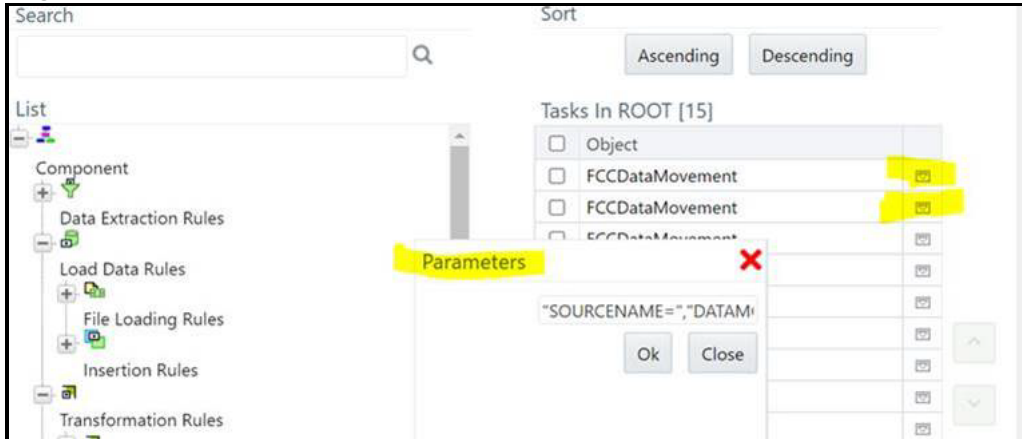

7. Give the value for `SOURCENAME` and `LOADTYPE` as suggested in Step d and click **OK** to save.
8. Update the above values mentioned in step 7 to all the `FCCDataMovement` where `SOURCENAME` and `LOADTYPE` are empty.
9. Now, if you create a batch out `Oracle_CS_Zipper_Processing` run in ZIPPER UI Instance and execute it, it will pull the `CS_ALERTS` from the source system and create a zipper alert Zipper UI instance.

The following are the steps to pull data from multiple source systems in the zipper UI instance:

- a. Enter a DB details of source system database where `CS_ALERTS` are present to create a DB link in the Zipper UI database for each source system.
- b. Login as a CS Admin in the Zipper UI instance and navigate to `Common Tasks>Rule Run Framework>Process`.
- c. Select the check box for `Loading_Oracle_CS_Alerts` process name and click **Copy** to create a copy. Create the copies for all source systems.
- d. Now, select Individual Process and click **Edit** and follow the above steps from 4 to 7 and give the respective **SOURCENAME** value and **LOADTYPE** as `DBLINK`.
- e. Navigate to `Common Tasks>Rule Run Framework>Run`.
- f. Select the check box for `Oracle_CS_Zipper_Processing` run name and click **Copy** to create a copy.
- g. In the RUN details, enter a Folder name and give a different name for Code and Name fields.
- h. Click on the **Selector** button and then select **Job**.
- i. From the tasks section on the right side, remove the `Loading_Oracle_CS_Alerts`, map the respective process created for a particular source system, and click **OK**.
- j. Verify the **Run Details** screen to see processes are mapped correctly and proceed to finish the steps to complete copying of process.
- k. Create a different run for each source system by following the above steps from Step vi to x.
- l. Now, if you create a batch out individual source system runs created in ZIPPER UI Instance and execute it, it will pull the `CS_ALERTS` from the respective source system and create zipper alert in Zipper UI instance.

16 Appendix I: API to create the Alerts in the Zipper Alerts table (FCC_ZCS_ALERTS)

Multiple CS Instances are used for an ad-hoc Screening of Customer and External Entity from the Real-time Screening UI. Following are the steps to configure these systems to create zipper alerts in separate Zipper UI Instances:

1. Navigate to `##FIC_HOME##/ficdb/bin` folder of CS instance, used for ad-hoc screening of Customer and External Entity from Real-time Screening UI.
2. Execute `EDQInsert.sh` bypassing `infodom` along with it.
Example: `./EDQInsert.sh TFLTINFO`
3. Initially, enter the EDQ server details.
4. If you want to use the **Enterprise Case Management Application (ECM)** or **Customer Screening Alert Management (CSAM)** as an L1 investigation for Real-Time Screening, enter CSAM.
5. Enter the URL of the Zipper UI instance used for Zipper alerts, and if the **Customer Screening Alert Management (CSAM)** application is in the same installation, enter **N**.
6. Enter the user name and password to access the Zipper UI instance URL.
7. Now, if you perform an ad-hoc screening of Customer and External Entity from Real-time Screening UI from CS instance, it will create zipper alerts in Zipper UI instance.
8. Follow the above steps 1 to 7 in all the multiple CS instances used for ad-hoc screening of Customer and External entity from Real-time Screening UI.

NOTE

The source systems are configured with the **Rest URL** of the CS Instance used for ad-hoc screening of Customer and External Entity from the Real-time Screening UI. In this case, it will still use the same configuration done in the above steps 1 to 7 and creates zipper alerts in the Zipper UI instance.

17 Appendix J: PMF Configurations for Pool of Analyst

To configure the PMF Pool of Analyst configuration to set the new statuses, follow these steps:

1. Perform the following queries and introduce new status in the following tables.
 - `Select t.*,rowid from AAI_WF_STATUS_B t where t.v_app_package_id in ('OFS_CS_RT');`
 - `Select t.*,rowid from AAI_WF_STATUS_TL t where t.v_app_package_id in ('OFS_CS_RT');`
 - Create unique `v_status_id` in `AAI_WF_STATUS_B` table and map the same in the `AAI_WF_STATUS_TL` table and fill all the other columns data. This data will show in the PMF screen while mapping new status.

Figure 166: Example 1

The screenshot shows a SQL query editor with the following query:

```
select t.*, rowid from AAI_WF_STATUS_B t where t.v_app_package_id in ('OFS_CS_RT');
```

The results are displayed in a table with the following columns: V_STATUS_ID, V_APP_PACKAGE_ID, and ROWID.

V_STATUS_ID	V_APP_PACKAGE_ID	ROWID
1 301	OFS_CS_RT	AAPSIeABHAAAHzABG
2 302	OFS_CS_RT	AAPSIeABHAAAHzABH
3 303	OFS_CS_RT	AAPSIeABHAAAHzABI
4 307	OFS_CS_RT	AAPSIeABHAAAHzABJ
5 309	OFS_CS_RT	AAPSIeABHAAAHz2AAB

The screenshot shows a SQL query editor with two queries:

```
select t.*, rowid from AAI_WF_STATUS_B t where t.v_app_package_id in ('OFS_CS_RT');
```

```
select t.*,rowid from AAI_WF_STATUS_TL t where t.v_app_package_id in ('OFS_CS_RT');
```

The results are displayed in a table with the following columns: V_STATUS_ID, V_STATUS_NAME, V_STATUS_DESC, V_LOCALE_CODE, V_APP_PACKAGE_ID, and ROWID.

V_STATUS_ID	V_STATUS_NAME	V_STATUS_DESC	V_LOCALE_CODE	V_APP_PACKAGE_ID	ROWID
1 301	Investigation	Investigation	en_US	OFS_CS_RT	AAPSD/ABHAAAEqLABZ
2 302	Pending Review	Pending Review	en_US	OFS_CS_RT	AAPSD/ABHAAAEqLABa
3 303	Closed - False Positive	Closed - False Positive	en_US	OFS_CS_RT	AAPSD/ABHAAAEqLABb
4 307	Closed - True Match Exit Required	Closed - True Match Exit Required	en_US	OFS_CS_RT	AAPSD/ABHAAAEqLABc
5 309	Pending Test Review	Pending Test Review	en_US	OFS_CS_RT	AAPSD/ABHAAAEqOAAA

2. Perform the following query and introduce new Outcome in both the following tables.

- Select t.*, rowid from AAI_WF_OUTCOME_B t;
- Select t.*, rowid from AAI_WF_OUTCOME_TL t;
- Create unique outcome id in AAI_WF_OUTCOME_B table and map the same in AAI_WF_OUTCOME_TL table and provide other columns data.

Figure 167: Example 2

Select t.*, rowid from AAI_WF_OUTCOME B t;

Query Result x
All Rows Fetched: 19 in 0.05 seconds

V_OUTCOME_ID	ROWID
7 12	AAPSIqABHAAAJ4DAAM
8 2	AAPSIqABHAAAJ4DAAN
9 21	AAPSIqABHAAAJ4DAAA
10 22	AAPSIqABHAAAJ4DAAB
11 23	AAPSIqABHAAAJ4DAAC
12 24	AAPSIqABHAAAJ4DAAD
13 25	AAPSIqABHAAAJ4DAAE
14 26	AAPSIqABHAAAJ4DAAF
15 3	AAPSIqABHAAAJ4DAAO
16 309	AAPSIqABHAAAJ4GAAB
17 4	AAPSIqABHAAAJ4DAAP
18 5	AAPSIqABHAAAJ4DAAQ
19 96	AAPSIqABHAAAJ4GAAA

Select t.*, rowid from AAI_WF_OUTCOME_TL t;

Query Result x
All Rows Fetched: 19 in 0.05 seconds

V_OUTCOME_ID	V_OUTCOME_NAME	V_OUTCOME_DESC	V_LOCALE_CODE	ROWID
7 113	Pending Approval	Pending Approval	en_US	AAPSVAAA1AAAQ1zAAG
8 112	False Positive	False Positive	en_US	AAPSVAAA1AAAQ1zAAH
9 111	Confirmed Match	Confirmed Match	en_US	AAPSVAAA1AAAQ1zAAI
10 1	Auto Release	Auto Release	en_US	AAPSVAAA1AAAQ1zAAJ
11 2	Hold	Hold	en_US	AAPSVAAA1AAAQ1zAAK
12 3	Investigation	Investigation	en_US	AAPSVAAA1AAAQ1zAAL
13 4	Escalate	Escalate	en_US	AAPSVAAA1AAAQ1zAAM
14 5	Block	Block	en_US	AAPSVAAA1AAAQ1zAAN
15 12	Release	Release	en_US	AAPSVAAA1AAAQ1zAAO
16 10	Reject	Reject	en_US	AAPSVAAA1AAAQ1zAAP
17 11	Recommend To Block	Recommend To Block	en_US	AAPSVAAA1AAAQ1zAAP
18 96	Recommend To Release	Recommend To Release	en_US	AAPSVAAA1AAAQ1zAAQ
19 309	Pending Review	Pending Review	en_US	AAPSVAAA1AAAQ1zAAA
	Pending Test Review	Pending Test Review	en_US	AAPSVAAA1AAAQ1zAAB

- In the atomic schema, do the configuration for the following tables:

```
Select t.*,rowid from FCC_ZCS_STATUS_dim t;
```

```
Select V_STATUS_CODE, V_STATUS_CODE from fcc_zcs_status_dim;
```

Figure 168: Example 3

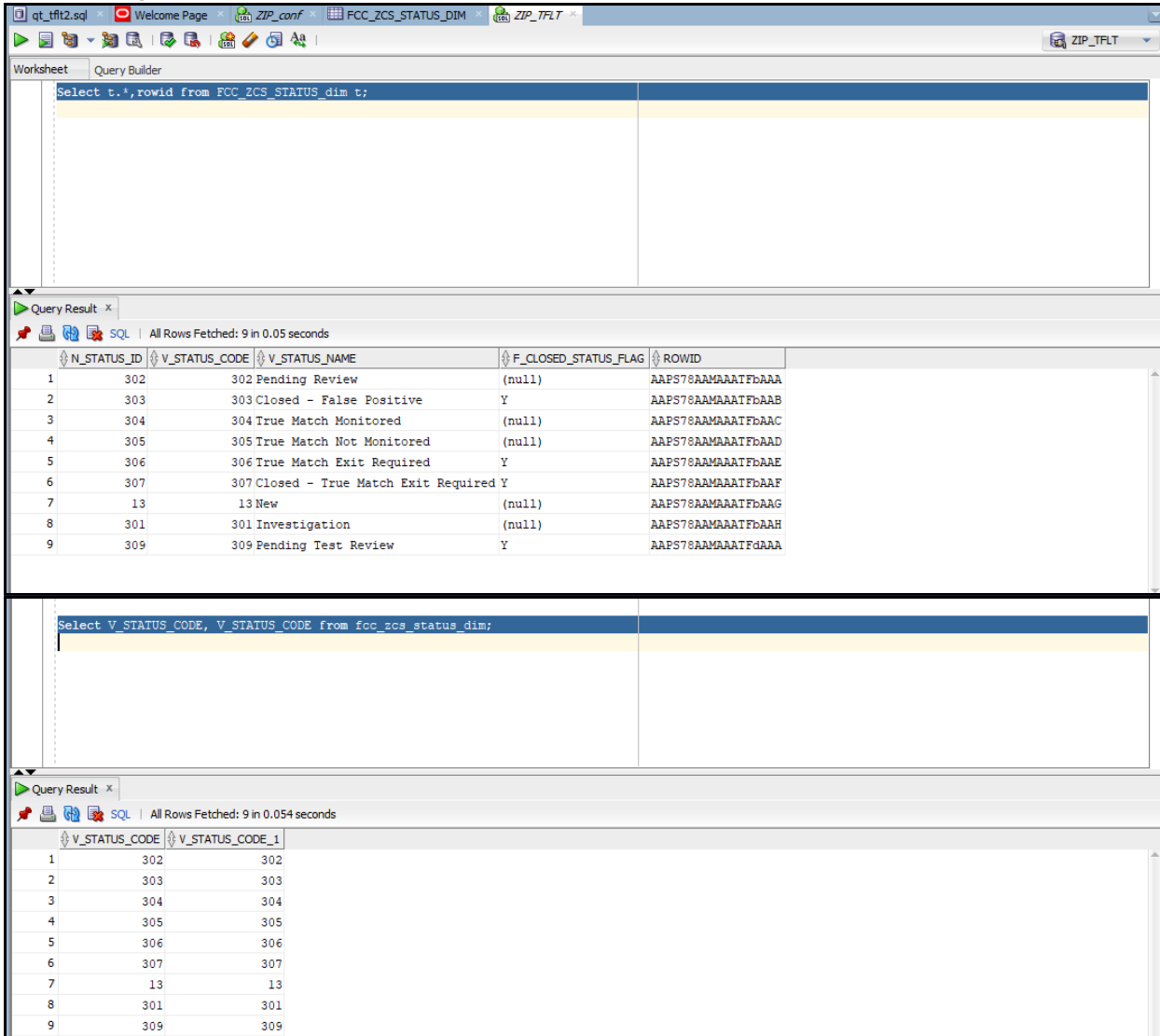

4. In the following table do the security attribute mapping for the new workflow:

```
Select t.*, rowid from FCC_ZCS_SECURITY_ATTR_GRP_MAP t;
```

In the following table, add the two entries:

```
Select * from cs_appln_params;
```

For the entry ZCS_ENBL_ANALYST_POOL, the value must be Y and for the entry POA_CHECK_STS_CODES, add the status code of the newly created status.

5. Create Human task in PMF screen that you want to introduce in-between existing status or you want to introduce new status or create separate status.

Activity

Activity Name*

Activity Description

Status* - New Status Name.

Outcomes - Where has to go (Destination Status).

Example: **If we have to introduce a new status between Investigation to Pending Review, first add the new activity as shown in the following Figures (Pending Test Review).**

Figure 169: Activity Statuses

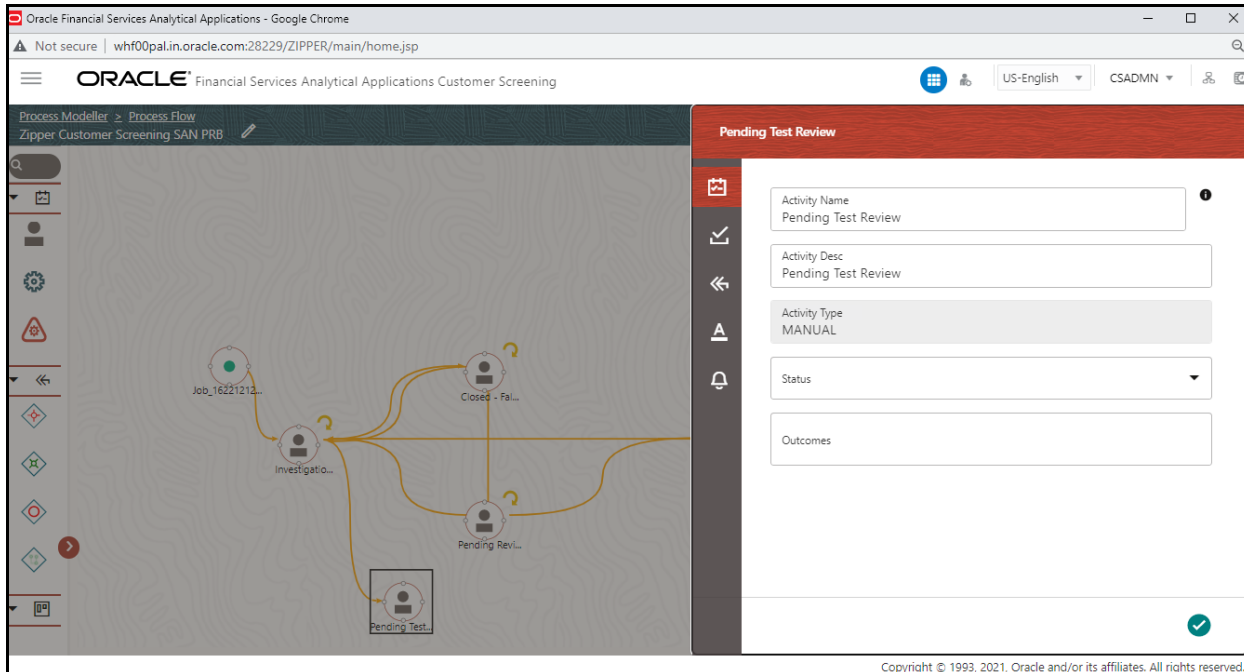

Transitions

Add ->

Transition Name - Unique Name for the particular Transition.

Connected To – Destination status.

Decision Rule - Map to decision rule for particular status.

Order - 1

Stroke – Default.

Example: First Transition between **Investigation** to **Pending Test Review** the next one between **Pending Test Review** and **Pending Review**.

Figure 170: Edit Transaction – Pending Test Review

The screenshot displays the Oracle Financial Services Analytical Applications Customer Screening interface. On the left, a process flow diagram shows a transition from 'Investigation' to 'Pending Test Review'. The right-hand pane is titled 'Edit Transition Job_1622121272870_JOB_16469118750280'. The configuration fields are as follows:

Transition Name	Investigation to Pending Test Review
Connected To	Pending Test Review
Stroke	Normal
Order	1
Decision Rule	Rule_Investigation_to_Pending Test Review

A green checkmark is visible at the bottom right of the configuration pane, indicating the transition is saved. The footer contains the text: 'Copyright © 1993, 2021, Oracle and/or its affiliates. All rights reserved.'

Figure 171: Edit Transition – Pending Review

The screenshot displays the Oracle Financial Services Analytical Applications Customer Screening interface. On the left, the same process flow diagram is shown. The right-hand pane is titled 'Edit Transition JOB_16469118750280_JOB_1622446950311'. The configuration fields are as follows:

Transition Name	Pending Test Review to Pending Review
Connected To	Pending Review
Stroke	Normal
Order	1
Decision Rule	Rule_Test_Pending_Review_to_Pending_Review

A green checkmark is visible at the bottom right of the configuration pane, indicating the transition is saved. The footer contains the text: 'Copyright © 1993, 2021, Oracle and/or its affiliates. All rights reserved.'

In Transition Decision Rule Map the specified rule for the current status. Or create as per business requirement.

Example: For the decision rules, add the following 2 decision rules.

Figure 172: Rule Details – Decision Rule 1

The screenshot shows the Oracle Financial Services Analytical Applications interface. On the left, a process flow diagram is visible with nodes labeled 'Job_16221212...', 'Investigatio...', 'Closed - Pa...', 'Pending Rev...', and 'Pending Test...'. The main area on the right is titled 'Application Rule' and contains the following configuration fields:

- Add** (button)
- Application Rule Type** (dropdown menu)
- Attribute Expressions** (dropdown menu)
- Name** (text input): Rule_Investigation_to_Test_Pending_Review
- Rule Type** (dropdown menu): Decision Rule
- Execution Type** (dropdown menu): Attribute Expressions
- Attribute** (dropdown menu): CS_STATUS
- CS_ACTION_CODE** (text input): value

Copyright © 1993, 2021, Oracle and/or its affiliates. All rights reserved.

The screenshot shows the Oracle Financial Services Analytical Applications interface. On the left, a process flow diagram is visible with nodes labeled 'Job_16221212...', 'Investigatio...', 'Closed - Pa...', 'Pending Rev...', and 'Pending Test...'. The main area on the right is titled 'Application Rule' and contains the following configuration fields:

- Attribute** (dropdown menu): CS_ROLE_CODE
- CS_ACTION_CODE** (text input): value PENDING_TEST_REVIEW x
- CS_STATUS** (text input): value 301 x
- ZP_POOL_ANALYST_FL** (text input): value Y x
- CS_ROLE_CODE** (text input): value CSANLYST x

Copyright © 1993, 2021, Oracle and/or its affiliates. All rights reserved.

Figure 173: Rule Details – Decision Rule 2

Application Rule

 Pending Test Review to Pending Review

Name
Pending Test Review to Pending Review

Rule Type
Decision Rule

Execution Type
Attribute Expressions

Attribute
ZP_POA_LOGGED_USER_ACTED_FIRST 

- CS_ROLE_CODE
- CS_STATUS
- ZP_LOGGED_USER_ACTED
- ZP_POOL_ANALYST_FL
- CS_JURISDICTION
- CS_BUSINESS_DOMAIN
- ZP_POA_LOGGED_USER_ACTED_FIRST 

Application Rule

Name
Pending Test Review to Pending Review

Rule Type
Decision Rule

Execution Type
Attribute Expressions

Attribute
CS_ACTION_CODE +

ZP_POOL_ANALYST_FL ✕

CS_ROLE_CODE ✕

CS_STATUS ✕

ZP_POA_LOGGED_USER_ACTE ✕

CS_ACTION_CODE ✕

✓

Edit the existing decision rule, by adding the ZP_POOL_ANALYST_FL.

17.1 List of Attributes Passed to Workflow

Table 6 provides the list of Attributes passed to workflow:

Table 6: Attributes Passed to Workflow

Attributes	Description
CS_ROLE_CODE	Logged in User.
CS_STATUS	Status code.
TF_ALERT TYPE	Alert type of the message (1 or 2).

Table 6: Attributes Passed to Workflow

Attributes	Description
ZP_POOL_ANALYST_FL	Allowed values are Y/N based on the CS_appln_params Configuration.
ZP_POA_LOGGED_USER_ACTED_FIRST	If the Logged in User is the user who performed the first action on the POA status, then the value of ZP_POA_LOGGED_USER_ACTED_FIRST is Y else it's N.

17.2 Attribute to Configure the Auto Refresh in Queue Management

Table 7 provides the list of Attribute to configure the Auto Refresh in Queue Management:

Table 7: Q_AUTO_REFRESH_TIME Attribute

Attributes	Description
Q_AUTO_REFRESH_TIME	Provide the time in mille second for the attribute in CS_APPLN_PARAMS table. By default it's 25000 i.e 25 seconds but the value is editable.

18 Appendix K: Invoking the PMF Workflow from backend

This appendix describes invoking the Process Modeller Framework (PMF) workflow from the backend for the alert.

Table1 provides the PMF workflow invoking parameters.

Table 1: PMF Workflow Invoking Parameters

Parameter Name	Parameter Description
Object ID	This represents the unique object ID. For Sanctions, the object ID can be alert ID or Good Guy Whitelist ID.
Object Type	This represents the object type for the object ID. For Sanctions, the object type will be 301 for alert and 302 for Good Guy Whitelist.
Infodom	This represents the name of the infodom in which Sanctions are installed.
Segment	This represents the name of the segment. For Sanctions, it will be TFLSEGMENT .
User ID	This represents the User ID that is triggering the workflow. Pass the value as SYSTEM .
Locale	This represents the locale. Pass the value as en_US .
Application Params	This represents the list of workflow data fields with their respective value.
Security Params	This represents the list of workflow security data fields with their respective value.

To trigger the workflow for Sanctions Alerts, follow the below code snippet.

```

DECLARE

lv_infodom  varchar2(4000);
lv_segment  varchar2(4000);
TYPE alert_record_ids IS TABLE OF fsi_rt_alerts.n_grp_msg_id%TYPE;
l_alert_record_ids alert_record_ids;
appParams          array_varchar := array_varchar();
secMap             array_varchar := array_varchar();

BEGIN

appParams.extend();
appParams(1) := 'TF_ACTION=MANUAL_CLOSE';
appParams.extend();
appParams(2) := 'Role=SYSTEM';
select t.v_attribute_value1

```

```
    into lv_infodom
    from setup_rt_params t
    where t.v_param_name = 'TFLT_INFODOM';
select t.v_attribute_value1
    into lv_segment
    from setup_rt_params t
    where t.v_param_name = 'TFLT_SEGMENT';
select t.n_grp_msg_id bulk collect
    into l_alert_record_ids
    from fsi_rt_alerts t
    where t.n_status_cd in (1,2);
FOR recId IN 1 .. l_alert_record_ids.COUNT loop
    startWorkflowForExpireRecord(l_alert_record_ids(recId),
                                '301',
                                lv_infodom,
                                lv_segment,
                                'SYSTEM',
                                'en_US',
                                appParams,
                                secMap);

end loop;

EXCEPTION
    WHEN OTHERS THEN
        dbms_output.put_line(SQLCODE || SQLERRM);
        ROLLBACK;

END;
```

19 Appendix L: Mapping the PMF Workflow for Different Jurisdiction and domain

The `AAI_WF_APP_DEFINITION_MAP` table in Config Schema stores the mapping of object type data to the process Modeller Framework (PMF) workflow that is to be used.

The `AAI_WF_APP_DEFINITION_MAP` table also captures the values for crucial business decisions such as jurisdiction and business domain.

To map a particular workflow to an object type for a combination of jurisdiction and business domain follow these steps:

1. Insert `V_KBD_1` and `V_KBD_2` columns values into the `AAI_WF_APP_DEFINITION_MAP` table.

NOTE

`V_KBD_1` represents Jurisdiction code and `V_KBD_2` represents Business Domain code.

2. Restart the web server after inserting the values into `AAI_WF_APP_DEFINITION_MAP` table.

20 **Appendix M: User Group Customization**

When a new user group for Customer Screening is created from Oracle Financial Services Analytical Applications (OFSAA) user Interface (UI), you must insert an entry in the `CSSMS_GROUP_MAST_PACK` table manually with the product id `OFS_CS`.

21 Appendix N: Adding New Alert Level Action and Standard Comments

To Add new Alert level action in the alert decision follow the subsequent steps:

1. Access the atomic schema in database.
2. Add new entries in the following tables:
 - `fcc_zcs_alert_actions_dim`
 - `fcc_zcs_alert_actions_tl`

For example, to add a new alert decision, provide an entry in the `fcc_zcs_alert_actions_dim` and `fcc_zcs_alert_actions_tl` with action code, name and description.

Figure 1: `fcc_zcs_alert_actions_dim` Table

@N_ACTION_ID	@V_ACTION_CD	@V_ACTION_NAME	@V_ACTION_DESC
1	1RECOMMEND_TM	Recommend True Match	Recommend True Match
2	2CLOSE_FP	Close as False Positive	Close as False Positive
3	3REJECT_RECOMMEND	Reject Recommend	Reject Recommend
4	4REJECT_RECOMMEND_CLOSE_FP	Reject Recommend - Close as False Positive	Reject Recommend - Close as False Positive
5	5APPROVE_RECOMMEND	Approve Recommend	Approve Recommend
6	6CONFIRM_TM_MONITORED	Confirm True Match Monitored	Confirm True Match Monitored
7	7CONFIRM_TM_NOT_MONITORED	Confirm True Match Not Monitored	Confirm True Match Not Monitored
8	8CONFIRM_EXIT_REQUIRED	Confirm Exit Required	Confirm Exit Required
9	9REOPEN	Re-open	Re-open
10	10DO_NOT_MONITOR	Do Not Monitor	Do Not Monitor
11	11PROMOTE_TO_CASE	Promote To Case	Promote To Case
12	12CAE30	Close as True Match	Close as True Match
13	13CAE31	Close as False Positive	Close as False Positive

3. If you require any validation for the newly added alert level action before taking action, provide an entry in the following tables:
 - `FCC_ZCS_ALERT_ACTIONS_MSG_DIM`
 - `FCC_ZCS_ALERT_ACTIONS_MSG_TL`

To add new standard comments for the alert action, follow the subsequent steps:

1. Access the atomic schema in database.
2. Add new entries in the following table:
 - For simply adding new standard comments in the application:
 - `fcc_san_std_cmnts_dim`
 - `fcc_san_std_cmnts_tl`
 - For mapping a newly added standard comment to event/alert in the application:
 - `fcc_san_std_cmnts_entity_map`

- For mapping a newly added standard comment to an existing action in the application:
 - `fcc_san_scmnts_entity_actn_map`

22 Appendix O: CS and ECM Table Mapping for Alert Status Customization

When L2 Investigation is enabled and if there is any customization of the alert workflow (status, action, or standard comments) done to the Customer Screening (CS) dimension tables listed in [Table 1](#), then update the same data in the corresponding ECM dimension table. As a result Alert summary for the escalated case will be visible in Enterprise Case Management (ECM) application.

[Table 1](#) provides the list CS dimensions tables and corresponding ECM dimension table.

Table 1: CS and ECM Dimension Tables

CS Dimension Tables	ECM Dimension Tables
FCC_ZCS_STATUS_DIM	FCC_CS_CM_STATUS_DIM
FCC_ZCS_STATUS_TL	FCC_CS_CM_STATUS_TL
FCC_ZCS_ALERT_PRIORITY_DIM	FCC_CS_CM_ALERT_PRIORITY_DIM
FCC_ZCS_ALERT_PRIORITY_TL	FCC_CS_CM_ALERT_PRIORITY_TL
FCC_ZCS_SCREENING_MODE_DIM	FCC_CS_CM_SCREENING_MODE_DIM
FCC_ZCS_SCREENING_MODE_TL	FCC_CS_CM_SCREENING_MODE_TL
FCC_ZCS_ALERT_TYPE_DIM	FCC_CS_CM_ALERT_TYPE_DIM
FCC_ZCS_ALERT_TYPE_TL	FCC_CS_CM_ALERT_TYPE_TL
FCC_SAN_ALERT_STD_CMNTS_MAP	FCC_CS_ESC_AL_STDCMNTS
FCC_SAN_STD_CMNTS_DIM	FCC_CS_CM_SAN_STD_CMNTS_DIM
FCC_SAN_STD_CMNTS_TL	FCC_CS_CM_SAN_STD_CMNTS_TL
FCC_ZCS_ALERT_ACTIONS_DIM	FCC_CS_CM_ALERT_ACTIONS_DIM
FCC_ZCS_ALERT_ACTIONS_TL	FCC_CS_CM_ALERT_ACTIONS_TL
FCC_ZCS_EVENT_STATUS_DIM	FCC_CS_CM_EVENT_STATUS_DIM
FCC_ZCS_EVENT_STATUS_TL	FCC_CS_CM_EVENT_STATUS_TL
FCC_SAN_EVENTS_STD_CMNTS_MAP	FCC_CS_ESC_EVNT_STDCMNTS
FCC_ZCS_MATCH_RULE_DIM	FCC_CS_CM_MATCH_RULE_DIM
FCC_ZCS_MTCH_RULE_ENT_ATTR_MAP	FCC_CS_CM_MTCH_RULE_ENT_ATTRMAP
FCC_ZCS_ENTITY_ATTR_DIM	FCC_CS_CM_ENTITY_ATTR_DIM
FCC_ZCS_MTCH_RULE_WLS_ATTR_MAP	FCC_CS_CM_MTCH_RULE_WLS_ATTRMAP
FCC_SAN_SCMNTS_ENTITY_ACTN_MAP	FCC_CSCM_SCMNTS_ENT_ACTN_MAP
FCC_SAN_STD_CMNTS_ENTITY_MAP	FCC_CSCM_STD_CMNTS_ENT_MAP

23 Appendix P: Configurations Required to Open ECM Case or CSAM Alert from RT Screening if RT Screening and ECM/CSAM are in Different Servers

Perform the following configuration to open Enterprise Case Management (ECM) Case or Customer Screening Alert Management (CSAM) Alert from Real-time (RT) Screening if RT Screening and ECM/CSAM are in Different Servers.

23.1 Configure REFERRER-POLICY-ENABLED

The valid V_PROP_VALUE values are TRUE or FALSE. The default is FALSE.

Configure this value to TRUE to allow Referrer URLs.

```
MERGE INTO aai_setup_props ut
USING (
SELECT 'REFERRER-POLICY-ENABLED' AS V_PROP_NAME FROM dual
) md ON (ut.V_PROP_NAME = md.V_PROP_NAME)
WHEN NOT MATCHED THEN
INSERT (V_PROP_NAME,V_PROP_VALUE,V_PROP_TIER,V_SEEDED_BY)
VALUES ('REFERRER-POLICY-ENABLED', 'FALSE', 'WEB', 'AAI')
/
```

23.2 Configure ALLOWED-REFERRER-URLS

By default V_PROP_VALUE is set to NONE.

Configure this value to set the HOST URL (Real time CS URL) as the allowed URL in the following format:

```
http://<HOST_NAME>:<PORT_NUMBER>/
```

Separate the URLs with a single space. Adding the URLs without a space between them or adding two or more spaces between them results in errors.

Run the following query after replacing the <Referral-URLs> with the suitable values.

```
MERGE INTO aai_setup_props ut
USING (
SELECT 'ALLOWED-REFERRER-URLS' AS V_PROP_NAME FROM dual
) md ON (ut.V_PROP_NAME = md.V_PROP_NAME)
WHEN NOT MATCHED THEN
INSERT (V_PROP_NAME,V_PROP_VALUE,V_PROP_TIER,V_SEEDED_BY)
VALUES ('ALLOWED-REFERRER-URLS', '<Referral-URLs>', 'WEB', 'AAI')
/
```

OFSAA Support

Raise a Service Request (SR) in [My Oracle Support \(MOS\)](#) for queries related to the OFSAA applications.

Send Us Your Comments

Oracle welcomes your comments and suggestions on the quality and usefulness of this publication. Your input is an important part of the information used for revision.

- Did you find any errors?
- Is the information clearly presented?
- Do you need more information? If so, where?
- Are the examples correct? Do you need more examples?
- What features did you like most about this manual?

If you find any errors or have any other suggestions for improvement, indicate the title and part number of the documentation along with the chapter/section/page number (if available) and contact the Oracle Support.

Before sending us your comments, you might like to ensure that you have the latest version of the document wherein any of your concerns have already been addressed. You can access My Oracle Support site which has all the revised/recently released documents.

