

Core Services User Guide

# Oracle FLEXCUBE Universal Banking

Release 12.87.04.0.0

Part No. E92710-01

Core Services User Guide  
Oracle Financial Services Software Limited

Oracle Park

Off Western Express Highway  
Goregaon (East)  
Mumbai, Maharashtra 400 063  
India

Worldwide Inquiries:

Phone: +91 22 6718 3000

Fax: +91 22 6718 3001

[www.oracle.com/financialservices/](http://www.oracle.com/financialservices/)

Copyright © 2007, 10/1/18, Oracle and/or its affiliates. All rights reserved.

Oracle and Java are registered trademarks of Oracle and/or its affiliates. Other names may be trademarks of their respective owners.

U.S. GOVERNMENT END USERS: Oracle programs, including any operating system, integrated software, any programs installed on the hardware, and/or documentation, delivered to U.S. Government end users are "commercial computer software" pursuant to the applicable Federal Acquisition Regulation and agency-specific supplemental regulations. As such, use, duplication, disclosure, modification, and adaptation of the programs, including any operating system, integrated software, any programs installed on the hardware, and/or documentation, shall be subject to license terms and license restrictions applicable to the programs. No other rights are granted to the U.S. Government.

This software or hardware is developed for general use in a variety of information management applications. It is not developed or intended for use in any inherently dangerous applications, including applications that may create a risk of personal injury. If you use this software or hardware in dangerous applications, then you shall be responsible to take all appropriate failsafe, backup, redundancy, and other measures to ensure its safe use. Oracle Corporation and its affiliates disclaim any liability for any damages caused by use of this software or hardware in dangerous applications.

This software and related documentation are provided under a license agreement containing restrictions on use and disclosure and are protected by intellectual property laws. Except as expressly permitted in your license agreement or allowed by law, you may not use, copy, reproduce, translate, broadcast, modify, license, transmit, distribute, exhibit, perform, publish or display any part, in any form, or by any means. Reverse engineering, disassembly, or decompilation of this software, unless required by law for interoperability, is prohibited.

The information contained herein is subject to change without notice and is not warranted to be error-free. If you find any errors, please report them to us in writing.

This software or hardware and documentation may provide access to or information on content, products and services from third parties. Oracle Corporation and its affiliates are not responsible for and expressly disclaim all warranties of any kind with respect to third-party content, products, and services. Oracle Corporation and its affiliates will not be responsible for any loss, costs, or damages incurred due to your access to or use of third-party content, products, or services.



---

# Contents

<b>1. Preface .....</b>	<b>1-1</b>
1.1 Introduction.....	1-1
1.2 Audience.....	1-1
1.3 Documentation Accessibility.....	1-1
1.4 Organization .....	1-1
1.5 Related Documents .....	1-3
1.6 Glossary of Icons.....	1-3
<b>2. Bank Parameters .....</b>	<b>2-1</b>
2.1 Defining Bank Level Parameters .....	2-1
2.1.1 <i>Maintaining Financial Preferences</i> .....	2-2
2.1.2 <i>Generating Automatic Balancing Entries</i> .....	2-3
2.1.3 <i>Maintaining General Preferences</i> .....	2-4
2.1.4 <i>Placing User Restrictions on Data Entry Batches</i> .....	2-7
2.1.5 <i>Specifying UDF Details</i> .....	2-12
2.1.6 <i>Specifying Account Generation Parameters at Bank Level</i> .....	2-12
2.1.7 <i>Maintaining Zengin Characters</i> .....	2-25
2.1.8 <i>Defining Bank-wide Preferences</i> .....	2-27
2.1.9 <i>Maintaining FATCA Preferences</i> .....	2-35
2.2 Maintaining Product Groups .....	2-36
2.3 Maintaining Mayuru Limit Details.....	2-36
2.3.1 <i>Viewing Maruyu Limit Details</i> .....	2-40
2.4 Maintaining Deposit Insurance Parameters.....	2-41
2.5 Maintaining Customer DIC Details .....	2-41
2.5.1 <i>Viewing Customer DIC Details</i> .....	2-43
2.5.2 <i>GI Interface Definition for DIC Outgoing Hand-off File</i> .....	2-44
2.6 Maintaining Mynumber Reason Code .....	2-103
2.6.1 <i>Viewing Mynumber Reason Code Summary</i> .....	2-105
2.7 Mynumber Upload Interface - STGICUMN.....	2-105
2.8 Tax Number Upload Interface - STGICUTN.....	2-107
2.9 Reconciliation Interface - STGORECN.....	2-109
2.10 Maintaining Transaction Code Class.....	2-111
2.10.1 <i>Viewing Transaction Code Class Maintenance Summary</i> .....	2-112
<b>3. Ramadan Maintenance .....</b>	<b>3-1</b>
3.1 Introduction.....	3-1
3.2 Maintaining Ramadan Day .....	3-1
<b>4. Dealer Maintenance .....</b>	<b>4-1</b>
4.1 Defining Dealer.....	4-1
<b>5. Branch Parameters .....</b>	<b>5-1</b>
5.1 Creating Branches.....	5-1
5.1.1 <i>System Features</i> .....	5-1
5.1.2 <i>Creating Reporting Structure</i> .....	5-2
5.1.3 <i>Basic Parameters for Branch</i> .....	5-2
5.1.4 <i>Maintaining General Details for Branch</i> .....	5-4
5.1.5 <i>Maintaining Financial Details for Branch</i> .....	5-8

5.1.6	<i>Maintaining Duplication Check Details</i> .....	5-13
5.1.7	<i>Maintaining SWIFT Address for Branch</i> .....	5-14
5.1.8	<i>Defining Account Mask</i> .....	5-14
5.1.9	<i>Maintaining Customer Number Range</i> .....	5-16
5.1.10	<i>Maintaining Global Interdict Functions</i> .....	5-19
5.1.11	<i>Maintaining Preferences</i> .....	5-19
5.1.12	<i>Maintaining LCY Message Preference for Branch</i> .....	5-26
5.1.13	<i>Specifying UDF Details</i> .....	5-27
5.1.14	<i>Maintaining Address Codes Details</i> .....	5-27
5.1.15	<i>Address Code Summary</i> .....	5-31
5.2	<i>Maintaining Tax Cycle</i> .....	5-31
5.2.1	<i>Updating Tax Cycle</i> .....	5-32
5.2.2	<i>Maintaining Tax</i> .....	5-32
5.2.3	<i>Maintaining Clearing Currencies</i> .....	5-34
5.2.4	<i>Account Statement Handoff</i> .....	5-34
5.2.5	<i>Account Statement Generation</i> .....	5-34
5.3	<i>Maintaining Role to Head Mapping at Branch Level</i> .....	5-35
5.3.1	<i>Viewing Accounting Role to Head Mapping Details</i> .....	5-36
<b>6.</b>	<b>Account Branch Transfer</b> .....	<b>6-1</b>
6.1	<i>Introduction</i> .....	6-1
6.2	<i>Maintaining Branch Transfer Parameters</i> .....	6-1
6.3	<i>Transferring Customer Account Branch</i> .....	6-2
6.3.1	<i>Viewing Account Branch Transfer Details</i> .....	6-4
6.4	<i>Transferring Account Class</i> .....	6-5
6.5	<i>Processing Account Branch Transfer</i> .....	6-6
<b>7.</b>	<b>System Dates Maintenance</b> .....	<b>7-1</b>
7.1	<i>Introduction</i> .....	7-1
7.1.1	<i>Maintaining Dates Change</i> .....	7-2
<b>8.</b>	<b>Web Service Maintenance</b> .....	<b>8-1</b>
8.1	<i>Introduction</i> .....	8-1
8.2	<i>Maintaining Web Service</i> .....	8-1
8.2.1	<i>Mapping of Web Service</i> .....	8-2
8.2.2	<i>Web Service Details</i> .....	8-3
8.2.3	<i>WebService Maintenance</i> .....	8-4
<b>9.</b>	<b>Accounts for Inter-Branch Transactions</b> .....	<b>9-1</b>
9.1	<i>Defining Accounts for Inter-Branch Transactions</i> .....	9-1
9.1.1	<i>System Features</i> .....	9-2
9.1.2	<i>Specifying Customer Accounts</i> .....	9-4
9.2	<i>Defining Accounts for Inter-Branch Fund Transactions</i> .....	9-5
9.2.1	<i>Querying on Netting Batch</i> .....	9-6
<b>10.</b>	<b>Currency Maintenance</b> .....	<b>10-1</b>
10.1	<i>Introduction</i> .....	10-1
10.2	<i>Maintaining Currency Details</i> .....	10-1
10.2.1	<i>Indicating Rounding Preferences</i> .....	10-6
10.2.2	<i>Specifying Amount Format Mask</i> .....	10-7
10.2.3	<i>Specifying Exchange Rate Limits</i> .....	10-8
10.2.4	<i>Mapping Currency to Country</i> .....	10-8
10.2.5	<i>Specifying User Defined Fields</i> .....	10-9
10.2.6	<i>Annexure</i> .....	10-9

10.2.7	<i>Specifying Currency Cut-Off Parameters</i> .....	10-12
10.3	Maintaining Currency Position Details .....	10-14
10.4	Handling Euro .....	10-16
10.5	Maintaining Euro Related Information .....	10-17
10.5.1	<i>Maintaining Currency Details</i> .....	10-17
10.5.2	<i>Maintaining Conversion GLs</i> .....	10-19
10.5.3	<i>Implications of Currency Redenomination</i> .....	10-19
10.5.4	<i>Specifying Preferred ERI Currency for Counterparty</i> .....	10-21
10.5.5	<i>Specifying Settlement Message Details</i> .....	10-22
10.5.6	<i>Settlements of Foreign Exchange Deals</i> .....	10-22
10.5.7	<i>Reports and Advices</i> .....	10-22
10.5.8	<i>Maintaining Limits Type</i> .....	10-23
10.5.9	<i>Maintaining Transaction Limits</i> .....	10-24
10.6	Maintaining Sequence Generation Format .....	10-26
<b>11.</b>	<b>Maintaining Currency Denomination</b> .....	<b>11-1</b>
11.1	Introduction .....	11-1
11.2	Maintaining Currency Denomination Details .....	11-1
<b>12.</b>	<b>Expressing Amounts in Words</b> .....	<b>12-1</b>
12.1	Introduction .....	12-1
<b>13.</b>	<b>Defining Currency Pairs</b> .....	<b>13-1</b>
13.1	Introduction .....	13-1
13.2	Maintaining Currency Pair Details .....	13-1
13.2.1	<i>System Features</i> .....	13-1
13.2.2	<i>Maintaining Parameters for Currency Pair</i> .....	13-2
13.2.3	<i>Specifying Points Multiplier</i> .....	13-4
<b>14.</b>	<b>Maintaining Exchange Rates</b> .....	<b>14-1</b>
14.1	Introduction .....	14-1
14.2	Maintaining Currency Rates .....	14-1
14.2.1	<i>Authorizing Exchange Rates</i> .....	14-4
14.2.2	<i>Revising Exchange Rates</i> .....	14-4
14.2.3	<i>Viewing Exchange Rates</i> .....	14-4
14.2.4	<i>Viewing Currency Batch Rate</i> .....	14-5
14.2.5	<i>Specifying Limits for Cross Currency Transactions</i> .....	14-6
14.3	Currency Manual Exchange Rate Maintenance .....	14-8
14.4	Maintaining Currency Position Threshold Limits .....	14-9
14.4.1	<i>Viewing Currency Position Threshold Limits Summary</i> .....	14-12
14.4.2	<i>Viewing Currency Position</i> .....	14-13
14.5	CYBPOSBT Batch .....	14-14
14.6	CYBCYPOB Batch .....	14-17
14.7	Transaction Currency Position .....	14-18
<b>15.</b>	<b>Maintaining Currency Spread for Customer</b> .....	<b>15-1</b>
15.1	Maintaining Currency Spread .....	15-1
15.2	Maintaining Customer Spread Details .....	15-2
15.2.1	<i>Computing Buy and Sell Spreads</i> .....	15-4
15.2.2	<i>Maintaining Currency Margins for Customer</i> .....	15-4
<b>16.</b>	<b>Maintaining Company Codes</b> .....	<b>16-1</b>
16.1	Introduction .....	16-1
<b>17.</b>	<b>Period Code Maintenance</b> .....	<b>17-1</b>
17.1	Introduction .....	17-1

17.2	Invoking Period Code Maintenance Screen .....	17-1
17.3	System Functions .....	17-3
<b>18.</b>	<b>Status Code Maintenance .....</b>	<b>18-1</b>
18.1	Introduction.....	18-1
18.2	Invoking Status Maintenance Screen .....	18-1
	18.2.1 <i>Maintaining Status Codes for Contracts</i> .....	18-2
	18.2.2 <i>Maintaining Status Codes for OD Account</i> .....	18-3
18.3	Maintaining Dormancy Parameter Details .....	18-3
18.4	Maintaining CR\DR Statistics Details .....	18-5
<b>19.</b>	<b>Transaction Code Maintenance .....</b>	<b>19-1</b>
19.1	Introduction.....	19-1
19.2	Invoking Transaction Code Screen .....	19-1
	19.2.1 <i>Maintaining Transaction Details</i> .....	19-2
	19.2.2 <i>Maintaining Country Name Details</i> .....	19-9
19.3	Maintaining Shumoku Code .....	19-11
<b>20.</b>	<b>Account Revaluation Maintenance .....</b>	<b>20-1</b>
20.1	Introduction.....	20-1
<b>21.</b>	<b>Maintaining Branch Holidays .....</b>	<b>21-1</b>
21.1	Introduction.....	21-1
21.2	Invoking Local Holiday Screen .....	21-1
	21.2.1 <i>Steps to Define Yearly Holidays</i> .....	21-2
	21.2.2 <i>Defining Holidays</i> .....	21-3
	21.2.3 <i>Annual Holidays</i> .....	21-3
	21.2.4 <i>Designating Unexpected Holidays for Branch</i> .....	21-3
<b>22.</b>	<b>Maintaining Currency Holidays .....</b>	<b>22-1</b>
22.1	Introduction.....	22-1
22.2	Invoking Currency Holiday Screen .....	22-1
	22.2.1 <i>Steps to Define Currency Holidays</i> .....	22-2
	22.2.2 <i>Defining Currency Holidays</i> .....	22-2
22.3	Uploading Holiday File.....	22-2
<b>23.</b>	<b>Maintaining Clearing Holidays .....</b>	<b>23-1</b>
23.1	Introduction.....	23-1
	23.1.1 <i>Steps to Define Clearing House Holidays</i> .....	23-1
	23.1.2 <i>Defining Clearing House Holidays</i> .....	23-2
	23.1.3 <i>Designating Unexpected Holidays for Clearing House</i> .....	23-2
<b>24.</b>	<b>Document Maintenance .....</b>	<b>24-1</b>
24.1	Introduction.....	24-1
24.2	Maintaining Document Type.....	24-1
24.3	Viewing Document Type Details.....	24-1
24.4	Maintaining Document Checklist Details .....	24-3
24.5	Viewing Document Type Details.....	24-4
<b>25.</b>	<b>Configuring Overrides .....</b>	<b>25-1</b>
25.1	Introduction.....	25-1
	25.1.1 <i>Types of Overrides</i> .....	25-1
25.2	Specifying Override Type .....	25-2
	25.2.1 <i>Maintaining Override Conversion</i> .....	25-3
	25.2.2 <i>Maintaining Error Codes</i> .....	25-3
<b>26.</b>	<b>Maintaining Features .....</b>	<b>26-1</b>
26.1	Introduction.....	26-1

26.2	Maintaining Feature ID .....	26-1
26.2.1	<i>Specifying UDF Values</i> .....	26-3
26.3	Viewing Feature ID Summary.....	26-4
<b>27.</b>	<b>Purging and Archiving Data .....</b>	<b>27-1</b>
27.1	Purging Data.....	27-1
27.2	Module Purging .....	27-1
27.3	Maintaining Purge Details.....	27-2
27.4	Entity Purging .....	27-3
27.4.1	<i>Configuring Purge Parameters</i> .....	27-4
27.4.2	<i>Viewing Purge Parameter Configuration Details</i> .....	27-6
27.4.3	<i>Processing Ad-hoc Purge</i> .....	27-7
27.4.4	<i>Parallel Stream Maintenance</i> .....	27-9
27.4.5	<i>Inquiring Purge Log</i> .....	27-10
27.5	Archiving Data .....	27-10
27.5.1	<i>Archival of CASA and GL Transaction History</i> .....	27-11
27.5.2	<i>Archival of Closed CASA Accounts</i> .....	27-14
27.5.3	<i>Archival of TD accounts</i> .....	27-15
27.5.4	<i>Archival of Liquidated Loans</i> .....	27-16
27.5.5	<i>Archival of ATM/POS/IVR Transaction Logs</i> .....	27-17
27.5.6	<i>Archival of Payment (Zengin) Transactions</i> .....	27-18
27.5.7	<i>Archival of Branch Transaction Logs</i> .....	27-19
27.5.8	<i>Archival of Retail Teller Transaction Logs</i> .....	27-20
27.5.9	<i>Archival of Interface Gateway Logs</i> .....	27-21
27.5.10	<i>Archival of Generic Interface (File/Batch) Upload Logs</i> .....	27-22
27.5.11	<i>Archival of Exchange Rate History</i> .....	27-23
27.5.12	<i>Archival of Security Management Logs</i> .....	27-23
27.5.13	<i>Archival of Audit Logs</i> .....	27-24
<b>28.</b>	<b>Support 24x7 .....</b>	<b>28-1</b>
28.1	Introduction.....	28-1
28.1.1	<i>Gateway Messaging</i> .....	28-1
28.1.2	<i>Web Branch</i> .....	28-1
28.1.3	<i>Batch Processing</i> .....	28-1
28.1.4	<i>Processing Different Categories during EOD</i> .....	28-2
28.2	Supporting 24x7 Transactions.....	28-7
28.2.1	<i>24x7 Transactions through Channel</i> .....	28-8
28.2.2	<i>24x7 Transactions through Branch or Call Centre</i> .....	28-9
28.2.3	<i>EOD handling</i> .....	28-13
28.2.4	<i>Call Centre Handling</i> .....	28-15
<b>29.</b>	<b>Tanking of Maintenance Records .....</b>	<b>29-1</b>
29.1	Introduction.....	29-1
29.2	Tanking New and Modified Maintenance Records .....	29-1
29.2.1	<i>Tanking New Records</i> .....	29-2
29.2.2	<i>Tanking Modified Records</i> .....	29-2
29.2.3	<i>Closing a Record</i> .....	29-2
29.2.4	<i>Re-opening a Record</i> .....	29-2
29.2.5	<i>Authorizing a Record</i> .....	29-2
29.2.6	<i>Deleting a Record</i> .....	29-2
29.2.7	<i>Viewing Summary of Records</i> .....	29-2
29.2.8	<i>Modifying Tanking Preferences</i> .....	29-2



<b>30. External Deal Maintenance .....</b>	<b>30-1</b>
30.1 Introduction.....	30-1
<b>31. Annexure B - File Formats .....</b>	<b>31-1</b>
31.1 Introduction.....	31-1
31.2 Upload File Formats .....	31-1
<b>32. Anti-Money Laundering Reporting .....</b>	<b>32-1</b>
32.1 Guarding Against Money Laundering .....	32-1
32.1.1 <i>Creating Product Categories in Oracle FLEXCUBE</i> .....	32-1
32.2 Maintaining Limit Codes .....	32-3
32.3 Maintaining Anti Money Laundering Customer Groups.....	32-4
32.4 Monitoring AML Accounting.....	32-7
<b>33. Developer and Developer Project Maintenance .....</b>	<b>33-1</b>
33.1 Introduction.....	33-1
33.2 Maintaining Developer Details.....	33-1
33.2.1 <i>Viewing Project Details</i> .....	33-2
33.2.2 <i>Viewing UDF Details</i> .....	33-3
33.3 Viewing Developer Maintenance Summary.....	33-3
33.4 Maintaining Developer Project Details.....	33-4
33.4.1 <i>Viewing UDF Details</i> .....	33-5
33.5 Viewing Developer Project Maintenance Summary .....	33-6
<b>34. Project Financing .....</b>	<b>34-1</b>
34.1 Introduction.....	34-1
34.2 Processing Finance for Project.....	34-1
34.3 Maintaining Project Financing Transaction.....	34-4
34.3.1 <i>Specifying the Project Details</i> .....	34-5
34.3.2 <i>Specifying the Main Details</i> .....	34-7
34.3.3 <i>Specifying Milestones Details</i> .....	34-8
34.3.4 <i>Specifying the Venture Details</i> .....	34-9
34.3.5 <i>Specifying PPC Limits Details</i> .....	34-11
34.3.6 <i>Specifying Non PPC Limits Details</i> .....	34-13
34.4 Maintaining PPC.....	34-14
34.4.1 <i>Specifying PPC Maintenance Details</i> .....	34-15
34.4.2 <i>Specifying Joint Venture Details</i> .....	34-16
34.4.3 <i>Maintaining PPC Liquidation</i> .....	34-17
34.5 Viewing Dashboard Details .....	34-18
34.5.1 <i>Viewing PPC Details</i> .....	34-18
34.5.2 <i>Viewing Limit Details</i> .....	34-19
34.5.3 <i>Viewing Commitment Details</i> .....	34-20
34.5.4 <i>Viewing Loan Details</i> .....	34-21
34.6 Querying Dashboard Details .....	34-22
34.7 Querying Accounting Entries .....	34-22
<b>35. Error and Error Codes for Project Financing .....</b>	<b>35-1</b>
35.1 Error and Error Codes .....	35-1
<b>36. Reports .....</b>	<b>36-1</b>
36.1 Introduction.....	36-1
36.2 List of Deleted Transactions .....	36-1
36.2.1 <i>Contents of Report</i> .....	36-2
36.3 Accounting Journal .....	36-4
36.3.1 <i>Contents of Report</i> .....	36-5

36.4	Cash Flow Report.....	36-6
	36.4.1 Contents of Report .....	36-7
	36.4.2 Cash Flow (Summary) Report .....	36-8
36.5	Future Dated Account Balance Report.....	36-9
	36.5.1 Contents of the Report .....	36-9
36.6	Current Rates Report .....	36-10
	36.6.1 Contents of Report .....	36-11
36.7	Rate History Report .....	36-12
36.8	Customer Account Opening Confirmation Report .....	36-13
	36.8.1 Contents of the Report .....	36-14
36.9	Activity Journal Report.....	36-15
	36.9.1 Contents of Report .....	36-16
36.10	Core Exception Report .....	36-17
	36.10.1 Contents of Report .....	36-18
36.11	Uncollected Funds Report .....	36-19
	36.11.1 Contents of Report .....	36-19
36.12	Account Revaluation Report.....	36-20
	36.12.1 Contents of Report .....	36-20
36.13	Accounts Movement Report .....	36-22
	36.13.1 Contents of Report .....	36-22
36.14	Customer Details Report .....	36-23
	36.14.1 Contents of Report .....	36-24
36.15	Customer Accounts Report .....	36-28
	36.15.1 Contents of Report .....	36-29
36.16	Document Check List Report.....	36-32
	36.16.1 Contents of the Report .....	36-33
36.17	Memo Revaluation Report.....	36-34
	36.17.1 Contents of Report .....	36-34
36.18	Black Listed During Contract Booking Report .....	36-35
	36.18.1 Contents of the Report .....	36-36
36.19	Black List Report During File Upload Report.....	36-37
	36.19.1 Contents of the Report .....	36-37
36.20	Cheque Book Issued Report .....	36-38
	36.20.1 Contents of the Report .....	36-39
36.21	Demand Draft Issued Report.....	36-39
	36.21.1 Contents of the Report .....	36-40
36.22	PDC Input Report .....	36-41
	36.22.1 Contents of the Report .....	36-42
36.23	Temporary Overdraft Report .....	36-43
	36.23.1 Contents of the Report .....	36-44
36.24	Daily Sales Report.....	36-45
	36.24.1 Contents of the Report .....	36-46
36.25	Exception Report.....	36-47
	36.25.1 Contents of the Events Log.....	36-48
<b>37.</b>	<b>Function ID Glossary .....</b>	<b>37-1</b>

---

# 1. Preface

## 1.1 Introduction

This manual is designed to help you quickly get acquainted with the Core Services module of Oracle FLEXCUBE.

You can further obtain information specific to a particular field by placing the cursor on the relevant field and striking <F1> on the keyboard.

## 1.2 Audience

This manual is intended for the following User/User Roles:

Role	Function
Back office clerk	Input functions for contracts
Back office managers/officers	Authorization functions
Product Managers	Product definition and authorization
End of day operators	Processing during end of day/ beginning of day
Financial Controller/Product Managers	Generation of reports

## 1.3 Documentation Accessibility

For information about Oracle's commitment to accessibility, visit the Oracle Accessibility Program website at <http://www.oracle.com/pls/topic/lookup?ctx=acc&id=docacc>.

## 1.4 Organization

The manual is organized in the following manner:

<b>Chapter 1</b>	<i>About this Manual</i> gives a brief introduction of the module, the audience it addresses and the organization of the various chapters. It also includes the list of related documents to be referred, if any, and the conventions used in the document
<b>Chapter 2</b>	<i>Bank Parameters</i> explains the maintenance of various basic details about your bank
<b>Chapter 3</b>	<i>Ramadan Maintenance</i> explains maintenance of <i>Ramadan</i> year.
<b>Chapter 4</b>	<i>Dealer Maintenance</i> explains how you can capture profiles of dealers involved in buying and selling of foreign exchange
<b>Chapter 5</b>	<i>Branch Parameters</i> explains the process of creating and maintaining branches of your bank, with all necessary details

<b>Chapter 6</b>	<i>Account Branch Transfer</i> explains how you can maintain and process account transfers from one branch of the bank to another.
<b>Chapter 7</b>	<i>System Dates Maintenance</i> explains how you can maintain system dates for the branches of your bank
<b>Chapter 8</b>	<i>Web Service Maintenance</i> explains the process of WebService Mapping and other details regarding maintenance of external WebService.
<b>Chapter 9</b>	<i>Accounts for Inter-Branch Transactions</i> explains how you can maintain internal accounts for branches involved in inter-branch transactions
<b>Chapter 10</b>	<i>Currency Maintenance</i> explains the process of maintaining currencies in the system, with all necessary static attributes
<b>Chapter 11</b>	<i>Maintaining Currency Denomination</i> explains the maintenance of standard currency denominations for each currency
<b>Chapter 12</b>	<i>Expressing Amounts in Words</i> describes the details of maintaining amounts in words
<b>Chapter 13</b>	<i>Defining Currency Pairs</i> explains the maintenance of static attributes for currency pairs for which exchange rate quotes are available
<b>Chapter 14</b>	<i>Maintaining Exchange Rates</i> explains the maintenance of exchange rates used to buy and sell currencies one for another
<b>Chapter 15</b>	<i>Maintaining Currency Spread for a Customer</i> explains the maintenance of currency spread and margin details for a customer
<b>Chapter 16</b>	<i>Maintaining Company Codes</i> explains the maintenance of company codes predominantly used for cycle based rates.
<b>Chapter 17</b>	<i>Period Code Maintenance</i> explains the maintenance of financial periods into which each financial cycle is to be divided
<b>Chapter 18</b>	<i>Status Code Maintenance</i> explains the maintenance of codes that you can assign to the different statuses that a contract or a customer account can attain
<b>Chapter 19</b>	<i>Transaction Code Maintenance</i> explains the maintenance of codes that you can use to represent different types of transactions
<b>Chapter 20</b>	<i>Account Revaluation Maintenance</i> explains the maintenance of parameters for account revaluation
<b>Chapter 21</b>	<i>Maintaining Branch Holidays</i> explains the maintenance of the holiday calendar for the different branches of your bank
<b>Chapter 22</b>	<i>Maintaining Currency Holidays</i> explains the maintenance of the holiday calendar for the different currencies in which your bank transacts
<b>Chapter 23</b>	<i>Maintaining Clearing Holidays</i> explains the maintenance of the holiday calendar for the different clearing houses with which your bank transacts
<b>Chapter 24</b>	<i>Document Maintenance</i> explains about the type of documents to be submitted before opening an account and the document checklist to be maintained.





<b>Chapter 25</b>	<i>Configuring Overrides</i> details on configuring overrides of the system.
<b>Chapter 26</b>	<i>Maintaining Features</i> explains the method of installing features in a branch to improve the performance of the system during online or batch processes.
<b>Chapter 27</b>	<i>Purging Data</i> explains the details of purging data.
<b>Chapter 28</b>	<i>Support 24x7</i> explains about the 24x7 support features in FCUBS.
<b>Chapter 29</b>	<i>Tanking of Maintenance Records</i> explains the process of tanking maintenance records.
<b>Chapter 30</b>	<i>External Deal Maintenance</i> explains the process of capturing deals booked in an external system.
<b>Chapter 31</b>	<i>Annexure B – File Formats</i> contains a list of file formats.
<b>Chapter 32</b>	<i>Anti-Money Laundering Reporting</i> explains the process of guarding against money laundering, a facility provided by Oracle FLEXCUBE
<b>Chapter 33</b>	<i>Developer and Developer Project Maintenance</i> explains how you can maintain details of the real-estate developer and developer projects.
<b>Chapter 34</b>	<i>Project Financing</i> explains the process of maintaining the project finance transaction in a bank using the Project Detail and Maintenance screen.
<b>Chapter 35</b>	<i>Error and Error Codes for Project Financing</i> lists all the error messages that you can encounter while working with this module.
<b>Chapter 36</b>	<i>Reports</i> explains the procedure of generating Reports.
<b>Chapter 37</b>	<i>Function ID Glossary</i> has alphabetical listing of Function/Screen ID's used in the module with page references for quick navigation.

## 1.5 Related Documents

- The Procedures User Manual
- The Settlements User Manual

## 1.6 Glossary of Icons

This User Manual may refer to all or some of the following icons:

<b>Icons</b>	<b>Function</b>
	Exit
	Add row
	Delete row
	Option List

## 2. Bank Parameters

### 2.1 Defining Bank Level Parameters

In the 'Bank Wide Parameters' screen, you maintain basic information about your bank such as its name, head office, account number structure, local currency and so on.

The details that you maintain in this screen will be made applicable to all branches of your bank. For instance, the account number structure that you define in this screen will be a common format for customer accounts in all branches of your bank.

Invoke the 'Bank Parameters' screen by typing 'STDBNKPM' in the field at the top right corner of the Application tool bar and clicking the adjoining arrow button.

The screenshot shows the 'Bank Parameters Maintenance' application window. It has a search bar at the top left labeled 'Enter Query'. Below it are input fields for 'Bank Code \*' and 'Bank Name'. A section titled 'Head Office Branch' contains 'Branch Code \*' and 'Branch Description' fields. There are three tabs: 'Financial Preferences' (selected), 'General Preferences', and 'FATCA'. Under 'Financial Preferences', there is a section 'Bank Default Currency Codes' with four rows, each having a currency code field (Local Currency \*, Discount Currency \*, Head Office Currency \*, Reporting Currency \*) and a 'Currency Description' field. Below that are two sections: 'Control Accounts For Real Entries' and 'Control Accounts For Contingent Entries'. Each has three rows with fields for 'Currency Mismatch Control Account', 'Value Date Mismatch Control Account', and 'Clearing Bank Code Routing Mask'. At the bottom right of these sections are two checkboxes: 'Auto Generate Currency Mismatch Entries' and 'Auto Generate Value Date Mismatch Entries'. The bottom of the window has a dark blue bar with fields for 'Maker', 'Checker', 'Mod No', 'Date Time', 'Record Status', and 'Authorization Status', and an 'Exit' button on the right.

You can maintain the following details in this screen:

#### Bank Code

In Oracle FLEXCUBE a bank is identified by a unique four-character code. You can follow your own convention in devising this code. In all inter-bank transactions this code identifies your bank.

#### Name

You can also specify the detailed name of the bank. This name will always be displayed whenever the bank code is used.

#### 2.1.0.1 Specifying Details of Head Office Branch

After specifying a code to identify your bank, you should specify details of the head office of your bank.

## **Code**

From the list of the branches you have already maintained of your bank, designate one as your Head Office

## **Description**

The description of the branch designated as Head Office is displayed.

### **2.1.1 Maintaining Financial Preferences**

In this screen, you can maintain information regarding default currency for the branch, specify if balancing entries must be automatically generated in case of mismatches, define routing mask, clearing bank code etc.

#### **2.1.1.1 Specifying Default Currency Codes**

You can indicate currency preferences for your bank. You can specify preferences to indicate the default currencies for the following purposes:

- **Local** — The currency that you indicate as the local currency will be taken as the local currency for all branches of your bank and the default currency for all transactions input into Oracle FLEXCUBE. The income and expense balances of your bank will also be maintained in this currency
- **Discount** — If the discount rate for a particular currency is not maintained the discount rate of the specified discount currency will be picked up for discounting profits on forward foreign exchange contracts
- **Head Office** — The default currency for the Head Office
- **Reporting** — The default currency in which all financial reporting should be done

You will not have an option to modify the default currencies that you specify after the Bank Parameters record has been stored and authorized.

#### **Auto Generate Currency and Value Date Mismatch Entries**

You can specify that balancing entries must be generated automatically by Oracle FLEXCUBE, in the case of currency or value date mismatches in accounting entries due to transactions that are not balanced with respect to currency or value dates, for each branch (single entity) of your bank.

To specify the automatic generation of such balancing entries for currency mismatches, select the options 'Auto Generate Currency Mismatch Entries' and for generation of balancing entries to correct value date mismatches, select 'Auto Generate Value Date Mismatch Entries' in the Bank Wide Parameters screen.

If indicated in the Bank Wide Parameters, balancing entries will be automatically generated for any event if a mismatch of currency or value date entries (or both) is involved in any module of Oracle FLEXCUBE, with the exception of manually entered journal entries.

#### **2.1.1.2 Specifying Control Accounts for Auto Balancing Entries (Real and Contingent)**

If you specify that such automatic balancing entries must be generated, you can also specify the control accounts into which the entries must be booked.

There are two sets of accounts that you can maintain in the Bank-Wide Parameters screen, one for mismatches arising out of entries to real accounts and another for mismatches arising out of entries to contingent accounts. The relevant Control accounts must therefore be of Real or Contingent nature (as defined in the GL – Chart of Accounts). Such balancing entries will be automatically generated if a mismatch of currency or value date entries (or both) is involved in any module of Oracle FLEXCUBE, except Journal Entry.

In your Chart of Accounts, you must ensure that the following conditions are not indicated for the control accounts that you have specified for the currency mismatch and value date mismatch entries:

- Position accounting: Even if position accounting is set to “Yes” for the control account, the system will not pass any position accounting entries, since position accounting is done only for the main set of entries and not for the auto-balancing entries.
- Account revaluation: Account revaluation must be set for the control accounts since the effect of revaluing these balances would be offset the effect of revaluing the original GLs. (the GLs into which the main entries were posted).
- Direct posting: If you post a manual entry to one of the Control Accounts and the Position Entry Flag for the Control Account is set to 'Yes', then the system will do position accounting for that entry. Hence, for the GLs set-up as Control Accounts, the “Direct Posting” flag in the Chart of Accounts maintenance must be turned OFF.

---

#### **Note**

Additionally, it is also recommended that these Control Account GL's that you have specified in the Bank Wide Parameters screen for the mismatch entries are not used as part of Role to Head Mapping in any of the products. If maintained, the system would pass mismatch adjustment entries into the same GLs in which the main entries have been passed. There is no system-enforced validation of this and this aspect needs to be taken care of during Product set-up.

---

### **2.1.2 Generating Automatic Balancing Entries**

In the case of transactions entered in any of the front-end modules of Oracle FLEXCUBE, the accounting process checks the entries at each business event, and automatically generates the balancing entries in case of a mismatch in currency or value date entries (or both).

#### **Manually entered journal entries**

In the case of manually entered journal entries, a journal batch that has been opened must be closed before it is authorized. During closure, the accounting process checks to see that the batch is balanced with respect to currency and value date entries. If a mismatch is detected, the accounting process raises an override to this effect. Depending upon how the override is configured, for your bank, the user who has opened the batch could adopt either of the following courses of action:

- If the override is configured to be an error, the system will not allow the user to close the batch without balancing the mismatches.
- If the override is configured to be a warning (either 'Override' or 'Ignore'), the user can save the batch with the mismatches. No balancing entries are automatically generated by the system for the mismatch.

#### **Uploaded journal entries**

In the case of uploaded journal entries, a journal batch that has mismatched entries is not rejected, but an override is raised by the accounting process. Depending upon how the override is configured, for your bank, the accounting process takes either of the following paths:

- If the override is configured to be an error, then the batch is rejected, and must be uploaded again with the corrected entries.
- If the override is configured to be a warning, the accounting process automatically generates the balancing entries for the currency or value date mismatches, for the batch, and posts them to the requisite control accounts specified in the Bank Parameters.



In each case, the transaction reference for the balancing entries is the same as that of the original accounting entry, in which the mismatch occurred, and the other details of the balancing entries are, by default, the corresponding values in the original entries.

The mismatch balancing entries are generated in the following order or preference:

- Currency mismatch balancing entries
- Value Date mismatch balancing entries

In the case of mismatches in accounting entries due to inter-branch transactions, the inter-branch balancing entries are generated before any balancing entries for currency mismatches, and then, finally, the value date mismatches.

### Routing Mask

A mask defines the manner in which a Routing Number is generated for your bank. It is on the basis of the routing number that Oracle FLEXCUBE processes clearing transactions.

The following is a typical mask format: 'BBBbbbSSS', wherein, 'BBB' indicates the bank code, 'bbb' indicates the branch, and 'SSS' indicates the sector to which the branch belongs. On the basis of the routing number, clearing transactions are routed to the appropriate branch of your bank.

### Clearing Bank Code

Specify the code by which your bank is identified in the Clearing Network you participate in. This has to be the same as that specified for your bank in the Clearing Bank Code Maintenance screen.

## 2.1.3 Maintaining General Preferences

In this screen, you can define format masks (for general ledger, CIF), choose if batch numbers should be auto-generated by the system, specify the details for cheque numbering etc.

The screenshot displays the 'Bank Parameters Maintenance' window with the 'General Preferences' tab selected. The interface includes the following sections and fields:

- Bank Information:** Bank Code \* (text), Bank Name (text).
- Head Office Branch:** Branch Code \* (text), Branch Description (text).
- Navigation Tabs:** Financial Preferences, **General Preferences**, FATCA.
- Format Mask:** Cif Mask (text), PID Mask (text), PID Checksum Algorithm (Modulo 11 dropdown), General Ledger Mask \* (text).
- Year End Profit and Loss:** General Ledger \* (text), Transaction Code \* (text).
- Spread:** Spread Application (dropdown), Spoof Files Purge Days (text), Inter Pay Lead Days (text).
- General Ledger Purge Days:** General Ledger Purge Days (text), Auto Batch (checkbox), User Batch Restriction (checkbox), SSO Enabled (checkbox).
- Cheque Numbering Details:** Scheme (dropdown), Cheque Number Mask (text), Checksum Algorithm (dropdown), Cheques Number Unique for Branch (checkbox).
- Footer:** Preferences | Account Mask | Field Properties | Zengin Characters. Fields for Maker/Checker, Date Time, Mod No, Record Status, Authorization Status, and an Exit button.

### 2.1.3.1 **Defining Format Masks**

A format mask is a structure that you can define for various elements that need to be entered in Oracle FLEXCUBE. You can define format masks for the following elements:

- General Ledgers
- Customer Identification File codes
- Customer account numbers

Once defined, you can modify the structure of a format mask only if no Customer or General Ledger Account has been opened using the mask. Customer Account mask is defined from the 'Account Mask' Button.

*For more details on defining customer account mask, refer the section titled 'Specifying Account Generation Parameters at Bank Level'.*

#### **CIF Mask**

You can maintain a mask for generation of identification numbers (CIF Number) for customers of your bank. During customer information maintenance, the system will automatically generate the CIF numbers based on the mask you define here and the customer number range maintained at the branch level.

A CIF mask consists of a maximum of 9 digits. The CIF mask could have only numbers or could be alpha numeric or could also have the branch code as a part of it.

For instance, you can maintain the CIF Mask as 'bbbnnnnnn' where 'bbb' represents a three-digit branch code and 'nnnnnn' represents a 6-digit number.

#### **PID Mask**

You can maintain a mask for generation of personal identification number (PID) for customers of your bank. A PID mask can have a maximum of 15 digits with alphanumeric characters.

You can also have the branch code as a part of it. For instance, you can define PID Mask as follows:

- For modulo 11, bbb nnnnnnnnnn d
- For modulo 97, bbb nnnnnnnnnn dd

Where 'b' represents a three-digit Branch Code, 'n' represents 10/11 digit number, and 'd' represent the check digit.

System automatically generates the PID numbers based on the defined mask and the preference option selected as 'Auto Generate PID No' or 'Re-Generate Unused PID number' in the 'Preferences' tab, system.

#### **PID Checksum Algorithm**

Select the checksum algorithm to be associated with the selected PID mask from the drop-down list. The list displays the following values:

- Modulo 11
- Modulo 97

*For more details on the algorithm types, refer to section 'Checksum Algorithm' and 'Specifying Customer Account Mask' of this document.*

#### **GL Mask**

You can indicate a mask for the general ledgers that are maintained for your bank. The mask that you define here will be enforced whenever a General Ledger is created in the Chart of Accounts screen.

A GL mask can consist of a maximum of nine alphanumeric characters. It can be built using a combination of numbers and letters to indicate for instance, the category of the GL - asset, liability etc., the GLs hierarchical position and so on.

Each element used to define the mask would represent a single character. To represent an alphabet of the English language, indicate "a". To represent a number, indicate "n". The last character would be a D or d, which indicates a check digit generated by the system. For a numeric check digit define it as 'd'; for an alphanumeric check digit define it as 'D'.

You may use any of the following punctuation in the GL mask:

- dash (-)
- comma (,)
- asterisk (\*)
- Full Stop (.)
- Forward slash (/)

For example, You wish to create a two level GL structure for your bank. You could define the first two characters of the GL to represent the category asset, liability etc., aa; the next two characters, nn, to represent the first level GL; and the next three characters, nnn, to represent the second level GL. A GL based on the given structure would read as AS01001 where AS represents the GL category - asset; 01 represents the first level GL; 001 represents the second level GL.

For creating this structure you would define your GL mask as - aannnnn'd/D'.

If you want to define your second level GL with a 4 digit numeric code instead of 3; other parameters remaining the same your mask would read as aannnnnn 'd' 'D'.

### **2.1.3.2 Indicating Year-end Profit & Loss**

#### **General Ledger**

At the end of any financial year the balances in the income and expense accounts are posted by Oracle FLEXCUBE into a separate year-end account for the purpose of consolidation of balances and turnovers. This account is called the Year End profit and loss General Ledger Account.

You also specify year-end profit and loss GL for each GL account you maintain in the 'Chart of Accounts' screen. The year-end account specified at the bank level is the default year end profit and loss GL for all GL accounts maintained in the 'Chart of Accounts - GL' screen. If you do not specify the account to which year end balances of a particular GL should be posted, it will be posted to the bank's year-end profit and loss account.

You can select a GL code from the option list of all assets, liabilities, income and expense GLs maintained in the chart of accounts screen.

#### **Transaction Code**

Indicate the transaction code that should be used to post the balances in the income and expense accounts to the year-end GL account.

You can select a transaction code from the list of transaction codes maintained in the 'Transaction Code Maintenance' screen.

#### **Spread**

Capture the following details.

### **Spread Application**

Indicate the transaction legs for which the spread should be applicable. Choose the appropriate option from the following available in the adjoining drop-down list:

- Single Leg
- Both Legs

### **Spool File Purge Days**

Specify the duration for which spool files should be stored in the spool file directory.

### **Interpay Lead Days**

Specify the inter-pay lead days required for fetching billing records for inter-pay files for automatic billing of clients..

### **Auto Batch**

Each time you post journal and multi offset entries, you need to open a batch. You can specify that the batch numbers of the journal entry batches opened in your bank should be generated automatically by enabling the Auto Batch option.

Consequently, the system automatically generates batch numbers while posting journal and multi offset entries.

## **2.1.4 Placing User Restrictions on Data Entry Batches**

You can restrict the usage of batches to specific user by placing bank-wide User level batch restrictions. If you enable this option as a Bank Parameter, you need to allocate the batch number range for each user through the 'Batch Restriction Maintenance' screen.

The restriction on the usage of batch numbers is made applicable on data entry and PC transactions. The user will be allowed to enter only those batches reserved for the user profile. As a result, each time a user specifies a batch number; it will be validated against the 'Allocated Batch Number Range'.

This feature is applicable only when batch generation is manual. Therefore, if you enable this option, you must ensure that the Auto Generate option has not been enabled. In a scenario where the User Restriction for Batch Number field is enabled and Auto Batch option has also been enabled, the system displays an error message as "Not a Valid Batch Number For the User".

In case you choose to auto generate batch numbers, the System will not perform the batch restriction validation.

You can invoke the 'Batch Restrictions Maintenance' screen by typing 'STDBRRES' in the field at the top right corner of the Application tool bar and clicking the adjoining arrow button.

Specify the following details in this screen:

- The User Profile for which the restrictions are being maintained. A list of all the User Profiles with access rights to the DE and PC modules is displayed in the option list. You can select the appropriate.
- The branch of your bank for which the restrictions will be made applicable. You can either choose a specific branch or make the restriction applicable to 'All' the branches of your bank.
- The module for which you are maintaining the Allocated Batch Number Range. This can either be PC or DE.
- The batch number range, which is indicated in terms of Start and End numbers. The range that you specify is allocated to the user. For distinct numbers, the start number and end number of the range will be the same.

---

#### Note

While processing DE and PC transactions, the batch number specified by the user is validated against the allotted range. If the validation fails, an error message is displayed.

---

These validations are made applicable even during the Batch Upload operations for the following functions:

1. Journal Online – Single Entry
2. Multi-offset Entry
3. Teller Transaction Input

#### SSO Enabled

To enable Single Sign On (SSO) for your installation check the SSO Enabled check box. This enables restricted login from external systems into Oracle FLEXCUBE.

## General Ledger Purge Days

You can specify here the maximum number of working days, the average GL balance computation for which is to be retained in the System.

### 2.1.4.1 Specifying Cheque Numbering Details

#### Scheme

In Oracle FLEXCUBE, cheque numbers can be generated automatically or can be manually entered. If you indicate manually, you can draw up numbering conventions and assign numbers to the cheques that are issued.

#### Cheque Number Mask

Specify the mask of a cheque number to be used by the bank. You can define numeric cheque mask as a series of N.

While defining an alpha numeric cheque mask, the alphanumeric character should always precede the numeric characters. For example: AANNNN, A being alpha numeric character and N being numeric character. Numeric characters should always follow the alpha numeric characters.

If cheque numbering scheme is 'Automatic' and checksum algorithm is selected, the 'Cheque mask' can be defined as only numeric. The cheque mask can contain only 'N' or can start with a 'T' followed by 'N'. If the cheque mask contains a 'T' in the first position, it indicates that the cheque is of type EURO or COMMERCIAL. If the mask contains only 'N', then the cheque is only numeric and cannot be EURO / COMMERCIAL. An appropriate error message is displayed if cheque numbering scheme is 'Automatic' and cheque number mask defined contains anything other than 'N' or 'T' in the first position.

If the cheque numbering scheme is 'Automatic' and checksum algorithm is selected at bank parameter, the cheque mask cannot be defined as alpha-numeric. The system validates if the cheque mask is alphanumeric and inventory is enabled at bank parameter. The system displays an appropriate error message as 'Alpha-numeric Cheque number is not supported as Inventory tracking is enabled'.

#### Checksum Algorithm

If you choose the automatic generation option you can indicate the algorithm based on which the check digit should be generated. A cheque number consists of three components:

- A check digit
- A cheque type
- A running serial number

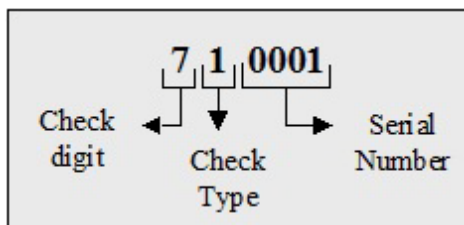

You have the option to choose the algorithm to be used to arrive at the check digit. Currently Oracle FLEXCUBE supports only the Modulo-7 algorithm. Based on this algorithm the check type and serial number is divided by seven, and the remainder is taken to be the check digit. If the remainder is zero, then the check digit is set to seven.

The cheque type indicates whether the cheque is a Euro or Commercial cheque. The numeral 1 before a cheque serial indicates a Euro cheque and 2 indicates a Commercial cheque.

The cheque serial number is generated sequentially starting from 0001. This running serial number is assigned taking into account the last check number issued for the account.

#### **Cheque Numbers Unique For Branch**

For cheque numbers that are automatically generated, you can choose to make cheque numbers unique across the branches of your bank.

If you indicate that serial numbers need not be unique, you can have the same cheque number assigned to cheque leaves of different accounts within a branch. In effect cheque numbers remain unique to an account.

#### **Lodgment Numbers Unique for Branch**

You can indicate whether lodgment leaves must have unique numbers in a branch, or must be unique for individual accounts.

For example, in the Bank Wide Parameters, you have specified that lodgment book numbers must be unique for the branch. This means that lodgment numbers need to be unique across all accounts of that branch. For instance, if a book is maintained with the Start Number as 1, and containing 25 leaves, you cannot start another book in respect of any other account, with these numbers.

If you have specified that lodgment book numbers must be unique to accounts in the branch, and a book is maintained with the Start Number as 1, and containing 25 leaves, you cannot start another book in respect of the same account, with these numbers. However, you can start a book with the same numbers in respect of another account in the branch.

### **2.1.4.2 Specifying TRS Details**

You can maintain the following details that will be used by the system to raise direct debit for Tax Relief at Source (TRS) rebate availed by customers on mortgage loans. The direct debit is raised during the End of Day (EOD) process after the LD batch processes.

#### **Sort Code**

Specify the destination bank code for which the bank raises direct debits for TRS claims.

#### **Account Number**

The destination account for which the bank raises direct debits for TRS claims.

#### **Payment & Collection Product Category**

Specify the Payments and Collections (PC) product category that would be used by the bank to raise direct debits for TRS claims.

#### **Suspense Account**

Specify the account that would be debited with the TRS amount, to credit customer account.

*For more details about processing for TRS, refer the Loans module user manual and the Payments and Collections user manual.*

### **2.1.4.3 Viewing Trade License Details**

#### **Expiry Advice Generation Days**

If the trade license is set to expire on a particular date, the number displayed here denotes the number of days before that date when an advice is generated and sent to the customer informing about the impending expiration.

### **2.1.4.4 Specifying Mandatory Limit Tracking For Customer Type**

You can maintain limit tracking as a mandatory option based on the customer type.

**Corporate**

Check this box if it is mandatory to link customer of Corporate type to credit line.

**Bank**

Check this box if it is mandatory to link customer of Bank type to credit line.

**Individual**

Check this box if it is mandatory to link customer of Individual type to credit line.

If a contract is saved without selecting the limit line for customers checked for mandatory limit tracking, then the system displays the error message as "Limit tracking is mandatory for this customer <Customer CIF>".

---

**Note**

- By default the customer type is selected as 'Individual'. However you can modify it.
  - At the customer maintenance level, system defaults 'Track Limits' option based on the option set here.
- 

**2.1.4.5 Loan Automatic Prepayment Details****Automatic Prepayment Transaction Code**

A provision has been provided to update the transaction code for automatic prepayment. Select the transaction code from the adjoining option list. For a retail lending product, if the automatic prepayment feature is enabled, that is, the automatic prepayment check box is selected in the Retail Lending Product Maintenance screen (CLDPRMNT), then the system validates whether a transaction code is maintained for automatic prepayment at the bank level. If not, then an appropriate error message is displayed

**2.1.4.6 Specifying Cheque Discounting Details****Cheque Return Count for Drawer Blacklisting**

The system displays the number of cheque returns for a drawer. During the cheque return processing, the system check the number of cheque returns against this maintenance and marks the drawer as 'Blacklisted' drawer.

**2.1.4.7 Specifying Passbook Details****Minimum Number of Digits for Passbook**

Specify the minimum number of digits for creating passbook number. The system defaults the minimum value 10. However you can modify it.



## 2.1.5 Specifying UDF Details

You can associate values to all the User Defined fields created and attached to the Bank Parameters Screen. You can view the list of User Defined fields associated by clicking the 'Fields' button. The screen appears as shown below:



You can enter the value for the UDFs listed here in the 'Value' column.

*For more details on how to create user Defined fields, refer chapter 'Creating custom fields in Oracle FLEXCUBE' in the User Defined Fields User Manual under Modularity.*

## 2.1.6 Specifying Account Generation Parameters at Bank Level

Account numbers in your bank are generated in the format of the account mask that you specify through the 'Account Parameters' sub-screen of the Bank-wide Parameters screen.

Click 'Account Mask' button in the Bank-wide Parameters screen. Account Parameters screen is displayed. The screen appears as shown below:

The screenshot shows the 'Account Parameters' window with the following fields and options:

- Customer Account Mask:** Text input field.
- Checksum Algorithm:** Dropdown menu.
- User Defined Algorithm:**
  - Customer Account: Text input field.
  - Consumer Number: Text input field.
  - Start Account Number: Text input field.
  - End Account Number: Text input field.
  - Auto Generate Account:
  - Loan Account Auto Generate:
- Multi Currency Account Input:**
  - Multicurrency Account Mask: Text input field.
  - Multicurrency Checksum Algorithm: Dropdown menu.
  - Multi Currency Account Algorithm: Text input field.
  - Start Multicurrency Account Number: Text input field.
  - End Multicurrency Account Number: Text input field.
  - Auto Generate Multicurrency Account:
- Auto Account Creation:**
  - Start Account Number: Text input field.
  - End Account Number: Text input field.
- Fund Subscription:**
  - Start Account Number: Text input field.
  - End Account Number: Text input field.

Buttons: Ok, Cancel

---

### Note

Since account level parameters are defined at the bank-level, by default these parameters will be defaulted to all the branches of your bank. However, individual branches of your bank will be allowed to change these specifications.

---

#### 2.1.6.1 Specifying Customer Account Mask

Account numbers can either be generated automatically or you can choose to allocate them manually. In Oracle FLEXCUBE you have the option of maintaining three types of account masks.

They are as follows:

- **Alphanumeric** – this type of an account mask is a combination of alphabets and numbers where you can build the mask with components such as the Branch Code, the Account Class, the Currency Code, a check digit, etc
- **Numeric** - is a numeric type of account mask where the checksum algorithm associated with the account mask is either Modulo 11, Modulo 11 with weights or Modulo 97.
- **Pure Numeric** – is a numeric type of account mask, which does not have a checksum algorithm, associated with it. If you are maintaining a pure numeric mask you have to identify the start and end account number which is to be associated with it.

## Alphanumeric customer account masks

The alphanumeric customer account mask can have a maximum of twenty alphanumeric characters. It can comprise of one or more of the following elements in combination:

- **Account Class** — Use “AClass” to indicate that the account class to which the account belongs should be part of the mask.
- **CIF Number** — You can incorporate the nine-character CIF code assigned to the customer into the mask. To do so indicate ‘CIF Number’ in the mask.
- **Currency** — To add the currency of the customer account, use ‘CCY’
- **To indicate an alphabet or number** — Each element used to define the mask would represent a single character. To represent an alphabet of the English language, indicate “a”. To represent a number, indicate “n”.
- **Punctuation Marks** — When defining the customer account mask you have the option of separating the elements. To do this, you may use the following punctuation marks:
  - Dash (-)
  - Comma (,)
  - Asterisk (\*)
  - Full stop (.)
  - Forward slash (/)

**For Check Digit** - The last character in the customer account mask should always be a ‘D’ or ‘d’. This indicates the check digit, which is generated by the system. When specified in the mask, the check digit component is generated using either of the following methods:

- Modulo 11
- Modulo 97
- Modulo 11 without Weights
- User Defined Algorithm

If you choose Modulo 97, all components of the account mask (for example, the Branch Code, the Account Class, the CIF ID, etc.) should be numeric. For example, if you enter ‘bbb’ in the account mask field (indicating that the branch code should be part of the account number), and choose the Modulo 97 option, ensure that the branch code is a numeric value, such as ‘000’, ‘123’, etc.

---

### Note

The maximum length of twenty characters for the customer account mask is inclusive of the check digit

---

All customer accounts that are entered in any branch of your bank will compulsorily have to conform to the mask.

For example, you want the following elements to be part of the customer account mask:

The currency of the account

The nature of the account (savings, current etc.) and

The Customer Id

Given the above criteria the customer account mask would be:

AClassCCYCIFNUMBERn'D'

This corresponds to:

LLLLL\$\$\$CCCCCCnD

All customer accounts entered in any branch of your bank would now comprise of these elements, in the order defined in the mask.

A customer with CIF number 10005 has opened his first USD savings account with your bank, and the Account class for savings accounts is INDSB. His account number would read:

INDSB-USD-10005-1'D'

Similarly, the second GBP current account of a corporate customer with CIF Number 20005, would read

CUCOR-GBP-20005-2'D'

'CUCOR' being the account class representing current accounts of corporate customers.

**Characters Supported for Various Fields in Account Mask:**

Field	Mask character	Max length supported
Account class code	L	6
Account code	T	4
Currency code	\$	3
Currency type	Z	3
Customer number	C	9
Branch code	b	3
Serial Number	S	-
Numeric value(user to input)	n	-
Alphabet value(user to input)	a	-
UDF	U	-

---

**Note**

You must specify the mask character in the same case as mentioned above.

---

Field	Case 1	Case 2	Case3	Case4
CIF number	015005624	015005624	015005624	015005624
Currency code	GBP	GBP	GBP	YUV
Currency type	O	O	O	YA1

Field	Case 1	Case 2	Case3	Case4
Account class	SAVINV	CACIN	123456	SAVINV
Account code	SA12	SA12	8909	SA12
Branch code	014	015	015	015

Mask maintained	Booked against	Chk sum Algorithm	Generated Account Number
LLLLLL\$\$\$CCCC CCCCSSd	Case 1	Modulo 11	SAVINVG- BP15005624019
LLLL\$\$\$TTCCCC CCCCSSd	Case 1	Modulo 11	SAVIGBP- SA15005624028
LLLLLL\$\$\$ZCCC CCCnnd	Case 2	Modulo 11	CACINGB- PO005624997
nnnnnnnD	Case 1	Modulo 11	09888994
bbb- bLLLZZZCCCC nnd	Case 4	Modulo 11	015SAVYA105624 074
LLLLLL\$\$\$CCCC CCCSSDD	Case 1 / 2	Modulo 97	Error. Will not be able to generate the check digit. The control digits value must be numeric for Mod- ulo 97.
LLLLLLT- TTTTCCCCSSD D	Case 3	Modulo 97	123456890900562 40150

### Customer Account Number Containing a UDF Value

While defining a customer account if you include 'U' in the account mask, it indicates that the customer account numbers will have the value of a user-defined field.

The number of U's will depend on the length of the UDF value that has to be included in the customer account number. For example, if you want to include 3 characters from a UDF, the account mask should consist of UUU (in addition to other parameters which you want to include in the customer account numbers).

---

#### Note

- A user-defined field can be part of the customer account mask only if the customer account number generation is not automatic.

- Since a customer account number in Oracle FLEXCUBE can accommodate only up to 20 characters you have to ensure that the account mask you have defined does not exceed this number.

---

### Numeric Account Masks with Modulo 11 and Modulo 97 as Checksum Algorithms

A numeric type of mask can have a maximum of fifteen numeric characters, inclusive of the checksum algorithm.

If you associate Modulo 11, as the checksum algorithm, a single character D will be appended to the numeric mask. Let us assume that you have an account mask with five numeric values – 'nnnnn' and associated Modulo 11 as the checksum algorithm. The system automatically appends 'D' to the numeric mask. The generated account numbers will have the following format – nnnnnD.

If the Account mask is Alphanumeric, and check sum digit is needed as per Modulo 11, then the check digit- 'd' has to be manually specified in the mask. For example, if you need an account mask as 'bbbCCCCCSS', then considering Modulo 11 check sum digit, you need to input the mask as 'bbbCCCCSSd'.

Similarly, if you associate Modulo 97, with an account mask of five numeric values, the system appends a double-digit value of DD to the mask. The generated accounts will have the following format – nnnnnDD

---

#### Note

As system automatically appends DD in case of Modulo 97, if you input the customer mask with 'D', system will display the error message as 'Cannot have D denoting Alphanumeric Characters'.

if you input 'dd' in the mask, then system displays the error message as 'Cannot have dd denoting Alphanumeric Characters in account mask while using mod11 Checksum algorithm'.

---

System automatically appends DD always at the end of the Mask.

Algorithm	Contents of the mask	Check sum digit	Check digit character	Remarks
Modulo 11	Alphanumeric	User to input	d	Check digit should be specified manually in the mask
Modulo 11	Numeric	Auto append	D	System appends the check digit automatically, however, the mask characters should be 'n' for example, nnnnD

Algorithm	Contents of the mask	Check sum digit	Check digit character	Remarks
Modulo 97	Alphanumeric	Auto append	DD	If the values for the mask are alphanumeric, then check digit will not be generated
Modulo 97	Numeric	Auto append	DD	-
wing format – nnnnnDD.				

### Numeric Account Masks with 'Modulo 11 with Weights' as Checksum Algorithm

The account mask with 'Modulo 11 with Weights' algorithm can have a maximum of 13 digits. It comprises of the following elements:

- Branch Code (3 digits) – Indicates the branch at which the customer account is maintained.
- Account Code (1 digit) – This will indicate the account code of the account class to which the customer account belongs. During account number generation (in the Customer Account Maintenance screen), you need to select the account class from the option-list provided. The system will then convert it to the account code maintained for that account class. The account code thus becomes a part of the customer account number.
- Currency Type (1 digit) – This will represent the currency type of the account currency. As explained for account code, you will select a 3-digit currency code during account generation. The system will convert it to the currency type maintained for that currency. The currency type will then form a part of the account mask.
- CIF Number – You can also include the CIF number of the customer as part of the account mask. The CIF number is automatically generated by the system when you capture customer details in the Customer Information Maintenance screen. During customer account maintenance, you can select the CIF number from the option list provided.

Sequence Number (1 digit) – The sequence number is automatically generated by the system for a combination of account code + currency type + customer. This means that, for this combination, you can maintain nine accounts. To maintain the 10<sup>th</sup> account for the same combination, the system will use the 'Dummy Customer No. Range' maintained at the branch level'.

*Refer the section titled 'Creating Branches' of this document for more details on dummy number range.*

- Control Number (1 digit) - This is the 13<sup>th</sup> digit of the account number. This number is also automatically generated by the system based on the 'Modulo 11 with Weights' algorithm.

For the above combination, the customer account mask would be:

'bbbTZCCCCCSd'

Where,

- bbb – is the branch code
- T – indicates the account code

- Z – is the currency type
- CCCCCC – is the CIF number of the customer
- S – is the sequence number for a combination of account code, currency type and customer
- d – is the control number generated by 'Modulo 11 with Weights' algorithm

The following example illustrates the manner in which the system calculates the 13<sup>th</sup> digit for a customer account number using the 'Modulo 11 with Weights' algorithm.

Assume that the account number of a customer is '000-4-1-123456-1'. As per this algorithm, the value of each position (1 to 12) is multiplied with the weight for each position (the weights are provided by your bank). Further, the sum of the product obtained is divided by 11. The remainder of the division will determine the value of the 13<sup>th</sup> digit.

The position-wise weight and account number and the product (of weight and number) is as follows:

Position	1	2	3	4	5	6	7	8	9	10	11	12
Weight (W)	2	4	8	5	10	9	7	3	6	2	3	5
Acct. No (N)	0	0	0	1	2	3	4	5	6	4	1	1
Product (W * N)	0	0	0	5	20	27	28	15	36	8	3	5

Sum of the product = 147.

Divide the value 147 by 11 to obtain the remainder

Remainder = (147/11) = 4

As per this algorithm, if the remainder is 10, then the control number will be zero. If it is any value other than 10, the remainder itself will be taken as the control number.

Therefore, the 13<sup>th</sup> digit = 4.

The customer account number will now read as '000-4-1-123456-1-4'

### **Numeric Account Masks with User Defined Algorithms as Checksum Algorithm**

If the check digit component within a Customer Account Number is to be generated using a method of your choice you must identify the following:

- The User Defined Algorithm for the Customer Account Number – this identifies the name of the user-defined algorithm for check digit generation of account numbers.
- The User Defined Algorithm for Consumer Number – this stores the name of the user-defined algorithm for validating consumer numbers.

While capturing Customer Account numbers, the System checks for your specification for the checksum algorithm. If you have selected User Defined, the check digit is generated using the specified user-defined algorithm.

- Unused sequence numbers of CASA cannot be tracked for re-use if the sequence number is generated by user defined algorithm

Since these parameters are maintained for your bank, they are defaulted to the branches of your bank. You will not be allowed to change these for a specific branch of your bank.



---

**Note**

Unused sequence numbers of CASA can be tracked for re-use only if the customer account mask contains numeric mask.

---

- If the account mask contains any of the following characters, the lost account number is re-used only if the same customer opens another account with the same branch code, account class, currency & sequence number combination:
  - C(Customer number)
  - b(Branch)
  - T(Account class)
  - Z(Currency)
  - S(Single digit sequence number)
  - SS(Double digit sequence number)
- Unused customer account number is reused in the same day, except in the following scenarios:
  - Session termination for the current user
  - Multiple windows opened for the same Function ID by the current user.

**Pure Numeric Masks**

A numeric account mask, which does not have a checksum algorithm associated with it, is called a pure numeric mask. Since it does not have a checksum algorithm associated with it you will have to specify the start and end account numbers and enable the auto-generated option.

The start account number forms the basis on which customer accounts numbers are to be generated. Similarly, you will not be allowed to maintain account numbers beyond the end account number.

Let us assume, that you have maintained the following details in the Account Parameters screen at your bank:

<b>Customer Account Mask</b>	<b>nnnnn</b>
Start Account Number	1
End Account Number	50000
Cust Account Auto Generate	Yes

While generating a new account number the system will automatically generate 00001 corresponding to nnnnn. The next account will be – 00002.

---

**Note**

'n' is allowed in the account mask, only if auto account number generation is selected at branch level.

---

**Including Value of a UDF as Part of Customer Account Number**

If your bank has not opted for automatic generation of account numbers, you can specify a structure for customer account numbers. The structure can be a combination of CIF number, account class, value of a user defined field, currency, branch code, alphabets/numeric and a check digit which is automatically generated by the system.

For example, an account mask is CCCCCCLLbbbUUU\$\$\$ad.

This implies that a customer account number will contain:

CIF Id – represented by C

Account Class represented by L

Branch Code represented by b

Values of a user defined field represented by U

Any user-input alphabet represented by a (enter 'n' if you want to include a numeric)

Currency Code represented by \$\$\$

A check digit (which is automatically generated by the system) represented by 'd'

---

**Note**

The number of C's in the account mask should match with the CIF mask that you have specified. For instance, if the CIF mask is aaaannn (7characters), the account mask should consist 7 C's to include the CIF Id in the customer account number.

---

The value of a user-defined field can be used to include an additional parameter (for example: the code of the country to which the customer belongs) in the customer account number.

The steps involved for including the value of a user-defined field in a customer account number are as follows:

1. Include 'U' in the customer account mask to indicate that the customer account number should contain the value of a UDF
2. Create a new user defined field
3. Link it to the Function Id STDCIF
4. Specify the value of the user defined field at the time of creating a customer
5. Specify the UDF whose value has to be included in the customer account number to the Oracle FLEXCUBE implementer. The implementer will indicate this at the back end.

**Maintaining Ten Digit Masks with Running Sequence Numbers**

You can maintain a 10-digit mask of any combination, wherein the last two digits will necessarily be a running sequence number. This number will be automatically generated by the system. For instance, if you want to maintain a mask for the customer number and currency combination followed by the two digit running number, you will have to maintain the mask as CCCCC\$\$\$\$SS. Here, CCCCC stands for the customer number, \$\$\$ stands for the currency of the account and SS stands for the running number. The system will generate the last two-digit number in a continuous sequence irrespective of the combination that you specify in the mask.

For example, let us assume that you want the customer account number to be a combination of the customer number and the account currency followed by the serial number. To achieve this, you have to specify the mask as CCCCC\$\$\$\$SS. Based on this mask, for a customer with CIF ID 40207 with account in USD, the account number will be 40207USD01. If the same customer has another account in GBP, the next account number would be 40207GBP02. That is, there will not be any holes in the system generated running number.

## 2.1.6.2 Specifying Multicurrency Account

### **Multicurrency Account Mask**

Specify the multi-currency account mask. The system supports 15 characters of PID number as Multicurrency Account Mask. If lesser number of digits are considered from PID mask, then the system considers the last set of digits. In case the PID digit is less than the mask defined then it should be prefixed by '0'.

### **Multicurrency Checksum Algorithm**

Select the checksum algorithm details from the adjoining drop-down list. This list displays the following values:

- Modulo 11
- Modulo 97
- Modulo 11 with weights
- Modulo 10
- User Defined

### **Multicurrency Account Algorithm**

Specify the multi-currency account algorithm details.

### **Start Multicurrency Account Number**

Specify the start number for multi-currency accounts.

### **End Multicurrency Account Number**

Specify the end number for multi-currency accounts.

### **Auto Generate Multicurrency Account**

Check this box to generate unique multi-currency accounts automatically.

If this box is unchecked, then you need to specify the account number details for each currency while creating an account.

The 1<sup>st</sup> account opened (through account maintenance screens or through Gateway) should remain in 'Active' state. You cannot open accounts in different branch using multi currency account class for the same customer. The Account Branch number for all the assigned CASA accounts will be same as that of the 1<sup>st</sup> account (LCY) created.

The system will check if the 1<sup>st</sup> account opened under the Multicurrency Account Class is in LCY (Branch Account Currency).

On initiation of a transaction, the system will automatically create the account and post the transaction for inactive accounts.

At the time of account creation, system will replicate the following data maintained for the 1st account/ LCY account to the automatically created account:

- Account Description
- Account Type
- Mode of Operation
- Account Open Date
- Address
- Location
- Media
- IC special condition

- Instructions
- Restrictions MIS
- Joint Holders
- Linked Entities
- Account Status
- Statement
- Account signatory, only if 'Replicated Customer Signature' is selected during manual account creation.

In case, if the transaction is reversed, the system will not roll back the account opening/creation process.

In case if the first account opening (manual) fails due to any reason, for instance, Failure of Initial funds, the entire process of account opening will be rolled back.

The system will validate that for a customer and currency combination, there should be only one account under the multicurrency account class. The system will perform this validation at both account creation and at account authorization level.

The system will validate for the following 'Account Class' level validations during account creation for assigned CASA account numbers/ Inactive accounts:

- Initial Funding
- Currency restrictions
- Debit Card Request
- Cheque Book Request
- Restrictions - Defaulted data will be removed automatically for Inactive Accounts since 'Special Condition' is 'NA', by default

---

#### **Note**

Following data will not be captured for Inactive accounts:

The sub sections such as, Limits, Deposit Instructions, Debit Card Request, Sweep in Set-up, Instructions, BIC, Interim Transactions Report, Standing Instructions, Billing Parameters Documents, Restrictions and Cheque Book Request

Intermediary Details in 'Auxiliary' tab

---

The system will maintain Interest/Charge calculation and application, account statement and passbook separately for each account. Also, all the account activities in the entire life cycle of an account till the closure date will be maintained separately.

- In case if the account class is modified at a later stage, i.e., increase in the number of allowed currencies, then,
  - For customers with a multicurrency account, the bank should open the accounts in new currency, if required, provided the customer has LCY account opened in the multicurrency account class. Newly added accounts should be in active status and it should be mapped to the existing Multi-currency Account number of the customer and account class combination. In case if a customer does not have an LCY account opened, then the system will perform the validation to open an LCY account
  - In case if new multicurrency accounts are opened, the system will assign the account number for newly added currency under account class.

- In case if the account class is modified at a later stage, i.e., decrease in the number of allowed currencies, then,
  - For customers with a multicurrency account, the assigned accounts will be opened even if those currency details are removed at account class level. The system will not validate against currency restriction maintained at account class level.
  - In case if new multicurrency accounts are opened, the system will assign the account number for newly added currency under account class.

The assigned CASA account numbers will be available for the following screens:

- 360 Degree Retail Customer View (STDRETVW)
- 360 Degree Corporate Customer View (STDCUSVW)

The system will display the assigned CASA account number as a part of TD account opening and redemption for the following screens:

- Term Deposit Payout Details
- Term Deposit Payout
- ICDREDMN

The system will display the assigned CASA account number as a part of Teller transaction for the following screens:

- 1401
- 1006
- 8207

In case if the transaction is deleted before authorization or reversed after authorization, the account will remain in active state.

---

**Note**

Multicurrency Account Class cannot be closed unless all the accounts under the same is closed first. Also at any given point of time there can be only one active 'Multicurrency Account Class'.

The system should not allow an account to be transferred from multicurrency account class to a non multicurrency account class and vice versa.

Customer Aggregation cannot be initiated from customer who has a multicurrency account to a customer who also holds a multicurrency account.

---

### **2.1.6.3 Specifying Auto Account Creation Parameters**

You may wish the system to automatically create current accounts for customers at the time of loan initiation. These system-created current accounts are for use as settlement accounts.

Here, you need to specify the range of numbers available for such auto created accounts by mentioning a start and an end number.

If you wish to retain the facility of auto creation of current accounts at loan initiation, you will have to ensure that the account number mask does not have any user input character.

## 2.1.7 Maintaining Zengin Characters

You can maintain Zengin characters by clicking on 'Zengin Characters' button in 'Bank Parameters' screen.

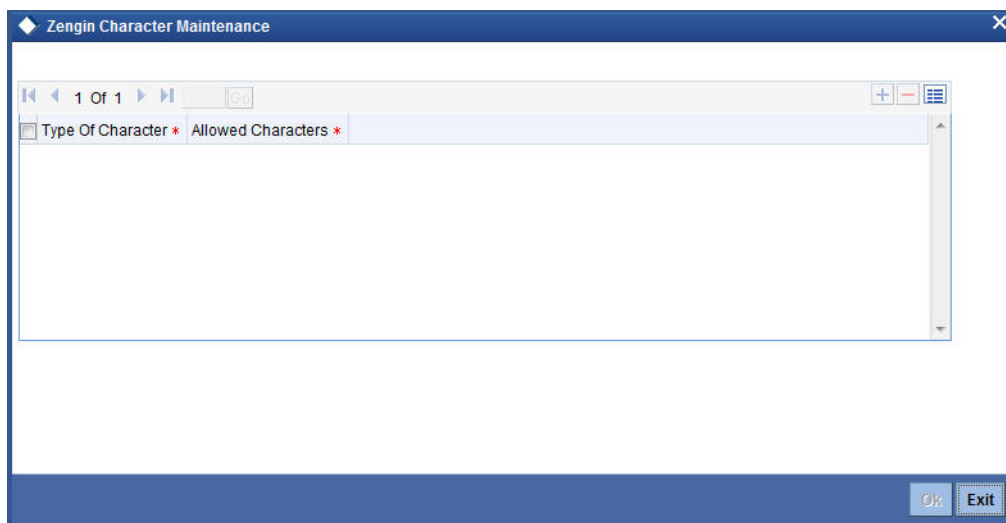

You can specify the following details:

### **Type of Character**

Select the type of character from the adjoining drop-down list. This list displays the following values:

- English
- Numbers
- Katakana
- Special Characters

You can select any one type of characters and add multiple allowed characters in the 'Allowed Characters' field.

A character can be entered only once, if the same character is entered twice, then the system will display the following error message:

**Duplicate Value X**

For instance, if you have selected 'Type of Character' as 'English' and if you try to enter the value 'A' twice in the 'Allowed Character' field, then the system will display the following error message:

**Duplicate Value A**

Also, you can enter multiple characters in the same field. For instance, if you have chosen 'Type of Character' as 'English', then you can enter ABCE...Z (A to Z) in a single 'Allow Character' field

A type of character can be selected only once, if duplicate value has been selected for the same then system will display the following error message:

**Type of Character Cannot be Duplicate**

---

**Note**

When the “Type of Character” is chosen as English, the character entered in the “Allowed Characters” field will be validated against English capital (A to Z) & English small (a to z).

When the “Type of Character” is chosen as Numbers, the character entered in the “Allowed Characters” field will be validated against the numbers (0 to 9).

Ensuring whether the right value that is entered into the right type of character for special characters and Katakana scripts need to be controlled operationally.

---

**Allowed Characters**

Specify the number of Zengin characters allowed.

If an allowed character is deleted at any point in time, then the deleted character will be restricted for new customer creation and modification of existing customers.

The system performs the following validations against Zengin characters set during customer creation/modification:

During customer creation or modification in STDCIF/STDCIFAD screens, the values entered in Full Name, First Name and Middle Name needs to be validated against each character set maintained at STDBNKPM level. If a character entered in the above mentioned fields is not maintained in STDBNKPM screen then the system will display the following error message:

**Character X is not Allowed**

During customer creation or modification in STDCIF/STDCIFAD screens, the values entered in Full Name’ field in ‘Katakana’ script Name needs to be validated against each character set maintained at STDBNKPM level. If a character is entered in the ‘Full Name’ field in Katakana scripts and not maintained in STDBNKPM screen then system will display the following error message

**Character X is not Allowed**

During creation or modification of multiple names in Customer Name in STDCIFNM screen to be validated against the character set maintained at STDBNKPM level.

When an incoming Zengin message has been received, the beneficiary name available in that message needs to be validated against the following values.

- Full Name, Middle Name and Last Name fields in STDCIF.
- Full Name field in Katakana scripts in STDCIF.
- Multiple Names maintained in Customer Name field in STDCIFNM.

When the RT web service is consumed by the channels and if the value has been provided the Zengin Transaction and Beneficiary Name fields then the Beneficiary Name will be validated against the following values.

- Full Name, Middle Name and Last Name fields in STDCIF.
- Full Name field in Katakana scripts in STDCIF
- Multiple Names maintained in Customer Name field in STDCIFNM.

If the Beneficiary name exactly matches with any of the above mentioned values then the transaction will be processed otherwise it will be rejected.

## 2.1.8 Defining Bank-wide Preferences

In the Bank-Wide Preferences screen, you can specify the following:

- The route of inter-branch accounting — through HO, through RO or directly between branches
- Exchange rate preferences — to be maintained for the bank as a whole or at each branch
- Preference relating to update of GL balances — on-line or at the End of day
- Preference relating to Position Accounting
- Interface details

Click the 'Preferences' button to invoke the 'Preferences' screen.

### Interface Details

Specify the following details:

#### Journal Account

Specify Journal Account of the Interface details

#### Width

Specify width of the interface.

#### Emperor's Coronation Date

Specify the date of coronation of the current emperor.

### Inter Branch Scheme

Indicate the following details.

#### Inter Branch Account Schedule

You can indicate the route through which accounting entries for inter-branch transactions should be settled. You can select one of the following routes from the option list that is available:



- Choose 'Through HO' to indicate that inter-branch transactions should be settled through the Head Office
- If you specify 'Through RO' the accounting entries would be routed through the regional office. If two branches involved in a transaction do not report to a common regional office, the accounting entry would be routed through the HO
- If you specify 'Direct', each branch would have a direct accounting relationship with every other branch

The receivable and payable accounts between the branches, referred to as 'due from' and 'due to' accounts, are maintained in the 'Inter-branch parameters' screen.

For example, suppose the University Savings Bank has the following set up for its head office and branches in Headington, Oxford:

Roosevelt Avenue Branch, is the HO with Branch Code 000

Foxlake Drive Branch (Branch Code 001)

Mountainwood Road branch (Branch Code 002)

You have indicated that inter-branch transactions should be routed through the Head Office. Ms. Tanya Agnihotri has an account in Branch 002. She makes a cash withdrawal from Branch 001. This being an inter-branch transaction, Branch 001 will have to recover the money from Branch 002.

In this example the following movement of funds is involved:

- At Branch 001, the cash account is credited for the transaction amount and due from Head Office account debited.
- At Branch 000, the due from Branch 002 is debited and the due to Branch 001 is credited.
- At Branch 002, the Customer Account is debited and the due to Head Office account credited

### **Inter Branch Entity**

Oracle FLEXCUBE allows you to post accounting entries related to inter-branch transactions to either of the following:

- Customer Accounts
- General Ledgers
- Both

If you select Customer Accounts as an inter-branch entity, you can specify the currency and the actual customer accounts involved in an inter-branch transaction between two branches of your bank. If the inter-branch entity is specified as 'General Ledgers', you need to specify the internal accounts that would be involved in a transaction between two different branches of your bank. If you select 'Both' option, it indicates that inter branch accounting entries could be posted for both GL and Customer accounts.

### **Fund Inter Branch Scheme**

Indicate the following details.

#### **Inter Branch Account Schedule**

You can indicate the route through which accounting entries for inter-branch fund transactions should be settled. You can select one of the following routes from the option list that is available:

- Choose 'Normal' to indicate the inter-branch routing defined for corporate transactions will be applicable to the inter-branch fund transactions as well.
- Choose 'Through HO' to indicate inter-branch transactions should be settled through the Head Office.
- If you specify 'Through RO' the accounting entries would be routed through the regional office. If two branches involved in a transaction do not report to a common regional office, the accounting entry would be routed through the HO.
- If you specify 'Through RO and HO', the accounting entries would be routed through the Regional Office of the first branch, then the Head Office. From the Head Office, the entries would be routed through the Regional Office of the second branch.
- If you specify 'Direct', each branch would have a direct accounting relationship with every other branch.

The receivable and payable accounts between the branches, referred to as **due from** and **due to accounts**, are maintained in the '**Inter-branch parameters**' screen.

### **Inter Branch entity**

Oracle FLEXCUBE allows you to post accounting entries related to inter-branch fund transactions to a General Ledger that you have specified.

If you choose '**Normal**' as the inter-branch routing, and you have not selected the option 'Allow Corporate Access' in the Branch Parameters screen, the Inter Branch transfer options you have chosen will be used.

If you have selected the option 'Allow Corporate Access' in the Branch Parameters screen and the branch is a fund branch, the entity will be defaulted as General Ledger. The GL will be based on the maintenance you have carried out in the Fund Inter Branch Accounts Maintenance screen, for the fund id. The same is explained in the chapter **Accounts for Inter-branch transactions**.

### **Online GL Updates**

The update of GL balances can take place either on-line or during End of Day. For an on-line update select this checkbox.

### **Re-generate unused CIF ID**

Check this box to indicate that the unused CIF ID needs to be re-generated automatically.

---

#### **Note**

Unused sequence number's of CIF is tracked for re-use only in the following scenarios:

- If the user cancels without saving new customer maintenance.
  - If the user deletes a new customer before authorizing it.
  - Unused customer account is regenerated on next day post cancelling or deleting.
- 

### **Re-generate unused CASA no**

Check this box to indicate that the unused CASA number needs to be re-generated automatically.

---

#### **Note**

Unused sequence number's of CASA is tracked for re-use only in the following scenarios:

- If the user cancels without saving a new CASA maintenance.
- If the user deletes a new CASA before authorizing it.

- The sequence numbers marked during delete operation is re-used in ascending order. The sequence numbers marked during cancel operation is reused only from next working day to prevent concurrency issues.
- 

#### **Auto Generate PID No**

Check this box to automatically generate PID No.

#### **Auto- Generate CIF Numbers**

This indicates whether or not the CIF should be generated automatically. Check this box to indicate the CIF number needs to be generated automatically.

---

#### **Note**

Unused sequence number's of CIF is tracked for re-use only if the CIF is generated automatically.

---

#### **Re-generate Unused PID No**

Check this box to automatically re-generate unused PID numbers.

#### **Re-Generate unused Multi-currency Account No**

Check this box to automatically re-generate unused multi-currency account number.

#### **Use Head Office Exchange Rates**

Exchange rates are maintained for a currency pair and are used to calculate the equivalent of one currency against the other. These exchange rates can be maintained in each branch or at the Head office. You can indicate your preference.

If you check against the option 'Use Head Office Exchange Rates' the exchange rates maintained at the Head Office will be made applicable to all branches of the bank. Leave it unchecked to indicate that exchange rates should be maintained at each branch.

This value is used to inherit the USE HO EXCHANGE RATE field at branch param level.

#### **Position Accounting Required**

You can retrieve the position of a foreign currency, any time, by opting for position accounting in your bank. When you opt for position accounting, you maintain a Position GL and a Position Equivalent GL for every foreign currency maintained in your bank. The Position GL reflects the current position of the currency.

If you opt for position accounting while defining Bank-Wide Parameters, you have to maintain Position GLs and Position Equivalent GLs for every foreign currency that your bank deals in. When maintaining GLs for your bank, you can opt to link the different currencies, associated with the GL to either of the following:

- The Position GLs that you have specified for the currency (Your specifications in the Currency Definition screen will default here)
- Position GLs of your choice

#### **Daily MIS Refinancing**

As part of setting up the bank level preferences you can indicate whether MIS refinancing processing is required on a daily basis for the particular branch of your bank.

If you indicate that MIS refinancing should be done on a daily basis, refinance processing will be done on a daily basis for the following modules:

- Loans and Deposits
- Money Market

---

**Note**

You can indicate the rate type that is to be used for individual LD, and MM transactions while processing the contract.

---

**Propagate Floating Rates to Branches**

You have to indicate whether the floating rates maintained at the head-office of your bank should be propagated across all the branches of your bank.

Check the box positioned next to this field to indicate that floating rates need to be propagated across branches. Consequently, each time you maintain a floating rate for a particular rate code and currency combination at your bank, a corresponding floating rate record will be created and sent to all the branches of your bank.

**Limits History Required**

You can indicate whether date-wise limits history needs to be maintained for the Bank. If you choose to enable this option, the limits history is maintained at the following levels:

- Liability level history for storing liability records
- Limit level history for storing Lines records
- Line level history for storing Line Utilization records

Conditions for collating Limits History data:

- There is no retrospective effect on limits history.
  - Back-valued contracts and account transactions do not result in any adjustment to the previous records in the history. Such transactions are inserted with the current EOD date. Similarly any future-dated contracts and account transactions are also inserted with the current EOD dates.
  - In cases where the main line is changed to a sub line, the utilization is transferred from the old main line to the new main line and the effect cascades to the ultimate parent line. But existing records are not changed or updated.
  - Existing data will not reflect the change in the liability number for a customer.
- Revaluation has no effect on the limits history data
- Limits history is not maintained country-wise

The data is archived during the EOD processing. The history data is not updated for holidays.

---

**Note**

If there is no change for a liability/limit/line, data is not archived for that day.

---

---

**Note**

This option can be enabled or disabled at any point of time. Limits history will be recorded with effect from the day the option is enabled. Disabling the option will however not automatically purge history data.

---

You have the option of querying Liability history and drilling down to Limits Line history and further drilling down to Contract-wise Utilization history. Clean risk data is displayed only as of the date of query and history for the same is not maintained.

### **Branch wise Limits**

This option indicates whether or not the limits tracking must be done at the branch level. If this box is checked, you will be allowed to view/change only the lines created from that branch for a given liability.

To illustrate, if you open any credit line facility in branch BR1, then in the Limit Restriction screen, the only branch available will be BR1.

Checking this option will also allow you to View details of line utilization at the branch level in the Limits Query screen.

For a total utilization of a global customer maintained in HO, you would have to generate a report of the limit utilization for each instance.

### **Pairwise Positioning Required**

You have to select this option to indicate whether pair wise positioning entries need to be stored/handed off or not. If selected, the system will store position creating pair entries separately for handoff to other external systems.

When processing accounting entries, the system will check whether you have opted for pair wise positioning. If you opt for this option, the system will check for the following conditions in all the accounting entries that are posted:

- The set of entries posted are balanced i.e. total LCY debit is equal to total LCY credit
- At least one pair of accounting entry is in FCY
- Both the currencies are not the same

If the above conditions hold true, the system will store the entries along with the following information:

- Dr. Account: indicates the debit leg's account GL
- Cr. Account: indicates credit leg's account GL
- Event Code: is the event of the transaction
- Dr CCY/Bought Currency
- Dr. Amount/Bought Amount
- Cr. CCY/Sold Currency
- Cr. Amount/Sold Amount
- Dr Booking Date/Cr Booking Date
- Dr Value Date/ Cr Value Date
- Dr Transaction Code/Cr Transaction Code
- Exchange Rate
- Hand Off Flag

---

#### **Note**

While passing pair wise position entries, the main component will be passed with TRF\_AMT tag and the equivalent entry will be passed with the AMT\_EQUIV tag.

---

In case of accruals/reevaluation also, if position entries are created, the corresponding entries will be stored separately for hand off.

---

**Note**

Pair-wise Positioning Required will decide whether position creating pair entries need to be stored by the accounting processor separately for handing off to other system.

---

**Period for Customer Names (in Days)**

Specify the total number of days during which multiple customer names are valid in the system.

This field will take only positive integer values up to 5 digits. If the Period for customer names field is not positive, then the system will display an error message.

---

**Note**

- Period for Customer Names (in Days) field can be modified at any time. When multiple customer names are added in the account level, this value is used in the default population of 'Valid Till Date' field in the STDCIFNT screen.
  - When Period for Customer Names (in Days) field is left blank, then the 'Valid Till Date' field in the STDCIFNT screen will also be blank and the name will remain valid indefinitely.
- 

**Junior NISA External System**

Specify the external system from where debit transactions for Junior NISA accounts can be performed.

**Propagate CIF to other Nodes**

You need to indicate whether or not the CIF number maintained in HO has to be propagated to other branches present in different instances. Check this box to indicate the CIF number has to be propagated to other Nodes/instances.

**Propagate Customer Addresses to Nodes**

You need to indicate whether or not the customer addresses maintained in HO has to be propagated to other branches present in different instances. Check this box to indicate the Customer addresses has to be propagated to other Nodes/instances.

**Propagate Bank Instruction Codes Details to Nodes**

This indicates whether or not the BIC data maintained in HO has to be propagated to other branches present in different instances. Check this box to propagate BIC details.

**Maintenance of Customer Identification Mask at Branch/Node level**

This option gives you the flexibility to define different CIF masks at the Nodes/Bank level. If you select 'Bank' from the option list, then the CIF mask given at Bank level will be applied to all the branches under it.

**Mudarabah Fund Shareholder Balance Type**

Specify whether the system should consider the month-end balance or the monthly average balance of the GL to compute the shareholders' investment in the linked *Mudarabah* fund. Choose from the following options available in the drop-down list:

- Monthly Average Balance
- Month End Balance

The option specified here will be common to all the shareholder GLs identified under the *Mudarabah* fund and once *Mudarabah* fund shareholder balance type is input and authorized, it will not be allowed to modify later.

### Customer Service Model Effective Month

The system displays the month in YYMM format. The customer service model effective month will be the application date month.

### Staff Account Restriction Required

Check this option to apply staff account restriction at the bank level.

### Auto Account Closure

Check this box to enable Account Auto Closure functionality.

If you select 'Node' from the option list, you will need to maintain CIF masks at the Node level in the 'Node-wise CIF Mask Maintenance' screen. This would ensure that the branches maintained in different nodes/instances have different CIF masks.

Click 'Nodewise CIF mask Maintenance' button to access this screen. The screen appears as shown below:

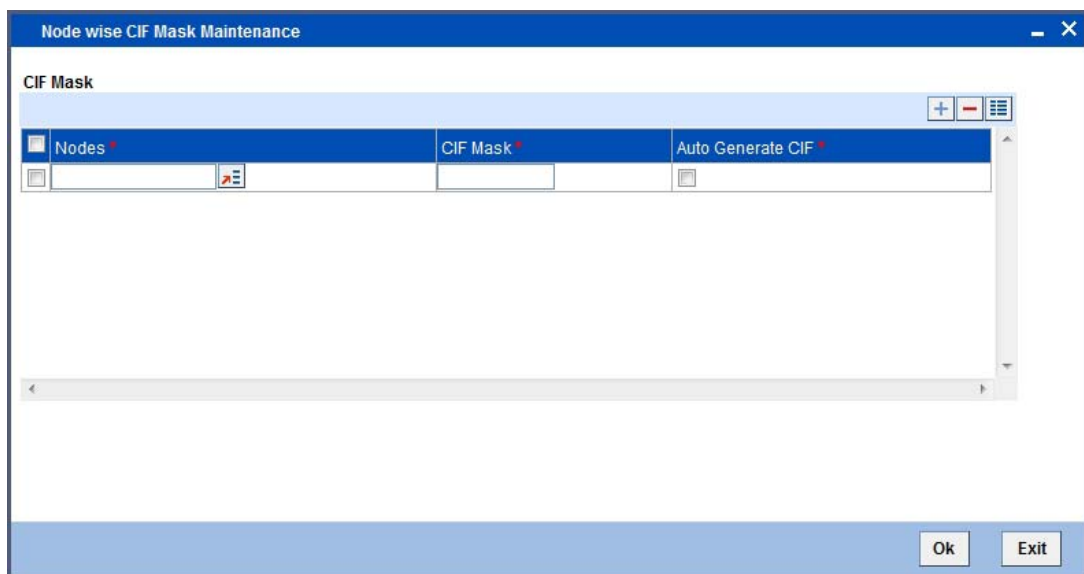

You can specify the following details here:

#### Nodes

This indicates the node/instance for which the CIF mask is required. Select a node from the option list provided.

#### Customer Identification File Mask

This indicates the CIF mask for the corresponding instance/node. Select a CIF mask from the option list provided.

#### Autogenerate Customer Identification File Number

This indicates whether or not the CIF should be generated automatically. Check this box to indicate the CIF number needs to be generated automatically.

#### Allow Inventory Tracking

You can use this check box to allow/disallow inventory management and tracking. To use inventory management module, check this box.

---

#### Note

If inventory tracking is allowed then 'Cheque Numbering Scheme' should be left blank/null.

---

For more details on Inventory Tracking, refer the Instruments Inventory Tracking User Manual.

## 2.1.9 Maintaining FATCA Preferences

In this screen, you can maintain the details regarding the banks' own FATCA classification. You mainly need to maintain the details in the following screen to identify:

- If FATCA is applicable to the bank
- The banks' own FATCA classification
- The banks' IRS issued EIN as well as its issue and expiry date

You can maintain these details by clicking the 'FATCA' tab. The screen appears as shown below:

The screenshot displays the 'Bank Parameters Maintenance' window with the 'FATCA' tab selected. The interface includes a search bar at the top, followed by input fields for 'Bank Code \*' and 'Bank Name'. Below this is the 'Head Office Branch' section with 'Branch Code \*' and 'Branch Description' fields. The 'FATCA' tab is active, showing a checkbox for 'FATCA Applicable'. Under 'Banks FATCA Classification', there are fields for 'FATCA Classification', 'GIIN', 'Employer Identification No. (EIN)', 'Remarks', 'Issue Date/Date of Agreement', and 'Expiry Date/Date of Re-validation'. At the bottom, there are fields for 'Maker', 'Checker', 'Mod No', 'Date Time', 'Record Status', and 'Authorization Status', along with an 'Exit' button.

### FATCA Applicable

Check this box to indicate that the FATCA rules are applicable to the bank.

### Banks FATCA Classification

#### FATCA Classification

Specify the bank's own FATCA classification. The adjoining option list displays the all the allowed classifications maintained for customer type bank using the 'Customer Type-Wise FATCA Parameters' screen.

#### Employer Identification No. (EIN)

Specify the employer identification number (EIN) issued to the bank by IRS.

---

#### Note

All the statuses do not require employer identification number (EIN).

---



### Issue Date/Date of Agreement

Specify the date on which the employer identification number (EIN) was issued by IRS; or the date on which the bank entered into an agreement with IRS.

### Expiry Date/Date of Revalidation

Some classification requires revalidation of employer identification number (EIN) periodically. Specify the date on which the EIN is to be revalidated.

### GIIN

Specify the global Intermediary Identification number issued to the bank by the IRS.

### Remarks

Provide any remarks, comments or observations regarding the Bank's FATCA Classification.

## 2.2 Maintaining Product Groups

For maintaining product groups, you can invoke the 'Product Group Maintenance' screen. To invoke this screen type 'STDPRGRT' in the field at the top right corner of the Application tool bar and click on the adjoining arrow button.

Fields		
Maker	Date Time:	Mod No
Checker	Date Time:	Record Status
		Authorization Status

Specify the following details in this screen:

#### Group ID

Specify a group ID for the product group that you are defining.

#### Description

Enter a brief description of the product group that you are defining.

## 2.3 Maintaining Mayuru Limit Details

The customers can be categorized to 'Maruyu Limit' (Tax free small sum savings) group/ category. The customers belonging to this group are provided tax exemption for deposits up to a certain limit amount. If the balance in the account goes above the allowed limit then, on interest liquidation the interest amount will be taxable.

The Maruyu limit maintained at the customer level is applicable to all the CASA and TD accounts of the customer. The account limit can be specified by the customer on opening of account or any time during the life cycle of the account. The sum total of the threshold limits across all accounts of the customer (CASA and term deposit) should not breach the customer level limit.

You can maintain the Maruyu Limit per customer using 'Maruyu Limit Maintenance' screen. The limit amount for Maruyu customers should be less than or equal to the bank level limit.

You can invoke this screen by typing 'CSDMLMT' in the field at the top right corner of the Application tool bar and click on the adjoining arrow button.

The screenshot shows a software window titled "Maruyu Limit Maintenance". At the top left, there is a "Save" button. Below it, the "Maruyu Details" section contains three input fields: "Limit Currency" with "JPY" selected, "Customer Limit Amount \*" (marked with a red asterisk), and "Effective Date \*" (marked with a red asterisk and a calendar icon). At the bottom, there is a status bar with fields for "Maker", "Checker", "Date Time:", "Mod No", "Record Status", and "Authorization Status", along with a "Cancel" button.

You can enter the following details:

### **Limit Currency**

The system displays the currency for which the limit is maintained.

### **Customer Limit Amount**

Specify the amount of customer limit.

### **Effective Date**

Specify the date from which the limit is effective at the bank level. The Maruyu effective date should not be less than the current system date.

In this screen, you can perform the following operations:

- New
- Enter Query
- Save
- Authorize
- Copy
- Close
- Unlock
- Print
- Delete

The SDEs MARUYU\_CUSTOMER and MARUYU\_ACCLIMIT are used for tax calculation for Maruyu Customers.

The SDE MARUYU\_CUSTOMER will return a value as '1' for TD accounts based on the following conditions:

- In the list of records available in the multi grid of 'Maruyu limit' in STDCUSTD screen, the SDE will identify the records which are related to current liquidation cycle.
- If the 'Maruyu Status' is Yes or Disqualified for a particular record.

The SDE MARUYU\_CUSTOMER will return a value as '1' for CASA accounts based on the following conditions:

- In the list of records available in the multi grid of 'Maruyu limit' in STDCUSAC screen, the SDE will identify the records which are related to current liquidation cycle.
- If the 'Maruyu Status' is Yes for a particular record.

The SDE MARUYU\_CUSTOMER will return a value as '0' for TD accounts based on the following conditions:

- In the list of records available in the multi grid of 'Maruyu limit' in STDCUSTD screen, the SDE will identify the records which are related to current liquidation cycle.
- If the 'Maruyu Status' is No for a particular record.

The SDE MARUYU\_CUSTOMER will return a value as '0' for CASA accounts based on the following conditions:

- In the list of records available in the multi grid of 'Maruyu limit' in STDCUSAC screen, the SDE will identify the records which are related to current liquidation cycle.
- If the 'Maruyu Status' is No or Disqualified for a particular record.

The formula for Maruyu Limit is below:

**CASA**

SI.No	Conditions	Result	Periodicity	Remarks
1	VD_D- LY_CR_BAL _M>0	((VD_D- LY_CR_BAL _M* DAYS * TER- M_RATE) / (100 * YEAR))	Daily	Credit Inter- est Formula
2	MARUYU_C USTOMER = 0	((VD_D- LY_CR_BAL _M* DAYS * TER- M_RATE) / (100 * YEAR))	Daily	Non booked Formula, periodicity should be maintained as daily
3	FORMULA2 > 0	FORMU- LA2*(TAX- _RATE/100)	Daily	Tax formula, periodicity should be periodic

**TD Accounts**

SI.No	Conditions	Result	Periodicity	Remarks
1	DEPOSIT_A MOUNT>0	((DEPOSIT_ AMOUNT * DAYS * TER- M_RATE) / (100 * YEAR))	Daily	Credit Inter- est Formula
2	MARUYU_C USTOMER = 0	((DEPOSIT_ AMOUNT * DAYS * TER- M_RATE) / (100 * YEAR))	Daily	Non booked Formula, periodicity should be maintained as daily
3	FORMULA2 > 0	FORMU- LA2*(TAX- _RATE/100)	Daily	Tax formula, periodicity should be periodic

The MARUYU\_CUSTOMER SDE will be '1' only if all of the following customer level conditions are met:

- Customer is a Maruyu Customer (based on the check box 'Maruyu Customer')
- The effective date is reached

The SDE MARUYU\_ACCLIMIT will pick up the value based on the SDE MARUYU\_CUSTOMER. i.e. only if SDE MARUYU\_CUSTOMER is '1' the limit is considered.

On modification of the account limit amount, the SDE MARUYU\_ACCLIMIT will consider the latest value of the limit for every interest liquidation cycle.

The MARUYU\_CUSTOMER SDE will be '0' only if Maruyu Status is 'No' or 'Disqualified' for a particular record.

### 2.3.1 Viewing Maruyu Limit Details

You can view the maruyu limit details of the customer in 'Maruyu Limit Summary' screen. You can invoke this screen by typing 'CSSMLMT' in the field at the top right corner of the Application tool bar and clicking on the adjoining arrow button.

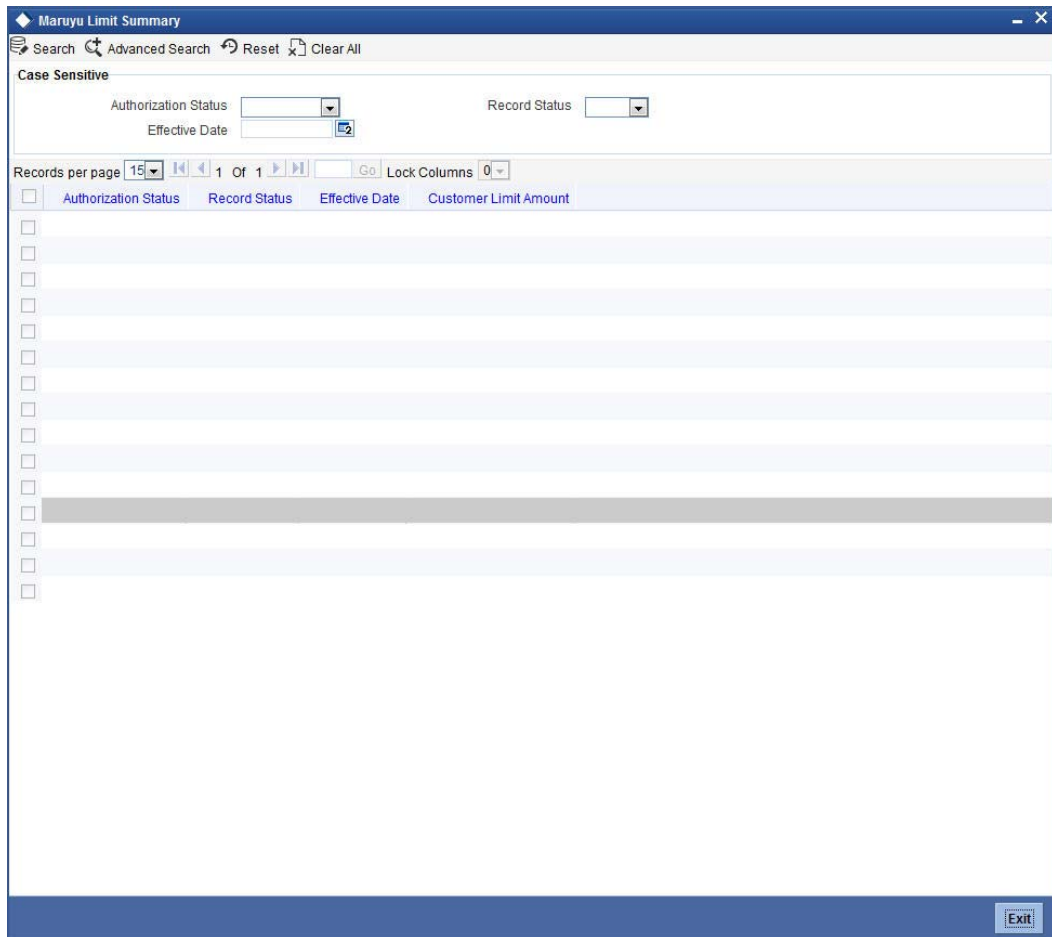

You can search for the records based on either one or more of the following search parameters:

- Authorization Status
- Record Status
- Effective Date

Once you have specified the search parameters, click 'Search' button. The system will display the following information:

- Authorization Status
- Record Status
- Effective Date
- Customer Limit Amount

## 2.4 Maintaining Deposit Insurance Parameters

Oracle FLEXCUBE allows you to activate your deposit insurance in case the bank becomes bankrupt. When bankruptcy is declared on a bank, the core banking generates the handoff files, that contains the details of all CASA and deposit accounts and sends to Deposit Insurance Corporation Japan (DICJ). The DIC system determines the insured and uninsured amount for each account and this file is sent to FCUBS. The uninsured amount will be transferred to the 'Miscellaneous Cr GL' configured in the GL Lines sub screen of Account Class Maintenance screen.

You can configure transaction code to facilitate transfer of funds from CASA/TD accounts to this GL (Miscellaneous Cr GL) through Deposit Insurance Parameters Maintenance screen. You can invoke this screen by typing 'STDDICP' in the field at the top right corner of the Application tool bar and clicking the adjoining arrow button.

The screenshot shows a software window titled "Deposit Insurance Parameters Maintenance". At the top left, there is a "Save" button. The main content area contains two input fields. The first is labeled "Bank code" and contains the text "0397". The second is labeled "Transaction Code for Uninsured Movement" and is currently empty. Below the input fields, there is a status bar with several fields: "Maker", "Date Time:", "Mod No", "Record Status", "Checker", "Date Time:", "Authorization Status", and a "Cancel" button.

### **Bank Code**

The system displays the bank code.

### **Transaction Code for Uninsured Movement**

Specify the transaction code for uninsured movement. Alternatively, you can select the transaction code from the option list. The list displays all valid transaction codes.

## 2.5 Maintaining Customer DIC Details

You can maintain the netting preference of a customer based on customer ID, PID and customer name through 'Customer DIC Details' screen. You can invoke this screen by typing

'STDCDICD' in the field at the top right corner of the Application tool bar and clicking the adjoining arrow button.

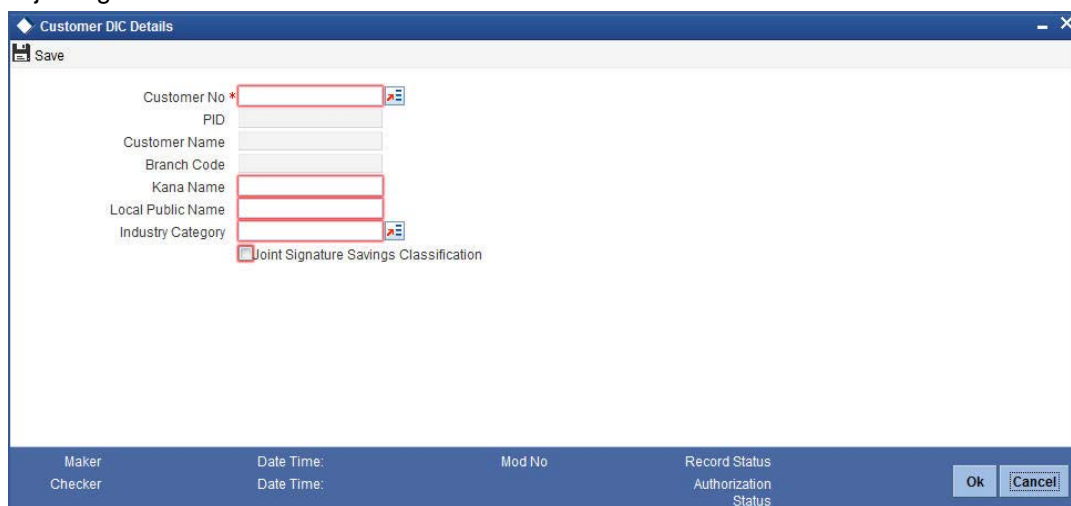

You can maintain the following in this screen:

### **Customer No**

Specify the customer number. Alternatively, you can select the customer number from the option list. The list displays all valid customer numbers.

### **PID**

The system displays the PID based on the customer number.

### **Customer Name**

The system displays the customer name based on the customer number selected.

### **Branch Code**

The system displays the branch code based on the customer number selected.

### **Kana Name**

Specify the DIC specific Kana name. If Kana name is maintained here then it will be considered for while reporting to DIC. If it is not maintained then the Kana name maintained at Customer Maintenance (STDCIF) screen will be considered.

The system will validate the characters entered in 'Kana name' field with the factory shipped script code 'DIC' in STDSRPT (Script Maintenance for language), only if 'Validate Characters' field is checked.

System will display a configurable error/override if the character is not entered in the allowed list of characters for DIC

System will not validate KANA Name in 'STDCDICD' against KANA script code If DIC script code is not maintained

### **Local Public Name**

Specify the local name of the customer.

The system will validate the characters entered in 'Local Public Name' field field with the factory shipped script code 'DIC' in 'STDSRPT' (Script Maintenance for language), only if 'Validate Characters' field is checked

System will display a configurable error/override if the character is not entered in the allowed list of characters for DIC

**Industry Category**

Specify the industry category. Alternatively you can select the industry category from the option list. The list displays all valid industry classifications.

**Joint Signature Savings Classification**

Check this box to indicate preference for joint signature savings classification.

**2.5.1 Viewing Customer DIC Details**

You can view the customer DIC details in 'Customer DIC Summary' screen. You can invoke this screen by typing 'STSCDICD' in the field at the top right corner of the Application tool bar and clicking the adjoining arrow button.



In the above screen, you can query on any or all of the following parameters and fetch records:

- Authorization Status
- Record Status
- Customer No
- Customer Name
- PID No



- Maker Home Branch
- Maker ID

Select any or all of the above parameters for a query and click 'Search' button. Records meeting the selected criteria are displayed with the following details:

- Authorization Status
- Record Status
- Customer Id
- Customer Name
- PID No
- Maker Home Branch
- Maker ID
- Local Public Name
- Joint Signature Savings Classification
- Industry Category
- Branch Code
- Kana Name

## **2.5.2 GI Interface Definition for DIC Outgoing Hand-off File**

Oracle FLEXCUBE allows you to activate your insurance deposit in case the bank becomes bankrupt. When bankruptcy is declared on a bank, the core banking generates the handoff files, that contains the details of all CASA and deposit accounts and sends to Deposit Insurance Corporation Japan (DICJ). The handoff file generation is scheduled to trigger every week and will replace the files generated in the previous week. The files have to be generated post EOTI stage of EOD processing after all the interest accruals are completed.

The following interface definition and corresponding data source will be available in the handoff file generated from FCUBS to external system DICJ (Deposit Insurance Corporation Japan):

### Retail Customer Data

Format ID	Description
STODICNC	GI outgoing file for Nayose (Customer Change) customer data File Name to be generated - CSDICRC1.dat
STODICIF	GI outgoing file for customer data File Name to be generated - CSDICRC2.dat
STODIDEP	GI outgoing file for CASA and Deposit accounts File Name to be generated - CSDICRC3.dat
STODICOL	GI outgoing file for Collateral accounts File Name to be generated - CSDICRC4.dat
STODIODA	GI outgoing file for OD accounts File Name to be generated - CSDICRC8.dat
STODIAPP	GI outgoing file for Appendix data File Name to be generated - CSDICRC9.dat

The following periodic outgoing file with Nayose CIF Data is generated for the format ID 'STODICNC'.

Sl. No	Field Name	Field Type	Derivation Logic	Data Type	Length	Format Remarks	Fixed Value
	NAYOSE						
1	Data classification	FIXED	NA	N	1		"3"
2	Data type	FIXED	NA	N	2		"36"
3	Financial institution code	DERIVED	Bank Code > Bank Parameters	C	4		
4	Branch code	DERIVED	1st 3 digits of PID	C	3		
5	CIF (customer) number	DERIVED	RTL+ last 7 digits of PID	C	10		
6	Non-applicable class	FIXED	NA	N	1		"0"
7	Indiv. / corporate code	FIXED	1 - Retail 2 - Corporate	N	1		

8	Name (kana)	DERIVED	If record available for PID in STD-CDICD Kana name from same, else Kana name of STD-CIF>Additional Scripts	C	48		
9	Birth date	DERIVED	00000000 if a) In case customer addition date is 05/Nov/2001 and Birth date is 01/Jan/1950 b) In case customer addition date is within(<=) 01/Jan/1850, else Date of Birth from STDCIF in YYYYM-MDD format	D	8		
10	Telephone number	DERIVED	Phone number from CIF - Mobile ISD Code + Mobile Number	C	17		
11	Dummy	FIXED	NA	C	15		spaces

The following periodic outgoing file with customer data is generated for the format ID 'STODICIF'.

Sl. No	Field Name	Field Type	Derivation Logic	Data type	Length	Format Remarks	Fixed Value
--------	------------	------------	------------------	-----------	--------	----------------	-------------

1	Data classification	FIXED	NA	N	1		"3"
2	Data type	FIXED	NA	N	2		"02"
3	Financial institution code	DERIVED	Bank Code > Bank Parameters	C	4		
4	Branch code	DERIVED	1st 3 digits of PID	C	3		
5	CIF (customer) number	DERIVED	RTL+ last 7 digits of PID	C	10		
6	CIF caution code	DERIVED	Customer Memo 0: If no memo 1: If 'error or override' type of memo 10: if 'information' memo	C	10	Based on customer memo	
7	Name (kana)	DERIVED	If record available for PID in STDCDICD Kana name from same, else Kana name of STD-CIF>Additional Scripts	C	48		
8	Name (kanji)	DERIVED	Kanji name from CIF	K	90	Double byte	
9	Zip code	DERIVED	Address zip code from CIF - PIN Code without spaces	C	7		
10	Address (kana)	DERIVED	Kana address from CIF - Prefecture + City + Addr1-3 - without space	C	80		
11	Address (kanji)	DERIVED	Kanji address from CIF - Prefecture + City + Addr1-3 - without space	K	120		

12	(Tax info) financial system, etc. classification	FIXED	NA	N	1		"0"
13	(Tax info) foreign address display classification	DERIVED	0 - Country in Address is Japan 1 - Other address	N	1		
14	(Tax info) no residence/ foreign corporation classification	DERIVED	0-Resident, 1-Non-resident	N	1	based on customer type (resident)	
15	(Tax info) diplomatic immunity classification	FIXED	NA	N	1		"0"
16	(Tax info) has property but no residence/ foreign corporation classification	FIXED	NA	N	1		"9"
17	(Tax info) reduced/ tax exempt classification	FIXED	NA	N	1		"0"
18	(Tax info) tax reduction rate (%)	FIXED	NA	N	5	"00000" will be interpreted as 00.000	"00000"
19	Dummy	DERIVED	NA	C	14		

The following periodic outgoing file with deposit data is generated for the format ID 'STODIDEP'.

Sl. No	Field Name	Field Type	Derivation Logic	Data type	Length	Format Remarks	Fixed Value
1	Data classification	FIXED	NA	N	1		"3"
2	Data type	FIXED	NA	N	2		"03"
3	Financial institution code	DERIVED	Bank Code in Bank Parameters	C	4		

4	Branch code	DERIVED	the first 3 digit of account no.	C	3		
5	Deposit item code	DERIVED	product type/ CCY  01 - JPY CASA  05 - JPY TD  17- FCY CASA  18- FCY TD  13- CASA with 0% interest or no Credit interest formula attached	N	2		
6	Deposit item code branch number	FIXED	"00"	N	2		"00"
7	Account number	DERIVED	Digits 4-12 of account number	C	12	Right pad with SPACE	
8	Account branch no.	FIXED	NA	N	4		"0000"
9	CIF (customer) branch code	FIXED	NA	C	3		all space
10	CIF (customer) number	DERIVED	"RTL" + the last 7 digit of PID	N	10		

11	Account caution code	DERIVED	<p>Refers to ATM flag + CASA Account status.</p> <p>It contains the values based on below calculation.</p> <p>Decode(MOD(ATM Flag,2),0,1,1,0)+Decode(ACCOUNT STATUS,8,0,2,10,3,100,16,1000,0)</p> <p>ACCOUNT STATUS : If 'Debit Override' = 16, else 8</p> <p>ATM FLAG (Channels allowed based on STDCTLMT) : Sum of values based on channels allowed at account where ATM=1,IVR=2,POS=4,Internet Banking=8</p> <p>Example: Account where ATM &amp; Internet banking is allowed and account in Debit override status ATM flag = 9 &amp; cod_acct_status = 16 Account Caution code = 90+1000 = 1000</p>	C	10	Left pad ZERO	
----	----------------------	---------	--	---	----	---------------	--

12	Account setup date	DERIVED	Account Open Date	N	8		
13	Deposit date	DERIVED	CASA : Last transaction date TD : Interest Start Date	N	8		
14	Term end date	DERIVED	CASA: 00000000 TD : Maturity date in YYYYMMDD	N	8		
15	Immediately prior to interest settlement date/ term end date	DERIVED	CASA- sets last interest accrual date TD - Last Interest Liquidation Date	N	8		
16	Interest rate (%)	DERIVED	CASA : Interest rate as per default product with RP variance TD : Interest Rate with RP variance	N	9	2,7	
17	Post-end of term rate (%)	DERIVED	CASA: If tax formula is available, same as 'Interest Rate' field above, else 0 TD: Value maintained for 'PMI_RATE' UDE, else 0	N	9	2,7	
18	General ledger principal balance mark	DERIVED	"-" if account balance is 'Dr' blank otherwise	C	1		



19	General ledger principal balance	DERIVED	CASA : Current Balance TD: Deposit Amount  Note: Round down to previous integer for JPY accounts. Others retain currency decimals	N	17	14,3	
20	Other bank bill return decision classification	DERIVED	1 - if amount block is available for account  0 - otherwise	N	1		
21	Unpaid end of term interest	DERIVED	CASA - all zero  TD - total interest amount till TD maturity (excluding PMI)	N	17	14,3	

22	Unpaid accrued interests	DERIVED	<p>CASA : Interest accrued from last liquidation date</p> <p>TD: Interest accrued + PMI , since last liquidation date</p> <p>Note: Rounding as per remarks field</p>	N	17	<p>14,3</p> <p>The result of Yen interest (both CASA and TD),</p> <p>If 123.678 then 123000. (round down)</p> <p>The result of FCY savings interest,</p> <p>If 123.678 then 123670. (round down below Subsidiary currency)</p> <p>The result of FCY TD interest,</p> <p>If 123.678 then 123680. (round closer below Subsidiary currency)</p>	
23	Uncollected interests	FIXED		C	12	12,0	"0"
24	Pass-book capital balance symbol	DERIVED	'-' (balance is negative) or space (positive / not issued)	C	1		

25	Pass-book capital balance	DERIVED	Balance of CASA (JPY/FCY) 0 for other accounts	N	17	14,3 - without separator last 3 digits considered as decimal	
26	Pass-book update classification	FIXED	1(unprinting exist),"0"(No unprinting exist or not issued)	N	1		
27	Savings passbook not issued classification	DERIVED	1(not issued),"0"(issued)	N	1		
28	Foreign currency type	DERIVED	Account Currency Code for FCY accounts for LCY accounts - null	C	3		
29	Debt classification	DERIVED	0 - if collateral is not created for deposit 2 - if collateral is created in case of CASA if TD, space	N	1		
30	Collateral deposit classification	DERIVED	"1" if limit against deposit is utilised	N	1		
31	401K classification	FIXED	NA	N	1		"0"
32	Ineligible deposit classification	FIXED	NA	N	1		"0"

33	Third party investment trust classification	FIXED	NA	N	1		"0"
34	(Maruyu) Tax-free small-sum savings system classification	FIXED	Maruyu flag	N	1		"0"/"1"
35	(Maruzai) Tax-free property accumulation system classification	FIXED	NA	N	1		"0"
36	Tax-free corporation classification	FIXED	NA	N	1		"0"
37	Children's bank savings classification	FIXED	NA	N	1		"0"
38	Other than objective repayment total	FIXED	NA	C	13	13,0	all zero
39	Joint signature savings classification	DERIVED	Set "1" - if CASA interest rate is 0 OR no Cr interest formula is attached  Set "0" - In case of the other code, sets "0".	N	1		
40	Discount rate (%)	FIXED	NA	C	7		all zero

41	General ledger principal amount	FIXED	NA	C	11		all zero
42	Assumed interest payable coefficient	FIXED		C	8		all zero
43	Date immediately preceding interest payment	FIXED	NA	C	8		all zero
44	3		NA	N	1		"3"
45	Dummy	FIXED	NA	C	11		all space

The following periodic outgoing file with collateral data is generated for the format ID 'STODICOL'.

Sl. No	Field Name	Field Type	Derivation Logic	Data type	Length	Format Remarks	Fixed Value
1	Data classification	FIXED	NA	N	1		"3"
2	Data type	FIXED	NA	C	2		"04"
3	Financial institution code	DERIVE D	Bank Code in Bank Parameters	C	4		
4	Branch code	DERIVE D	the first 3 digit account number for JPY CASA	C	3		
5	Deposit item code	DERIVE D	01: JPY CASA	C	2		
6	Deposit item code branch number	FIXED	NA	C	2		"00"
7	Account number	DERIVE D	Digits 4-15 of JPY CASA Account Number	C	12		
8	Account branch no.	FIXED	NA	C	4		"0000"

9	Collateral deposit branch code	DERIVE D	the first 3 digit of collateralized TD account number	C	3		
10	Collateral deposit deposit item code	FIXED	NA	C	2		"05"
11	Collateral deposit deposit item code branch no.	FIXED	NA	C	2		"00"
12	Collateral deposit account number	DERIVE D	Digits 4-15 digits of TD Account Number	C	12		
13	Collateral deposit account number branch no.	FIXED	NA	C	4		"0000"
14	Dummy	FIXED	NA	C	17		all space

The following periodic outgoing file with outstanding OD data is generated for the format ID 'STODIODA'.

Sl. No	Field Name	Field Type	Derivation Logic	Data type	Length	Format Remarks	Fixed Value
1	Financial institution code	DERIVED	Bank Code in Bank Parameters	C	4		
2	Branch code	DERIVED	the first 3 digit account number for JPY CASA	C	3		
3	Deposit item code	DERIVED	01: JPY CASA	C	2		
4	Deposit item code branch number	FIXED	NA	C	2		"00"

5	Account number	DERIVED	Digits 4-15 of JPY CASA Account Number	C	12		
6	Account branch no.	DERIVED		C	4		"0000"
7	Negative balance mark	DERIVED	'-' (balance is negative) or space (positive)	C	1		
8	General ledger principal balance	DERIVED	Account Balance with leading zeros  last three digits for decimals without separator  eg: JPY1,000,000 is shown as 00000001000 000000	C	17	will be interpreted as 14,3 i.e. last 3 digits are decimals	

The following periodic outgoing file with appendix data is generated for the format ID 'STODIAPP'.

Sl. No	Field Name	Field Type	Derivation Logic	Data type	Length	Format Remarks	Fixed Value
1	Branch code	DERIVED	the first 3 digit of PID (the same as it of Nayose CIF)	C	3		
2	comma	FIXED	NA	C	1		","
3	CIF(customer) number	DERIVED	"RTL"+the last 7 digit of PID (the same as it of Nayose CIF)	C	10		
4	comma	FIXED	NA	C	1		","
5	NCIF(customer) number	FIXED	NA	C	8		ALL space
6	comma	FIXED	NA	C	1		","
7	Business Division code	DERIVED	"RTL"	C	3		

8	comma	FIXED	NA	C	1		","
9	Customer Group code	FIXED	NA	C	3		ALL space
10	comma	FIXED	NA	C	1		","
11	Customer Type Code	DERIVED	Based on customer tax group code description A: 'Resident', D: 'Non Resident' I: 'Tax Exemption'	C	1		
12	comma	FIXED	NA	C	1		","
13	industry type classification	FIXED	NA	C	5		"00000"
14	comma	FIXED	NA	C	1		","
15	Dormancy Flag(reason code)	DERIVED	Account Status Dormant flag 'Yes' then '1' else '0'	C	1		
16	comma	FIXED	NA	C	1		","
17	Birth date flag(reason code)	FIXED	NA	C	1		ALL space
18	comma	FIXED	NA	C	1		","
19	Dummy	FIXED	NA	C	16		ALL space

The following incoming file from DIC after bankruptcy is generated for the format ID 'STIDICIN'.

SI. No	Field Name	Field Type	Derivation Logic	Data type	Length	Format Remarks	Fixed Value
--------	------------	------------	------------------	-----------	--------	----------------	-------------



1	Deposit Item Code	DERIVE D	product type/ CCY 01 - JPY CASA 05 - JPY TD 17- FCY CASA 18- FCY TD 13- Other deposits	C	2		
2	Draw-down Number	FIXED	NA	N	2		"00"
3	Account Number	DERIVE D	Digits 4-15 of account number	C	12	set account number by left- justified and set single byte space	
4	Account Branch Number	FIXED	1st 3 digits of account number	N	4		"0000"
5	Non Insure Classification	DERIVE D	1 - if total account balance is un- insured  2- if partial account balance is un- insured	C	1		
6	Setting Classification (Spare)	DERIVE D	NA	C	1		"1"
7	Non Insure Amount (Principal)	DERIVE D	Uninsured principal to be transferred to GL	N	14		
8	Non Insure Amount (Interest)	DERIVE D	Uninsured interest to be transferred to GL	N	12		

9	(for division Saving Account with interest)	DERIVED	Include this amount to be deducted from CASA and paid to Uninsured GL	N	12		
10	Dummy	FIXED	NA	C	21		

The following daily tran reporting on insured portion is generated for the format ID 'STODICTN'.

Sl. No	Field Name	Field Type	Processing Logic	Data type	Length	Format Remarks	Fixed Value
<b>HEADER</b>							
1	Data Classification	FIXED	NA	N	1		"1"
2	Data Type	FIXED	NA	N	2		"10"
3	Code Specification	FIXED	NA	N	1		"1"
4	Financial Institution Code	DERIVED	Bank Code in Bank Parameters	C	4		
5	Creation Date	DERIVED	Creation date YYYYMMDD	N	8		
6	Creation Time	DERIVED	Creation date HHMMSS	N	6		
7	Value Date (from)	DERIVED	Transaction value date From YYYYMMDD	N	8		
8	Value Date (to)	DERIVED	Transaction value date To YYYYMMDD	N	8		
9	Tape Number	DERIVED	Unique number for magnetic tape	C	10		
10	Dummy	DERIVED	Set all space	C	152		
					200		
<b>STATEMENT RECORD (BODY)</b>							
1	Data Classification	FIXED	NA	N	1		"3"

2	Data Type	FIXED	NA	N	2		"10"
3	Financial Institution Code	DERIVED	Bank Code in Bank Parameters	N	4		
4	Branch Code	DERIVED	First 3 digits of account number	C	3		
5	Deposit Item Code	DERIVED	product type/ CCY 01 - JPY CASA 05 - JPY TD 17- FCY CASA 18- FCY TD 13- CASA with 0% interest or no Credit interest formula attached	C	2		
6	Drawdown Number	FIXED	NA	N	2		space
7	Account Number	DERIVED	Digits 4-15	C	12		
8	Account Sub Number	FIXED	NA	N	4		"0000"
9	CIF (Customer) Branch Code	DERIVED	1st 3 digits of PID	C	3		
10	CIF (Customer) Number	DERIVED	RTL+ last 7 digits of PID	C	10		
11	Value Date	DERIVED	Transaction value date YYYYMMDD	N	8		
12	Transaction Number	DERIVED	Running serial number to signify nth transaction for account on tran value date	N	8		
13	Credit ?Debit Date	DERIVED	Same as value date	N	8		

14	Deposit Status Classification	DERIVED	CASA : 0 - New account 1 - Credit 2 - Debit 3 - Reversal/ Cancellation TD: 0 - booking 1 - Reversal of debits, if any 2 - Other debits to account 3 - Full redemption	N	1		
15	Transaction Classification	DERIVED	10 : cash (include checks issued by other banks) 14 : account transfer (interest of Saving Account etc. and middle interest of Term Deposit transfer to a designated account) 15 : automatic renewal 18 : others 19 : correction	N	2		
16	Transaction Principal Amount	DERIVED	Transaction amount with leading 0's	C	12		
17	Interest Rate (%)	DERIVED	Interest rate considered in case of TD redemption, else 0	N	9		
18	Interest Rate after Maturity (%)	DERIVED	If field 14 is TD booking related (0), then corresponding interest rate , else 0	N	9		

19	Maturity Date	DERIVED	Maturity date of TD YYYYMM-MDD if available, else all 0's	N	8		
20	Transaction Interest Amount	DERIVED	Interest amount with leading 0's in case of TD redemption	C	11		
21	Balance Sign after Transaction	DERIVED	-, if account balance after transaction is in Dr, else space	C	1		
22	Balance after Transaction	DERIVED	Current balance after transaction with leading 0's	N	14		
23	Dummy	FIXED	NA	C	66		space
					200		
<b>END RECORD</b>							
1	Data Classification	FIXED		N	1		"8"
2	Data Type	FIXED		N	2		"10"
3	Financial Institution Code	DERIVED	Bank Code in Bank Parameters	C	4		
4	New Transaction Number	DERIVED	?total number of Deposit Status Classification of ?0?(New) in this MT  ?number set by right-justified + remaining "0" (for example) 1,234 transaction is ?000001234?	N	9		

5	Total Amount of New Transaction	DERIVED	?total principal amount of all transaction of Deposit Status Classification of ?0?(New) in this MT  ?number set by right-justified + remaining "0" (for example) 12,345,600 Yen is ?00000012345600?	N	14		
6	Credit Transaction Number	DERIVED	?total number of Deposit Status Classification of ?1?(Credit)  & not Transaction Classification of ?19?(Correction) in this MT  ?number set by right-justified + remaining "0" (for example) 2,345 transaction is ?000002345?	N	9		
7	Total Amount of Credit Transaction	DERIVED	?total principal amount of all transaction of Deposit Status Classification of ?1?(Credit)  & not Transaction Classification of ?19?(Correction) in this MT  ?number set by right-justified + remaining "0" (for example) 23,456,700 Yen is ?00000023456700?	N	14		

8	Total Number of Credit Correction Transaction	DERIVED	?total number of Deposit Status Classification of ??(Debit)  & Transaction Classification of ?19?(Correction) in this MT  ?number set by right-justified + remaining "0" (for example) 3,456 transaction is ?000003456?	N	9		
9	Total Amount of Credit Correction Transaction	DERIVED	?total principal amount of all transaction of Deposit Status Classification of ??(Debit)  & Transaction Classification of ?19?(Correction) in this MT  ?number set by right-justified + remaining "0" (for example) 23,456,700 Yen is ?00000023456700?	N	14		
10	Debit Transaction Number	DERIVED	?total number of Deposit Status Classification of ??(Debit)  & not Transaction Classification of ?19?(Correction) in this MT  ?number set by right-justified + remaining "0" (for example) 4,567 transaction is ?000004567?	N	9		

11	Total Amount of Debit Transaction	DERIVED	<p>?total principal and interest amount of all transaction of Deposit Status Classification of ??(Debit)</p> <p>&amp; not Transaction Classification of ?19?(Correction) in this MT</p> <p>?number set by right-justified + remaining "0" (for example) 45,678,900 Yen is ?00000045678900?</p>	N	14		
12	Total Number of Debit Correction Transaction	DERIVED	<p>?total number of Deposit Status Classification of ?1?(Credit)</p> <p>&amp; Transaction Classification of ?19?(Correction) in this MT</p> <p>?number set by right-justified + remaining "0" (for example) 5,678 transaction is ?000005678?</p>	N	9		



13	Total Amount of Debit Correction Transaction	DERIVED	?total principal and interest amount of all transaction of Deposit Status Classification of ?1?(Credit) & Transaction Classification of ?19?(Correction) in this MT  ?number set by right-justified + remaining "0" (for example) 56,789,000 Yen is ?00000056789000?	N	14		
14	Cancellation Transaction Number	DERIVED	?total number of Deposit Status Classification of ?3?(Cancellation) in this MT  ?number set by right-justified + remaining "0" (for example) 7,890 transaction is ?000007890?	N	9		
15	Total Amount of Cancellation Transaction	DERIVED	?total principal and interest amount of all transaction of Deposit Status Classification of ?3?(Cancellation)  ?number set by right-justified + remaining "0" (for example) 78,900,000 Yen is ?0000007890000?	N	14		

16	Number of Statement Record	DERIVED	?Total Number of Statement Record in this MT  ?number set by right-justified + remaining "0" (for example) 12,300 records is ?000012300?	N	9		
17	Dummy	FIXED	all space	C	46		
18	Data Classification	FIXED		N	1		"9"
19	Data Type	FIXED		N	2		"10"
20	Financial Institution Code	DERIVED	Bank Code in Bank Parameters	N	4		
21	Total Number of Statement Record	DERIVED	?Total Number of Statement Record  ?number set by right-justified + remaining "0" (for example) 23,456 records is ?000023456?	C	9		
22	Dummy	FIXED	all space	C	184		

The following uninsured balance reporting to third party system is generated for the format ID 'STODICUN'.

Sl. No	Field Name	Field Type	Derivation Logic	Data type	Length	Format Remarks	Fixed Value
1	DataClassification	FIXED	NA	N	1		`
2	Data Type	FIXED	NA	N	2		"36" ( Fixed value )
3	Cif-Branch-Code	FIXED	NA	V	3		" " ( All space )
4	Cif Number	DERIVED	RTL+ last 7 digits of PID	V	10		
5	Branch-Code	DERIVED	the first 3 digit of account no.	V	3		

6	BankAccount-Number	DERIVED	Uninsured GL to which amount is transferred	C	16	"400751000123456" ( 16th byte is space )	
7	DepositItemCode	DERIVED	product type/CCY 01 - JPY CASA 05 - JPY TD 17- FCY CASA 18- FCY TD 13- Other deposits	V	2		
8	DepositItemCode-Branch-Number	FIXED	NA	N	2	"0"	"00"
9	Account-Number	DERIVED	Account Number of Insured Portion; digits 4-13 followed by 2 spaces	V	12	"75825932D1" ( 11th&12th byte are space )	
10	Account-Branch-Number	FIXED	NA	N	4		"0000"
11	NonInsured-Classification	DERIVED	1 - if total account balance is uninsured 2- if partial account balance is uninsured	C	1	"2"	
12	Setting-Classification	FIXED	NA	C	1		"1" ( Fixed value )
13	NonInsuredPrincipalAmount	DERIVED	Uninsured principal transferred to GL	N	14	(14, 0)	

14	NonInsuredInterestAmount	DERIVED	Uninsured interest transferred to GL	N	12	(12, 0)	
15	AccountBalanceAmount	DERIVED	Account Balance before split	N	14	(14, 0)	
16	ValidFlag	FIXED	NA	C	1	"Y"	
17	WithdrawalProcessedFlag	FIXED	NA	C	1	"W"	
18	GIProcessedFlag	FIXED	NA	C	1	"C"	
19	NonInsuredBranchCode	FIXED	NA	N	4		"0000"
20	NonInsuredDepositItemCode	DERIVED	product type/CCY 01 - JPY CASA 05 - JPY TD 17- FCY CASA 18- FCY TD 13- Other deposits	V	2	"05"	
21	NonInsuredDepositItemCode-BranchNumber	FIXED	NA	N	2	"0"	"00"
22	NonInsuredAccountNumber	DERIVED	DIC account number (as per mask at STDDICP) digits 4-13 followed by 2 spaces	V	12	"75825932D1 "	

23	NonInsuredAccountBranchNumber	FIXED	NA	N	4		"0000"
24	Deposit-Date	DERIVED	Account Open Date in YYYYMMDD format	D	8	"20120427"	
25	Maturity-Date	DERIVED	Maturity Date in YYYYMMDD format for TD CASA - 00000000	D	8	"20190427"	
26	InterestRate	DERIVED	Interest rate last applied on account	N	9	(2, 7)	
27	InterestRateAfterMaturity	FIXED	NA	N	9	(2, 7)	"0" ( Fixed value )

#### Corporate Customer Data

Format ID	Description
STODCCNC	GI outgoing file for Nayose (Customer Change) customer data File Name to be generated - CSDICRC1.dat
STODCCIF	GI outgoing file for customer data File Name to be generated - CSDICRC2.dat
STODCDEP	GI outgoing file for CASA and Deposit accounts File Name to be generated - CSDICRC3.dat
STODCCOL	GI outgoing file for Collateral accounts File Name to be generated - CSDICRC6.dat
STODCODA	GI outgoing file for Loan accounts File Name to be generated - LCPAYOFF.dat
STODCAPP	GI outgoing file for Appendix data File Name to be generated - CSDICRC9.dat

The following periodic outgoing file with Nayose CIF data is generated for the format ID 'STODCCNC'.

Sl. No	Field Name	Field Type	Derivation Logic	Data type	Length	Format Remarks	Fixed Value
	NAYOSE						
1	Data classification	FIXED	NA	N	1		"3" ( Fixed value )
2	Data type	FIXED	NA	N	2		"01" ( Fixed value )
3	Financial institution code	DERIVED	Bank Code > Bank Parameters	C	4		
4	Branch code	DERIVED	First 3 digits of PID	C	3		
5	CIF (customer) number	DERIVED	"CRP"+ last 7 digits of PID	C	10		
6	Non-applicable class	FIXED	NA	N	1		"0"
7	Indiv. / corporate code	FIXED	1 - Retail 2 - Corporate	N	1		
8	Name (kana)	DERIVED	If record available for PID in STD-CDICD Kana name from same, else Kana name of STD-CIF>Additional Scripts	C	48		
9	Birth date	DERIVED	Date of Incorporation from STDCIF in YYYYM-MDD format	D	8		

10	Tele- phone number	DERIVED	Mobile ISD Code + Mobile Num- ber : Phone number from CIF > Direc- tor's tab	C	17	If the length is more the first 17 digits after con- catenat- ing the two fields to be con- sidered	
11	Dummy	FIXED	NA	C	15		spaces
12	Old Cif	DERIVED	WHEN A12 = '00000000' THEN  '09180025'  ELSE  A12	C	8	This is based on migrated custom- ers in leg- acy system. Table mapping from FCR to V12 to be updated	

The following periodic outgoing file with customer data is generated for the format ID 'STODCCIF'.

Sl. No	Field Name	Field Type	Derivation Logic	Data type	Length	Format Remarks	Fixed Value
1	Data classification	FIXED	NA	N	1		"3"
2	Data type	FIXED	NA	N	2		"02"
3	Financial institution code	DERIVED	Bank Code > Bank Parameters	C	4		
4	Branch code	DERIVED	1st 3 digits of PID	C	3		
5	CIF (customer) number	DERIVED	CRP+ last 7 digits of PID	C	10		

6	CIF caution code	DERIVED	Customer Memo If 'error or override' the set 0000000001 if 'information' 0000000000	C	10	Based on customer memo	
7	Name (kana)	DERIVED	If record available for PID in STD-CDICD Kana name from same, else Kana name of STD-CIF>Additional Scripts	C	48		
8	Name (kanji)	DERIVED	Kanji name from CIF	C	90		
9	Zip code	DERIVED	Address zip code from CIF - PIN Code without spaces	C	7		
10	Address (kana)	DERIVED	Kana address from CIF - Prefecture + City + Addr1-3 - without space	C	80	State + City + Addr1-3 - without space	
11	Address (kanji)	DERIVED	Kanji address from CIF - Prefecture + City + Addr1-3 - without space	C	120		
12	(Tax info) financial system, etc. classification	FIXED	NA	N	1		"0"
13	(Tax info) foreign address display classification	DERIVED	0 - Country in Address is Japan 1 - Other address	N	1		



14	(Tax info) no residence/ foreign corporation classification	DERIVED	0-Resident, 1- Non-resident	N	1	based on customer type (resident)	
15	(Tax info) diplomatic immunity classification	FIXED	NA	N	1		"0"
16	(Tax info) has property but no residence/ foreign corporation classification	FIXED	NA	N	1		"9"
17	(Tax info) reduced/ tax exempt classification	FIXED	NA	N	1		"0"
18	(Tax info) tax reduction rate (%)	FIXED	NA	N	5	To interpreted as 00.000	"00000"
19	Dummy	DERIVED	NA	C	14		

The following Periodic outgoing file with deposit data is generated for the format ID 'STODCDEP'.

Sl. No	Field Name	Field Type	Derivation Logic	Data type	Length	Format Remarks	Fixed Value
1	Data classification	FIXED	NA	N	1		"3"
2	Data type	FIXED	NA	N	2		"03"
3	Financial institution code	DERIVED	Bank Code in Bank Parameters	C	4		
4	Branch code	DERIVED	1st 3 digits of account number	C	3		

5	Deposit item code	DERIVED	product type/ CCY  01 - JPY CASA 05 - JPY TD 17- FCY CASA 18- FCY TD  13- CASA with 0% interest or no Credit interest formula attached	N	2		
6	Deposit item code branch number	FIXED	"00"	N	2		"00"
7	Account number	DERIVED	Digits 4-15 of account number	C	12		
8	Account branch no.	DERIVED	TD : 0001 CASA : 0000	N	4		
9	CIF (customer) branch code	FIXED	NA	C	3		all space
10	CIF (customer) number	DERIVED	"CRP" + the last 7 digit of PID (left trim)	N	10		
11	Account caution code	DERIVED	If Account Status is  Blocked - 0000000010  No Debit - 0000000100  Debit Override - 0000001000  Else - 0000000000	BT	10		
12	Account setup date	DERIVED	Account Open Date	N	8		
13	Deposit date	DERIVED	CASA : Last transaction date  TD : Interest Start Date	N	8		

14	Term end date	DERIVED	CASA: 00000000 TD : Maturity date in YYYYMMDD	N	8		
15	Immediately prior to interest settlement date/ term end date	DERIVED	CASA- sets last interest accrual date TD - Last Interest Liquidation Date	N	8		
16	Interest rate (%)	DERIVED	CASA : Interest rate as per default product with RP variance TD : Interest Rate with RP variance	N	9	2,7	
17	Post-end of term rate (%)	DERIVED	CASA: If tax formula is available, same as 'Interest Rate' field above, else 0 TD: Value maintained for 'PMI_RATE' UDE, else 0	N	9	Last seven digits to be considered as decimal Assuming PMI_RATE will be the UDE maintained for PMI	
18	General ledger principal balance mark	DERIVED	"-" if account balance is 'Dr' blank otherwise	C	1		

19	General ledger principal balance	DERIVED	CASA : Current Balance TD: Deposit Amount  Note: Round down to previous integer for JPY accounts. Others retain currency decimals	N	17	14,3	
20	Other bank bill return decision classification	DERIVED	1 - if amount block is available for account 0 - otherwise	N	1		
21	Unpaid end of term interest	DERIVED	CASA - all zero TD - total interest amount till TD maturity (excluding PMI)	N	17	14,3	

22	Unpaid accrued interests	DERIVED	<p>CASA : Interest accrued from last liquidation date</p> <p>TD: Interest accrued + PMI , since last liquidation date</p> <p>Note: Rounding as per remarks field</p>	N	17	<p>14,3</p> <p>The result of Yen interest (both CASA and TD),</p> <p>If 123.678 then 123000. (round down)</p> <p>The result of FCY savings interest,</p> <p>If 123.678 then 123670. (round down below Subsidiary currency)</p> <p>The result of FCY TD interest,</p> <p>If 123.678 then 123680. (round closer below Subsidiary currency)</p>	
23	Uncollected interests	FIXED		C	12	all zeros	
24	Passbook capital balance symbol	DERIVED	'-' (balance is negative) or space (positive / not issued)	C	1		

25	Passbook capital balance	DERIVED	Balance of CASA (JPY/FCY) 0 for other accounts	N	17	14,3	
26	Passbook update classification	FIXED	1(unprinting exist),"0"(No unprinting exist or not issued)	N	1		
27	Savings passbook not issued classification	DERIVED	1(not issued),"0"(issued)	N	1		
28	Foreign currency type	DERIVED	Account Currency Code for FCY accounts for LCY accounts - null	C	3		
29	Debt classification	DERIVED	CASA: 0 - if collateral is not created for deposit 2 - if collateral is created TD: N/A (space)	N	1		

30	Collateral deposit classification	DERIVED	<p>A.Set '0'</p> <p>If there are no records in STODCOL whose fields 6-10 matches to the value of fields 4-8 in deposit file,</p> <p>B. If there are any records in collateral file whose fields 6-10 matches to the value of fields 4-8 in deposit file</p> <p>i) Set '3' (Under attachment )</p> <p>AND all 3 conditions below are satisfied</p> <p>1) Select accounts whose status is "restricted"</p> <p>a) for CASA ;</p> <p>Acct.Status = "Block the Account"</p> <p>or "Disallow debits"</p> <p>or "Allow debits with override"</p> <p>b) for TD ;</p> <p>Acct.Status = "Block the Account"</p> <p>2) search acct-status-change-history, and select the records where after-status in history = acct-status in present acct master. If more than one records</p>	N	1		
----	-----------------------------------	---------	--	---	---	--	--

31	401K classification	FIXED	NA	N	1		"0"
32	Ineligible deposit classification	FIXED	NA	N	1		"0"
33	Third party investment trust classification	FIXED	NA	N	1		"0"
34	(Maruyu) Tax-free small-sum savings system classification	FIXED	Maruyu flag	N	1		"0"/"1"
35	(Maruzai) Tax-free property accumulation system classification	FIXED	NA	N	1		"0"
36	Tax-free corporation classification	FIXED	NA	N	1		"0"
37	Children's bank savings classification	FIXED	NA	N	1		"0"
38	Other than objective repayment total	FIXED	NA	C	13		all zeros
39	Joint signature savings classification	DERIVED	Set "1" - if CASA interest rate is 0 OR no Cr interest formula is attached  Set "0" - In case of the other code, sets "0".	N	1		



40	Discount rate (%)	FIXED	NA	C	7		all zeros
41	General ledger principal amount	FIXED	NA	C	11		all zeros
42	Assumed interest payable coefficient	FIXED		C	8		all zeros
43	Date immediately preceding interest payment	FIXED	NA	C	8		all zeros
44	3		NA	N	1		"3"
45	Dummy	FIXED	NA	C	11	all space	

The following periodic outgoing file with collateral data is generated for the format ID 'STODCCOL'.

Sl. No	Field Name	Field Type	Derivation Logic	Data type	Length	Format Remarks	Fixed Value
1	Data classification	FIXED	NA	N	1		"3"
2	Data type	FIXED	NA	N	2		"06"
3	Financial institution code	DERIVED	Bank Code in Bank Parameters	C	4		
4	CIF (customer) branch code	DERIVED	First 3 digits of PID	C	3		
5	CIF (customer) number	DERIVED	"CRP" + the last 7 digit of PID (left trim)	N	10		
6	Collateral deposit branch code	FIXED	1st 3 digits of account number	C	3		"00"

7	Collateral deposit deposit type code	DERIVE D	product type/ CCY 01 - JPY CASA 05 - JPY TD 17- FCY CASA 18- FCY TD 13- Other deposits	C	2		
8	Collateral deposit deposit type code sub-number	FIXED	"00"	N	2		"00"
9	Collateral deposit account number	DERIVE D	Digits 4-15 of ac number (left trim)	C	12		
10	Collateral deposit account sub-number	DERIVE D	TD : 0001 CASA : 0000	N	4		
11	Dummy	FIXED	NA	C	17		all space

The following periodic outgoing file with outstanding loan data is generated for the format ID 'STODCODA'.

Sl. No	Field Name	Field Type	Derivation Logic	Data type	Length	Format Remarks
1	Data classification	FIXED	NA	N	1	
2	Data type	FIXED	NA	N	2	
3	Financial institution code	DERIVED	Bank Code in Bank Parameters	C	4	
4	CIF (customer) branch code	DERIVED	1st 3 digits of PID	C	3	
5	CIF (customer) number	DERIVED	CRP+ last 7 digits of PID	N	10	

6	Outstanding loan	DERIVED	Customer loan balance across loan accounts	N	12	First 12 digits of amount field
7	Accrued interest on loan	DERIVED	Accrued interest on loan	N	12	
8	Dummy	FIXED	all space	C	16	

The following periodic outgoing file with appendix data is generated for the format ID 'STODCAPP'.

SI. No	Field Name	Field Type	Derivation Logic	Data type	Length	Format Remarks	Fixed Value
1	Branch code	DERIVED	the first 3 digit of PID (the same as it of Nayose CIF)	C	3		
2	comma	FIXED	NA	C	1		","
3	CIF(customer) number	DERIVED	"CRP"+the last 7 digit of PID	C	10		
4	comma	FIXED	NA	C	1		","
5	NCIF(customer) number	FIXED	NA	C	8		ALL space
6	comma	FIXED	NA	C	1		","
7	Business Division code	DERIVED	"CRP"	C	3		
8	comma	FIXED	NA	C	1		","
9	Customer Group code	FIXED	NA	C	3		ALL space
10	comma	FIXED	NA	C	1		","

11	Customer Type Code	DERIVED	Based on customer tax group code description A: 'Resident', D: 'Non Resident' I: 'Tax Exemption'	C	1		
12	comma	FIXED	NA	C	1		","
13	industry type classification	FIXED	NA	C	5		"00000"
14	comma	FIXED	NA	C	1		","
15	Dormancy Flag(reason code)	DERIVED	Account Status Dormant flag 'Yes' then '1' else '0'	C	1		
16	comma	FIXED	NA	C	1		","
17	Birth date flag(reason code)	FIXED	NA	C	1		ALL space
18	comma	FIXED	NA	C	1		","
19	Dummy	FIXED	NA	C	16		ALL space

The following incoming file from DIC following bankruptcy is generated for the format ID 'STIDCCIN'.

S. No	Field Name	Field Type	Processing Logic	Data type	Length	Format Remarks	Fixed Value
-------	------------	------------	------------------	-----------	--------	----------------	-------------

1	Deposit Item Code	DERIVE D	product type/ CCY  01 - JPY CASA  05 - JPY TD  17- FCY CASA  18- FCY TD  13- Other deposits	C	2		
2	Drawdown Number	FIXED	NA	N	2		
3	Account Number	DERIVE D	Digits 4-15 of account number	C	12	Concatenate fields '4+3' to arrive at account number	
4	Account Branch Number	FIXED	1st 3 digits of account number	N	4		
5	Non Insure Classification	DERIVE D	1 - if total account balance is uninsured  2- if partial account balance is uninsured	C	1		
6	Setting Classification (Spare)	FIXED	NA	C	1	"1"	
7	Non Insure Amount (Principal)	DERIVE D	Uninsured principal to be transferred to GL	N	14		
8	Non Insure Amount (Interest)	DERIVE D	Uninsured interest to be transferred to GL	N	12		
9	(for division Saving Account with interest)	DERIVE D	Include this amount to be deducted from CASA and paid to Uninsured GL	N	12		

10	Dummy	FIXED	NA	C	21		
----	-------	-------	----	---	----	--	--

The following daily tran reporting on insured portion is generated for the format ID 'STODCCTN'.

SI.No	Field Name	Field Type	Processing Logic	Data type	Length	Format Remarks	Fixed Value
<b>HEADER</b>							
1	Data Classification	FIXED	NA	N	1		"1"
2	Data Type	FIXED	NA	N	2		"10"
3	Code Specification	FIXED	NA	N	1		"1"
4	Financial Institution Code	DERIVED	Bank Code in Bank Parameters	C	4		
5	Creation Date	DERIVED	Creationdate YYYYMMDD	N	8		
6	Creation Time	DERIVED	Creationdate HHMMSS	N	6		
7	Value Date (from)	DERIVED	Transaction value date From YYYYMMDD	N	8		
8	Value Date (to)	DERIVED	Transaction value date To YYYYMMDD	N	8		
9	Tape Number	DERIVED	Unique number for magnetic tape	C	10		
10	Dummy	DERIVED	Set all space	C	152		
					200		
<b>STATEMENT RECORD (BODY)</b>							
1	Data Classification	FIXED	NA	N	1		"3"

2	Data Type	FIXED	NA	N	2		"10"
3	Financial Institution Code	DERIVED	Bank Code in Bank Parameters	N	4		
4	Branch Code	DERIVED	First 3 digits of account number	C	3		
5	Deposit Item Code	DERIVED	product type/ CCY 01 - JPY CASA 05 - JPY TD 17- FCY CASA 18- FCY TD 13- CASA with 0% interest or no Credit interest formula attached	C	2		
6	Draw-down Number	FIXED	NA	N	2		space
7	Account Number	DERIVED	Digits 4-15	C	12		
8	Account Sub Number	FIXED	NA	N	4		"00"
9	CIF (Customer) Branch Code	DERIVED	1st 3 digits of PID	C	3		
10	CIF (Customer) Number	DERIVED	CRP+ last 7 digits of PID	C	10		

11	Value Date	DERIVED	Transaction value date YYYYMMDD	N	8		
12	Transaction Number	DERIVED	Running serial number to signify nth transaction for account on tran value date	N	8		
13	Credit ?Debit Date	DERIVED	Same as value date	N	8		
14	Deposit Status Classification	DERIVED	CASA : 0 - New account 1 - Credit 2 - Debit 3 - Reversal TD: 0 - booking 1 - Reversal of debits, if any 2 - Other debits to account 3 - Full redemption	N	1		



15	Transaction Classification	DERIVED	10 : cash (include checks issued by other banks) 14 : account transfer (interest of Saving Account etc. and middle interest of Term Deposit transfer to a designated account) 15 : automatic renewal 18 : others 19 : correction	N	2	module/ product/ event or tran code basis	
16	Transaction Principal Amount	DERIVED	Transaction amount with leading 0's	C	12		
17	Interest Rate (%)	DERIVED	Interest rate considered in case of TD redemption, else 0	N	9		
18	Interest Rate after Maturity (%)	DERIVED	If field 14 is TD booking related (0), then corresponding interest rate , else 0	N	9		
19	Maturity Date	DERIVED	Maturity date of TD YYYYMM-MDD if available, else all 0's	N	8		
20	Transaction Interest Amount	DERIVED	Interest amount with leading 0's in case of TD redemption	C	11		

21	Balance Sign after Transaction	DERIVED	-, if account balance after transaction is in Dr, else space	C	1		
22	Balance after Transaction	DERIVED	Current balance after transaction with leading 0's	N	14		
23	Dummy	FIXED	NA	C	66		space
					200		
<b>TRAILER</b>							
1	Data Classification	FIXED		N	1		"8"
2	Data Type	FIXED		N	2		"10"
3	Financial Institution Code	DERIVED	Bank Code in Bank Parameters	C	4		
4	New Transaction Number	DERIVED	?total number of Deposit Status Classification of ?0?(New) in this MT  ?number set by right-justified + remaining "0" (for example) 1,234 transaction is ?000001234 ?	N	9		

5	Total Amount of New Transaction	DERIVED	<p>?total principal amount of all transaction of Deposit Status Classification of ?0?(New) in this MT</p> <p>?number set by right-justified + remaining "0" (for example) 12,345,600 Yen is ?00000012345600?</p>	N	14		
6	Credit Transaction Number	DERIVED	<p>?total number of Deposit Status Classification of ?1?(Credit) &amp; not Transaction Classification of ?19?(Correction) in this MT</p> <p>?number set by right-justified + remaining "0" (for example) 2,345 transaction is ?000002345?</p>	N	9		

7	Total Amount of Credit Transaction	DERIVED	<p>?total principal amount of all transaction of Deposit Status Classification of ?1?(Credit)</p> <p>&amp; not Transaction Classification of ?19?(Correction) in this MT</p> <p>?number set by right-justified + remaining "0" (for example) 23,456,700 Yen is ?00000023456700?</p>	N	14		
8	Total Number of Credit Correction Transaction	DERIVED	<p>?total number of Deposit Status Classification of ?2?(Debit)</p> <p>&amp; Transaction Classification of ?19?(Correction) in this MT</p> <p>?number set by right-justified + remaining "0" (for example) 3,456 transaction is ?000003456?</p>	N	9		

9	Total Amount of Credit Correction Transaction	DERIVED	<p>?total principal amount of all transaction of Deposit Status Classification of ??(Debit)</p> <p>&amp; Transaction Classification of ?19?(Correction) in this MT</p> <p>?number set by right-justified + remaining "0" (for example) 23,456,700 Yen is ?00000023456700?</p>	N	14		
10	Debit Transaction Number	DERIVED	<p>?total number of Deposit Status Classification of ??(Debit)</p> <p>&amp; not Transaction Classification of ?19?(Correction) in this MT</p> <p>?number set by right-justified + remaining "0" (for example) 4,567 transaction is ?000004567?</p>	N	9		

11	Total Amount of Debit Transaction	DERIVED	<p>?total principal and interest amount of all transaction of Deposit Status Classification of ??(Debit)</p> <p>&amp; not Transaction Classification of ?19?(Correction) in this MT</p> <p>?number set by right-justified + remaining "0" (for example) 45,678,900 Yen is ?00000045678900?</p>	N	14		
12	Total Number of Debit Correction Transaction	DERIVED	<p>?total number of Deposit Status Classification of ?1?(Credit)</p> <p>&amp; Transaction Classification of ?19?(Correction) in this MT</p> <p>?number set by right-justified + remaining "0" (for example) 5,678 transaction is ?000005678?</p>	N	9		

13	Total Amount of Debit Correction Transaction	DERIVED	<p>?total principal and interest amount of all transaction of Deposit Status Classification of ?1?(Credit)</p> <p>&amp; Transaction Classification of ?19?(Correction) in this MT</p> <p>?number set by right-justified + remaining "0" (for example) 56,789,000 Yen is ?00000056789000?</p>	N	14		
14	Cancellation Transaction Number	DERIVED	<p>?total number of Deposit Status Classification of ?3?(Cancellation) in this MT</p> <p>?number set by right-justified + remaining "0" (for example) 7,890 transaction is ?000007890?</p>	N	9		

15	Total Amount of Cancellation Transaction	DERIVED	?total principal and interest amount of all transaction of Deposit Status Classification of ???(Cancellation)  ?number set by right-justified + remaining "0" (for example) 78,900,000 Yen is ?00000078900000?	N	14		
16	Number of Statement Record	DERIVED	?Total Number of Statement Record in this MT  ?number set by right-justified + remaining "0" (for example) 12,300 records is ?000012300?	N	9		
17	Dummy	FIXED	all space	C	46		
18	Data Classification	FIXED		N	1		"9"
19	Data Type	FIXED		N	2		"10"
20	Financial Institution Code	DERIVED	Bank Code in Bank Parameters	N	4		



21	Total Number of Statement Record	DERIVED	Total Number of Statement Record number set by right-justified + remaining "0" (for example) 23,456 records is ?000023456 ?	C	9		
22	Dummy	FIXED	all space	C	184		

The following uninsured balance reporting to third party system is generated for the format ID 'STODCCUN'.

Sl. No	Field Name	Field Type	Derivation Logic	Data type	Length	Format Remarks	Fixed Value
1	Data-Classification	FIXED	NA	N	1		"3"
2	Data Type	FIXED	NA	N	2		"36" ( Fixed value )
3	Cif-Branch-Code	FIXED	NA	V	3		" " ( All space )
4	Cif Number	DERIVED	CRP+ last 7 digits of PID	V	10		
5	Branch-Code	DERIVED	the first 3 digit of account no.	V	3		
6	BankAccount-Number	DERIVED	Uninsured GL to which amount is transferred	C	16	"400751000123456" ( 16th byte is space )	

7	DepositItemCode	DERIVED	product type/CCY 01 - JPY CASA 05 - JPY TD 17- FCY CASA 18- FCY TD 13- Other deposits	V	2		
8	DepositItemCode-Branch-Number	FIXED	NA	N	2	"0"	"00"
9	Account-Number	DERIVED	Account Number of Insured Portion; digits 4-13 followed by 2 spaces	V	12	"75825932D1 " ( 11th&12th byte are space )	
10	Account-Branch-Number	FIXED	NA	N	4		"0000"
11	NonInsured-Classification	DERIVED	1 - if total account balance is uninsured 2- if partial account balance is uninsured	C	1	"2"	
12	Setting-Classification	FIXED	NA	C	1		"1" ( Fixed value )
13	NonInsured-PrincipalAmount	DERIVED	Uninsured principal transferred to GL	N	14	(14, 0)	
14	NonInsuredInterestAmount	DERIVED	Uninsured interest transferred to GL	N	12	(12, 0)	

15	Account-Bal- anceAm ount	DERIVE D	Account Balance before split	N	14	(14, 0)	
16	ValidFlag	FIXED	NA	C	1	"Y"	
17	With- drawal- Process edFlag	FIXED	NA	C	1	"W"	
18	GIPro- cessed- Flag	FIXED	NA	C	1	"C"	
19	NonIn- sured- BranchC ode	FIXED	NA	N	4		"0000"
20	NonIn- sured- DepositIt emCode	DERIVE D	product type/CCY  01 - JPY CASA  05 - JPY TD  17- FCY CASA  18- FCY TD  13- Other deposits	V	2	"05"	
21	NonIn- sured- DepositIt emCode- Branch- Number	FIXED	NA	N	2	"0"	"00"
22	NonIn- suredAc- countNu mber	DERIVE D	DIC account number (as per mask at STDDICP)  digits 4-13 followed by 2 spaces	V	12	"7582593 2D1 "	
23	NonIn- suredAc- countBra nchNum- ber	FIXED	NA	N	4		"0000"

24	Deposit-Date	DERIVE D	Account Open Date in YYYYM-MDD format	D	8	"20120427"	
25	Maturity-Date	DERIVE D	Maturity Date in YYYYM-MDD format for TD  CASA - 00000000	D	8	"20190427"	
26	InterestRate	DERIVE D	Interest rate last applied on account	N	9	(2, 7)	
27	InterestRateAfterMaturity	FIXED	NA	N	9	(2, 7)	"0" ( Fixed value )

## 2.6 Maintaining Mynumber Reason Code

Mynumber is an a full file, which consists of full data to be uploaded. Mynumber file contains information of a customer such as., Customer PID, Reason Code and Status (active / delete). Oracle FLEXCUBE facilitates storing the Mynumber upload data with reason codes that accompany the Mynumber file upload of customers. While querying the customer data, the system displays these data in 'Customer Maintenance' screen (STDCIF). The system validates whether the Customer PID and the Reason code are valid.

---

### Note

If Mynumber data is modified using upload, the data store is truncated and uploaded with the data in the Interface.

---

You can maintain Mynumber reason code and it's description in the 'Mynumber Reason Code Maintenance' screen. To invoke this screen type 'STDMRCMT' in the field at the top right corner of the Application toolbar and clicking on the adjoining arrow button.



Specify the following details:

**Reason Code**

Specify the reason code that accompany Mynumber file upload of customer.

**Reason Code Description**

Specify the description of the reason code of Mynumber file upload of customer.

## 2.6.1 Viewing Mynumber Reason Code Summary

You can view the Mynumber reason code summary details in 'Mynumber Reason Code Summary' screen. You can invoke this screen by typing 'STSMRCMT' in the field at the top right corner of the Application tool bar and clicking on the adjoining arrow button.



You can search for the records based on either one or more of the following search parameters:

- Authorization Status
- Record Status
- Reason Code
- Description

Once you have specified the search parameters, click 'Search' button. The system will display the following information:

- Authorization Status
- Record Status
- Reason Code
- Description

## 2.7 Mynumber Upload Interface - STGICUMN

Mynumber Upload Interface STGICUMN is a file containing customer data for Mynumber. This interface consists of Customer PID and Reason code as data. The interface consists of

multiple records for the same PID and with different Reason Code. Oracle FLEXCUBE truncates and stores the uploaded data in a separate data store, which contains the following details:

- Customer PID
- Reason Code

---

**Note**

Customer PID and the Reason code together will be unique in the data store.

---

**Header**

Following table describes the Header of the interface:

Field No	Field Name	Field Description	Data Type	Start position	End position	Field Length	Remarks
1	Header Identifier	Fixed 'HDR'	Aplphanumeric	1	3	3	This field would be used to identify the header record in the file. Default value is "HDR".
2	System Code Origin	FCJ	Aplphanumeric	4	13	10	System which generated the output file. Default value is "FCJ"
3	Destination system code		Aplphanumeric	14	23	10	System in which file needs to be processed.
4	Date	Date countable in format YYYYM-MDD	Numeric	24	33	10	Date when the output file has been generated i.e system date. Date format is "RRRRM-MDD" (Date of generation of file)

**Body**

Following table describes the Body of the interface:

Field No	Field Name	Field Description	Table Name	Field Name	Data Type	Start position	End position	Field Length	Precision	Remarks
1	Body Identifier	Fixed Value 'BDY'			Alphanumeric	1	3	3		Body Identifier
2	CUSTOMER_PID	PID of the customer	STTM_S_CUSTOMER_M YNUMBER_C	CUSTOMER_PID	Alphanumeric	4	23	20		Customer PID.
3	REASON_CODE	Reason code for My Number update	STTM_S_CUSTOMER_M YNUMBER_C	REASON_CODE	Alphanumeric	24	25	2		Reason code for the My number update

### Trailer

Following table describes the Trailer of the interface:

Field No	Field Name	Field Description	Data Type	Start position	End position	Field Length	Remarks
1	Trailer Identifier	Fixed 'TLR'	Alphanumeric	1	3	3	This field would be used to identify the Trailer record in the file. Default value is "TLR".

## **2.8 Tax Number Upload Interface - STGICUTN**

Tax Number Upload Interface STGICUTN is a file processed in Oracle FLEXCUBE with a set periodicity which can be defined in the 'Interface Definition' – GIDINTDF. The interface consists of only one record per Liability ID and the Tax number details for the upload. Liability ID is unique in the data store



Oracle FLEXCUBE does not perform any validation on the data available in the interface. The system stores the uploaded data in a separate data store. Oracle FLEXCUEBE truncates the data and upload the data from the interface during every time the interface is processed.

The data store consists the following details:

- Liability\_ID
- Taxnumber

**Header**

Field No	Field Name	Field Description	Data Type	Start position	End position	Field Length	Remarks
1	Header Identifier	Fixed 'HDR'	Alphanumeric	1	3	3	This field would be used to identify the header record in the file. Default value is "HDR".

**Body**

Field No	Field Name	Field Description	Table Name	Field Name	Data Type	Start position	End position	Field Length	Precision	Remarks
1	Body Identifier	Fixed Value 'BDY'			Alphanumeric	1	3	3		Body Identifier

2	LIA-BILITY_ID	LIA-BILITY ID of the customer for Tax Number upload	STTB_CUST_TAX_NUM_UPLOAD_C	LIA-BILITY_ID	Apl-hanumeric	4	23	20		LIA-BILITY ID of the customer for Tax Number upload
3	TAX-NUMBER	Reason code for My Number update	STTB_CUST_TAX_NUM_UPLOAD_C	TAX-NUMBER	Apl-hanumeric	24	36	13		Reason code for the Mynumber update

### **Trailer**

Field No	Field Name	Field Description	Data Type	Start position	End position	Field Length	Remarks
1	Trailer Identifier	Fixed 'TLR'	Apl-hanumeric	1	3	3	This field would be used to identify the Trailer record in the file. Default value is "TLR".

## **2.9 Reconciliation Interface - STGORECN**

Reconciliation Interface STGORECN is an outgoing interface with the data of reconciliation between Oracle FLEXCUBE stored data and the Mynumber Incoming Interface that is going to be processed that moment.

This interface consist of results with PID, Reason code and Result as fields.

- Result will be 'Missing in FCUBS', when the data is present in the Mynumber incoming Interface and not in Oracle FLEXCUBE.
- Result will be 'Missing in NRI' when the data is present in Oracle FLEXCUBE and not in Mynumber incoming interface.

Reconciliation data is processed and populated to the Reconciliation Data store in Oracle FLEXCUBE during every processing of the Mynumber Interface STGICUMN. Hence, the reconciliation outgoing Interface can be generated anytime as required in Oracle FLEXCUBE.

The generated reconciled data consists of data corresponding to the latest Mynumber Incoming Interface STGICUMN processed and the data that was present in Oracle FLEXCUBE, prior to the interface STGICUMN processing.

## Header

Field No	Field Name	Field Description	Data Type	Start position	End position	Field Length	Remarks
1	Header Identifier	Fixed 'HDR'	Alphanumeric	1	3	3	This field would be used to identify the header record in the file. Default value is "HDR".

## Body

Field No	Field Name	Field Description	Table Name	Field Name	Data Type	Start position	End position	Field Length	Precision	Remarks
1	Body Identifier	Fixed Value 'BDY'			Alphanumeric	1	3	3		Body Identifier
2	LIA-BILITY_ID	LIA-BILITY ID of the customer for Tax Number upload	STTB_CUST_TAXNUM_UPLOAD_C	LIA-BILITY_ID	Alphanumeric	4	23	20		LIA-BILITY ID of the customer for Tax Number upload
3	TAX-NUMBER	Reason code for My Number update	STTB_CUST_TAXNUM_UPLOAD_C	TAX-NUMBER	Alphanumeric	24	36	13		Reason code for the My Number update

## Trailer

Field No	Field Name	Field Description	Data Type	Start position	End position	Field Length	Remarks
1	Trailer Identifier	Fixed 'TLR'	Alphanumeric	1	3	3	This field would be used to identify the Trailer record in the file. Default value is "TLR".

## 2.10 Maintaining Transaction Code Class

You can configure a Transaction Code Class with a required list of transaction codes that has to be considered for the FX Position Monitor.

You can configure a new Transaction Code Class in the 'Transaction Code Class Maintenance' screen. To invoke this screen type 'STDTCCLM' in the field at the top right corner of the Application toolbar and clicking on the adjoining arrow button.



Specify the following details:

### **Transaction Code Class**

Specify the class code of the Transaction Code Class.

## Transaction Code Class Description

Specify the description of the Transaction Code Class selected.

### **Transaction Code**

Specify the transaction code part of the Transaction Code Class Maintenance. Alternatively, you can select the transaction code from the option list maintained in the system. The list displays the valid transaction code maintained in the system.

### **Transaction Code Description**

The system displays the description of the transaction code selected for the Transaction Code Class Maintenance.

## **2.10.1 Viewing Transaction Code Class Maintenance Summary**

You can view the transaction code class maintenance summary details using the 'Transaction Code Class Maintenance Summary' screen. To invoke this screen, type 'STSTCCLM' in the field at the top right corner of the Application tool bar and click the adjoining arrow button.



You can query on records based on any one or all of the following criteria:

- Authorization Status
- Record Status
- Transaction Code Class
- Transaction Code Class Name

Click 'Search' button. The system identifies all records satisfying the specified criteria and displays the following details for each one of them:

- Authorization Status
- Record Status
- Transaction Code Class
- Transaction Code Class Name



---

## 3. Ramadan Maintenance

### 3.1 Introduction

*Zakat* is a charge which is applied on the balance in an account if the balance is above a certain threshold amount. This charge is applicable only to savings accounts and Term Deposits (TD). It cannot be levied on current accounts.

The minimum threshold amount above which *Zakat* will be payable is decided every year before *Ramadan*. In addition, the percentage to be applied on the capital amount for calculation of *Zakat* is also decided.

This charge is levied on the savings accounts and TD accounts at *Ramadan*. For savings accounts, *Zakat* is computed on the balance as on the first day of *Ramadan* for all active accounts. The applicable amount is then deducted from the accounts.

In the case of TD accounts, *Zakat* is computed whenever there is a redemption of the principal. It is computed on the redeemed principal amount, provided the first day of *Ramadan* (for any one year of the TD tenor) falls between the profit start date of the deposit and the maturity date.

For computation and collection of *Zakat* you need to capture the first day of Ramadan every year.

### 3.2 Maintaining Ramadan Day

You can capture the first day of *Ramadan* for a given year in the 'Ramadan Day Maintenance' screen. This is a bank-level maintenance that needs to be done at your Head Office. To invoke the 'Ramadan Day Maintenance' screen, type 'CSDRAMDN' in the field at the top right corner of the Application tool bar and clicking the adjoining arrow button.

The screenshot shows a software window titled "Ramadan Day Maintenance". At the top, there are two buttons: "New" and "Enter Query". The main area contains two input fields: "Year\*" and "First Day of Ramadan". The "Year\*" field has a small calendar icon to its right, and the "First Day of Ramadan" field has a date picker icon. At the bottom of the window, there is a status bar with the following information: "Input By", "Date Time", "Authorized By", "Date Time", "Modification Number", and two checkboxes labeled "Authorized" and "Open".

Here you can specify the following details:

**Year**

Specify the year for which you are capturing the first day of *Ramadan*. Note that you cannot maintain multiple records for the same year.

**First Day of Ramadan**

Specify the date on which *Ramadan* starts in the specified year. Note that the date should be valid as per the *Ramadan* calendar.

*Refer the chapters titled 'Defining the attributes specific to an Interest or Charge product' and 'Daily Processing of Interest and Charges' in the Interest and Charges User Manual for details on Zakat computation and application.*



---

## 4. Dealer Maintenance

### 4.1 Defining Dealer

At the time of entering the details of a foreign exchange, money market, or securities deal, you will be required to enter details of the dealer who has struck the deal.

The dealers at your bank, who are associated with the buying and selling of foreign exchange, money or securities in the treasury, should each be assigned an identification number (ID number). The dealer list is maintained for the bank through the 'Dealer Maintenance' screen. Invoke this screen by typing 'STDDLRT' in the field at the top right corner of the Application tool bar and clicking the adjoining arrow button.

The screenshot shows a software window titled "Dealer Maintenance". At the top, there is a toolbar with "New" and "Enter Query" buttons. The main content area has two text input fields: "Dealer Id \*" and "Dealer Name". Below this is a section labeled "Fields" which contains a grid of labels: "Maker", "Date Time:", "Mod No", "Checker", "Date Time:", "Record Status", and "Authorization Status". An "Exit" button is positioned in the bottom right corner of the window.

The following parameters need to be maintained to define a dealer ID:

#### **Dealer Id**

Enter a unique code to identify the dealer. The identification code can have a maximum of six alphanumeric characters.

The dealer will be identified by this code for all transactions entered in Oracle FLEXCUBE. You can also retrieve dealer-wise information on the treasury deals entered into by your bank.

#### **Dealer Name**

You can also enter a detailed name of the dealer. The name of the dealer will be displayed whenever the dealer Id is used.

---

## 5. Branch Parameters

### 5.1 Creating Branches

In the 'Branch Parameters' screen you create the various branches of your bank, define their reporting hierarchy, and maintain parameters such as their names, their address of location, SWIFT, TELEX, and HOST addresses.

In this screen you can do the following:

- Create the Regional Offices and branches of your bank by assigning each a unique branch code
- Maintain the address of location of each of the branches and also their SWIFT, TELEX and HOST addresses
- Specify the Suspense GL for posting all those accounting entries for which no GL has been specified or the specified GL has been closed
- Define preferences, such as - the retention duration, a CIF number for walk-in customers and the GL for netting FX contracts
- Maintain customer number range for generation of CIF numbers for customers of your bank.

The HO creates the branches at the bank level. All subsequent modifications on the table are done from the respective branches.

#### 5.1.1 System Features

Oracle FLEXCUBE supports a three level reporting structure.

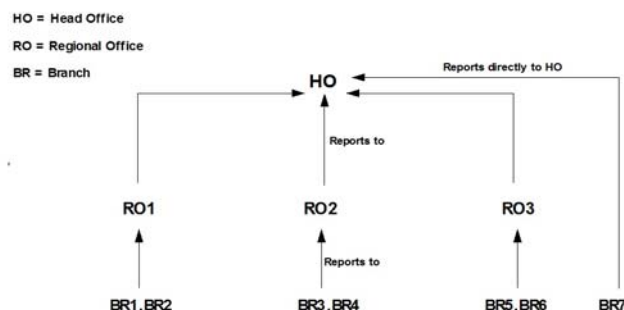

At the top stands the Head Office followed by the Regional Offices. At the lowest level are the branches. There can be any number of branches, but the number of regional offices is restricted to six. The system validates to check that the number of parent branches is not more than six. If the number of parent branches is more than six, system will give an error and restrict the number to six.

The branches report to the RO; and the ROs in turn report to the HO. Within this three level structure you can also have a branch reporting independently to the Head office (as branch, BR7 in the diagram).

It is also possible to have a two level reporting structure with only the HO and the branches, where each individual branch reports directly to the HO.

## 5.1.2 Creating Reporting Structure

The order in which you create the HO, the ROs and the branches should follow the hierarchy. Hence, the first branch to be created should be the HO, followed by the ROs, and then the branches.

The Head Office of your bank is created during installation. You only have to create the Regional Offices and the various branches. During installation, the system automatically populates this screen with the branch code and name of your Head Office that you have specified to the implementer. The 'Parent branch' and the Regional Office fields' also default to this branch code.

To create an RO, invoke a new screen. Then, enter the code and name of the RO against 'Branch Code' and 'Name' respectively. You do not need to specify the 'Regional office' because the HO Code is the default for the field. (All ROs report to the HO).

Then create all the branches. If a branch reports to an RO, to specify that RO is the branch's 'Regional Office', select the code you want from the option list provided for this field.

But before designating, you should authorize all the RO records you have created; the system will not allow you to use any unauthorized record.

### (Diagrammatic Representation)

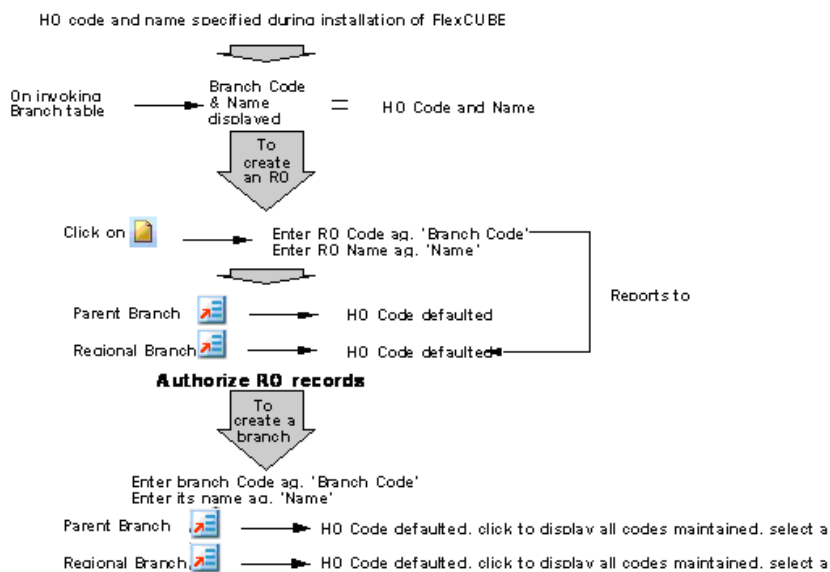

## 5.1.3 Basic Parameters for Branch

In Oracle FLEXCUBE, the Head Office and the Regional Offices are defined as branches. You can maintain the details of the Head Office, regional offices and branches in the 'Branch'.

Parameters Maintenance' screen. Invoke this screen by typing 'STDBRANC' in the field at the top right corner of the Application tool bar and clicking the adjoining arrow button.

You can specify the following details here:

### Branch Code

This is the code you assign to the office or branch. The code acts as an identifier in the system for the office / branch.

### Branch Name

This is the name of the office or branch, the code of which is input. Enter the name using a max. Of 35 characters, alphanumeric

### Branch Available

The system displays the Branch Available status. If the status is 'Yes', it indicates that the branch can accept transactions for the day and if the status is 'No', then it indicates that the transactions will be accepted but it will be in effect only from the next business day.

Accordingly accounting entries will be passed checking the following, for tanking branch transactions:

- The Branch Available Status
- The Branch date and host date i.e. entries will be tanked if branch date is ahead of host date

When the Branch Available status is 'NO' or if branch date is ahead of host date, then the transactions will be tanked. These transactions will be untanked by the BOD program which runs post date change i.e. POSTDTCH.

---

### Note

If you want to check whether the transaction is tanked or not, you should login to host and refer to the corresponding query function.

---

### **Alternate Branch Code**

Specify the alternate branch code. Alternate branch code is mandatory if it is used for the PID mask at bank level or the account number mask at the branch level. The system checks if the length of alternate branch code is same as the number of 'r' maintained in PID mask or account number mask.

Alternate branch code can be used as a component for CASA account number mask and PID number. For example, if the account number and PID number will have the mask like 'rrrTTTSSSSSSSSd' and 'rrrrnnnnnnnnnnnd' respectively, then the system picks 'rrr' as the alternate branch code while generating account number and PID number.

The branch code and alternate branch code should be in numeric characters.

*For more information on 'Querying the Transactions' refer Retail Teller, Clearing and Utility Payment Chapters under Oracle FLEXCUBE host module.*

## **5.1.4 Maintaining General Details for Branch**

You can maintain the branch details regarding the local currency, the parent branch, regional office of the branch, address details including telex, BIC etc.

### **Local Currency**

Specify the currency of operation for your branch and the default currency for all transactions of your branch. The income and expense balances of your branch will also be maintained in this currency.

### **Parent Branch**

Parent Branch is to define an alternate reporting line, other than the three level HO-RO-Branch structure. The 'Parent' for all the branches you create is the HO code (default). To specify the Parent, other than the HO, select from the options displayed. The name of the parent branch is displayed alongside.

### **Regional Office**

This is the branch code of the Head Office or Regional Office to which the branch (whose code is input eg. Branch Code) reports.

For a Head Office or a Regional office, this code should be the Head Office branch code, which is also the default for this field. For the branches, specify that branch as the RO, to which the branch reports. Select from the list of options displayed.

### **Country Code**

Specify the code of the country in which the branch operates. Select from the options provided in the pick list

### **Customer Identity**

Specify the customer's identity. During maintenance of payments & collections periodic instructions, system defaults the customer number here.

### **GL Class**

Specify the GL Class. The adjoining option list displays a list of all the valid GL class codes and their description. You can choose the appropriate one.

---

#### **Note**

You can also select 'ALL' as an option. This indicates that all the GL codes are allowed for this branch.

---

### **Branch Type**

Select the branch type from the drop-down list. The list displays the following options:

- Retail - Indicates the retail branch
- Corporate - Indicates the corporate branch

#### **5.1.4.1 Specifying ATM Details**

Specify the following details

##### **ATM Branch**

Specify the ATM branch.

##### **Institution Identification**

Your bank may have a branch or multiple branches for different countries. You have to capture the identification code that uniquely identifies your bank branch in the ATM transactions interchange environment. Specify a code to identify the institution. This institution ID will help identify whether a particular transaction has been sent from an external network or whether it has originated from your bank branch.

##### **Inter Branch Transaction Code**

You can specify the Transaction Code through which accounting entries for inter-branch transactions should be settled.

##### **Customer Transfer**

Check this option to indicate that transfer transaction should be permitted through the ATM

#### **5.1.4.2 Specifying Address Details**

For each branch of your bank you maintain the following parameters:

##### **Branch Address**

Input the address of location of the branch. Each line can have a maximum of 35 characters.

##### **BIC**

Input the SWIFT address for a branch using 8 or 11 characters, alphanumeric

##### **Telex**

Specify the branch's TELEX address, using a maximum of 14 characters, alphanumeric

##### **Host Name**

Against 'HOST' enter the name of the Host server for this branch, in not more than 35 characters, alphanumeric

#### **5.1.4.3 Specifying Time Zone Offset**

For branches with different time zones, you can define the offset time that is to be displayed in maker/checker stamp and all the reports generated for the branch.

The offset time is specified in terms of hours and minutes, and the time will be added/ subtracted from the Server Time maintained for the bank.

##### **Hours**

Specify the number of hours to be offset from Server Time to arrive at the local branch time

This is the number of hours by which the branch leads or lags behind the Server Time

**Minutes**

Indicate the additional minutes by which the branch leads or lags behind the Server Time

---

**Note**

The reference of time is always the System Time (Server Time)

---

**Ahead**

The system calculates the local time of the Branch by adding/subtracting the Server Time and the Time Zone Offset time. When you maintain the offset time for the time zone, you need to specify whether the system should add or subtract the offset time from the Time Zone Offset.

Checking the Ahead box indicates that the offset time is added to the Server Time. Consequently, if the box is unchecked, the offset time is subtracted from the Server Time.

Additionally, the system validates the cutoff time depending on the time you specify here. The validation is based on following 3 parameters:

- Cutoff Time maintained for the currency in Currency Definition Screen
- Cutoff Offset Time maintained for the Branch in Branch Parameters Screen
- Time Zone Offset maintained for Branch in Branch Parameters Screen

**Time Level**

In this field is displayed the system time level status, represented by a number between 0 and 9

In Oracle FLEXCUBE, user access to the system can be controlled by assigning each user and the system, a time level. Both the system and the users are set to different time levels. Only those users who have a time level equal to or greater than the system time level can log into the system.

A control clerk, during the EOC process, does the change in time level status

**Fund Branch**

Even though the fund and the bank are in the same database, the fund is treated as a different legal entity and as such the books of the fund are maintained separately from those of the bank. Funds are created in a separate branch and any transaction initiated in the fund branch belongs to a fund. Check this box to indicate that the branch you are maintaining is a fund branch. Since the fund is a different legal entity, it should not be possible to initiate inter-branch accounting entries from the fund branch.

Any settlement with an external entity is routed through the normal settlements interface. In order to facilitate this, all the account fields in the system accept only the accounts in the transaction branch, if the branch happens to be a fund branch.

**Allow Corporate Access**

Select this option to specify that the fund subscription/redemption operations in the fund branch can access the accounts of corporate branch.

---

**Note**

- You will not be allowed to change this field once the branch record has been authorized.
  - This field will be enabled only if the branch is a fund branch.
-

**External Value**

Specify the name of the branch as maintained in an external system. This value can be used to interface with the external system.

**EOC Status**

Under EOC status one of the following alphabets will be displayed which stand for the following:

**B** - Beginning of financial input; indicates system transactions in progress

**I** -- Indicates that user transactions are in progress

**T**-- End of user transaction input; indicates system transactions in progress

**F** -- End of financial input; system transactions also completed

**E** -- End of Day, Branch awaiting date change

The values are updated by EOC process.

**5.1.4.4 Indicating Cutoff Offset Time**

When defining a currency, you can indicate a cut-off time for the currency. If your bank operates in branches located in different time zones, the cut-off time maintained for the bank will not be applicable across branches.

Therefore, you can set up an offset time for your branch based on the cut-off time set for the bank. You can specify an offset time for your branch in the Branch Parameters screen.

**Hours & Minutes**

The offset time is expressed in hours and minutes. The time you specify here is added or subtracted from the cut-off time maintained for the bank. This depends on the time difference between your branch and the Head Office.

**5.1.4.5 Indicating Local Payments****Clearing Branch**

Select the clearing branch from the adjoining option list.

**Transaction Code for Consolidation Across Products**

Select the transaction code for consolidation from the adjoining option list.



## 5.1.5 Maintaining Financial Details for Branch

You can specify the details regarding suspense GLs, Financial cycle, preference for floating rate, message generation (103,103+) for the branch in this screen. The screen appears as shown below:

The screenshot displays the 'Branch Parameters Maintenance' window with the following sections and fields:

- Branch Information:** Branch Code, Branch Name, Branch Available Status (checkbox).
- General Details:** Suspense General Ledger (Real Local Currency, Cont Local Currency, Real Foreign Currency, Cont Foreign Currency, ATM), Description fields.
- Financial Cycle:** Current Cycle, Current Period.
- Referral Cut Off Time:** Hours, Minutes.
- Amount Block Processing:** Transaction Code for Amount Block Release.
- Revaluation / Position Transfer Details:** Transfer Type, Transfer Branch, Position Asset GL, Position Liability GL, Transaction Code, Job Status (checkbox), Auto Authorization (checkbox).
- Euro Redenomination General Ledger:** Conversion General Ledger, Conversion Transaction Code, Description fields.
- Payment Messages:** Generate 103+ (checkbox), Default Bank Operation Code, Branch Code for Clearing, Clearing Through Branch, Loan Direct Debit Generation Days.
- Floating Rate:** Proceed without maintaining float rate (checkbox), Sector Code, Routing No, Deferred Statement Status, Install (dropdown menu).
- Suspense Batch Entry Details:** Suspense Entry Required (checkbox), Suspense Transaction Code, Suspense Batch Number, Reverse Suspense Entry Days, Maximum Real Suspense Amount, Maximum Cont Suspense Amount.
- Navigation:** Preferences, SWIFT Address, Account Mask, CIF Range, Global Interdict Functions, Tax, Branch Currency, Fields.
- User Information:** Maker, Checker, Date Time, Mod No, Record Status, Authorization Status, Exit button.

### 5.1.5.1 Specifying Suspense GL

The accounting entries generated by different modules of Oracle FLEXCUBE will be passed into the specified 'Suspense GL' account if:

- The GL into which the entries are to be passed is not defined, or
- If the GL has been closed

Suspense GLs are of two types:

#### Real Suspense GL (Local and Foreign Currency)

The accounting entries that belong to asset, liability, income or expense GL categories will be passed to the 'Real suspense GL'. To indicate the real suspense GL for a branch, click option list and select a GL code from the option list.

#### Contingent Suspense GL (Local and Foreign Currency)

The accounting entries that belong to contingent asset or contingent liability GL categories will be posted to a 'Contingent Suspense GL'.

To indicate the contingent suspense GL for a branch, click option list and select a GL code from the option list.

### 5.1.5.2 Specifying Euro Redenomination GL

To facilitate the currency conversion process, you have to maintain a common Conversion GL and a Transaction Code.

The conversion GL that you specify in this screen will be identified as the common suspense GL for all balance conversions while re-denominating the currency of an account either for specific customers or for generic conversions.

In addition to the conversion GL you have to indicate a Transaction Code, which identifies conversion, related entries.

### 5.1.5.3 Indicating Payment Messages

#### **Generate 103+**

The 'Generate MT 103 + option' allows you to generate outgoing MT 103 messages in the MT 103 + format. This check box can be enabled only if you have enabled the generation of MT 103 messages as Payment Messages.

---

#### **Note**

The system will generate MT 103 messages as payment messages for transactions in the branch, and generate them in the MT 103 + format only if you have enabled this option in the following cases:

- For the counterparty of the transaction, in the BIC Code Maintenance
- By choosing the Generate 103+ option for currency in the Currency Definition
- For the product used by the transaction, in the Product Preferences

The system is also capable of processing incoming MT 103 messages in the MT 103 + format. During the upload process the system considers an MT 103 payment message to be of MT 103 + Format based on the presence of the STP code in the 119 field. Field 119 is present in the third block of the message i.e., {3: {119:STP}}.

---

#### **Branch Code for Clearing**

Indicate the code that identifies your branch in the Clearing Network. The code you specify for your branch should be the same as that defined in the Clearing Bank Code Maintenance screen.

#### **Clearing Through Branch**

If clearing transactions involving your branch are routed through another branch, specify the Oracle FLEXCUBE branch code of that branch in this field.

On the basis of the Routing Number Mask defined for your bank, and your specifications in this screen, Oracle FLEXCUBE automatically generates the Routing Number for clearing transactions involving your branch in the Routing Number field.

#### **Loan Direct Debit Generation Days**

Loan DD Generation days specifies the number of days before the schedule payment date, when a Direct Debit Contract is generated for the schedule due. This is applicable only for Loan Contracts in the local currency.

In order to facilitate the processing of loan repayments by customers who have their current or settlement accounts in some other bank of the clearing network you can initiate Direct Debits to these accounts. When a payment is due on a loan, a direct debit is generated 'Loan DD Generation Days' before the payment date.

As a result in Oracle FLEXCUBE the following entries will be passed:

Dr	Clearing suspense
Cr	Dummy Settlement Account

During liquidation which is performed on the schedule date the entries passed are as follows:

Dr	Dummy Settlement Account
Cr	Loan Asset GL / Interest Income GL

*Refer the 'Maintaining the attributes specific to PC products' chapter of the PC manual along with the Branch Parameters section of the Core Services Manual for details on processing DDs originating from a Loan.*

#### **5.1.5.4 Processing Amount Block**

Oracle FLEXCUBE passes the accounting entries for releasing an amount block through the 'Transaction Code for Amount Block Release' field. The system will check whether any amount block of type CASA for a branch is in open status. If an account is in open status, the system will group the amount blocks into primary account and primary account branch. Then, the system will remove the amount block from the cover account and debit the blocked amount of the cover account to the primary account.

##### **Transaction Code for Amount Block Release**

Specify the transaction code for the release of amount block. The adjoining option list displays all valid transaction codes maintained in the system. You can choose the appropriate one.

#### **5.1.5.5 Indicating Financial Cycle**

##### **Current Cycle**

This is the code for the current financial year as defined by you in the 'Period Code' screen.

##### **Current Period**

Each financial year is divided into accounting periods called 'Period Codes' defined in the 'Period Code Maintenance' Screen (for details refer 'period Code screen'). The current accounting period of the financial year is displayed in this field.

#### **5.1.5.6 Specifying Referral Cut-off Time**

Referral refers to the process of handling customer transactions that force the accounts involved in such transaction to exceed the overdraft limit. Examples of typical transactions, which force an account to move into overdraft, are Payment and Collections, Funds Transfers, Standing Instructions or Clearing transactions. If an account is marked for referral, the details of transactions resulting in the account moving into Overdraft will be sent to the referral queue.

##### **Hours & Minutes**

In branch parameter, you have to specify the referral cut-off time for accepting / rejecting transactions in the referral queue.

In case a transaction is rejected from the referral queue after the cut-off time then system displays the override message as "Rejected after cut off time".

---

**Note**

Transactions are accepted into the Referral Queue even after cut-off time if account goes into overdraft.

---

**Auto Authorisation**

Oracle FLEXCUBE enables you to allow certain users (of your choice, depending on your requirements at your installation) to automatically authorize transactions.

To indicate applicability of automatic authorization for users of the branch, you must enable the Auto Authorization option in the Branch Parameters screen. When you do, you can then allow automatic authorization rights to the appropriate users at the branch.

*For more details about automatic authorization, refer the Security Management System and Procedures user manuals.*

**Deferred Statement Status**

This is a display field. This field indicates whether or not the Branch is ready for Deferred Statement Generation. 'Y' indicates the Branch is ready for deferred statement generation.

*For further details on Referrals refer to the Processing Referrals in Oracle FLEXCUBE chapter of the Core Entities manual.*

**Install**

Select the appropriate value from the drop-down list to indicate whether Oracle FLEXCUBE installation is complete or incomplete.

**Proceed Without Maintaining Floating Rate**

Check this option to indicate that floating rates should be propagated across all branches,

**Sector code**

Specify the Sector Code of your branch, as specified in the Clearing Bank Code Maintenance screen.

**Routing No**

On the basis of the Routing Number Mask defined for your bank, and your specifications in this screen for clearing and sector, Oracle FLEXCUBE automatically generates the Routing Number for clearing transactions involving your branch in the Routing Number field.

**5.1.5.7 Specifying Revaluation/Position Transfer Details**

You can transfer the currency positions from the individual branches to the designated branch during EOD. The system transfers the position from the existing branch to the treasury branch. When the position is negative in the given GL, then the system will choose the Offset account as Position asset GL and when the position is positive in the given GL, then the system will choose the Offset account as Position liability GL. Sequence of the EOD between the designated branch and all other branches are operationally controlled.

You can maintain the following revaluation/position transfer details:

**Transfer Type**

Select the transfer type from the drop-down list. Following are the options available in the drop-down list:

- Position
- Reval

---

**Note**

- If the Transfer Type field is left blank then neither the position transfer nor revaluation transfer to the designated branch will be done.
  - For position transfer, the 'Inter Branch in Local Currency' check box in the Transaction Code maintenance screen, should be checked to avoid creating position due to IB posting.
- 

**Transfer Branch**

The system will identify the branch to which the revaluation/position transfer should be done.

During account/GL revaluation process, the system considers this branch and the GL to pass one leg of the revaluation profit and loss entries. The other leg of the entries will be passed based on the revaluation profit/loss GL and the account branch. The account branch in this case is the 'Revaluation Into' branch maintained as part of branch parameters maintenance.

**Position Asset GL**

Specify the GL to which the notional asset needs to be transferred..

**Position Liability GL**

Specify the GL to which the notional liability needs to be transferred.

**Transaction Code**

Specify the transaction code used to pass the accounting for position transfer.

While saving, the system will validate the difference between negotiated rate input by the user and the base rate maintained against the tolerance limit at the product level. If the difference is not within the tolerance limit, then the system will display an error message.

### 5.1.5.8 **Specifying Suspense Batch Entry Details**

Specify the following details:

**Suspense Entry Required**

Check this box to indicate that automatic suspense entries can be posted for a branch. If a mismatch occurs between real entries or contingent entries during the batch, then the system will post the balancing entries and will continue the EOD without interruption, if you check the 'Suspense Entry Required' option and specify the Suspense Batch Entry details. You can correct those entries manually at later stages.

If you leave this box unchecked and if a mismatch occurs in Real or contingent entries then the EOD is stopped and the error is thrown. You have to correct the entries.

**Suspense Transaction Code**

Specify the transaction code against which the suspense entries are posted or /reversed.

**Suspense Batch Number**

Specify the batch number against which the suspense entries are posted or reversed.

**Reverse Suspense Entry Days**

Specify the days till which the system can sustain the mismatch entries once the batch is run for the same. You can specify a value within a range of 1 to 9999.

If the 'Reverse Suspense Entry Days' is greater than the EOD suspense entry date and if reversal action is not performed for the suspense entry then the EOD is stopped and system displays an error message.

### Maximum Real Suspense Amount

Specify the maximum amount that the system can consider to post suspense entry for an EOD for real entry.

### Maximum Cont Suspense Amount

Specify the maximum amount that the system can consider to post suspense entry for an EOD for contingent entry.

## 5.1.6 Maintaining Duplication Check Details

You can maintain the number of days for which the duplication check should be done for a transaction in 'Duplication Check Details' tab. A transaction is compared with all previous transactions entered during the number of days maintained here, for any possible duplication.

The duplicate check is done starting from booking date till the booking date minus the number of days for duplicate check. This duplication check is carried out based on the combination of the preferences maintained at the FT/SI product respectively.

---

### Note

Duplicate transaction check is applicable only for FT and SI transactions.

---

The screenshot displays the 'Branch Parameters Maintenance' application. The 'Duplication Check Details' tab is active, showing a table with the following columns: 'Module', 'Duplication Check Required', and 'Duplication Days'. The table is currently empty. The interface includes search fields for 'Branch Code \*' and 'Branch Name \*', and a 'Branch Available Status' checkbox. At the bottom, there are fields for 'Maker', 'Checker', 'Date Time', 'Mod No', 'Record Status', and 'Authorization Status', along with an 'EXIT' button.

You can specify the following details here:

### Module

Specify the module for which you wish to maintain duplicate check days or select the module from the option list provided.

### Duplication Check Required

Check this box to indicate that duplication check is required for the transactions related to the module selected.

---

### Note

- However, despite checking this box if the duplication check criteria are not specified in the following screens the system will not perform duplication checks for all the respective contracts under this branch.
- Payments and Collection Product Category Maintenance
- Funds Transfer Product Preference

### Duplication Days

Specify the number of days for which the duplication checks for transactions need to be carried out. Calendar days are considered for duplication check.

---

#### Note

You need to specify a value here if 'Duplicate Check Required' option is selected. You cannot specify a negative value.

---

## 5.1.7 Maintaining SWIFT Address for Branch

Click the 'SWIFT Address' in the Branch Parameters screen to invoke 'Additional SWIFT Address' screen.

The screen appears as shown below:

SWIFT Address *	Description
<input type="text"/>	<input type="text"/>

You can specify the SWIFT addresses related to the branch in this screen.

## 5.1.8 Defining Account Mask

Customer Account Masks can be defined at the Branch Level or at the Bank Level

Click the 'Account Mask' in the Branch Parameters screen to invoke 'Account Parameters' screen.

The screen is as shown below:

The screenshot shows a dialog box titled "Account Parameters" with the following sections and fields:

- Customer Account Mask:** A text input field.
- Checksum Algorithm:** A dropdown menu.
- User Defined Algorithm:**
  - Customer Account: Text input field.
  - Consumer Number: Text input field.
  - Start Account Number: Text input field.
  - End Account Number: Text input field.
  - Auto Generate Account: Check box.
  - Loan Account Auto Generate: Check box.
- Multi Currency Account Input:**
  - Multicurrency Account Mask: Text input field.
  - Multicurrency Checksum Algorithm: Dropdown menu.
  - Multi Currency Account Algorithm: Text input field.
  - Start Multicurrency Account Number: Text input field.
  - End Multicurrency Account Number: Text input field.
  - Auto Generate Multicurrency Account: Check box.
- Auto Account Creation:**
  - Start Account Number: Text input field.
  - End Account Number: Text input field.
- Fund Subscription:**
  - Start Account Number: Text input field.
  - End Account Number: Text input field.

Buttons: Ok, Cancel

### 5.1.8.1 **Specifying Multicurrency Account**

#### **Multicurrency Account Mask**

Specify the multi-currency account mask.

#### **Multicurrency Checksum Algorithm**

Select the checksum algorithm details from the adjoining drop-down list. This list displays the following values:

- Modulo 11
- Modulo 97
- Modulo 11 with weights
- Modulo 10
- User Defined

#### **Multicurrency Account Algorithm**

Specify the multi-currency account algorithm details.

#### **Start Multicurrency Account Number**

Specify the start number for multi-currency accounts.

#### **End Multicurrency Account Number**

Specify the end number for multi-currency accounts.

#### **Auto Generate Multicurrency Account**

Check this box to generate unique multi-currency accounts automatically.



If this box is unchecked, then you need to specify the account number details for each currency while creating an account.

For further details please refer the Section 'Specifying the Account generation Parameters at bank level' under Bank Parameters.

### **Fund Subscription**

You may wish the system to automatically create deposit accounts for customers at the time of fund subscription. These system-created deposit accounts are for use as settlement accounts.

Here, you need to specify the range of numbers available for such auto created accounts by mentioning a start and an end number.

If you wish to retain the facility of auto creation of current accounts at loan initiation, you will have to ensure that the account number mask does not have any user input character.

---

#### **Note**

- The range of numbers specified for the creation of current accounts should not overlap with the range specified for the creation of deposit (or contra deposit) account.
  - Fund account number ranges are enabled only in the fund branch.
- 

### **5.1.9 Maintaining Customer Number Range**

You can specify a number range based on which the customers of your bank will be assigned CIF numbers for identification. Since the number range is maintained at the branch level, you can specify different number ranges for different branches of your bank.

To maintain the number range, click the 'CIF Range' in the Branch Parameters screen. The 'Customer Number Range' screen is displayed:

The screenshot shows a window titled "Branch Parameters CIF Range". It contains three sections for defining number ranges:

- Customer Number:** Start Number [input field] End Number [input field]
- Dummy Customer Number:** Start Number [input field] End Number [input field]
- PID Range:** Start PID Number [input field] End PID Number [input field]

At the bottom right, there are "Ok" and "Exit" buttons.

Specify the following in this screen:

#### **Start Customer No.**

This number is the basis on which the system generates the CIF numbers for customers of your branch.

The CIF number generation is determined by the following details:

- The CIF mask maintained in the Bank-Wide Parameters screen. Assume that the mask is 'bbbnnnnn' (where 'bbb' represents a 3-digit branch code and 'nnnnn' is a 6-digit number).
- The start customer no – assume that this number is 100

While generating CIF numbers, the system will automatically assign the number '00000100' to the first customer of your branch, assuming that the branch code is 000. This conforms to the CIF mask maintained for the bank. The next customer will be '00000101' and so on.

If the option 'Auto Generate CIF Numbers' is checked in the 'Bank Parameter Preferences' screen and the start CIF is zero or null, the new customer number will be generated for the branch as per the current running sequence number of the Head Office.

### **End Customer No**

Just as you specify a Start Customer Number, you have to indicate the End Customer Number also. You will not be allowed to maintain customers beyond this range.

Let us assume that the 'End Customer No.' is 99999. As per the mask and the end number, the last customer CIF number that is generated at your branch will be '000099999'.

### **Start Dummy Customer Number & End Dummy Customer Number**

You should also maintain a dummy customer number range in this screen. When maintaining a dummy range, you should ensure that dummy CIFs and the actual range do not overlap with one another.

The dummy CIF range will be used for account number generation. As explained earlier, the account number can be generated based on the following account mask:

**'bbbTZCCCCCSd'**

Where,

- bbb – is the branch code
- T – indicates the account code
- Z – is the currency type
- CCCCCC – is the CIF number of the customer
- S – is the sequence number for a combination of account code, currency type and customer
- d – is the control number generated by 'Modulo 11 with Weights' algorithm (explained earlier)

To recall, the sequence number that is automatically generated by the system is for an account code + currency type + customer combination. The sequence number is a single digit number (from 1 to 9). This means that, for the same combination, you will be allowed to maintain only nine accounts. To eliminate this limitation and to allow maintenance of more than nine accounts for the same combination, the dummy customer number range will be utilized. This is explained with the help of an example.

For example, Assume that you have maintained the following CIF range for your branch:

<b>Start CIF No.</b>	<b>100000</b>
End CIF No.	198999
Start Dummy No.	199000

End Dummy No.	199999
---------------	--------

Ms. Jennifer approaches your bank to open a savings account in your branch (branch code is '000'). Further, the CIF and account number masks maintained for the branch are 'bbbnnnnnn' and 'bbbTZCCCCCSd' respectively.

As per the CIF mask, Ms. Jennifer is assigned the CIF number: 000123456. According to the account number mask, the 6<sup>th</sup> to 12<sup>th</sup> digits will be the last six digits of the CIF number, which is '123456'.

The account number of the first savings account, in USD opened for Ms. Jennifer is: 000411234561 (we will consider only 12-digits for this example since the 13<sup>th</sup> digit is auto generated by the system based on Modulo 11 with Weights algorithm).

The components of the account number **000-4-1-123456-1** are as follows:

- 000 – is the branch code
- 4 – is the account code
- 1 – is the currency type
- 123456 – is the CIF number for Ms. Jennifer
- 1 – is the sequence number for the combination of account code, currency type and customer i.e. the number '4-1-123456' will be common for the first 9 accounts maintained for the same combination.

Now, Jennifer decides to open another account for the same combination. In this case, the sequence number gets incremented to 2 and the account will be assigned the number: **000-4-1-123456-2**.

This will go on till the 9<sup>th</sup> account for the same combination. The 9<sup>th</sup> account number would be **000-4-1-123456-9**.

If the customer decides to maintain the 10<sup>th</sup> account for the same combination, the sequence number will restart since it has reached the maximum allowed level. This would result in duplication of account numbers. To eliminate this, the system will now use the dummy CIF range to number the accounts.

Therefore, the 10<sup>th</sup> account number will be: **000-4-1-199000-1**. This sequence will continue for subsequent accounts maintained for the same combination.

---

#### Note

You can view all the dummy CIF numbers linked to a customer in the 'Customer Accounts – Allocated Dummy CIF' screen.

---

### **PID Range**

#### **Start PID Number**

Specify the initial characters of the PID number. You can enter a maximum of 11 or 10 numeric characters when modulo 11 or module 97 is selected respectively. The same can be entered only once, and cannot be modified subsequently.

#### **End PID Number**

Specify the last characters of the PID number. You can enter a maximum of 11 or 10 numeric characters when modulo 11 or module 97 is selected respectively.

## 5.1.10 Maintaining Global Interdict Functions

Click 'GI Functions' button in the Branch Parameters Maintenance screen to invoke 'Branch Global Interdict Functions' screen. Using this screen, you can integrate with Global Interdict System for online verification of transactions before authorisation in order to comply with 'Office of Foreign Assets Control' (OFAC) regulations in US.

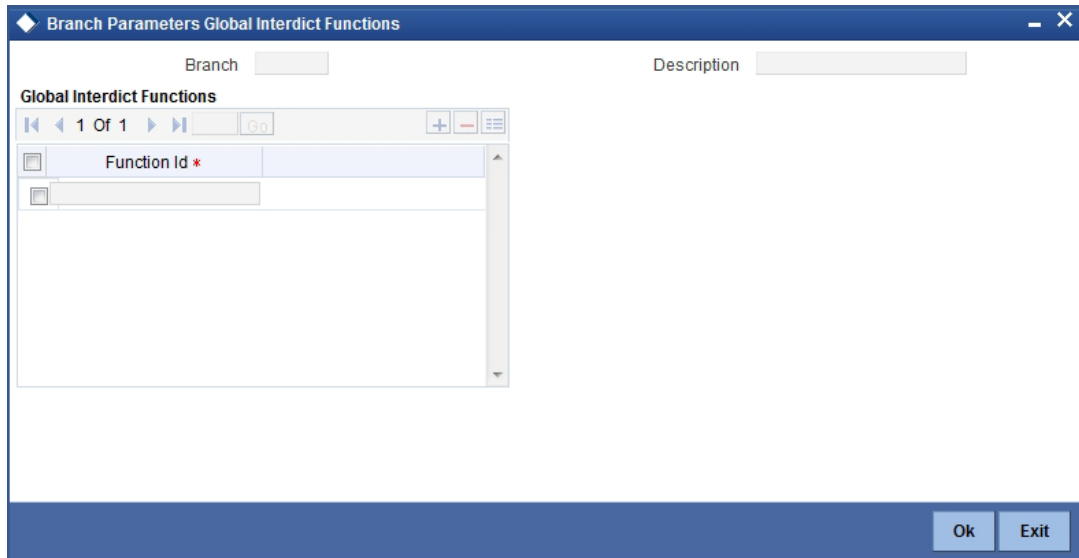

## 5.1.11 Maintaining Preferences

To specify your preferences, click 'Preferences' button from the 'Branch-Wide Parameters' screen. The 'Preferences' screen is displayed.

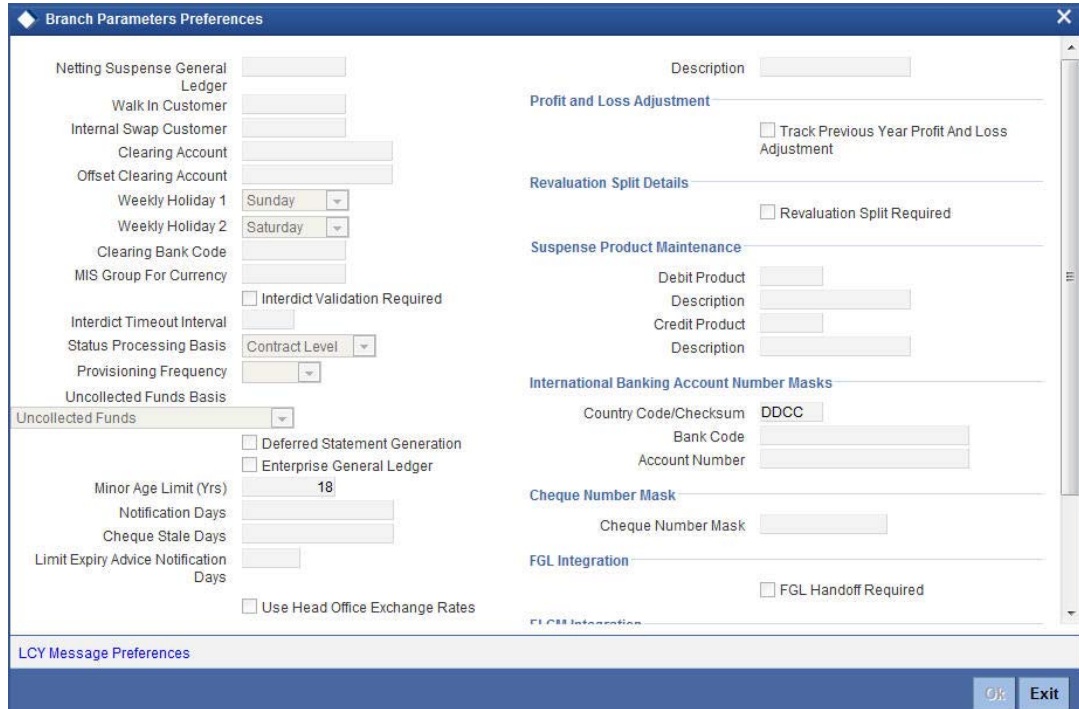

In this screen you define the following preferences:

- The netting suspense GL into which settlement entries for netted FX Contracts should be posted
- The CIF Number against which all Walk in customers should be identified

- The format in which the IBAN Account Number and the Bank Code should be captured
- The duration for which spool files should be stored in the spool file directory
- The directory into which the files should be spooled
- MIS codes for posting of automatic balancing entries

These details can be maintained by the respective branches. For a branch you maintain the following, in the 'Preferences' screen:

### **Netting Suspense GL**

All settlement accounting entries relating to a netted FX contract, is passed into the specified 'Netting suspense GL'. The net amount of the settlement is transferred through the Nostro accounts. For instance, let us take the following two outstanding contracts entered into by bank A; both settling on January 10, 1998:

- Bought from bank B 1 Million USD in exchange for 35 Million INR
- Sold to bank B 1/2 million USD in exchange for 18 million INR

The above contracts can be settled in either of the two ways given below, on the settlement date:

- Settle both contracts separately
- Net the settlements of the two contracts

If your bank has a netting agreement with the counterparty, the settlement entries are posted to this 'Netting suspense GL' and the net amounts are settled through the nostros.

### **Walk in Customer**

For your branch you can create a walk in customer ID against which you track all those customers who do not hold a regular account with your bank but have approached the bank for a transaction, say, for encashment of traveler's checks or for manager's checks.

### **Internal Swap Customer**

You need to specify an internal swap customer for processing internal swaps. The names of all the customers of your bank will be displayed in the option-list provided. This will be a unique customer meant for processing internal swaps.

### **Clearing Account**

Specify the default GL account to be used for clearing transactions at the branch.

### **Offset Clearing Account**

Specify the default offset GL account to be used for clearing transactions at the branch.

### **Weekly Holiday 1 & 2**

Using this option you can indicate the holiday in a week for your branch. You can select the day for holiday from dropdown list. If you want to set only one holiday in a week for your branch, select the day for Weekly Holiday 1 and leave Weekly Holiday 2 Blank. If you want to opt for two holidays in a week, select the days for Weekly Holiday 1 & Weekly Holiday 2.

### **Clearing Bank Code**

Specify the code by which your bank is identified in the Clearing Network you participate in. This has to be the same as that specified for your bank in the Clearing Bank Code Maintenance screen.

### **MIS Group for Currency (Mismatch Entries)**

If the posting of automatic balancing entries due to currency and value date mismatches has been specified for your bank, you can specify the MIS codes or groups to be used for posting the balancing entries.

### **Interdict Validation Required**

For your branch you need to indicate whether Interdict Validation is required for all Customers, Customer Accounts, Funds Transfers, Standing Instructions, Foreign Exchange, Letter of Credit and DD transaction processed within your branch.

The options available are:

- Yes – the details of CIFs and Customer Accounts, captured in the specific branch of your bank will be sent to the GI system as and when they are captured in Oracle FLEXCUBE.
- No – the details maintained in the specific branch will not be sent to the GI system for online verification.

### **Interdict Timeout Interval**

If you indicate that the details should be sent to the GI system, you will also have to specify the interdict timeout interval period. If the response time from the GI system takes longer than the time that you specify in this field, the transaction will be timed out since the processing time exceeds the time stipulated in this field.

If you enable this preference, you will have to identify the Code or ID of the function in Oracle FLEXCUBE for which such a validation should be performed by clicking on the 'GI' button in the Branch Parameters screen.

### **Status Processing Basis**

In the Branch Parameters, you can indicate the basis upon which status processing must be done at the branch, for customer accounts as well as loan contracts.

Status processing can be done either at an individual contract / account level, or at a Group / CIF level.

If you opt for Group / CIF -level processing, it is done in two stages:

- The worst status among all contracts and accounts under a specific customer group or CIF is arrived at
- All accounts and contracts involving the customer group or CIF are then moved to the worst status that was arrived at

If you opt for status processing at individual contract / account level, the status of each contract or account would be assigned according to the status processing parameters that are operative for the contract or account.

If 'Status Processing' is at Individual Contract Level, then you can change the status and trigger the status change event along with accounting entry posting. However if the 'Status Processing' is at CIF/Group level individual module (LC, CI, MO, CA, IA and BC) batches will be updating common storage with the derived status of each contract and CIF/Group level status will be triggered by the common status change batch. The common status change batch will call the individual module function for status change processing.

*For details about loan status processing and provisioning, consult the Loans user manual and the Core Entities user manual.*

### **Provisioning Frequency**

Provision processing depends upon status processing for accounts and contracts. The provisioning batch process executes after the status processing batch. If status processing is indicated to be processed at group / CIF level, you can indicate the frequency at which the provisioning batch is to be executed for your branch. The frequency options available are daily and monthly.

*For details about loan status processing and provisioning, consult the Loans user manual and the Core Entities user manual.*

### **(Withdrawable) Uncollected Funds Basis**

You can define how the System enforces the allowable amount of uncollected funds (on an account) that can be withdrawn within a business day.

For each customer account, you designate a limit on the amount of uncollected funds that can be withdrawn (the Uncollected Funds Limit). You can also indicate whether, for a given business day, the System should consider the uncollected funds that are allowed to be withdrawn as:

- The funds scheduled to be released on the current date (today), OR,
- The total uncollected funds available against the account subject to the Uncollected Funds Limit

You can specify your preference by choosing any of the following options:

- **Uncollected Funds** : If you select this option, an amount up to or less than the uncollected funds limit defined for the account, is allowed to be withdrawn, on a given business day.
- **Uncollected Funds Available Same Day**: If you select this option, the funds allowed to be withdrawn against uncollected funds on a given business day are the funds scheduled to be released on the current date (today).

### **Deferred Statement Generation**

Check this option to stop the automatic account statement generation at end of day.

If this option is checked, then the account statement generation will be deferred to whenever you initiate action for executing Batch Operations for statement generation. You can do this through the Branch Statement Status Change screen.

### **Enterprise GL**

Check this option if this branch needs to have an enterprise GL hand-off. Once checked the system will identify the said branch for creating an ASCII hand-off file containing the relevant accounting entries to be sent to the external enterprise GL.

### **Minor Age Limit (Yrs)**

Specify the minor age limit. This varies from nation to nation. However If user does not maintain the age limit, the system will automatically defaults it as 18 years during save.

### **Junior NISA Age Limit**

Specify the junior NISA age limit. You can provide maximum age limit for the NISA customer. You can enter only two numeric values. Based on the age limit maintained here, the system performs age limit validation at the customer level for the Junior NISA CIF.

### **Notification Days**

Specify the intimation days to send advice prior to the customer turns major based on DOB.

### **Cheque Stale Days**

Specify the cheque stale days. Here you can identify the number of days for which stale validation is done.

### **Limit Expiry Advice Notification Days**

Specify the limit expiry advice notification days. The system will send advice to the customer these many days before the limit expiry date.

The limit expiry advice generated by the system provides information on the limit details. Multiple lines can be attached to a customer with different expiry dates. Advice sent to the customer contains the details of the line which is about to expire.

#### **Use Head Office Exchange Rates**

Exchange rates are maintained for a currency pair and are used to calculate the equivalent of one currency against the other. These exchange rates can be maintained in each branch or at the Head office. You can indicate your preference.

If you check 'Use Head Office Exchange Rates' field, the exchange rates maintained at the Head Office will be made applicable to the respective branches of the bank.

If this field is not checked then the exchange rates should be maintained at the respective branch.

### **5.1.11.1 Specifying Back-Valued Details**

For your branch you can specify the maximum period up to which back valued posting can be processed. This restriction can be made applicable by specifying the following preferences:

#### **Back Value Check Required**

It is used to indicate whether all back-valued transactions should be validated against a specific period.

#### **Back Value Days**

If you enable the Back Value Check Required option, you must indicate the number of calendar days up to which back-valued transactions can be allowed. During transaction processing you will be allowed to post back-valued transactions up to the specified date in the past (no check will be done). Further, if the option is checked but you have not maintained the 'Back Value Days' (maintained as NULL), the system will interpret it to be 'Zero' days allowed (for back valued transactions).

The restriction for the maximum period up to which back-valued posting can be allowed, will be made on transactions processed in following modules:

- Payment and collections
- Data Entry
- Retail Teller
- Utility Payments
- Foreign Exchange
- Money Market
- Expense Processing
- Fund Transfer
- Loans and Deposits

While saving transactions pertaining to any of these modules the System validates the Value Date of the contract to check whether it adheres to the restriction. You will be intimated with an override if the Value Date is earlier than the specified period. This restriction is made applicable on all uploads as well.



*Refer the Contract Processing chapter of the individual modules for additional information.*

### **5.1.11.2 Indicating Profit and Loss Adjustment**

#### **Track Previous Year Profit and Loss Adjustment**

You can collect data pertaining to the unrealized income booked for each contract during the year by triggering the Year-end batch process. But, you will be allowed to trigger the batch process for splitting the unrealized profit and loss for the previous year and the current year only if you have specified this (Track PY PnL Adjustment) as a preferred option for your branch.

If you set this preference, the data pertaining to the unrealized income is collected at contract level for the following modules:

- Securities - Unrealized Interest, Discount and Premium accrued for the year.
- Derivatives - unrealized income
- Bills and Collections - unrealized income
- Letters of Credit - unrealized income
- Money Markets - unrealized income

### **5.1.11.3 Indicating Revaluation Split Details**

#### **Revaluation Split Required**

You can choose to break-up revaluation profit/loss into:

- Trading P&L – P&L due to revaluation of foreign currency transactions during the day
- Revaluation P&L – P&L due to revaluation of opening balances (balances without current day's turnover)

If you enable this preference, all GLs which are marked for revaluation split will have their revaluation profit/loss broken up into trading and revaluation P & L for entries posted from this branch.

*For further details on Split Revaluation refer the GL user manual.*

### **5.1.11.4 Specifying Suspense Product Maintenance**

When a branch goes offline, user posts the transactions allowed in offline mode. Once the branch and host are online, branch starts posting these transactions as force post. If the force post fails, then the host needs to post these transactions as a suspense product in the branch.

#### **Debit Product**

Specify a valid debit product you need to maintain as Suspense Product. The adjoining option list displays all the valid debit products maintained in the system. You can select the appropriate one.

#### **Description**

The system displays the description based on the selected debit product

#### **Credit Product**

Specify a valid credit product you need to maintain as Suspense Product. The adjoining option list displays all the valid credit products maintained in the system. You can select the appropriate one.

#### **Description**

The system displays the description based on the selected credit product.

### 5.1.11.5 Specifying International Banking Account Number MASKS

The IBAN or International Bank Account Number is a unique account number that is used to identify a customer's account in a financial institution internationally.

International Bank Account Numbers in your bank are generated in the format of the account mask that you specify in the Branch Parameters screen. Therefore, you have to first define IBAN masks.

#### **The IBAN Mask**

Since IBANs should be maintained in a particular format you should first define the format in which the IBAN should be captured. You should also indicate the format in which the bank code of the bank in which the account resides should be maintained.

The maximum length of an IBAN should be 34 characters. The IBANK Mask should be a combination of the following parameters:

- An **ISO Country Code**, which has a maximum length of two characters. The identifier that you can use to indicate the country code is DD. The identifier will be replaced by the actual country code while defining the account number. For instance, you will replace DD with PL for Poland, US for the United States and so on.
- A **Check Digit Number** calculated according to an ISO Standard algorithm, using the Country Code, Bank Code and Account Number combination. Since this is a two-digit number you can use the identifier CC to specify this algorithm. The system arrives at and replaces this identifier with the actual check-digit based on the Country Code, Bank Code and Account Number combination.
- The **Bank Code** of the bank where the IBAN resides. This code is assigned to the respective Bank by its national bank. There are no individual restrictions on the length of Bank Code and Account Number. However, the combined length of the Bank Code and Account Number should not exceed 30 characters. You can use the identifiers **a** (for alphabets) and **n** (for numerals) as the identifiers to capture the length of the bank code.
- The **Account Number** of the customer account. The bank in which the customer account resides assigns this number. You can use the identifiers **a** (for alphabets) and **n** (for numerals) as the identifiers to capture the length of the account number.

For example, you maintain an IBAN mask in the following format:

**DDCCaaaaaaaannnnnnnaaaaaannnnnnnn**

While capturing the IAB number you have to strictly adhere to the format mentioned above.

**USccCHASEBANK000101CBNYLI450000026**

In place of the 'cc's the system will generate the check digit algorithm based on the Country Code, Bank Code and Account Number combination.

#### **The Bank Code Mask**

After indicating the IBAN mask you have to specify the mask for the Bank Code. The Bank Code mask is a combination of alphabets and numerals. Therefore you can specify **A** and **N** as the identifiers. Subsequently, while capturing the bank code in the IBAN screen each of these characters will be replaced with the respective alphabet or numeral. For instance, let us assume that you have maintained a 15-character mask for the Bank Code:

A	A	A	A	A	A	A	A	A	N	N	N	N	N	N
---	---	---	---	---	---	---	---	---	---	---	---	---	---	---

You will have to capture the corresponding bank code in the same format:

C	H	A	S	E	B	A	N	K	0	0	0	1	0	1
---	---	---	---	---	---	---	---	---	---	---	---	---	---	---

---

**Note**

The combined length of the Bank Code and Account Number should not exceed 30 characters.

---

### 5.1.11.6 Indicating Cheque Number Mask

#### **Cheque Number Mask**

The system displays the cheque number mask maintained at bank parameter level.

The 'Cheque Number Mask' defined at branch parameter level cannot be changed once maintained and authorized.

If the cheque book is issued to non base branch accounts, the system populates or validates the cheque numbers based on the cheque mask of the account branch.

### 5.1.11.7 Indicating ELCM Integration

Check this box to indicate that the branch details will be replicated to ELCM system. System will select this option by default, but you can unselect it.



System will not allow unselecting this option once it is selected.

#### **LDAP DN Template**

The LDAP DN template needs to be maintained here for each branch. This is used in Oracle FLEXCUBE user maintenance form to populate corresponding LDAP user-id automatically from the template.

### 5.1.12 Maintaining LCY Message Preference for Branch

Click the 'LCY Msg Pref' button in the Preferences screen to invoke the 'LCY Message Preference' screen.

The screen is as shown below:

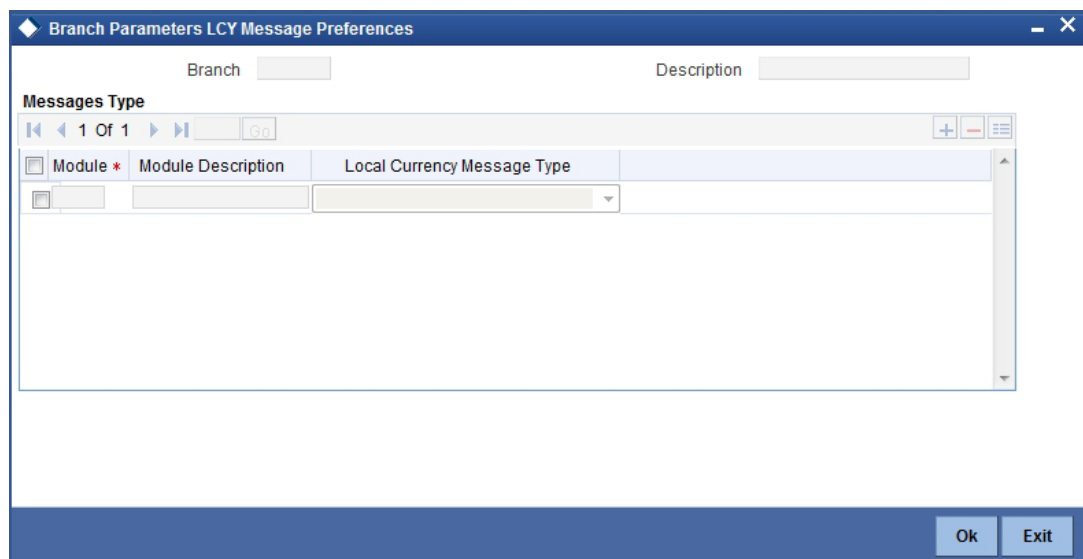

**Branch**

The system displays the branch details.

**Description**

The system displays the description.

**Module**

Specify the module details.

**Module Description**

Specify the description of the module.

**Local Currency Message Type**

Select the local currency message type from the drop-down list. Following are the options available in the drop-down list:

- Suppress LCY
- Generate LCY Message Thru SWIFT
- Generate PC Contract

### 5.1.13 Specifying UDF Details

You can associate values to all the User Defined fields created and attached to the Branch Parameters Screen. You can view the list of User Defined fields associated by clicking the 'Fields' button.

The screen appears as shown below:

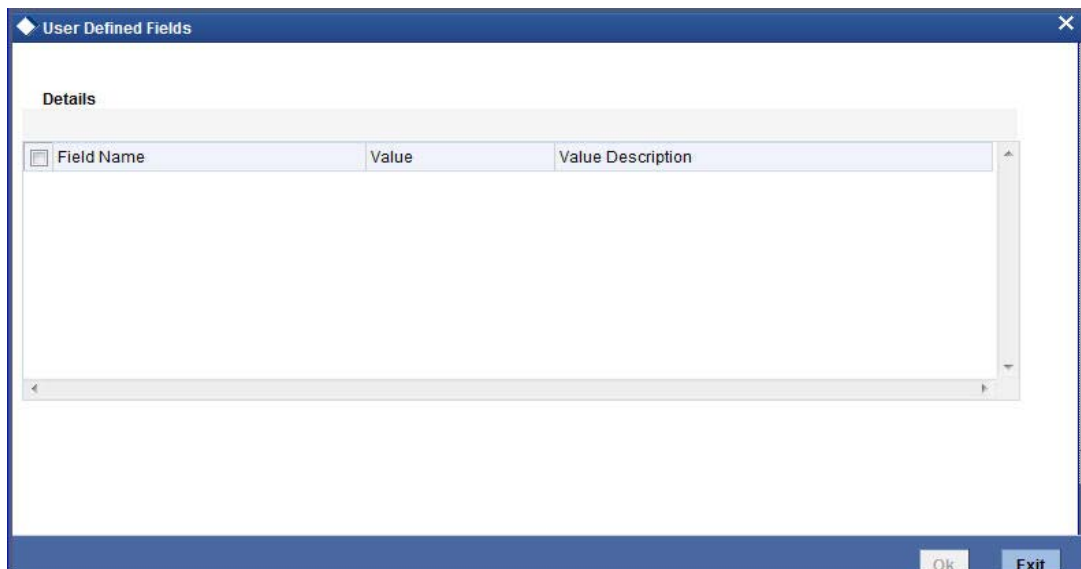

You can enter the value for the UDFs listed here in the 'Value' column.

### 5.1.14 Maintaining Address Codes Details

You can maintain the address code details in the 'Address Code Maintenance' screen. This facility helps to store and retrieve address details based on the address code maintained.

The address codes maintained in this screen can be retrieved in the following customer account creation or maintenance screens:

- Customer Maintenance (STDCIF)

- Customer Summary (STSCIF)
- Quick Customer Addition (STDCIFAD)
- Quick Customer Addition Summary (STSCIFAD)
- 360 Degree Corporate Customer View (STDCUSVW)
- 360 Degree Retail Customer View (STDRETVW)
- Customer Party Summary (STSCUSSH)
- Customer Details in the Customer Tab (Homepage)
- Customer Accounts Maintenance (STDCUSAC)
- Deposit Account Booking (STDCUSTD)
- Customer Address Maintenance (MSDCUSAD)
- Account Address Maintenance (MSDCACAD)
- Quick Customer Account Input (STDCASAC)
- Central bank blacklist status (STDNCBQY)
- Lead Maintenance (STDLEDMT)

You can invoke this screen by typing 'STDADMNT' in the field at the top right corner of the Application tool bar and clicking the adjoining arrow button.

The screen appears as shown below:

The screenshot shows the 'Address Code Maintenance' application window. The window title is 'Address Code Maintenance'. The interface includes a top toolbar with 'New' and 'Enter Query' buttons. Below the toolbar is a search area with an 'Address Code \*' text box and a 'Mark For Expiry' checkbox. A status bar shows '1 Of 1'. The main area contains several input fields: 'Script Code \*', 'Address 1', 'Address 2', 'Address 3', 'Prefecture', and 'Pincode'. At the bottom, there is a footer with fields for 'Maker/Checker', 'Date Time', 'Mod No', 'Record Status/Authorization Status', and an 'Exit' button.

Specify the following details:

### **Address Code**

Specify the address code which will uniquely define the address and PIN code. During the closure of an address code, the system will validate whether the address code is not used for address maintenance for any other customer. If this address is maintained for another customer, then an appropriate error message with the customer details are displayed.

If an address code is modified, then using the batch STBADMNT the modified record is applied across all customers and accounts mapped to this address code.

### **Mark For Expiry**

Select the check box to maintain the address code details for a scheduled period.

### **Script Code**

Specify the script code. Alternatively you can select the script code from the option list. The list displays all the valid script codes maintained in the system.

### **Address 1-3**

Specify the address details of the customer from fields Address 1 to Address 3.

---

#### **Note**

If there is a character validation defined for the address fields in 'Script Maintenance for Language' screen (i.e. 'Validate Characters' option checked in 'STDSCRPT' screen) then the system validates for allowed characters defined for that particular script entered in 'Address 1', 'Address 2' and 'Address 3' fields.

---

### **Prefecture**

Specify the prefecture associated with the address specified.

### **PIN Code**

Specify the PIN code.

The batch STBADMNT will not save the modified 'Address Code' record in 'Address Code Maintenance' screen (STDADMNT). This batch is run as a part of End of Transaction Input Process (EOTI) at the end of the day (EOD). Also, modified 'Address Code' gets reflected for all the below mentioned screens as a part of STBADMNT batch:

- Address Code Maintenance (STDADMNT)
- Address Code Summary (STSADMNT)
- Customer Maintenance (STDCIF)
- Customer Summary (STSCIF)
- Quick Customer Addition (STDCIFAD)
- Quick Customer Addition Summary (STSCIFAD)
- 360 Degree Corporate Customer View (STDCUSVW)
- 360 Degree Retail Customer View (STDRETVW)
- Customer Party Summary (STSCUSSH)
- Customer Accounts Maintenance (STDCUSAC)
- Quick Customer Account Input (STDCASAC)
- Deposit Account Booking (STDCUSTD)
- Customer Address Maintenance (MSDCUSAD)
- Account Address Maintenance (MSDCACAD)
- Central Bank Blacklist Status (STDNCBQY)

- Lead Maintenance (STDLEDMT)

Address code and its details gets fetched and displayed in customer tab.

### **5.1.14.1 Address Code Upload**

Address codes are also maintained by using 9 byte or 11 byte format uploads in Generic Interface.

#### **11 byte Address Code Upload**

##### **New Address Code Addition**

If an address code that is present in the file is not available in the system, then it is identified as a new record. These records are added in the system and auto authorized ( configured at GIDPARAM) and would be available at address code maintenance screen (STDADMNT).

##### **Address Code Modification**

System checks the 'Address Code' and 'New Address Code' fields. In case if both are different then those records can be considered as address code changed records. The modified record including 'New Address Code' value will be updated in the system and the mapped fields at address code maintenance (STDADMNT) level would be updated accordingly. The modified values are also updated at account level.

##### **Address Code Deletion**

Address files which are not available as part of the uploaded file are identified as deleted files.

- System marks the address code as closed if no customer or accounts are linked to the address code.

System does not closed mark the address code as closed if it is linked to customers or accounts. In this case, deletion is handled procedurally by bank. The system displays an error code, 'Address code for closure is linked to customer/accounts. Hence address code could not be closed'

#### **9 byte Address Code Upload**

##### **Data Type = 981/986**

Data type 981 and 986 are treated as new data entry. System adds the records and these will be available at address code maintenance screen(STDADMNT).In case a record for the address code already exists in the system, a error message will be displayed.

##### **Date Type = 982**

Data type 982 refers to modified address codes. System updates the changes to the attributes of a address code record and reflects the same in address code maintenance screen, customer and account screens.

##### **Data Type = 983**

Data type 983 refers to deleted entries. The sytem does the following:

- Mark the address code as closed if no customer or accounts are linked to it.
- Displays an error if the address code is linked to a customer or account.
- Displays an error if the address code does not exist in the system.

##### **Data Type = 984**

Data type 984 are marked for expiry. These address codes are set for expiry after a scheduled period. These address codes are automatically checked for 'Mark for Expiry' in the address code maintenance screen.

### Data Type = 985

Data type 985 are address codes marked as expired. System marks these address codes as closed if they are not linked to any customer or accounts.

System displays an error if the address code is linked to a customer or account and cannot be closed.

## 5.1.15 Address Code Summary

You can view the summary of the address code maintained in the 'Address Code Summary' screen. You can invoke this screen by typing 'STSADMNT' in the field at the top right corner of the Application tool bar and clicking the adjoining arrow button.

The screen appears as shown below:

Authorization Status	Record Status	Address Code

Specify the following details:

- Authorization Status
- Record Status
- Address Code

System displays the following:

- Authorization Status
- Record Status
- Address Code

*For more details on how to create user Defined fields, refer chapter 'Creating custom fields in Oracle FLEXCUBE' in the User Defined Fields User Manual under Modularity.*

## 5.2 Maintaining Tax Cycle

You can maintain tax cycle at the bank level through the 'Tax Cycle Maintenance' screen. Invoke this screen by typing 'STDTCYCL' in the field at the top right corner of the Application tool bar and clicking the adjoining arrow button.



The screen is as shown below:

Fields		
Input By Date Time	Authorized By Date Time	Modification Number <input type="checkbox"/> Authorized <input type="checkbox"/> Open

### **Tax Cycle**

You need to define the tax cycle, which will be uniquely identified in the system

### **Start and End dates for tax cycle**

You need to indicate the start and end date of the tax cycle you are defining, using the adjoining calendar.

## **5.2.1 Updating Tax Cycle**

The Current Tax Cycle would be updated as and when the tax cycle changes. This would be done during authorization of date change function on the first day of the new Tax Cycle.

## **5.2.2 Maintaining Tax**

To maintain Tax parameters at the branch level, click the 'Tax' button in the Branch Parameters Details screen.

The screen appears as shown below:

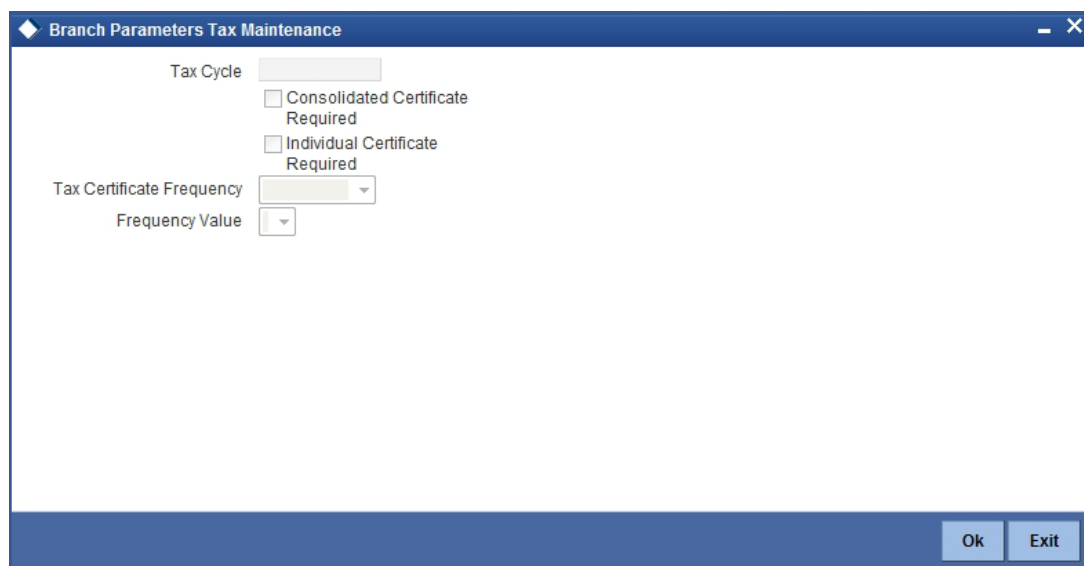

### **Tax Cycle**

This is the current tax cycle for the branch. This is a display field. Whenever the tax cycle changes, the field is updated during the date change authorization for that day.

### **Consolidated Tax Certificate Required**

Check this option to indicate Consolidated Tax Certificate is required for all the transactions done in the Tax Cycle. This option works in conjunction with a similar option in the Customer Information Maintenance and the Tax Category Maintenance screen.

The Consolidated Tax Certificate would be generated at the frequency specified at the branch level. Apart from this, the certificate would also be generated at the end of the Tax Cycle. The consolidated tax certificate would always display all the transactions pertaining to the current Tax Cycle.

### **Individual Tax Certificate Required**

Check this option to indicate Individual Tax Certificate is required for individual transactions under the selected tax category. This option works in conjunction with a similar option in the Customer Information Maintenance and the Tax Category Maintenance screen.

### **Tax Certificate Frequency**

This field is enabled only if the Consolidated Tax Certificate option is checked.

You need to specify the frequency with which the tax certificate should be generated. This would be a combination of the Tax Certificate Frequency and the Tax Certificate Day. It could be any of the following:

- Monthly - This indicates that the tax certificate would be generated every month. The day of the month on which the Tax Certificate would be generated is defined in the Tax Certificate Day field.
- Quarterly (Q) – This indicates that the tax certificate is generated once in three months. The end-month for the first quarter is defined in the Tax Certificate Day field. The Certificate would be generated on the last working day of the month defined in the Tax Certificate Day field. Subsequent end-months would be derived by the system.
- Half Yearly (H) – This indicates that the Tax Certificate would be generated once in six months. The end-month for the first half-year period is defined in the Tax Certificate Day field. The Certificate would be generated on the last working day of the month defined in the Tax Certificate day field. Subsequent end-months would be derived by the system.

- Yearly (Y) – This indicates that the tax certificate would be generated once a year. The month in which the certificate needs to be generated is defined in the Tax Certificate Day field. The Certificate would be generated on the last working day of the month defined in the Tax Certificate Day field.

### Frequency Value

Select the appropriate month for tax certificate generation, from the adjoining drop-down list.

## 5.2.3 Maintaining Clearing Currencies

You can maintain a list of currencies in which clearing transactions can be processed under a branch. In order to achieve this, you need to invoke the 'Clearing Currency' screen by clicking the 'Branch Currency' button in the 'Branch Parameters – Detail View' screen.

Here you can capture the following details:

### Branch Code

The branch code gets defaulted from the 'Branch Parameters – Detail View' screen. A brief description of the branch is displayed alongside.

### Currency Code

Specify the currency in which you wish to allow clearing transactions under this branch. You can specify multiple currencies for a branch. Click on the adjoining option list and select the appropriate code from the list of currencies maintained in the system.

### Currency Description

A description of the chosen currency code is displayed here

## 5.2.4 Account Statement Handoff

The account statement handoff will consider the movements on accounts based on the Statement Date and not the Transaction Date. The Statement Status Change will itself run the Account Statement handoff for the previous working date before marking the Branch Statement Status as ready.

## 5.2.5 Account Statement Generation

Accounting entries with Statement Date lying between From Date and To Date populated in the handoff records will be picked up for Account Statement Generation processing.

## 5.3 Maintaining Role to Head Mapping at Branch Level

You can maintain different General Ledgers for different branches for the accounting roles defined in the system. If you have maintained Role to Head mapping for a product at the branch level, the system uses these accounting heads instead of the heads maintained at the product level.

You can maintain Role to Head mapping for a combination of branch, product and status in 'Branch Level Role to Head Mapping' screen. You can invoke this screen by typing 'CSDACRHM' in the field at the top right corner of the Application tool bar and clicking the adjoining arrow button.

The screenshot shows the 'Branch Level Role to Head' application window. The window title is 'Branch Level Role to Head'. It features a 'New' button and an 'Enter Query' button. Below these are input fields for 'Branch \*', 'Branch Name', 'Product Code \*', 'Product Description', and 'Status \*'. A section titled 'Role To Head Mapping Details' contains a table with two columns: 'Accounting Role \*' and 'Accounting Head \*'. The table currently shows one row with empty fields. At the bottom, there is a 'Fields' section with labels for 'Maker', 'Checker', 'Mod No', 'Date Time:', 'Record Status', and 'Authorization Status'. An 'Exit' button is located in the bottom right corner.

You can specify the following details in this screen:

### **Branch Code**

The branch code of the current branch gets defaulted here.

### **Branch Name**

The name of the current branch corresponding to the branch code gets displayed here.

### **Product Code**

Specify the product code for which you wish to maintain role to head mapping or select the product code from the option list provided.

### **Status**

Specify the status code for which you wish to maintain role to head mapping or select the status code from the option list provided.

### **Accounting Role**

Select the accounting role to be used for role to head mapping, from the option list provided.

### **Accounting Head**

Select the GL accounting head to be used for role to head mapping, from the option list provided.

You can add more rows to accounting role and heads by clicking the 'plus' icon provided. You can also delete a row from this table by selecting the required row and clicking the 'minus' icon.

---

**Note**

The accounting roles and heads maintained here will override the default role head mapping maintained for the product.

---

### 5.3.1 Viewing Accounting Role to Head Mapping Details

You can view the details related to accounting roles and heads for a branch in 'Branch Level Role to Head Mapping Summary' screen. You can invoke this screen by typing 'CSSACRHM' in the field at the top right corner of the Application tool bar and clicking the adjoining arrow button.

The screenshot displays the 'Branch level Role To Head Mapping Summary' application window. The window title is 'Branch level Role To Head Mapping Summary'. The interface includes a search bar with options for 'Search', 'Advanced Search', 'Reset', and 'Clear All'. Below the search bar, there are input fields for 'Case Sensitive', 'Authorization Status', 'Record Status', 'Branch', and 'Product Code'. A table below these fields shows a list of records with columns for 'Authorization Status', 'Record Status', 'Branch', 'Product Code', and 'Status'. The table is currently empty. At the bottom right of the window, there is an 'Exit' button.

The following details get displayed in this screen:

- Authorization status
- Record status
- Branch code
- Product code
- Status

---

## 6. Account Branch Transfer

### 6.1 Introduction

You may get request from the customers for change of account branch. Oracle FLEXCUBE allows you to transfer a customer account from one branch of the bank to another. You can also transfer the all accounts that belong to an account class to a different branch at once. This chapter explains the required maintenances and the methods to process account branch transfer.

### 6.2 Maintaining Branch Transfer Parameters

In order to facilitate this, you need to maintain the branch transfer parameters using 'Branch Transfer Parameters Maintenance' screen. To invoke this screen, type 'CSDACTRP' in the field at the top right corner of the Application toolbar and click the adjoining arrow button.

Branch Transfer Parameter Maintenance Screen

New Enter Query

Branch Code \*

Transaction Code \*

Transfer Bridge GL \*

Process Mode

No of Parallel Jobs

Commitment Frequency

Fields

Maker Date Time:

Checker Date Time:

Mod No Record Status

Authorization Status

Exit

Specify the following details:

#### Transaction Code

Specify a unique transaction code. The system will use this transaction code to post the accounting entries while processing the account balance transfer from one branch to another.

---

#### Note

Ensure that the options 'Account Activity', 'Cheque Mandatory', 'IC Transaction Count', 'IC Turnover Inclusion' and 'IC Penalty' are not checked on 'Transaction Code Maintenance' screen.

---

#### Transfer Bridge GL

Specify the bridge GL to be used while moving the account balance from one branch to another.

### Process Mode

Specify the mode of processing the account transfer. The drop-down list displays the following options:

- | Sequential – If you choose this, the system will process the transfer in a sequential order
- | Job – If you choose this, the system will process the transfer as job

Choose the appropriate one.

### Number of Parallel Jobs

Specify the number of parallel jobs. This is the maximum number of jobs that may be submitted for processing at the same time.

### Commitment Frequency

Specify the commitment frequency. While processing the transfer batch, the system will perform commits based on the frequency set here.

## 6.3 Transferring Customer Account Branch

Using Oracle FLEXCUBE, you can transfer a customer account from one branch of the bank to another. The account branch transfer is processed using 'Account Transfer' screen. To invoke this screen, type 'CSDACCTR' in the field at the top right corner of the Application tool bar and click the adjoining arrow button.

The screenshot shows the 'Bank Transfer' application window. The title bar reads 'Bank Transfer'. Below the title bar, there are two buttons: 'New' and 'Enter Query'. The main area contains several input fields with asterisks indicating they are required: 'Transfer ID \*', 'Current Branch \*', 'Current Branch Name', 'Transfer Date \*', 'Target Branch \*', and 'Target Branch Name'. Below these fields is a table with the following columns: 'Account Number', 'Account Description', 'Customer Number', and 'Customer Name'. The table is currently empty. At the bottom of the window, there is a 'Fields' section with labels for 'Maker', 'Checker', 'Mod No', 'Date Time:', 'Date Time:', 'Record Status', and 'Authorization Status'. An 'Exit' button is located in the bottom right corner.

Specify the following details:

### Transfer ID

The system generates a unique transfer ID. This will be used as a unique identifier of the account transfer.

### Current Branch

Specify the current branch of the account. On processing the transfer, the system will move the account from this branch to the target branch.

**Current Branch Name**

The system displays the name of the current branch.

**Target Branch**

Specify the target branch code. The option list displays all valid branch codes maintained in the system. Choose the appropriate one.

On processing the transfer, the system will move the account from the current branch to the branch selected here.

**Target Branch Name**

Based on the branch code selected, the system displays the name of the target branch.

**Transfer Date**

Specify the effective date of the account branch transfer. Click the date button to choose a date from the calendar.

The transfer date must be a date in the future. You cannot process the transfer on the current date or a past date.

**Account Details**

You need to specify the following account details:

**Account Number**

Specify the account number that you need to transfer. The option list displays all valid account numbers at the selected branch. Choose the appropriate one.

**Account Description**

Based on the account selected, the system displays the description.

**Customer Number**

Based on the account selected, the system displays the customer number.

**Customer Name**

Based on the customer number selected, the system displays the name of the customer.

Once you have captured the details, save the record. The system will process the account transfer on the transfer date.



### 6.3.1 Viewing Account Branch Transfer Details

You can search and view the details of account branch transfer using 'Branch Transfer Log' screen. To invoke this screen, type 'CSDACLOG' in the field at the top right corner of the Application toolbar and click the adjoining arrow button.

The screenshot shows the 'Branch Transfer Log' application window. The window has a title bar with a diamond icon and the text 'Branch Transfer Log'. Below the title bar is a toolbar with 'New' and 'Enter Query' buttons. The main area contains search criteria fields: 'Transfer Reference Number', 'Account Number', 'Transfer Date', 'Customer No', 'Source Branch', 'Target Branch', 'Status', and 'Account Class'. Below these is an 'Error Details' section with a table. The table has two columns: 'Error Code' and 'Error Message'. There is one row in the table with empty cells. At the bottom right of the window is an 'Exit' button.

You can search for the account transfer details based on one or more of the following parameters:

- | Transfer ID
- | Account number
- | Transfer date
- | Customer number
- | Source/current branch
- | Target branch
- | Status of the transfer record (Success/Error)
- | Account class

Once you have set the search parameters, click search button. The system displays the account transfers that match the search criteria. Double-click a record to view the details.

---

#### Note

The system will not process the account transfer in the following circumstances:

- The account is a Nostro type account
  - Local currency of the current branch and the target branch are different, in case of individual account transfer
  - Minor age limit is different for the current branch and target branch
-

---

**Note**

- Staff restriction, account class restriction and branch restriction are applicable while maintaining details of individual account transfer.
  - You can mark for rerun the accounts with status 'Error' by clicking 'Resubmit' button. Such accounts are processed during EOD operations on the next day.
- 

## 6.4 Transferring Account Class

You can transfer all accounts that belong to an account class, from one branch to another, using 'Account Branch Class Transfer' screen. To invoke this screen, type 'CSDACLTR' at the top right corner of the Application toolbar and click the adjoining arrow button.

Fields	
Maker	Date Time:
Checker	Date Time:
Mod No	Record Status
	Authorization Status

Specify the following details:

**Transfer ID**

The system generates a unique transfer ID. This will be used as a unique identifier of the account class transfer.

**Current Branch Code**

Specify the current branch of the account class. On processing the transfer, the system will move the accounts that belong to the selected account class from the current branch to the target branch.

**Current Branch Name**

The system displays the name of the current branch.

**Target Branch Code**

Specify the target branch code. The option list displays all valid branch codes maintained in the system. Choose the appropriate one.

On processing the transfer, the system will move the accounts that belong to the selected account class from the current branch to the target branch selected here.

#### **Target Branch Name**

Based on the branch code selected, the system displays the name of the target branch.

#### **Transfer Date**

Specify the effective date of the account branch transfer. Click the date button to choose a date from the calendar.

The transfer date must be a date in the future. You cannot process the transfer on the current date or a past date.

#### **Account Class**

Specify the account class that you need to transfer. The option list displays all valid account classes maintained in the system. Choose the appropriate one.

#### **Account Class Description**

Based on the account class selected, the system displays the account description.

Once you have captured the details, save the record. The system will process the account transfer on the transfer date.

## **6.5 Processing Account Branch Transfer**

During Beginning of Day Operations, the system will check the accounts whose transfer date is the current system date. These accounts are processed by the account branch transfer batch (ACDTRFBT), which is triggered as part of BoD operations.

The system verifies the balances of the accounts to be processed. There can be two cases as follows:

- I Negative balance – If the account balance is negative, then the system will debit the transfer GL and credit the account to make the balance zero.
- I Positive balance – If the account balance is positive, then the system will debit the account and credit the transfer GL to make the balance zero.

Further, the system updates the remaining necessary account information. The new branch code is updated in messages, statements and all branch related information specific to the account.

---

#### **Note**

The system will not process the account transfer in the following circumstances:

- The target branch is not allowed for the account class
  - The account has uncollected, unauthorized or tanked balance
  - The account status is 'Frozen', 'Deceased', 'No Debit' or 'No Credit'
  - The account is a Nostro type account
- 

Once the details are updated, the system transfers the balance back to the account from the transfer GL.

Auto deposits linked to the account is handled as follows:

- I Auto deposit maturing on the transfer date – The system does not transfer the auto deposits that mature on the date of transfer.
- I Auto deposit maturing in the future – The system transfers the auto deposits that mature on a future date.

*In case of a customer portfolio transfer or a bank merger, the accounts will be transferred to the corresponding branch. For further details on customer portfolio transfer and bank merger, refer to the sections 'Transferring Customer Portfolio' and 'Merging of Branches' in chapter 'Branch Transfer of Loans' of Retail Lending user manual.*

## 7. System Dates Maintenance

### 7.1 Introduction

In the 'System Dates Maintenance' screen you maintain the system dates for your branch, for instance, the business date for your branch, which is the booking, date for all transactions input in the branch.

The dates screen is maintained at the branch level by the respective branches. Invoke this screen by typing 'STDDATES' in the field at the top right corner of the Application tool bar and clicking the adjoining arrow button.

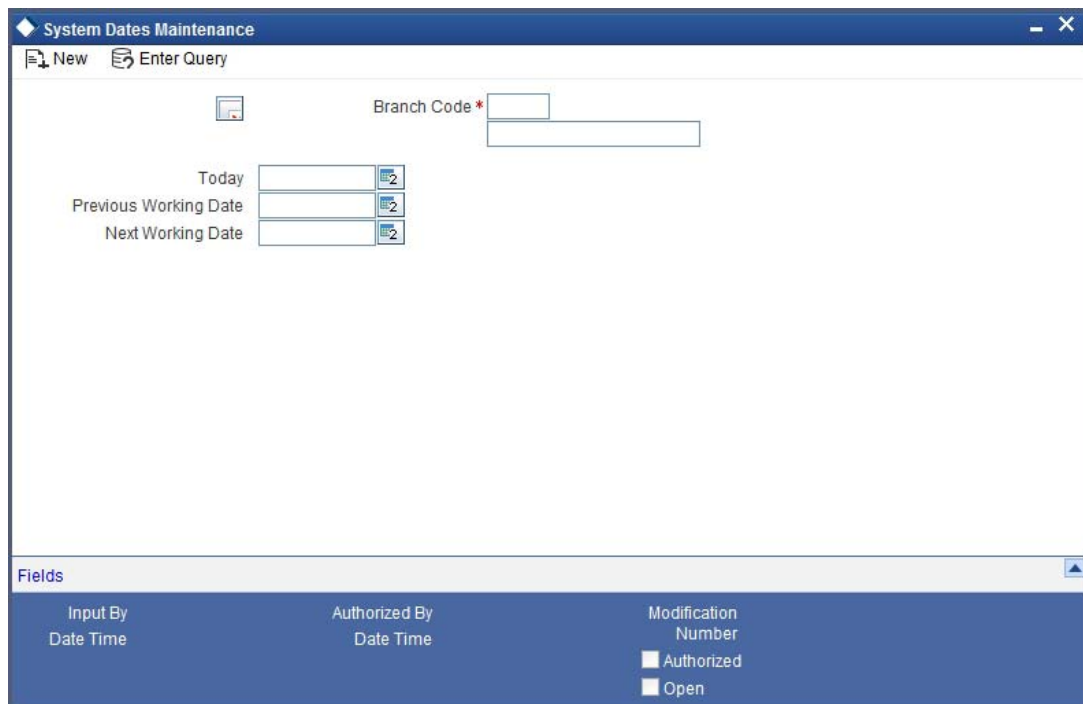

In this screen the following fields are maintained for your branch:

You define today's date, previous working date and next working date, for the first time, during installation of the system (for details refer to the installation manual).

Suppose Oracle FLEXCUBE is installed on 1 January 1998, in your bank. In the dates screen you would input the following:

**Today's date:** 01-JAN-1998

**Previous working date:** 31-DEC-1997

**Next working date:** 02-JAN-1998

After EOD for a branch is run, the system will not allow you to run any other operation in the branch, till a date change has been invoked.

If you try to run any other application, you will be prompted to invoke a date change first.

- I Simultaneously two different branches can be running on two different system dates. This may happen when EOD for a branch is delayed for some reason.

- | Based on 'today's date' (post authorization) the system computes and updates the 'Current financial cycle' and the 'Current period' in the Branch Parameters screen.

### **7.1.1 Maintaining Dates Change**

For maintaining date change, invoke the 'System dates maintenance' screen after EOD for the day is run. Click 'Unlock' in the Action menu or click unlock icon. The system populates the default dates in the screen.

For instance, on the first working date i.e., 2nd of January, 1998; the system dates will be updated to:

**Today's date = 02-Jan-1998**

**Previous working date = 01-Jan-1998**

**Next working date = 03-Jan-1998**

'Today's date' is defaulted from 'Next working date' of the old record. 'Previous working date' is defaulted from 'today's date' of the old record. The 'Next working date' is picked up from the 'Local branch holiday calendar' as maintained by you. You can modify 'today's date' and the 'next working date' by either clicking unlock icon on the toolbar/selecting 'unlock' from the action menu.' 'Previous working date' cannot be modified.

Today's date, if modified, should always be greater than the 'previous working date' and less than the 'next working date'. Similarly, 'next working date' if modified should be greater than 'today's date'. On modifying the dates, the system will ask you for an override. On confirmation the change will be effected.

Date change should be immediately authorized because no application of Oracle FLEXCUBE can be run without date change authorization.

- | If you have input any date modification, you cannot authorize it. A user with a different login ID should do it.
- | For a branch you can have only one system dates record
- | Any modification in date, (be it an authorized or unauthorized record), can be done any time after today's EOD and before BOD for the next day is run. You can modify the 'next working date' any time before running the EOD for the current day.

To authorize, click authorize icon on the toolbar. If any modifications were made, on the system date, the old and the new values will be displayed. After which an alert box will warn you that the dates change will be authorized. You will be prompted to confirm. Click  to confirm. The change will be authorized. If you do not want to authorize the change then click delete icon, you will be returned to the screen from where you invoked the authorization function. Click 'Exit' button to exit and return to the Application Browser.

---

## 8. Web Service Maintenance

### 8.1 Introduction

Oracle FLEXCUBE supports a generic functionality to call external web services. The operations done on the screens have the information of web services. The request processed during the operations is analyzed and the web service is enabled. This chapter takes you through the WebService Maintenance, WebService Mapping and other details regarding WebService.

### 8.2 Maintaining Web Service

You can maintain Web service through WebService Maintenance screen. You can invoke this screen by typing 'CSDEXTWS' in the field at the top right corner of the Application tool bar and clicking the adjoining arrow button.

The screenshot shows a software window titled "Webservice Maintainance". At the top, there is a toolbar with "New" and "Enter Query" buttons. The main content area is divided into two columns of input fields. The left column contains: "WebService Code \*", "WebService Description", "WebService User \*", and "WebService Password \*". The right column contains: "WebService Server IP \*", "WebService Server Port \*", and "WebService Server URI \*". At the bottom of the window, there is a dark blue footer area containing several fields: "Maker", "Checker", "Mod No", "Date Time:", "Record Status", and "Authorization Status". An "Exit" button is located in the bottom right corner of this footer area.

Specify the following here:

#### **WebService Code**

The unique code for the web service s defaulted here.

#### **WebService Description**

The description of the web service is displayed here.

#### **WebService User**

The system displays the user of the web service.

#### **WebService Password**

The system displays the password with which the web service is invoked.

#### **WebService Server IP**

The system defaults the IP address of the server where web service is installed.

### WebService Server Port

The system displays the port of the server where web service is installed.

### WebService Server URI

The system defaults the URI of the server where web service is installed.

## 8.2.1 Mapping of Web Service

WebService mapping is attached to the transaction screens for which web service call is required. You can invoke this screen by typing 'CSCEXWSO' in the field at the top right corner of the Application tool bar and clicking the adjoining arrow button.

WebService Code	Calling Sequence Number	Calling Stage	Status	Details
<input type="checkbox"/>	<input type="text"/>	PRE	Unprocessed	Details

### WebService Code

Select the unique web service code from the adjoining option list.

### Call Sequence Number

The unique sequence number for the web service is displayed here.

### Calling Stage

Select the stage at which web service should be called from the drop-down list.

### Status

The system defaults the status of the web service.



## 8.2.2 Web Service Details

Web Service details is attached to the maintenance screens for which web service call is required. You can invoke this screen by typing 'CSCEXWSM' in the field at the top right corner of the Application tool bar and clicking the adjoining arrow button.

WebService Code	Calling Sequence Number	Calling Stage	Status	Details
<input type="checkbox"/>		PRE	Unprocessed	Details

### **WebService Code**

Select the unique web service code from the adjoining option list.

### **Call Sequence Number**

The system displays the unique sequence number for the web service.

### **Calling Stage**

Select the stage in which the web service should be called from the drop down list.

### **Status**

Select the status of the web service from the drop down list.

---

### **Note**

- When any operation is done in the screen and call to back end is made, the request built during this process will have the information of web services to be called. The web service call will be made based on the status of each web service which will be updated in the backend.
- The details of an external web service is taken from the maintenance screen based on the web service code mentioned in the call form. Each web service should be deployed in the URL mentioned in the maintenance before processing the request.
- A flag will be set to find whether the request contains the web service information and the same will be used for parsing the request in the application server. Call to the web service is based on the request format that particular web service accepts. The request to the web service should be in that format and it can be written in the handler class provided.

---

Sending request to back end involves two cases:

- I If in the request, option to call the web service is pre, then the web service will be called and the response from the web service will be appended in the request before sending it to the back end.

- 1 If in the request, option to call the web service is post, then the request will sent to back end first and the response from the back end will be sent to the web service. The response from the web Service Call will be appended in the request and sent to the backend again.

### **8.2.3** **WebService Maintenance**

Web Service Maintenance is attached to the maintenance screens for which web service call is required. You can invoke this screen by typing 'CSDEXWSD' in the field at the top right corner of the Application tool bar and clicking the adjoining arrow button.

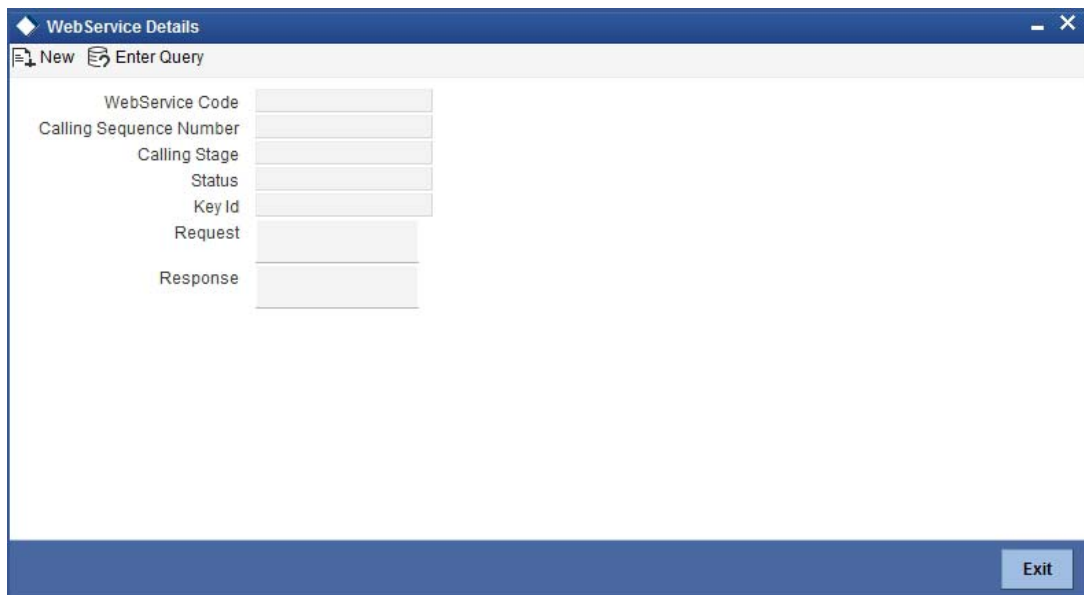

#### **WebService Code**

The system displays the unique code of the web service

#### **Call Sequence Number**

The system displays the unique sequence number of the web service

#### **Calling Stage**

Select the stage in which the web service should be called.

#### **Status**

The system defaults the status of the web service.

#### **Key ID**

The system defaults the ID for which the web service is called.

#### **Request**

The system displays the request of the web service.

#### **Response**

The system displays the response of the web service.

---

## 9. Accounts for Inter-Branch Transactions

### 9.1 Defining Accounts for Inter-Branch Transactions

A transaction that takes place in a branch of your bank may involve accounts that are maintained in another branch. For example, a customer has an account in the Head Office branch and approaches another branch of the bank for a cash withdrawal.

For each combination of branches that may be involved in an inter-branch transaction, you can define the currency and the respective customer accounts to which the related accounting entries will be posted.

The accounting entries for such inter-branch transactions can be routed in one of the following ways:

- **Directly** - where each branch will have a direct accounting relationship with all other branches
- **Through a Regional Office** -- where two branches involved in a transaction will interact through a common RO
- **Through the Head Office** -- where the two branches involved in the inter-branch transaction will interact only through the HO.

This route for all transactions is defined in the 'Bank parameters' screen.

In the 'Inter-branch Parameters Maintenance' screen you define the internal accounts for pairs of branches that would be involved in any inter-branch accounting.

Invoke this screen by typing 'ACDIBMNT' in the field at the top right corner of the Application tool bar and clicking the adjoining arrow button.

The screen appears as shown below:

In this screen you maintain the following for each combination of branches that may be involved in an inter-branch transaction:

- Branch Code of both the branches that are involved in the transaction
- For each of the branches, whether inter-branch entries must be posted in transaction currency or settlement account currency
- Customer accounts of Branch 1
  - Due to Branch 2
  - Due from Branch 2
- Customer accounts of Branch 2
  - Due to Branch 1
  - Due from Branch1

### 9.1.1 System Features

The system generates a set of pairs of branches for which internal accounts should be maintained. The pairs generated depend upon on two factors:

- The reporting structure for the branches as created in the 'Branch parameters' screen and
- The route defined for inter-branch transactions in the 'Bank-wide parameters -- Preferences' screen,

For example, the following represents the reporting structure of your bank:

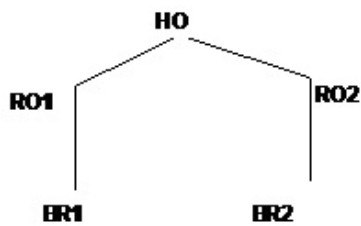

If you have defined a direct inter-branch accounting route then you need to maintain an accounting relationship for each possible combination of

- Branch and branch
- Branch and RO
- RO and HO
- Branch and HO

For the above mentioned reporting structure the system will offer the following pairs of branch combinations to be maintained:

1. BR1- BR2
2. BR1- RO1
3. BR2- RO2
4. RO1- HO
5. RO2- HO
6. BR1 - RO2
7. BR2 - RO1
8. BR1 – HO
9. BR2 – HO
10. RO1 - RO2

If you have defined 'through RO' inter-branch accounting route then you need to maintain an accounting relationship for each possible combination of

- Branch and RO/HO
- RO and RO

In the branch and RO pair, the RO should be that RO to which this branch reports. For the above mentioned reporting structure the system will offer the following branch pairs to be maintained:

1. BR1 - RO1
2. BR2 - RO2
3. RO1 – HO
4. RO2 – HO
5. RO1 - RO2

If you have defined 'through HO' inter-branch accounting route then you need to maintain an accounting relationship for each possible combination of,

- Branches and HO

- ROs and HO

For the above mentioned reporting structure the system will offer the following branch pairs to be maintained:

1. HO - RO1
2. HO - RO2
3. HO - BR1
4. HO - BR2

The system has an in-built auto escalation path for inter-branch accounting transaction which escalates from Direct to Through RO to Through HO.

For example, in the 'Bank preferences' screen you have defined a 'direct' inter-branch accounting relationship. But in the 'Inter-branch Accounts' maintenance screen (where all inter-branch accounts are maintained), you have not maintained an accounting relationship between two branches -- 000 and 002. Then, in case of an inter-branch accounting transaction between 000 and 002, the system will first look for a 'direct relationship' since that has not been maintained it will look for a relationship through RO i.e., if the two branches have a common RO; if that too does not exist then 'through HO' the transaction would take place.

## 9.1.2 Specifying Customer Accounts

System determines the settlement route for inter-branch transactions by considering the customer accounts that you specify for a particular currency in this screen.

For example, your bank has to processes a transaction in USD involving your branch (Branch Code 001) and another branch (Branch Code 002). If you maintain the customer accounts for the branch pair 001-002 and currency USD, system will accordingly determine the settlement route.

### **Branch1 and Branch2**

To specify a branch pair for which you want to define the customer accounts, you can choose from a list of maintainable branch pairs displayed by the System. The description of Branch 1 and Branch 2 are displayed below the respective branch codes.

### 9.1.2.1 Specifying General Ledger Details

Specify the customer accounts which are involved in the inter-branch transaction, in the respective branches

To maintain customer accounts for the branch pair specified, the following parameters should be maintained:

#### **Inter Bank Currency**

For each branch, you have the option of specifying whether the inter-branch entries must be posted in the transaction currency or the settlement account currency.

For the booking branch, if the Inter-branch Transaction Currency option specified is Transaction Currency, inter-branch entries are posted in the transaction currency only if:

- The local currency of both branches involved in the transaction is the same
- One of the accounts in the entries belongs to the booking branch

#### **Due To Branch 2**

This field identifies the customer account maintained in Branch 1 into which the credit accounting entry is passed.

To specify the customer account, select the appropriate account from the picklist of all the customer accounts maintained at Branch 1 .

**Due From Branch 2**

This field identifies the customer account maintained in Branch 1 into which a debit entry will be passed.

**Due to Branch 1**

This identifies the customer account maintained at Branch 2 into which a credit entry will be passed.

**Due From Branch 1**

This account identifies the customer account maintained at Branch 2 into which a debit entry will be passed.

System uses the customer accounts specified in this screen and determines the settlement route for a transaction between two different branches of your bank.

## 9.2 Defining Accounts for Inter-Branch Fund Transactions

A fund transaction that takes place in a branch of your bank may involve accounts that are maintained in another branch.

As mentioned earlier, if you have selected the option 'Allow Corporate Access' in the Branch Parameters screen and the branch is a fund branch, the IB Entity will be defaulted as General Ledger. The GL that will be used will be based on the maintenance in the Fund Inter Branch Accounts Maintenance screen, for the fund id.

To invoke this screen, type 'IADIBMNT' in the field at the top right corner of the Application tool bar and clicking the adjoining arrow button.

For a fund id, specify all the details necessary to define the Inter branch GL that will be used. The option list against the field Fund ID includes all the valid funds maintained in the system.

For an explanation on each of the other fields, refer to the previous section.

## 9.2.1 Querying on Netting Batch

You can view all netted and non-netted transactions of the netting process from the 'Netting Batch Query' screen. You can invoke this screen by typing 'STDNETQY' in the field at the top right corner of the Application tool bar and clicking the adjoining arrow button.

The screenshot shows the 'Netting Batch Query' application window. At the top, there is a menu bar with 'New' and 'Enter Query' options. Below the menu bar, there are three input fields: 'Group Code', 'Account Number', and 'Date'. A section titled 'Netting Batch Details' contains a table with columns: 'Netting Reference Number', 'Date', 'Branch', 'Account', and 'Module'. The table currently shows one row of data. At the bottom right of the window is an 'Exit' button.

You can query on the basis of one or more of the following parameters:

- Netting Group Code
- Account Number
- Date

On searching, the system displays the following details:

- Netting Reference Number
- Date
- Branch Code
- Account
- Module
- Event
- Reference Number
- Transaction Code
- Amount Tag
- Debit/Credit Transaction
- Account Currency
- Foreign Currency Amount
- Local Currency Amount



# 10. Currency Maintenance

## 10.1 Introduction

In the 'Currency Definition' screen, you define the attributes of the currencies in which your bank can deal. For each currency, you can define attributes like, the SWIFT code for the currency, the country to which the currency belongs, the interest method, the spot days, the settlement days, etc.

Currencies can be maintained only at the Head Office. The list of currencies will be made available to all the branches of your bank.

Invoke this screen by typing 'CYDCDEFE' in the field at the top right corner of the Application tool bar and clicking the adjoining arrow button.

The screenshot shows the 'Currency Definition' application window. The interface includes a top menu bar with 'New' and 'Enter Query' options. The main area is divided into several sections: 'Currency Code' and 'Alternate Currency Code' fields; 'Currency Name' and 'Currency Type' fields; 'ISO Numeric Currency Code' field; 'Country' and 'Decimals' fields; 'Interest Method' dropdown menu (set to '30-Euro/360'); 'Spot Days', 'Foreign Exchange', 'Netting Days', and 'Settlement Days' fields; 'Position General Ledger', 'Position Equivalent General Ledger', 'Tolerance Limit', and 'Index Base Currency' fields; 'Cutoff Time' section with 'Days', 'Hour', and 'Minute' fields; 'Rounding' section with 'Rule' (Truncate) and 'Unit' fields; 'Amount Format Mask' section with radio buttons for '99,999,999,999' and '99,99,99,99,999'; and 'Euro Type' section with radio buttons for 'Euro Currency', 'IN Currency', 'Out Currency', and 'Euro Closed'. A status bar at the bottom displays 'PC | Currency Country Mapping | Fields' and 'Authorized' status.

## 10.2 Maintaining Currency Details

### Currency Code

Currencies are identified in Oracle FLEXCUBE by the SWIFT codes assigned to them. The currency will be identified by this code in all transactions that involve it.

### Currency Name

You can enter the detailed name of the currency in not more than thirty-five alphanumeric characters.

### Currency Type

As per your bank's requirement you can choose to classify currencies into different currency types. The bank can use its own discretion to decide the basis of classifying currencies into different currency types. A currency type can consist of a maximum of three characters.

Depending on the customer account mask maintained, the value in the currency type field would be used during the generation of customer account numbers through the Customer Accounts Maintenance screen.

If you have decided to include currency type as part of the customer account number (in the account number mask), then at the time of creating a new customer account number, you will need to select the currency of the account number being generated. In the option-list provided for currency, the currency code is displayed along with the associated currency type say, USD – 1, GBP – 2 etc. When the account number gets populated, it is the currency type that forms a part of the customer account number.

### **ISO Numeric Currency Code**

Specify the currency code specified by the International Standardization Organization.

### **Country**

After you have identified the currency, you should indicate the country to which the currency belongs. You can select a country code from the option list available.

### **Decimals**

You can indicate the number of decimal units up to which the currency can be denominated. The number of decimals allowed for any amount in the currency can be:

0 - Currency with no decimals

2 - Currency with two decimals

3 - Currency with three decimals

### **Interest Method**

You can indicate the interest rate to be used for transactions that involve this currency. The interest options available are:

- Actual/Actual
- 30(US)/360
- Actual/360
- 30(Euro)/365
- 30(US)/365
- Actual/365
- 30(Euro)/Actual
- 30(US)/Actual
- Actual/Actual

Select the interest method that should be used by default whenever the currency is used in transactions. While processing a transaction that involves this currency, the interest method defined for the currency is defaulted. You have the option to change it for a specific transaction.

However, if you do not specify an interest method for a transaction, the method defined for the currency will be used (For details refer to the Annexure in this User Manual).

### **Spot Days**

The number of spot working days applicable for the currency is specified here. Payment advises for FX and MM contracts will be generated on a date, which is calculated as the number of spot working days before the Maturity Date of the contract.

For example, the tenor of an MM contract is as follows:

**Value Date** - 01/01/99

**Maturity Date** - 31/01/99

**Contract Currency - USD**

**Contract Amount - 5000**

For USD, the number of Spot Days is specified as: **Spot Days - 3**

For this contract, the payment advices will be sent on 28/01/96.

### **Foreign Exchange Netting Days**

Oracle FLEXCUBE provides a facility wherein all transactions relating to a customer, meant to be settled on a particular day and are made before a specific cut off day are collated, netted and a single payment message is sent instead of individual messages for each payment. This cut off day can be parameterized and is called 'Netting Days'. The number of FX netting days applicable for the specified currency is maintained here.

---

#### **Note**

The system will validate that the FX Netting days are lesser than or equal to the spot days.

---

### **Settlement Days**

In this screen, you can specify the 'Settlement Days' for a currency. Settlement messages for the components of a contract (in the LC, BC, LD, MM, FX, and FT modules) will be generated according to the settlement days specified for the currency of the settlement account. The following example illustrates this.

For example, when maintaining the details of USD in the Currency screen, you specify the 'Settlement Days' as '2'. This implies that two working days prior to the settlement of a component through a USD account, a settlement message will be automatically generated if specified (when you run the Settlement Messages function at the end of day).

The settlement details of a contract are as follows:

Settlement Date: 06 May 1999

Settlement Account Currency: USD

Component: Principal

Settlement Message: **Yes**

Component Currency: GBP

When you generate the Settlement Messages function, at the end of day, on 04 May 1999, a settlement message for the Principal component of the contract will be generated.

You can run Settlement Messages function as part of EOD operations from the Application Browser to automatically generate settlement messages for contracts marked out for automatic liquidation.

The settlement day specification for a currency will determine the contracts that are picked up for settlement message generation.

### **Cut-off Time**

The Currency Cut-off time refers to the time by which all transactions involving a currency should be generated. For a currency, you can indicate the cut-off hour and minute. This time should be expressed in the local time of the bank.

The maintenance of a cut-off time for a currency has particular reference to outgoing funds transfers involving it.

### **Cut-off days**

You can also specify the cut-off days and time for payment transactions involving the currency.

For example, the value date of a funds transfer transaction (incoming payment) involving USD, is 3<sup>rd</sup> June 2001. The number of cut-off days specified for the currency is 2. This means that the payment must be received on or before 1<sup>st</sup> June 2001. If the payment is received on 1<sup>st</sup> June, it must be received before the cut-off time specified for USD.

If the USD cut-off time is 1200 hrs, then, if the payment is received on 1<sup>st</sup> June 2001, it must be received before 1200 hrs.

The cut-off time (in hours and minutes) that you maintain to be applicable for payment transactions involving a currency are applicable to the head office branch of your bank.

If the branches are in time zones other than the head office branch time zone, you must maintain the offset time applicable for each branch, in the Branch Parameters screen.

---

### **Note**

Even when cut-off days and cut-off time for a currency have both been specified, the cut-off checks are performed for a funds transfer transaction only if specified as applicable for the product involved in the transaction.

---

### **Position or Position Equivalent GL for a currency**

If you have opted for position accounting in your bank, you should indicate the Position GL and the Position Equivalent GL, when maintaining a foreign currency, in the currency screen (the Currency Definition screen).

When maintaining the GLs in your bank, you can opt to link the different foreign currencies, associated with the GL to either of the following:

- The Position GLs that you specify here (for the corresponding currency)
- Position GLs of your choice

### **Tolerance Limit**

When you are maintaining an 'In' Currency, or the Euro, in the Currency Definition screen, you can define a 'Tolerance Limit' for it. The limit is expressed as a percentage.

### **The implication:**

During the transition period, settlement of components in 'In' currencies can be made either in the same currency or in the Euro (EUR) depending on the settlement account(s) maintained. (Similarly, components in Euro can either be settled in EUR or in an 'In' currency.) In the settlement messages that are generated (MT 100, MT202), the settlement amount would be reported in the Settlement Account Currency. However, you can opt to additionally furnish the value of the component in Euro Related Information (ERI) currency. You have to manually specify the settlement amount value, in the ERI currency, in the Settlement Message Details screen.

When generating the message towards settlement (MT100, MT202), the system ensures that the value you specify as the ERI Amount conforms to the Tolerance Limit defined for the ERI Currency (in the Currency Definition screen). That is, the system computes the ERI equivalent of the settling amount using the pegged rates, and compares the same against the ERI

amount input by the user. If the difference is within the tolerance limits defined for the ERI currency, the user specified amount is used.

If the user specified ERI amount breaches the Tolerance Limit defined for the ERI currency, the system calculates and reports the ERI Amount on the basis of the exchange rate defined for the settlement currency vis-à-vis the ERI currency.

For example, in the SWIFT messages (MT 100 and MT 202) that are generated towards settlement, the value of the component can be reported both in Nostro account currency (in Field 32A) and in an ERI currency that you specify (in Field 72). In Oracle FLEXCUBE, this information is captured in the European Related Information (ERI) fields in the Settlement Message Details screen.

Assume the following scenario:

- The settlement account is an EUR account
- You have to settle an amount of DEM 10000
- You have defined the ERI currency for DEM as DEM
- The Tolerance Limit for DEM as 0.05%
- The exchange rate: 1 Euro = 1.30 DEM

The settlement amount in Euro would therefore be 7692.36 (rounded to nearest higher cent). This amount will be reported in Field 32A of the settlement messages. Now, if you want to furnish the settlement amount in the ERI currency (in this case, DEM) you have to manually enter the DEM value in the ERI Amount field. You may enter DEM 10000. (EUR 7692.36 actually converts into DEM 10000.068.)

The value that you have entered is well within the Tolerance Limit of 0.05% defined for DEM. Therefore, this value will be reported in Field 72 of the settlement messages.

Since the Tolerance Limit for DEM is 0.05%, you can specify an ERI Amount between DEM 9995 and DEM 10005 ( $DEM\ 10000 * 0.05/100 = DEM\ 5$ ). If you enter an ERI value exceeding DEM 10005 or less than DEM 9950, the system recalculates the ERI Amount at the time of generating the settlement messages. The recalculation will be on the basis of the pegged rates between the Settlement Currency and the ERI currency.

---

#### **Note**

The system validates the ERI amount only when generating the settlement messages. It does not validate the ERI amount at the time of input (in the Settlement Message Details screen).

---

#### **Index Base Ccy**

Specify the currency that should be used to handle index-based securities traded by the banks, wherein the deals are done in index currency and their settlement is done through the local currency.

#### **Generate 103+**

You can enable the MT 103 + format option only if you would like to generate outgoing MT 103 messages in the MT 103 + format.

If you are enabling this option for a specific currency, ensure to also enable this option:

- For your bank branch in the Branch Parameters Maintenance
- For the customer of the contract, in the BIC Code Maintenance
- For the product used by the contract, in the Product Preferences

Consequently, while processing transactions in the specified currency for such a customer, branch and product, for which the MT 103+ option is enabled, the system generates outgoing payment messages in the MT 103 + format.

---

**Note**

Since the system is also capable of processing incoming MT 103 messages in the MT 103 + format. Therefore, during the upload process for your branch, the system considers an MT 103 payment message to be of MT 103+ format for those customer, currency and product combinations, for which the MT 103+ option has been enabled.

---

**CLS currency**

To allow customers of your bank to settle their FX deals via the CLS (Continuous Linked Settlements) Bank, you can identify the currency to be a 'CLS Currency'. FX deals in the CLS currency only will be eligible to be routed through the CLS bank.

From the available list of CLS currencies, you can further maintain a list of 'allowed' or 'disallowed' currencies for a specific customer. Every customer who is a 'CLS Participant' will be allowed to trade in all the available CLS currencies unless specifically mentioned.

*Refer the 'Continuous Linked Settlements' chapter of the Foreign Exchange User Manual for details on maintaining currency restrictions and other maintenances required for processing CLS deals in Oracle FLEXCUBE.*

**Index Flag**

Check this box to derive index rate of the currency in Lending module.

**Validate Tag 50F**

Check this box to indicate that validations need to be performed for the 50F details captured for the ordering customer during contract input.

*For more details on 50F validations, refer the chapter titled 'Maintaining Addresses for a Customer' in Messaging System user manual.*

---

**Note**

Customer cover messages are always generated in new format (MT202COV or MT205-COV).

---

*For more details on new cover message formats, refer settlements user manual.*

## 10.2.1 Indicating Rounding Preferences

**Rule**

This refers to the method to be followed for rounding off fractional units of a currency. The rounding preferences available are:

- Truncate — The amount is truncated to the number of decimals specified for the currency
- Round Up — The amount is rounded up based on the number of decimals and the nearest rounding unit
- Round Down —The amount is rounded down based on the number of decimals and the nearest rounding unit

For example,

Amount before Rounding	Rounding Method	No. of Decimals	Rounding Unit	Amount after Rounding
1234.678	Truncate	2	-	1234.67
1234.678	Round up to the nearest rounding unit	2	.01	1234.68
1234.678	Round down to the nearest rounding unit	2	.01	1234.67

### Unit

If you have selected Round Up or Round Down in the Rule field, you need to indicate the nearest unit to which the rounding should take place. The number of units specified here should not be greater than the number of decimals allowed for the currency.

### **Example**

The decimal points specified for currency 'A' is 2. Rounding unit is .05

Amount for transaction is USD 100.326, which will be rounded off depending upon the decimals specified and the rounding rule and rounding unit.

For Rounding Rule 'Up', the amount available for transaction would be USD 100.35. For rounding rule 'Down', the transaction amount would have been rounded down to 100.30

If the rounding rule was specified as 'truncate' then, the amount would have rounded off to 100.32 (simply, knock off all decimal points beyond the stated decimals places to be rounded off). Thus whenever you specify a 'truncate' option you need not state the 'Rounding unit'.

## 10.2.2 **Specifying Amount Format Mask**

Specify the format in which amounts in this currency are to be displayed for contracts in this currency. Two options are available:

999,999,999

9,999, 999, 99

The system defaults to the 999,999,999 format.

### **Euro Type**

When maintaining a currency in the Currency Definition screen, you have to specify the 'type' of the currency with relation to transition phase of the European Economic and Monetary Union (EMU). You can do this in the 'Euro Type' field.

Your specifications in this field enable you to handle the *first phase* of the EMU, which commenced on 01 January 1999.

*For more details on the manner in which Oracle FLEXCUBE handles the Euro, refer the chapter 'Handling the Euro'.*

By choosing the appropriate option, you can indicate if the currency is:

- The Euro
- An 'In' currency
- An 'Out' currency

- 'Euro Closed'

National currencies of 'In' countries are referred to as 'In' currencies. When maintaining other currencies, you have to choose the 'Out Ccy' option under Euro Type.

When the transition period ends, the national currencies of the participating countries would cease to exist as valid legal tenders. The Euro would be the only legal tender in the participating countries. Consequently, the Euro changes made to Oracle FLEXCUBE will no longer be required.

You can turn off the changes at the end of the transition period by:

1. Closing all 'In' currencies, and
2. Choosing the 'Euro Closed' option (for the Euro)

### 10.2.3 **Specifying Exchange Rate Limits**

Click 'PC' button in the Currency Definition screen to invoke 'Limits' screen.

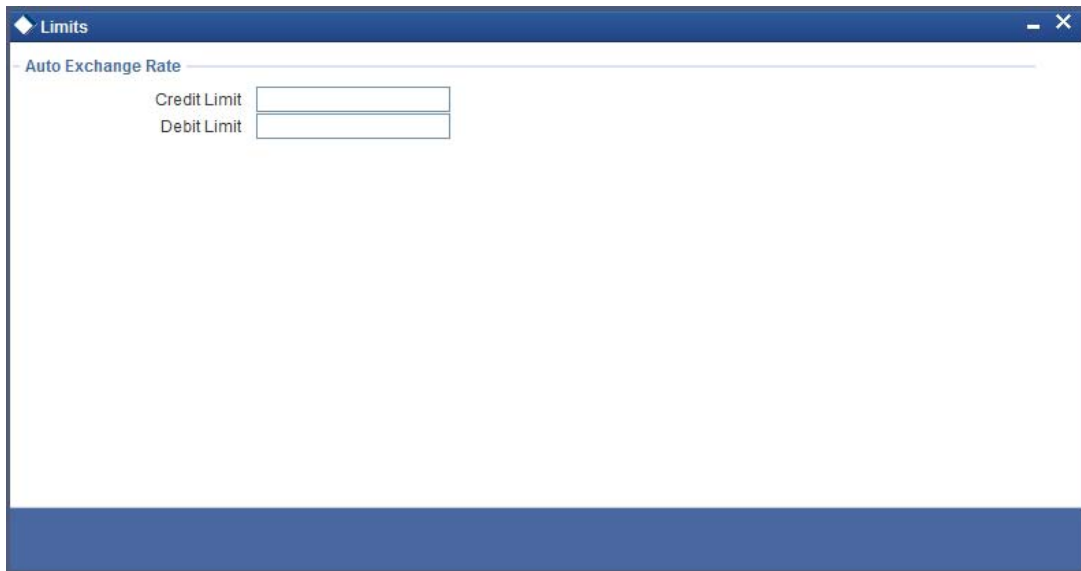

You can specify the credit limit and the debit limit for the exchange rate in this screen. The transaction amount of a PC contract must not exceed the limit specified here.

### 10.2.4 **Mapping Currency to Country**

Click 'Currency Country Mapping' button in the Currency Definition screen to invoke 'Clearing Zones Country Codes for Currency' screen.



The screen appears as shown below:



You can map a currency code to a country in this screen.

### 10.2.5 Specifying User Defined Fields

You can associate values to all the User Defined fields created and attached to the Currency Definition Screen. You can view the list of User Defined fields associated by clicking the 'Fields' button.

The screen appears as shown below:

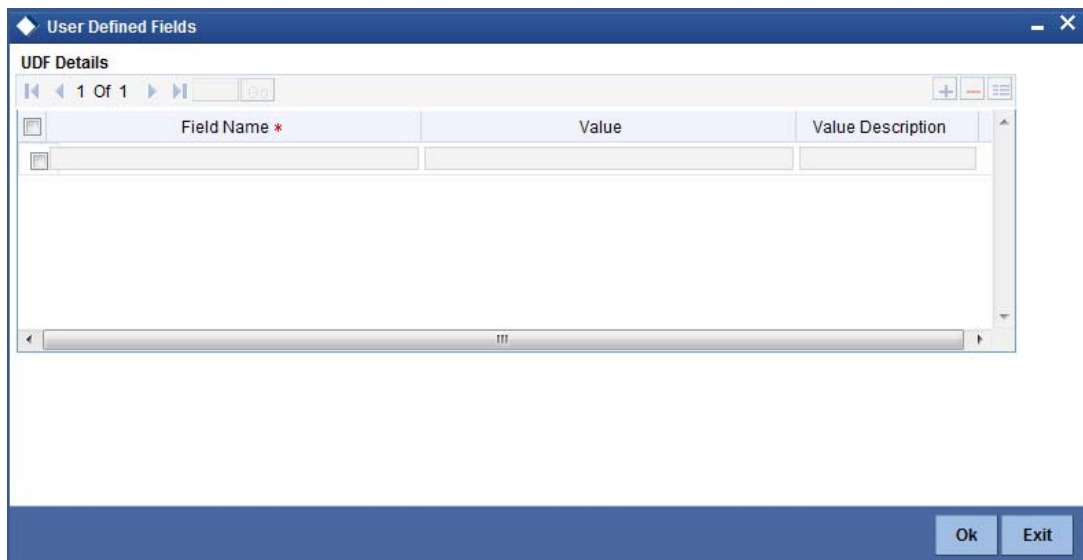

You can enter the value for the UDFs listed here in the 'Value' column.

*For more details on how to create user Defined fields, refer chapter 'Creating custom fields in Oracle FLEXCUBE' in the User Defined Fields User Manual under Modularity.*

### 10.2.6 Annexure

The treatment for interest calculation varies with each of the interest calculation methods. Each method is dealt with individually below:

**Actual/Actual Method**

$$10,000 \times 10 / 100 \times (31 / 365 + 84 / 366)$$

In this method, the number of days is calculated as follows:

Dec. -31 days (include from date exclude to date)

Jan -31 days

Feb.-29 days (leap year)

March - 24 days (include from date exclude to date)

$$\text{Total} = 31 + (31+29+24=84) = 115$$

---

**Note**

When the interest period crosses from a non-leap year to a leap year (or otherwise), the basis of actual days has to be treated separately in each year.

---

Therefore, the denominator for the 31 days in December is 365 as it is a non-leap year and the denominator for the 84 days in 2000 is 366 as it is a leap year.

**Actual /365 Method**

$$10,000 \times 10 / 100 \times 115 / 365$$

In this method, the number of days is calculated as follows:

Dec. -31 days (include from date exclude to date)

Jan -31 days

Feb.-29 days (leap year)

March - 24 days (include from date exclude to date)

$$\text{Total} = 31 + 31 + 29 + 24 = 115$$

**Actual/360 Method**

$$10,000 \times 10 / 100 \times 115 / 360$$

In this method, the number of days is calculated as follows:

Dec. -31 days (include from date exclude to date)

Jan -31 days

Feb.-29 days (leap year)

March - 24 days (include from date exclude to date)

$$\text{Total} = 31 + 31 + 29 + 24 = 115$$

**30 Euro/Actual Method**

$$10,000 \times 10 / 100 \times (30 / 365 + 84 / 366)$$

In this method, the number of days is calculated as follows:

Dec. - 30 days (include from date exclude to date)

Jan - 30 days (In 30 Euro Method, all months have 30 days, February included.)

Feb. - 30 days (In 30 Euro Method, February always has 30 days, leap year or not)

March - 24 days (include from date exclude to date)

Total = 113 days

---

**Note**

When the interest period crosses from a non-leap year to a leap year (or otherwise), the basis of actual days has to be treated separately in each year.

---

**30 Euro/365 Method**

$10,000 \times 10 / 100 \times 114 / 365$

In this method, the number of days is calculated as follows:

Dec. - 30 days (include from date exclude to date)

Jan - 30 days (In 30 Euro Method, all months have 30 days, February included.)

Feb. - 30 days (In 30 Euro Method, February always has 30 days, leap year or not)

March - 24 days (include from date exclude to date)

Total = 113 days

**30 Euro/360 Method**

$10,000 \times 10 / 100 \times 114 / 360$

In this method, the number of days is calculated as follows:

Dec. - 30 days (include from date exclude to date)

Jan - 30 days (In 30 Euro Method, all months have 30 days, February included.)

Feb. - 30 days (In 30 Euro Method, February always has 30 days, leap year or not)

March - 24 days (include from date exclude to date)

Total = 113 days

**30 US/Actual Method**

$10,000 \times 10 / 100 \times (30 / 365 + 84 / 366)$

In this method, the number of days is calculated as follows:

Dec. - 30 days (include from date exclude to date)

Jan - 30 days (In 30 US Method, all months have 30 days, only for February are the actual number of days calculated.)

Feb. - 29 days (In 30 US Method, actual days are accounted for the leap year.)

March - 24 days (include from date exclude to date)

Total = 113 days

---

**Note**

When the interest period crosses from a non-leap year to a leap year (or otherwise), the basis of actual days has to be treated separately in each year.

---

**30US/365 Method**

$10,000 \times 10 / 100 \times 114 / 365$

In this method, the number of days is calculated as follows:

Dec. - 30 days (include from date exclude to date)

Jan - 30 days (In 30 US Method, all months have 30 days, only for February are the actual number of days calculated.)

Feb. - 29 days (In 30 US Method, actual days are accounted for the leap year.)

March - 24 days (include from date exclude to date)

Total = 113 days

**30US/360 Method**

$10,000 \times 10 / 100 \times 114 / 360$

In this method, the number of days is calculated as follows:

Dec. - 30 days (include from date exclude to date)

Jan - 30 days (In 30 US Method, all months have 30 days, only for February are the actual number of days calculated.)

Feb. - 29 days (In 30 US Method, actual days are accounted for the leap year.)

March - 24 days (include from date exclude to date)

Total = 113 days

## **10.2.7 Specifying Currency Cut-Off Parameters**

You can choose to restrict the time within which (or before which) funds transfer transactions involving a specific customer, product, and a currency, must be received for processing. For a specific customer, product, and a currency, you can specify a certain number of days before which a transaction involving the combination must be received, as well as a cut-off time before which transactions must be received. These parameters are known as currency cut-off parameters, and you maintain these parameters in the 'Value Dated Spread' maintenance screen.

Invoke this screen by typing 'FTDVDSR' in the field at the top right corner of the Application tool bar and clicking the adjoining arrow button.

The screen is as shown below:

Value Dated Spread Maintenance

New Enter Query

Customer No \*

Customer Name

Product Code \*

Product Description

Currency Code \*

Currency Description

Spread Details

Debit Value Date Spread \*

Credit Value Date Spread \*

Cut Off Details

Days

Hour

Minutes

Fields

Maker Date Time:

Checker Date Time:

Mod No Record Status

Authorization Status

Exit

In this screen, you can maintain the cut-off time, cut-off days and the value spreads to be applicable for:

- Each customer, for a product and currency combination
- All customers, for each product and currency combination

These currency cut-off parameters are validated in respect of a funds transfer transaction only if currency cut-off checks are specified as applicable in the product preferences, for the product involving the transaction.

*For details about how the currency cut-off checks are applied on a funds transfer transaction, refer the chapter 'Processing a Funds Transfer Contract' in the Funds Transfer User Manual.*

## 10.3 Maintaining Currency Position Details

You can view the currency position through Currency Position Details screen. To invoke this screen type 'CYDCCYLS' in the field at the top right corner and click the adjoining arrow button in the application toolbar.

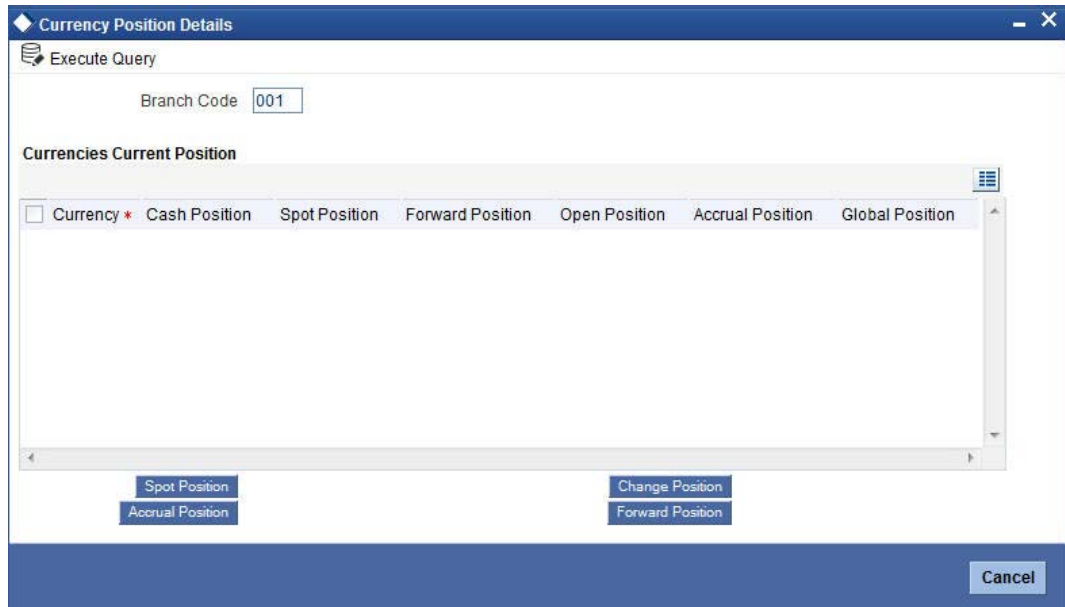

In this screen, system calculates and displays the currency positions for different currencies.

You can view the following positions of each currency in a selected branch:

- Cash Position - This gives the currency wise cash position based on the transactions booked across all the modules in Oracle FLEXCUBE. It considers the entries that are formed under Asset, Liability, Income and Expenses GL heads for which 'Report as Accrual' at GL Maintenance screen is not checked.
- Spot Position - This position is derived based on the outstanding deals from various modules for which the maturity date falls on the spot days as maintained in the 'Currency Maintenance' screen.
- Forward Position - This position is acquired based on the outstanding deals from various modules for which the maturity date falls after the spot days maintained in the 'Currency Maintenance' screen.
- Open Position - This position is a combination of Cash Position, Spot Position and Forward Position
- Accrual Position - This gives the currency wise position across all the modules in Oracle FLEXCUBE considering the entries that formed under Asset, Liability, Income and Expenses GL heads for which 'Report as Accrual' at 'GL Maintenance' screen is checked.
- Global Position - This position is a combination of Cash Position, Spot Position, Forward Position and Accrual Position.

---

### Note

Check 'Report as Accrual' field in 'GL Chart of Accounts Maintenance' screen to calculate the accrual entries posted to this GL. This is displayed during the online query of FX positions. Depending on your selection in this field, system will arrive at the cash and accrual positions.

---

Click 'Spot Position' to view the details of the deals that have contributed to spot position.

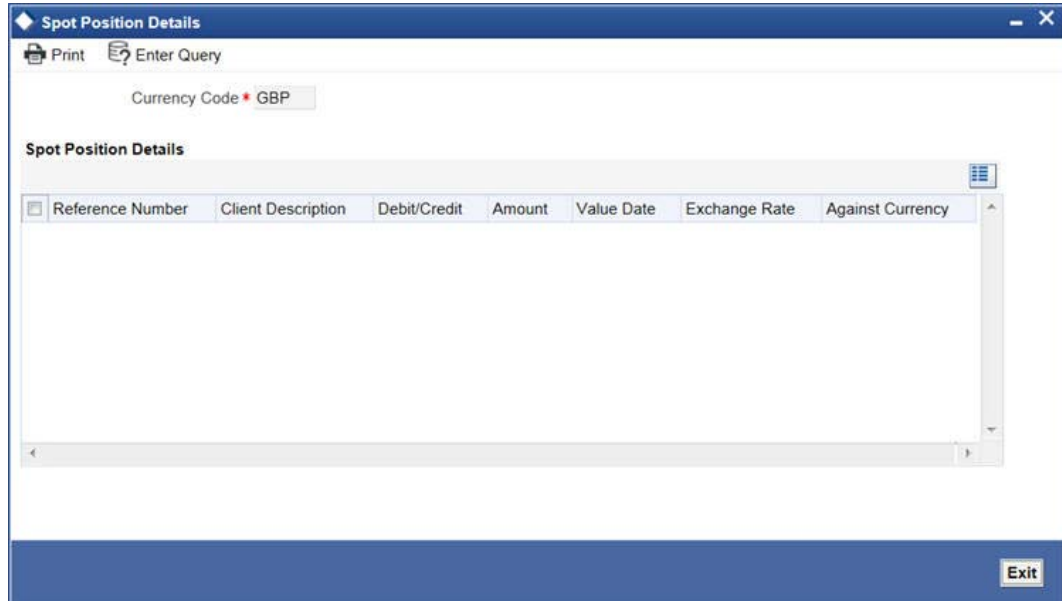

Click 'Change Position' to view the details of the deals that have contributed to change position.

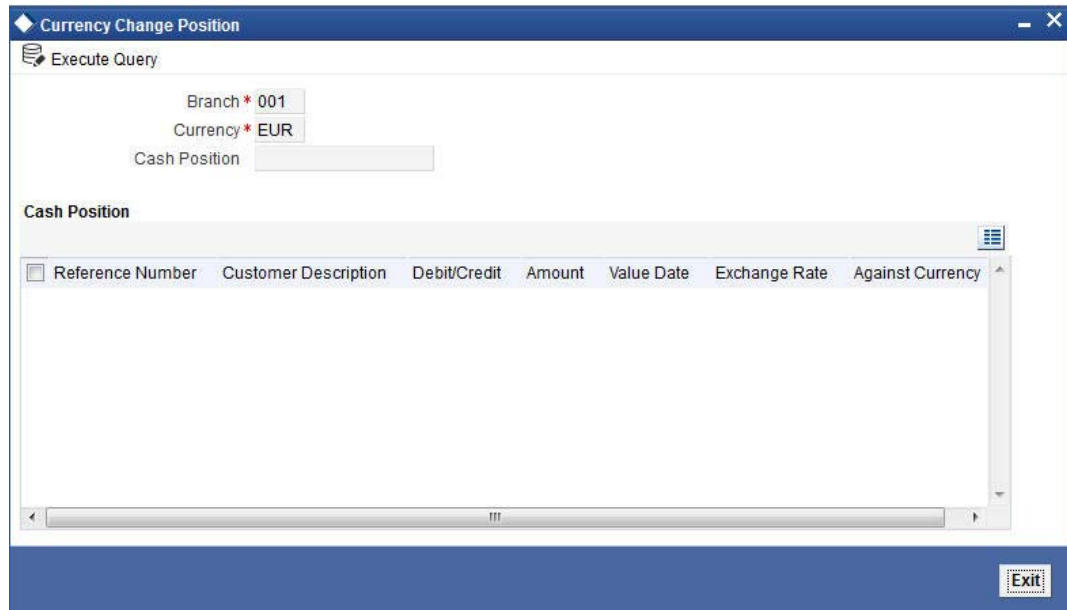

Click 'Accrual Position' to view the details of the deals that have contributed to accrual position.

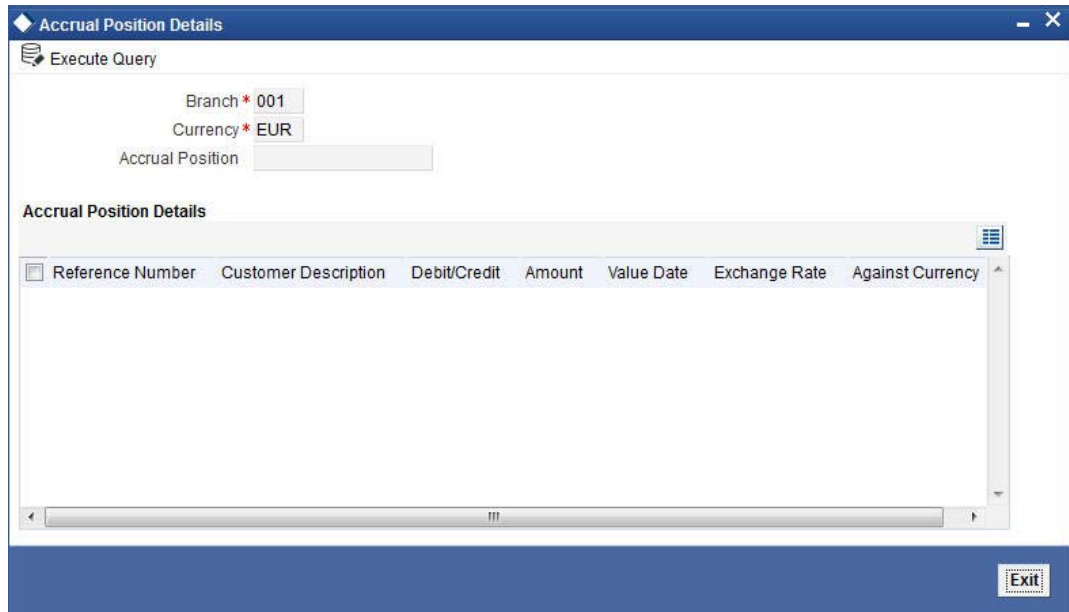

Click 'Forward Position' to view the details of the deals that have contributed to forward position.

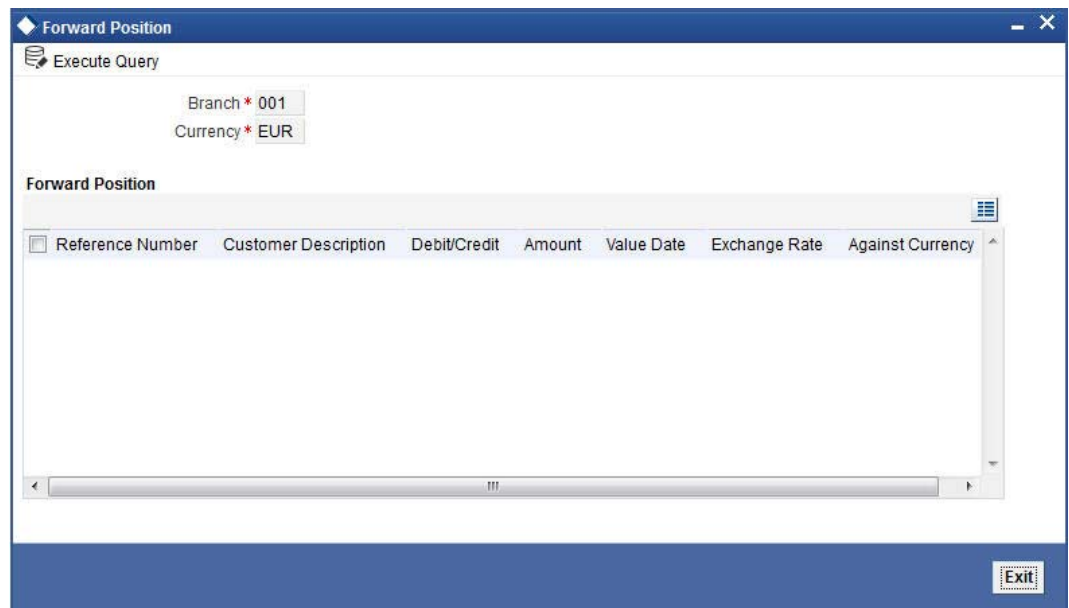

## 10.4 Handling Euro

On 1 January 1999, eleven countries that are part of the European Union embarked on the first phase of economic integration, called the 'Economic and Monetary Union' (EMU). In Oracle FLEXCUBE, the eleven countries participating in the first phase of the EMU are referred to as 'In' countries and the respective national currencies as 'In' currencies. All other countries are referred to as 'Out' countries.

The first phase of the EMU, referred to as the 'transition period', ushered in a new, single European currency: the **Euro (EUR)**. During this phase, the National Currency Denominations of 'In' countries would co-exist with the Euro. That is, transactions involving an 'In' currency would, typically, be routed through the Euro during this phase. At the end of the transition period, in mid 2002, however, the national currencies of the participating



countries would cease to exist as valid legal tenders. The Euro would be the only legal tender in 'In' countries.

In Oracle FLEXCUBE, you can handle the Euro and the attendant implications for your bank, by capturing additional currency and settlements related information. This chapter details how this information is to be captured, and its implications.

## 10.5 Maintaining Euro Related Information

In Oracle FLEXCUBE, the details that you need to maintain in order to handle the EMU include:

- Maintaining Euro as a valid currency
- Indicating if a currency is 'In', 'Out', 'Euro', or 'Euro Closed'
- Maintaining Currency Redenomination details
- A common conversion GL and a transaction code to identify the redenomination entry
- Maintaining a 'Tolerance Limit' for a currency (to check against ERI information)
- Capturing additional settlement details (Euro related information for the MT 100 and MT 202 SWIFT messages)

You can maintain currency related information in the Currency and the Currency Pair Definition screens. 'Settlement' details can be captured in the Settlement Instruction Details screen.

### 10.5.1 Maintaining Currency Details

Your specifications for a currency in the Currency Definition screen determine the manner in which transactions in the currency are handled in Oracle FLEXCUBE.

#### **Currency Type**

When maintaining a currency in the Currency Definition screen, you have to specify the 'type' of the currency. You can do this in the 'Euro Type' field. Choose the appropriate option from the following:

- The Euro itself
- An 'In' currency
- An 'Out' currency
- 'Euro Closed'

National currencies of 'In' countries are referred to as 'In' currencies. When maintaining other currencies, you have to choose the 'Out Ccy' option under Euro Type.

When the transition period ends, the national currencies of the participating countries would cease to exist as valid legal tenders. The Euro would be the only legal tender in the participating countries. Consequently, the Euro changes made to Oracle FLEXCUBE will no longer be required.

You can turn off the changes at the end of the transition period by:

- Closing all 'In' currencies, and

- Choosing the 'Euro Closed' option (for the Euro)

### Tolerance Limit

When you are maintaining an 'In' Currency, or the Euro, in the Currency Definition screen, you can define a 'Tolerance Limit' for it. The limit is expressed as a percentage.

### The Implication:

During the transition period, settlements of components in 'In' currencies can be made either in the same currency or in the Euro (EUR) depending on the settlement account(s) maintained. (Similarly, components in Euro can either be settled in EUR or in an 'In' currency.) In the settlement messages that are generated (MT 100, MT202), the settlement amount would be reported in the Settlement Account Currency. However, you can opt to additionally furnish the value of the component in Euro Related Information (ERI) currency. You have to manually specify the settlement amount value, in the ERI currency, in the Settlement Message Details screen.

When generating the message towards settlement (MT100, MT202), the system ensures that the value you specify as the ERI Amount conforms to the Tolerance Limit defined for the ERI Currency (in the Currency Definition screen). That is, the system computes the ERI equivalent of the settling amount using the pegged rates, and compares the same against the ERI amount input by the user. If the difference is within the tolerance limits defined for the ERI currency, the user specified amount is used.

If the user specified ERI amount breaches the Tolerance Limit defined for the ERI currency, the system calculates and reports the ERI Amount on the basis of the exchange rate defined for the settlement currency vis-à-vis the ERI currency.

The following example illustrates the application of the Tolerance Limit.

---

### Note

The system validates the ERI amount only when generating the settlement messages. It does not validate the ERI amount at the time of input (in the Settlement Message Details screen).

---

## Currency pairs

In the Currency Pair Definition screen, you can specify a 'Through Currency'. When maintaining a pair involving an 'In' currency ('In' – 'Out' and 'In' – 'In'), you can only specify the Euro as the 'Through Currency'.

---

### Note

You cannot maintain a 'Through Currency' for a pair constituted by an 'In' currency and the Euro.

---

## 10.5.2 Maintaining Conversion GLs

To facilitate the currency conversion process, two additional parameters need to be maintained in the 'Branch Parameters' screen. You have to maintain a common Conversion GL and a Transaction Code that identifies redenomination entries.

The screen is as shown below:

### 10.5.2.1 Indicating Euro Redenomination General Ledger

#### Conversion GL

The conversion GL that you specify will be identified as the common Suspense GL for all balance conversions while re-denominating the currency of an account either for specific customers or for generic conversions.

#### Transaction Code

In addition to the conversion GL, you have to indicate a Transaction Code, which identifies conversion related entries.

### 10.5.3 Implications of Currency Redenomination

#### In the IC Product Accounting Role Definition screen

For the purpose of currency conversion, an accounting role called 'Acquired' is available.

### **End of day processes**

Maintaining a Conversion GL and Transaction Code simplifies the End of day process. Basically two important things happen when the End of day processes are run. Firstly interest is liquidated to the Acquired Interest GL and secondly all balances will be reduced to zero.

When you run the Beginning of day processes the next day the change in the currency conversion will be in place. In addition balances will get restored.

### **Change in field values due to conversion**

The change in currency re-denomination impacts amount based fields pertaining to Accounts, Collaterals, Credit Lines and Customer Limits. The change in the value of these fields is reflected when you run the beginning of day processes.

The amount-based fields, which are affected by the change in currency denomination, will be updated with the equivalent value in the new currency

### **Accounts**

The following fields will reflect the new values:

- Temporary Over Draft limit
- Sub-limit
- Uncollected Funds limit
- Offline limit
- Account Currency

These fields can be found in the Customer Accounts Maintenance screen.

### **Collateral**

In the Limits Maintenance Collaterals screen the following fields will be updated:

- Collateral Currency
- Collateral Value
- Limit Contribution
- Issuer Exposure Amount

### **Credit Lines**

In the Limits screen of the Limits Maintenance module the following fields will reflect the new values:

- Credit Line Currency
- Tenor limits
- Tenor utilization
- All Related Amounts

### **Customer Limits**

In the Customer Maintenance screen of the Core Services module the following fields will be updated at BOD.

- Limit Currency
- Liability Risk Limit
- Customer Risk Limit

---

**Note**

Once the conversion process is complete the advices generated for your customer will carry the following information:

- The Old Value
- The New Value
- And the Exchange Rate used for the conversion

As a consequence of currency re-denomination you will not be able to pass entries where the value date falls before the currency conversion date.

---

#### 10.5.4 Specifying Preferred ERI Currency for Counterparty

For a counterparty and currency (combination), you can maintain a preferred ERI currency. You can state this preference in the 'Settlement Instructions' screen.

##### The Implication

During the transition period, settlements of components in 'In' currencies can be made either in the same currency or in the Euro (EUR) depending on the settlement account(s) maintained. (Similarly, components in Euro can either be settled in EUR or in an 'In' currency.) In the settlement messages that are generated (MT 100, MT202), the settlement amount would be reported in the Settlement Account Currency. However, you can opt to additionally furnish the value of the component in Euro Related Information (ERI) currency. You can maintain this ERI currency (for a counterparty and currency combination) in the 'Settlement Instructions Maintenance' screen.

In the SWIFT messages that are generated towards settlement of a component (involving the counterparty and the currency), the component value will be expressed in this (ERI) currency, by default. Invoke this screen by typing 'ISDINSTN' in the field at the top right corner of the Application tool bar and clicking the adjoining arrow button.

The screen is as shown below:

The screenshot displays the 'Settlement Instructions Maintenance' application window. The interface includes a top navigation bar with 'New' and 'Enter Query' options. The main workspace is organized into several sections: 'Pay' and 'Receive' for transaction details, a 'Charges Details' section with radio buttons for 'Ourselves', 'Beneficiary', and 'Shared', and a tabbed interface for 'Pay Parties', 'Receiver Parties', 'Cover Parties', 'Clear Details', 'Cover Details', and 'Other Details'. The 'Pay Parties' tab is currently selected, showing 'Intermediary Reimbursement Institution' and 'Intermediary' sections with multiple rows of input fields for 'Country'. A footer bar contains fields for 'Maker/Checker', 'Date Time', 'Mod No', 'Record Status', and 'Authorization Status', along with an 'Exit' button.

## 10.5.5 Specifying Settlement Message Details

SWIFT messages (MT 100/MT202) generated towards settlement can furnish the value of the settlement amount in both the settlement account currency, and an 'ERI' currency. If you opt to furnish the ERI value of the amount, you have to enter the following in the 'Settlement Details' screen:

- The ERI currency
- The ERI Amount

The screen appears as shown below on clicking 'Settlements' button in the contract screen:

Component	Currency	Branch	Account	Account Currency	Dr/Cr	Original Exchange Rate	Exchange Rate	Rate Code

The system defaults to the ERI currency specified for the customer and currency combination. You can change the default ERI currency. The ERI amount that you specify will be validated against the Tolerance Limit specified for the ERI currency.

## 10.5.6 Settlements of Foreign Exchange Deals

Oracle FLEXCUBE allows cross currency settlements of foreign exchange deals that involve an 'In' currency. You can settle the 'In' currency leg in another 'In' currency or in 'Euro'.

## 10.5.7 Reports and Advices

The following reports furnish the equivalent Euro values of amounts in an 'In' currency. The 'locked in' exchange rates defined for the Euro against the 'In' currency will be used for currency conversions.

The reports with this feature are the:

- Currency Position report
- Cash Flow report
- FX Maturity report

---

**Note**

These reports will not furnish the 'In' currency and equivalent Euro values when you close the 'In' currencies, and choose the 'Euro Closed' option (for the Euro) in the Currency Definition screen.

---

All advices that provide 'In' currency details will also provide the equivalent Euro values

**Account Statements**

Statements provided for accounts in an 'In' currency provide the Euro equivalent values of the following:

- The opening balance
- The closing balance
- Every transaction

### 10.5.8 Maintaining Limits Type

You can maintain various limit types and their values through the 'Limits Types Maintenance' screen. For example, you can define and maintain various Limit types like price codes, collateral types and price through this screen.

You can invoke this screen by typing 'LMDTYPES' in the field at the top right corner of the Application tool bar and clicking the adjoining arrow button.

The screen is as shown below:

Value	Code

Fields

Input By Date Time	Authorized By Date Time	Modification Number
		<input type="checkbox"/> Authorized
		<input type="checkbox"/> Open

**Type**

Specify the limit type for which you want to maintain values

**Description**

Specify the description for the limit type you are maintaining

## Values

The values for the limit type that you are maintaining can be listed here. To add a value to the list of values, click on the 'Add' icon, and type the value. To remove a value from the list of values, check the box against that value and click on the 'Delete' icon.

### **Value**

Specify the list of supported values. For example, MAIL, COURIER, BRANCH and so on.

### **Code**

Specify the codes for the list of value. For example, CO, ML and so on.

## **10.5.9 Maintaining Transaction Limits**

This section explains in detail about maintaining transaction limits, level of authorisations required for the transaction amounts and minimum user authorisation limit required for a transaction.

Oracle FLEXCUBE offers you a facility, whereby, each time a particular transaction processed in the system exceeds a certain limit; an override will be generated by the system.

You can maintain transactional limits for a module and product combination through the 'Product Transactional Limits Maintenance' screen. Invoke this screen by typing 'CSDPLMNT' in the field at the top right corner of the Application tool bar and clicking the adjoining arrow button.

The screen appears as shown below:

Transaction Limit *	Level of Authorization	Minimum Authorization Limit	Cumulative
<input type="text"/>	<input type="text"/>	<input type="text"/>	<input type="checkbox"/>

### **Module Identification**

Each module in Oracle FLEXCUBE is identified by a code. First, you have to identify the module for which the currency-wise transactional limit is to be maintained. A list of all the modules operational at your bank will be displayed in the option list. You can choose the appropriate module code.



### **Module Description**

The description associated with the module will be defaulted in the adjacent field.

### **Product Code**

Each module contains a number of products within it. After you identify the module, indicate the product within the module for which you would like to maintain a currency-wise transactional limit. You can select the appropriate product code from the option list.

In the Product Transactional Limits screen, you can maintain the limits for:

- A specific module and a specific product
- A specific module and all products (select 'ZALL' as the Product Code)
- All modules (Select 'AL' as the Module Code) and all products

### **Product Description**

The description associated with the module will be defaulted in the adjacent field.

### **Source Code**

Specify the source code based on which you need to maintain the product transactional limits. The adjoining option list displays all valid source codes. The transaction limit amount maintained for the selected source code is used to validate transaction limit while authorizing the contract.

If the source code is available in Oracle FLEXCUBE, then the system enables all the fields available under 'Product Transaction Limit Details' multi grid.

If the source code external, then the system enables only 'Transaction Limit' available under 'Product Transaction Limit Details' multi grid.

---

#### **Note**

You cannot select a source code more than once.

---

### **Transaction Limit Currency**

The transaction limit currency is the currency in which you would like to maintain the amount limit.

### **Customer Type**

Select the type of customer for whom you are maintaining the transaction limits from the adjoining drop-down list. The following are the options available:

- Corporate
- Individual
- Bank
- All

## **10.5.9.1 Specifying Product Transaction Limit Details**

Specify the following transaction limit details:

### **Transaction Limit**

Specify a transaction limit. Each time you process a transaction, the system checks the transaction amount involved in the contract against the limit specified here. If the contract currency is different from the transaction limit currency, then the system converts the contract amount using the standard mid rate to the transaction limit currency and check against the transaction limit amount maintained for the product

The system displays an appropriate message indicating the levels of authorization if the transaction amount booked is in excess of the maintained transaction limit.

#### **Level Of Authorization**

Specify the number of authorisers to be involved in the authorising a particular transaction amount.

---

#### **Note**

The level of authorization should be greater than one.

---

#### **Minimum Authorization Limit**

This option is enabled only if the 'Cumulative' option is checked. Specify the minimum authorization limit required for a transaction. The authorization limit cannot be greater than the transaction limit. This amount is used to validate authorizer limit while authorizing the contract.

#### **Cumulative**

Check this option to indicate that multiple authorisers are allowed to authorise a transaction. The authorisers must have equal or greater than the minimum authorization limit maintained in this screen. The system displays an appropriate error message if the authoriser tries to authorise a transaction having transaction amount greater than the minimum authorising limit.

### **10.5.9.2 Validating Transaction Amount during Contract Processing**

While saving a contract, the system will check the transaction amount against the cut-off amount maintained for the module and product currency involved in the transaction. If both the transaction currency and the limits currency are same, the comparison will be done directly. If different currencies are involved, the system will first convert the transaction amount into the cutoff amount currency using the STANDARD mid rate and then perform the validations.

To perform the check, the System will look for the limits maintained, in the following order:

3. The System looks for the limits maintained for a specific module and specific product combination
4. If the first option is not available, it checks the limits maintained for a specific module + ZALP (all products) combination
5. It checks the maintenance for AL (all modules) + ZALP (all products) combination

If the third option is also not available, the system displays an error message

When a transaction exceeds the amount limit, the system displays an override message while saving the transaction

## **10.6 Maintaining Sequence Generation Format**

Every contract in Oracle FLEXCUBE is identified by a unique Contract Reference Number that is generated internally by the system. You are not allowed to modify this number. In addition, a contract is also identified by a unique User Reference Number. By default, the Contract Reference Number will be taken as the User Reference Number. But you have the option to change the User Ref Number.

Oracle FLEXCUBE also provides you the facility to generate the user reference number in a specific format.

To maintain a specific format, you need to identify the various components that would be part of the user reference number including details such as the length, order, value etc. of each component.

You can maintain a unique format through the 'Sequence Generation Input' screen. You can invoke this screen by typing 'CSDSQGEN' in the field at the top right corner of the Application tool bar and clicking the adjoining arrow button.

The screen appears as shown below:

The screenshot shows the 'Sequence Generation Input' application window. The window title is 'Sequence Generation Input'. It contains several input fields: 'Sequence Code \*', 'Branch Code', 'Module Code', 'Reset Frequency' (set to 'Daily'), a 'Range' checkbox, 'From', and 'To'. Below these is a 'Sequence Detail' table with columns: 'Component Order', 'Component', 'Component Type', 'Use in Sequence Generation', 'Component Length', and 'Component V'. The table shows '1 Of 1' records. At the bottom, there is a 'Fields' section with labels: 'Maker', 'Checker', 'Date Time:', 'Mod No', 'Record Status', 'Authorization Status', and an 'Exit' button.

You can maintain the following details of the sequence format:

### Sequence Code

Each sequence format is identified by a unique sequence code. You can devise a code comprising a maximum of 20 alphanumeric characters.

### Branch Code and Module Code

You can maintain the format for a specific branch and module combination. Select the branch code and the module code from the option-list. All authorized and active records will be displayed in the list.

Alternatively, you can maintain a sequence format that will be applicable to all the branches (ALL) and all the modules (AL) available in your bank.

### Reset Frequency

You need to specify the frequency at which the system will drop and recreate the sequence numbers once again. At the reset frequency that you specify, all sequence numbers of the sequence format will be dropped and recreated again during the End of Day processing.

The options available are:

- None
- Daily
- Monthly

- Yearly

For example, let us assume that the running number in the sequence format is 4 characters long (starting from 0001) and the reset frequency is Monthly. Further, let us assume that the sequence number of the last contract processed on the last day of the month is 0199. At EOD of the last day of the month, the sequence numbers generated till date will be dropped and the system will begin regeneration starting from 0001 once again for all subsequent contracts.

### **Range**

You can specify a range of sequential reference numbers. If you specify such a range, then no additional details need be specified. If you do not specify a range, you can specify additional details specific to each component of the sequence format.

In addition to the above details, you should also maintain details specific to each component of the sequence format. The details are as follows:

### **Component Order**

Each component is assigned an order number based on which they would appear in the user reference number. The component order is automatically generated by the system and is non-editable.

### **Component**

Each component in the sequence format is identified as one of the following:

- An Oracle FLEXCUBE Component – If your sequence format uses an Oracle FLEXCUBE column directly, you can specify it as an Oracle FLEXCUBE Component. For instance, you may want to include the product group associated with the product code involved in a contract, as a component in sequence number generation. To achieve this, you will use the Oracle FLEXCUBE column `PRODUCT_GROUP` (available in the table `CSTM_PRODUCT`) as an Oracle FLEXCUBE Component.
- A User Component – You may want the first two characters of your bank's name to be part of all the user reference numbers generated at your bank. You can define it as a user component. In addition, if you want to use the manipulated value of an Oracle FLEXCUBE Column in the sequence format, you can specify it as a User Component. For eg, you may want to include ONLY the first four characters of the product group in the sequence number. In this case, the component would be defined as a User Component.
- A Separator – To separate the various components from one another, you can use the component known as the separator. Eg: a back slash, a hyphen etc.
- A Running Number – Each contract is identified by a unique sequence number. It is mandatory to maintain a running number as a component in the sequence format. If not included, you will not be allowed to save the details of the format. A running number is internally generated by the system.

### **Component Type**

You need to identify the type of each component in the sequence format. A component can be constant through out or change for every contract processed at your bank. You can associate a component with one of the following types:

- Static – To include any hard coded component in the sequence format, you will specify the type to be static. For instance, you may want the first two characters of your bank's name to be part of all the user reference numbers generated at your bank. The component type would be static in this case.
- Dynamic – You will specify the component to be of the dynamic type if its value is picked up from the Oracle FLEXCUBE table. Eg: Product Group. A running number would always be dynamic in nature.

### **Use in Sequence Generation**

You need to indicate whether the component being defined should be used in sequence generation or not. Specify 'YES' or 'NO' as per your choice.

You can also choose to display the reference number in the advices that are generated for a contract.

### **Component Length**

You can also specify the length of each component in the sequence format. The component value is dependent on the component length maintained. For instance, if you specify 2 as the component length, the value should comprise of only two characters.

### **Component Value**

As stated earlier, the component value is dependent on the component length. Based on the length, you can specify a value comprising of as many characters as specified in the Component Length field. However, this field is used only if the value of the component is required to be constant (static type) in all the user reference numbers generated at your bank. If the component value is changing constantly (Dynamic type) for every contract, the system will automatically pick up the value from the DB table based on the SQL query that you maintain for the purpose.

### **Component Column and Component Table**

If your component is of the dynamic type, you will need to mention the name of the Oracle FLEXCUBE column from where the system will pick up the component value. Further, if you wish to include a manipulated column value in sequence generation, you will need to include 'SUBSTR' as well in the column name. For eg, to include only the first four characters of the product group associated with the product code involved in a contract, you will specify the following in the Component Column field:

```
SUBSTR (PRODUCT_GROUP, 1, 4)
```

You need to mention the table name also, if the component type is dynamic. The following table names are available in the option-list provided.

- DUAL
- STTM\_BANK
- STTM\_BRANCH
- CSTM\_PRODUCT

For our example, the table name would be CSTM\_PRODUCT.

### **Component Where Clause**

The condition or the 'where clause' of the SQL code is specified here. In the example discussed above, the system will pick up the appropriate product group depending on the product code involved in the contract being processed. You can specify the following where clause as an extension of the SQL statement specified earlier:

```
WHERE PRODUCT_CODE = SUBSTR (P_CRN, 4, 4);
```

Click add icon to define each subsequent component in the format. Use the navigating icons to move between the various components of a sequence format.

# 11. Maintaining Currency Denomination

## 11.1 Introduction

In the Data Entry module, you can specify a break up of a transaction amount for Teller transactions by denomination. The system also maintains a break-up of the till balances by denomination.

## 11.2 Maintaining Currency Denomination Details

In the 'Currency Denomination' screen, you maintain the standard currency denominations for each currency that your bank deals with. You can invoke this screen by typing 'CSDDEMAN' in the field at the top right corner of the Application tool bar and clicking the adjoining arrow button.

The screenshot shows the 'Denomination Details' application window. The form includes the following fields:

- Denomination Type \* (Dropdown menu, selected: Cash)
- Currency Code \* (Text field)
- Issuer Code \* (Text field)
- Issuer Description (Text field)

The table below the form has the following columns:

Denomination Id *	Denomination Description	Denomination Value *	Sequence Number	Type *
				Note

At the bottom of the window, there are fields for:

- Maker
- Checker
- Mod No
- Date Time:
- Record Status
- Authorization Status

An 'Exit' button is located in the bottom right corner.

To maintain the denominations of a currency, you need to specify the following:

- The code of the currency for which you are defining denominations
- A unique code to identify each denomination of the currency. For example, you can assign D1, D10, D50 for USD 1, 10, 50.
- A description of the denomination unit
- The denomination type coin or note
- The value of the denomination in relation to one unit of the currency. It could be a fraction for coins

For example, for the currency USD you can maintain the denominations as follows:

CURRENCY CODE	DENM CODE	DESCRIPTIO N	VALU E	NOTE / COIN
USD	D100	100 dollars	100.00	NOTE

USD	D50	50 dollars	50.00	NOTE
USD	D20	20 dollars	20.00	NOTE
USD	D10	10 dollars	10.00	NOTE
USD	D5	5 dollars	5.00	NOTE
USD	D1N	1 dollar Note	1.00	NOTE
USD	D1C	1 dollar Coin	1.00	COIN
USD	C25	25 cents	0.25	COIN
USD	C10	10 cents	0.10	COIN
USD	C5	5 cents	0.05	COIN
USD	C1	1 cent	0.01	COIN

Denomination type Millionaire certificate is used to facilitate MC/LMC (Millionaire Certificate) transactions. You can have only one denomination with denomination type as 'Notes' and the currency code should be the LCY code of each country..

#### **11.2.0.1 Operations Allowed in the Currency Denomination Screen**

Following standard maintenance operations are possible in the 'Currency Denomination' screen:

- Add
- Modify
- Delete
- Authorize
- Close
- Re-open
- Inquiry
- Logs all maintenances in the Audit Trail.

# 12. Expressing Amounts in Words

## 12.1 Introduction

You can describe the amounts printed on account statements, messages, advices, etc., in words, for the benefit of your customers. To describe 'amounts' in a specific language, you have to maintain the verbal equivalents of numerals in the language. You can maintain verbal equivalents of numerals in the 'Amount Text Maintenance' screen.

You can invoke this screen by typing 'STDAMTMN' in the field at the top right corner of the Application tool bar and clicking the adjoining arrow button.

The screenshot shows the 'Amount Text Maintenance' application window. At the top, there is a 'Save' icon and a 'Language Code' field with a dropdown arrow, and a 'Description' field with a speech bubble icon. Below these is a 'Text' section containing a table with columns 'Amount', 'Description', and 'Prefix One'. The table has one row with a checkmark in the first column. Below the 'Text' section is a 'Currencies' section containing a table with columns 'Currency Code', 'Pre Decimal', 'Post Decimal', 'Final Text', 'Text Before', and 'Fracti'. The table has one row with a checkmark in the first column. At the bottom, there is a 'Fields' section with labels: 'Maker', 'Checker', 'Mod No', 'Date Time', 'Date Time', 'Record Status', and 'Authorization Status'. A 'Cancel' button is located in the bottom right corner.

Amount translation details can be maintained as one time maintenance at the time Oracle FLEXCUBE is installed at your bank. Once maintained, the amount descriptions printed on account statements, and other messages, will be described according to your specifications in this screen.

### Language

You can maintain verbal equivalents of numerals in any language that Oracle FLEXCUBE supports. This means that you can maintain the verbal equivalents of numerals in as many languages as you generate messages.



## **Text**

You must describe the following numerals in the Description field (in the language that you specify in the Language field):

- 1, 2, 3, upto 10
- 20, 30, 40, 50, 60, 70, 80, and 90
- 100
- 1,000
- 10,000
- 100,000
- 1,000,000
- 10,000, 000, and so on

In certain languages, One thousand, One million, and so on are expressed, simply, as 'thousand', and 'million'. If you are defining verbal equivalents of amounts in such a language, do not choose the 'Prefix One' option. Statements and messages printed in such a language will describe amounts such as '1000', simply, as 'thousand'.

Choose the 'Prefix One' option, if you would like amounts such as '1000' described as 'One thousand'.

## **Currencies**

In this screen, you can also describe the pre-decimal and the post-decimal units of a currency in different languages. Enter the verbal equivalent of the 'pre' and 'post' decimal units of a currency in the Pre-Decimal and Post-Decimal fields respectively. For example, if you would like to describe the decimal units of USD, enter:

1. The currency in the Currency field
2. The pre-decimal description as 'Dollars'
3. The post-decimal description as 'Cents'
4. Final Text to be attached to the currency.

You can opt to prefix, or suffix, an amount with its currency. If you would like the suffix an amount with its currency, do not choose the 'Text Before' option. If you would like to prefix an amount with its currency, choose the 'Text Before' option.

For example, if you would like to describe USD 1000, as Dollars One Thousand, choose the 'Text Before' option.

# 13. Defining Currency Pairs

## 13.1 Introduction

In the foreign exchange markets, the exchange rates for some currency pairs such as the USD-GBP or USD-JPY are easily obtainable, since these are frequently traded. The exchange rates of other currencies such as the ZAR-INR (South African Rand - Indian Rupee), which is not traded very often, is determined through a third currency. This third currency is usually the US dollar, since the US dollar is quoted in all trading centres.

In the Currency pair definition screen, you define the static attributes of currency pairs for which a regular market quote is readily available. For other pairs, which do not have a regular market quote, you need to specify the third currency through which the system should compute the exchange rate.

## 13.2 Maintaining Currency Pair Details

The currency pair screen is maintained at the bank level by your Head Office branch using the 'Currency Pair Maintenance' screen.

You can invoke this screen by typing 'CYDCCYPR' in the field at the top right corner of the Application tool bar and clicking the adjoining arrow button.

The screenshot shows the 'Currency Pair Maintenance' application window. It includes an 'Enter Query' button, a 'Currency Pair' section with input fields for 'Currency 1 \*', 'Currency 2 \*', and a 'Through Currency' checkbox. Below this is a 'Through Currency' section with fields for 'Currency Code', 'Currency Name', and a 'Direct Spread Application Required' checkbox. To the right, there are radio button options for 'Number Of Units' (One, Hundred, Thousand), 'Spread Definition' (Percentage, Points), and 'Quotation Method' (Direct, Indirect), along with a 'Points Multiplier' text box set to '1.0000'. The bottom of the window features a 'Fields' section with columns for 'Maker/Checker', 'Date Time', 'Mod No', and 'Record Status/Authorization Status', and an 'Exit' button.

### 13.2.1 System Features

From among the currencies maintained in the currency screen, the system builds all possible combinations of currencies in pairs. For example, if you have maintained the following currency codes: USD, YEN. The system will give you a choice of defining parameters for the following pairs.

- USD-INR

- USD-YEN
- INR-USD
- INR-YEN
- YEN-USD
- YEN-INR

It is however, not obligatory to define parameters for all these pairs. A currency pair needs to be maintained only if:

- You want to define a direct exchange rate for the pair: for frequently traded currencies like INR-USD or USD-GBP or USD-JPY for which market quotes are available.
- You want to define a through currency for the pair: for those currencies which are not so well traded, market quotes may not be available. Therefore you can route the conversion rate for the pair via a 'through currency'. For example, in the case of GBP-NLG, for which a direct exchange rate may not be available, you can define a through currency say, USD. The exchange rate between GBP-USD and NLG-USD will be picked up by the system to compute the exchange rate between GBP-NLG.

In the absence of a direct exchange rate, the system will look for a through currency to compute the rate. If a 'through currency' has not been maintained then the default local currency will be picked up as the through currency to compute the rate for a currency pair.

### 13.2.2 **Maintaining Parameters for Currency Pair**

#### **Currency Pair**

A currency pair (specified as Currency1 and Currency2, in the Currency Pair screen) represents the two currencies for which you need to maintain exchange rates.

To specify the pair, choose from the list provided against Currency1. Select the pair for which you want to maintain parameters.

The pair should be selected according to the quotation method followed by the market, which could be direct or indirect (for details refer to the field 'quotation method'). Exchange rates can be defined for currency1 against currency2 or currency2 against currency1.

The descriptions of the respective currencies are displayed below.

#### **Through Currency**

If the exchange rate for a particular currency pair is not to be maintained, specify the 'Through Currency' via which the exchange rate between the currencies should be calculated.

To maintain a through currency for a currency pair, check against the box 'Through Currency'.

Then choose from the list codes provided against Code, Select the currency code, which you want to specify as the 'through currency'. The exchange rate for the currencies involved in the pair will be calculated using the through currency.

---

#### **Note**

- While maintaining a pair involving an 'In' currency ('In' – 'Out' and 'In' – 'In'), you can only specify the Euro as the 'Through Currency'. Please note that you cannot maintain a 'Through Currency' for a pair constituted by an 'In' currency and the Euro.
- 

*For more details on the manner in which Oracle FLEXCUBE handles the Euro, refer the chapter 'Handling the Euro' in this manual.*

Whenever, you define a through currency for a currency pair, you will not be allowed to specify the following for the pair:

- Number of units
- Spread definition

### **Direct Spread Application Required**

Check this box to indicate if direct spread maintenance is to be used to compute the final rate.

You can select this option only if 'Through Currency' is selected. This is an alternate method to compute exchange rates for currency pairs. The system computes only the mid rate using through currency. The system will pick buy and sell spread from the spread definition and will apply directly to the computed mid rate to get the final buy and sell rates.

### **Quotation Method**

This is the method to be followed for quoting the exchange rate. There are two methods direct and indirect.

In the Direct method the exchange rate for the currency pair is quoted as follows:

Buy rate = mid rate - buy spread

Sell rate = mid rate + sell spread

Ccy 1 = Rate x Ccy 2

In the Indirect method the exchange rate for the currency pair is quoted as follows:

Buy rate = mid rate + buy spread

Sell rate = mid rate - sell spread

Ccy 2 = Rate x Ccy 1

### **Example**

The market follows the direct quote convention for the currency pair USD-DEM e.g., 1USD=1.6051DEM. To maintain this pair, you would specify currency 1 as USD and currency 2 as DEM, and specify "direct" in this field.

For the USD-GBP pair, which is quoted indirectly (1 GBP = 1, 5021 USD), the USD will be defined as currency 1 and the GBP as currency 2, with the quotation method "indirect".

### **Number of Units**

This indicates the number of units of currency to be used for currency conversion

### **Spread Definition**

You need to indicate the method in which the spread for a currency pair needs to be defined. There are two ways of defining the spread -- in points and in percentage.

The effective spread can be calculated using any of the following two methods:

- In points — spread x points multiplier
- In percentage — spread/100 x mid rate

The method of spread definition that you specify here applies to two instances:

- While maintaining exchange rates for this currency pair
- While maintaining Customer Spread for this currency pair

### 13.2.3 Specifying Points Multiplier

Points are the smallest unit of measurement in the exchange rate of a currency pair. If you have opted for a points system of defining spread, you should specify the multiplication factor for the points to compute effective spread.

Suppose for the currency pair USD-DEM your rates are as follows:

Mid-Rate:1.6045

Buy rate:1.6040

Sell rate:1.6051

The effective buy spread is 0.0005 (1.6045 - 1.6040) and the effective sell spread is 0.0006 (1.6051 - 1.6045).

In the Rates screen, where you define rates and spreads for a currency pair, you can specify the buy and sell spreads as 5 and 6 instead of as 0.0005 and 0.0006 (i.e., as spread points), and specify here the points multiplier as 0.0001.

The effective spread, buy and sell rates are then computed as follows:

Effective buy spread = Buy spread x Points multiplier = 5 x 0.0001 = 0.0005

Buy rate= Mid rate - Buy spread = 1.6045 – 0.0005 = 1.6040

---

## 14. Maintaining Exchange Rates

### 14.1 Introduction

In the Currency Rates screen, you can maintain exchange rates for a currency pair, the rates at which you buy and sell one currency for another.

A bank determines its buy and sell rate for a currency pair by applying a spread (i.e., its profit margin) to the mid-rate of the currency pair. Mid rate is the basic rate at which a currency pair is exchanged.

The spread applied for a currency pair varies with the transaction type, while the mid-rate usually remains constant. Consequently, different rates are applicable to different transaction types. For instance dollars in currency are purchased at a certain rate, while USD traveler's checks are bought at a different rate. In Oracle FLEXCUBE, you can define a rate type which you would like to associate with a transaction type e.g., 'CASH', 'TRAVCHKS', etc., in the Rates screen.

### 14.2 Maintaining Currency Rates

In the Currency Rates Maintenance screen, you define the mid-rate, buy and sell spread applicable to each rate type; the buy and sell exchange rates are computed by the system.

Buy rates and sell rates can either be maintained by individual branches or can be input by the HO and propagated to all the branches. If in the Bank-wide parameters - Preferences screen you have specified your preference as 'Use Head Office Exchange Rates' then the header part of currency rates maintained at the bank level by your Head Office will be propagated to the branches. In the Bank-wide Preferences screen, if you have not specified 'copy exchange rate to branches' then the 'Currency Exchange Rates Input' screen is maintained at the branch level by the respective branches.

Modifications of Rates at branch level are allowed even though "Use Head Office Exchange Rates" is enabled at bank level.

You can invoke this screen by typing 'CYDRATEE' in the field at the top right corner of the Application tool bar and clicking the adjoining arrow button.

The screen appears as shown below:

Branch Code: 420  
 Currency 1: AUD  
 Currency 2: JPY  
 Branch Name: コールセンター  
 Currency 1 Name: オーストラリアドル  
 Currency 2 Name: エン

id Rate	Buy Spread	Sell Spread	Buy Rate	Sale Rate	Rate Date	Rate Sequence
97.56	0	0	97.56	97.56	2014-12-11	1
95.778	0	0	95.778	95.778	2014-12-11	1
97.47	200	200	95.47	99.47	2014-12-11	1

Field

Maker: GOPI\_AUTH  
 Checker: GOPI\_MAK  
 Date Time: 2014-12-11 16:13:50  
 Date Time: 2014-12-11 16:15:32  
 Mod No: 1  
 Record Status: Open  
 Authorization Status: Authorized  
 Status

In this screen you maintain the following parameters for each rate type of a currency pair:

- Mid rate
- Buy spread and Sale spread
- Buy rate and Sale rate

Specify the currency pair for which you want to compute the exchange rates. The pair should be selected keeping in mind the quotation method for exchange rates as followed by the market. The system offers the choice of maintaining both the currencies as currency1 or currency 2 -- USD against DEM and DEM against USD.

For the pair specified the following parameters need to be maintained to arrive at the buy and sell rate of currencies:

- Rate Type
- Mid Rate
- Buy Spread
- Sell Spread
- Buy Rate
- Sell Rate

### Rate Type

This is the rate type for which you are maintaining exchange rates for a currency pair. For different transaction categories your bank would like to maintain different exchange rates. For example, traveller's check is purchased at a certain rate whereas a bill of exchange is bought at a different rate.

In the front-end-modules, where you define products to cater to the various transaction types of your bank, you can link an appropriate rate type to the product. For instance, you create a product to cater to outgoing cross currency transfers by SWIFT. For this product, if you define

the rate type to be STANDARD then for all contracts linked to this product, the Standard Rate Type would be applied.

### **Mid Rate**

Mid rate is an indicative exchange rate for a currency pair. It is the average of the buy and sell rate quoted by the market for a currency pair.

For example,

currency 1 = USD

Currency 2 = INR

Buy rate -- 1 USD = 1.7020 INR

Sell rate -- 1 USD = 1.7040 INR

Mid-Rate = 1.7030

### **Buy Spread**

The system displays the buy spread value maintained for the currency pair.

This is the buy spread for a currency pair. It is defined as the profit margin specified over the mid rate when you buy currency 1 for currency2. The buy spread is defined in two ways -- either in points or in percentage. The system computes the effective buy spread for you.

### **Sell Spread**

The system displays the sell spread value maintained for the currency pair.

This is the sell spread for a currency pair. It is defined as the profit margin specified over the mid rate when you sell currency 1 for currency 2. The sell spread is defined either in points or in percentage. The system computes the effective sell spread for you.

### **Buy Rate**

The system displays the buy rate value maintained for the currency pair.

Buy rate is the rate of exchange for a currency pair, which is computed by the system based upon the mid rate, the spread specified, the spread definition and the quotation method maintained in the 'Currency definition' screen.

### **Sale Rate**

The system displays the sale rate value maintained for the currency pair.

Sell rate is the rate of exchange for a currency pair, which is computed by the system based upon the mid rate, the spread specified, the spread definition and the quotation method maintained in the 'Currency definition' screen.

### **Rate Date**

This is a display field. When you enter the exchange rate for a currency pair, the system will default the Rate Date as the Application Date. The rate date will always be less than or equal to the application date.

### **Rate Sequence**

This is a running serial number for the Rate Date. You need to specify the serial number. You entry will be validated for uniqueness. For example, there could be only one exchange rate between USD and EUR for 31/07/2003 with Rate Type STANDARD with Rate Serial as 0001. Thus, this will be a unique rate serial for a currency pair, rate type combination for a given rate date.



When you enter the exchange rate for a currency pair, the system will default the Rate Date as the Application Date and the Rate Serial as the latest available serial for the currency pair + 1. The Rate Serial Number will be system generated. However, you can modify it if required. This number takes into account the Rate Serial Number present in the Currency Rates History screen too. The Rate Serial Number and the Rate Date will be displayed during authorization of the Rate in the Currency Authorization screen.

### Rate Date Update Required

Check this box if rate date has to be updated. The system will refresh the rate date to current application date for the rate type.

If you uncheck this field, then the rate date will continue as old date

## 14.2.1 Authorizing Exchange Rates

Authorization of exchange rates is done from the Currency Exchange Rates input screen. Details like old value, new value for each field (buy rate, mid rate etc) are displayed. Click authorise icon to authorize the record.

## 14.2.2 Revising Exchange Rates

For revising the exchange rates for your bank or the branches invoke the 'Currency Maintenance' screen. Click the currency pair whose exchange rate you want to revise and click unlock icon on the toolbar. Input/modify the new rates for the pair.

## 14.2.3 Viewing Exchange Rates

You can view the exchange rates in the 'Currency Exchange Rates View' screen. You cannot input any values. You also have the option of specifying whether you want to view authorized rates or the unauthorized rates for any currency pair.

You can invoke this screen by typing 'CYSRATEE' in the field at the top right corner of the Application tool bar and clicking the adjoining arrow button.

The screen appears as shown below:

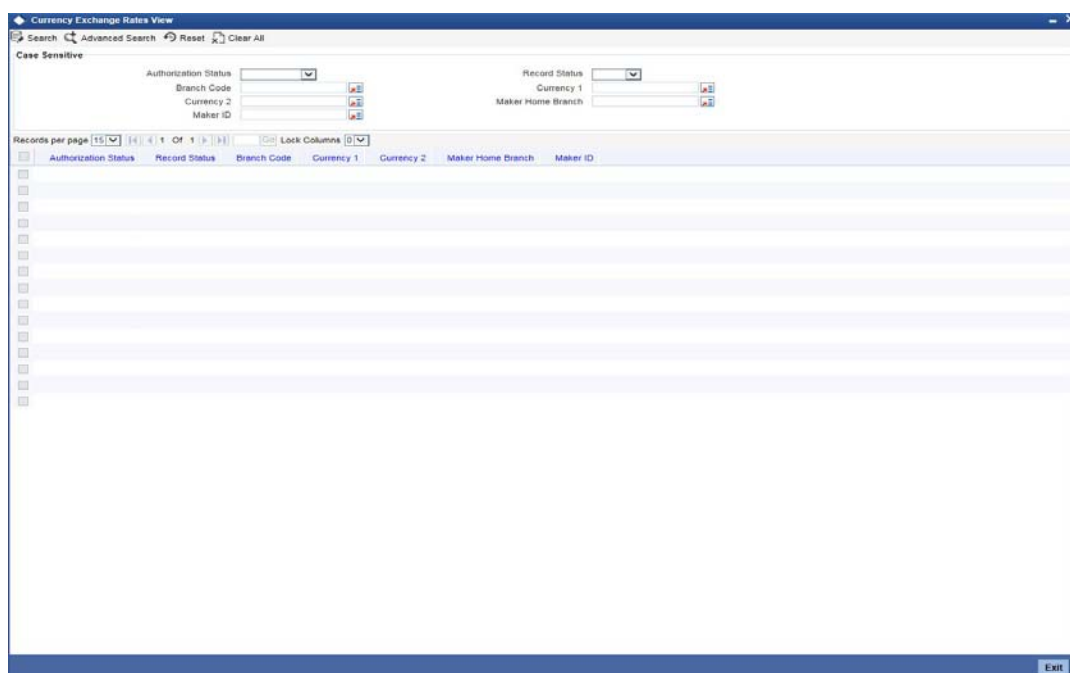

If the branches pick up the exchange rates maintained by the HO, then each time you invoke the 'currency view' screen from a branch it is advisable to update this screen with the latest rate input, from the HO. To do this, click on 'Refresh'. Refresh updates the screen with the last exchange rates input.

You can view records based on any or all of the following criteria:

- Authorization Status
- Record Status
- Branch Code
- Currency 1
- Currency 2
- Maker Home Branch
- Maker ID

Click 'Search' button. The system identifies all records satisfying the specified criteria and displays the following details for each one of them:

- Authorization Status
- Record Status
- Branch Code
- Currency 1
- Currency 2
- Maker Home Branch
- Maker ID

#### 14.2.4 Viewing Currency Batch Rate

You can view the currency batch rates maintained in the system using 'Currency Batch Rate Maintenance' screen.

You can invoke this screen by typing 'CYDBATRT' in the field at the top right corner of the Application tool bar and clicking the adjoining arrow button.

Rate Type	Mid Rate	Buy Spread	Sale Spread	Buy Rate	Sale Rate
-----------	----------	------------	-------------	----------	-----------

You can query on records based on any one or all of the following criteria:

- Branch Code
- Currency

Click 'Execute Query' button. The system identifies all records satisfying the specified criteria and displays the following details for each one of them:

- Rate Type
- Mid Rate
- Buy Spread
- Sale Spread
- Buy Rate
- Sale Rate
- Rate Date

### **14.2.5 Specifying Limits for Cross Currency Transactions**

Typically, the exchange rates applicable for cross currency funds transfer or teller transactions is defaulted by the system depending upon the preference indicated in the product preferences, for the product involving the transaction.

In your bank, for high-value cross currency transactions, you may want the user to manually enter the exchange rate involved, rather than let the system automatically pick up a default rate during transaction input.

You can define such a preference to be applicable to cross currency transactions involving:

- A currency pair
- A specific product, or all products
- A specific module, or all modules
- A specific branch, or all branches
- A specific rate code

The transaction amount limit, above which the exchange rate must be entered, for a high value transaction, could be defined in terms of currency pair where the currency of the transaction is currency1 in the CCY pair defined in the maintenance.

To ensure that users manually enter exchange rates for high-value cross currency transactions in Oracle FLEXCUBE, you must specify the limit amounts that must be validated for each transaction in terms of currency pair, product, module, and branch combination. You can use the 'Product Limits Maintenance' screen to specify the limits.

When you have specified these limits, the system automatically validates the amount with each transaction for the currency pair, product, module and branch combination, and accordingly, if the limits are exceeded, enforces the manual entry of exchange rates.

In case, the limit between ccy1 and ccy2 is given in ccy2, the system will automatically convert the transaction amount to an amount in ccy2 using standard mid rate and check against the limit amount whether or not manual entry of exchange rates is required. You can invoke the 'Product Limits Maintenance' screen, by typing 'CSDPXMNT' in the field at the top right corner of the Application tool bar and clicking the adjoining arrow button.

The screen appears as shown below:

The screenshot shows the 'Product Max Limit' application window. The window title is 'Product Max Limit'. It features a menu bar with 'New' and 'Enter Query'. Below the menu bar are five input fields: 'Branch Code \*', 'Module Code \*', 'Product Code \*', 'Currency 1 \*', and 'Currency 2 \*', each with a dropdown arrow icon. The 'Limit Details' section contains a table with three columns: 'Rate Code \*', 'Limit Currency \*', and 'Limit Amount \*'. The table has one row with empty input fields. At the bottom, there is a 'Fields' section with 'Input By Date Time', 'Authorized By Date Time', and 'Modification Number'. Below these are two checkboxes: 'Authorized' and 'Open'.

### Branch Code

You must specify the branch for which the limit amount will be applicable. You can specify that the limits must be applicable for all branches.

### Module Code

You must specify the module for which the limit amount will be applicable. You can indicate that these limits must be applicable for both the Data Entry (DE) and Funds Transfer (FT) modules.

### Product Code

You must specify the product, transactions involving which the limit amount will be applicable. You can specify that the limits must be applicable for all products.

### Currency 1

You need to specify the currency1 applicable for defining the Transaction Amount limit, beyond which the system will not default the Auto Exchange Rate.

All valid currencies defined in the Currency Pair Maintenance will appear for selection. This currency is always the transaction currency of the contract.

### Currency2

You need to specify the currency2 applicable for defining the Transaction Amount limit, beyond which the system will not default the Auto Exchange Rate.

All valid currencies defined in the Currency Pair Maintenance will appear for selection. The Currency2 should be part of a Currency Pair Maintenance in which the Currency1 defined here is the first currency. Currency 2 can be specified as ALL.

### **14.2.5.1 Specifying Limit Details**

#### **Rate Code**

You need to specify the Rate Type (code) for the Exchange Rate Limit

#### **Limit Currency**

You need to specify the currency in which the Limit Amount should be expressed. All valid currencies defined in the system will be applicable for selection. There will be a validation for the limit currency as either Currency1 or Currency2.

#### **Limit Amount**

You need to specify the maximum amount up to which the system should default the Exchange Rate or perform the Rate Variance validation.

### **14.2.5.2 Validating Exchange Rate Limits**

The Funds Transfer Contract Input will default the Rate only if the Transaction Amount is less than the Maximum Amount defined for the Rate Code maintained at the product level for FT. If the amount is more than the specified amount, then the system will not default the Rate. Instead, it will force the user to enter the Rate. Once the user enters the Rate, the system will not add the Customer Spread etc. as this will be final Exchange Rate for the contract.

The Rate Variance validation will also be done only if the amount is less than the maximum amount defined for the Rate Code maintained at the product level for FT. If the amount is more than the specified amount, the system will not perform the Rate Variance validation. Instead, there will be an override to specify that the transaction amount is greater than the maximum amount for Rate Variance check.

*For details about how limits are applied when a transaction is entered, refer the chapter Processing a Funds Transfer, in the Funds Transfer user manual.*

## **14.3 Currency Manual Exchange Rate Maintenance**

You can maintain exchange rates for a specific Rate type of a currency pair using Currency Manual Exchange Rate Maintenance (CYDMRTMT) screen.

You can maintain the exchange rate for Rate types of a currency pair those are part of periodic upload (through Excel / Macro upload) with existing Currency Exchange Rates Input (CYDRATEE) and not through this Currency Manual Exchange Rate Maintenance (CYDMRTMT) screen.

#### **Branch Code**

Specify the branch code which the currency pair and Rate type is being modified.

#### **Rate Type**

Specify the Rate type of the currency Pair.

#### **Currency 1 and Currency 2**

Specify the Currency pair to be modified.

The system will result with the result of the query only if the given Rate type is maintained and is not a part of periodic upload of the currency exchange rate (CYDRATEE).

You can amend the resulted details. You can also amend the below mentioned fields during modification action.

#### **Mid Rate**

Specify the mid rate. Mid rate is an indicative exchange rate for a currency pair. It is the average of the buy and sell rate quoted by the market for a currency pair.

#### **Rate Date Update Required**

Check this box if rate date has to be updated. The system will referesh the rate date to current application date for the rate type.

If you uncheck this field, then the rate date will continue as old date.

#### **Enrich Button (optional)**

On clicking 'Enrich' button, the system will calculate buy and sell rate using the buy and sell spread for the currency pair maintained in the Currency Spread Definition (CYDSPRDF)

---

**Note**The Rate type for a currency pair maintained in this Currency Manual Exchange Rate Input (CYDMRTMT) screen will not be able to query or maintain in Currency Exchange Rate Input (CYDRATEE) screen and vice-versa.



## **14.4 Maintaining Currency Position Threshold Limits**

You can view the various foreign currency positions of the bank and define the threshold limits for currencies at different levels using the 'Currency Position Threshold Limits' screen. When the threshold levels are is reached, an automated warning is displayed.

You can invoke the 'Currency Position Threshold Limits' screen, by typing 'CYDCYTHR' in the field at the top right corner of the Application tool bar and clicking the adjoining arrow button.

The screenshot shows the 'Currency Position Threshold Limits' application window. The window has a title bar with a diamond icon and the text 'Currency Position Threshold Limits'. Below the title bar is a toolbar with 'New' and 'Enter Query' buttons. The main area contains several input fields: 'Branch Code \*', 'Branch Name', 'GL Class Code \*', and 'GL Class Name'. There is also a 'Severity' dropdown menu set to 'Low'. Below these fields is a data grid with columns for 'CCY Code', 'Buy Threshold', and 'Sell Threshold'. The grid is currently empty. At the bottom of the window is a status bar with fields for 'Maker', 'Checker', 'Date Time', 'Mod No', 'Record Status', 'Authorization Status', and an 'Exit' button.

Maintain the following details:

#### **Branch Code**

Specify the branch code for which threshold is to be maintained. Alternatively, you can select the branch code from the option list. The list displays all valid branch codes maintained at the bank level.

You can also select 'ALL' to select all the branch codes listed.

#### **Branch Name**

Based on the branch code selected, system displays the branch name.

#### **GL Class Code**

Specify the GL class code for which threshold limits are to be maintained. Alternatively, you can select the GL class code from the option list. The list displays all valid GL class codes maintained for the selected branch in 'GL Class Maintenance' (STDGLCMT) screen.

#### **GL Class Name**

Based on the GL class code selected, system displays the GL Class Name.

#### **Transaction Code Class**

Specify the class code for the transaction code class. Alternatively, you can select the transaction code class from the option list. The list displays the valid transaction code class maintained in the system.

#### **Transaction Code Class Name**

The system displays the name of the Transaction Code Class selected.

#### **Threshold Type**

Select the threshold type from the drop-down list. The list displays the following values:

- Cumulative: This option indicates that the threshold maintained will apply for cumulative position monitoring using the 'CYDCCYPE' screen.
- Daily: This option indicates that the threshold maintained will apply for daily position monitoring using 'CYDTRPOS' screen.

Click '+' to define the threshold limits for different currencies.

### **CCY Code**

Specify the currency code for which the buy and sell threshold limits are to be maintained. Alternatively, you can select the currency code from the option list. The list displays all valid currencies maintained for the selected branch.

### **Buy Threshold**

Specify the limit amount in the currency being maintained to indicate the threshold for net buy position. If the net balance of the currency is in credit and exceeds this amount, a warning is displayed.

### **Sell Threshold**

Specify the limit amount in the currency being maintained to indicate the threshold for net sell position. If the net balance of the currency is in debit and exceeds this amount, a warning is displayed.

- 

### **Severity**

Select the type of severity from the drop-down list. The list displays the following values:

- Low
- Medium
- High

During save, if the maintenance for the Threshold Type is 'Cumulative', the system will overwrite the Transaction code Class as '\*\*\*' if the value is other than '\*\*\*'. Threshold Type 'Cumulative' is allowed to have '\*\*\*' as the Transaction Code Class value.



## 14.4.1 Viewing Currency Position Threshold Limits Summary

You can view the various currency threshold limits maintained in the system using 'Currency Position Threshold Limits' screen. You can invoke this screen, by typing 'CYSCYTHR' in the field at the top right corner of the Application tool bar and clicking the adjoining arrow button.

The screenshot shows the 'Currency Position Threshold Limits' application window. The window title is 'Currency Position Threshold Limits'. It features a search bar with 'Search', 'Advanced Search', 'Reset', and 'Clear All' buttons. Below the search bar is a 'Case Sensitive' section with dropdown menus for 'Authorization Status', 'Record Status', 'GL Class Code', and 'Branch Code', and a 'Severity' dropdown. A table below shows columns for 'Authorization Status', 'Record Status', 'GL Class Code', 'Branch Code', and 'Severity'. The table is currently empty. At the bottom right, there is an 'Exit' button.

You can query on records based on any one or all of the following criteria:

- Authorization Status
  - Authorized
  - Unauthorized
  - Rejected
- GL Class Code
- Record Status
  - Open
  - Closed
- Branch Code
- Threshold Type
  - Daily
  - Cumulative
- Transaction Code Class

Click 'Execute Query' button. The system identifies all records satisfying the specified criteria and displays the following details for each one of them:

- Authorization Status
- Record Status
- GL Class Code

- Branch Code
- Threshold Type
- Transaction Code Class

## 14.4.2 Viewing Currency Position

You can view the various currency positions maintained in the system using the 'Currency Position' screen.

You can invoke this screen, by typing 'CYDCCYPE' in the field at the top right corner of the Application tool bar and clicking the adjoining arrow button.

You can query on records based on any one or all of the following criteria:

- Branch Code
- GL Class Code

Click 'Search' button. The system identifies all records satisfying the specified criteria and displays the latest extracted currency position of real GLs and contingent GLs in different tabs with the following details:

- CCY Code
- Buy Threshold Limit
- Sell Threshold Limit
- Currency Position
- Currency Position LCY Eqv
- Breach

---

**Note**

- If the Threshold Type is maintained as 'Cumulative' in 'Currency Position Threshold Limits Maintenance' screen (CYDCYTHR), the system displays the position for the 'Transaction Code Class' as '\*\*\*\*'.
  - During save, the system allows the Threshold Type 'Cumulative' to have '\*\*\*\*' as the Transaction Code Class value.
- 

The Breach column indicates the threshold limit status in the following colour combinations:

- Red indicates, Buy/Sell - High or Medium or Low level breach.
- Green indicates, Buy/Sell Limit has not been breached.

If the net balance of the currency results in credit, then its a buy breach. Similarly, if the net balance of the currency results in debit, then its a sell breach.

You can also click 'Refresh' to fetch the latest currency position.

## 14.5 CYBOSBT Batch

You can extract currency positions and compute average exchange rates using CYBOSBT batch. This batch program will always be run from the head office branch. The batch program will run one cycle of position extraction for each branch and GL class maintained in the currency threshold maintenance. Following are the steps followed by this batch program:

For each open and authorized branch code and GL class combination in currency threshold maintenance, the batch will perform the following steps:

For all real GLs in the list, the batch will perform the following steps:

1. For Customer GLs in the list, identify all open customer accounts that have these GLs as either a debit GL or a credit GL and have at-least one transaction in the daily accounting data store for the branch for a foreign currency.
2. For internal GLs, identify all such GLs in the list that have at-least one transaction in the daily accounting data store for the branch for a foreign currency.
3. From daily accounting data store, sum up the foreign currency amount and local currency amount from foreign currency transactions, whose balances have been successfully updated, involving the GLs and customer accounts identified in steps (1) and (2) above for each currency and transaction type (Debit and Credit)
4. The sum of debit transactions for a currency will be the buy amount (foreign currency and local currency) and the sum of credit transactions for a currency will be the sell amount (foreign currency and local currency).
5. If in the threshold maintenance, the branch code is "\*\*\*\*", then in steps (1), (2) and (3), the branch code will be ignored while identifying customer accounts and transactions and accounts and transactions across all branches of the bank will be used.

For contingent GLs in the list of GLs linked to the GL class, the batch will perform the following steps:

1. Identify all such contingent GLs in the list that has at-least one transaction in the daily accounting data store for the branch for a foreign currency.
2. From daily accounting data store, sum up the foreign currency amount and local currency amount from foreign currency transactions, whose balances have been successfully updated, involving the contingent GLs for each currency and transaction type (Debit and Credit)

3. The sum of debit transactions for a currency will be the contingent buy amount (foreign currency and local currency) and the sum of credit transactions for a currency will be the contingent sell amount (foreign currency and local currency).
4. If in the threshold maintenance, the branch code is "\*\*\*\*", then in steps (1) and (2), the branch code will be ignored while identifying transactions and transactions across all branches of the bank will be used.

Once all the GLs in the GL class have been processed, then the system will insert a row in a new data store with the following fields. If there are already rows for the Branch Code, GL Class, Currency Code and Date combination in the data store, the system will delete these rows before new rows are inserted. Deleted rows will not be archived.

- Branch Code: The branch code for which position is being extracted.
- GL Class: The GL class for which position is being extracted
- Currency Code: : The currency for which position is being extracted
- Date: The application date.
- Foreign Currency Amount (Buy): The summed up value of foreign currency amount for all debit transactions involving real internal GLs and customer accounts.
- Local Currency Amount (Buy): The summed up value of local currency amount for all debit transactions involving real internal GLs and customer accounts.
- Average Exchange Rate (Buy): Average Exchange Rate (Buy) would be computed based on the quotation method maintained for the foreign currency – local currency pair. The steps to be followed will be as follows:

- Quotation Method is Direct: In this case, the computation of exchange rate will be as follows:

$$\text{Average Exchange Rate (Buy)} = \frac{\text{Local Currency Amount (Buy)}}{\text{Foreign Currency Amount (Buy)}}$$

- Quotation Method is In-Direct: In this case, the computation of exchange rate would be as follows:

$$\text{Average Exchange Rate (Buy)} = \frac{\text{Foreign Currency Amount (Buy)}}{\text{Local Currency Amount (Buy)}}$$

This value would be rounded down to 3 decimal places.

- Foreign Currency Amount (Sell): The summed up value of foreign currency amount for all credit transactions involving real internal GLs and customer accounts.
- Local Currency Amount (Sell): The summed up value of local currency amount for all credit transactions involving real internal GLs and customer accounts.
- Average Exchange Rate (Sell): Average Exchange Rate (Sell) will be computed based on the quotation method maintained for the foreign currency – local currency pair. The steps to be followed would be as below:

- Quotation Method is Direct: In this case, the computation of exchange rate will be as follows:

$$\text{Average Exchange Rate (Sell)} = \frac{\text{Local Currency Amount (Sell)}}{\text{Foreign Currency Amount (Sell)}}$$

- Quotation Method is In-Direct: In this case, the computation of exchange rate would be as follows:

$$\text{Average Exchange Rate (Sell)} = \frac{\text{Foreign Currency Amount (Sell)}}{\text{Local Currency Amount (Sell)}}$$

This value would be rounded down to 3 decimal places.

- Foreign Currency Amount (Net): This value will be computed by subtracting Foreign Currency Amount (Sell) from Foreign Currency Amount (Buy).

Foreign Currency Amount (Net) = Foreign Currency Amount (Buy) – Foreign Currency Amount (Sell)

- Local Currency Amount (Net): This value will be computed by subtracting Local Currency Amount (Sell) from Local Currency Amount (Buy).

Local Currency Amount (Net) = Local Currency Amount (Buy) – Local Currency Amount (Sell)

- Average Exchange Rate (Net): Average Exchange Rate (Net) will be computed based on the quotation method maintained for the foreign currency – local currency pair. The steps to be followed will be as below:

- Quotation Method is Direct: In this case, the computation of exchange rate will be as follows:

Average Exchange Rate (Net) =  $\frac{\text{Local Currency Amount (Net)}}{\text{Foreign Currency Amount (Net)}}$

- Quotation Method is In-Direct: In this case, the computation of exchange rate would be as follows:

Average Exchange Rate (Net) =  $\frac{\text{Foreign Currency Amount (Net)}}{\text{Local Currency Amount (Net)}}$

This value would be rounded down to 3 decimal places.

- Contingent Foreign Currency Amount (Buy): The summed value of foreign currency amount for all debit transactions involving Contingent GLs.
- Contingent Local Currency Amount (Buy): The summed value of local currency amount for all debit transactions involving contingent GLs.
- Contingent Average Exchange Rate (Buy): Contingent Average Exchange Rate (Buy) will be computed based on the quotation method maintained for the foreign currency – local currency pair. The steps to be followed would be as below:

- Quotation Method is Direct: In this case, the computation of exchange rate will be as follows:

Contingent Average Exchange Rate (Buy) =  $\frac{\text{Contingent Local Currency Amount (Buy)}}{\text{Contingent Foreign Currency Amount (Buy)}}$

- Quotation Method is In-Direct: In this case, the computation of exchange rate would be as follows:

Contingent Average Exchange Rate (Buy) =  $\frac{\text{Contingent Foreign Currency Amount (Buy)}}{\text{Contingent Local Currency Amount (Buy)}}$

This value would be rounded down to 3 decimal places.

- Contingent Foreign Currency Amount (Sell): The summed up value of foreign currency amount for all credit transactions involving contingent GLs.
- Contingent Local Currency Amount (Sell): The summed up value of local currency amount for all credit transactions involving contingent GLs involving contingent GLs.
- Contingent Average Exchange Rate (Sell): Contingent Average Exchange Rate (Sell) would be computed based on the quotation method maintained for the foreign currency – local currency pair. The steps to be followed would be as below:
- Quotation Method is Direct: In this case, the computation of exchange rate will be as follows:

Contingent Average Exchange Rate (Sell) =  $(\text{Contingent Local Currency Amount (Sell)}) / (\text{Contingent Foreign Currency Amount (Sell)})$

- Quotation Method is In-Direct: In this case, the computation of exchange rate would be as follows:

Contingent Average Exchange Rate (Sell) =  $(\text{Contingent Foreign Currency Amount (Sell)}) / (\text{Contingent Local Currency Amount (Sell)})$

This value would be rounded down to 3 decimal places.

- Contingent Foreign Currency Amount (Net): This value will be computed by subtracting Contingent Foreign Currency Amount (Sell) from Contingent Foreign Currency Amount (Buy).

Contingent Foreign Currency Amount (Net) = Contingent Foreign Currency Amount (Buy) – Contingent Foreign Currency Amount (Sell)

- Contingent Local Currency Amount (Net): This value will be computed by subtracting Contingent Local Currency Amount (Sell) from Contingent Local Currency Amount (Buy).

Contingent Local Currency Amount (Net) = Contingent Local Currency Amount (Buy) – Contingent Local Currency Amount (Sell)

- Contingent Average Exchange Rate (Net): Contingent Average Exchange Rate (Net) will be computed based on the quotation method maintained for the foreign currency – local currency pair. The steps to be followed will be as below:

- Quotation Method is Direct: In this case, the computation of exchange rate will be as follows:

Contingent Average Exchange Rate (Net) =  $(\text{Contingent Local Currency Amount (Net)}) / (\text{Contingent Foreign Currency Amount (Net)})$

- Quotation Method is In-Direct: In this case, the computation of exchange rate would be as follows:

Contingent Average Exchange Rate (Net) =  $(\text{Contingent Foreign Currency Amount (Net)}) / (\text{Contingent Local Currency Amount (Net)})$

This value would be rounded down to 3 decimal places.

The new batch program described above will have to be scheduled to run at a desired frequency. The data stored by the last run of the batch before date change will be stored as the closing position for the date.

CYBPOSBT batch can be used to compute the Foreign Currency Positions based on the 'Transaction Code Class' configured in the 'Currency Position Threshold Limits Maintenance' screen (CYDCYTHR) for Threshold type as 'Daily'. CYBPOSBT batch can process with 3 minutes as execution time for a single Currency Position Threshold Limits Maintenance (CYDCYTHR) for Threshold type 'Daily'.

## 14.6 CYBCYPOB Batch

CYBCYPOB is an automated intra-day batch process extracts the latest exchange rate and store it as batch rate. The same is considered as frozen exchange rates for batch operations.

To extract the currency rates for Branches which does not use head office exchange rates, you need to login into the respective branch where the branch setup and execute the Batch. For branches which use head office exchange rates, you need to run the batch at Head office level.

CYBCYPOB can also be triggered at the head office level, which extracts and stores the GL balance for various currencies.

CYBCYPOB batch can be used compute the Foreign Currency Positions based on the Transaction Code Class '\*\*\*' as configured in the 'Currency Position Threshold Limits Maintenance' screen (CYDCYTHR) for Threshold type 'Cumulative'.

## 14.7 Transaction Currency Position

You can view currency position and indicate breach of the currency position as and when required using 'Transaction Currency Position' screen. You can view the currency positions for both current and historical positions. Where, Current indicates the current position to be viewed and Historical indicates the historical position to be viewed. If historical position is to be viewed, then you need to choose the date for which position is to be viewed.

You can invoke 'Transaction Currency Position' screen by typing 'CYDTRPOS' in the field at the top right corner of the Application tool bar and clicking the adjoining arrow button.



You can specify the following details:

### **Branch Code**

Specify the branch code. Alternatively, you can select branch code from the option list. The list displays all valid branch code maintained in the system.

### **Branch Name**

The system displays the name of the branch for the selected branch code.

### **GL Class Code**

Specify the GL Class code for which the position is required. Alternatively, you can select GL class code from the option list. The list displays all valid GL class code maintained in the system.

### **GL Class Name**

The system displays the GL Class name for the selected GL Class code.

### **Transaction Code Class**

Specify the class code for the transaction code class. Alternatively, you can select the transaction code class from the option list. The list displays the valid transaction code class maintained in the system. By default the system displays the transaction code class as 'FXPOSDFLT' during query. However, you can change it.

### **Transaction Code Class Name**

The system displays the name of the Transaction Code Class selected.

### **Position Date**

The system displays the date of position.

### **Search Criteria**

Select the search criteria from the drop-down list. The list displays the following values:

- Current: Indicating that current position is to be viewed
- Historical: Indicating that historical position is to be viewed. If historical position is to be viewed, then you need to choose the date for which position is to be viewed.

Clicking 'Fetch/Refresh' button, the system will fetch data for the search criteria provided from the data store populated by the batch (CYBPOSBT).

Click 'Refresh' button to refresh the screen by re-querying the back end data store with the search criteria already present. It will not re-execute the new batch program.

## **14.7.0.1 Real Tab**

Click 'Real' tab in 'Transaction Position Currency' screen.



Based on the search criteria, the system displays the following values:

### **Currency Code**

The system displays the currency code for which the position is being displayed.

### **Buy Amount (FCY)**

The system displays the sum of foreign currency amount of Debit transactions for a currency.



**Buy Amount (LCY)**

The system displays the sum of local currency amount of debit transactions for a currency.

**Average Rate (Buy)**

The system displays the average exchange rate for Buy Amount.

**Sell Amount (FCY)**

The system displays the sum of foreign currency amount of credit transactions for a currency.

**Sell Amount (LCY)**

The system displays the sum of local Currency amount of Credit transactions for a currency.

**Average Rate (Sell)**

The system displays the average exchange Rate for Sell Amount.

**Net Amount (FCY)**

The system displays the sum of foreign Currency amount for net of debit and credit transactions for a currency.

**Net Amount (LCY)**

The system displays the sum of local Currency amount of net of debit and credit transactions for a currency.

**Average Rate (Net)**

The system displays the average exchange rate for net amount.

**Breach Indicator**

The system displays whether the currency position threshold has been breached or not with two indicators, namely, a colour code and a text value.

The colour code indicates the severity of the breach.

- Yellow indicates Low Severity
- Orange indicates Medium Severity, and
- Red indicates High Severity.
- Green indicates that there is no breach of threshold.

The text in the field indicates if Buy Threshold or Sell threshold has been breached. If buy threshold has been breached, then the text 'BUY' will be displayed and if sell threshold has been breached, then 'SELL' will be displayed.

## 14.7.0.2 Contingent Tab

Click 'Contingent' tab in 'Transaction Position Currency' screen.



Based on the search criteria, the system displays the following values:

### **Currency Code**

The system displays the currency code for which the position is being displayed.

### **Contingent Buy Amount (FCY)**

The system displays the sum of foreign Currency amount for net of debit transactions for a currency for Contingent GLs.

### **Contingent Buy Amount (LCY)**

The system displays the sum of local Currency amount of debit transactions for a currency for contingent GL.

### **Contingent Average Rate (Buy)**

The system displays the average exchange rate for Contingent Buy Amount.

### **Contingent Sell Amount (FCY)**

The system displays the sum of foreign Currency amount for credit transactions for a currency for Contingent GLs.

### **Contingent Sell Amount (LCY)**

The system displays the sum of local Currency amount of Credit transactions for a currency for contingent GLs.

### **Contingent Average Rate (Sell)**

The system displays the average exchange Rate for Contingent Sell Amount.

### **Contingent Net Amount (FCY)**

The system displays the sum of foreign Currency amount for net of debit and credit transactions for a currency for Contingent GLs.

### **Contingent Net Amount (LCY)**

The system displays the sum of local Currency amount for net of debit and Credit transactions for a currency for contingent GLs.

### **Contingent Average Rate (Net)**

The system displays the average exchange rate for contingent net amount.

### **Breach Indicator**

The system displays whether the currency position threshold has been breached or not with two indicators, namely, a colour code and a text value.

The colour code indicates the severity of the breach.

- Yellow indicates Low Severity
- Orange indicates Medium Severity, and
- Red indicates High Severity.
- Green indicates that there is no breach of threshold.

The text in the field indicates if Buy Threshold or Sell threshold has been breached. If buy threshold has been breached, then the text 'BUY' will be displayed and if sell threshold has been breached, then 'SELL' will be displayed.

---

#### **Note**

If contingent GLs are not included as part of the GL class, then this tab would not have any rows.

---

To check if the threshold is breached, the system will consider the Net FCY amount. for Real GLs, the amount will be Net Amount (FCY) and for contingent GLs, it will be Contingent Net Amount (FCY) for a currency.

To check if the threshold is breached or not, the system will first check for the threshold amount based on the branch code, GL class, Threshold type and currency. In this case, the threshold type will always be 'Daily'. If no threshold is maintained, then the threshold will be assumed to be zero.

Net Amount (FCY) and Contingent Net Amount (FCY) will be signed amounts. If these amounts are negative, then it indicates BUY position and if these amounts are positive it indicates SELL position.

In case of Real GLs and Accounts, you can determine if a threshold is breached or not as follows:

- If for a currency, the Net Amount (FCY) is negative then the system will compare its absolute value to compare against the Sell Threshold maintained for that currency in the following order:
  - If the ABS (Net Amount (FCY)) is less than or equal to Low Severity Amount, then there is no breach, the breach field for that row would be filled in Green with no text value.
  - If the ABS (Net Amount (FCY)) is greater than Low Severity Amount but less than or equal to medium severity amount for the currency, then there is a low severity breach. The breach field would be filled with Yellow colour and text value will be set to 'SELL'
  - If the ABS (Net Amount (FCY)) is greater than Medium Severity amount but less than or equal to High Severity Amount for the currency, then there is a Medium

Severity Breach. The breach field will be filled with Orange Colour and text value will be set to 'SELL'

- If the ABS (Net Amount (FCY)) is greater High Severity Amount, then there is a high severity breach. The breach field will be set to Red Colour and text value will be set to 'SELL'
- If for a currency, the Net Amount (FCY) is greater than or equal to zero, then the value will be directly compared against the Buy Threshold maintained for that currency in the following order:
  - If the Net Amount (FCY) is less than or equal to Low Severity Amount, then there is no breach, the breach field for that row will be filled in Green with no text value.
  - If the Net Amount (FCY) is greater than Low Severity Amount but less than or equal to medium severity amount for the currency, then there is a low severity breach. The breach field will be filled with Yellow colour and text value will be set to 'BUY'
  - If the Net Amount (FCY) is greater than Medium Severity amount but less than or equal to High Severity Amount for the currency, then there is a Medium Severity Breach. The breach field will be filled with Orange Colour and text value will be set to 'BUY'
  - If the Net Amount (FCY) is greater High Severity Amount, then there is a high severity breach. The breach field will be set to Red Colour and text value will be set to 'BUY'

---

**Note**

Similar steps will be followed for Contingent GLs. The only difference in case of Contingent GLs will be that the amount being compared to threshold amounts maintained will be Contingent Net Amount (FCY). All the other steps would remain the same.

---

---

# 15. Maintaining Currency Spread for Customer

## 15.1 Maintaining Currency Spread

You can maintain currency pair-wise spreads in the 'Currency Spread Definition' screen for those branches which does not follow the Head Office currency exchange rates. However, this condition is not applicable if your current branch itself is the head office.

All defined currency pairs including those currency pairs that have a through currency will be available for spread maintenance.

You can invoke this screen by typing 'CYDSPRDF' in the field at the top right corner of the Application tool bar and clicking the adjoining arrow button.

The screenshot shows the 'Currency Spread Definition' application window. The window has a title bar with a diamond icon and the text 'Currency Spread Definition'. Below the title bar is a toolbar with 'New' and 'Enter Query' buttons. The main area contains several input fields: 'Branch Code \*', 'Currency 1 \*', 'Currency 2', 'Spread Definition', 'Quotation', 'Branch Name', 'Currency 1 Name', 'Currency 2 Name', and 'Points Multiplier'. Below these fields is a table with columns for 'Rate Type', 'Buy Spread', and 'Sell Spread'. The table is currently empty. At the bottom of the window is a status bar with fields for 'Maker', 'Checker', 'Date Time', 'Mod No', 'Record Status', 'Authorization Status', and an 'Exit' button.

Specify the following details:

### **Branch Code**

Specify the branch code. Alternatively, you can select the branch code from the option list. The list displays all valid branch codes maintained at the bank level.

---

### **Note**

System display only those branch codes for which the 'Use Head Office Exchange Rates' option is not selected in 'Bank Parameters Maintenance' (STDBNKPM) screen. However, for Head office Branch, this condition is not applicable and is listed for selection

---

### **Currency 1**

Specify the currency for which you to maintain spread. Alternatively, you can select the currency from the option list. The list displays all valid currencies maintained at the bank level.

### **Currency 2**

The system displays the second currency based on the branch code and currency code selected,

**Spread Definition**

The system displays the spread as either points or percentage based on the currency pair combination maintained at bank parameter level.

**Quotation**

The system displays the Quotation method values based on the branch code and currency code selected,

**Branch Name**

The system displays the branch name based on the branch code and currency code selected,

**Currency 1 Name**

The system displays the name of the first currency pair based on the currency code selected.

**Currency 2 Name**

The system displays the name of the second currency pair based on the currency code selected.

**Points Multiplier**

The system displays the points multiplier values from the currency pair definition based on the branch code and currency code selected,

**Rate Type**

Specify the Rate Type. Alternatively, you can select the rate type from the option list. The list displays all valid rate type maintained at the bank level.

**Buy Spread**

This is the buy spread for a currency pair. It can be defined as the profit margin specified over the mid rate when you buy currency 1 for currency2. You can define the buy spread in two ways, either in points or in percentage. The system computes the effective buy spread for you.

**Sell Spread**

This is the sell spread for a currency pair. It can be defined as the profit margin specified over the mid rate when you sell currency 1 for currency 2. You can define the sell spread either in points or in percentage. The system computes the effective sell spread for you.

---

**Note**

Currency Spread maintained through 'Currency Spread Definition' (CYDSPRDF) screen can be in decimals but has to be in positive integer. You can upload Upload Currency Spread for new and update records using a macro enabled Microsoft excel file.

---

## 15.2 Maintaining Customer Spread Details

For a customer and currency pair, you can maintain tenor-wise spread details in the 'Customer Spread Maintenance' screen.

You can invoke this screen by typing 'CYDCUSPR' in the field at the top right corner of the Application tool bar and clicking the adjoining arrow button.

The screenshot shows the 'Customer Currency Spread Maintenance' application window. At the top, there are buttons for 'New' and 'Enter Query'. Below these are several input fields: 'Branch \*', 'Customer \*', 'Currency 1 \*', and 'Currency 2 \*'. To the right of these fields is a 'Spread Definition' dropdown menu currently set to 'Percentage'. The main content area is titled 'Customer Spread Details' and contains a table with three columns: 'Tenor', 'Buy Spread', and 'Sale Spread'. The 'Tenor' column has a red asterisk next to it. Below the table is a horizontal scrollbar. At the bottom of the window, there is a 'Fields' section with checkboxes for 'Input By Date Time', 'Authorized By Date Time', 'Modification Number', 'Authorized', and 'Open', and an 'Exit' button.

In this screen, for a customer and currency pair, you can maintain buy and sell spreads for different tenors.

You need to maintain customer spreads in each branch. Transactions initiated in a branch will pick up the spread(s) maintained for that branch.

---

#### Note

- Funds Transfer, Loans and Deposit contracts have tenor = 0 (zero). Therefore, you need to maintain Customer Spreads for zero tenor also.
  - The tenor is specified in days
- 

### 15.2.0.1 Specifying Spread Details

When processing an FX deal involving a customer (for whom you have maintained spread details), the system picks up the customer spread corresponding to the tenor of the deal and builds it into the exchange rate. If spread details are unavailable for a specific tenor, the system picks up the spread defined for the nearest lower tenor.

For example, assume for a customer and currency pair you maintain spread details for the following tenors: '3', '5', and '10' days. When processing a deal with a tenor of '4' days (involving the customer and the currency pair), the system picks up the spread details defined for a tenor of three days. This is because spread details for a '4' day tenor is unavailable for the customer and currency pair.

---

#### Note

You can also maintain customer spreads for the wildcard entry – ALL. If spread details for a specific counterparty (for the currency pair) are unavailable, the System looks for the customer spread maintained for the wildcard ALL entry. If even that is not available, then the customer spread defaults to zero.

---

## 15.2.1 Computing Buy and Sell Spreads

**Using percentage system** -- suppose the bank wants to make a profit of 5% over and above the mid rate quoted. Suppose the dealing currencies are USD and AUD. 1USD = 1.4166 AUD for Standard rate type. (Mid rate being 1.4166). Now to arrive at the spread the bank will use the following formula:

$$\text{Spread} = 5 / 100 \times \text{Mid rate (1.4166)} = 0.07083$$

**Using the points system** -- suppose the point quoted by the bank is 708.3. The points multiplier in this case would be 0.0001 (depends on the decimal points that the mid rate extends to. Usually it is 4 decimal places).

$$\text{Spread} = \text{Points (708.3)} \times \text{Points Multiplier (0.0001)}$$

Now coming to the buy and sale rate computing, there are two ways of computing the buy and sale rates -- Direct and Indirect. Depending upon the quotation method you have specified in the Currency pair screen, the system computes the spreads.

In the **Direct** method, the buy and sell rates are calculated as follows:

$$\text{Buy Rate} = \text{Mid-Rate} - \text{Buy Spread}$$

$$\text{Sell Rate} = \text{Mid-Rate} + \text{Sell Spread}$$

For cross currency contracts, the rate for the currency pair is:

$$1 \text{ unit of Ccy 1} = \text{Rate} * 1 \text{ unit of Ccy 2}$$

In the **Indirect** method, the buy and sell rates are calculated as follows:

$$\text{Buy Rate} = \text{Mid-Rate} + \text{Buy Spread}$$

$$\text{Sell Rate} = \text{Mid-Rate} - \text{Sell Spread}$$

For cross currency contracts, the rate for the currency pair is:

$$1 \text{ unit of Ccy 2} = \text{Rate} * 1 \text{ unit of Ccy 2}$$

The method of spread definition – percentage or points – that you have maintained for the currency pair is displayed on this screen.

## 15.2.2 Maintaining Currency Margins for Customer

For each customer of your bank you can define buy and sell margins for a specific currency. This spread is applied to floating interest components that involve the customer and currency combination.

You can define buy and sell margins for a customer in the Customer Spread Maintenance screen invoked from the Application Browser. You can invoke this screen by typing 'CFDCUMRG' in the field at the top right corner of the Application tool bar and clicking the adjoining arrow button.

The margin that you define will be appropriately picked up and applied to arrive at the final rate that is applied to floating components of contracts that involve the customer - currency combination.



The buy and sell margins that you define are for a customer and currency combination. You can select the customer and currency combination from the option lists available.

For the selected currency – customer combination, you can define amount slabs and specify a Borrow and Lend margin for each slab. To add a slab to the list click add icon and enter the slab details. To remove a slab from the list, highlight it and click delete icon.

Whenever you enter a contract in Oracle FLEXCUBE that involves the customer and currency combination, the appropriate spread is applied to arrive at the floating rate to be charged. The slab is selected based on the contract amount and depending on the nature of the contract, the Borrow or Lend spread is applied.

The screenshot shows the 'Customer Spread Maintenance' window. At the top, there are buttons for 'New' and 'Enter Query'. Below these are two dropdown menus for 'Customer \*' and 'Currency \*'. To the right, there are radio buttons for 'Borrow/Lend', with 'Borrow' selected. Below these is a table titled 'Customer Spread Maintenance' with columns 'Amount Slab' and 'Spread'. The table has one row with empty input fields. At the bottom, there is a 'Fields' section with labels for 'Input By Date Time', 'Authorized By Date Time', and 'Modification Number'. There are also checkboxes for 'Authorized' and 'Open'.

### 15.2.2.1 Making Margin Applicable to All Customers

For a given currency, you can define borrow and sell margins to be applied to All customers. At the customer field choose ALL. However, if you have maintained currency margins for a specific customer and currency combination, it takes precedence over the margin defined for all customers.

Currency margins can be maintained for customers across branches. In effect, a branch can maintain margins for a customer belonging to another branch. These margins are propagated across branches of your bank.

---

## 16. Maintaining Company Codes

### 16.1 Introduction

A list of company codes can be defined in the Company Maintenance screen. You can invoke this screen by typing 'STDCOMMT' in the field at the top right corner of the Application tool bar and clicking the adjoining arrow button.

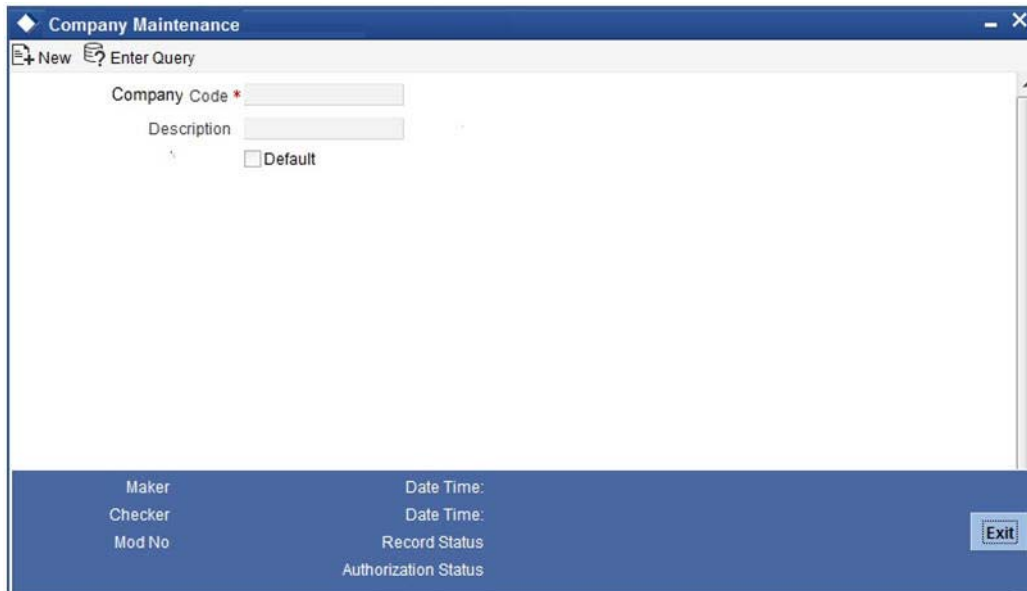

The screenshot shows the 'Company Maintenance' application window. The title bar reads 'Company Maintenance'. Below the title bar is a toolbar with 'New' and 'Enter Query' buttons. The main content area contains three input fields: 'Company Code \*', 'Description', and a 'Default' checkbox. The bottom status bar displays fields for 'Maker', 'Checker', 'Mod No', 'Date Time:', 'Record Status', and 'Authorization Status', along with an 'Exit' button.

The following details need to be specified in this screen:

#### **Company Code**

Specify the company code to uniquely identify the company.

#### **Description**

Specify the description of the company code.

#### **Default**

Check this box to select the company code as the default company code. This box should be selected for only one company. If the default flag is selected for more than one company then an appropriate error message is displayed by the system during the Save operation.

The company codes defined in this screen is subsequently listed in the 'Company Based Variance and Charge' screen and the 'Customer Maintenance' screen to define Cycle Based Interest Rates.

---

# 17. Period Code Maintenance

## 17.1 Introduction

Banks, like all business houses compute their profits and losses and assess their financial position at the end of each financial year, which typically extends to 12 months -- from January to December or from March to April. However, this could be changed, depending upon the Bank's policies and regulatory requirements.

For interim reporting needs, the financial year is further divided into accounting periods, the duration of which is again determined by the bank's accounting requirements. For example, your bank's Board of Directors meets once a month therefore, you would divide the financial cycle into monthly periods.

The financial year and the accounting periods are referred to in the Oracle FLEXCUBE system as the 'Financial Cycle' and the 'Financial Periods' respectively and are maintained at the bank level by your Head Office branch.

At the end of each financial period and financial cycle you can generate profit and loss statement and a balance sheet. The system also offers you the flexibility of keeping a financial period/financial cycle open, allowing you to post adjustments to it and obtain a revised profit or loss statement/balance sheet. You can maintain these details in the 'Period Code Maintenance' screen.

## 17.2 Invoking Period Code Maintenance Screen

You can invoke this screen by typing 'STDPRCDE' in the field at the top right corner of the Application tool bar and clicking the adjoining arrow button.

The screen appears as shown below:

Period Code *	Start Date	End Date *

In this screen you define the following:

- The financial cycle of your bank giving the start date and end date of each financial year
- The period group - financial periods into which each financial cycle is to be divided

The following are the features of the Period Code screen

### **Financial Cycle**

For each financial cycle you maintain the following parameters:

#### **Cycle**

This is a code for the financial cycle. It acts as an identifier for the cycle. For example, while posting adjustments into a previous financial cycle -- you would identify the year through this code.

Input the code using a maximum of 9 characters, alphanumeric.

For example, the financial cycle extends from 1st April to 31st March in India. A bank here could define its code for the year 1996-97 as FY 1996-97.

#### **Description**

This describes the financial cycle. Enter description using a maximum of 35 characters, alphanumeric. Taking the above example, you could enter Financial Year - 1996-97.

#### **Start Date**

This is the first day of this Financial Cycle

#### **End Date**

This is the last day of this Financial Cycle

#### **Period Group**

The financial cycle defined above, can be divided into different accounting periods. To define individual accounting periods click on the first row under period code. A period called 'FIN' is created by the system. This is an open ended period coinciding with the last day of the financial cycle (for details refer to the section 'System Functions').

You can maintain the following parameters for each accounting period within a financial cycle:

#### **Period Code**

This code identifies the accounting period. Enter a code using a maximum of 3 characters, alphanumeric. For example, if your period length is a quarter you can enter - Q1 for the first period; Q2 for the second; Q3 for the third and so on. If your period length is a bimonthly you can enter BM1, BM2. If your period length coincides with a month you can input M1, M2.

#### **Start Date**

This is the first day of the corresponding period

#### **End Date**

This is the last date of the corresponding period. 'End date' of a period should always end on a month end. Please note:

- The period codes could be of varying lengths but no gaps should be left between periods
- The duration of two periods should not overlap
- You can modify the period code of the current or a future period; however, a past period cannot be modified even if it has not been closed
- All details maintained in the 'Period Code Screen' will automatically apply to any new branch opened by you in the Branch Parameters Screen

- The current financial cycle code and the current period code are displayed in the 'Branch Parameters Screen'

### **Period Code Status**

After authorisation, you can view whether a financial period is open or it has been closed. Each branch can view the status of a period in every other branch. Click the period whose status you want to view.

### **Branch**

Displays the codes of the different branches of your bank

### **Status**

Displays the corresponding status of the period code highlighted. 'O' - indicates open status; 'C' - indicates closed status

---

### **Note**

The current financial cycle code and the current period code are displayed in the 'Branch Parameters Screen'

---

All details maintained in the 'Period Code Screen' will automatically apply to any new branch if incorporated to your bank post maintenance of this screen. The status of all periods in the new branch will be open.

## **17.3 System Functions**

The system offers you the flexibility of posting transactions into a previous accounting period which has passed its due end date. For example, lets assume your bank's financial cycle extends from 1st January to 31st December; the first period starts on 1-01-96 ends on 31-03-96. Even beyond 31-03-96 you can keep the period open to be able to post for example, expense bills you expect to receive in April. After you have posted all adjustments, you can close the period.

Even after you have closed the last accounting period of a year, the system offers you the flexibility of posting adjustments to the financial year.

For each financial year the system generates an open status period called FIN. Its start and end dates coincide with the last date of the financial cycle. Into this one day period you can post the accumulated profits and loss for the financial cycle, general reserves, and statutory reserves for the current year after paying off the dividends. After this one day period is closed the status of the financial cycle in the made by field 'status' is displayed as closed. With this the financial year stands closed and no adjustments can be posted to it.

Closure of a period/financial cycle can be invoked through the General Ledger/ Core Services module. The branches of the bank should close this period/financial cycle.

---

## 18. Status Code Maintenance

### 18.1 Introduction

Loans and bills, which are past their due maturity date of installment re-payment, but remain unpaid, are defaulted contracts. In the Oracle FLEXCUBE system these defaulted contracts can be assigned to different statuses, based on the number of days for which the contract is outstanding.

Each status can be assigned a code. For instance, you can define a status code PDO to represent 'past due obligation', and specify a period of 15 days after which an outstanding contract should be marked as 'PDO'. If they are due for more than 60 days, you could assign a 'doubtful' status; 'sub-standard' if due for 6 months, and so on. Contracts for which no installments are due, or which are regularly paid on their due dates are assigned the status 'Active' by the system. According to the number of days of default defined for each status, a loan would be moved from 'Active' to PDO status, then to doubtful and finally to sub-standard status.

Similarly, you can define status codes for current and savings accounts also. Current and Savings accounts that have not generated any interest over a specific period or have remained inactive with interest overdue may be identified as 'NPAs' (Non-Performing Asset). In Oracle FLEXCUBE, you can assign these accounts different status codes and define status criteria based on which the status movement will occur.

*Refer the 'Core Entities' user manual for details on associating status codes with a customer account class /account.*

These status codes are maintained in the 'Status Codes Maintenance' screen.

### 18.2 Invoking Status Maintenance Screen

You can invoke this screen by typing 'STDSTSCD' in the field at the top right corner of the Application tool bar and clicking the adjoining arrow button.

The screenshot shows the 'Status Code Maintenance' application window. At the top, there is a title bar with the text 'Status Code Maintenance' and standard window controls. Below the title bar is a menu bar with 'New' and 'Enter Query' options. The main content area contains four input fields: 'Status Code \*', 'Description', 'Status Sequence \*', and 'Status Type \*' (a dropdown menu set to 'Both'). Below the input fields is a 'Fields' section with a scrollable list containing 'Maker', 'Checker', 'Mod No', 'Date Time:', 'Date Time:', 'Record Status', and 'Authorization Status'. An 'Exit' button is located in the bottom right corner.

In this screen you can maintain the following to user defined status of a loan or bill/account status:

- I A unique code for the status
- I A brief description for the status
- I A sequence number for the status
- I The type of status – Indicate whether the status codes are maintained for an 'Account' or for a 'Contract', or for 'Both'

The type of status you choose depends on the status processing basis for your branch, which is defined in the Branch Parameters Preferences maintenance. If status processing basis is at individual account / contract level, you can choose the applicable status types as 'Account' or 'Contract'. The status codes that have been maintained of type 'Account' are available for association in the Account maintenance and those maintained with type 'Contract' can be associated with contracts.

If status processing basis is at Group / CIF level, you can only maintain status codes of type 'Both' (that is, applicable for both accounts and contracts). In such a case, you must associate the statuses at both the Account maintenance as well as for contracts.

---

**Note**

- It is mandatory to maintain the status code 'NORM' (Normal) with the sequence number as '0', for all the status types. The sequence number must not be repeated for a status type.
  - The sequence number associated with the status will be used for determining the hierarchy of statuses, i.e., higher the number, worst the status and this will be unique for the status codes.
- 

## 18.2.1 **Maintaining Status Codes for Contracts**

The following parameters need to be maintained for defining a status code:

### **Status Code**

This is the code, which identifies the status to which the contract belongs.

For example, assign a code using a maximum of 3 characters, alphanumeric. For example, if your contract has past its due obligation status you can input code PD1. PD representing post due obligation. The number 1 stands for stage 1 of the post due obligation status

### **Status Description**

This is the description of the status, Enter a description using a maximum of 35 SWIFT characters.

For example, taking the above example, you can input here - Past Due Obligation 1 for Loan if you are maintaining status codes for Loans.

### **Link to**

This represents the category of the product - asset or liability to which the contract status is applicable.

For example, if you are maintaining status codes for loans or any money market placements, click on 'assets type of product'. If you are maintaining status codes for deposits, click on 'liability type of products'.

### Effective days from Maturity

This indicates the number of days after the due date when this status becomes applicable to the contract. You can specify any number of days from 0-999.

The effective days defined here is defaulted to the product level in the Bills and Loans modules. You have the option of redefining the number of days at the product level.

## 18.2.2 Maintaining Status Codes for OD Account

Oracle FLEXCUBE provides a facility to maintain status codes for Charge-off and Write-off status of the OD account. These status codes are maintained in 'Status Code Maintenance' screen and the details of the same are as follows:

Status Code	Description	Status Sequence	Status Type
CROF	Status code for Charge-off of OD accounts.	Should be less than SUSP status sequence	Account
SUSP/WOFF	Status code for suspended status of OD accounts.	Should be greater than CROF status sequence	Account

## 18.3 Maintaining Dormancy Parameter Details

You can maintain the dormant statuses for the customer account in the 'Dormancy Parameter Maintenance' screen. To invoke this screen, type 'STDSTDOR' in the field at the top right corner of the Application tool bar and click the adjoining arrow button.

### Transaction Branch

Select the appropriate branch from the list of branches available in the option list. This screen will be available only for those users who has 'Multi Branch Operational' check box enabled at 'User Maintenance' Screen.

While clicking 'Ok' button, the system validates the access rights of the selected branch and function for the user. If you don't have appropriate rights on the selected branch and function, the system would raise an error message. If you select a valid branch, the system updates the same as transaction branch and the transaction would be posted for this branch.

---

### Note

The system performs the action level access rights validation only on 'Save' operation.

---



After selecting the Transaction Branch, you can enter the remaining details in the 'Dormancy Parameter Maintenance' screen.

The screenshot shows the 'Dormancy Parameter Maintenance' window. It includes a 'Save' button at the top left. The main form area contains the following fields and options:

- Account Number \* (with a dropdown arrow)
- Account Description (with a text area)
- Account Branch (with a dropdown arrow)
- Account Currency (with a dropdown arrow)
- No Debit
- No Credit
- Frozen
- Dormant
- Reverse Movement Parameters (with a dropdown arrow)
- Remarks (with a text area)

At the bottom, there is a 'Change Log' section with a blue background, containing the following fields:

- Maker
- Checker
- Mod No
- Date Time:
- Date Time:
- Record Status
- Authorization Status

A 'Cancel' button is located in the bottom right corner of the window.

You need to specify the following details:

#### **Account Number**

Specify the customer account and the TD account for which you are maintaining the dormant status. The adjoining option list displays all the customer account numbers and the TD accounts that are maintained in the selected transaction branch. You can choose the appropriate one.

#### **Account Description**

The system displays the account description of the selected account.

#### **Account Branch**

Specify the account branch code. The adjoining option list displays all the branch codes that are maintained in the system. You can choose the appropriate one.

#### **Account Currency**

The system will display the currency of the selected account.

#### **No Debit**

Check this box to indicate that no debits should be posted to the selected customer account. This option is not applicable for TD accounts.

#### **No Credit**

Check this box to indicate that no credits should be posted to the selected customer account. This option is not applicable for TD accounts.

#### **Frozen**

Check this box to indicate that the customer account is frozen due to some unavoidable reason. This option is not applicable for TD accounts.

**Dormant**

Check this box to indicate that the account is in dormant status which means not used for along time.

**Remarks**

Specify the remarks, if any.

---

**Note**

- For a customer if there are any TD accounts, the most futuristic maturity date of the 'Open' is taken as the reference. If you update any customer account (CASA/TD) with the status dormant, then the futuristic maturity date is validated.
  - During validation, if the dormancy movement date is current system date, then system will display an error message 'Account Cannot be Made as Dormant as the Maturity Date of the TD Account Number XXXXXXXX (Account Number) is XXXXXXXX (DDMMYYYY)'.
- 

## 18.4 Maintaining CR\DR Statistics Details

You can maintain the credit\debit statuses for the customer account in the 'CrDrStat Maintenance' screen. To invoke this screen, type 'STDSTCDM' in the field at the top right corner of the Application tool bar and click the adjoining arrow button.

**Transaction Branch**

Select the appropriate branch from the list of branches available in the option list. This will be available only for those users who has 'Multi Branch Operational' check box enabled at 'User Maintenance' Screen.

While clicking 'Ok' button, the system validates the access rights of the selected branch and function for the user. If you don't have appropriate rights on the selected branch and function, the system would raise an error message. If you select a valid branch, the system updates the same as transaction branch and the transaction would be posted for this branch.

---

**Note**

The system performs the action level access rights validation only on 'Save' operation.

---

After selecting the Transaction Branch, you can enter the remaining details in the 'CrDrStat Maintenance' screen.

The screenshot shows the 'Credit Rating Status' window. It includes a title bar, a menu bar with 'New' and 'Enter Query' options, and a main form area. The form contains input fields for 'Branch Code \*' and 'Customer A/C \*', three checkboxes for 'No Debit', 'No Credit', and 'Posting Allowed', and a 'Remarks' field. Below the form is a 'Change Log' section, and at the bottom is a footer area with labels for 'Maker', 'Checker', 'Mod No', 'Date Time:', 'Record Status', and 'Authorization Status', along with an 'Exit' button.

You need to specify the following details:

#### **Branch Code**

Specify the branch code. The adjoining option list displays all the branch codes that are maintained in the system. You can choose the appropriate one.

#### **Customer A/C**

Specify the customer account for which you are maintaining the credit\debit status. The adjoining option list displays all the customer account numbers that are maintained in the selected transaction branch. You can choose the appropriate one.

#### **No Debit**

Check this box to indicate that no debits should be posted to the selected customer account.

#### **No Credit**

Check this box to indicate that no credits should be posted to the selected customer account.

#### **Posting Allowed**

Check this box to indicate that the account class being created is to be used while creating IRA monetary accounts. Monetary accounts used for IRA need to be distinguished from the other accounts in Oracle FLEXCUBE, so that these accounts do not come up for posting in the other Oracle FLEXCUBE screens.

#### **Remarks**

Specify the remarks, if any.

# 19. Transaction Code Maintenance

## 19.1 Introduction

In the 'Transaction Codes Maintenance' screen you define transaction codes to representing various types of transactions, for example, transfer charges, incoming mail transfer, incoming telex transfer, reserve, incoming clearing transfer etc. All similar transactions can be grouped under a common transaction code with a description. This description will be printed on the account statements, reports and advices generated.

For a transaction type you also maintain other related processing details which will be applicable to all transactions posted under a common code. Details about availability of funds for liability checking, SWIFT code for the transaction type, preferences regarding charges to be levied on turnovers, payment to be made through cheques etc.

## 19.2 Invoking Transaction Code Screen

You can invoke 'Transaction Code Maintenance' screen by typing 'STDTRNCD' in the field at the top right corner of the Application tool bar and clicking the adjoining arrow button.

The screenshot displays the 'Transaction Code Maintenance' application window. The interface is organized into several sections:

- Transaction Details:** Includes fields for 'Transaction Code \*', 'Description \*', and 'Swift Code'. To the right are 'MIS Head' and 'External Code' fields.
- Availability Information:** Features radio buttons for 'Immediate', 'On Value Date', 'After Days with New Value Date', and 'After X days', along with a 'Days' input field.
- Overdraft Tracking:** Contains a 'Component type for transaction' dropdown menu set to 'Principal'.
- Anti Money Laundering Monitoring:** Includes checkboxes for 'Anti Money Laundering Required', 'Product Category', 'Statement Day Basis' (set to 'Current Working Day'), 'Intraday Release', and 'Salary Credit'.
- Preferences:** A large section with numerous checkboxes, including 'Cheque Mandatory', 'Interests and Charges Transaction Count', 'Interests and Charges Turnover Inclusion', 'Consider for Account Activity', 'Interest and Charges Balance Inclusion', 'Consider For Turnover Limit', 'Consider for cover sweeps', 'Available Balance Check Required', 'Interests and Charges Penalty Inclusions', 'Inter Branch in Local Currency', 'Acumen Transaction Code', 'Exempt Advance Interest', 'Escrow Processing', 'Available Balance Update Through PPC', 'Exception to Debit Override Status', and 'Exception to Credit Override Status'.

At the bottom, there is a 'Fields' section with labels for 'Maker', 'Checker', 'Date Time:', 'Mod No', 'Record Status', 'Authorization Status', and an 'Exit' button.

In this screen you maintain the following for a transaction:

- A code representing the transaction type
- Description of the transaction type
- The interval after which funds should be made available after the transaction

- Preferences regarding charges to be levied or not on number of transaction counts and total turnover amounts
- Preference stating whether a transactions booked under this code should cause an account marked as 'dormant' by the system to be re-instated to 'active'
- Preference whether payment for a transactions posted under this code should be made through cheque
- Preference indicating whether payment for a transaction booked under this code should be considered for Escrow transfer processing

## 19.2.1 Maintaining Transaction Details

The following parameters need to be maintained for a transaction type:

### **Transaction Code**

This is the code you assign to a transaction type. This code identifies the type of transaction.

Enter 3 characters, Alphanumeric. For example, for all transfer charges transaction you can give the code as TCT; for incoming telex transfer you can input - ITT. In case, you want to assign numeric codes only, then for ease of operation similar transaction types should be grouped into a range. For example, you can set a range for all Money Market transactions say, A1-A30; a different range for Bills and Collections B1-B30 and so on.

### **Description**

This is the description of the transaction type

Enter the description using a maximum of 35 characters, alphanumeric. For example, for TCT code you can enter 'Transfer Charges Transaction'.

### **SWIFT Code**

This is the SWIFT code to which this transaction code is linked. It is used for posting transaction details on SWIFT format.

Select from the option list. It will display a list of SWIFT formatted codes representing transaction types. The following list is displayed:

<b>SWIFT CODES</b>	<b>TRANSACTION TYPE</b>
BOE	Bill of Exchange
BRF	Brokerage fee
CHG	Charges and other Expenses
CHK	Cheques
CLR	Cash Letter/Cheque Remittance
COL	Collections
COM	Commission
DCR	Documentary Credit (for Principal Amount)
DIV	Dividends - Warrants
EQA	Equivalent Amount

ECK	Euro checks
FEX	Foreign Exchange
INT	Interest
LBX	Lock Box
LDP	Loan Deposit
MSC	Miscellaneous
RTI	Returned Item
SEC	Securities
STO	Standing Order
TCK	Travelers Cheques
TRF	Transfer
VDA	Value Date Adjustment

The codes COL -Collections, DCR - Documentary Credit and SCC- Securities are used when entering a principal amount.

#### **MIS Head**

Each Transaction Code that is created can be linked to an MIS Head. An MIS Head indicates the manner in which the type of entry should be considered for profitability reporting purposes.

#### **Availability Information**

This states the different time intervals after which funds will be available for withdrawal in case of all transactions posted under this transaction code.

The system defaults to immediate, which means that funds will be immediately available for withdrawal (the immediate option on the screen). Example: Teller Transaction. For all Clearing transactions you have the option to specify as to when will funds be made available for withdrawal. Click the desired option.

Click 'On Value Date' option if you want funds to be available on the date the transaction became effective. Example: A loan or a deposit

Incase you want to specify the number of days after which funds should be available for withdrawal, click on the option After Days. Enter the number in the box. It could be any two digit positive integer from 1 to 99. This option will make funds available for all transactions posted under this code, on the specified date from the value date. Example: Demand Draft

When you click the option After Days with New Value Date and enter the number of days in the box; then the original value date of the contract will take a new value date. This new value date = old value date + the number of days input by the user in the box against the option. Example: Future dated funds transfer.

The difference between the third and fourth option being that in the latter case the old value date changes; while in the former the value date does not change.

When you click the option 'After X Days' it indicates the availability of the respective funds on the same day as per the customer value date or with a delay based on value for 'X'.

During this extended period, funds will not be available and will be in “Uncollected” status.

### **Intra-day Release**

If you want uncollected funds on a transaction posted using the transaction code, to be manually released intra-day (that is, within the day), select the Intraday Release option. The Intraday Funds Batch, when manually executed during the day, picks up those transactions that are due for release on or before the system date, which have been posted with the transaction code (with the Intraday Release option enabled), for release of uncollected funds.

The Intraday Release option cannot be enabled if the Availability specified for the transaction code is Immediate.

You can use the ACUNCOLB (Intraday Funds Release) batch process to perform the intra-day release of uncollected funds in respect of transactions posted using a transaction code for which the Intraday Release option has been enabled.

*For details about invoking the batch process, refer the Current and Savings Account user manual.*

### **Extended Period for Uncollected Balance**

If ‘availability days’ is deferred by X days mentioned in transaction code, the system will credit the funds to customer account as on ‘Customer Value Date’, but the availability of the funds will be restricted. The uncollected funds will NOT be released on reaching customer value date. The system will trigger the ‘uncollected release’ on reaching ‘Contract Date + ‘X’ Days as per transaction code’.

The system will schedule the ‘uncollected release’ as an intra day batch to release the funds to available balance on the account, say at 2PM every day.

The float extension can be triggered till the movement to ‘available balance’ takes place. Whenever there is a float extension defined using CGDBFLEX or CGDCFLEX, the uncollected release execution will get pushed by the extended number of days and correspondingly the ‘Availability date’ in CGDQUERY screen will also be updated with the new date

For interest application, the system will consider the value date of credit as the previous local working day for the clearing house, compared to the ‘Availability Date’.

### **Overdraft Tracking**

#### **Component type for transaction**

Select the component type for transaction from the drop-down list. The options available are:

- Principal - Select ‘Principal’, if a transaction type is not an interest or charge
- Interest - Select ‘Interest’, if a transaction code is used for debiting interest for an overdraft account.
- Charge - Select ‘Charge’, if a transaction code is used for debiting charge for an overdraft account.

The component type for the transaction code is mandatory for maintaining transaction code and cannot be modified after the first authorization.

### **Preferences**

This field indicates your preferences regarding transactions booked against this transaction code. The preferences marked relate to the following:

### **Interest and Charges Transaction Count**

Every debit or credit entry is passed under a transaction code. If for a transaction code you have checked 'I&C transaction count' then all entries made under that code would be picked up by the system as chargeable transaction counts which would be used by the I&C system to compute charges.

Therefore, you should take care not to check for all bank induced transactions like - service charges, interest payment, calculation, brokerage and charges, etc.

For example, your bank has a policy of limiting savings withdrawals without additional charges to only 8 in a month. Beyond which all withdrawals would be charged. For the ninth and onward withdrawals in the month from any account the system will maintain a count for computing charges. However, care should be taken to exclude all bank-induced transactions from the count.

### **Interest and Charges Turnover inclusion**

Every debit or credit entry is passed under a transaction code. If for a transaction code you have checked 'I&C turnover inclusion' then the debit turnover/ credit turnover balance under that code would be picked up by the system as chargeable depending upon the option specified in the I&C module. Therefore you should take care not to check for all bank induced transactions like - service charges, interest payment, calculation, brokerage and charges, etc.

### **Interest and Charges Balance Inclusion**

Check this box to indicate that the transactions posted under this code should be considered for the purpose of computation of Remuneration (Interest). By default this option is checked. Uncheck this box for such loan transactions or any other transactions for which you wish to exclude computation of remuneration (interest).

---

#### **Note**

Once the transaction code is authorized, you cannot change your preference.

---

### **Consider for Turnover Limit**

Check this box to indicate that all transactions posted under this code should be considered as part of the turnover limit processing.

### **Consider for Cover Sweeps**

Check this box to consider easy saver processing using cover accounts for transaction.

Only if you check this box, the system will consider the debit transactions for sweep from cover accounts/auto linked TD/linked term deposits.

If a particular transaction should not be included for sweep, then the related transaction codes should be maintained with 'Consider for Cover Sweeps' as unchecked.

The above field is applicable only for clearing and teller modules. Oracle FLEXCUBE repays loan from multiple accounts. In Oracle FLEXCUBE, the loan account is the primary account and all the other accounts linked to it are cover accounts. While paying the settlement if the primary account has insufficient amount, the system will check the cover accounts for the remaining amount according to the preference.

### **Consider for Account activity**

If you check the field 'Consider for A/C activity' for a transaction code, then any debit or credit posted under this code would reinstate the status of an account from dormant to active and accounting activity shall be considered.



### **Cheque Mandatory**

If for a transaction code you check 'Cheque Mandatory' then, for all transactions posted under this code, transaction will take place through cheque. For example: Incoming Clearing transfer.

Cheque Mandatory should be checked only for SB cheque withdrawals and Cash Account Cheque withdrawals.

### **Available Balance Check Required**

Select this option along with Available Balance Check Required flag in account class (STDACCLS) of the customer account too if you want the system to check for the availability of funds before posting a debit entry to a customer account. The system will check for the available balance in all customer accounts associated with the Transaction Code and account class for which the option is enabled.

---

#### **Note**

However, the system will check for the available balance only if you have selected the 'Available Balance Check required' option for both the transaction code associated with the accounting entry and the Customer Account Class to which the customer's account that is being debited, belongs. The check will not be performed if the option is not selected in both places.

---

### **Interest and Charges Penalty Inclusion**

In the transaction code that you use for debit entries to time deposit accounts, you must indicate the computation of penalties on debit entries due to withdrawals from the account before the maturity date. You must select the IC Penalty Inclusion check box to indicate this.

### **Inter Branch in Local Currency**

This indicates whether inter branch entries passed with this transaction code should be in Local currency. If this option is checked, the inter branch transactions would be passed in local currency. This way, the Treasury would be able to track its profit and the branch's profit by passing a single consolidated entry (Position transfer from one branch to the Treasury branch) at the treasury rate.

---

#### **Note**

- This option is applicable only if the local currency of the different branches is the same. This option is applicable only for Fcy1- Fcy1 transactions. For other transactions, namely, Fcy1-Fcy2, Lcy-Fcy, Fcy-Lcy, IB entries would be based on IB Parameters Maintenance.
  - For position transfer, the 'Inter Branch in Local Currency' check box in the Transaction Code maintenance screen should be checked to avoid creating position due to IB posting.
- 

### **Acumen Transaction Code**

You need to check this option in order to eliminate the deals/transactions uploaded from the Acumen in the Hand-off of transactions affecting FCY Position to Acumen from Oracle FLEXCUBE.

---

**Note**

This is applicable where Oracle FLEXCUBE interfaces with Acumen. Acumen is an Integrated Turn-key solution for Treasury, Derivatives and Capital Markets Covering Front, Risk Control, Middle Office from Login SA.

---

**Exempt Advance Interest**

Check this box to indicate that all the postings with this transaction code should not be considered for penalty interest calculation.

**Escrow Processing**

Check this box to indicate that all the payments related to this transaction code should be considered for Escrow sweeps. If this box is checked and the credit account (Project account) is Escrow enabled then the system will automatically compute predefined percentage of transaction amount and places an amount block on the credit account (Project account).

---

**Note**

Escrow processing is possible only if the trust account and escrow account are of the same currency and are with-in Oracle FLEXCUBE.

---

**Available Balance update through PPC**

Check this box to update the available balance on the project through PPC.

**Exception to Debit Override Status**

Check this box to provide all the transactions under the transaction code an exception to debit override restriction.

**Exception to Credit Override Status**

Check this box to provide all the transactions under the transaction code an exception to credit override restriction.

If a customer account is marked as Debit/Credit Override for all Debit/Credit transactions to the account, then during the accounting entry posting to the account the system behaves as follows:

- FCUBS UI
  - If a debit/credit transaction to the account is performed through FCUBS user interface, system will pop-up an override message intimating the user that the account is in 'Debit/Credit Override' status. This validation will be applicable to all debit/credit transactions to the account and system will not consider the exceptions maintained at transaction code level. The user has an option to accept the override and go ahead with the transaction or reject the override and abort the transaction.
  - If the override is accepted, then it will be logged along with transaction details.
  - For all FCUBS transactions, override will be displayed only during posting of the account entries into account.
  - The system displays an override message on the transaction screen if the accounting entries for a transaction are posted online.
  - In case of bulk transaction processing in PC/ Clearing transactions, where the accounting entries are deferred, the transactions will move to a debit exception queue. From the queue these overrides can be accepted or rejected by the user
- FCUBS Automatic Batch Processes
  - If a customer account is marked as debit/credit override, all the transactions in the account will be restricted by a validation which is configured as 'Error'.

- If 'Exception to Debit/Credit override' status is checked at the transaction code level, then the accounting entries are posted. Else, the system does not allow the accounting entries to get posted.
- Transaction from Interfaces
  - If the customer account is marked as 'Debit/Credit Override', all debit/credit transactions in the account initiated from external interfaces will be stopped and the system will not consider the exceptions maintained at transaction code level.
  - You can handle the transactions from the external interfaces through the error code conversion functionality available in the 'Override Maintenance' (CSDOVDME) screen. The error code conversion can be maintained based on channel names and the new error code can be maintained as 'Error' type.

### Salary Credit

Select the type of salary credit from the adjoining drop-down list. This list displays the following values:

- Normal Salary
- Bulk Salary

By default, the system selects null value.

---

#### Note

- The value 'Bulk Salary' can be selected only if the 'Availability Information' is 'Immediate'.
  - This applies when you use the option 'Bulk Salary' along with a transaction code. When a credit is made to an account through salary upload table along with a bulk salary enabled transaction code, the system blocks the entire credit amount on that account with effect from the date of upload. This block remains active for the period maintained in CSTB\_PARAM against the parameter 'BULKSALARY\_BLOCK\_DAYS'. The number of days for expiry is mentioned terms of calendar days. The system does not allow manual operations on the amount block for these accounts.
- 

### Statement Day Basis

You need to specify when the transaction associated with the selected Transaction Code should appear in the account statement. The available options are:

- Current Working Day
- Previous Working Day

#### 19.2.1.1 Accounting Entry Processing to Calculate Statement Date

The accounting entry processing will be enhanced to calculate the Statement Date based on the Transaction Code Maintenance and the Statement Status at the Branch level. The following illustration explains the calculation of Statement Date.

Assume two Transaction Codes TXN1 and TXN2 have been defined with Statement Date Basis as Current Working Day and Previous Working day respectively. The Statement Date would be derived as follows:

For a transaction C1 posted on say 25<sup>th</sup> Jan, 2004 with TXN1, the Statement Date would be derived as 25<sup>th</sup> Jan, 2004 irrespective of the Branch Statement Status.

For a transaction C2 posted on 25<sup>th</sup> Jan, 2004 with TXN2, the Statement Date would be derived as the Previous Working Day of 25<sup>th</sup> Jan, 2004 if the Branch Statement Status is set to 'N' specifying that the Branch is not yet ready for periodic statements processing.

For a transaction C3 posted on 25<sup>th</sup> Jan, 2004 with TXN2, the Statement Date would be derived as 25<sup>th</sup> Jan, 2004 if the Branch Statement Status is set to 'Y' specifying that the Branch is ready for periodic statements processing.

The Statement Date would be stored as part of the archived data also

The Statement Date would be recomputed during the reversal entry in the same logic

### 19.2.1.2 **Monitoring Anti Money Laundering**

#### **Anti Money Laundering Required**

Check this box to indicate that AML monitoring is required for all accounting entries linked to the particular transaction code. Leave it unchecked to indicate otherwise.

#### **Product Category**

If you indicate that AML tracking is required for all transactions linked to the particular transaction code you have to identify the product category for which AML tracking is necessary.

---

#### **Note**

If the transaction code linked to the transaction type has 'intra day release' as 'Yes', then 'uncollected release' can be scheduled as an intra day batch to release the funds to the available balance on the account.

---

### 19.2.2 **Maintaining Country Name Details**

You can define country name through the 'Country Code Maintenance' screen. You can invoke this screen by typing 'STDCNMNT' in the field at the top right corner of the Application tool bar and clicking the adjoining arrow button.

The screenshot shows the 'Country Code Maintenance' application window. The window title is 'Country Code Maintenance'. It features a menu bar with 'New' and 'Enter Query' options. The main area contains several input fields and checkboxes: 'Country Code \*', 'Alternate Country Code', 'Limit Currency', 'Blacklisted', 'EU Member', 'Generate 205', 'Country Name', 'ISO Country Code', 'Overall Limit', 'IBAN Mandatory for Payment Messages', 'Clearing Code in BIC+', 'Default Clearing Network', and 'International Dialing Code +'. At the bottom, there is a 'Fields' section with labels for 'Maker', 'Checker', 'Mod No', 'Date Time:', 'Record Status', and 'Authorization Status'. An 'Exit' button is located in the bottom right corner.

Here, you can capture the following details

### **Country Code**

You can capture a unique three-character code to identify the country. For example: you can maintain USA as the country code for United States of America.

### **Alternate country code**

You can also associate an alternate country code. This is for information purposes only and will not be printed on any customer correspondence.

For example you can have US as the alternate code for USA

### **Country Name**

After you define an alphanumeric code to identify the country for which you would like to assign a name, you have to specify the name of the Country.

### **Overall Limit**

This is the maximum credit exposure that a bank is willing to take for a country. That is, the sum of all utilization's under this country liability cannot exceed the amount specified here.

### **Blacklisted**

Further, in the 'Country Name Maintenance' screen you can black list a country for further usage. You are not allowed to deal in countries that are blacklisted.

You can only deal with countries that are *not* blacklisted

### **IBAN Mandatory for Payment Messages**

If this is checked, it indicates that for every payment message an IBAN is mandatory. This is automatically checked if you have checked the 'EU Member' box.

If this option is unchecked for a country, the system will not process the outgoing payments wherein the ordering customer or the beneficiary customer belongs to that country.

### **EU Member**

This indicates whether the country is recognized by Swift as a part of the Intra European countries.

If you check this flag the instructed amount field should be mandatory in the generated 103, 103+ and 102 messages. The instructed amount field is mandatory in the incoming messages.

### **Clearing Code in BIC+**

Check this box to indicate that the National ID in the BIC plus file is the clearing code. During upload of clearing codes from BIC plus file, the records that belong to countries against which this box is checked will be selected.

### **Generate 205**

Check this box to indicate that the cover message 205COV or 205 need to be generated for transactions involving this country. If you do not select this option, RTGS, 202 or 202COV message will be generated.

*For more details on 202COV and 205COV cover message formats, refer settlements user manual.*

### **Default Clearing Network**

Once the National ID from BIC plus directory is uploaded into clearing codes, the network will be populated as the default clearing network for that country. This is mandatory when clearing code in BIC+ is chosen as 'Y'.

### **International Dialling Code**

Specify the international dialling code associated with the country.

## **19.3 Maintaining Shumoku Code**

You can maintain Shumoku codes and associate each customer account class with a Shumoku code. This facilitates capturing the default account for a customer based on the Shumoku code combination and process the Direct debit / ANSER transactions with the default account maintained.

---

### **Note**

A Shumoku code can be closed only if it is not associated with any active account class.

---

You can maintain Shumoku codes in the 'Shumoku Code Maintenance' screen. You can invoke the 'Shumoku Code Maintenance' screen by typing 'STDSHMCD' in the field at the top right corner of the Application tool bar and clicking the adjoining arrow button.



You can specify the following details:

### **Shumoku Code**

Specify the Shumoku code, which can be mapped with an account class.

### **Description**

Specify the description of the Shumoku code.

## 20. Account Revaluation Maintenance

### 20.1 Introduction

Account revaluation is a process by which the LCY equivalent of balances in the FCY accounts is marked to market.

In all foreign currency accounts, the FCY current balance is displayed along with the LCY equivalent of the current balance. The LCY equivalent current balance is the aggregate of the LCY equivalent of the various transactions that have been posted to the account.

In the 'Chart of Accounts - GL Details' screen you specify whether a GL should be revalued or not.

In the 'Account Revaluation Maintenance' screen, you specify parameters for account revaluation such as rate type, the GL to which the profit or loss from revaluation should be posted, etc. You can invoke this screen by typing 'RVDSETUP' in the field at the top right corner of the Application tool bar and clicking the adjoining arrow button.

The screenshot shows the 'Account Revaluation Setup' window. It contains the following fields and sections:

- General Ledger Code \*** (with a search icon) and **Description**
- Transaction Code \*** (with a search icon) and **Description**
- Rate Type \*** (with a search icon) and **Description**
- Profit General Ledger** (with a search icon) and **Description**
- Loss General Ledger** (with a search icon) and **Description**
- Revalue Into** (with a search icon) and **Description**
- Trading Profit GL** (with a search icon) and **Description**
- Trading Loss GL** (with a search icon) and **Description**
- Netting of Offset Entries**
- Entry Based Revaluation** section:
  - Rate Type** (with a search icon)
  - Transaction Code** (with a search icon)
- Fields** section:
  - Input By** (Date Time)
  - Authorized By** (Date Time)
  - Modification Number**
  - Authorized**
  - Open**

In this screen you can maintain the following parameters to define the revaluation parameters for a GL account:

- | The general ledger accounts to which the profit or loss on revaluation is to be posted
- | The account to which the revaluation profit is to be debited or loss credited
- | The rate type to be used to revalue the GL
- | The transaction code for posting the revaluation entries

- | The rate type to be used for accounting entry-based revaluation of profit and loss GLs
- | The transaction code that would be used to post revaluation entries due to accounting entry-based revaluation of profit and loss GLs

**General Ledger Code**

This is the code of the GL account for which you are specifying revaluation parameters.

**Transaction Code**

This is the transaction code under which the accounting entries would be posted to the defined revalued GL account

**Rate type**

This is the rate type to be used for revaluation of this GL

**Profit General Ledger**

If the result of revaluation is a profit, the profit amount is credited to this profit GL. If, for a GL, you have opted for revaluation split, then Revaluation Profit (as opposed to Trading Profit) is posted into this GL.

Revaluation split segregates revaluation profit / loss into:

- | Trading Profit / Loss – Profit / Loss due to revaluation of FCY entries posted into the GL during the current day.
- | Revaluation Profit / Loss – Profit / Loss due to revaluation of opening FCY balances (excludes current day's turnover).

**Loss General Ledger**

If the result of revaluation is a loss, the loss amount is debited to this loss GL. If, for a GL, you have opted for revaluation split, then Revaluation Loss (as opposed to Trading Loss) is posted into this GL.

**Revalue into**

This GL account is debited if the result of revaluation is a profit; and credited if the result of revaluation is a loss

This would typically be the GL code being revalued. For all non-contingent GLs belonging to the asset or liability categories, the system defaults to the GL being revalued.

If you wish to specify a different account for posting these entries specify by selecting from the list of maintained GLs. A list of all GLs would be displayed. Select.

**Trading Profit Account/Trading Loss Account**

This indicates the GL for posting profit/loss due to trading revaluation (Trading Profit / Loss) if you have indicated that revaluation split is required for a GL.

**Netting of offset entries**

A check against this indicates whether the offset entries for all accounts linked to the GL code need to be netted or not. If checked, a single consolidated entry would be passed (one for profit and one for loss).

---

**Note**

Netting of offset entries is applicable only for normal account revaluation and not for accounting entry-based revaluation of Income/Expense GLs.

---



### **Accounting entry-based revaluation of Income / Expense GLs**

Income/expense GLs that are marked for entry-based revaluation are picked up by the EOD revaluation batch process, which executes before the account revaluation batch process on a given business day.

In the Account Revaluation Maintenance, you must specify the following parameters that would be used by the batch revaluation process, for revaluing FCY entries in Income/Expense GLs:

- | Rate type
- | Transaction code for posting entry-based revaluation entries

You can maintain these parameters for specific Income/Expense GLs. If you wish to maintain these parameters for all Income/Expense GLs, you can specify the 'STDPNL' option in the GL Code field. The 'STDPNL' option signifies that the entry-based parameters being maintained are applicable for all Income/Expense GLs.

When the revaluation batch revalues an Income/Expense GL, it uses the rate type and transaction code maintained for the GL in the Account Revaluation screen. If no maintenance exists for the specific GL, the parameters maintained for the 'STDPNL' GL Code option are used.

---

## 21. Maintaining Branch Holidays

### 21.1 Introduction

For a year, you need to define your weekly holidays and your calendar year annual holidays. This is done in the 'Local Holiday Calendar' screen.

The system uses the information maintained in this screen to do the following:

- To check that the 'value date' of no Data Entry transaction falls on a holiday
- To check that the start date / maturing date and schedule date of a loans and deposit contract does not fall on a holiday
- To effect a date change on the system -- today's date and the next working date

For any schedule / contract maturing at a future date, say, 5 years hence, you can input a future date, only if the calendar for that year has been maintained. It is not necessary to maintain the list of all annual holidays, for future, you can merely define all regular weekly holidays.

This screen is maintained for each branch, of your bank, from the respective branches; thus making it possible to have a different set of holidays for different branches of the bank.

### 21.2 Invoking Local Holiday Screen

Invoke the 'Local Holiday Calendar' screen, by typing 'STDLOCHL' in the field at the top right corner of the Application tool bar and clicking the adjoining arrow button.

The screen is as shown below:

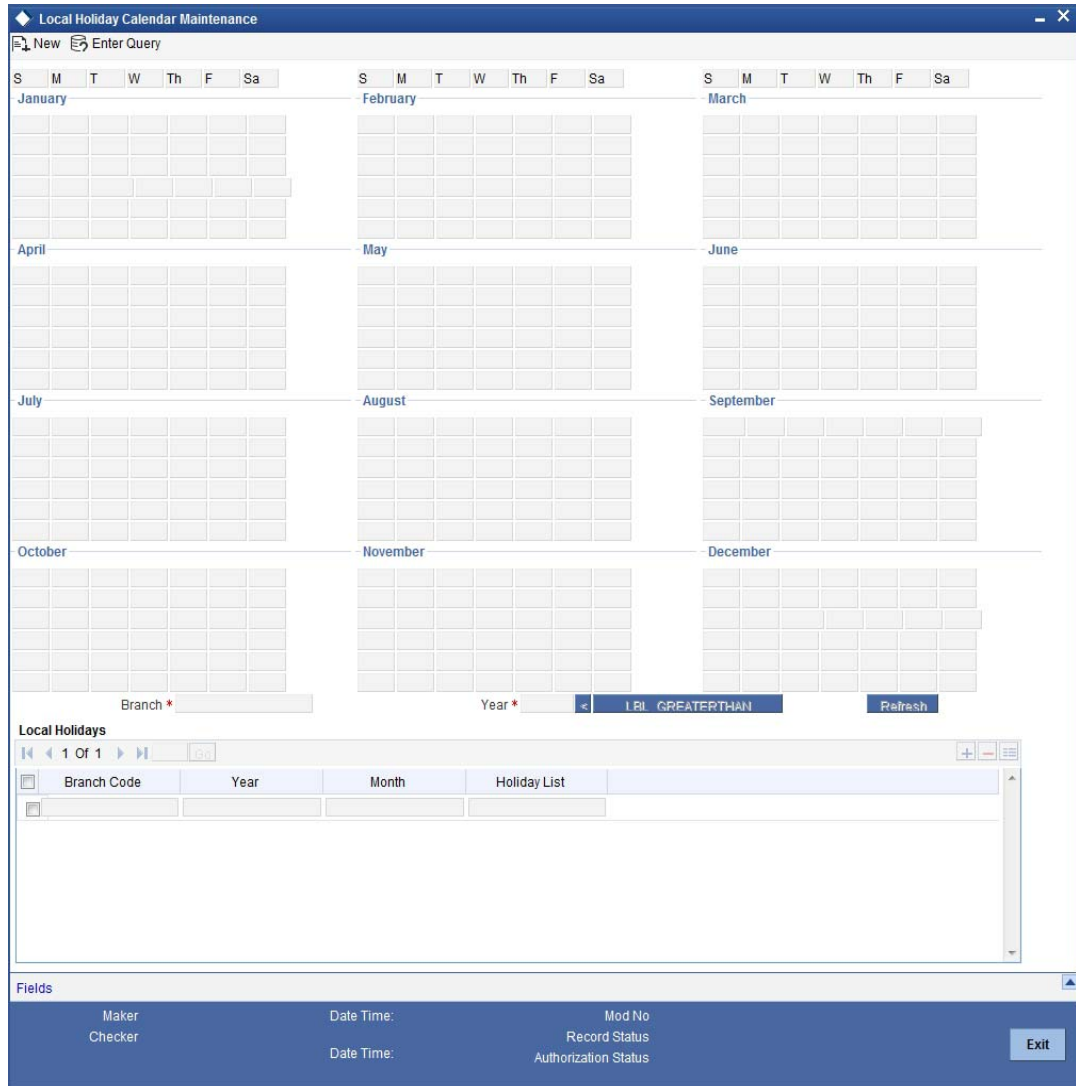

In this screen you can specify the weekly and also the annual holidays, for your branch, for any year between 1 AD and 4000 AD.

### **21.2.1 Steps to Define Yearly Holidays**

To define holidays for a year, (for instance, for 2000) you have to do the following:

Building the calendar for the year

#### **Step 1**

Select 'New' from the Actions menu in the Application tool bar or click new icon

#### **Step 2**

Enter the year -- 2000 or move to the year 2000 using the arrows

#### **Step 3**

To build the calendar for the year, 2000 click the 'Refresh' button. This button is called the 'refresh / build up' button because it builds the calendar for you. Please note:

- On invoking the calendar of any year, you will notice that Saturdays and Sundays are marked as weekly holidays. This is the default setting of the system
- For identification, the working days are marked in black and the holidays in red

- All unauthorised records appear against a blue background. On authorisation of that record, the background is cleared.

### **21.2.2 Defining Holidays**

To define any other weekly holiday, other than the default, double click the day of the week, listed on the top row of the screen. For instance, if you double click on 'F', all Fridays in the year would be marked as holidays.

To clear off the default weekly holidays — Saturdays and Sundays, double click on 'sa' and 's' written on the top row.

To specify, other annual holidays, double click on the date — the date would be marked as a holiday.

If you want to unmark a day specified earlier as a holiday, double click on it, once again. You will notice that the day gets marked in black. Because the change is yet unauthorised, it appears against a blue background.

### **21.2.3 Annual Holidays**

These are the holidays you have defined for the year calendar on display

You will observe that all holidays are marked in red, while working days in black. (All unauthorised holiday dates appear against a blue background). To mark a date as a holiday, double click on it. In case you wish to undo a date marked off as a holiday, double click on it once again. It changes back to a working day.

With each modification you make, the Modification Number in the made by column below moves up serially.

### **21.2.4 Designating Unexpected Holidays for Branch**

The holiday calendar for your branch is maintained in the Branch Holiday Calendar screen.

In addition to the holiday calendar, you may need to designate certain days as holidays unexpectedly, without forewarning. Alternatively, you may also need to roll back a previously defined holiday date or set of dates. You can do this using the 'Unexpected Branch Holiday Maintenance' screen. You can invoke this screen by typing 'CGDUNHOL' in the field at the top right corner of the Application tool bar and clicking the adjoining arrow button.

The screen is as shown below:

The screenshot shows a software interface titled "Unexpected Branch Holiday Maintenance". It features a form with the following fields: "Branch Code \*" (text), "Branch Name" (text), "Holiday/Working Type" (radio buttons for "Holiday" and "Working"), "Holiday Date From \*" (date), "Holiday Date To \*" (date), and "Holiday Reason" (text). Below the form is a "Type Exceptions" table with two columns: "Holiday/Working Date" and "Reversed Flag". The table has one row with a date field and a checkbox. At the bottom, there is a "Fields" section with three columns: "Input By Date Time", "Authorized By Date Time", and "Modification Number". The "Modification Number" column has two checkboxes: "Authorized" and "Open".

In this screen, for the current branch, you can maintain a range of dates, every date within which will be designated as holidays for the branch. You can also provide a reason for the designation.

Every unexpected holiday you designate must be authorized for it to be effective

#### **21.2.4.1 Reversing Designated Holiday**

In the Unexpected Holiday Maintenance screen, you can also reverse a designated holiday before the actual date. Specify the holiday date in the Holiday Date field, and check the Reverse box field alongside it.

When you designate unexpected holidays, any bank or customer value dates for any transactions, that coincided with the holiday are rolled forward. Any accounting entries passed are reversed and fresh entries are passed to reflect the new value date.

---

#### **Note**

For the release of uncollected funds, the original transaction date is considered for availability calculations

---

#### **21.2.4.2 Propagating Local Holidays**

Oracle FLEXCUBE facilitates propagation of holiday details maintained in the head branch to all other active branches. This propagation is based on the value maintained for the CSTB parameter 'PROPOGATION\_OF\_LOH'.

The system defaults the value as 'N' for 'PROPOGATION\_OF\_LOH', indicating that no propagation is allowed for local holidays; however, you can set the value as 'Y' if you need to allow propagation of holidays.

If the 'PROPOGATION\_OF\_LOH' value is maintained as 'Y', then the system will enable propagation of holiday maintenance from Head branch to other active branches under the following condition:

- Holiday details are authorized.
- Holiday details are not maintained for the year for the active branches
- Only when the new holiday details are maintained and authorized for the first time. Propagation of holiday maintenance at HO will be allowed for Un-authorized branch also, subsequent modification after first authorization, if year is not maintained for the branch.
- When a new branch is created and authorized for the first time
- Un-authorized branch with modifications after first authorization and no holiday details maintained for the year
- For the branches which are restricted

Propagated records will have the Maker ID and Checker ID details of the HO.

### **Propagation of Holidays during Modify Operation**

After maintaining 'PROPOGATION\_OF\_LOH' flag as 'Y', if propagation of holidays during modify operation is required, then the parameter 'PROPOGATION\_OF\_LOH\_ON\_MODIFY' should also be set as 'Y' in CSTB\_PARAM.

In this scenario when both parameters are set as 'Y', the propagation of holidays will also happen during modification of head office record and the calendar for all branches will be overwritten by the Head Office calendar.

## 22. Maintaining Currency Holidays

### 22.1 Introduction

You need to maintain a yearly list of holidays, for the currencies, defined in the currency screen. This is done in the 'Currency Holiday Calendar' screen.

The system uses the information maintained in this screen to check whether any settlement, involving a foreign currency (in the foreign Exchange, Money market, Funds Transfer, Loans & Deposit modules) falls on that currency's holiday. If yes, then the system will display a message stating so, and ask the user for an override

For any schedule or contract maturing at a future date say, 5 years hence, you can input the future date, only if the calendar for that year has been maintained.

The currency holiday screen is maintained at the Bank Level by the Head Office

### 22.2 Invoking Currency Holiday Screen

You can invoke this screen by typing 'STDCCHOL' in the field at the top right corner of the Application tool bar and clicking the adjoining arrow button.

The screenshot shows the 'Currency Holiday Calendar Maintenance' application window. It contains a grid of 12 calendar views for the months of the year (January to December). Each month view has a header with day abbreviations (S, M, T, W, Th, F, Sa). Below the grid, there are input fields for 'Currency Code \*' and 'Year \*', and a 'Refresh' button. At the bottom, there is a table titled 'Currency Holidays' with columns for 'Currency', 'Year', 'Month', and 'Holiday List'. The table is currently empty. A 'Fields' section at the very bottom lists 'Input By', 'Authorized By', 'Modification Number', 'Date Time', 'Date Time', and 'Authorized / Open'.

In this screen, you can maintain a list of holidays for each of the currencies maintained in the 'currency screen', for any year between 1 AD and 4000 AD.

## **22.2.1 Steps to Define Currency Holidays**

To define currency holidays for a year, (for instance, for 2000) you have to do the following:

Building the calendar for the year

### **Step 1**

Select 'new' from the Actions menu in the Application tool bar or click new icon. A blank screen appears and the cursor moves to the field 'Year'

### **Step 2**

Enter the year -- 2000 or move to the year 2000 using the arrows

### **Step 3**

To build the calendar for the year, 2000 click on the 'Refresh' button. This button is called the 'refresh / build up' button because it builds the calendar for you

### **Step 4**

Select the currency for which you are defining holidays. Please note:

- On invoking the calendar of any year, you will notice that Saturdays and Sundays are marked as weekly holidays for the currency. This is the default setting of the system.
- For identification, the working days are marked in black and the holidays in red.
- All unauthorised records appear against a blue background. On authorisation of that record the background disappears.

## **22.2.2 Defining Currency Holidays**

To define any other weekly holiday for the currency, other than the default, double click the day of the week, listed on the top row of the screen. For instance, if you double click 'F', all Fridays in the year would be marked as holidays.

To clear off the default weekly holidays — Saturdays and Sundays, double click on 'sa' and 's' written on the top row

To specify, other holidays, double click on that date — the date would be marked as a holiday

If you want to unmark a day specified earlier as a holiday, double click on it, once again. You will notice that the day gets marked in black. Because the change is yet unauthorised, it appears against a blue background

## **22.3 Uploading Holiday File**

SWIFT provides a country-wise holiday file that can be uploaded into Oracle FLEXCUBE. For all countries where 'EUR' is not the local currency, the respective holidays can be uploaded into the currency holidays tables. For European countries, where 'EUR' is the currency, you can upload the TARGET holidays. Oracle FLEXCUBE allows you to upload these currency holidays through the 'BIC/BICPLUS – Upload' screen. You can invoke this screen by typing



'ISDBICPU' in the field at the top right corner of the Application tool bar and clicking the adjoining arrow button.

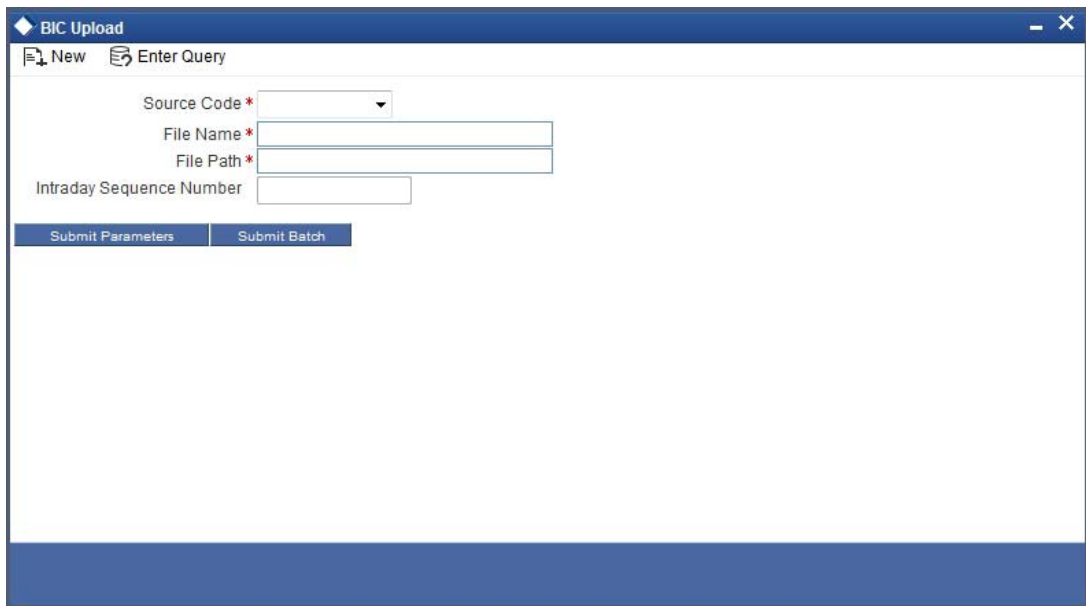

Here you need to choose the source code as 'CCH' from the drop-down list. For further details about this screen, refer the section titled 'Uploading the BIC/BICPLUS files into Oracle FLEXCUBE' in the 'Settlements' User Manual.

The holiday file gets uploaded with two records:

- HF Record – wherein 'EUR' is not the local currency
- HS Record - wherein 'EUR' is the local currency

*For more details on the file formats of these records, refer the chapter titled 'Annexure – B – File Formats'.*

## 23. Maintaining Clearing Holidays

### 23.1 Introduction

You need to maintain a yearly list of holidays of your Clearing House. This is defined in the 'Clearing House Holiday Calendar' screen.

This set of holidays is maintained at the bank level, by the Head Office. You can invoke this screen by typing 'STDCLHOL' in the field at the top right corner of the Application tool bar and clicking the adjoining arrow button.

The screenshot shows the 'Clearing House Holiday Maintenance' application window. The window title is 'Clearing House Holiday Maintenance'. It features a menu bar with 'New' and 'Enter Query'. Below the menu bar are two sets of day-of-the-week buttons (S, M, T, W, Th, F, Sa). The main area is a 3x3 grid of calendar grids for the months: January, February, March, April, May, June, July, August, September, October, November, and December. At the bottom of the grid are input fields for 'Clearing House \*' and 'Year \*', and a 'Populate' button. Below the grid is a 'Holiday Details' section with a list box. At the very bottom is a 'Fields' section with labels for 'Input By', 'Authorized By', and 'Modification Number', and checkboxes for 'Authorized' and 'Open'.

In this screen, you maintain a list of holidays of the Clearing House with which your bank is associated with.

#### 23.1.1 Steps to Define Clearing House Holidays

To define Clearing House holidays for a year, (for instance, for 2000) you have to do the following:

Building the calendar for the year

**Step 1**

Click new icon.

**Step 2**

Enter the year — 2000 or move to the year 2000 using the arrows.

**Step 3**

To build the calendar for the year, 2000 click the 'Refresh' button. This button is called the 'refresh / build up' button because it builds the calendar for you. Please note:

- | Your clearing house can be identified with the name -- SYS, given to it by the Oracle FLEXCUBE system. This is displayed in the field 'Clearing House'
- | Saturdays and Sundays are marked as weekly holidays for the Clearing House. This is the default setting of the system
- | For identification, the working days are marked in black and the holidays in red
- | All unauthorised records appear against a blue background. On authorisation of that record the background disappears

**23.1.2 Defining Clearing House Holidays**

To define an additional holiday, click the particular date which you need to be considered as holiday. The system will mark that date as a holiday. The system will change the color of the date to red.

If you click a date that is already marked as a holiday, the system will clear the holiday and treat that date as a working day. The color of the date text is changed to black, indicating that it is no more a holiday.

**23.1.3 Designating Unexpected Holidays for Clearing House**

The holiday calendar for your clearing house is maintained in the Clearing House Holiday Calendar screen

In addition to the holiday calendar, you may need to designate certain days as holidays unexpectedly, without forewarning. Alternatively, you may also need to roll back a previously defined holiday date or set of dates. You can do this using the 'Unexpected Holiday Maintenance' screen.

You can invoke this screen by typing 'CGDCLHOL' in the field at the top right corner of the Application tool bar and clicking the adjoining arrow button.

The screenshot shows a software window titled "Unexpected Clearing House Holiday Maintenance". At the top left, there are "New" and "Enter Query" buttons. The main form area contains several input fields: "Clearing House \*" (with a dropdown arrow), "Description" (with a help icon), "Holiday/Working Type" (with radio buttons for "Holiday" and "Working"), "From \*" (with a date picker), "To \*" (with a date picker), and "Reason" (with a help icon). Below the form is a table titled "Type Exceptions" with two columns: "Holiday/Working Date" and "Reversed Flag". The table has a scroll bar on the right. At the bottom of the window, there is a "Fields" section with three columns: "Input By Date Time", "Authorized By Date Time", and "Modification Number". Under "Modification Number", there are two checkboxes: "Authorized" and "Open".

In this screen, for a clearing house, you can maintain a range of dates, every date within which will be designated as holidays for the clearing house. You can also provide a reason for the designation.

Every unexpected holiday you designate must be authorized for it to be effective

### **23.1.3.1 Reversing Designated Holiday**

In the Unexpected Holiday Maintenance screen, you can also reverse a designated holiday before the actual date. Specify the holiday date in the Holiday Date field, and check the Reverse box field alongside it.

When you designate unexpected holidays, any bank or customer value dates for clearing transactions, that coincided with the holiday are rolled forward. Any accounting entries passed are reversed and fresh entries are passed to reflect the new value date.

---

#### **Note**

For the release of uncollected funds, the original transaction date is considered for availability calculations.

---

---

## 24. Document Maintenance

### 24.1 Introduction

Before opening an account, the customers are expected to furnish the documents to the bank.

The following sections in this chapter discuss about the type of document to be submitted and the document checklist to be maintained.

### 24.2 Maintaining Document Type

You can maintain the various document types in the 'Document Type Maintenance' screen. To invoke this screen, type 'CSDDOCTY' in the field at the top right corner of the Application toolbar and click the adjoining arrow button.

Document Type *	Document Type Description

Specify the following details:

#### Document Category

Specify the document category. The adjoining option list displays all the document categories that are maintained in the system. You can select the appropriate one.

#### Document Type

Specify the type of document.

#### Document Description

Specify a brief description for the document.

### 24.3 Viewing Document Type Details

You can view the document type details in the 'Document Type Summary' screen. To invoke this screen, type 'CSSDOCTY' in the field at the top right corner of the Application toolbar and click the adjoining arrow button.

The screen is as shown below:

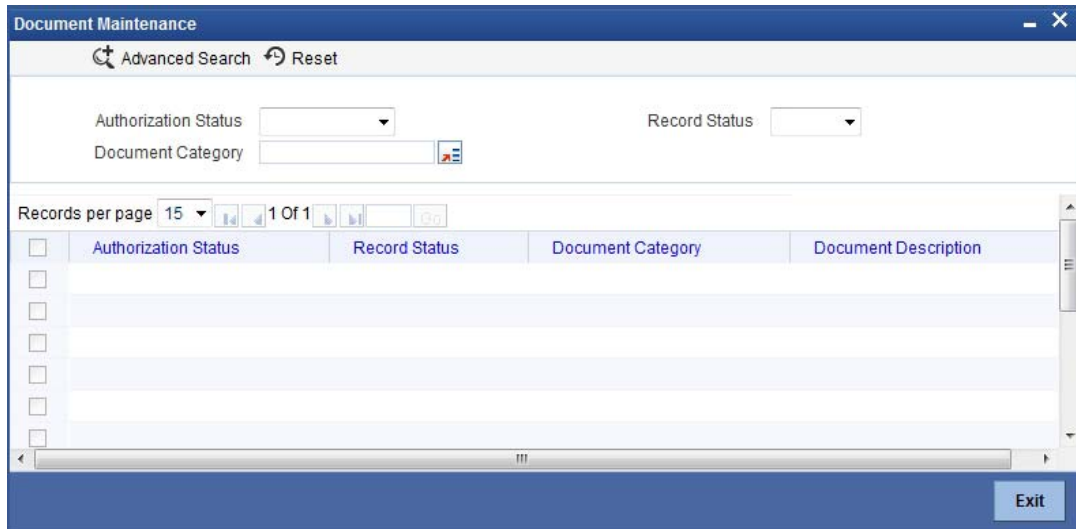

You can query on records based on any one or all of the following criteria:

- | Authorization Status
- | Record Status
- | Document Type
- | Document Category
- | Document Description

Click 'Search' button. The system identifies all records satisfying the specified criteria and displays the following details for each one of them:

- | Authorization Status
- | Record Status
- | Document Type
- | Document Category
- | Document Description

## 24.4 Maintaining Document Checklist Details

You can maintain the various document checklist details in the 'Document Checklist Maintenance' screen. To invoke this screen, type 'CSDDOCHK' in the field at the top right corner of the Application toolbar and click the adjoining arrow button.

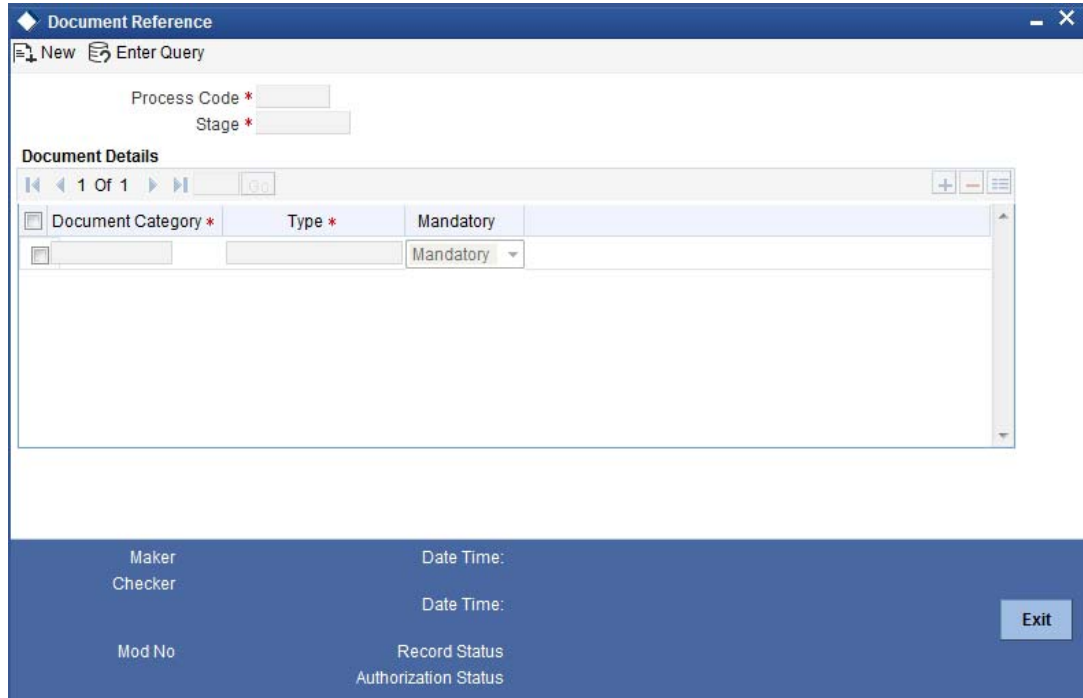

The screenshot shows the 'Document Reference' application window. At the top, there are buttons for 'New' and 'Enter Query'. Below these are two input fields: 'Process Code \*' and 'Stage \*'. The main section is titled 'Document Details' and contains a table with the following columns: 'Document Category \*', 'Type \*', and 'Mandatory'. The table has one row with a dropdown menu showing 'Mandatory'. At the bottom of the window, there are several fields: 'Maker', 'Checker', 'Mod No', 'Date Time:', 'Record Status', and 'Authorization Status'. An 'Exit' button is located in the bottom right corner.

Specify the following details:

### Process Code

Specify the process code. The adjoining option list displays the process codes that are maintained in the system. You can select the appropriate one.

### Stage

Specify the stage in which you need to maintain the checklist details.

### Document Category

Specify the document category. The adjoining option list displays all the document categories that are maintained in the system. You can select the appropriate one.

### Document Type

Specify the type of document.

### Mandatory

Indicates whether the document is needed for checklist.

## 24.5 Viewing Document Type Details

You can view the document type details in the 'Document Checklist Summary' screen. To invoke this screen, type 'CSSDOCHK' in the field at the top right corner of the Application toolbar and click the adjoining arrow button.

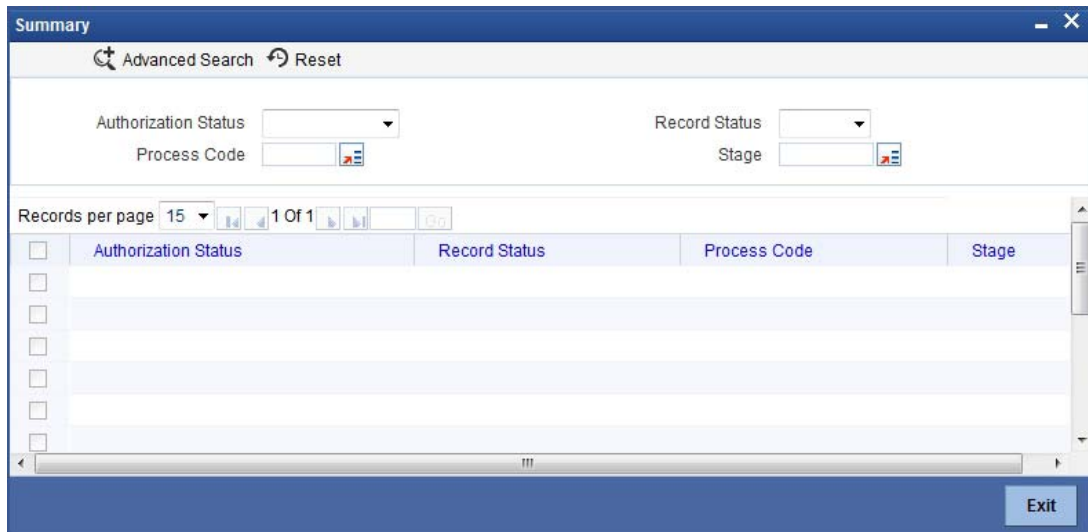

The screenshot shows a web application window titled 'Summary'. At the top, there are 'Advanced Search' and 'Reset' buttons. Below this, there are four search filters: 'Authorization Status' (dropdown), 'Record Status' (dropdown), 'Process Code' (text input with a search icon), and 'Stage' (text input with a search icon). Below the filters, there is a 'Records per page' dropdown set to '15' and a '1 Of 1' indicator. The main area contains a table with the following columns: 'Authorization Status', 'Record Status', 'Process Code', and 'Stage'. The table is currently empty. At the bottom right of the window, there is an 'Exit' button.

You can query on records based on any one or all of the following criteria:

- | Authorization Status
- | Record Status
- | Process Code
- | Stage

Click 'Search' button. The system identifies all records satisfying the specified criteria and displays the following details for each one of them:

- | Authorization Status
- | Record Status
- | Process Code
- | Stage



---

## 25. Configuring Overrides

### 25.1 Introduction

The system displays messages in respect of errors that occur when you execute operations during a work session, in any module. These error messages are also displayed in respect of automatic or batch processes, such as end of day processes.

Depending upon your requirements at your installation, you might require some of the errors to be ignored, and others to result in an override being sought from the user for the operation to proceed. For still others, you might require an online authorization for the operation to proceed. Accordingly, the implementers at your installation configure the sensitivity of such errors. Subsequently, you might also need to configure errors to suit your requirements.

#### 25.1.1 Types of Overrides

In Oracle FLEXCUBE, you can assign a level of sensitivity to each override that arises or occurs during system operation. This level of sensitivity that you assign to an override indicates the action that will result when that specific override occurs. Accordingly, you can assign any of the following sensitivity levels to an override:

##### **Ignore**

This would mean that no override message would be displayed and the exception would be ignored

##### **Override**

This sensitivity indicates that an override message should be displayed, seeking confirmation from the user. If the user confirms or accepts the override, processing of the transaction would proceed; if not, the exception would have to be corrected before transaction processing can proceed.

For such overrides, you can assign an additional parameter to indicate whether an online authorization is required if the override is accepted. If you have assigned online authorization to be required, then, for transactions involving such overrides, an online authorization is requested as a mandatory procedure. The online authorization limit specified for the authorizer would be checked during authorization, in addition to the time level of the authorizer, which should be greater than the user who is input the transaction.

For such overrides, if you have specified that no online authorization is required, the user can accept the override, and it will not require any online authorization.

##### **Error**

This would indicate that, when an exception occurs, an override message would be displayed, and the transaction cannot be processed further, that is, it would stop being processed until the exception is corrected.

##### **Online Authorization**

This would indicate that an override message would be displayed, seeking confirmation from the user. However, in this case, online authorization would be required as a mandatory procedure, if the override were accepted.

##### **Dual Authorization**

This would indicate that an override message would be displayed, seeking confirmation from the user. However, in this case, online authorization would be required as a mandatory procedure, if the override were accepted. Also, at least two authorizers would be needed to authorize the transaction.

## Override Types for Batch Functions

For exceptions occurring during execution of automatic or batch processes, you can assign the Ignore, Override or Error sensitivities.

## 25.2 Specifying Override Type

In the 'Overrides Maintenance' screen, all the error messages that would appear in each module, with their respective error codes, are displayed. The functions, with respect to which the error messages could be encountered, are also displayed. You can invoke this screen by typing 'CSDOVDME' in the field at the top right corner of the Application tool bar and clicking the adjoining arrow button.

The screenshot shows the 'Overrides Maintenance' window. At the top, there is a 'Save' button and a 'Language' dropdown menu. Below this is the 'Error Details' section, which contains several input fields and dropdown menus: 'Type' (set to 'Ignore'), 'Function', 'Message', 'Confirm' (checkbox), 'Maximum Sub Parameters', 'Batch Type' (set to 'Ignore'), and 'Error Code \*'. At the bottom of the window, there is a 'Fields | Conversion' table with columns for 'Maker', 'Checker', 'Mod No', 'Date Time', 'Record Status', and 'Authorization Status'. A 'Cancel' button is located in the bottom right corner of the window.

In the Type field, you can specify, for each error message, the appropriate sensitivity level – Ignore, Override, Error, Online Authorization or Dual Authorization.

For error messages in respect of automatic or batch functions, you can specify the appropriate level in the Batch Type field – Ignore, Override or Error.

For certain overrides, (to which you have assigned the level Override, Online Authorization or Dual Authorization), you can indicate whether the authorizer must also confirm the override, by checking the Confirm box.

---

### Note

You can make changes to configurable overrides in the Error Codes Maintenance screen only after consulting the support team at your installation.

---

## 25.2.1 Maintaining Override Conversion

Click 'Conversion' button on the 'Overrides Maintenance' screen to maintain the conversion error codes for the override error code using 'Overrides Conversion' screen.

You can enter the following details:

### **Branch Code**

Specify the branch code. If ALL is specified, in all the branches the conversion will be done. However if it is maintained for a specific branch, only in that branch the conversion will be done.

### **Function Id**

Specify function Id for which the override should be treated as error.

### **New Error Code**

You can map an already existing error code as the conversion error code or can use the 'Override Maintenance' screen to define the same.

You are not allowed to maintain/map conversion error codes for the error code which is a conversion error-code.

---

### **Note**

- If you encounter overrides while processing, the system will check if any conversion error code mapped for the override for the combination of branch and function Id. If available then the system will raise the mapped error code instead of the original error code.
  - The system will allow you to map conversion codes only for the error codes with type as 'Override'.
  - If a modifiable error code is changed from 'Override' to 'Error', then the system will delete all the conversion error codes maintained for the same.
- 

## 25.2.2 Maintaining Error Codes

According to the requirements of your bank, you can configure the system to display an error message if you have not opted for batch balancing at the time of opening a batch.

This is indicated in the 'Overrides Maintenance' screen before opening a batch.

You can invoke the 'Overrides Maintenance' screen by typing 'CSDOVDMT' in the field at the top right corner of the Application tool bar and clicking the adjoining arrow button.

The screenshot shows the 'Overrides Maintenance' application window. The interface includes a top navigation bar with 'New' and 'Enter Query' buttons. The main area is divided into sections: 'Language' with a 'Language \*' dropdown and a 'Description' text field; 'Error details' with 'Error Code \*', 'Type' (set to 'Ignore'), 'Function', 'Message', 'Parameters', and 'Batch Type' (set to 'Ignore'). A 'Confirm' checkbox is located below the 'Message' field. The bottom of the window features a 'Fields | Conversion' tab and a status bar with 'Input By', 'Authorized By', and 'Modification Number' fields, and checkboxes for 'Authorized' and 'Open'.

According to your instructions in the 'Overrides Maintenance' screen, Oracle FLEXCUBE will either:

- Display an error message if balancing is not allowed at the time of opening a batch (system will allow you to enter the details of the journal entry only if the option 'Balancing' is checked)
- Display an override message reminding that the batch that has been opened will not be balanced (even if the option 'Balancing' is unchecked, system will display an override and allows you to proceed further and enter the journal entry details)
- Ignore your selection for the option 'Balancing'. System will not display an error message or override irrespective of your selection for the option 'Balancing' and you can proceed to enter the details of the journal entry in the 'Journal Entry' screen.

According to the requirements of your bank, indicate your option (Error, Override, or Ignore) for the error code DEBATBAL-1.

Depending on your selection in the 'Overrides Maintenance' screen for the error code DEBATBAL-1, system will either display an error message or an override message or will just ignore your selection for the option 'Balancing'.

In the 'Overrides Maintenance' screen, if you have indicated the 'Type' as 'Error' and if you don't opt for 'Balancing, system will display an error message as "The batch is not balanced".

and 'Balancing' is automatically checked. In other words, it is mandatory to opt for balancing. This is to ensure that all batches that are opened to post entries are balanced.

If you have indicated the Type as 'Override' and you haven't checked the option 'Balancing' system will display an override message as "The batch is not balanced. Do you want to proceed? Yes/No".

You can proceed to enter the details of the journal transaction if you select 'Yes'.

If you have opted for 'Ignore' in the 'Error Codes Maintenance' screen, irrespective of whether you opt for balancing of batches or not, system will allow you enter the details of the journal transaction in the 'Journal Entry' screen (system will not display an error message or an override).

---

## 26. Maintaining Features

### 26.1 Introduction

In order to improve the performance of the system during online or batch processes, you can install some features on need basis on the system. This chapter explains the process of installing features.

### 26.2 Maintaining Feature ID

To maintain feature IDs, which can subsequently be selected in the 'Feature ID Maintenance' screen, invoke the 'Feature Maintenance' screen. To invoke this screen, type 'CSDFTRMN' in the field at the top right corner of the application tool bar and click the adjoining arrow button.

The screenshot shows a software window titled "Feature Maintenance". At the top left, there is a search icon and the text "Enter Query". Below this, there is a text input field labeled "Feature \*". Underneath the input field is a checkbox labeled "Applicable" which is checked. At the bottom of the window, there is a section titled "Fields" with several labels: "Maker", "Checker", "Date Time:", "Mod No", "Record Status", and "Authorization Status". An "Exit" button is located in the bottom right corner of the window.

Specify the following details in this screen:

**Feature**

Specify a feature ID which can be subsequently selected in the Feature Maintenance screen.

**Applicable**

Check this box to indicate whether this feature is applicable.

You can maintain required features using the 'Feature ID Maintenance' screen. You can invoke this screen by typing 'CSDFEMNT' in the field at the top right corner of the Application tool bar and clicking the adjoining arrow button.

You can specify the following details:

### Branch Code

Specify the branch where the feature needs to be installed. The adjoining option list displays all valid branch codes maintained in the system. You can select the appropriate one.

### Branch Name

The branch name is displayed here based on the chosen branch code.

### Feature Id

Specify the feature that should be installed in the branch. You can also choose any of the following values from the adjoining option list:

Feature Id	Description	Mode - Online/Batch
ACCRESTR	Account Restriction feature which need to be enabled for replace amounts in overrides with wild char (*)	Online
ACSTHAND	Account Statement Handoff during EOD	Batch
APY	Movement of Annual Percentage Yield to history	Batch
CCYPOS	CCY position entries updation during EOD	Batch
CUSTOMIS	building of Customer MIS details Transaction/Composite/Fund	Online

DDRECLOG	During Demand Draft creation - update of record log and field log	Online
DEFERLIQ	IC Deferred Liquidation	Batch
DORMUPD	Dormancy update during EOD	Batch
DRINTDUE	Dr. Interest Due	Batch
FCTDSTATS	Financial cycle wise account statistics update	Batch
GLCUSTSTATS	Period/Financial cycle wise customer GLs statistics update	Batch
GLFCTDSTATS	Financial cycle wise GL statistics update	Batch
GLPTDSTATS	Period wise GL statistics	Batch
ICINTSTMT	IC Interest Statement generation	Batch
ICRATECHG	Rate change Advice	Batch
IRASTMT	IRA Statement generation during EOD	Batch
LDSTMT	Loan Statements generation during EOD	Batch
LINKSTMTAC	Update of Previous Statement Date and No during statement generation	Batch
PRODTXNREST	Product and Transaction code restrictions applicability	Batch
PTDSTATS	Period wise account statistics update	Batch
RAC	Account entry serial number derivation logic when multiple FCUBS instances exists	Online/Batch
REGCC	Regulatory CC update for customer account during EOD	Batch
TRACKACCRINT	Tracking of Accrued interest	Batch
USREGCHGS	US Regulatory changes	Batch
VDBALINIC	VD balance update. This is equivalent to flag at bank parameters level	Online

### Installed

Check this box to indicate that the feature should be installed in the branch.

Click save icon in the Application tool bar to save the changes.

### **26.2.1 Specifying UDF Values**

All User Defined Fields (UDFs) linked to the function ID 'CSDFEMNT' are displayed in the 'User Defined Fields' screen. Invoke this screen by clicking 'Fields' button on the 'Feature ID Maintenance' screen.



The screen is as shown below:



Here you can specify values for each UDF.

Refer the User Manual titled 'User Defined Field' for details about defining UDFs.

## **26.3 Viewing Feature ID Summary**

You can view summary of all feature IDs installed across branches, using the 'Feature ID Summary' screen. To invoke this screen, type 'CSSFEAMT' in the field at the top right corner of the Application tool bar and click the adjoining arrow button.

The screen is as shown below:

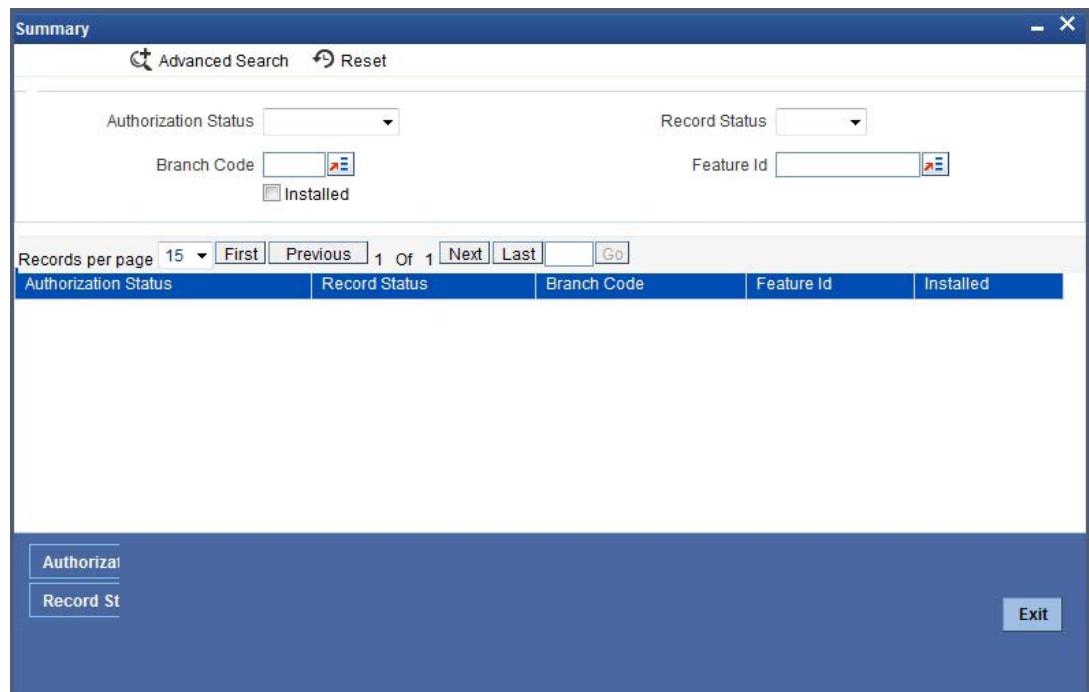

You can query on records based on any one or all of the following criteria:

- I Authorization Status
- I Record Status

- | Branch Code
- | Feature ID
- | Installed

Click 'Search' button. The system identifies all records satisfying the specified criteria and displays the following details for each one of them:

- | Authorization Status
- | Record Status
- | Branch Code
- | Feature ID
- | Installed

Double click on a record to invoke the detailed screen for that record.

---

## 27. Purging and Archiving Data

### 27.1 Purging Data

Purging is a process by which you remove unwanted data from the system. For example, you may find the interest rates that you have maintained for a financial cycle useless a couple of years later. You would want to remove such data from the system. You can achieve this by 'purging' the data of the system.

There are two types of purging data:

- Module Purging
- Entity Purging (User Defined)

### 27.2 Module Purging

The purge function of Oracle FLEXCUBE allows you to purge:

- Contracts and transactions that you have entered into,
- Data relating to transactions (such as, interest rates)
- Limits history (Liability, Lines and Line Utilization history)
- GL Average Balance and Customer Account statistics

You can purge the contracts (or transactions) that you have entered into in the following modules of Oracle FLEXCUBE:

- Foreign Exchange
- Money Market
- Loans
- Deposits
- Data Entry
- Standing Instructions
- Letters of Credit
- Bills and Collections

You can purge data from the following modules:

- Accounting
- Currency
- General Ledger
- Interest and Charges
- Messaging
- MIS
- Reconciliation
- Receivable Liquidation

You can also purge data relating to transactions. For example, you can purge the currency rates that you have maintained, the messages in the messaging system of Oracle FLEXCUBE, the User Data Elements that you used to compute interest, interest statement details, user information maintained in the Security Management System of Oracle FLEXCUBE, customer information, and so on.

The system will automatically purge data according to the parameters that you define in the Purge Details Maintenance screen.

## 27.3 Maintaining Purge Details

In the 'Purge Details Maintenance' screen, you can define the parameters for purging data from the system. For instance, you may want to purge the contracts entered into in the previous financial cycle. Or, you may want to retain exchange rates in the system for a specific period. These are examples of parameters that you can define in the Purge Details Maintenance screen. You can invoke this screen by typing 'CSDPURGE' in the field at the top right corner of the Application tool bar and clicking the adjoining arrow button.

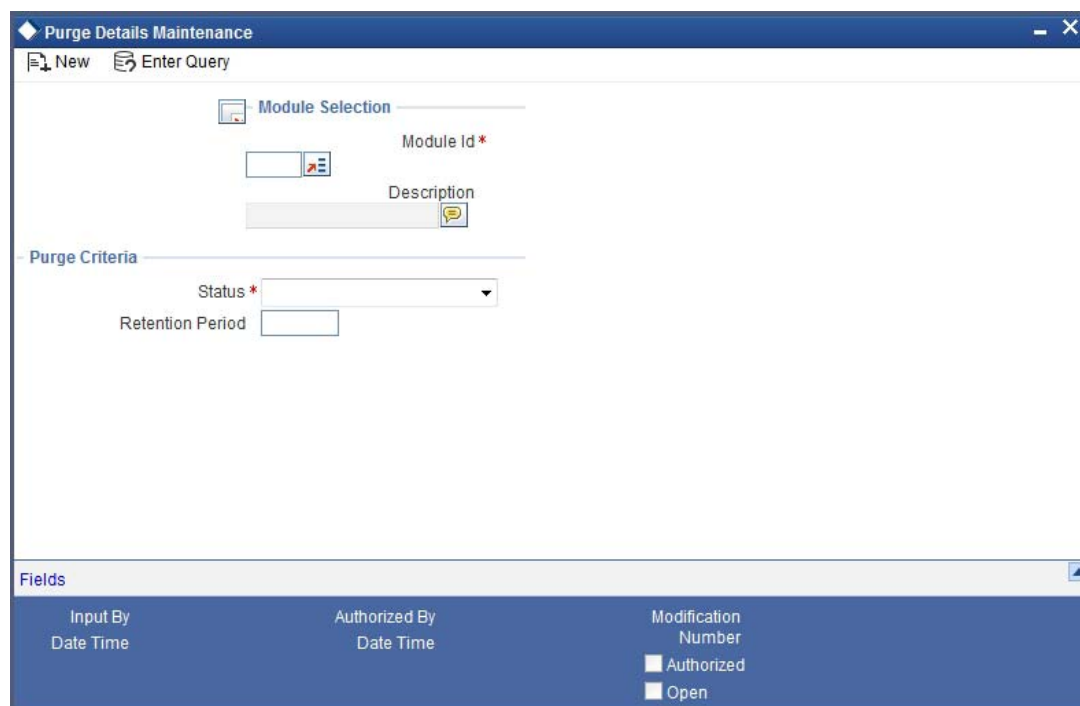

### 27.3.0.1 Specifying Module

In the Purge Details Maintenance screen you must first specify the module for which you are defining parameters. All parameters that you define subsequently will only apply to the module that you specify.

You can enter a description of the module for which you are maintaining purge details.

---

#### **Note**

For purging limits history which is Liability, Lines, and Lines Utilization history, you must specify LM as the module code. Limits history data is purged for the current branch only.

---

### 27.3.0.2 Specifying Nature of Data to be Purged

You can opt to purge contracts (of the module you specified) along the following criteria. You may either choose to purge any of the following:

- Liquidated contracts
- Closed (applicable only to the BC and LC modules)
- Reversed contracts

When you run the purge process, only those contracts that are in the status that you specified will be purged. That is, only contracts (in the module you specified) that are liquidated, closed, and/or reversed, depending on your specification, will be purged from the system.

Similarly, if you want to purge

- Exchange rates (from the Currency module), you should choose the 'None' option.
- Data from the Reconciliation module, you should choose any of the following options, depending on the data that you want to purge. The options available are:
  - System Date Relative
  - Match Relative
  - Closed Match
  - Closed External Statement

### **Retention Period**

The retention period, as the term suggests, is the period for which data is stored in the system. For each module in Oracle FLEXCUBE, you can specify the retention period.

When you run the purge process on any given day, only the data that is beyond the retention period that you specified will be purged. The following example illustrates this concept.

For example,

The requirement: You would like to retain foreign exchange contracts that were liquidated 60 days prior to the running of the purge process, in the system. (That is, if the current system date is 30 June 1999 and you do not wish to purge the foreign exchange contracts that were liquidated between 1 May 1999 and 30 June 1999).

Solution: In the Retention Period field enter '60' (note this value is expressed in days), and in the 'Status' field choose the 'Liquidated' option.

Result: If this setup is authorised, and you run the purge process on 30 June 1999, the current system date, all foreign exchange contracts that you liquidated prior to 1 May 1999 will be purged. Contracts that were liquidated on or after 1 May 1999 will not be purged.

## **27.4 Entity Purging**

In entity purging, you can archive or purge the data from the main tables and its child tables. You can also configure the purge type and the frequency of data purging.

There are 3 parts in an entity purging:

### **Purge Parameter Definition**

The purge parameter definition is achieved through ODT. The ODT generates the purge source files which is then deployed in Oracle FLEXCUBE.

The ODT is used for the following:

- Maintaining the list of entities that need to be purged.
- Maintaining the purge behaviour.
- Maintaining the mode of purge.
- Maintaining the purge frequency.
- Maintaining the archive table suffix if the purge behaviour is to archive the data.
- Maintaining the filter criteria to determine what data to purge.

You can capture the above parameters to define the entity and purge preferences.

### **Purge Parameter Configuration**

Once the ODT generated scripts are deployed in Oracle FLEXCUBE, they can be re-configured in the purge parameter configuration.

### **Purge Execution**

You can execute the purge in two modes:

- Batch Mode - In the batch mode you have to maintain the purge entity batch CSBPURGE. The AEOD batch process starts the purge process in which all the entities that are scheduled for purge on that day gets purged.
- Ad-hoc Mode - This mode supports purging of a single entity at any time.

You can define entities for purging in any module. However, pre-defined entities are available for the following modules:

- Accounting
- Bills and Collections
- Letters of Credit
- Funds Transfer
- SWITCH

## **27.4.1 Configuring Purge Parameters**

You can configure the parameters for purging the data through 'Purge Parameter Configuration Maintenance' screen. You can query and modify entities in this screen. However new operation is not allowed. To invoke this screen type 'STDPGMNT' in the field at the top right corner of the Application tool bar and clicking the adjoining arrow button.

The screenshot shows the 'Purge Parameter Configuration' application window. At the top, there's a title bar with a diamond icon and window controls. Below the title bar is an 'Enter Query' section with several input fields: 'Entity Id \*', 'Purge Frequency' (a dropdown menu currently showing 'Daily'), 'Next Purge Date', 'Commit Frequency' (with the value '100'), 'Description', 'Last Purge Date', and 'Query'. Below these fields is a table with the following columns: 'Filter Name', 'Column', 'Data Type', 'Left Hand Side', 'Operator', and 'Right Hand Side \*'. The table is currently empty. At the bottom of the window, there's a 'Branch Restriction' section with fields for 'Maker', 'Checker', 'Mod No', 'Date Time:', 'Record Status', and 'Authorization Status'. An 'Exit' button is located in the bottom right corner.

The following details are captured in this screen:

**Entity Id**

Select the entity Id from the adjoining option list.

**Purge Frequency**

Select the frequency of purge from the adjoining drop-down list. The available options are:

- Ad-hoc - If the frequency is selected as Adhoc, then this particular entity will not be picked up for purging in the batch purge. This entity can be purged only by the Adhoc Purge option.
- Daily - The purge routine for the entity having daily frequency will run daily
- Weekly - The purge routine for the entity having weekly frequency will run every week. The day of the week will be determined based on the purge start date. If the purge start day is a Monday, then the purge routine runs on every Monday. If you want to change the day of the week, then 'Next Purge Date' needs to be updated.
- Monthly - The purge routine for the entity having monthly frequency will run every month. It is advised that the purge routines are not configured during the month-ends, as Purge Anniversary dates so as to reduce the processing load on the month-ends
- Quarterly - The purge routine for the entity having quarterly frequency will run every quarter.
- Half-Yearly - The purge routine for the entity having half-yearly frequency will run every 6 months.
- Yearly - The purge routine for the entity having yearly frequency will run every year.

**Last Purge Date**

The system displays the date on which the entity is purged.

**Next Purge Date**

Specify the next date for purging the entity. The system populates this date if purge frequency is not ad-hoc.

The next purge date is left blank initially. The system picks up for automatic purging of data and updates the subsequent dates only if the next purge date is provided.

**Commit Frequency**

Specify the commit frequency while purging the data. The default value for commit frequency is 100.

For example,

If the value is 100 (which is default), then the purge routine will commit after every 100 records.

**Query**

The system displays the full query for the entity.

**Filter Details****Filter Name**

The system displays the name of the purge filter criteria.

**Column Data Type**

The system displays the data type for the filter.

**LHS**

The system displays the LHS of the filter expression.

## Operator

The system displays the operator for the filter.

## RHS

The system displays the RHS or the value for the expression based on which data is purged. However RHS can be modified.

## Branch Restrictions

Click on 'Branch Restrictions' to allow or disallow entities across branches.

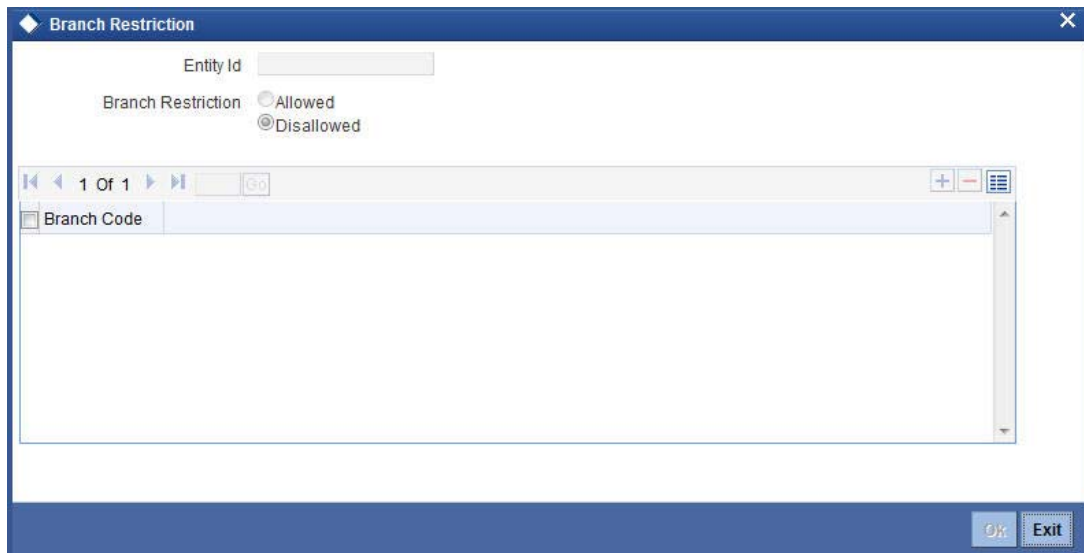

The screenshot shows a window titled "Branch Restriction" with a close button (X) in the top right corner. Inside the window, there is a text input field labeled "Entity Id". Below it, the "Branch Restriction" section has two radio buttons: "Allowed" (which is unselected) and "Disallowed" (which is selected). A pagination bar shows "1 Of 1" with navigation arrows and a "Go" button. Below the pagination bar is a table with a header "Branch Code" and an empty body. At the bottom right of the window, there are "Ok" and "Exit" buttons.

### Entity Id

The system displays the entity ID.

### Branch Restriction

Indicate whether the branch restriction is 'Allowed' or 'Disallowed'.

### Branch Code

The system displays the branch code. However, you can add the branch codes here.

You should configure the branch restrictions as part of first time entity configurations.

## 27.4.2 Viewing Purge Parameter Configuration Details

You can view the purge parameter configuration details maintained in the 'Purge Parameter Configuration' screen using the 'Purge Parameter Configuration Summary' screen. You can



invoke this screen by typing 'STSPGMNT' in the field at the top right corner of the Application tool bar and clicking on the adjoining arrow button.

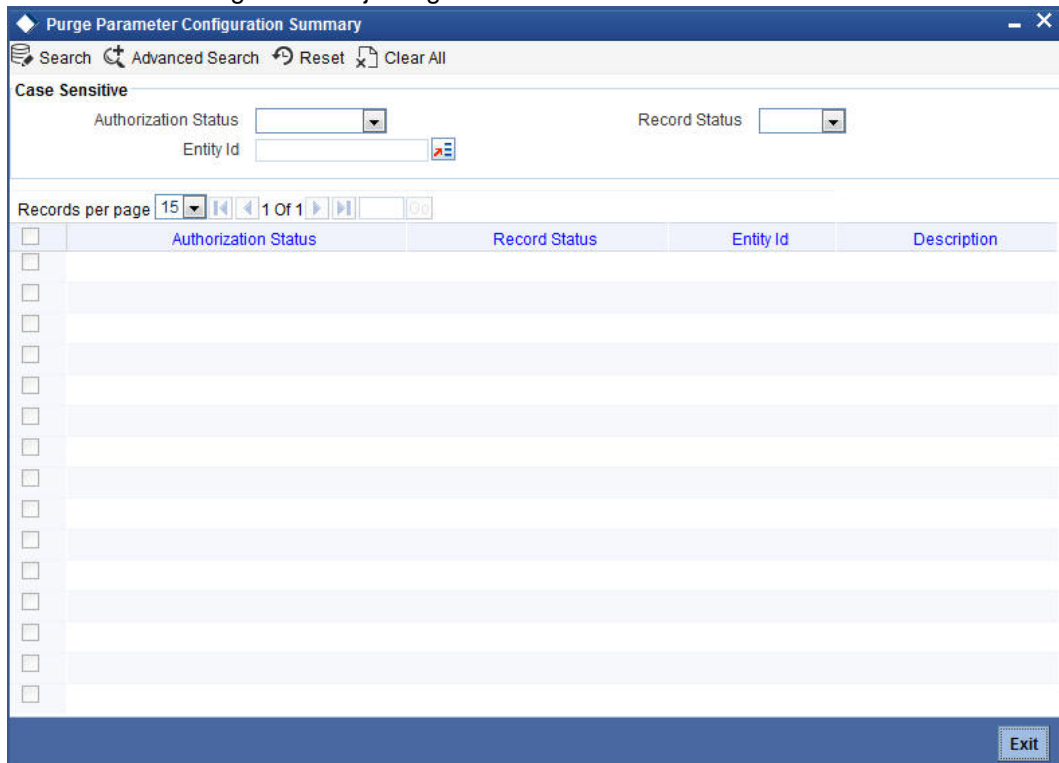

In the above screen, you can base your queries on any or all of the following parameters and fetch records:

- Authorization Status
- Entity Id
- Record Status

Select any or all of the above parameters for a query and click 'Search' button. The system displays the records meeting the selected criteria:

- Authorization Status
- Record Status
- Entity Id
- Description

### 27.4.3 Processing Ad-hoc Purge

You can process ad-hoc purge through 'Ad-hoc Purge Process' screen. An entity configured as automatic can also be started from this screen. However, this would not change the regular frequency cycle of the entity. The next purge date is not effected or changed if started from

this screen. To invoke this screen type 'AEDPGOP' in the field at the top right corner of the Application tool bar and clicking on the adjoining arrow button.

### Entity Id

Select the entity ID from the adjoining option list.

### Purge Frequency

The system displays the purge frequency.

### Number of Threads

The system displays the number of parallel streams in which the purge should be run. However, you can modify it. The purge batch process is split into specified numbers and executed in separate threads.

### Description

The system displays description on the entity ID.

### Next Purge Date

The system displays the next purge date.

### Last Purge Date

The system displays the last purge date.

### Query

The system displays the query for the entity.

The system displays the following details:

- Filter Name - Name of the purge filter criteria
- Column Data Type - Data type of the filter
- LHS - LHS of the filter expression
- Operator - The operator for filter
- RHS - RHS or the value for the expression based on which data is purged. However, you can modify this.

---

**Note**

- Only 'Execution Filter' conditions are displayed in the Filter Condition Multi Entry Block.
  - 'Business Filter' conditions will not be displayed.
- 

#### 27.4.4 **Parallel Stream Maintenance**

You can inquire the number of streams through 'Parallel Stream Maintenance' screen. To invoke this screen type 'CSDPSTMN' in the field at the top right corner of the Application tool bar and clicking on the adjoining arrow button.

Parallel Stream Maintenance

Enter Query

Function Id \*      Number of Streams \*

Fields

Maker	Date Time:	Mod No
Checker	Date Time:	Record Status
		Authorization Status

Exit

**Function Id**

Select the function ID from the adjoining option list.

**Number of Streams**

The system displays the number of streams in which the purge should be run. The purge batch process is split into specified numbers and executed in separate threads.

## 27.4.5 Inquiring Purge Log

You can inquire the purge history through the Purge Log Inquiry screen. To invoke this screen type 'AEDPGLOG' in the field at the top right corner of the Application tool bar and clicking on the adjoining arrow button.

Entity Id	Run ID	Date	Start Time	End Time	Status	Error	Number of Records	Query
-----------	--------	------	------------	----------	--------	-------	-------------------	-------

### Entity Id

Select the entity Id from the adjoining option list.

### From Date

Specify the date from when the log should be enquired.

### To Date

Specify the date till when the log should be enquired.

The system displays the following details:

- Entity ID
- Run ID
- Date
- Start Time
- End Time
- Status
- Error
- Number of Records
- Query

## 27.5 Archiving Data

You can archive entities on a regular basis. Archival would involve moving data from the production data stores to designated archival data stores based on the archival criteria specified.

Following are the steps involved in setting up the archival function:

1. **Archival Framework:** You can define a framework for archival generically and perform the following actions:

- Identify and define functional areas that needs to be archived
- Identify entities that should be archived and understand the relationships between them
- Specify names for archival data stores
- Define archival criteria, frequency and mode of archival. You can define the logic needed for archival

The archival framework performs the archival for each functional area as mentioned below:

- Defines archival data stores for each of the production data store. The archival data stores are created in a separate schema in the production database itself.
  - For each of the archival data store, a synonym is created in the production schema.
  - The archival routine moves the data from the production data stores to the archival data stores using the synonym created.
2. **Execution of Archival Framework:** Archival framework dynamically produces executables for each functional areas identified for archival. These executables should be scheduled using any scheduler to run at specified times
  3. **Retrieval of Archived Data:** Data that has been archived can be retrieved on need basis using SQL queries or by defining customized reports.

You can develop the following archival entities and configure the retention period and purge/ archival execution:

- CASA and GL Transaction
- ATM/POS/IVR Transaction Log
- Payment (Zengin) Transactions
- Branch Transaction Logs
- Retail Teller Transaction Logs
- Interface Gateway Logs
- Generic Interface(File/Batch) Upload Logs
- Closed CASA Archive
- Matured TD Archive
- Liquidated Loans Archival (Corporate and Retail)
- Other Entities
- Interest Rates History
- Exchange Rates History
- Security Management Logs
- Audit Logs

### **27.5.1 Archival of CASA and GL Transaction History**

You can archive the accounting entries posted to the customer and general ledger accounts of CASA and GL transactions. During archive, all the transactions that satisfy the archival criteria are moved to a different data store called the archival data store from the active data store.

Following are the parameters to be used to setup the entities under CASA and GL Transactions History:

SI.No	Parameter Name	Value
1	Purging or Archival	Archival
2	Purge/Archival Mode	Bulk Purging
3	Purge/Archival Frequency	This can be setup by the bank as per their requirement (Monthly/Quarterly/Annual/Ad-hoc)
4	Main Entity to be Purged/ Archived	ACTB_HISTORY and related data stores
5	Data Store for Archived Data	Archival data store names
6	Retention Period	Proposed retention period is two years
7	Purge/Archival Execution	Preferably any time apart from the EOD time
8	Retrieval of Archived Records	SQL Queries/Customized reports can be used. Standard screen or report would not be provided for Archived records

### **Definition or Archival Criteria**

Following are the archival criteria:

- You can archive the CASA and GL transactions prior to a cut-off date. Cut-off date can be computed based on a retention period.
- The cut-off date should always be a period end date.

### **Archival Process**

You can trigger the archival process at the bank level, where the transactions are processed branch by branch.

- **Customer Accounts (CASA):** For all customer accounts, following are the archival process:
  - The balance as of the cutoff date is computed by netting all the accounting entries posted to the customer account prior to cutoff date.
  - All the entries posted to the account prior to the cutoff date is moved to the archival data store.
  - One entry with the net balance computed for the account is inserted in the accounting history data store. The value of individual fields are as follows:

Field Name	Value
Transaction date	Cut off date
Value date	Cut off date
Financial Cycle	Financial cycle of the cutoff date
Period Code	Period code of the cutoff date

Field Name	Value
Event code	PURG-A new Event code exclusively for archival and purging
Module	PG
Transaction Code	PGR
Amount_tag	PURG_NET_BAL
Exchange Rate	This would be derived again based on the netted FCY and LCY amounts

- Book dated balance data store and value dated balance data store is archived for all records for the account prior to the cut-off date.
- One row for the cut-off date is inserted for the booked dated balance and value dated balance data store.
- Customer GL breakup data store is archived for all rows prior to and including the financial cycle and period code of the cut-off date.
- Customer GL balance in GL balance data store is archived for all financial cycle and period codes prior to the financial cycle and period code of the cut-off date.
- **General Ledgers:** For all General Ledger Accounts, following are the archival process:
  - For each internal leaf GL, the balance as of cut-off date is computed by netting all the accounting entries posted to the General Ledger prior to the cut-off date.
  - All entries posted to the general ledger prior to the cut-off date is moved to the archival data store.
  - One entry with the net balance computed for general ledger is inserted in the accounting history data store. The transaction date and value date will be the cut-off date and financial cycle and period code will be that of the cut-off date.
  - All rows in GL balance table for the GL, financial cycle, period codes prior to and including the financial cycle, and period code of the cut-off date is archived.
  - Rows for the GL in booked dated balance history and value dated balance history are archived for all dates prior to the cut-off date.
  - One row each in book dated balance history and value dated balance history is inserted for the cut-off date with the net balance computed as the balance.

### **Restriction of Back Valued Transactions**

Back valued transactions including reversals are restricted for dates prior to the last archival date as follows:

- The date of archival is stamped for each branch where CASA/GL transactions are archived.
- Accounting entry posting mechanism checks the data of last archival for the branch before posting transactions with the value date of the transaction. The system does not allow the transactions, if the value date happens to be before the last archival date for the branch.

### **Retrieval of Data**

Data Retrieval for CASA and GL transactions process takes place as follows:

- **V12 Query Screens and Statements:** Only transactions that are available in active data stores are available for query from V12 query screens and statements. Archived data cannot be queried from these screens.
- **Channel Queries:** Queries from various channels like internet banking, mobile banking and so on can access only active data. Channels cannot query archived data.
- **Archived Data:** You can retrieve the data that has been archived on need basis by using SQL queries or by defining customized reports.

## 27.5.2 Archival of Closed CASA Accounts

During archival of CASA account entity, only closed CASA account master details along with its associated details are archived. Transactions posted to the CASA account are no part of the CASA account entity archival. Archival process involves moving all records for accounts satisfying archival criteria to an archive data store from the main active data store.

The archival parameters maintenance is as follows:

SI.No	Parameter Name	Value
1	Purging or Archival	Archival
2	Purge/Archival Mode	Record level Purging, the related data in all child data store shall be archived
3	Purge/Archival Frequency	This can be setup by the bank as per their requirement (Monthly/Quarterly/Annual/Ad-hoc)
4	Main Entity to be Purged/ Archived	STTM_CUST_ACCOUNT and related data stores
5	Data Store for Archived Data	Archival data store names
6	Retention Period	Two Years after the closure date
7	Purge/Archival Execution	Preferably any time apart from the EOD time
8	Retrieval of Archived Records	SQL Queries/Customized reports can be used. Standard screen or report would not be provided for Archived records

### Definition or Archival Criteria

- Only Closed CASA accounts can be archived.
- All CASA accounts closed prior to the cut-off date is archived. The cut-off date is computed based on a configurable retention period. You can configure the retention period.

### Archival Process

The following processes are followed for archiving CASA account data:

- The system picks all accounts that satisfy the archival criteria
- For each account picked up, all the data and its associated information are moved from the active data store to archival data store



### Retrieval of Data

- **V12 Query Screens and Statements:** Only data from active data stores are available from V12 Query Screens and Statements. You cannot query archived data from these screens.
- **Channel Queries:** Queries from channels like internet banking, mobile banking, and so on is restricted to active data. Archived data cannot be queried from these screens.
- **Archived Data:** Data that has been archived can be retrieved on need basis by using SQL queries or by defining customized reports. Standard query screens or reports would not be provided for archived data.

### **27.5.3 Archival of TD accounts**

You can archive the matured term deposit, structured deposit, dual currency deposit and triple currency deposit.

#### Segregation of TD transactions

TD and CASA transactions share the same data store. Thus archival of CASA transaction data store may result in archival of transactions belonging to active TD's falling in the archival period getting removed from the active data store. This will impact the TD account statements.

For segregating transactions that belong to active TDs, the following steps are performed:

- While moving the data from the daily transaction logs to the transaction history logs, a copy of the TD transactions are created in a separate data store. This would facilitate the generation of the account statements even in case of archival of the history transaction data of TD.
- The 'TD Audit Trial' screen displays the data from the new TD data store as well.

#### Archival of Matured TD Accounts

TD account data refers to information related to TD account definition and the events during the life cycle of the TD, such as deposit booking, accrual, maturity, interest liquidations and so on. Archival involves moving all matured TD account data and its associated transactional data to an archive data store from the main active data store. This archival is also applicable to Structured Deposits (SD), Dual Currency Deposit (DCD) and Triple Currency Deposit (TCD) accounts.

The archival parameters are as follows:

SI.No	Parameter Name	Value
1	Purging or Archival	Archival
2	Purge/Archival Mode	Record level Purging, the related data in all child data store shall be archived
3	Purge/Archival Frequency	This can be setup by the bank as per their requirement (Monthly/Quarterly/Annual/Ad-hoc)
4	Main Entity to be Purged/ Archived	STTM_CUST_ACCOUNT and related data stores

SI.No	Parameter Name	Value
5	Data Store for Archived Data	Archival data store names
6	Retention Period	Proposed retention period is 2 years after liquidation
7	Purge/Archival Execution	Preferably any time apart from the EOD time
8	Retrieval of Archived Records	SQL Queries/Customized reports can be used. Standard screen or report would not be provided for Archived records

### **Definition of Archival Criteria**

- Only closed TD accounts and their associated data can be archived.
- All closed TD accounts prior to a cut-off date will be archived. The cut-off date is computed based on a configurable retention period. You can configure the retention period.

### **Archival Process**

For TD accounts that satisfy the archival criteria, all the TD definition data along with the associated transactions data from the newly created TD transaction data store will be moved to their respective archival data stores.

### **Retrieval of Data**

- **V12 Query Screen:** You can fetch data from the new TD transactional data store in the 'Customer Account TD Audit Trail' screen. In this screen, you can query only active data.
- **Channels Queries:** Queries from channels like internet banking, mobile banking and so on is restricted to only active data stores.
- **Archived Data:** You can retrieve the data that has been archived on need basis by using SQL query or by defining customized reports.

## **27.5.4 Archival of Liquidated Loans**

Loans account data comprises of data relating to loan definition, schedules, interest rates, payments, and so on. Transactional Data are events that happen as part of the loan life cycle, loan booking, disbursements, interest accruals, interest liquidation, loan re-payments and so on. Archival of loan data involves moving all records satisfying the archival criteria to a set of archival data stores from active data stores. Loan transactional data is archived along with the loan account data.

The archival parameters are as follows:

SI.No	Parameter Name	Value
1	Purging or Archival	Archival
2	Purge/Archival Mode	Record level Purging, the related data in all child data store shall be archived

SI.No	Parameter Name	Value
3	Purge/Archival Frequency	This can be setup by the bank as per their requirement (Monthly/Quarterly/Annual/Ad-hoc)
4	Main Entity to be Purged/ Archived	STTM_CUST_ACCOUNT and related data stores
5	Data Store for Archived Data	Archival data store names
6	Retention Period/Liquidation days	Proposed retention period is 2 years after liquidation
7	Purge/Archival Execution	Preferably any time apart from the EOD time
8	Retrieval of Archived Records	SQL Queries/Customized reports can be used. Standard screen or report would not be provided for Archived records

### **Definition of Archival Criteria**

- Only closed loan accounts can be archived.
- All closed loan accounts prior to a cut-off date is archived. The cut-off date is computed using a configurable retention period. You can configure the retention period.

### **Archival Process**

The archival process moves all the loan definition, schedules, rate records, payment records and other loan associated data including loan transactional data to their respective archival data store, for all loan accounts that satisfies the archival criteria.

### **Retrieval of Data**

- **V12 Query Screen:** You can use the 'Events Diary' query screen for loan data to query data related to loan accounts and transactions from active data stores.
- **Channel Queries:** Channels like internet banking, mobile banking can query only active data stores for loan account and transaction information.
- **Archived Data:** You can retrieve data that has been archived on need basis by using SQL queries or by defining customized reports.

## **27.5.5 Archival of ATM/POS/IVR Transaction Logs**

ATM, POS and IVR transaction logs are purged from the online data store to a history data store on a daily basis. This activity is completed as part of the end of day (EOD) process.

The archival parameters for ATM/POS/IVR transaction logs are as follows:

SI.No	Parameter Name	Value
1	Purging or Archival	Archival
2	Purge/Archival Mode	Bulk Purging – All records satisfying the criteria would be archived

SI.No	Parameter Name	Value
3	Purge/Archival Frequency	Monthly
4	Main Entity to be Purged/ Archived	Data stores
5	Data Store for Archived Data	Archival data store names
6	Retention Period	3 Months - Records older than 3 months would be archived
7	Purge/Archival Execution	End of Day Batch
8	Retrieval of Archived Records	SQL Queries/Customized reports can be used. Standard screen or report would not be provided for Archived records

ATM/POS/IVR transactions prior to a cut-off date should be archived. The cut-off date is computed based on a retention period. You can configure retention period.

### **Archival Process**

Each ATM/POS/IVR transaction log record that satisfies its archival criteria is moved from the active data stores to their respective archival data stores.

### **Retrieval of Data**

**Archived Data:** You can retrieve the data that has been archived on need basis by using SQL queries or by defining customized reports.

## **27.5.6 Archival of Payment (Zengin) Transactions**

Purging and Archival process within FP module allows moving old data from transaction table to a corresponding set of archival tables. As a result only data that is relevant for operation of the bank is retained in the transaction tables.

Payment (Zengin) Transactions are purged from the online data store to a history data store on a periodic basis.

Archival for Payment (Zengin) transactions can be setup with the parameters as follows:

SI.No	Parameter Name	Value
1	Purging or Archival	Archival
2	Purge/Archival Mode	Bulk Purging – All records satisfying the criteria would be archived
3	Purge/Archival Frequency	This can be setup by the bank as per their requirement (Monthly /Quarterly / Annual/ Ad-hoc)
4	Main Entity to be Purged/ Archived	PMTB_CONTRACT_HISTORY and related data stores

SI.No	Parameter Name	Value
5	Data Store for Archived Data	Archival data store names
6	Retention Period	3 Months - Records older than 3 months would be archived
7	Purge/Archival Execution	Preferably any time apart from the EOD time
8	Retrieval of Archived Records	SQL Queries/Customized reports can be used. Standard screen or report would not be provided for Archived records

You can capture archival criteria for each of the Zengin Payment transaction log. The criteria for archival of each of the Zengin Payment transaction log data is cut-off date or a retention period. The cut-off date can either be provided directly or can be indirectly computed using a retention period.

### **Archival Process**

Each of Zengin's Payment transaction log data that satisfies its archival criteria based on the archival rule will be moved from the active data stores to their respective archival data stores.

### **Retrieval of Archived Data**

- **V12 Query Screens:** V12 query screens are available for branch and Retail Teller transaction logs, File/Batch Uploads using Generic Interface and Payment (Zengin) Logs. You can only query the active data stores.
- **Channel Queries:** Channels like internet banking, mobile banking, and so on. can query only Payment (Zengin) transaction logs. Channels queries are restricted to active data stores only and cannot access archived data stores.
- **Customized Reports:** Customized reports can be used for querying each of the Zengin's payment transaction logs. Customized reports can query both active and archived data stores.

## **27.5.7 Archival of Branch Transaction Logs**

You can archive Branch Transaction Logs from the online data store to a history data store based on the archival days maintained in the branch parameter data store, which is completed as part of branch end of day process. You can also use V12 archival framework to archive the branch history data into another level of archival.

The archival for Branch Transaction Logs setup parameters are as follows:

SI.No	Parameter Name	Value
1	Purging or Archival	Archival
2	Purge/Archival Mode	Bulk Purging – All records satisfying the criteria would be archived
3	Purge/Archival Frequency	Monthly
4	Main Entity to be Purged/ Archived	FBTB _OVD_HIST and related data stores

SI.No	Parameter Name	Value
5	Data Store for Archived Data	Archival data store names
6	Retention Period	3 Months - Records older than 3 months would be archived
7	Purge/Archival Execution	End of Day Batch
8	Retrieval of Archived Records	SQL Queries/Customized reports can be used. Standard screen or report would not be provided for Archived records

The cut-off date is computed based on the retention/purge days maintained. You can configure the retention period as and when required.

Branch Transaction History Logs is purged prior to a cut-off date. This purging activity is completed as a part of V12 archival process.

### **Archival Process**

Each branch transaction log data that satisfies its archival criteria is moved from the active history data stores to their respective archival data stores.

### **Retrieval of Data**

**Archived Data:** Data that has been archived can be retrieved on need basis by using SQL queries or by defining customized reports.

## **27.5.8 Archival of Retail Teller Transaction Logs**

Retail Teller Transaction Logs are purged from the online data store to a history data store on a daily basis as part of the end of day (EOD) process.

Archival for Retail Teller Transaction Logs is setup with the parameters as follows:

SI.No	Parameter Name	Value
1	Purging or Archival	Archival
2	Purge/Archival Mode	Bulk Purging – All records satisfying the criteria would be archived
3	Purge/Archival Frequency	Monthly
4	Main Entity to be Purged/ Archived	DETB_RTL_TELLER_HIST and related data stores
5	Data Store for Archived Data	Archival data store names
6	Retention Period	3 Months - Records older than 3 months would be archived
7	Purge/Archival Execution	End of Day Batch

SI.No	Parameter Name	Value
8	Retrieval of Archived Records	SQL Queries/Customized reports can be used. Standard screen or report would not be provided for Archived records

Retail Teller transaction log prior to a cut-off date can be archived. The cut-off date is computed based on a retention period. You can configure the retention period as and when required.

### **Archival Process**

Each retail teller transaction log data that satisfies its archival criteria is moved from the active data stores to their respective archival data stores.

### **Retrieval of Data**

- **V12 Query Screens:** V12 query screens are available for Branch and Retail Teller transaction logs, File/Batch Uploads using Generic Interface and Payment (Zengin) Logs. These screens can only query the active data stores.
- **Archived Data:** Data that has been archived can be retrieved on need basis by using SQL queries or by defining customized reports. Standard query screens or reports would not be provided for archived data.

## **27.5.9 Archival of Interface Gateway Logs**

Interface Gateway Logs are purged from the online data store to a history data store on a daily basis as part of the end of day (EOD) process.

Archival for Interface Gateway Logs can be setup with the parameters as below

SI.No	Parameter Name	Value
1	Purging or Archival	Archival
2	Purge/Archival Mode	Bulk Purging – All records satisfying the criteria would be archived
3	Purge/Archival Frequency	Monthly
4	Main Entity to be Purged/ Archived	GWTB_MSG_IN_HISTORY and related data stores
5	Data Store for Archived Data	Archival data store names
6	Retention Period	3 Months - Records older than 3 months would be archived
7	Purge/Archival Execution	End of Day Batch
8	Retrieval of Archived Records	SQL Queries/Customized reports can be used. Standard screen or report would not be provided for Archived records

Gateway Interface Logs prior to a cut-off date can be archived. The cut-off date is computed based on a retention period. You can configure the retention period as and when required.

### **Archival Process**

Each gateway interface log data that satisfies its archival criteria is moved from the active data stores to their respective archival data stores.

### **Retrieval of Data**

**Archived Data:** Data that has been archived can be retrieved on need basis by using SQL queries or by defining customized reports.

## **27.5.10 Archival of Generic Interface (File/Batch) Upload Logs**

Generic Interface (File/Batch) Upload Logs are purged from the online data store to a history data store on a daily basis as part of the end of day (EOD) process.

Archival of Generic Interface (File/Batch) Upload Logs can be setup with the parameters as follows:

<b>Sl.No</b>	<b>Parameter Name</b>	<b>Value</b>
1	Purging or Archival	Archival
2	Purge/Archival Mode	Bulk Purging – All records satisfying the criteria would be archived
3	Purge/Archival Frequency	Monthly
4	Main Entity to be Purged/ Archived	GITA_UPLOAD_MASTER and related data stores
5	Data Store for Archived Data	Archival data store names
6	Retention Period	3 Months - Records older than 3 months would be archived
7	Purge/Archival Execution	End of Day Batch
8	Retrieval of Archived Records	SQL Queries/Customized reports can be used. Standard screen or report would not be provided for Archived records

Generic Interface upload logs prior to a cut-off date can be archived. The cut-off date is computed based on a retention period. You can configure the retention period as and when required.

### **Archival Process**

Each Generic Interface upload data or log data that satisfies its archival criteria can be moved from the active data stores to their respective archival data stores.



### **Retrieval of Data**

- **V12 Query Screens:** V12 query screens are available for Branch and Retail Teller Transaction Logs, File/Batch Uploads using Generic Interface and Payment (Zengin) Logs. These screens can only query the active data stores.
- **Archived Data:** Data that has been archived can be retrieved on need basis by using SQL queries or by defining customized reports.

### **27.5.11 Archival of Exchange Rate History**

Purge framework can be used to archive the exchange rate history.

Following are the parameters to setup the archival of the exchange rate:

<b>SI.No</b>	<b>Parameter Name</b>	<b>Value</b>
1	Purging or Archival	Archival
2	Purge/Archival Mode	Bulk Purging
3	Purge/Archival Frequency	This can be setup by the bank as per their requirement (Monthly/Quarterly/Annual/Ad-hoc)
4	Main Entity to be Purged/ Archived	Data store names
5	Data Store for Archived Data	Archival data store names
6	Retention Period	Proposed retention period is yearly
7	Purge/Archival Execution	Preferably any time apart from the EOD time.
8	Retrieval of Archived Records	SQL Queries/Customized reports can be used. Standard screen or report would not be provided for Archived records

Exchange Rate History data prior to a cut-off date can be archived. The cut-off date would be computed based on a retention period. You can configure the retention period as and when required.

### **Archival Process**

Each history data record that satisfies its archival criteria is moved from the active data stores to their respective archival data stores.

### **Retrieval of Data**

**Archived Data:** Data that has been archived can be retrieved on need basis by using SQL queries or by defining customized reports.

### **27.5.12 Archival of Security Management Logs**

Purge framework can be used to archive the security maintenance logs.

Following are the parameters to setup the archival of the security maintenance logs:

SI.No	Parameter Name	Value
1	Purging or Archival	Archival
2	Purge/Archival Mode	Bulk Purging
3	Purge/Archival Frequency	This can be setup by the bank as per their requirement (Monthly/Quarterly/Annual/Ad-hoc)
4	Main Entity to be Purged/ Archived	Data store names
5	Data Store for Archived Data	Archival data store names
6	Retention Period	Proposed retention period is yearly
7	Purge/Archival Execution	Preferably any time apart from the EOD time
8	Retrieval of Archived Records	SQL Queries/Customized reports can be used. Standard screen or report would not be provided for Archived records

Security Management Logs prior to a cut-off date can be archived. The cut-off date is computed based on a retention period. You can configure the retention period as and when required.

### **Archival Process**

Each security log data that satisfies its archival criteria is moved from the active data stores to their respective archival data stores.

### **Retrieval of Data**

**Archived Data:** Data that has been archived can be retrieved on need basis by using SQL queries or by defining customized reports.

## **27.5.13 Archival of Audit Logs**

Purge framework can be used to archive the audit logs.

Following are the parameters to setup the archival of the audit logs:

SI.No	Parameter Name	Value
1	Purging or Archival	Archival
2	Purge/Archival Mode	Bulk Purging

SI.No	Parameter Name	Value
3	Purge/Archival Frequency	This can be setup by the bank as per their requirement (Monthly/Quarterly/Annual/Ad-hoc)
4	Main Entity to be Purged/ Archived	Data store names
5	Data Store for Archived Data	Archival data store names
6	Retention Period	Proposed retention period is monthly
7	Purge/Archival Execution	Preferably any time apart from the EOD time
8	Retrieval of Archived Records	SQL Queries/Customized reports can be used. Standard screen or report would not be provided for Archived records

Audit Logs prior to a cut-off date can be archived. The cut-off date can be computed based on a retention period. You can configure the retention period as and when required.

### **Archival Process**

Each audit log data that satisfies its archival criteria is moved from the active data stores to their respective archival data stores.

### **Retrieval of Data**

**Archived Data:** Data that has been archived can be retrieved on need basis by using SQL queries or by defining customized reports.

---

## 28. Support 24x7

### 28.1 Introduction

Oracle FLEXCUBE is available on a 24x7 basis for two broad channels Web service & Web Branch. During EOD batch process, transactions are tanked and then get processed after the batch is completed.

This document details about the 24x7 support feature in FCUBS.

#### 28.1.1 Gateway Messaging

Oracle FLEXCUBE processes the following channel transactions, 24x7:

- FLEXCUBE UBS - Gateway - Web service
  - Customer (New, Modify, Close)
  - Customer Account (New, Modify, Close)
  - Fund Transfer
  - Payment & Collections
  - Consumer Loans

All new requests for maintenance functions or online functions when the branch available status is 'No' are accepted at the Gateway messaging layer. The Gateway messaging layer does not route the transaction requests during the Date Change Window.

#### 28.1.2 Web Branch

Oracle FLEXCUBE processes the following channel transactions, 24x7:

- FLEXCUBE UBS - Retail Web Branch UI
  - Retail Teller
  - Instruments
  - Clearing
  - Utility Payments
  - Retail Loan

#### 28.1.3 Batch Processing

Every day while processing a channel transaction, system checks for the branch availability status. The system displays the Branch Available status. If the status is 'Yes', it indicates that the branch can accept transactions for the day and if the status is 'No', then it indicates that the transactions will be accepted but it will be in effect only from the next business day.

Accordingly accounting entries will be passed checking the following, for tanking branch transactions:

- The Branch Available Status
- The Branch date and host date i.e. entries will be tanked if branch date is ahead of host date

When the Branch Available status is 'NO' or if branch date is ahead of host date, then the transactions will be tanked. These transactions will be untanked by the BOD program which runs post date change i.e. POSTDTCH.

The branch available status can be changed from Yes to No in two ways.

- Auto
  - At the start of EOTI if the branch available status is not 'No'.
  - At the start of ICEOD if the branch available status is not 'No'.
  - At the start of EOFI if the branch available status is not 'No'.
  - Drop of End of Transaction Input
  - System Date Change
- Manual
  - Manual – Scheduling and Execution as EOD batch.

### **IC EOD Process**

The account resolution during IC EOD process excludes accounts that are with account creation status as Tanked.

#### **Drop - End of Transaction Input (EOTI)**

If the branch is not available during the Drop End Of Transaction Input, system automatically resets the Branch available status to 'Yes'. Also all the tanked transactions and accounting entries are released.

All transactions that are tanked would be released with tanked status as No and advices and payment messages if suppressed would be generated.

For the process that started when the branch available status was Yes, then the Status change to 'No' cannot be changed till the completion of the process. This is applicable for DE Batch upload process.

## **28.1.4 Processing Different Categories during EOD**

During EOD batch process, the categories like maintenance and financial transaction process are explained below.

### **28.1.4.1 Processing Maintenance**

The maintenance process includes:

- New Customer Creation
- Customer Amendment
- Customer Closure
- New Account Creation
- Account Amendment
- Account Closure

#### **Creating Customers**

While creating customer if the branch available status is no, then the creation date gets set to next branch working date. The customer details report requests are accepted and the processing of the same starts only during the next branch available status. The report would include the customer creation date also.

#### **Creating Customer Accounts**

The customer account creation requests are processed with the tanked status as 'Yes' if the branch is not available for transaction and these accounts are not considered for Interest & Charges calculation process

After the branch is available after the date change process, tanked status gets changed to 'No' and initiation entries of term deposit that are tanked are released with transaction date moved to next working date.

#### **Processing TD Account Creation**

The Term Deposit creation requests are processed with the tanked status as 'Yes' if the branch is not available for transaction. If the customer account is displaying as tanked, it indicates that the customer account creation request was processed when the branch available status is No or when branch date was ahead of host date.

The process when the TD account creation is received when the branch is unavailable or when branch date is ahead of host date is as follows:

- The TD account creation would be accepted with transaction status as Tanked.
- The initiation accounting entries will be posted as tanked entries.

The Term Deposit accounts that are in tanked status will not be considered for Interest & Charges calculation process.

After the branch available status is changed to 'Yes' then:

- The TD account tanked status will set to No.
- The Initiation entries of term deposit that are tanked would be released with transaction date moved to next working date.

#### **Processing TD Account Redemption**

The Term Deposit Redemption Transactions are processed partially if the branch is not available for transaction or when branch date is ahead of host date. Partial Redemption of the account is processed even after branch available status is 'No' or branch date is ahead of host date

- For TD redemption by Transfer to Savings, TD redemption by Transfer to GL, the RT Transaction done for moving the available funds will get tanked.
- For TD redemption By Bankers Cheque, the Instrument Transaction done for Issuing the BC will get tanked.

After the branch available status is changed to 'Yes' then:

- The transaction status of the TD Redemption Transaction will be changed to Active.

The tanked accounting entries if any would be un-tanked by the batch process.

#### **Processing Account Closure**

The Close out Withdrawal Transaction is not allowed if the branch is not available for transaction or when branch date is ahead of host date.

#### **28.1.4.2 Processing transactions:**

The transaction process includes:

- Payments and Collections
- Retail Loan
- Fund Transfer
- Retail Teller
- Instruments
- Standing Instructions
- Clearing

- Utility Payments

### **Processing Funds Transfer**

The fund transfer requests are processed with tanked status if the branch is not available for the transactions assuming that the FT Product cut-off time is maintained such that the cut-off time is past for the FT transaction when the Branch available status is changed to No.

The process when the FT transaction is received when the branch is unavailable is as follows:

- The FT transaction would be accepted with tanked status as Yes.
- There would be no change in the debit & credit value date derivation which currently takes in to consideration the value date spreads and cut-off time maintained in FT - Value Date Spread maintenance.
- There would be no change in the derivation of the following processing dates –
  - Messaging Date
  - Accounting Entry Date
  - Rate Date
- If the Messaging Date of the FT transaction is derived as the application date then the message generation would be suppressed and the message will be generated once the branch available status changes to 'Yes'
- Accounting entries would be posted with tanked status if the accounting date derived is as of the application date.
- Advices associated with FT transaction events if any would be suppressed and generated once the branch available status changes to 'Yes'

After the branch available status is changed to 'Yes' after the business date change then

- The tanked status of the FT transaction would be set to No
- The tanked accounting entries if any would be un-tanked by the existing batch process for releasing the accounting entries.
- Advices of the FT transaction if suppressed would be generated.
- If the payment message generation for FT transaction was suppressed, the same would be generated during the transaction release.

The following FT operation requests when the branch available status is No would be accepted and the processing would be deferred till the branch available status is yes. The requests would be tanked at the FC UBS Gateway messaging layer.

- Cancellation of FT Transaction
- Amendment of FT transaction
- Liquidate FT transaction
- Reversal of FT transaction

### **Processing Payments and Collection**

The PC requests are processed with the tanked status as 'Yes' if the branch is not available for transaction assuming that the PC Product cut-off time is maintained such that the cut-off time is past for the PC transaction when the Branch available status is changed to No.

If the PC request is received past the cut-off time maintained at the product/customer level, the activation date would be moved to next working date with the other processing dates resolved based on the activation date keeping as same. For Debit Liquidation - DRLQ event and Credit Liquidation - CRLQ event dates derived is application date, then the accounting entries are posted with tanked status.

For a book transfer, if the dispatch date derived is the application date then the offset transaction is generated and processed. The offset transaction accounting entries as part of DRLQ event and CRLQ event are posted with tanked status if the accounting entry date derived is the application date. After the branch status is available, then the tanked accounting entries if any would be un-tanked by the existing batch process for releasing the tanked accounting entries.

The following PC operation requests when the branch available status is No would be accepted and the processing would be deferred till the branch available status is yes. The requests would be tanked at the FC UBS Gateway messaging layer.

- Amendment of PC transaction
- Reject/Recall of PC Transaction
- Approval of Incoming collection
- Reversal of PC transaction
- Re-dispatch of Outgoing collection
- PC periodic instruction setup transaction

### **Processing Retail Teller Transactions**

The retail teller transactions are processed with the tanked status as 'Yes' if the branch is not available for transaction. During the RT transaction query, the transaction can be viewed as tanked, if the RT transaction is tanked and that the request was processed when the branch available status is No or when branch date was ahead of host date.

The process when the RT transaction is received when the branch is unavailable or when branch date is ahead of host date is as follows:

- The RT transaction would be accepted with transaction status as Tanked.
- The accounting entries would be posted with tanked status.
- Message and advices of an RT transaction are suppressed.

After the branch available status is changed to 'Yes' then

- The transaction status of the RT transaction will be changed to Active.
- The tanked accounting entries if any would be un-tanked by the batch process for releasing the tanked accounting entries.
- The messages and the advices associated with the RT transaction that were suppressed are also generated.
- The transaction date of the RT transaction will remain unchanged during the process of un-tanking.

### **Processing Clearing Transactions**

The clearing transactions are processed with the tanked status as 'Yes' if the branch is not available for transaction. During the clearing transaction query, the transaction can be viewed as tanked, if the CG transaction is tanked and that the request was processed when the branch available status is No or when branch date was ahead of host date.

The process when the clearing transaction is received when the branch is unavailable or when branch date is ahead of host date is as follows:

- The Clearing transaction would be accepted with transaction status as Tanked.
- The accounting entries would be posted with tanked status.

After the branch available status is changed to 'Yes' then:

- The transaction status of the Clearing transaction will be changed to Active.



- The tanked accounting entries if any would be un-tanked by the batch process for releasing the tanked accounting entries.

### **Processing Instrument Transactions**

The instrument transactions are processed with the tanked status as 'Yes' if the branch is not available for transaction. During the DD transaction query, the transaction can be viewed as tanked, if the DD transaction is tanked and that the request was processed when the branch available status is No or when branch date was ahead of host date.

The process when the instrument transaction is received when the branch is unavailable or when branch date is ahead of host date is as follows:

- The instrument transaction would be accepted with transaction status as Tanked.
- The accounting entries would be posted with tanked status.

After the branch available status is changed to 'Yes' then:

- The transaction status of the Instrument transaction will be changed to Active.
- The tanked accounting entries if any would be un-tanked by the batch process for releasing the tanked accounting entries.

### **Processing Standing Instructions**

The standing instructions are processed with the tanked status as 'Yes' if the branch is not available for transaction. During the standing instruction query, the instruction can be viewed as tanked, if it is tanked and that the request processed when the branch available status is 'No' or when branch date was ahead of host date.

When the instruction is received while the branch is unavailable, then the process is as follows:

- The instruction is accepted with transaction status as 'Tanked'.
- Accounting entries are posted with the status 'Tanked'.

Once the branch status is 'Available', then the following process is applicable:

- The transaction status of the instruction is changed to 'Un-tanked'
- A batch process releases the tanked accounting entries
- For all instructions whose booking date is the same as the Application date, the 'Date Change BOD Batch' of that date updates the status to 'Un-tanked'.
- The transaction date of the instruction remains the same after un-tanking.

### **Processing Utility Payment Transactions**

The utility payment transactions are processed with the tanked status as 'Yes' if the branch is not available for transaction. During the UP transaction Query, the transaction can be viewed as tanked, if the UP transaction is tanked and that the request was processed when the branch available status is No or when branch date was ahead of host date.

The process when the utility transaction is received when the branch is unavailable or when branch date is ahead of host date is as follows:

- The UP transaction would be accepted with transaction status as Tanked.
- The accounting entries would be posted with tanked status.

After the branch available status is changed to 'Yes' then:

- The transaction status of the UP transaction will be changed to Active.
- The tanked accounting entries if any would be un-tanked by the batch process for releasing the tanked accounting entries.

The different categories which get processed during the End of the Day batch run are explained in the table below:

<b>Maintenance/ Transactions</b>	<b>Branch Status – Not Available</b>	<b>Branch Status – Available (After date change)</b>
Customer/Account Creation	The process is tanked till the branch available status is yes.  Initiation accounting entries will be posted as tanked entries.	TD account status is changed from tanked to un-tanked.  Initiation accounting entries are un-tanked and released with transaction date moved to next working date.
TD Account Redemption	Processed partially	Transaction status is un-tanked and accounting entries if any would be un-tanked
Account Closure	Not Allowed	Processed normally
Funds Transfer	Transaction/Accounting entries would be posted with tanked status.	Transaction/Accounting entries are un-tanked and processed.
Payments and Collection	Transaction/Accounting entries would be posted with tanked status.	Transaction/Accounting entries are un-tanked and processed.
Retail Teller Transactions	Transaction/Accounting entries would be posted with tanked status.	Transaction/Accounting entries are un-tanked and processed.
Clearing Transactions	Transaction/Accounting entries would be posted with tanked status.	Transaction/Accounting entries are un-tanked and processed.
Instrument Transactions	Transaction/Accounting entries would be posted with tanked status.	Transaction/Accounting entries are un-tanked and processed.
Utility Payment Transactions	Transaction/Accounting entries would be posted with tanked status.	Transaction/Accounting entries are un-tanked and processed.

## **28.2 Supporting 24x7 Transactions**

Oracle FLEXCUBE provides round the clock support for the following banking transactions.

## 28.2.1 24x7 Transactions through Channel

Below mentioned transactions will be supported 24x7 through Channels.

<b>Sr. no</b>	<b>Transaction Name</b>	<b>Function IDs</b>
1	Misc Debit	1008
2	Misc Credit	1408
3	Funds Transfer (A2A)	1006
4	TD Account Opening	STDCUSTD
5	TD Redemption	ICDREDMN
6	Zengin Funds Transfer	NA
7	Fee Collection (as part of Zengin)	NA
8	ATM Transactions	NA
9	POS Transactions	NA
10	Account Transfer By GL	1005
11	Zengin Funds transfer limit inquiry	NA
12	HL rate cycle rate change query	CLSACCVM
13	HL smart pay query	CLSACCNT
14	JGB DCD Account Opening	STDCUSTD
15	Multimoney TD Opening	STDCUSTD
16	NK225 TD Opening	STDCUSTD
17	Otemashi Gaika TD Opening	STDCUSTD
18	Power Builder TD Opening	STDCUSTD
19	Power chance TD Opening	STDCUSTD
20	Power setup gaika TD opening (USD)	STDCUSTD
21	Power setup TD Opening	STDCUSTD
22	Power Teiki plus TD Opening	STDCUSTD
23	Power Yokin Limit query and update	STDCUSAC
24	Power TD neo Opening	STDCUSTD
25	Triple currency TD Opening	STDCUSTD
26	Zengin Transfer	NA
27	Zengin Cancellation	NA
28	Zengin free transaction query	NA

<b>Sr. no</b>	<b>Transaction Name</b>	<b>Function IDs</b>
29	Zengin query	NA
30	Zengin Payee Maintenance	NA
31	Customer Channel wise Limit Maintenance	NA

## **28.2.2 24x7 Transactions through Branch or Call Centre**

Below mentioned transactions will be supported 24x7 through branch or call centres.

<b>Sr. no</b>	<b>Transaction Name</b>	<b>Function IDs</b>
1	MISC Debit	1008
2	MISC Credit	1408
3	Fund Transfer	1006
4	Customer ATM Limit Maintenance	STDCUSAC
5	Cross Currency Rate Maintenance	CYDRATEE
6	Zengin Registration	NA
7	Customer Account Creation	STDCIF
8	Account Collateral Management	STDCUSAC
9	Limit Master Maintenance	GEDFACTL
10	Hold Funds	CADAMBLK
11	Customer Relationship	STDRETVW/ STDCUSAC
12	Customer Master Maintenance	STDCIF/ STSCIF
13	Customer Memo Maintenance	CSDINSTR
14	Standing Instruction	SIDTRONL
15	Account Schedule Generation	CLDACCVM/ CLDACCNT
16	Collateral Input	GEDCOLLT
17	Loan Account Creation	CLDACCNT
18	Loan Account Payment	CLDPYMNT
19	Deposit Detail Maintenance	STDCUSTD
20	Term Deposit Maturity Standing Instruction	STDCUSTD

<b>Sr. no</b>	<b>Transaction Name</b>	<b>Function IDs</b>
21	Collateral Pool Input	GEDMPOOL
22	Account Status audit trail inquiry	STSSTCHN/ STDSTCHN
23	Statement Enquiry	ACDABLQY
24	GL transactions/ Movements inquiry	GLDVWBAL/ ACDOPTN
25	Future dated Disbursement Inquiry	CLDMNDSB
26	Term Deposit Audit Trail Enquiry	ACDAUDTR
27	Deposit Renewal History Enquiry	STDCUSTD
28	Account Ledger Enquiry	ACDTRNQY/ ACDABLQY
29	Term deposit Interest Payout Enquiry	ACDTRNQY
30	Customer Account J-Debit Limit Maintenance	SWDCD- MNT
31	Card Request	STDCRDMS
32	AOD Lien Maintenance	LMDCUSLT
33	AOD Lien for TD Maintenance	STDCUSAC
34	Customer Company Cross Reference	NA
35	User Maintenance	SMDUSRDF, SMDU- SHOL, SMD- BANKP
36	Blocking/Unblocking Accounts Maintenance	STDBSTCH
37	FX Parameters Maintenance	CYD- CYTHR, CYDCCYPO
38	Plus Card Maintenance	STDCRDMS

Sr. no	Transaction Name	Function IDs
39	Account Master Maintenance	STD-CUSAC, STDCIF, MSDCA-CAD, ICDUDVAL, STDACCLS, ACDAS-TQY, STDACSTA, CADCH-BOO, STDTXWAV
40	Account Status Maintenance	STDSTCHN
41	AOD Customer Maintenance	STDCUSAC
42	Inquiry on Logged in Users	CLRU
43	Deposit Account Details	STD-CUSTD, ICDPRMNT, ACDABLQY, ICDREDMN, STSAMPLK
44	TD Account Ledger Inquiry	ACDTRNQY, ACDABLQY
45	Interest Payment History Inquiry	ACDAUDTR
46	Account FT Limits	STDCTLMT, ISDITLMT
47	Account Additional Data	CLDACCNT
48	TD Product Rates Maintenance	CFDFLTRI, ICDUDVAL, STDACCLS
49	TD Interest Adjustments	DEDMJONL
50	TD Audit Trail Maintenance	ACDAUDTR
51	Block/Unblock Account Status	STDSTCHN
52	Maruyu Inquiry	STDCIF, STD-CUSTD, STDRETVW

<b>Sr. no</b>	<b>Transaction Name</b>	<b>Function IDs</b>
53	TCD Account Details Inquiry	STDCUSTD
54	DCD Account Details Inquiry	STDCUSTD
55	Deposit Account Booking	STD-CUSTD, RDDSCHEQ
56	Currency Position Cover Maintenance	CYDCYTHR
57	Account activation	STDMLACT, STDMLACL
58	Furikomi	NA
59	Furikomi Predefined	NA
60	Zengin Inquiry	NA
61	Zengin Platinum Cust Inquiry	NA
62	Message Details Inquiry	STDEMDIN
63	E-Statement Registration Inquire	STDEMFLG
64	E-Statement Inquire	STDEMFLG
65	Alert Inquiry	STDEMDIN
66	Power Yokin Debit Transaction – Customer Parameters Maintenance	NA
67	Customer Email Registration	STDEMFLG
68	Customer Email ID Block	STDEMBLK
69	TD Renewal History	STDCUSTD
70	Customer Channel wise Limit Maintenance	STDCTLMT
71	Maruyu Details Maintenance	STDCIF
72	TD Currency Transfer	STDACCH, STDCIF, STDCUSTD
73	ILD Account Details Inquiry	STDCUSTD
74	Journal Operations Batch Browser	DEDBTTOT/ DEDBTHAU

---

**Note**

To have 24x7 support, Tanking Required field should be checked in the Function Description Maintenance screen (SMDFNDSC)

---

### 28.2.3 EOD handling

EOD will have below mentioned process through archival and purging routines of web branch ,Pre cut-off and cut-off:

- WBPRGEOD- Separate routine for archival and purging of web Branch transactions can be run during any time of the day. This process will archive all previous day's transaction, This is an intra day batch.
- AEDCUOFF- This is an intra day batch.

---

#### **Note**

- Opening and closing of Till and Vault will be done operationally.
  - Mark the time level to 9 for all the branches. This will enable ONLY users with time level 9 or more to log into Oracle FLEXCUBE. Call centre users should be maintained with Time Level as 9.
  - When the cut-off process is successfully completed then tanking process will start. All branch and non-branch transactions will tanked with Transaction date and Value date as next working date.
- 

Once the cut-off process is completed, Oracle FLEXCUBE will start EOD cycle.

The AEDUCOFF has to be operationally controlled to run before the start of the MarkeOTI batches.

During End of Day process the system displays the message, "EOD batch Process in progress" in the transaction screens alone.

BASIDMTR will be used to monitor the status of intraday batches.

Drop End Of Transaction input will not be allowed once the Cutoff batch and MARKEOTI batch process is run.

#### **Scheduling of Batch Operations**

During the scheduling of branch operations following configuration will be followed:

1. POSTEOD3 stage will not be configured with any Batch processing. But Head office branch alone can be configured with AEDDATCH (Date Change batch) in POSTEOD3 stage
2. All the branches including Head office branch has to feature in a single End of day group.
3. EOD process for the 24/7 functionality has to be processed with the parallel thread mode.
4. If EOC process is executed manually, then the EOC operator should ensure that the PEOD2 for all the normal branches is completed successfully before initiating the PEOD3 of Head office branch, since Date change batch is configured in PEOD3 stage of Head office branch EOC program.

Channel transactions during cutoff:

If any transaction happens through channel then the channel will send the required value dates/account opening dates through channel.

TD opening through Channel:



The channel will first send a request to find out the current host date. If the branch availability is 'N', then the API will respond with next application working date. The channel will then send the booking date for TD account opening.

CASA opening through Channel:

The channel will first send a request to find out the current host date. If the branch availability is 'N', then the API will respond with next application working date. The channel will then send the interest start date.

For host transaction, the user is expected to manually input the booking date and interest start date.

Below mentioned table summarizes the step by step execution of EOD process

Process	Description	Sub Process	Head office Process
AECUTOFF	Clearing of user/ deletion of pending trans- action	Force Log-off all the users	Y
		Delete if any pending trans- actions are there in web branch.  Note: FC Host transactions has to be operationally con- trolled	
		Check Host pending transac- tion. If Pending transaction is there then the same has to be operationally controlled either by deleting or authoriz- ing the pending transactions. Else AECUTOFF will abort with error message.	
		Branch EODM process- Change Branch Date to next date	
Mark EOTI	Mark EOTI (Running suc- cessfully across all branches.	MarKEOTI (check to be removed for pending transac- tions and users). Enable MARKEOTI from initial end of input status of 'C'	N
Post EOTI batches	Post EOTI batches		N
MarkEOF1	MarkEOF1		N
MarkEOD	MarkEOD		N
AEDDATCH	Date Change	Update all the branch availa- bility status to 'y'	Y
		Change the date across all branches	

<b>Process</b>	<b>Description</b>	<b>Sub Process</b>	<b>Head office Process</b>
Mark BOD	Mark BOD	Remove date change process from the BOD	N
Post BOD batches	Post BOD batches		N
Mark TI	Mark TI		N
WBPR-GEOD	Web Branch Archival and purging	Web Branch Archival and Purging (intra Day batch)	N

#### **28.2.4 Call Centre Handling**

Call centre will be set up as a virtual branch in FCUBS. Call centre users will log-in to a virtual branch designated for them. Call centre users can do transactions on behalf of other branch based on the branch that the customer belongs to.

---

## 29. Tanking of Maintenance Records

### 29.1 Introduction

The maintenance records that are created or modified in the system can be tanked till they get authorized, so that it is possible to undo the modifications, if needed, before the records are authorized. The maintenance log also will store the changes till they get authorized. The new or the modified records are written to the static tables only after authorization.

### 29.2 Tanking New and Modified Maintenance Records

You can enable tanking of the creation and modification of maintenance records by selecting the 'Tanking Required' option provided at the function Id level. You need to enable the 'Tanking Required' option in RAD tool as well.

You can enable 'Tanking Required' option for individual function Ids in 'Function Description Maintenance' screen. You can invoke this screen by typing 'SMDFNDSC' in the field at the top right corner of the Application tool bar and clicking on the adjoining arrow button.

Language Code	Main Menu	Sub Menu 1	Sub Menu 2	Balloon Help	Description
---------------	-----------	------------	------------	--------------	-------------

To enable tanking of maintenance records for a function Id you need to select the function Id in this screen and then select the 'Tanking Required' checkbox.

*For more details on this screen, refer Security Management System user manual.*

---

#### Note

Tanking of records has been enabled only for the following function Ids:

- STDCIF
  - STDCUSAC
-

### **29.2.1 Tanking New Records**

During the creation of a new record, if 'Tanking Required' option is enabled, the system tanks the details of the newly created record till the record gets authorized. Any query on this data retrieves this stored information.

### **29.2.2 Tanking Modified Records**

All modifications to unauthorized records get tanked and the modified data gets written to actual tables only after authorization. In this case, the record remains in 'Authorized' status in the actual table and the unauthorized modifications will be kept pending for un-tanking. The most recent modifications will be shown in both summary and detailed screens with the Authorization status as 'Unauthorized'.

### **29.2.3 Closing a Record**

You can close a record only if it is in 'Authorized' state, without any unauthorized modifications pending for un-tanking. Closure is possible only for records that are in 'Open' status. When you close a record, the system tanks this and the record gets actually closed only after the closure gets authorized.

### **29.2.4 Re-opening a Record**

You can re-open a record only if it has been closed and the closure is authorized. Re-opening of a record gets tanked till it gets authorized and the actual re-opening happens after the authorization.

### **29.2.5 Authorizing a Record**

All unauthorized modifications get displayed when you click 'Authorize' menu option. You can select a modification number and the records get authorized till that modification. These records are un-tanked and their status gets updated as 'Authorized'. You can authorize the modifications partially, if required.

### **29.2.6 Deleting a Record**

All unauthorized records will be available for deletion. You can select a modification number and system deletes all unauthorized modifications from the selected modification number. If the modifications getting deleted are made by a user other than the current user, the system displays an error message.

### **29.2.7 Viewing Summary of Records**

All summary screens display data retrieved from both the summary data source and the table that contains the unauthorized tanked records.

### **29.2.8 Modifying Tanking Preferences**

You can modify the tanking preferences specified for a function Id, if required. This modification is possible only if all records related to that function Id are in 'Authorized' status.

## 30. External Deal Maintenance

### 30.1 Introduction

You can capture the details of a deal booked in an external system using 'External Deal' maintenance screen. You can invoke this screen by typing 'STDEXLIN' in the field at the top right corner of the Application tool bar and clicking the adjoining arrow button.

The screenshot shows the 'External Deal Linkage Detail' window. The title bar includes a diamond icon and the text 'External Deal Linkage Detail'. Below the title bar is a toolbar with 'New' and 'Enter Query' buttons. The main content area contains the following fields:

- FLEXCUBE Reference \*
- Account Number
- External Deal Reference
- Deal Currency
- Deal Amount
- Exchange Rate
- Deal Booking Date
- Deal Expiry Date
- Account Currency
- Equivalent Amount
- Remarks

At the bottom of the window, there are several fields and a button:

- Maker
- Checker
- Mod No
- Date Time:
- Date Time:
- Record Status
- Authorization Status
- Exit button

You can specify the following details in this screen:

#### **FLEXCUBE Reference Number**

This reference number is automatically generated by the system.

#### **Account Number**

Select the account number associated with the external deal from the option list which displays all valid account numbers in the system.

#### **External Deal Reference Number**

Specify a unique identification number for the external deal.

#### **Deal Currency**

Specify the currency in which the external deal was carried out or select the deal currency from the option list provided.

#### **Account Currency**

The account currency gets defaulted once you select the account number.

#### **Deal Amount**

Specify the amount associated with the external deal in terms of deal currency.

#### **Equivalent Amount**

The deal amount in terms of the account currency gets displayed here.

Equivalent Amount = Deal Amount \* Exchange Rate

**Exchange Rate**

Specify the exchange rate to convert the deal currency in terms of the account currency.

**Remarks**

Specify any remarks associated with the external deal, if required.

**Deal Booking Date**

Specify the booking date of the external deal or select the deal booking date by clicking the 'Calendar' icon.

**Deal Expiry Date**

Specify the expiry date of the external deal or select the deal expiry date by clicking the 'Calendar' icon.

After specifying the above details you can save the record. An amount block equivalent to the deal amount is automatically created once these details are authorized.

---

**Note**

You can not modify a record in this screen, after it has been authorized.

---

*For more details related to amount block maintenance, refer the chapter 'Maintaining Amount Blocks' in Current and Savings Account User Manual.*

---

## 31. Annexure B - File Formats

### 31.1 Introduction

As mentioned earlier, SWIFT provides a country-wise holiday list that can be uploaded into Oracle FLEXCUE using the 'CCH' source code. This file consists of the 'HF' and 'HS' records. HF and HS are the tag identifiers through which the currency code can be obtained.

### 31.2 Upload File Formats

#### HF – Non-European countries

As mentioned before, the HF record comprises the holiday details for countries where 'EUR' is not the local currency. The currency code is obtained from the country code present in this record. The holiday record is then uploaded into the Oracle FLEXCUBE holiday upload table.

The HF record has the following format:

Position	Description	Length	Type	Mandatory	Data
1	Tag Identifier	2	VAR-CHAR2	Y	'HF'
3	Modification Flag	1	VAR-CHAR2	Y	'A' addition 'M' modification 'D' deletion 'U' unchanged
4	Country Code	2	VAR-CHAR2	Y	ISO Country Code
6	Country Name	35	VAR-CHAR2	Y	Country Name (first part)
41	Country Name	35	VAR-CHAR2	N	Country Name (second part)
76	Date	8	VAR-CHAR2	Y	Date of a Holiday
84	Holiday type	1	VAR-CHAR2	Y	Code indicating type of Holiday (see below)

85	Special holiday info.	320	VAR-CHAR2	N	Restrictions applicable if a holiday is not applicable country-wide, or is not a full day
----	-----------------------	-----	-----------	---	---

### HS – For European countries

The HS record comprises the Target holiday details for countries where 'EUR' is the local currency. The holiday record is uploaded into the Oracle FLEXCUBE holiday upload table.

The HS record has the following format:

Position	Description	Length	Type	Mandatory	Data
1	Tag Identifier	2	VARCHAR2	Y	'HS'
3	Modification Flag	1	VARCHAR2	Y	'A' addition 'M' modification 'D' deletion 'U' unchanged
4	Service Code	3	VARCHAR2	Y	Value Added Service Code
7	Date	8	VARCHAR2	Y	Date of a Holiday
15	Holiday type	1	VARCHAR2	Y	Code indicating type of holiday(see below)
16	Special holiday info	320	VARCHAR2	N	Restrictions applicable if a holiday is not applicable country-wide, or is not a full day



---

## 32. Anti-Money Laundering Reporting

### 32.1 Guarding Against Money Laundering

In Oracle FLEXCUBE you can guard against Money Laundering by using the anti-money laundering option wherein you will be required to maintain certain basic information as a safeguard against Money Laundering activities that customers may indulge in.

The information that you need to maintain includes the maintenance of:

- Product Categories
- Limit Codes
- Customer Groups

#### 32.1.1 Creating Product Categories in Oracle FLEXCUBE

You have to create product categories in Oracle FLEXCUBE, for the purpose of grouping common transactions. A product is a specific service that you offer your customers. Each transaction that you process in Oracle FLEXCUBE should be linked to a product. By maintaining amount limits at the product level, each time you link a transaction with a product the system verifies the amount limit maintained for the product. If the transaction amount exceeds the amount maintained at the product level the system intimates you with an override.

You can invoke the 'AML Product Categories Maintenance' screen by typing 'CSDAMLPC' in the field at the top right corner of the Application tool bar and clicking the adjoining arrow button.

### Product Category

You should identify each product category with an identification code by giving it a unique name.

### Description

With each product category you have to associate a brief description. This description is meant for information purposes and will not be used for any processing.

### Limit Currency

You have to identify the currency in which limits have to be tracked for transactions associated with the product category.

A list of all the currencies maintained in Oracle FLEXCUBE is available in the option list positioned next to this field. You can select the appropriate.

### Product Type

Transactions grouped under a product can either be cash based or non-cash based. Therefore, you would have created products catering to cash based and non-cash based transactions.

While creating a product category, you have to indicate whether the products grouped under the respective category cater to cash based or non-cash based transactions. You can select the appropriate option.

### **Exchange Rate Code and Rate Type**

The rate associated with this rate code will be used to derive the exchange rate when the currency of the transaction is different from the limit currency of the product category.

Similarly, you have to select the Rate Type that is to be associated with the rate code. The options available are as follows:

- Mid
- Buy
- Sell

The rate code along with the rate type will determine the exchange rate that is to be used.

### **Debit/Credit Indicator**

As part of Anti-Money Laundering you can indicate the manner in which the system should track the Debit and Credit turnover limits for any of the limit types, for the product category. The options available are:

- Both (Aggregate Together) – absolute values of debits and credits will be aggregated together
- Both (Aggregate Separately) – debits and credits will be aggregated separately
- Debits alone or Credits alone

### **Limit Code and Limit Amount**

At the product category level, you can specify the limit amount that should be associated with each limit code for a limit type.

A list of all the limit codes maintained for the specific limit type (Online, Individual, Daily turnover Batch, Daily turnover Online and Monthly turnover), in the Limit Codes Maintenance screen, will be displayed in the option list positioned next to this field. You can select the appropriate limit code and specify the limit amount that is to be linked with the code.

---

#### **Note**

For a particular product category you can choose to maintain Limit Code and Amount combinations for all of any of the five Limit types. They are:

- The Online transaction limit
- Individual limits
- Daily turnover limits
- Monthly turnover limits
- Online daily turnover limits

The transaction limits that you specify will be tracked online on a daily basis, whenever you process a transaction involving the product category. However, individual, daily and monthly turnover limits will be tracked only when the after the End of Day processes have been run successfully.

---

## **32.2 Maintaining Limit Codes**

Before you begin the maintenance of product category records, you should necessarily maintain limit codes through the Limit Code Maintenance screen. While linking a limit amount with a limit code in the product category screen, only valid limit codes that you have maintained through this screen will be made available for mapping.

You can invoke this screen by typing 'CSDAMLLM' in the field at the top right corner of the Application tool bar and clicking the adjoining arrow button.

The screenshot shows the 'Limit Codes Maintenance' application window. The window title is 'Limit Codes Maintenance'. The toolbar contains 'New' and 'Enter Query' buttons. The main area has two input fields: 'Limit Code \*' and 'Description'. To the right, the 'Limit Type' section has five radio button options: 'Online Limit' (selected), 'Online Daily Turnover', 'Daily Turnover', 'Monthly Turnover', and 'Individual Transaction'. At the bottom, the 'Fields' section lists 'Input By Date Time', 'Authorized By Date Time', and 'Modification Number'. Below these are two checkboxes: 'Authorized' and 'Open'.

### Limit Code

You can maintain limit codes for the various types of limit types like online tracking limits, individual tracking limits, daily turnover limits and monthly turnover limits.

You have to specify a unique name to identify each Limit Code that you would like to define. Subsequently, you can assign a brief description with each limit code that you define.

### Limit Type

Since you can maintain separate limit codes for each limit type, you have to associate a limit code with each limit type. The options available are:

- Online Limit – tracks the limits of all online transaction that exceed limits
- Individual Transaction – during the batch processed executed at EOD the limit maintained for this type is used to tack all individual transactions that exceed the limit
- Online Daily Turnover –all transactions processed during the day are considered for an online tracking and an online reporting is done when the specified limit exceeds
- Monthly Turnover – all transactions processed during the month that have exceeded the specified limit will be reported
- Daily Turnover – during the batch processes executed at EOD all transactions for the business day that have exceed the limit will be reported

You can select the appropriate type from the list.

## 32.3 Maintaining Anti Money Laundering Customer Groups

Since you need to define transaction online, individual, daily and monthly limits for each customer, each product category that you maintain should be linked with a customer. To facilitate this linking, you are required to maintain AML Customer Groups. You have to link one of the limit codes of the respective type attached to the product category to the customer group

You can define product categories applicable to customer groups through the 'AML Customer Group Maintenance' screen. You can invoke this screen by typing 'CSDAMLCG' in the field at the top right corner of the Application tool bar and clicking the adjoining arrow button.

Product Category *	Description	Online Limit Code	Individual Limit Code	Daily Limit Code

### Customer Group

This is the AML group to which the particular customer belongs. You can select from the available option list and identify the AML group to which the customer belongs.

---

#### Note

In the CIF maintenance screen when you capture the customer code of a customer, the same will be defaulted in the AML Customer Group field since the system recognizes each customer code as a customer group. You can either choose to categorize the customer under the same group or choose another customer group.

---

You can capture a brief description that should be associated with every AML group

### Next Review Date

While maintaining customer group and product category records you can specify the next date on which you would like to review the limits maintained for the various limit types.

### Tracking

You have to specify whether the AML tracking is required for a customer or for all customers within a group. The system performs a group level tracking if you select Customer group. Conversely if you select Customer, the AML reporting, online tracking and data collection is done only at the customer level.

---

#### Note

If you fail to indicate your preference specifically the system will perform a customer group level tracking by default

---

## Risk Profile

You can identify the risk profile of the customer group by selecting any one of the following options:

- High – indicating that the limits for the customer group need to be tracked regardless of the amount involved since the customer group is meant for high-risk customers.
- Low – indicating that the customer group is meant for low risk customers therefore amount limits need not be tracked if the amount involved falls within the limit amount.

You can select the required specification.

### 32.3.0.1 Linking Product Category with Customer Group

You have the option of selecting and linking as many limit codes as required for each limit type from the product categories maintained in the system. After you select the product category that is to be linked to the customer group, you have to identify the limit code associated with the limit type and in turn link it with the customer group.

Given below is a sample of the Customer Group maintenance record:

The Main details of the record are as follows:

<b>Customer Group</b>	<b>AMLCUS01</b>
Description	AMLCUSTOMER GROUP 1
Next Review Date	10-FEB-2003
Risk Profile	High

The Product Category linkage details are as follows:

<b>Product Category</b>	<b>Description</b>	<b>Online Limit Code</b>	<b>Individual Limit Code</b>	<b>Daily Limit Code</b>	<b>Monthly Limit Code</b>	<b>Online Daily Turnover</b>
PDT01	Product 1	LIM31	LIM01	LIM11	LIM21	LIM41
PDT02	Product 2	LIM36	LIM06	LIM16	LIM26	LIM46

---

#### Note

- Consequently, while processing transactions for all customers linked to the Customer Group AMLCUS01, the system does an online verification of transaction limits based on the amount limits maintained for the limit code LIM31 (linked to the product category PDT01) and LIM36 (linked to the product category PDT02) respectively.
  - It is mandatory for you to maintain a generic Customer Group called ALL for the customers of your bank. When product categories have not been linked to a specific customer or a customer group, the system picks up the limits maintained at the generic level for AML tracking purposes. Also, any new product category created and associated to the transaction code should be mandatorily associated with the ALL group.
-

## 32.4 Monitoring AML Accounting

For AML reporting purposes, while maintaining a transaction code you need to indicate whether AML monitoring is required for all accounting entries linked to the transaction code.

You can invoke this screen by typing 'STDTRNCD' in the field at the top right corner of the Application tool bar and clicking the adjoining arrow button.

The screen is as shown below:

The screenshot displays the 'Transaction Code Maintenance' window. It is divided into several sections:

- Transaction Details:** Includes fields for Transaction Code, Description, and Swift Code.
- Availability Information:** Features radio buttons for 'Immediate', 'On Value Date', 'After Days with New Value Date', and 'After X days', along with a 'Days' input field.
- Overdraft Tracking:** Contains a dropdown menu for 'Component type for transaction' set to 'Principal'.
- Preferences:** A list of checkboxes for various settings, including 'Cheque Mandatory', 'Interests and Charges Transaction Count', 'Interests and Charges Turnover Inclusion', 'Consider for Account Activity', 'Interest and Charges Balance Inclusion', 'Consider For Turnover Limit', 'Consider for cover sweeps', 'Available Balance Check Required', 'Interests and Charges Penalty Inclusions', 'Inter Branch in Local Currency', 'Acumen Transaction Code', 'Exempt Advance Interest', 'Escrow Processing', 'Available Balance Update Through PPC', 'Exception to Debit Override Status', and 'Exception to Credit Override Status'.
- Anti Money Laundering Monitoring:** Includes a checkbox for 'Anti Money Laundering Required', a 'Product Category' dropdown, a 'Statement Day Basis' dropdown set to 'Current Working Day', an 'Intraday Release' checkbox, and a 'Salary Credit' dropdown.
- MIS Head and External Code:** Two empty text input fields.
- Fields:** A footer section with labels for 'Maker', 'Checker', 'Date Time', 'Mod No', 'Record Status', and 'Authorization Status', along with an 'Exit' button.

If you indicate that AML tracking is required for transactions linked to the transaction code you have to identify the product category with which the transaction code is to be linked.

Consequently, the system does a check for every accounting entry passed during online processing. The system checks the transaction amount of the entry with the transaction online limit maintained for the specific customer group (of the customer to whose account the entry has been posted) and the product category (for the transaction code of the entry). If the system finds that the limit amount has been exceeded an override message informing you of the same will be displayed.

During the End of Day (EOD) processing, the system identifies all accounting entries posted during the day, which have been marked for AML monitoring, and verifies the individual amount limit for the customer group and product category combination and stores this data in the system. You will be able to view this data when you generate an AML report using Business Objects.

As part of the EOD processes the system also updates the daily turnover limits for the particular customer group and product category combination. Monthly turnovers are updated for the Customer Number, Product Category and Currency combination.



---

## 33. Developer and Developer Project Maintenance

### 33.1 Introduction

In Oracle FLEXCUBE, you can maintain details of the real-estate developer and developer projects. You can link the developers to loan accounts.

### 33.2 Maintaining Developer Details

You can maintain contact and project details of the developer in the 'Developer Maintenance' screen. You can invoke this screen by typing 'CSDDEVDT' in the field at the top right corner of the Application tool bar and clicking the adjoining arrow button.

The screenshot shows the 'Developer Maintenance' application window. The title bar reads 'Developer Maintenance'. Below the title bar is a toolbar with 'New' and 'Enter Query' buttons. The main content area is divided into two columns of input fields. The left column contains: 'Developer Code \*', 'Address', 'Zip', 'Country', and 'Country Name'. The right column contains: 'Developer Name', 'Telephone', 'Email Id', 'Fax', 'Mobile', and 'Website'. At the bottom of the window, there is a 'Project | Fields' section with labels for 'Maker', 'Checker', 'Mod No', 'Date Time:', 'Record Status', and 'Authorization Status'. An 'Exit' button is located in the bottom right corner.

Here, you can specify the following details:

#### **Developer Code**

Specify the unique code of the developer.

#### **Address**

Specify the address of the developer.

#### **Zip**

Specify the ZIP code of the developer.

#### **Country**

Specify the code of the country to which the developer belongs. The adjoining option list displays all valid country codes maintained in the system. You can choose the appropriate one.

#### **Country Name**

The system displays the corresponding country name based on the specified code of the country.

**Developer Name**

Specify the name of the developer.

**Telephone**

Specify the telephone number of the developer.

**Email ID**

Specify the Email ID of the developer.

**Fax**

Specify the fax number that should be linked with the specified developer.

**Mobile**

Specify the mobile number of the developer.

**Website**

Specify the URL of the website linked to the developer.

### 33.2.1 Viewing Project Details

You can view the details of the projects linked to the developer by clicking 'Project' button in the 'Developer Maintenance' screen.

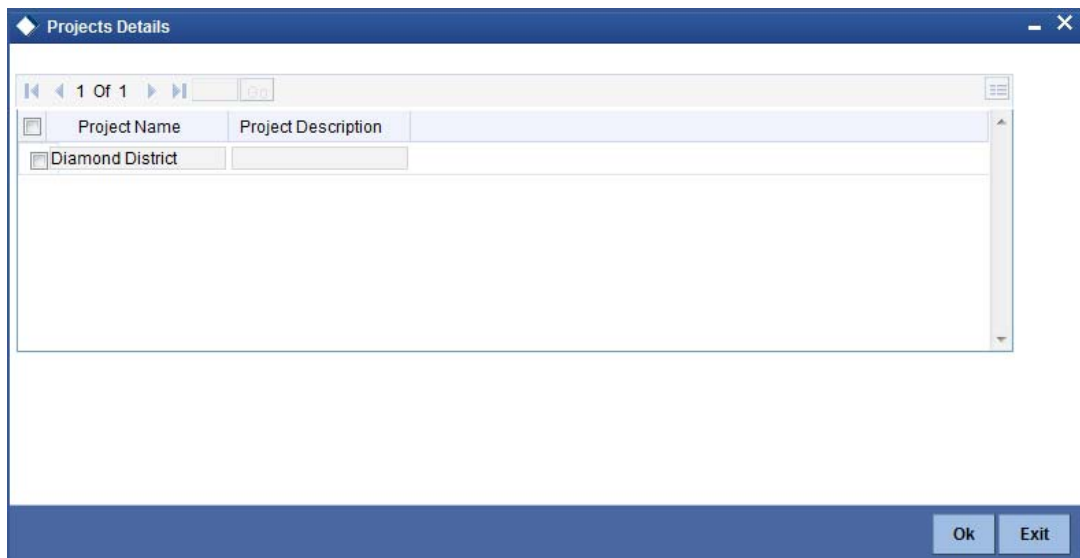

Here you can view the project names and descriptions that are linked to the specified developer.

### 33.2.2 Viewing UDF Details

You can view the UDF details by clicking 'Fields' button in the 'Developer Maintenance' screen.

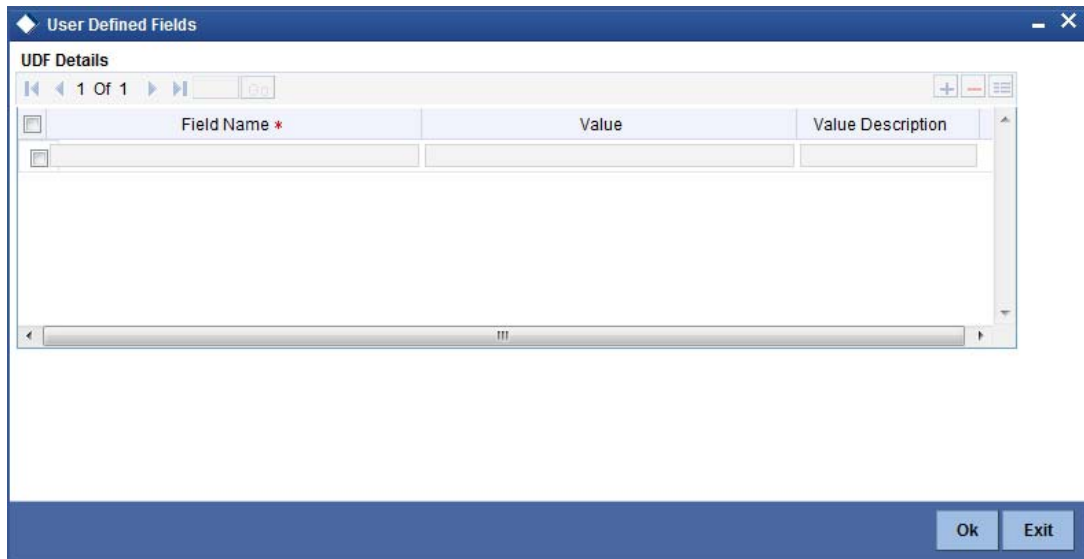

Here you can view the field names and its value.

### 33.3 Viewing Developer Maintenance Summary

You can view the summary of developer maintenance in the 'Developer Maintenance Summary' screen. You can invoke this screen by typing 'CSSDEVDT' in the field at the top right corner of the Application tool bar and clicking the adjoining arrow button.

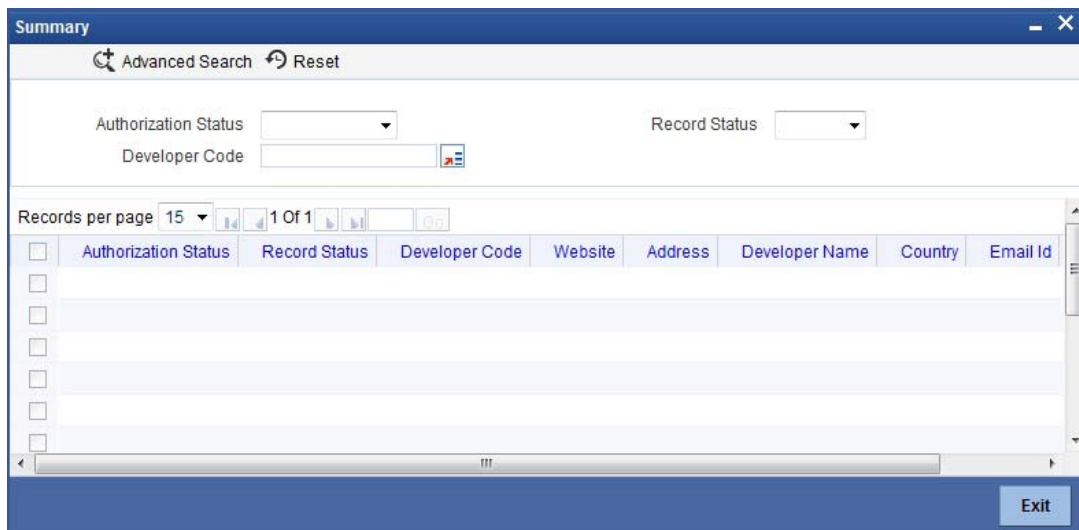

In this screen, you can query based on any combination of the following fields:

- Authorization Status
- Developer Code
- Record Status

After specifying the parameters for the query, click 'Search' button. The system displays all the records matching the parameters specified. You can view the following details:

- Authorization Status

- Record Status
- Developer Code
- Website
- Address
- Developer Name
- Country
- Email ID
- Zip

## 33.4 Maintaining Developer Project Details

You can maintain the details of real estate development projects in the 'Developer Project Maintenance' screen. You can invoke this screen by typing 'CSDDEVPR' in the field at the top right corner of the Application tool bar and clicking the adjoining arrow button.

Here you can specify the following details:

### **Project Name**

Specify the name of the project.

### **Project Description**

Specify a brief description about the project.

### **Address**

Specify the address of the project location.

### **Status**

Specify the status of the project.

### **Developer Code**

Specify the unique code of the developer. The adjoining option list displays all valid codes maintained in the system. You can choose the appropriate one.

### **Unit Details**

Specify the following details.

#### **Unit ID**

Specify the unit ID of the developer project.

#### **Unit Holder Name**

Specify the name of the unit holder of the developer project.

### **33.4.1 Viewing UDF Details**

You can view the UDF details by clicking 'Fields' button in the 'Developer Project Maintenance' screen.

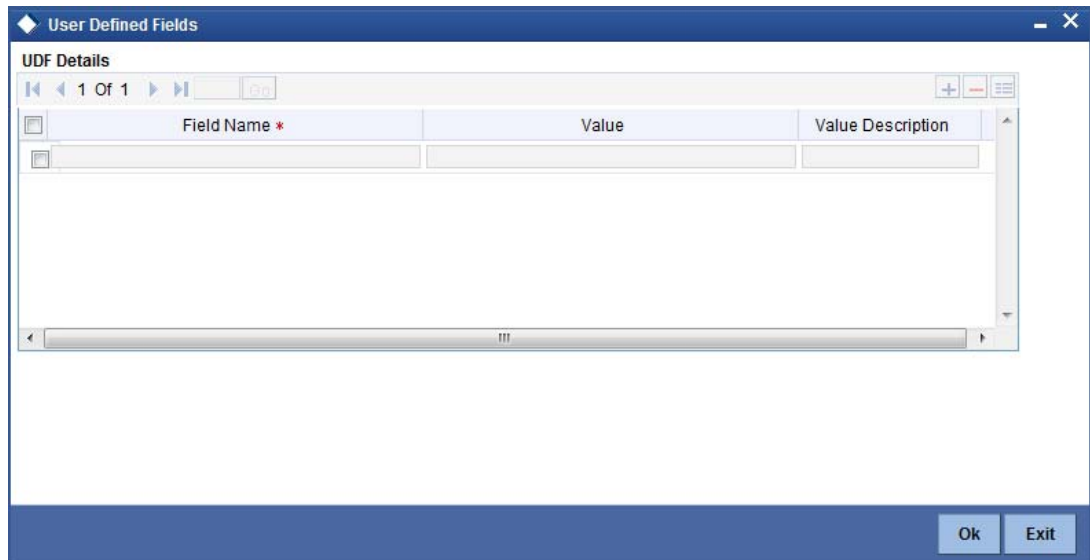

The screenshot shows a window titled "User Defined Fields" with a sub-section "UDF Details". The details are presented in a table with three columns: "Field Name \*", "Value", and "Value Description". The table is currently empty. The window includes navigation controls at the top (back, forward, search) and "Ok" and "Exit" buttons at the bottom right.

Field Name *	Value	Value Description
--------------	-------	-------------------

Here you can specify values for the UDF.

## 33.5 Viewing Developer Project Maintenance Summary

You can view the summary of developer project maintenance in the 'Developer Project Maintenance Summary' screen. You can invoke this screen by typing 'CSSDEVPR' in the field at the top right corner of the Application tool bar and clicking the adjoining arrow button.

The screenshot shows a web application window titled "Summary". At the top, there are "Advanced Search" and "Reset" buttons. Below these are four search criteria: "Authorization Status" (a dropdown menu), "Record Status" (a dropdown menu), "Developer Code" (a text input field), and "Project Name" (a text input field). Below the search criteria, there is a "Records per page" dropdown set to "15" and a "1 Of 1" indicator. A table with the following columns is displayed: "Authorization Status", "Record Status", "Developer Code", "Project Name", "Project Description", "Address", and "Status". The table is currently empty. At the bottom right of the window, there is an "Exit" button.

In this screen, you can query based on any combination of the following fields:

- Authorization Status
- Developer Code
- Record Status
- Project Name

After specifying the parameters for the query, click 'Search' button. The system displays all the records matching the parameters specified. You can view the following details:

- Authorization Status
- Record Status
- Developer Code
- Project Name
- Project Description
- Address
- Status

---

# 34. Project Financing

## 34.1 Introduction

Project financing is the financing of long-term infrastructure and industrial projects involving a number of equity investors and a group of banks.

Project financing is a credit facility sanctioned to the contractors who execute large infrastructure projects, residential complexes, commercial complexes, etc. These contractors are awarded the contracts (projects) based on a BID system. Once the project is awarded to a contractor, he approaches the bank seeking for finance.

The contractor can avail financing from the bank against PPC (Project Progress Certificate/ Project Payment Certificate) or Invoice or TD or a clean line. PPCs are one type of backing against which OD is provided. The contractor can be a single entity or a joint venture (JV). In case of a joint venture, the share of the overdraft for each contractor will depend on their share in the joint venture.

## 34.2 Processing Finance for Project

The process of project financing is as follows:

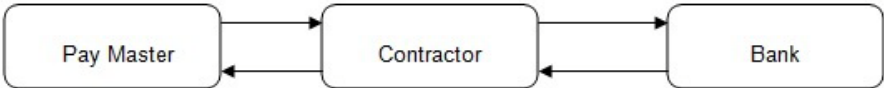

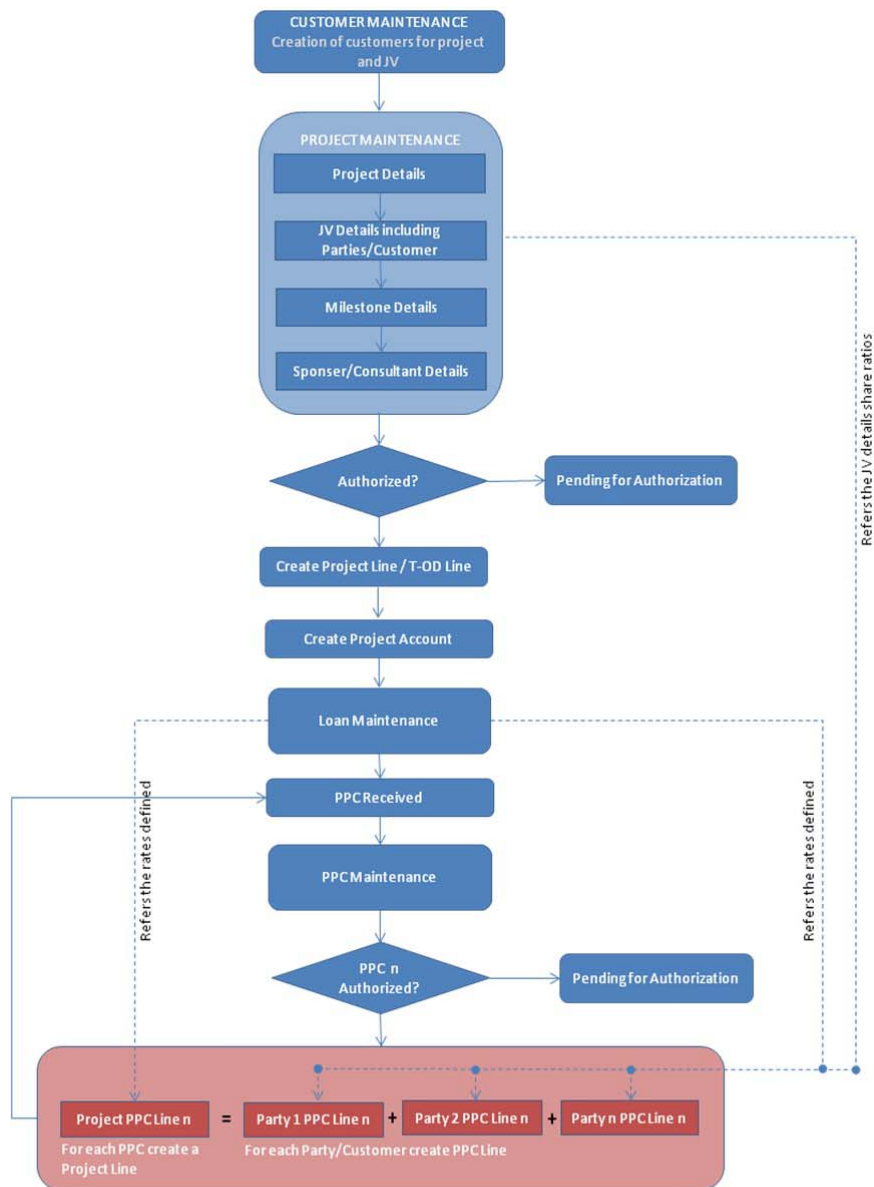

**AUTO** **MANUAL**

1. A customer or a joint venture approaches the bank for project financing
2. The bank creates the customer in the system
3. If it is a joint venture, the bank creates the joint venture customer and enters the party/customer details linked to the joint venture in the joint venture button screen.
4. The bank then creates the project account for the created customer/joint venture customer.
5. The bank captures the following details in the 'Project Maintenance' screen:
  - Project header details
  - Sponsor/Pay-master details
  - Project milestone details



- Joint Venture Parties Details (In case of Joint Venture Limit Tracking)
  - PPC Limits Details
  - Non-PPC Limits Details
6. Link the Non-PPC lines defined in project to the project account using Limits tab
  7. The customer will utilize this clean limit line until he furnishes a PPC against part or full completion of a milestone.
  8. On receiving the PPC, the bank does the following:
    - Captures the PPC details
    - If it is a joint venture then the system will default the joint venture details to this screen based on the details captured in the project maintenance venture details screen.
    - If 'Auto Line Creation for PPC' field is unchecked,
      - You should manually create the line whenever a PPC is received.
      - The line currency can be other than project currency also, but the PPC CCY should be either project currency or line currency.
      - You should manually enter the limit line details in the project maintenance screen limits tab, if the project lines are created manually and in the PPC maintenance screen Joint Venture tab if PPC lines are created manually. If joint venture party limits tracking is not required, then the system will attach one line for the project customer with 100% tracking.
      - The system will also update the project ID and the PPC ID in the 'Facility Maintenance' screen, once the linkage between a line and a PPC/ Project is established manually during PPC maintenance
    - If 'Auto Line Creation for PPC' field is checked,
      - On authorizing the PPC, the system will create the limit lines for each of the PPC for liability ID of the project customer
      - You should allocate the limit to the project line equal to the lendable value of the respective PPC
      - You should allocate the limit to an individual customer limit lines based on the share each has in the joint venture if 'JV Limit Tracking Required' is checked
    - On authorizing the PPC, the system will automatically create line commitment contracts during the EOD. The rates used in the commitment are taken from project maintenance.
    - For each PPC authorized and if 'Limits tracking through Commitment' is checked, then the system will create the following line commitment contracts:
      - Project line commitment contract, regardless of whether there is a joint venture or not
      - Customer line commitment contract for each customer only in case of joint venture
  9. The bank will view the details of a project and the status of its collaterals from a Dashboard screen
  10. You should manually mark the PPC as CLOSED, if the payment against it has been received
  11. You should manually close the project account, if the system receives the payment towards all the PPC's and all the PPC's are marked as CLOSED
  12. When multiple lines are available and system has to utilize the lines, the priority will be determined based on the lowest interest rate + spread defined in the linkages screen.
  13. Using the PPC liquidation screen, you can choose the payment of the loan or credit to the project account. This transaction will be logged under the PPC.

14. PPC liquidation will be allowed even without the 'Entry No.', say, in case the contractor did not receive money due to contractual terms elapse etc. The system will display an override message when such an input is made.
15. Partial liquidation of PPC is allowed and they will be tracked. In case 'Entry No' is provided, loan payment will be considered only to the extent of PRINCIPAL payment and other component payments will not be considered.
16. Project closure activities include:
  - Liquidating PPCs
  - Marking PPCs as closed
  - All PPCs should be liquidated before they are closed
  - Closing all lines associated with the project
  - Manually created lines can be closed using the close button in the facility screen
  - Auto created lines (created by system) will be auto closed on the event of complete repayment and complete PPC liquidation
  - Manually closing project account
  - All lines associated with the project account should be closed
  - All PPCs should be closed
  - Manually closing project
  - All lines associated with the project should be closed
  - Commitment contracts will be auto closed on commitment maturity date through CL batch (Event: CLOC). Closure of commitment contracts before closure of project will have to be operationally controlled.

### **34.3 Maintaining Project Financing Transaction**

Oracle FLEXCUBE allows you to maintain the project finance transaction in a bank with the details of the project undertaken with the contract. You can maintain these details using 'Project Detail and Maintenance' screen. To invoke this screen, type 'STDPJMNT' in the field at the top right corner of the Application tool bar and clicking the adjoining arrow button.

The screen is as shown below:

**Project Details and Maintenance**

New Enter Query

**Project Details**

Customer Number \*  
Project ID \*  
Project Name \*  
Project Account Branch \*  
Project Account \*  
Liability No \*  
Project Value \*  
Remarks

Branch Code  
Currency \*  
Number Of PPCs \*  
Default PPC Clearance Days \*  
Start Date \*  
End Date \*  
Sponsor Retention Margin (%)  
Bank Margin (%)

Ratio Change Allowed  
 JV Limit Tracking Required  
 Auto Line Creation for PPC  
 Limit Track Required through Commitment

**Main** Milestones Venture Details PPC Limits Non PPC Limits

**Sponsor**

1 Of 1

Sponsor ID	Sponsor Name *	Sponsor.
------------	----------------	----------

**Consultant**

1 Of 1

Consultant ID	Consultant Name *	Consulta
---------------	-------------------	----------

**UDF**

Maker Date Time:  
Checker Date Time:  
Mod No Record Status  
Authorization Status

Exit

### 34.3.1 Specifying the Project Details

#### **Customer Number**

Specify the customer number.

#### **Project ID**

Specify the project identification number.

#### **Project Name**

Specify the name of the project.

#### **Project Account Branch**

Specify the project account branch details.

#### **Project Account**

Specify the project account details.

#### **Liability ID**

Specify the liability ID.

#### **Project Value**

Specify the value of the project.

**Remarks**

Specify remarks, if any.

**Ratio Change Allowed**

Check this box if the joint venture ratio change is allowed during the course of the project.

This field is enabled only for new loans under the project financing.

**JV Limit Tracking Required**

Check this box if joint venture limit tracking is required.

**Branch Code**

The system displays the branch code.

**Currency**

Specify the currency details.

**Number of PPCs**

Specify the number of PPCs in the project.

**Default PPC Clearance Days**

Specify the default PPC duration for the payment.

**Start Date**

Specify the start date of the project.

**End Date**

Specify the end date of the project.

**Sponsor Retention Margin (%)**

Specify the retention margin for the sponsor while paying the PPC.

**Bank Margin (%)**

Specify the margin retained by the bank for the PPC..

**Auto Line Creation for PPC**

If you check this box, then the system will automatically create the credit lines while authorizing the PPC. Else, you need to manually create the line and link them in the PPC screen.

By default, this field will be checked.

**Limit Track Required through Commitment**

If you check this box, then the system will create the commitment contracts for every automatic line creation.

## 34.3.2 Specifying the Main Details

You can specify the main details of the project such as sponsor details and consultant details to validate the PPC and to recommend the sponsor for the payment.

The screenshot displays the 'Project Details and Maintenance' application window. The window title is 'Project Details and Maintenance'. It features a menu bar with 'New' and 'Enter Query'. The main area is divided into 'Project Details' and 'Sponsor/Consultant' sections. The 'Project Details' section contains various input fields: Customer Number \*, Project ID \*, Project Name \*, Project Account Branch \*, Project Account \*, Liability No \*, Project Value \*, Remarks, Branch Code, Currency \*, Number Of PPCs \*, Default PPC Clearance Days \*, Start Date \*, End Date \*, Sponsor Retention Margin (%), and Bank Margin (%). There are also checkboxes for 'Ratio Change Allowed', 'JV Limit Tracking Required', 'Auto Line Creation for PPC', and 'Limit Track Required through Commitment'. Below this is a tabbed interface with 'Main', 'Milestones', 'Venture Details', 'PPC Limits', and 'Non PPC Limits'. The 'Sponsor' and 'Consultant' tabs are active, each showing a table with columns for ID, Name, and other details. At the bottom, there is a 'UDF' section with fields for 'Maker', 'Checker', 'Mod No', 'Date Time', 'Record Status', and 'Authorization Status', along with an 'Exit' button.

### 34.3.2.1 Maintaining Sponsor Details

#### Sponsor ID

Specify the sponsor identification details of the project. If the sponsor is the customer of the bank, then you can specify the CIF identification details.

#### Sponsor Name

Specify the name of the sponsor.

The system will display the sponsor name, if you had specified the CIF ID in the 'Sponsor ID' field.

#### Sponsor Address

Specify the address of the sponsor.

The system will display the sponsor address, if you had specified the CIF ID in the 'Sponsor ID' field.

### 34.3.2.2 Maintaining Consultant Details

#### Consultant ID

Specify the consultant identification details of the project. If the sponsor is the customer of the bank, then you can specify the CIF identification details.

#### Consultant Name

Specify the name of the consultant.

The system will display the consultant name, if you had specified the CIF ID in the 'Consultant ID' field.

#### Consultant Address

Specify the address of the consultant.

The system will display the consultant address, if you had specified the CIF ID in the 'Consultant ID' field.

If the sponsor or consultant is not a customer of the bank, then the system will display only the name and address of the sponsor or the consultant.

### 34.3.3 Specifying Milestones Details

You can specify the records of the various milestones in the project and percentage of completion with respect to the project.

The screenshot shows the Oracle Project Details and Maintenance application window. The window title is "Project Details and Maintenance". It contains a "Project Details" section with various input fields and checkboxes. Below this is a "Milestones" section with a table and a "UDF" section at the bottom.

**Project Details**

Customer Number *	Branch Code
Project ID *	Currency *
Project Name *	Number Of PPCs *
Project Account Branch *	Default PPC Clearance Days *
Project Account *	Start Date *
Liability No *	End Date *
Project Value *	Sponsor Retention Margin (%)
Remarks	Bank Margin (%)

Ratio Change Allowed  
 JV Limit Tracking Required  
 Auto Line Creation for PPC  
 Limit Track Required through Commitment

**Milestones**

Milestone No *	Description *	Percentage Completion *	Start Date *	End Date *

**UDF**

Maker	Date Time:
Checker	Date Time:
Mod No	Record Status
	Authorization Status

Exit

**Milestone No**

Specify the milestone number.

**Description**

Specify the description of the milestone.

**Percentage Completion**

Specify the percentage of completion with respect to the milestone.

**Start Date**

Specify the start date of the milestone.

**End Date**

Specify the end date of the milestone.

**34.3.4 Specifying the Venture Details**

You can maintain the details of the joint venture. You can also change the joint venture ratios during the course of the project, but these ratios are effective only for future loans. Each loan created for the project can store the ratios at the loan level which is defaulted based on the application ratio at the time of loan creation. All limits tracking for joint venture parties will be based on this ratio.

The system will create the limit lines for each of the project venture parties when joint venture limit tracking is required at the project level. The line ID maintained at the limits is used to create the limits automatically. Each time the PPC is created, the system will create a new limit line using the same line for each of the liability of each joint venture. Different joint venture parties will have the same commitment product which can have different interest rate.

The screen is as shown below:

**Project Details and Maintenance**

New Enter Query

**Project Details**

Customer Number \*  Branch Code   
 Project ID \*  Currency \*   
 Project Name \*  Number Of PPCs \*   
 Project Account Branch \*  Default PPC Clearance Days \*   
 Project Account \*  Start Date \*   
 Liability No \*  End Date \*   
 Project Value \*  Sponsor Retention Margin (%)   
 Remarks  Bank Margin (%)

Ratio Change Allowed  Auto Line Creation for PPC  
 JV Limit Tracking Required  Limit Track Required through Commitment

Main Milestones **Venture Details** PPC Limits Non PPC Limits

Default

1 Of 1

Effective Date \*

Party Id *	Party Name	Liability No *	Ratio *	Rate *	Margir
<input type="text"/>	<input type="text"/>	<input type="text"/>	<input type="text"/>	<input type="text"/>	<input type="text"/>

UDF

Maker Date Time:  
 Checker Date Time:  
 Mod No Record Status  
 Authorization Status

Exit

### Effective Date

Specify the effective date of the joint venture. For each effective date, the system maintains the ratio among the joint venture partners. The sum of ratios for each effective date must be equal to 100.

### Party ID

The system displays the joint venture details of the project.

### Party Name

The system will display the party name.

### Liability ID

Specify the liability ID.



### Ratio

Specify the percentage share of the joint venture party. The sum of all the ratios must be equal to 100.

### Default Interest Rate

Specify the default interest rate that is used for the external component in the commitment product. The system will default this value to PPC.

### Margin

Specify the margin applicable on the interest rate.

## 34.3.5 Specifying PPC Limits Details

You can create the clean limit (ToD) manually using the line ID for the amount. You should then link this limit to the project account. The system creates the joint venture lines on authorization of the PPC maintenance with joint venture tracking required.

In case of manual line creation, the system will create the lines in project currency. Whenever there is a cross currency, the system will use a standard mid rate to convert from limit currency to project currency to track utilization. The LCY difference that may arise due to exchange rate differences will be handled by the ELCM CCY revaluation EOD batch.

You can view the limits detail such as line ID to create the project limits. There are two types, namely, PPC Limits and Non PPC Limits.

The screenshot for PPC Limits is as follows:

The screenshot displays the 'Project Details and Maintenance' window. The 'Project Details' section includes fields for Customer Number, Project ID, Project Name, Project Account Branch, Project Account, Liability No, Project Value, and Remarks. It also includes Branch Code, Currency, Number Of PPCs, Default PPC Clearance Days, Start Date, End Date, Sponsor Retention Margin (%), and Bank Margin (%). There are three checked checkboxes: 'Ratio Change Allowed', 'JV Limit Tracking Required', and 'Auto Line Creation for PPC'. The 'Limit Track Required through Commitment' checkbox is unchecked. Below the form is a tabbed interface with 'PPC Limits' selected. A table below the tabs shows one limit entry with a serial number of 1. The bottom of the window contains a UDF section with fields for Maker, Checker, Mod No, Date Time, Record Status, and Authorization Status, along with an 'Exit' button.

Limit Type *	Limit Description	Credit Line *	Serial No *	Commitment Product
			1	

**Limit Type**

Specify the type of limit.

**Limit Description**

The system displays the limit description.

**Credit Line**

Specify the credit line.

**Serial No**

The system displays the serial number for the limit created.

**Commitment Product**

Specify the commitment product details used when the respective limit line is created.

**Rate**

Specify the rate.

**Margin**

Specify the margin.

### 34.3.6 Specifying Non PPC Limits Details

The screenshot for Non PPC Limits is as follows:

**Project Details and Maintenance**

New Enter Query

**Project Details**

Customer Number \*  Branch Code   
Project ID \*  Currency \*   
Project Name \*  Number Of PPCs \*   
Project Account Branch \*  Default PPC Clearance Days \*   
Project Account \*  Start Date \*   
Liability No \*  End Date \*   
Project Value \*  Sponsor Retention Margin (%)   
Remarks  Bank Margin (%)   
 Ratio Change Allowed  Auto Line Creation for PPC  
 JV Limit Tracking Required  Limit Track Required through Commitment

Main Milestones Venture Details PPC Limits **Non PPC Limits**

**Joint Venture Line Details**

1 Of 1

Limit Type *	Limit Description	Customer No *	Liability No *	Line Code *

**Party Line Details**

1 Of 1

Customer No *	Liability No *	Line Code *	Line Serial *	Currency

UDF

Maker Date Time:  
Checker Date Time:  
Mod No Record Status Authorization Status

Exit

#### 34.3.6.1 Maintaining Joint Venture Line Details

##### Limit Type

Specify the type of limit.

##### Limit Description

The system displays the limit description.

##### Customer No

Specify the customer number.

##### Liability No

Specify the liability number.

**Line Code**

Specify the line code.

**Line Serial**

The system displays the serial number for the limit created.

**Currency**

The system displays the line currency details.

**Rate**

Specify the rate.

**Margin**

Specify the margin.

**JV Line**

This box will be checked by default.

**34.3.6.2 Maintaining Party Line Details****Customer No**

Specify the customer number.

**Liability No**

Specify the liability number.

**Line Code**

Specify the line code.

**Line Serial**

The system displays the serial number for the limit created.

**Currency**

The system displays the line currency details.

**34.4 Maintaining PPC**

Oracle FLEXCUBE allows the executor to maintain the PPC during the course of the project, i.e. during the course of the project, once the executor completes the milestone should inform the sponsor. The sponsor in turn, will inspect and confirms the completion of the milestone. The executor is then allowed to raise the PPC with start date and the expiry date. The system calculates the expiry date based on the default PPC clearance days. However, the sponsor can change the expiry date. The system will accept the PPC in any currency. If there is a cross currency, then the system uses a standard mid rate for converting from limit currency to project currency.

You can maintain the PPC using 'PPC Maintenance' screen. To invoke this screen, type 'STDPPCMN' in the field at the top right corner of the Application tool bar and clicking the adjoining arrow button.

### 34.4.1 Specifying PPC Maintenance Details

#### **Project ID**

Specify the project ID.

#### **PPC ID**

The system displays the PPC ID.

#### **PPC Description**

Specify the description of the PPC.

#### **Start Date**

Specify the PPC start date.

#### **End Date**

Specify the PPC end date.

#### **Milestone No**

Specify the milestone sequence number.

#### **Currency**

Specify the currency of the PPC.

#### **PPC Amount**

Specify the amount of the PPC. If the sum of the PPC amounts for all the PPCs presented for the specific milestone is greater than the milestone percentage calculated amount an error message is displayed.

The system will create the automatic limit lines for the lendable amount arrived at after applying the sponsor retention margin and the bank margin.

#### **Sponsor Retention Margin**

The system displays the margin retained by the sponsor for this PPC. However, you can amend this field while creating the PPC.

#### **Sponsor Amount**

The system displays the sponsor amount after applying the sponsor retention margin.

#### **Bank Margin**

The system displays the margin retained by the bank for this PPC. However, you can amend this field while creating the PPC.

#### **Lendable amount**

The system displays the lendable amount after applying the bank margin.

#### **Amount Paid**

The system displays the amount that has been paid against this PPC.

#### **Remarks**

Specify remarks, if any.

### **34.4.2 Specifying Joint Venture Details**

In case of manual line linkage, you need to operationally ensure the following points:

- Synchronization of Line End date and PPC end date
- Limit lines should have amounts equivalent to that of PPC lendable amount. In case line currency is different from PPC currency, lines should be created for the equivalent of PPC lendable amount by applying the rate conversion. If there is any mismatch in the amounts, while linking the manual lines, the system will display an override message

#### **Party ID**

The system defaults the party ID from the project maintenance.

#### **Ratio**

The system defaults the joint venture share ratio from the project maintenance.

#### **Credit Line**

The system defaults the line ID. The system uses this limit line for tracking the exposure of specific joint venture party.

If joint venture limit tracking is not required at project level, the system will not create the lines. In case auto creation of lines is not chosen, then you need to manually create limit lines and link them in this screen.

#### **Serial Number**

Specify the line serial of the credit line.

#### **Currency**

The system displays the line currency.

After specifying the PPC amount, click on 'CALC' button. The will calculate the sponsor margin and the bank margin and arrive at the sponsor amount and the lendable amount respectively.

### 34.4.3 Maintaining PPC Liquidation

You can maintain the liquidation details in the PPC screen, where in you can choose the payment of the loan or credit to the project account. This transaction is logged in the PPC. To invoke the PPC Liquidation screen, type 'STDPPCLQ' in the field at the top right corner of the Application tool bar and clicking the adjoining arrow button.

The screenshot shows the 'PPC Liquidation' window with the following fields:

- Project ID \*
- Project Name
- PPC Id \*
- PPC Description
- Serial No
- Branch Code \*
- Loan/Account Number \*
- Entry Number
- Currency
- Amount

The UDF (User Defined Fields) section contains:

- Maker
- Checker
- Mod No
- Date Time:
- Date Time:
- Record Status
- Authorization Status

An 'Exit' button is located in the bottom right corner.

#### Project ID

Specify the project ID.

#### Project Name

The system displays the name of the project ID selected.

#### PPC ID

Specify the PPC ID.

#### PPC Description

The system displays the description for the PPC ID selected.

#### Loan/Account Number

Specify the loan or the account number.

#### Entry Number

Specify the entry number. If you have not specified the entry number, then the system will display an override message.

#### Amount

The system displays the amount for liquidation. However, you can amend this field.

#### Branch Code

Specify the branch code.

#### Currency

The system displays the currency details.

## 34.5 Viewing Dashboard Details

Oracle FLEXCUBE allows you to view the details of the PPC available in the project such as joint venture ratios, balance in the project account, the project lines and their limits for each project line, etc. You can view these details using 'Dashboard Details' screen. To invoke this screen, type 'STDPJDSH' in the field at the top right corner of the Application tool bar and clicking the adjoining arrow button.

The screen is as shown below:

Collateral Type	Sequence	Collateral Description	Amount	Currency	Out Standing	Status
						Open

Party ID	% Share	Currency	Limit	Available

You can view the following details:

- Project ID
- Project Name
- Customer ID
- Customer Name
- Available Balance
- Account Number
- Account Currency
- Project Limit
- Project Utilization
- Current Balance

### 34.5.1 Viewing PPC Details

You can view the PPC details by clicking on the 'PPC Details' tab in the 'Dashboard Details' screen.



The screen is as shown below:

Dashboard Detail

New Enter Query

Project ID  Customer ID  Account No   
Project Name  Customer Name  Account CCY   
Project Amount  Available Balance  Current Balance   
Project Utilization  Currency

PPC Details | **Limit Details** | Commitment Details | Loan Details

Collateral Type	Sequence	Collateral Description	Amount	Currency	Out Standing	Status
<input type="text"/>	<input type="text"/>	<input type="text"/>	<input type="text"/>	<input type="text"/>	<input type="text"/>	Open

Party ID	% Share	Currency	Limit	Available
<input type="text"/>	<input type="text"/>	<input type="text"/>	<input type="text"/>	<input type="text"/>

Exit

You can view the following details:

- Collateral Details
  - Collateral Type
  - Sequence
  - Collateral Description
  - Amount
  - Outstanding
  - Status
- Venture Details
  - Party ID
  - % Share
  - Limit CCY
  - Limit
  - Available

### 34.5.2 Viewing Limit Details

You can view the limit details by clicking on the 'Limit Details' tab in the 'Dashboard Details' screen.

The screen is as shown below:

Dashboard Detail

New Enter Query

Project ID  Customer ID  Account No   
Project Name  Customer Name  Account CCY   
Project Amount  Available Balance  Current Balance   
Project Utilization  Currency

PPC Details **Limit Details** Commitment Details Loan Details

Credit Line	Line Serial	Currency	Limit	Utilized	Paid
-------------	-------------	----------	-------	----------	------

Party ID	% Share	Credit Line	Line Serial	Currency	Limit	Utilized
----------	---------	-------------	-------------	----------	-------	----------

Exit

You can view the following details:

- Project Line Details
  - Line ID
  - Line Serial
  - Limit
  - Utilized
  - Paid
- Customer Line Details
  - Party ID
  - % Share
  - Line ID
  - Line Serial
  - Limit
  - Utilized
  - Paid

### 34.5.3 Viewing Commitment Details

You can view the commitment details by clicking on the 'Commitment Details' tab in the 'Dashboard Details' screen.

The screen is as shown below:

The screenshot shows the 'Dashboard Detail' application window. At the top, there are fields for Project ID, Project Name, Project Amount, Project Utilization, Customer ID, Customer Name, Available Balance, and Currency. To the right, there are fields for Account No, Account CCY, and Current Balance. Below these fields is a tabbed interface with four tabs: 'PPC Details', 'Limit Details', 'Commitment Details', and 'Loan Details'. The 'Commitment Details' tab is currently selected. Below the tabs is a table with the following columns: 'Contract Reference', 'Currency', 'Amount', 'Outstanding Amount', and 'Maturity Date'. The table is currently empty. At the bottom right of the window is an 'Exit' button.

You can view the following details:

- Contract Reference
- Currency
- Amount
- Outstanding Amount
- Maturity Date

### 34.5.4 Viewing Loan Details

You can view the loan details by clicking on the 'Loan Details' tab in the 'Dashboard Details' screen.

The screen is as shown below:

This screenshot is identical to the one above, showing the 'Dashboard Detail' application window. The only difference is that the 'Loan Details' tab is now selected in the tabbed interface, while the table below it remains empty.

You can view the following details:

- Contract Reference
- Currency
- Amount
- Outstanding Amount
- Maturity Date

## 34.6 Querying Dashboard Details

Oracle FLEXCUBE allows you to query the dashboard details based on the Project ID, Project Name, Customer ID, Customer Name, Account Number. You can view these details using 'Dashboard Summary' screen. To invoke this screen, type 'STSPJDSH' in the field at the top right corner of the Application tool bar and clicking the adjoining arrow button.

The screen is as shown below:

The screenshot shows the 'Dashboard Summary' application window. At the top, there are 'Advanced Search' and 'Reset' buttons. Below these are seven search criteria: Project ID, Project Name, Customer ID, Customer Name, Account No, Account CCY, and Project Amount, each with a corresponding input field and a search icon. Below the search fields, there is a table with the following columns: Project ID, Project Name, Customer ID, Customer Name, Account No, Account CCY, and Project Amount. The table currently displays one record. At the bottom right of the window, there is an 'Exit' button.

You can query the record based on the following details:

- Project ID
- Customer ID
- Account Number
- Project Limit
- Project Name
- Customer Name
- Account Currency

You can double-click on a specific record to view the detailed screen.

## 34.7 Querying Accounting Entries

Oracle FLEXCUBE allows you to view the accounting entry serial number which can be used in PPC liquidation screen for marking a specific credit entry for query. You can view these details using 'Customer Account Transaction Query' screen. To invoke this screen type 'ACDTRNQY' in the field at the top right corner of the Application tool bar and click on the adjoining arrow button.

The screen is as shown below:

**Customer Account Transaction Query**

Execute Query

**Query Criteria**

Contract Reference

Account Number

Transaction Code

Event Code

Value Date

Related Reference Number

From Date

Last N number of transactions

Debit/Credit

Transaction Currency

Module

Transaction Date

Related Account

To Date

**Account Details**

Branch

Currency

Starting Balance

Debit Credit Balance

Account Number

**Transaction Details**

1 Of 1

Contract Reference	Entry Serial Number	Module Code	Transaction Code	Event Code	Transaction Date	Value
--------------------	---------------------	-------------	------------------	------------	------------------	-------

Cancel

You can query the record based on the following details:

- Contract Reference
- Account Number
- Debit/Credit
- Transaction Code
- Currency
- Event Code
- Module Code
- Value Date
- Transaction Date
- Related Reference
- Related Account
- From Date
- Last N Number of Transactions
- To Date

Clicking on the 'Query' button, the system displays the transaction details. You can double-click on a specific record to view the detailed screen.

---

**Note**

- You can query for a specific number of previous records by entering the value in 'Last N Number of Transactions'. By default, it is set as 100.
  - When you click 'Query' button, the system validates whether Last N.number of transactions is greater than the menu level MAX\_RES\_ROWS of the function ID 'ACDTRNQY'. If it is found greater than that, then the system displays a configurable message 'Last N number of transactions is greater than the allowed maximum transactions to be retrieved'.
  - If you do not enter the last N number of transaction and click the 'Query' button, and the number of transactions to be retrieved is greater than the menu level MAX\_RES\_ROWS for the function ID 'ACDTRNQY', then the system will retrieve only the first MAX\_RES\_ROWS number of transaction and display an information message 'Displaying only first[MAX\_RES\_ROWS] transactions'.
  - The starting balance and running balance fields of the Customer Account Transaction Query (ACDTRNQY) are not be applicable if you try to retrieve the Last N transaction.
-

## 35. Error and Error Codes for Project Financing

### 35.1 Error and Error Codes

Validation	Error Code	Description
System should not allow entering PPCs if the total # of PPC's already entered exceeds the # allowed	ST-PPC-001	Max limit for number of PPCs exhausted.
Whenever there is a change in the # of PPC's, the system should validate whether the change is an increase or decrease. It should only allow an increase in the # of PPC's	ST-CON003	Decreasing number of PPCs not allowed
At the project maintenance, whenever there is a change in the project amount, the system should validate and only allow an increase in the project amount and not allow a decrease	ST-CON005	Decrease of project amount not allowed
In case of a JV, the total of the % share of individual customers should be 100%	ST-PROJ-009	Total share should be 100%
In case of a JV, each customer should have a separate Liability ID it is operational control.  At the project maintenance, each project should have unique Line ID for PPC lines.	ST-PROJ-028	Liability ID already in use
The milestone start date and end date should be validated against that of the project	ST-PROJ-004	The milestone start date/ end date should be equal to or within the range of project start and end date
The project status when changed to CLOSED should be allowed only when all PPC's associated with the respective project are in CLOSED status	ST-PROJ-024	OPEN PPC's exist. Project status cannot be closed
In case of auto created lines, system should not allow amendment on these lines	ST-CON012	Amendment of auto-created lines not allowed
The number of milestones cannot exceed the number of PPCs	ST-PROJ-027	Number of milestones cannot be greater than the number of PPCs

The sum of the milestone percentage completion should be 100	ST-PROJ-010	The sum of milestone completion should be 100
PPC end date is different from PPC start date + PPC clearance days. Configurable override	ST-PROJ-031	PPC End Date is different from Project Start Date + PPC Clearance days.



### 36.1 Introduction

You can generate the following reports:

- List of deleted transactions
- Accounting journal
- Cash flow report
- Balances of future dated transactions
- Current Rates Report
- Account Opening Confirmation
- Activity Journal Report
- Core Exception Report

### 36.2 List of Deleted Transactions

This report lists out the deleted transaction details pertaining to each product under each module pertaining to every user. You can invoke this screen by typing 'ACRDLTXN' in the field at the top right corner of the Application tool bar and clicking the adjoining arrow button.

The screenshot shows the 'Deleted Transactions Listing' application window. It features several sections for filtering the report:

- Module:** Radio buttons for 'Single' and 'All', and a text input field with a search icon.
- Products:** Radio buttons for 'Single' and 'All', and a text input field with a search icon.
- User:** Radio buttons for 'Single' and 'All', and a text input field with a search icon.
- Batch:** 'From' and 'To' text input fields with search icons.
- Report Options:** 'Report Format' (PDF) and 'Report Output' (Print) dropdown menus.
- Printer:** 'Printer At' (Client) and 'Printer' text input fields with search icons.
- Print Options:** A 'Print Copies' checkbox.
- Buttons:** 'Ok' and 'Exit' buttons at the bottom right.

Specify the following details.

#### Module

Indicate whether the reports should be generated for a single module or for all modules.

If you choose 'Single', you need to specify the module for which the report needs to be generated. The option list provided displays all valid module codes maintained in the system. You can select the appropriate one.

#### Transactions

Indicate the type of transactions that should be covered in the report. The following options are available:

- All
- This branch
- Posted to Other Branch

- This branch acted as bridge

### **Products**

Indicate whether the reports should be generated for a single product or for all products.

If you choose 'Single', you need to specify the product code for which the report needs to be generated. The option list provided displays all valid product codes maintained in the system. You can select the appropriate one.

### **User**

Indicate whether the reports should be generated for a transactions entered by all users or a single user.

If you choose 'Single', you need to specify the user ID based on which the report needs to be generated. The option list provided displays all valid user IDs maintained in the system. You can select the appropriate one.

### **From**

Specify the batch from which the transactions need to be considered for report generation.

### **To**

Specify the batch until which transactions need to be considered for report generation.

### **Print Copies**

Check this box to indicate that the report needs to be printed.

Click 'OK' to generate the report.

## **36.2.1 Contents of Report**

The contents of this report are discussed under the following heads:

### **Header**

The Header carries the title of the report, information on the branch code, branch date, the ID of the user who generated the report, the date and time at which it was generated, the modules covered in the report, the product codes covered in the report, batch information, transactions covered in the report and printing preference.

### **Body of the Report**

This report is sorted module-wise. For every module the following details are displayed.

- Module
- Product
- User ID

The following transaction details are displayed.

<b>Field Name</b>	<b>Field Description</b>
Reference Number	This is the reference number of the deleted transaction
Account Branch	This is the branch where the account resides.
Account Number	This is the account number.

Currency	This is the currency of the transaction.
Debit/Credit	This indicates the nature of the transaction – debit or credit.
Transaction Code	This is the transaction code.
Status	This is the status of the transaction
Value Date	Indicates the value date of the transaction
Account description	This is the account description.
Fcy Amount	This is the transaction amount in foreign currency.
Transaction Description	This is the description of the transaction code
Exchange Rate	This is the exchange rate
LCY Amount	This is the Amount in Local currency
Narrative	This is the narrative text associated with the transaction.
Instrument Number	This is the instrument number linked to the transaction.
Auth ID	This is the authorization ID
Total Debits	Total amount debited under the respective user, product and module
Total Credits	Total amount credited under the respective user, product and module
User ID	This is the user ID of the user who entered the transaction.
Grand Total Debits	This is the grand total amount of all the debit transaction grouped by transaction code and user.
Grand Total Credits	This is the grand total amount of all the credit transaction grouped by transaction code and user.

## 36.3 Accounting Journal

This report gives details of every journal entry transaction. You can invoke this screen by typing 'ACRJRNAL' in the field at the top right corner of the Application tool bar and clicking the adjoining arrow button.

The screenshot shows the 'Accounting Journal' configuration window. It features several sections for filtering data: 'Module', 'Products', 'User', and 'Batch'. Each section has radio buttons for 'Single' and 'All', with a corresponding text input field and a search icon. The 'Transactions' section on the right has radio buttons for 'All', 'This Branch', 'Posted to Other Branch', and 'This Branch acted as Bridge', along with checkboxes for 'Print Copies' and 'Position Entries', and a 'Report Date' field with a search icon. At the bottom, there are dropdown menus for 'Report Format' (set to PDF) and 'Report Output' (set to Print), and fields for 'Printer At' (set to Client) and 'Printer'. 'Ok' and 'Exit' buttons are located at the bottom right.

Specify the following details:

### **Module**

Indicate whether the reports should be generated for a single module or for all modules.

If you choose 'Single', you need to specify the module for which the report needs to be generated. The option list provided displays all valid module codes maintained in the system. You can select the appropriate one.

### **Transactions**

Indicate the type of transactions that should be covered in the report. The following options are available:

- All
- This branch
- Posted to Other Branch
- This branch acted as bridge

### **Products**

Indicate whether the reports should be generated for a single product or for all products.

If you choose 'Single', you need to specify the product code for which the report needs to be generated. The option list provided displays all valid product codes maintained in the system. You can select the appropriate one.

### **User**

Indicate whether the reports should be generated for a transactions entered by all users or a single user.

If you choose 'Single', you need to specify the user ID based on which the report needs to be generated. The option list provided displays all valid user IDs maintained in the system. You can select the appropriate one.

**From**

Specify the batch from which the transactions need to be considered for report generation.

**To**

Specify the batch until which transactions need to be considered for report generation.

**Print Copies**

Check this box to indicate that the report needs to be printed.

**Position Entries**

Check this box to indicate that the report needs to cover position accounting entries.

**Report Date**

Specify the date as on which the report needs to be generated.

Click 'OK' to generate the report.

**36.3.1 Contents of Report**

The contents of this report are discussed under the following heads:

**Header**

The Header carries the title of the report, information on the branch code, branch date, the ID of the user who generated the report, the date and time at which it was generated, the modules covered in the report, the product codes covered in the report, batch information, transactions covered in the report and printing preference.

**Body of the report**

The report is sorted by modules. Under every module, it lists out product-wise transaction details.

The following transaction details are displayed.

<b>Field Name</b>	<b>Field Description</b>
Product	This is the product code of the transaction.
User Id	This is the user ID of the user who entered the transaction.
Reference No	This is the transaction reference number.
Account Branch	This is the account branch.
Account Number	This is the account number.
Currency	This is the currency of the transaction.
Dr/Cr	This is the nature of the transaction – either debit or credit.
Transaction Code	This is the transaction code while posting the journal entry.
Module	This is the module code of the report
Description	This is the description of the transaction code.
Status	Status of the transaction.

Value Date	This is the value date of the transaction.
Account Description	This is the description of the account.
Event	This is the event triggered on the transaction.
Fcy Amount	This is the transaction amount in a foreign currency
Exchange Rate	This is the exchange rate used if the transaction is in any other currency.
Lcy Amount	This is the transaction amount in local currency.
Auth ID	This is the user ID of the user who authorized the transaction.
Total Debits	Total amount debited under the respective user, product and module
Total Credits	Total amount credited under the respective user, product and module
Grand Total Debits	This is the grand total amount of all the debit transaction grouped by transaction code and user.
Grand Total Credits	This is the grand total amount of all the credit transaction grouped by transaction code and user.

## 36.4 Cash Flow Report

The 'Cash flow report' gives details of the cash flow by accounts or by account class. The report contains details of the Account Number or Account Class, and the list of Accounts or Account Classes. You can invoke this screen by typing 'ACRPCASH' in the field at the top right corner of the Application tool bar and clicking the adjoining arrow button.

The screen is as shown below:

Specify the following details.

**Report Name**

Specify the name of the report. The option list provided displays all valid reports maintained in the system. You can select the appropriate one.

**Report Type**

Indicate whether the report should be a detailed report or a summary report.

**Notice Contracts**

Check this box to indicate that notice contracts should be covered in the report.

**Call Contracts**

Check this box to indicate that call contracts should be covered in the report.

**Select Account Class/Account**

Indicate whether the reports should be generated based on account class or account.

**All/Specific Records**

Indicate whether the reports should be generated for all records in an account class/account or for specific records.

**Account Class**

If you have indicated 'Account Class' as the basis for report generation, specify the account classes that should be considered. Click add icon to add rows. You can select a valid account class from the adjoining option list.

**Account**

If you have indicated 'Account' as the basis for report generation, specify the accounts that should be considered. Click add icon to add rows. You can select a valid account from the adjoining option list.

Click 'OK' to generate the report.

**36.4.1 Contents of Report**

The contents of the cash flow report are discussed under the following heads:

**Header**

The Header carries the title of the report, information on the branch code, the ID of the user who generated the report, the module, page number and the date and time at which it was generated.

**Body of the Report**

The report is sorted on the currency of the cash flow.

<b>Field Name</b>	<b>Field Description</b>
Interval	Indicates the interval of cash flow
Amount In	This is the amount debited into the particular account for the particular period.

Account	This is the account number
Account Class	This indicates the account class
Amount Out	This is the amount credited from the account during the specified period.
Net Flow	Indicates the net flow
Currency	Indicates the currency of the transaction

### 36.4.2 **Cash Flow (Summary) Report**

The Cash Flow summary report summarizes the details of cash flow for particular Accounts or Account Classes.

#### **Header**

The Header carries the title of the report, information on the branch code, the ID of the user who generated the report and the date and time at which it was generated.

#### **Body of the Report**

The report is sorted on the currency of the cash flow for different account classes and their accounts. The following details are displayed.

<b>Field Name</b>	<b>Field Description</b>
Amount In	This is the amount debited into the particular account for the specific period
Amount Out	This is the amount credited from the account during the specified period
Net Flow	This is the net amount available in the account for the specified period



## 36.5 Future Dated Account Balance Report

This report gives balances of future dated transactions. You can invoke the screen by typing 'ACRPFVBL' in the field at the top right corner of the Application tool bar and clicking the adjoining arrow button.

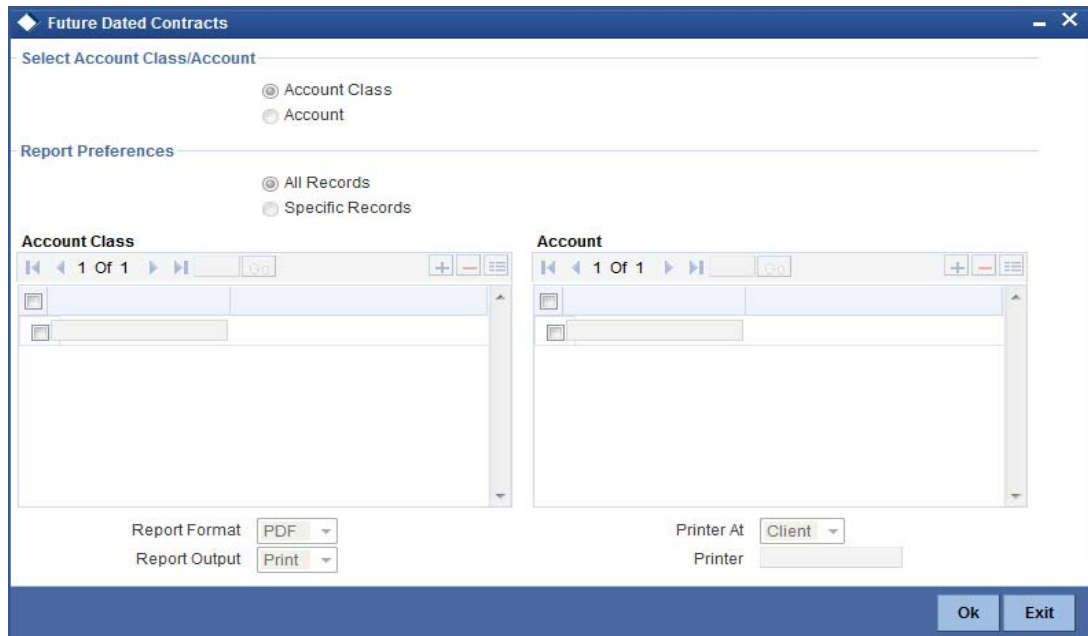

You can specify the following parameters:

### **Select Account Class/Account**

Select account criteria for generating the report from the following options:

- Account Class
- Account

### **Report Preferences**

Select report preference criteria for generating the report from the following options:

- All Records
- Specific Records

### **Account Class**

Specify valid account classes for which you need to generate the report from the adjoining option list, if you have selected 'Account Class'.

### **Account**

Specify valid account classes for which you need to generate the report from the adjoining option list, if you have selected 'Account'.

### 36.5.1 Contents of the Report

#### Header

The Header carries the title of the report, information on the branch code, branch date, the ID of the user who generated the report, the date and time at which it was generated and the modules covered in the report.

## **Body of the Report**

The following details are displayed.

<b>Field Name</b>	<b>Field Description</b>
Date	This gives the date for which a future dated transaction is booked for the account.
Reference Number	This is the reference number of the future dated transaction
Inflow	This is the inflow amount.
Outflow	This is the outflow amount.
Balance	This is the available balance.
Currency	This is the currency of the account
Customer	This is the name of the customer.
Account	This is the account number of the customer.
Account Class	This is the account class.
Opening	This is the opening balance of the account.

## **36.6 Current Rates Report**

This report gives details on rates for currency pairs. You can invoke the screen by typing 'CYRTCURR' in the field at the top right corner of the Application tool bar and clicking the adjoining arrow button.

The screenshot shows the 'Currency Rates' application window. The title bar reads 'Currency Rates'. The main area is divided into two sections: 'Selection' and 'Currency Choice'. Under 'Selection', there are two radio buttons: 'All Currency Pairs' (which is selected) and 'Selected Currency Pair'. The 'Currency Choice' section contains several controls: 'Currency1' and 'Currency2' are text input fields; 'Report Format' is a dropdown menu currently showing 'PDF'; 'Report Output' is a dropdown menu currently showing 'Print'; 'Printer At' is a dropdown menu currently showing 'Client'; and 'Printer' is a text input field. At the bottom right of the window, there are two buttons: 'Ok' and 'Exit'.

Specify the following details.

**Selection**

Indicate whether the report should be generated for all currency pairs or for a given currency pair.

**Currency 1**

If you have chosen, 'Selected Currency Pair', then specify the first currency that forms a pair. The adjoining option list displays all valid currency codes maintained in the system. You can select the appropriate one.

**Currency 2**

If you have chosen, 'Selected Currency Pair', then specify the second currency that forms the pair. The adjoining option list displays all valid currency codes maintained in the system. You can select the appropriate one.

Click 'OK' to generate the report.

**36.6.1 Contents of Report****Header**

The Header carries the title of the report, information on the branch code, the ID of the user who generated the report, the date and time at which it was generated, the module covered in the report and reporting options.

**Body of the report**

The report is sorted by currency pairs. The following details are displayed.

<b>Field Name</b>	<b>Field Description</b>
Currency Pair	This gives the currency pairs for which rate report has been generated.
Quotation	This indicates the quotation type – either direct or indirect.
No. of Units	This indicates the number of units of one currency being quoted against the other.
Rate Type	This is the rate type.
Mid Rate	This is the mid rate used for conversion.
Buy Rate	This is the buy rate used for conversion.
Sale Rate	This is the sell rate used for conversion.

## 36.7 Rate History Report

This report gives details on history of rates for currency pairs. You can invoke the screen by typing 'CYRTHIST' in the field at the top right corner of the Application tool bar and clicking the adjoining arrow button.

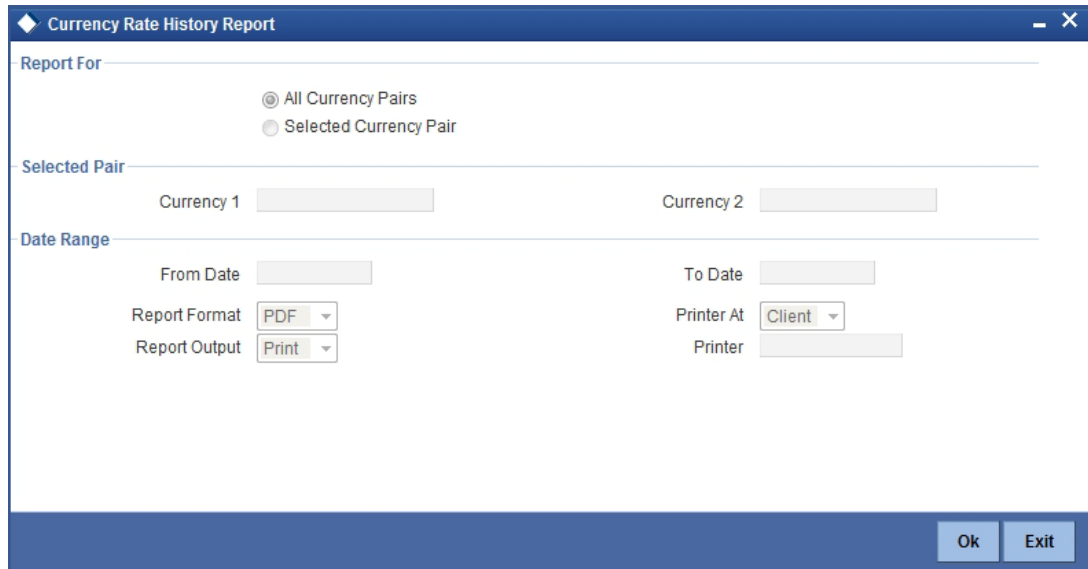

The screenshot shows a dialog box titled "Currency Rate History Report" with a blue header and a white body. The dialog is divided into several sections:

- Report For:** Contains two radio buttons: "All Currency Pairs" (selected) and "Selected Currency Pair".
- Selected Pair:** Contains two text input fields labeled "Currency 1" and "Currency 2".
- Date Range:** Contains two text input fields labeled "From Date" and "To Date".
- Report Format:** A dropdown menu currently set to "PDF".
- Report Output:** A dropdown menu currently set to "Print".
- Printer At:** A dropdown menu currently set to "Client".
- Printer:** A text input field.

At the bottom right of the dialog, there are two buttons: "Ok" and "Exit".

Specify the following details.

### Report For

#### **All Currency Pairs**

Select if you need all currency pairs.

#### **Selected Currency Pair**

Select if you need selected currency pair.

### Selected Pair

#### **Currency 1**

If you have chosen, 'Selected Currency Pair', then specify the first currency that forms a pair. The adjoining option list displays all valid currency codes maintained in the system. You can select the appropriate one.

#### **Currency 2**

If you have chosen, 'Selected Currency Pair', then specify the second currency that forms the pair. The adjoining option list displays all valid currency codes maintained in the system. You can select the appropriate one.

### Date Range

#### **From Date**

Specify the from date.

#### **To Date**

Specify the to date.

Click 'OK' to generate the report.

### Header

The Header carries the title of the report, information on the branch code, branch date, the ID of the user who generated the report, the date and time at which it was generated, the module covered in the report, reporting options, currency pair, from date and to date .

### Body of the report

The report is sorted by currency pairs. The following details are displayed.

Field Name	Field Description
Currency Pair	This gives the currency pairs for which rate report has been generated.
Quotation	This indicates the quotation type – either direct or indirect.
No of Units	This indicates the number of units of one currency being quoted against the other.
Rate Type	This is the rate type.
Date	The effective date of the rates applied.
Mid Rate	This is the mid rate used for conversion.
Buy Rate	This is the buy rate used for conversion.
Sale Rate	This is the sell rate used for conversion.

## **36.8 Customer Account Opening Confirmation Report**

You can generate a report for the customer, confirming that his / her account with the bank has been successfully opened. This report contains the following details:

- Customer Type
- Customer Number
- Date

You can generate the Customer Account Opening Confirmation report for one customer or all the customers at once, as of a specific date. To generate the report, invoke 'Customer Account Opening Confirmation' screen.

You can invoke this screen by typing the code 'CSRACCO' in the field at the top right corner of the Application tool bar and click on the adjoining arrow button.

The screen is as shown below:

The screenshot shows a window titled "Customer Account Opening Confirmation". It features the following controls:

- Customer Type:** Two radio buttons, "All Customers" (selected) and "Single".
- Customer Number:** A text input field.
- Date:** A date selection field.
- Report Format:** A dropdown menu currently showing "PDF".
- Report Output:** A dropdown menu currently showing "Print".
- Printer At:** A dropdown menu currently showing "Client".
- Printer:** A text input field.
- Buttons:** "Ok" and "Exit" buttons at the bottom right.

### **Customer Type**

You can generate customer account opening confirmation report for one or all the customers. Indicate your choice here. If you select 'Single Customer', you have to specify the customer number in the space provided.

### **Customer Number**

If you wish to generate a report specific to one customer, specify the customer number. The option list displays all valid customer numbers maintained in the system. Select the appropriate one.

### **Date**

Specify the date as of which you want to generate the report.

Once you have set the preferences, click 'OK' button. The system displays the print option screen, where you can set your preferences as to viewing and printing the report.

## **36.8.1 Contents of the Report**

The contents of the report are discussed under the following heads:

### **Header**

The Header carries the title of the report, information on the branch code, the run date and time, the branch date, the user id, the module name and the page number of the report.

## **Body of the Report**

<b>Field Name</b>	<b>Field Description</b>
Customer Name	Indicates the name of the customer
Customer Number	Indicates the customer number
First Nominee	Indicates the name of the first nominee
Second Nominee	Indicates the name of the second nominee
Address	Indicates the contact address for the customer whose cheque has been rejected.
Client Account Number	Indicates the Account Number of the client
Subject	Indicates the subject
Account Details	
First Account Holder Details	
Name	Indicates the name
Address	Indicates the address
Street	Indicates the street
Place	Indicates the place
Date of Birth	Indicates the date of birth
Telephone	Indicates the telephone
Fax	Indicates the fax
Email	Indicates the email
Unique Number	Indicates the unique number
Account Opening Date	Indicates the account opening date
Alternate Account Number	Indicates the alternate account number

## **36.9 Activity Journal Report**

This report gives details about activity journal in 'Core Activity Journal' screen. To invoke this screen, type 'CSRPACTJ' in the field at the top right corner of the Application tool bar and

clicking the adjoining arrow button.

**From Date**

Specify the start date of the report date range. The system will include the details of the record from this date.

**To Date**

Specify the end date of the report date range. The system will include the details of the record until this date.

**Report For**

Specify whether you want to generate the report for all the modules or selected modules alone. If you select 'Selected Modules', you need to specify the modules below.

**Module**

If you need to generate the report for selected modules, you need to indicate the modules here. Use the add button to add more modules.

**36.9.1 Contents of Report**

The parameters specified while generating the report are printed at the beginning of the report. Other content displayed in the report is as follows:

**Header**

The Header carries the title of the report, information on the branch code, the ID of the user who generated the report, the date and time at which it was generated and the modules covered in the report.

**Body**

You can find the following details in the body of the report:

Field Name	Field Description
Module	The module for which the report is being generated
Product Type	The type of product for which the report is being generated



Contract Ref No	The reference number of the contract being reported
Counter Party No	The CIF ID of the customer involved
Counter Party Name	This is the name of the customer involved
User Def. Status	The status if the user defined elements
Event Date	The date on which the event took place
Seq. No	The sequence number of the event
Event Description	The description of the event
Contract Status	The status of the contract i.e., active, closed etc.
Maker ID	The identification number of the maker
Checker ID	the identification number of the checker
Reversed Seq. No.	The reversed sequence number

## 36.10 Core Exception Report

This report gives details about core exception in 'Core Exception' screen. To invoke this screen, type 'CSRPEXCP' in the field at the top right corner of the Application tool bar and clicking the adjoining arrow button.

The screen is as shown below:

### From Date

Specify the start date of the report date range. The system will include the details of the record from this date.

### To Date

Specify the end date of the report date range. The system will include the details of the record until this date.

### **Report For**

Specify whether you want to generate the report for all the modules or selected modules alone. If you select 'Selected Modules', you need to specify the modules below.

### **Selected List**

If you need to generate the report for selected modules, you need to indicate the modules here. Use the add button to add more modules.

## **36.10.1 Contents of Report**

The parameters specified while generating the report are printed at the beginning of the report. Other content displayed in the report is as follows:

### **Header**

The Header carries the title of the report, information on the branch code, the branch date, the ID of the user who generated the report, the date and time at which it was generated and the modules covered in the report.

### **Body**

You can find the following details in the body of the report:

<b>Field Name</b>	<b>Field Description</b>
Module	The module for which the report is being generated
Contract Ref No	The reference number of the contract being reported
Counter Party	The name of the counter party
Counter Party Name	The name of the counter party involved
Event Description	The description of the event
Exception	The description about the exception

## 36.11 Uncollected Funds Report

This report provides details of uncollected funds based on release date of the fund. You can invoke this screen by typing 'ACRUNCOL' in the field at the top right corner of the application tool bar and clicking the adjoining arrow button.

The screenshot shows a dialog box titled "Uncollected Funds Print". It has a blue header bar with the title and window control icons. The main area is white and contains the following elements:

- Accounts:** Two radio buttons, "All" (selected) and "One". Below them is a text input field.
- Date:** Two radio buttons, "Present Date" (selected) and "Between Dates".
- From Date:** A text input field.
- To Date:** A text input field.
- Report Format:** A dropdown menu with "PDF" selected.
- Report Output:** A dropdown menu with "Print" selected.
- Printer At:** A dropdown menu with "Client" selected.
- Printer:** A text input field.
- Buttons:** "Ok" and "Exit" buttons at the bottom right.

Specify the following details.

### **Accounts**

Select the account for which the report is to be generated. The options are:

- All - System fetches all the accounts which has uncollected funds.
- One - If this option is selected, system fetches the report for a particular account, which is selected in the option list.

### **Date option**

Select the date for which report has to be generated:

- Present Date: System fetches the uncollected fund which are available in the current date
- Between dates: If between dates is selected then From date and to date is mandatory. System fetches the Uncollected fund details which are available in between dates.

### **From Date**

Specify the From date.

### **To Date**

Specify the To date.

### 36.11.1 Contents of Report

#### Header

The Header carries the title of the Report, information on the branch code, the branch date, the user ID, the module name, the date and time at which the report was generated and the page number of the report.

## **Body of the report**

The details of the uncollected funds that would be displayed in the report are as follows:

<b>Field Name</b>	<b>Field Description</b>
Account	This is the account for which transaction details is being reported
Available Date	This indicates the available date
Transaction Reference	This is the reference number of the transaction for which account has uncollected balance
Amount	This is the uncollected amount in the account
Total Amount	This is the total uncollected amount in the account

## **36.12 Account Revaluation Report**

This report gives details of the memo revaluation funds. You can invoke this screen by typing 'ACRREVAL' in the field at the top right corner of the Application tool bar and clicking the adjoining arrow button.

The screenshot shows a software window titled "Account Revaluation Report". Inside the window, there are several controls: a radio button group with "Memo" selected and "Normal" unselected; two dropdown menus labeled "Report Format" (set to "PDF") and "Report Output" (set to "Print"); a "Printer At" dropdown menu set to "Client"; and a "Printer" text field with a printer icon button. At the bottom right of the window, there are "Ok" and "Exit" buttons.

### **Memo or Normal**

Specify the type of account revaluation report.

### **36.12.1 Contents of Report**

#### **Header**

The Header carries the title of the Report, information on the branch code, the branch date, the user ID, the module name, the date and time at which the report was generated and the page number of the report.

## **Body of the report**

The details of the uncollected funds that would be displayed in the report are as follows:

<b>Field Name</b>	<b>Field Description</b>
Currency	This is the currency for which transaction details is being reported
Revaluation Rate	This is the revaluation rate
Account	This is the account for which transaction details is being reported
Description	This is the description provided
Account Revalued	This is the revalued account
Account Balance	This indicated the account balance
LCY Equivalent (before revaluation)	This indicates the amount equivalent to local currency before revaluation
LCY Equivalent (after revaluation)	This indicates the amount equivalent to local currency after revaluation
Profit/ Loss	This is the profit or loss incurred
Profit/ Loss Amount	This is the profit or loss amount
P&L Account	This is the profit or loss account
Currency	This is the currency for which transaction details is being reported
Rate	This is the revaluation rate
Category	This is the GL category

## 36.13 Accounts Movement Report

This report gives details of the movement of the accounts for that particular day. You can invoke this screen by typing 'ACRPMOVE' in the field at the top right corner of the Application tool bar and clicking the adjoining arrow button.

The screenshot shows a dialog box titled "Accounts Movement Report". It has a blue header bar with a diamond icon on the left and standard window controls (minimize, maximize, close) on the right. The main area is white and contains several groups of controls. On the left side, there are two date pickers labeled "From Date" and "To Date", each with a calendar icon. Below these are two text boxes for "Account No" and "Currency Code", each with a small dropdown arrow icon. Further down are two dropdown menus: "Report Format" (currently set to "PDF") and "Report Output" (currently set to "Print"). On the right side, there are two radio button groups. The first group has "Value Dated" (unselected) and "Booking Dated" (selected). The second group has "Single Account" (unselected) and "All Accounts" (selected). Below these are two more controls: "Printer At" (a dropdown menu set to "Client") and "Printer" (a text box with a dropdown arrow icon). At the bottom right of the dialog, there are two buttons: "Ok" and "Cancel".

### **From Date**

Specify the From Date from the option list.

### **To Date**

Specify the To Date from the option list.

### **Account Number**

Specify the account number from the option list.

### **Value Dated**

Select if the report is value dated.

### **Booking Dated**

Select if the report is booking dated.

### **Currency**

Specify the currency from the option list.

### **Account Selection**

Specify the type of account selection.

### 36.13.1 Contents of Report

#### **Header**

The Header carries the title of the Report, information on the branch code, the branch date, the user ID, the module name, the date and time at which the report was generated and the page number of the report.

## **Body of the report**

The details of the uncollected funds that would be displayed in the report are as follows:

<b>Field Name</b>	<b>Field Description</b>
Account Number	This is the account number
Account Description	This is the brief description for the account
Account Currency	This is the currency of the account
Opening Balance	This is the opening balance of the account
FCY Amount	This is the opening balance of account in FCY
LCY Amount	This is the opening balance of account in LCY
Transaction Date	This is the transaction date
Transaction Description	This is a brief description of the transaction
Transaction Reference Number	This is the reference number of the transaction posted to account
Value Date	This is the value date of transaction
FCY Amount	This is the amount of transaction in Foreign Currency
Rate	This is the exchange rate for FCY and LCY
LCY Amount	This is the amount of transaction in Local Currency
Current Balance	This is the current balance in the account

## **36.14 Customer Details Report**

This report gives details of the customer and you can generate this report using the 'Customer Details' screen.

You can invoke this screen by typing 'STRCIF' in the field at the top right corner of the Application tool bar and clicking the adjoining arrow button.

### 36.14.1 Contents of Report

The parameters specified while generating the report are printed at the beginning of the report. Other content displayed in the report is as follows:

#### **Header**

The Header carries the branch, information on the branch date, the user ID, the module name, the date and time at which the report was generated and the page number of the report.

#### **Body of the report**

The details of the customer information details that would be displayed in the report are as follows:

Field Name	Description
Customer Information	
Customer	Customer Identification Number of the customer
PID No	Indicates the Personal Identification number
Customer Name	Customer name
Address lines	Displays the address of the customer.
Country	The country the customer belongs to.
Nationality	The nationality of the customer.
Type	Type of the customer (individual or Corporate or Bank).



Unique ID Name	Displays the customer's unique id name.
Unique ID Value	Displays the customer's unique id value.
Creation Date	Displays the date of customer's number creation.
Input By	The Login ID of the user that created the customer record.
Input Date and Time	The date the customer record was created.
Auth By	The Login ID of the user that has authorized the record.
Auth Date and Time	The date of the authorization.
Mod Number	Displays the number of times the record was modified.
Auth Stat	Displays the current status of the customer record.
Record	Displays the record status.
Exposure Country	Displays the exposure country details.
Frozen	Displays the frozen status of the customer's account.
Local Branch	Displays the customer's local branch details.
Whereabouts Unknown	Gives the customer's details regarding the whereabouts.
Deceased	Indicates whether the customer is fit or deceased.
Short Name	Customer's abbreviated name.
Liability	This is the customer Liability ID number for which credit facility granted to the customer.
Language	Language.
Category	Category of the customer of the bank.
Professional Details	
Designation	Indicates Designation
Employer	Indicates Employer
Status	Indicates Status
Tenure	Indicates Tenure

Address	Indicates Address
Email	Indicates Email
Fax	Indicates Fax
Phone	Indicates Phone
Telex	Indicates Telex
Home Value	Indicates Home Value
Insurance	Indicates Insurance
Loans	Indicates Loans
Expenses	Indicates Expenses
Income	Indicates Income
Previous Designation	Indicates Previous Designation
Previous Employer	Indicates Previous Employer
Rent	Indicates Rent
Ret Age	Indicates Ret Age
Credit Cards	Indicates Credit Cards
IE Currency	Indicates IE Currency
Salary	Indicates Salary
Corporate Details	
National Id	Indicates National Id
Name	Indicates Name
Currency Of Amounts	Indicates Currency Of Amounts
Incorporation Country	Indicates Incorporation Country
Incorporation Date	Indicates Incorporation Date
Net worth	Indicates Net worth

Capital	Indicates Capital
Registered Address	Indicates Registered Address
Address 2	Indicates Address 2
Address 3	Indicates Address 3
Country	Indicates Country
Business	Indicates Business
Director Name	Indicates Director Name
Personal Details	
Prefix	Indicates Prefix
First Named	Indicates First Named
Middle Name	Indicates Middle Name
Last Name	Indicates Last Name
Date Of Birth	Indicates Date Of Birth
Sex	Indicates Sex
Domicile	Indicates Domicile
Line 2	Indicates Line 2
Line 3	Indicates Line 3
Domicile Cntry	Indicates Domicile Cntry
Minor	Indicates Minor
Legal Guard.	Indicates Legal Guard.
Passport Number	Indicates Passport Number
Issue Date	Indicates Issue Date
Expiry Date	Indicates Expiry Date
Permanent Address	Indicates Permanent Address

Address	Indicates Address
Country	Indicates Country
National Id	Indicates National Id
Phone	Indicates Phone
Telex	Indicates Telex
Email	Indicates Email
Fax	Indicates Fax
Domestic Details	Indicates Domestic Details
Accommodation	Indicates Accommodation
Dependent Child	Indicates Dependent Child
Dependent Other	Indicates Dependent Other
Education	Indicates Education
Marital Status	Indicates Marital Status
Spouse	Indicates Spouse
Spouse Employment Status	Indicates Spouse Employment Status

The value of Maruyu Customer field will be derived from field Maruyu Status based on the record with latest effective date which is less than or equal to the report date.

The system displays the Maruyu Limit Currency and Account Limit Amount based on the Maruyu Limit record.

## **36.15 Customer Accounts Report**

This report gives details of the customer account and you can generate this report using the 'Customer Accounts' screen.

You can invoke this screen by typing 'STRCUSAC' in the field at the top right corner of the Application tool bar and clicking the adjoining arrow button.

### 36.15.1 Contents of Report

The parameters specified while generating the report are printed at the beginning of the report. Other content displayed in the report is as follows:

#### Header

The Header carries the branch, information on the branch date, the user ID, the module name, the date and time at which the report was generated and the page number of the report.

#### Body of the report

The details of the customer accounts details that would be displayed in the report are as follows:

Field Name	Field Description
Account Number	Details about customer account Number
Account Class	Details about account class
Account Description	Account Description
Opening Date	The opening date of the account.
Dormant	The account status as dormant
Frozen	Account status as frozen.
No Credits	Gives no credit status of the account number.
No Debits	Gives no debit status of the account number.

Stop Payments	Gives the accounts stop pay status.
Statement Cycle	Gives the account statement cycle.
Statement Day	Gives the account statement day.
Statement Type	Gives account statement type.
Alternate Account Number	Gives an alternative account number.
Branch Code	Gives the branch code.
Currency	Currency
Customer Number	Gives customer number.
Nominee1	Gives the first nominee details
Nominee2	Gives the second nominee details
Account Type	Gives the account type.
Dr GL	Gives all debit balances within a specific account class
Cr GL	Gives all credit balances within a specific account class.
Dr HO Line	In this, all accounts belonging to account class will report, if they move to the status being defined.
Cr HO Line	In this, all accounts belonging to account class will report, if they move to the status being defined.
Dr CB Line	This is a GL to which all debit accounts belonging to an account class should report to.
Cr CB Line	This is a GL to which all credit accounts belonging to an account class should report to.
ATM Facility	Availability of ATM facility.
Cheque Book Facility	Availability of cheque book facility.
Passbook Facility	Availability of passbook facility.
Previous Statement Date	Gives the date of the previous statement.
Previous Statement Balance	Gives the balance of the previous statement.
Previous Statement Number	Gives the number of the previous statement

TOD Limit	The temporary overdraft limit facility granted to the customer account
Sublimit	It the overdraft facility maximum permitted to this account associated and tracked against the line id maintained for the liability.
Limit Currency	Displays the currency code of the limit
TOD Limit Start Date	The start date for the temporary overdraft facility
TOD Limit End Date	The end date for the temporary overdraft facility.
Uncollected Funds Limit	The funds hit the account which are debited / credited to the account with effect from the mentioned value days
Line ID	The line code is associated with the liability ID against which the overdraft facility is being tracked.
Tanked Status	It is the status of the transaction that hit the account in a specific branch once the branch is marked for EOTI.
Account Balance	Gives the total account balance
Maker ID	The identification number of the maker
Maker Date Stamp	This is the date on which the contract was uploaded.
Checker ID	This is the Login ID of the user who authorized the product.
Checker Date Stamp	This is the date on which the product was authorized.
Mod Number	Displays the number of times the record was modified.
Record Stat	Displays the current status of the external account record.
Authorization Status	Displays the current authorization status of the record.
Joint Holder Code	Displays joint holder CIF ID
Joint Holder Description	Displays description of the joint holder
Joint Holder	Displays linked entities of the joint holder

The value of Maruyu Customer field will be derived from field Maruyu Status based on the record with latest effective date which is less than or equal to the report date.

The system displays the Maruyu Limit Currency and Account Limit Amount based on the Maruyu Limit record.

## 36.16 Document Check List Report

This report gives you the details of the customer account whose documents are pending for submission, expired, or about to expire.

You can invoke this screen by typing 'STRDOCL' in the field at the top right corner of the Application tool bar and clicking the adjoining arrow button.

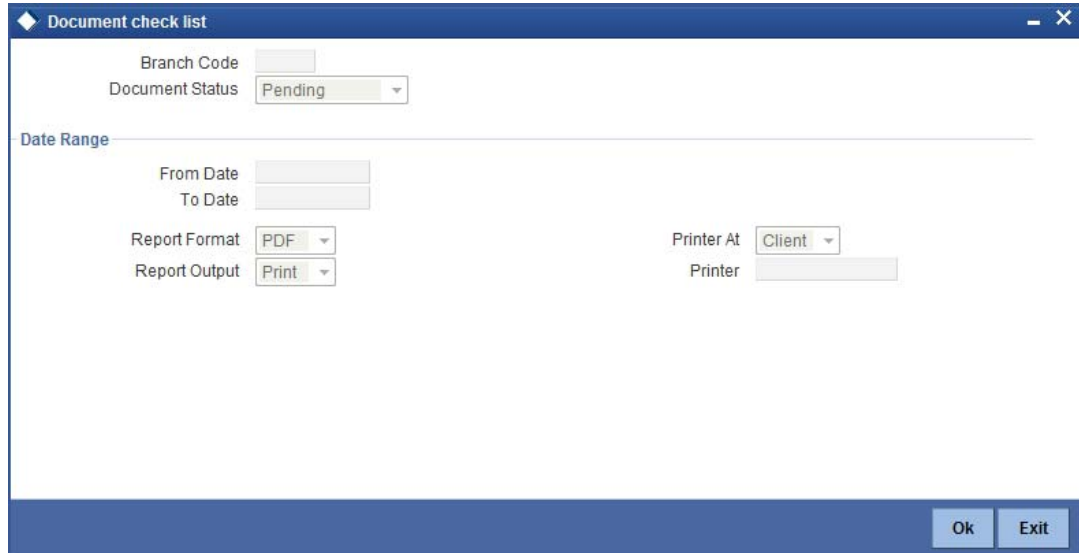

### Branch Code

Specify the branch code

### Document Status

Specify the status of the document submitted by the customer from the adjoining option list. You can select one of the following:

- Pending
- About to Expire
- Expired

---

### Note

- If you select the document status as 'About to Expire', then the 'From Date' should be greater than the current date.
  - If you select the document status as 'Expired', then the 'To Date' should be less than the current date.
- 

### From Date

Specify the date from which details should be made available in the report. The system will include all customers whose date is equal to or greater than this date.

### To Date

Specify the date till which details should be made available in the report. The system will include all customers whose date is equal to or lesser than this date.

### Report Format

Select the format in which you need to generate the report from the adjoining drop-down list. This list displays the following values:



- HTML – Select to generate report in HTML format.
- RTF – Select to generate report in RTF format.
- PDF – Select to generate report in PDF format.
- EXCEL – Select to generate report in EXCEL format.

### **Report Output**

Select the report output in which you need to generate the report from the adjoining drop-down list. This list displays the following values:

- Print – Select to print the report.
- View – Select to print the report.
- Spool – Select to spool the report to a specified folder so that you can print it later.

### **Printer At**

Select location where you wish to print the report from the adjoining drop-down list. This list displays the following values:

- Client – Select if you need to print at the client location.
- Server – Select if you need to print at the server location

### **Printer**

Select printer using which you wish to print the report from the adjoining option list.

## **36.16.1 Contents of the Report**

### **Header**

The Header carries the title of the report, information on the branch code, the ID of the user who generated the report, the date and time at which it was generated and the modules covered in the report.

### **Body of the Report**

<b>Field Name</b>	<b>Field Description</b>
Branch Code	Current branch code
Customer Number	Customer identification number
Customer Name	Customer name
Customer Account Number	Customer account number
Document Type	Type of document
Expiry Date	Expiry date of the document
Expected Date of Submission	Expected date of document submission
Actual Submission Date	Actual document submission date

## **36.17 Memo Revaluation Report**

You can invoke this screen by typing 'ACRMREVL' in the field at the top right corner of the Application tool bar and clicking the adjoining arrow button.

The screenshot shows a software window titled "Memo Revaluation Report". The window has a blue header bar. Below the header, there are four controls arranged in two rows. The first row contains "Report Format" with a dropdown menu showing "PDF" and "Printer At" with a dropdown menu showing "Client". The second row contains "Report Output" with a dropdown menu showing "Print" and an empty text field labeled "Printer". At the bottom right of the window, there are two buttons: "Ok" and "Exit".

### **36.17.1 Contents of Report**

#### **Header**

The Header carries the title of the Report, information on the branch code, the branch date, the user ID, the module name, the date and time at which the report was generated and the page number of the report.

### **Body of the Report**

<b>Field Name</b>	<b>Field Description</b>
Currency	This is the currency for which transaction details is being reported
Revaluation Rate	This is the revaluation rate
Account	This is the account for which transaction details is being reported
Description	This is the description provided
Account Revalued	This is the revalued account
Account Balance	This indicated the account balance
Lcy Equivalent (before reval)	This indicates the local currency before revaluation
Lcy Equivalent (after reval)	This indicates the local currency after revaluation
Profit/ Loss	This is the profit or loss incurred
Profit/ Loss Amount	This is the profit or loss amount
P&L Account	This is the profit or loss account
Currency	This is the currency for which transaction details is being reported
Rate	This is the revaluation rate
Category	This is the category

### **36.18 Black Listed During Contract Booking Report**

You can invoke 'Black Listed During Contract Booking Report' screen by typing 'CSRPBLCB' in the field at the top right corner of the Application tool bar and clicking on the adjoining arrow button.

The screen is as shown below:

Black Listed During Contract Booking

Date

Report Format PDF ▾

Report Output Print ▾

Printer At Client ▾

Printer

Ok Exit

**Date**

Specify the date when the contract was black listed from the adjoining calendar.

**36.18.1 Contents of the Report**

The contents of the report are discussed under the following heads:

**Header**

The header carries the Report Name, Branch, Branch Date, User Id, Module, Run Date and Time.

### **Body of the Report**

<b>Field Name</b>	<b>Field Description</b>
Reference Number	<b>Indicates the reference number</b>
Customer Number	Indicates the customer number
Customer Name	This indicates the name of the customer
Nationality	Indicates the nationality of the customer
Unique ID Name	Indicates the unique identification name
RM Code	Indicates the relationship manager code
RM Name	Indicates the name of relationship manager

## **36.19 Black List Report During File Upload Report**

You can invoke 'Black List Report During File Upload' screen by typing 'CSRPBLUP' in the field at the top right corner of the Application tool bar and clicking on the adjoining arrow button.

The screen is as shown below:

The screenshot shows a window titled "Black List Report During File Upload". The window contains the following elements:

- Report Format:** A dropdown menu currently set to "PDF".
- Report Output:** A dropdown menu currently set to "Print".
- Printer At:** A dropdown menu currently set to "Client".
- Printer:** An empty text input field.
- Buttons:** "Ok" and "Exit" buttons are located at the bottom right of the window.

### **36.19.1 Contents of the Report**

The contents of the report are discussed under the following heads:

## Header

The header carries the Report Name, Branch, Branch Date, User Id, Module, Run Date and Time.

## Body of the Report

Field Name	Field Description
Customer Number	Indicates the customer number
Customer Name	This indicates the name of the customer
Nationality	Indicates the nationality of the customer
Unique ID Name	Indicates the unique identification name
Unique ID Value	Indicates the unique identification value
RM Code	Indicates the relationship manager code
RM Name	Indicates the name of relationship manager

## **36.20 Cheque Book Issued Report**

You can invoke 'Cheque Book Issued Report' screen by typing 'CSRPCBH' in the field at the top right corner of the Application tool bar and clicking on the adjoining arrow button.

The screen is as shown below:

The screenshot shows a software window titled "Cheque Book Issued Report". At the top, there are two radio buttons: "All Branches" (which is selected) and "Single Branch". Below these is a text input field labeled "Branch". A horizontal line separates the top section from the "Date Range" section, which contains "From Date" and "To Date" input fields. Below the date range are two dropdown menus: "Report Format" (set to "PDF") and "Report Output" (set to "Print"). To the right of these are "Printer At" (set to "Client") and "Printer" input fields. At the bottom right of the window, there are "Ok" and "Exit" buttons.

### **Branch Code**

You can generate this report for all the branches or a single branch alone. You can indicate the branch for which the report is being generated using the following options:

- All – If you choose this, the system will generate the report for all the branches.
- Single – If you choose this, you need to specify the branch code for which the report should be generated. The option list displays all valid branch codes maintained in the system. Choose the appropriate one.

### **Date Range**

#### **From Date**

Specify a valid date from when you wish to generate the report from the adjoining calendar.

#### **To Date**

Specify a valid date till when you wish to generate the report from the adjoining calendar.

## **36.20.1 Contents of the Report**

The parameters specified while generating the report are printed at the beginning of the report. Other content displayed in the report is as follows:

### **Header**

The header carries the Report Name, Branch, Branch Date, User Id, Module, Run Date and Time.

### **Body of the Report**

<b>Field Name</b>	<b>Field Description</b>
Date of Issue	Indicates the date of issue
Issuing Channel	Indicates the Issuing Channel
Account Number	Indicates the account number
Account Currency	Indicates the account currency
Account Name	Indicates the account name
Serial Number	Indicates the serial number
Maker ID	Indicates the maker ID
Checker ID	Indicates the checker ID

## **36.21 Demand Draft Issued Report**

You can invoke 'Demand Draft Issued Report' screen by typing 'CSRPDDRP' in the field at the top right corner of the Application tool bar and clicking on the adjoining arrow button.

The screen is as shown below:

The screenshot shows a dialog box titled "Demand Draft Issued Report". It contains the following controls:

- Radio buttons for "All Branches" (selected) and "Single Branch".
- A text input field labeled "Branch".
- Dropdown menus for "Report Format" (set to "PDF") and "Report Output" (set to "Print").
- Dropdown menus for "Printer At" (set to "Client") and "Printer".
- "Ok" and "Exit" buttons at the bottom right.

### **Branch Code**

You can generate this report for all the branches or a single branch alone. You can indicate the branch for which the report is being generated using the following options:

- All – If you choose this, the system will generate the report for all the branches.
- Single – If you choose this, you need to specify the branch code for which the report should be generated. The option list displays all valid branch codes maintained in the system. Choose the appropriate one.

### **36.21.1 Contents of the Report**

The parameters specified while generating the report are printed at the beginning of the report. Other content displayed in the report is as follows:

#### **Header**

The header carries the Report Name, Branch, Branch Date, User Id, Module, Run Date and Time.



### **Body of the Report**

<b>Field Name</b>	<b>Field Description</b>
Account Number	Indicates the account number
Account Name	This indicates the name of the account
Currency	Indicates the currency of the account
Amount	Indicates the amount
Instrument Number	Indicates the instrument number
Description	Indicates the description of the demand draft
Cheque Number	Indicates the Cheque Number
Drawn On	Indicates the date when the DD was drawn
Input On	Indicates the date when the data was provided
Reference Number	Indicates the reference number
Maker ID	Indicates the identification of the maker of the record
Maker Date Stamp	Indicates the date when the record was created
Checker ID	Indicates the identification of the checker who authorized the record
Checker Date Stamp	Indicates the date on which the record was authorized

## **36.22 PDC Input Report**

You can invoke 'PDC Input Report' screen by typing 'CSRPPDC' in the field at the top right corner of the Application tool bar and clicking on the adjoining arrow button.

The screen is as shown below:

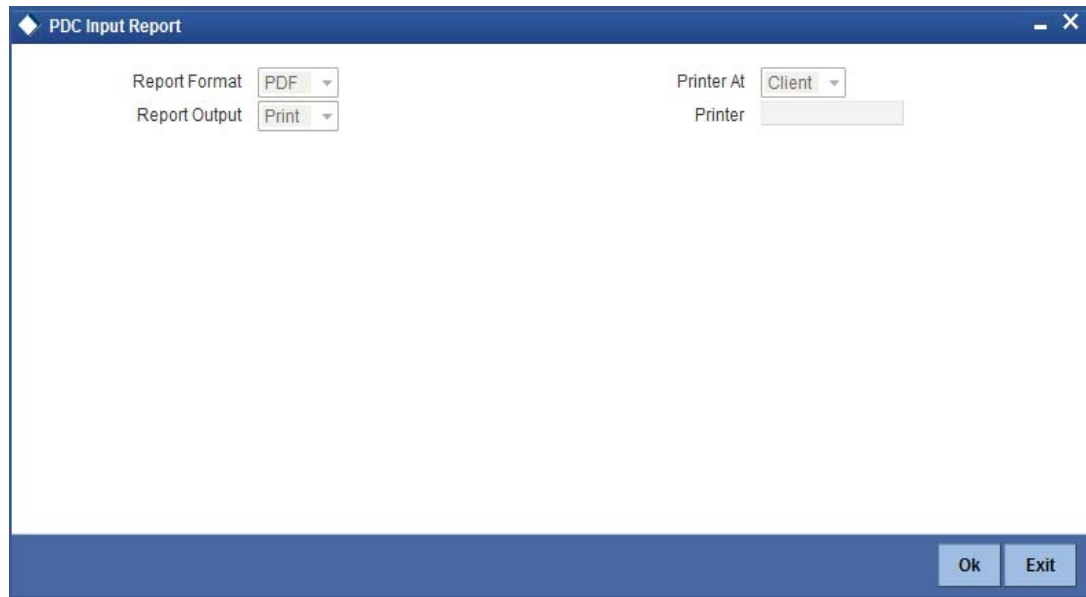

The screenshot shows a dialog box titled "PDC Input Report". It contains four dropdown menus: "Report Format" set to "PDF", "Report Output" set to "Print", "Printer At" set to "Client", and an empty "Printer" field. At the bottom right, there are "Ok" and "Exit" buttons.

### **36.22.1 Contents of the Report**

The contents of the report are discussed under the following heads:

#### **Header**

The header carries the Report Name, Branch, Branch Date, User Id, Module, Run Date and Time.

### **Body of the Report**

<b>Field Name</b>	<b>Field Description</b>
Account Number	Indicates the account number
Account Name	This indicates the name of the account
Currency	Indicates the currency of the account
Amount	Indicates the amount
Instrument Number	Indicates the instrument number
Bank Name	Indicates the name of the bank
Clearing Date	Indicates the date of clearing
Value Date	Indicates the value date of the demand draft
Maker ID	Indicates the identification of the maker of the record
Maker Date Stamp	Indicates the date when the record was created
Reference Number	Indicates the reference number

### **36.23 Temporary Overdraft Report**

You can invoke 'Temporary Overdraft Report' screen by typing 'CSRTEMOD' in the field at the top right corner of the Application tool bar and clicking on the adjoining arrow button. Temporary overdraft report displays only current and savings account of the customer.

The screen is as shown below:

The screenshot shows a window titled "Temporary Overdraft Report" with two main sections: "Branch Details" and "Customer".

- Branch Details:**
  - Radio buttons:  All,  Single
  - Text field: Branch Code
  - Dropdown: Report Format (PDF)
  - Dropdown: Report Output (Print)
- Customer:**
  - Radio buttons:  Bank,  Corporate,  Individual,  All
  - Dropdown: Printer At (Client)
  - Text field: Printer

Buttons: Ok, Exit

### Branch Code

You can generate this report for all the branches or a single branch alone. You can indicate the branch for which the report is being generated using the following options:

- All – If you choose this, the system will generate the report for all the branches.
- Single – If you choose this, you need to specify the branch code for which the report should be generated. The option list displays all valid branch codes maintained in the system. Choose the appropriate one.

### Customer Type

Select the type of customer from the following options provided:

- Bank
- Corporate
- Individual
- All

## 36.23.1 Contents of the Report

The parameters specified while generating the report are printed at the beginning of the report. Other content displayed in the report is as follows:

### Header

The header carries the Report Name, Branch, Branch Date, User Id, Module, Run Date and Time.

### **Body of the Report**

<b>Field Name</b>	<b>Field Description</b>
Customer Account Number	Indicates the customer account number
Customer Name	This indicates the name of the customer
Customer Type	Indicates the type of customer
Account Description	Displays the description for the account
Branch	Indicates the branch of the account
Customer Number	Indicates the customer number
Account Class	Indicates the account class of the customer
Customer Category	Indicates the category to which customer belong to
MIS Code	Indicates the MIS code
Currency	Indicates the currency of the account
Holding Amount	Indicates the holding amount
LCY Opening Balance	Indicates the opening balance in local currency
ACY Opening Balance	Indicates the opening balance of the account currency
ACY Available Balance	Indicates the available balance of the account currency
ACY Current Balance	Indicates the current balance of the account currency
Temp OD Since	Indicates the date when the temp OD was started
Overdraft Since	Indicates the date when the overdraft was started
Temp OD Debits Today	Indicates the day's temp OD debits
Temp OD Credits Today	Indicates the day's temp OD credits

## **36.24 Daily Sales Report**

You can invoke the screen by typing the code 'CORDSLRP' in the field at the top right corner of the Application tool bar and click on the adjoining arrow button.

You can specify the following parameters here:

**Branch Code**

Specify the branch code from the adjoining option list.

**From Date**

Specify a valid date from when you wish to generate the report from the adjoining calendar.

**To Date**

Specify a valid date till when you wish to generate the report from the adjoining calendar.

**36.24.1 Contents of the Report**

The parameters specified while generating the report are printed at the beginning of the report. Other content displayed in the report is as follows:

**Header**

The following details are displayed in the header section:

Field Name	Field Description
Branch	Indicates Branch Code and Branch Name
Branch Date	Indicates Current Date of the Branch
User ID	Indicates User ID
Date & Time	Indicates the Date and Time when the report was generated
Module	Indicates module for which report is generated.

## **Body of the Report**

The following details are displayed as body of the generated report:

<b>Field Name</b>	<b>Field Description</b>
Module	Indicates the module code
Outstanding Amount	Indicates the outstanding amount
Product Code	Indicates the product code
Customer ID	Indicates the customer ID
Customer Name	Indicates the name of the customer
Product Description	Indicates the product description
Account Number	Indicates Customer Account number
Booking Date	Indicates the date of booking
Branch Name	Indicates Branch Name
RM Code	Indicates the relationship manager code
DS Code	Indicates the DS code

## **36.25 Exception Report**

The report gives details of overrides accepted during transaction processing.(for example, Available Balance \* for \* is less than the Min balance for the A/c Class, Signature Verification not done, etc. You can specify the period for which you require the report when you invoke the report function. In the Application Browser, this report is available under the Signature Verification module.

To invoke this screen type 'SVROV' in the field at top right corner of the Application tool bar and click the adjoining arrow button.

The screenshot shows a window titled "Exception Report" with a blue header and standard window controls. The main area contains several input fields and dropdown menus:

- Module**: A text input field with a search icon.
- Description**: A text input field.
- All Modules**: A checked checkbox.
- Report Format**: A dropdown menu set to "PDF".
- Report Output**: A dropdown menu set to "Print".
- Printer At**: A dropdown menu set to "Client".
- Printer**: A text input field with a search icon.

At the bottom right, there are "Ok" and "Exit" buttons.

### 36.25.1 Contents of the Events Log

The contents of this report are discussed under the following heads:

#### Header

The Header carries the title of the report, information on the branch code, the ID of the user who generated the report, the date and time at which it was generated, the branch date, the modules covered in the report.

#### Body of the report

The following details are displayed in the report.

Module	The module of the report
Contract Reference	The contract reference number of the transaction
Event Sequence Number	The sequence number of the event
Instrument Code	The instrument code of the transaction
User Id	The Id of the user who generates the report
Auth Id	The Id of the person who authorized the transaction
Exception	Override message



---

## 37. Function ID Glossary

### A

ACDIBMNT .....	9-1
ACRDLTXN .....	36-1
ACRJRNAL .....	36-4
ACRMREVL .....	36-34
ACRPCASH .....	36-6
ACRPFVBL .....	36-9
ACRPMOVE .....	36-22
ACRREVAL .....	36-20

### C

CFDCUMRG .....	15-4
CORDSLRP .....	36-46
CSDACRHM .....	5-35
CSDAMLCG .....	32-5
CSDAMLLM .....	32-4
CSDAMLPC .....	32-2
CSDDEMAN .....	11-1
CSDDEVDT .....	33-1
CSDDEVPR .....	33-4
CSDOVDMT .....	25-4
CSDPLMNT .....	10-24
CSDPXMNT .....	14-6
CSDRAMDN .....	3-1
CSRPACKCO .....	36-13
CSRPACTJ .....	36-15
CSRPBLCB .....	36-35
CSRPLUP .....	36-37
CSRPCHB .....	36-38
CSRPPDRP .....	36-39
CSRPEXCP .....	36-17
CSRPPDC .....	36-41
CSRTEMOD .....	36-43
CSSACRHM .....	5-36
CSSDEVDT .....	33-3
CSSDEVPR .....	33-6
CYDBATRT .....	14-5

CYDCCYPE .....	14-13
CYDCCYPR .....	13-1
CYDCUSPR .....	15-3
CYDCYTHR .....	14-10
CYDRATEE .....	14-1
CYDSPRDF .....	15-1
CYRTCURR .....	36-10
CYRTHIST .....	36-12
CYSCYTHR .....	14-12

### F

FTDVDSRP .....	10-12
----------------	-------

### I

IADIBMNT .....	9-5
ISDINSTN .....	10-21

### L

LMDTYPES .....	10-23
----------------	-------

### S

STDBANKP .....	2-1
STDBRANC .....	5-3
STDBRRES .....	2-8
STDDATES .....	7-1
STDDEALR .....	4-1
STDLOCHL .....	21-1
STDNETQY .....	9-6
STDSTSCD .....	18-1
STDTRCOD .....	19-1
STDTRNCD .....	32-7
STDTXCYL .....	5-31
STRCIF .....	36-24
STRCUSAC .....	36-29
STRDOCL .....	36-32
SVROV .....	36-47