

MT Task Creation User Guide

Oracle FLEXCUBE Universal Banking

Release 12.87.04.0.0

Part No. E92710-01

January 2018

MT Task Creation User Guide
January 2018
Oracle Financial Services Software Limited

Oracle Park

Off Western Express Highway
Goregaon (East)
Mumbai, Maharashtra 400 063
India

Worldwide Inquiries:

Phone: +91 22 6718 3000

Fax: +91 22 6718 3001

www.oracle.com/financialservices/

Copyright © 2007, 2018, Oracle and/or its affiliates. All rights reserved.

Oracle and Java are registered trademarks of Oracle and/or its affiliates. Other names may be trademarks of their respective owners.

U.S. GOVERNMENT END USERS: Oracle programs, including any operating system, integrated software, any programs installed on the hardware, and/or documentation, delivered to U.S. Government end users are "commercial computer software" pursuant to the applicable Federal Acquisition Regulation and agency-specific supplemental regulations. As such, use, duplication, disclosure, modification, and adaptation of the programs, including any operating system, integrated software, any programs installed on the hardware, and/or documentation, shall be subject to license terms and license restrictions applicable to the programs. No other rights are granted to the U.S. Government.

This software or hardware is developed for general use in a variety of information management applications. It is not developed or intended for use in any inherently dangerous applications, including applications that may create a risk of personal injury. If you use this software or hardware in dangerous applications, then you shall be responsible to take all appropriate failsafe, backup, redundancy, and other measures to ensure its safe use. Oracle Corporation and its affiliates disclaim any liability for any damages caused by use of this software or hardware in dangerous applications.

This software and related documentation are provided under a license agreement containing restrictions on use and disclosure and are protected by intellectual property laws. Except as expressly permitted in your license agreement or allowed by law, you may not use, copy, reproduce, translate, broadcast, modify, license, transmit, distribute, exhibit, perform, publish or display any part, in any form, or by any means. Reverse engineering, disassembly, or decompilation of this software, unless required by law for interoperability, is prohibited.

The information contained herein is subject to change without notice and is not warranted to be error-free. If you find any errors, please report them to us in writing.

This software or hardware and documentation may provide access to or information on content, products and services from third parties. Oracle Corporation and its affiliates are not responsible for and expressly disclaim all warranties of any kind with respect to third-party content, products, and services. Oracle Corporation and its affiliates will not be responsible for any loss, costs, or damages incurred due to your access to or use of third-party content, products, or services.

Contents

1. MT Task Creation Process	1-1
1.1 Introduction.....	1-1
1.2 MT Task Creation	1-1
1.2.1 SWIFT Message –Task Creation	1-1
1.2.2 Gateway Message Task Creation	1-2
1.3 MT Task Process.....	1-3
1.3.1 Flow Diagram	1-3
1.4 Stages in MT Task Creation	1-3
1.4.1 Task Initiation – Maker	1-3
1.4.2 Checker	1-7
1.4.3 CABLE Room Operator	1-8
1.4.4 Completed Stage.....	1-9
1.5 Stage Transition Rule	1-9
1.6 Role Responsibility Matrix	1-10
2. Function ID Glossary	2-1

1. Preface

1.1 Introduction

This manual is designed to help acquaint you with the MT Task Creation Process of Oracle FLEXCUBE.

This manual provides explanations about the various MT Task creation process. You can obtain information specific to a particular field by placing the cursor on the relevant field, and striking <F1> on the keyboard.

1.2 Audience

This manual is intended for the following User/User Roles:

Role	Function
Back Office Trade Finance Department Clerks	Contract Input functions except Authorization.
Back Office Trade Finance Department Officers	Contract Authorization, maintenance of static data specific to this module.
Front end Trade Finance Product Managers	Product definition functions excluding authorization. Query functions.
End of Day Operators	End and beginning of day related processing functions
Bank's Financial Controller/Trade Finance Department Manager	Branch level processing related setup for this module and Authorization of the same.
MIS Department Officers	Query/Report functions.

1.3 Documentation Accessibility

For information about Oracle's commitment to accessibility, visit the Oracle Accessibility Program website at <http://www.oracle.com/pls/topic/lookup?ctx=acc&id=docacc>.

1.4 Organization





This Manual is organized into the following chapters:

Chapter 1	<i>About this Manual</i> gives information on the intended audience. It also lists the various chapters covered in this User Manual.
Chapter 2	<i>MT Task Creation Process</i> explains about the various tasks involved in the MT creation process.

Chapter 3	<i>Function ID Glossary</i> has alphabetical listing of Function/Screen ID's used in the module with page references for quick navigation.
------------------	--

1.5 Glossary of Icons

This User Manual may refer to all or some of the following icons.

Icons	Function
	Exit
	Add row
	Delete row
	Option List

1.6 Related Documents

You may need to refer to any or all of the User Manuals while working on the MB module:

- Core Entities
- Inventory
- ELCM
- Procedures
- Products
- User Defined Fields

1. MT Task Creation Process

1.1 Introduction

Oracle FLECUBE supports two types of message processing, namely Swift message (STP and Non- STP) and Gateway message.

During STP processing, a contract will be created when the incoming messages are subjected to STP rules and pass through the rules. If the incoming message fails to clear the defined STP rules or when the data could not be parsed or extracted then the message will be tanked and available for repair from the incoming browser window. All the non-STP messages will be in the unprocessed state and can be viewed in the incoming browser.

The gateway messages are processed and for a successful transaction, a response will be sent to the external system. If the transaction fails, then an error response will be sent to the external system along with the error details.

1.2 MT Task Creation

The list of SWIFT messages and Gateway messages for which a task is to be created are configured when:

- The incoming SWIFT message is failed or put on hold.
- The gateway message is moved to the dead letter queue or if the transaction fails.

1.2.1 SWIFT Message –Task Creation

The task creation for SWIFT message depends on the maintenance done in the 'STP Message Maintenance Details' screen. You can invoke this screen by typing 'MSDSTPSC' in the field at the top right corner of the Application tool bar and clicking the adjoining arrow button.

Using the 'STP Message Maintenance Details' screen, MT Task/Business Task can be created, if:

- The STP process is not required
- The STP process fails
- The STP process is successful and contract is put on hold

Refer the chapter 'Maintaining Advice Formats' in the Messaging System User Manual for more details on the screen.

1.2.2 Gateway Message Task Creation

The task creation for Gateway message depends on the maintenance done in the 'Gateway Maintenance' screen. You can invoke this screen by typing 'STDGWINT' in the field at the top right corner of the Application tool bar and clicking the adjoining arrow button.

Refer the chapter 'External System Maintenance' in the Gateway User Manual for more details on the screen.

1.3 MT Task Process

MT TASK process is a monitoring process for tracking the SWIFT messages/Gateway Transactions. It would be initiated based on the maintenance done for SWIFT messages and Gateway Transactions.

1.3.1 Flow Diagram

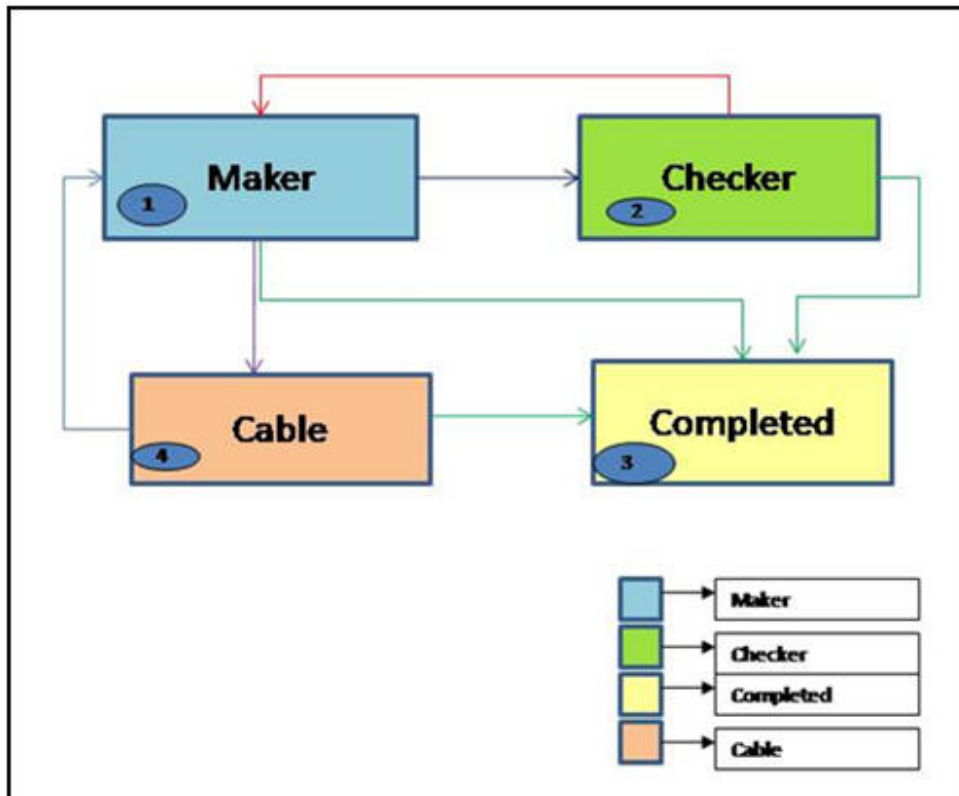

1.4 Stages in MT Task Creation

In Oracle FLEXCUBE, the process for MT task creation is governed by several user roles created to perform different tasks. At every stage, the users (with requisite rights) need to fetch the relevant transactions from their task lists and act upon them.

The MT task creation process comprises the following stages:

- Task Initiation – Maker
- Checker
- CABLE Room Operator
- Completed Stage

Only users who have procured the relevant access rights can perform activities under a stage.

1.4.1 Task Initiation – Maker

When the incoming SWIFT message is received, the Maker views the message and performs any one of the following task:

- Edits the incoming message/create a new contract and submit the tracking task to the checker for authorization of the message amendment/contract.
- Moves the task to the completed stage, if any action is not required.
- Refers the task to CABLE room, if the message is not reconciled or intended for the Maker.

For Gateway messages, the Maker views the error details, external reference number, inform the error details to the external system and move the task to the completed stage. On receiving the details from the external system, the maker will do any of the following tasks:

- Create/modify the contract and then move the task to the Checker for authorizing the contract.
- Move the task to the completed stage, if the maker does not want to create/modify the contract
- Send the task to the CABLE room stage, if the message is not intended to them.

Validations:

When the task is sent to the Checker, the system will validate if the contract/message is in auth status, if yes then an error message will be shown.

When the task is sent to the Cable room, system will validate if the contract/message is in un-auth status, if yes then an error message will be shown.

When the task is sent to the Completed Stage, system will validate if the contract/message is in un-auth status, if yes then an Configurable Override message will be shown.

For the maker the Authorize Message button will be disabled.

The screenshot shows the 'Receive and Verify' application window. The window title is 'Receive and Verify' and it contains a 'New' tab. The interface is divided into several sections:

- Workflow Reference #**: A text input field.
- Priority**: A dropdown menu set to 'Low'.
- Message Details**: Includes 'Source Code', 'Source Reference Number *', 'DCN *', 'Message Type', and 'Message Version Number'.
- Contract Details**: Includes 'FLEXCUBE Reference' and 'Module Code'.
- Activity Details**: Includes 'Send To' (dropdown set to 'Completed') and 'Team' (dropdown).
- Error Details**: A table with columns 'Error Code' and 'Error Message'. The table shows one row with empty fields. Above the table are navigation controls (back, forward, search) and a 'Go' button.
- Narrative**: Includes an 'Internal Remarks' text input field.

At the bottom of the window, there is a navigation bar with buttons: 'View Message', 'Online', 'Message Details', 'Edit Message', and 'Authorize Message'. Below this bar, there are 'Prev Remarks' and 'Remarks' labels, an 'Audit' button, an 'Outcome' dropdown menu, and an 'Exit' button.

The system displays the following details:

- Workflow Reference No.
- Source Code
- Source Reference Number
- DCN

- Message Type
- Message Version Number
- Send To
- FCUBS Reference Number
- Module Code
- Error Code
- Error Message
- Internal Remarks

Click on the 'View Message' button to view the message.

Click on the 'Message Details' button to view the message details.

Note

The message details will be available only for STP messages.

Click on the 'Edit Message' button in the 'Receive and Verify' screen to edit the message. The 'Edit Message' screen will be displayed.

The screenshot shows the 'Edit Message' window with the following components:

- Reference No:** [Text Field]
- Sender:** [Text Field]
- SWIFT Message Type:** [Text Field]
- Current Version:** [Text Field]
- Previous Version:** [Text Field]
- Mod Number:** [Text Field]
- Remove Trailer:**
- New Message:** Table with columns: Fields, Tag, Field Name, Field Value
- Old Message:** Table with columns: Fields, Tag, Field Value, De
- Message Trailer:** [Text Field]
- Remarks:** [Text Field]
- Reject Reason:** [Text Field]
- Old Message Trailer:** [Text Field]
- Remarks:** [Text Field]
- Reject Reason:** [Text Field]
- Repair Reason:** Table with columns: Status, Message Status, Latest Version Number, Repair Parameters
- Buttons:** Repair, Save, Authenticate, Exit

Note

You can edit the messages only MT103, MT200, and MT202.

Click on the 'Online Initiation' button in the 'Receive and Verify' screen. The system will launch the appropriate contract online screen based on the module code selected.

For Example, if module 'FT' is selected, system will launch the 'Fund Transfer Contract Input' online screen.

1.4.2 Checker

When the incoming SWIFT messages and Gateway messages are received, the checker will perform the following task:

- View the message and error details
- Create/modify the contract/ message
- Authorize the contract/ message and move the task to the completed stage.

If any information or modification is required, the checker will send the task back to the maker who initiated the task.

Validations:

When the task is sent to the Completed Stage, system will validate if the contract/message is in un-auth status, if yes then a Configurable Override message will be shown.

Checker can view the contract details by clicking on the 'View Online' button.

For the Checker, the 'Edit Message' button will be disabled.

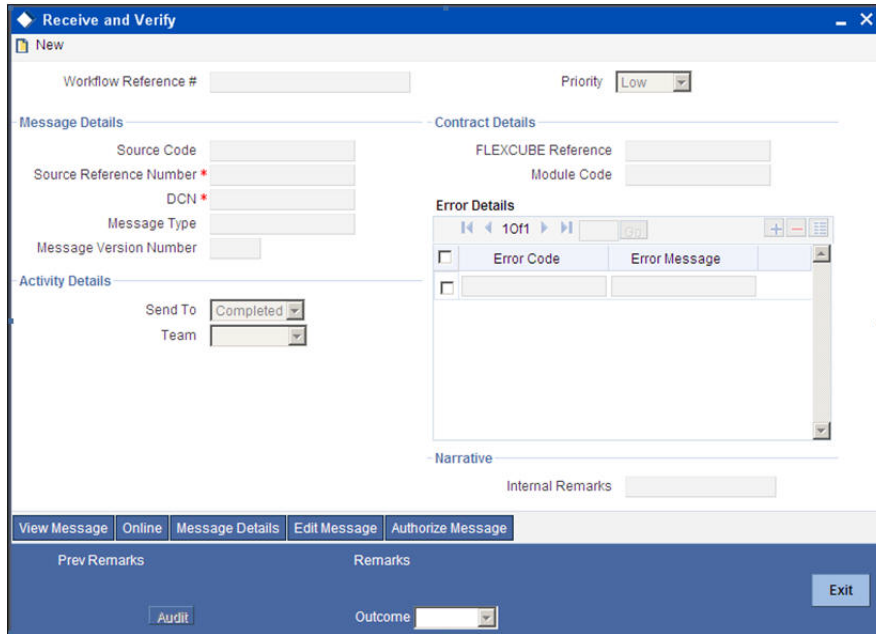

Click on the 'Authorize Message' button to view the edited details and authorize message.

1.4.3 CABLE Room Operator

Cable room operator can view the message, error details and decide whether to send the task to the Maker of Trade Team or Remittance team. Cable room operator can also send the task directly to the completed stage.

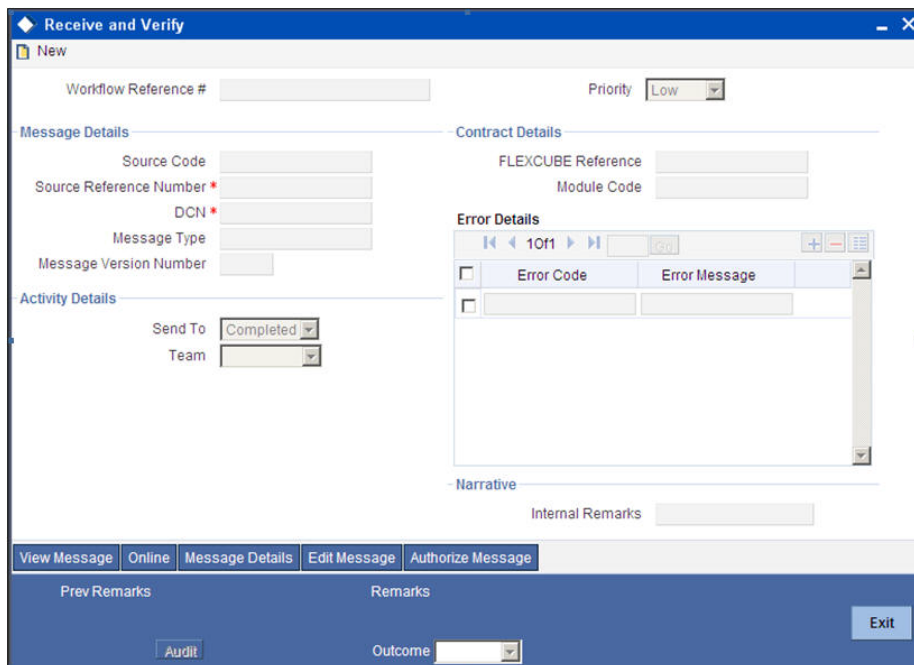

Specify the following details:

Send To

Select the stage to which the task has to be moved from the drop-down list. The list contains the following options:

- Completed

- Maker

Team Option

Select the team to which the task has to be moved from the drop-down list. The list contains the following options:

- Trade
- Remittance

You can select this option only when 'Send to Maker' is 'Team'.

1.4.4 Completed Stage

The user can view the completed stage in the screen.

The screenshot shows the 'Receive and Verify' application window. The 'Send To' dropdown is set to 'Completed' and the 'Team' dropdown is also visible. The 'Error Details' table is empty. The 'Internal Remarks' field is also visible.

Workflow Reference #	Priority
	Low

Message Details	Contract Details
Source Code	FLEXCUBE Reference
Source Reference Number *	Module Code
DCN *	
Message Type	
Message Version Number	

Activity Details
Send To: Completed
Team: [Dropdown]

Error Details				
1 of 1				
<table border="1"> <thead> <tr> <th>Error Code</th> <th>Error Message</th> </tr> </thead> <tbody> <tr> <td></td> <td></td> </tr> </tbody> </table>	Error Code	Error Message		
Error Code	Error Message			

Internal Remarks

View Message | Online | Message Details | Edit Message | Authorize Message

Prev Remarks | Remarks

Audit | Outcome [Dropdown] | Exit

1.5 Stage Transition Rule

Source Stage	Path	Destination Stage	Rule
Task Initiation/ Maker	1 – 3	Completed	Direct filing and when the maker sends the task to the Completed Stage. If the contract is not authorized, then an override will be shown.
Task Initiation/ Maker	1 – 2	Checker	If the Contract is created/modified or if the message is modified.
Checker	2 – 3	Completed	If the Contract/Message is authorized then the Checker can send the task to the completed stage. When the Checker sends the task to the completed stage if the contract/message is not authorized then an override will be shown.

Source Stage	Path	Destination Stage	Rule
Checker	2 – 1	Maker	If the Checker wants any information, he/she will send the task to the maker.
Task Initiation/ Maker	1 – 4	CABLE	If the Maker decides that this task is for his team task then he/she will send the task to the CABLE.
CABLE	4 – 1	Maker	If the CABLE room operator decides to send this task Maker of the Trade team, then he/she will select the Trade Team option and send task to the maker.
			If the CABLE room operator decides to send this task to the Maker of the Remittance team, then he/she will select the Remittance Team option and send task to the maker.
CABLE	4 – 3	Completed	Direct filing

1.6 Role Responsibility Matrix

S. No	Stage	Role	Access rights	Comments
1	Task Initiation/Maker - Trade	Maker-Trade	Modify Task	
		Checker-Trade	View Task	
		Cable	View Task	
2	Checker-Trade	Checker-Trade	Modify Task View Task	
		Maker-Trade	View Task	
		Cable	View Task	
3	Maker-Remittance	Maker-Remittance	Modify Task	
		Checker-Remittance	View Task	
		Cable	View Task	
4	Checker-Remittance	Checker-Remittance	Modify Task View Task	
		Maker-Remittance	View Task	

S. No	Stage	Role	Access rights	Comments
		Cable	View Task	
5	Cable	Cable	Modify Task View Task	
		Maker-Remittance Maker--Trade	View Task	
		Checker-Remittance Checker-Trade	View Task	
5	Completed Transactions	Checker-Remittance Checker-Trade	View Task	
		Cable	View Task	
		Maker—Remittance Maker--Trade	View Task	

2. Function ID Glossary

M

MSDSTPSC 1-1

S

STDGWINT 1-2