

Oracle Financial Services AgileREPORTER Application

Installation Guide

Release 8.1.2.6.0

September 2024

ORACLE
Financial Services

Oracle Legal Notices

Copyright Notice

Copyright © 1994, 2024, Oracle and/or its affiliates.

License Restrictions

This software and related documentation are provided under a license agreement containing restrictions on use and disclosure and are protected by intellectual property laws. Except as expressly permitted in your license agreement or allowed by law, you may not use, copy, reproduce, translate, broadcast, modify, license, transmit, distribute, exhibit, perform, publish, or display any part, in any form, or by any means. Reverse engineering, disassembly, or decompilation of this software, unless required by law for interoperability, is prohibited.

Warranty Disclaimer

The information contained herein is subject to change without notice and is not warranted to be error-free. If you find any errors, please report them to us in writing.

Restricted Rights Notice

If this is software, software documentation, data (as defined in the Federal Acquisition Regulation), or related documentation that is delivered to the U.S. Government or anyone licensing it on behalf of the U.S. Government, then the following notice is applicable:

U.S. GOVERNMENT END USERS: Oracle programs (including any operating system, integrated software, any programs embedded, installed, or activated on delivered hardware, and modifications of such programs) and Oracle computer documentation or other Oracle data delivered to or accessed by U.S. Government end users are "commercial computer software," "commercial computer software documentation," or "limited rights data" pursuant to the applicable Federal Acquisition Regulation and agency-specific supplemental regulations. As such, the use, reproduction, duplication, release, display, disclosure, modification, preparation of derivative works, and/or adaptation of i) Oracle programs (including any operating system, integrated software, any programs embedded, installed, or activated on delivered hardware, and modifications of such programs), ii) Oracle computer documentation and/or iii) other Oracle data, is subject to the rights and limitations specified in the license contained in the applicable contract. The terms governing the U.S. Government's use of Oracle cloud services are defined by the applicable contract for such services. No other rights are granted to the U.S. Government.

Hazardous Applications Notice

This software or hardware is developed for general use in a variety of information management applications. It is not developed or intended for use in any inherently dangerous applications, including applications that may create a risk of personal injury. If you use this software or hardware in dangerous applications, then you shall be responsible to take all appropriate fail-safe, backup, redundancy, and other measures to ensure its safe use. Oracle Corporation and its affiliates disclaim any liability for any damages caused by use of this software or hardware in dangerous applications.

Trademark Notice

Oracle®, Java, MySQL, and NetSuite are registered trademarks of Oracle and/or its affiliates. Other names may be trademarks of their respective owners.

Intel and Intel Inside are trademarks or registered trademarks of Intel Corporation. All SPARC trademarks are used under license and are trademarks or registered trademarks of SPARC International, Inc. AMD, Epyc, and the AMD logo are trademarks or registered trademarks of Advanced Micro Devices. UNIX is a registered trademark of The Open Group.

Third-Party Content, Products, and Services Disclaimer

This software or hardware and documentation may provide access to or information about content, products, and services from third parties. Oracle Corporation and its affiliates are not responsible for and expressly disclaim all warranties of any kind with respect to third-party content, products, and services unless otherwise set forth in an applicable agreement between you and Oracle. Oracle Corporation and its affiliates will not be responsible for any loss, costs, or damages incurred due to your access to or use of third-party content, products, or services, except as set forth in an applicable agreement between you and Oracle.

Pre-General Availability Draft Label and Publication Date

Pre-General Availability: 2024-MM-DD

Pre-General Availability Draft Documentation Notice

If this document is in public or private pre-General Availability status:

This documentation is in pre-General Availability status and is intended for demonstration and preliminary use only. It may not be specific to the hardware on which you are using the software. Oracle Corporation and its affiliates are not responsible for and expressly disclaim all warranties of any kind with respect to this documentation and will not be responsible for any loss, costs, or damages incurred due to the use of this documentation.

Oracle Confidential Label

ORACLE CONFIDENTIAL. For authorized use only. Do not distribute to third parties.

Revenue Recognition Notice

If this document is in private pre-General Availability status:

The information contained in this document is for informational sharing purposes only and should be considered in your capacity as a customer advisory board member or pursuant to your pre-General Availability trial agreement only. It is not a commitment to deliver any material, code, or functionality, and should not be relied upon in making purchasing decisions. The development, release, timing, and pricing of any features or functionality described in this document may change and remains at the sole discretion of Oracle.

This document in any form, software or printed matter, contains proprietary information that is the exclusive property of Oracle. Your access to and use of this confidential material is subject to the terms and conditions of your Oracle Master Agreement, Oracle License and Services Agreement, Oracle PartnerNetwork Agreement, Oracle distribution agreement, or other license agreement which has been executed by you and Oracle and with which you agree to comply. This document and information contained herein may not be disclosed, copied, reproduced, or distributed to anyone outside Oracle without prior written consent of Oracle. This document is not part of your license agreement nor can it be incorporated into any contractual agreement with Oracle or its subsidiaries or affiliates.

Documentation Accessibility

For information about Oracle's commitment to accessibility, visit the Oracle Accessibility Program website at <http://www.oracle.com/pls/topic/lookup?ctx=acc&id=docacc>.

Access to Oracle Support

Oracle customer access to and use of Oracle support services will be pursuant to the terms and conditions specified in their Oracle order for the applicable services.

Document Control

Version Number	Revision Date	Change Log
01	Sep 04, 2024	Installation Guide published

Table of Contents

1	Preface	8
1.1	Summary	8
1.2	Audience.....	8
1.3	Prerequisites for the Audience.....	8
1.4	Access to Oracle Support	8
1.5	Conventions and Acronyms	9
2	OFS AgileREPORTER.....	10
2.1	OFS AgileREPORTER Platform Architecture	10
2.2	OFS AgileREPORTER Modules.....	11
3	Preparing for Installation.....	12
3.1	Installer and Installation Prerequisites	12
3.1.1	<i>Supported Operating Systems</i>	12
3.1.2	<i>Required Software</i>	12
3.1.3	<i>Supported Databases</i>	13
3.1.4	<i>Other Requirements</i>	15
3.2	Obtaining the Software.....	15
3.3	Common Installation Activities	16
3.3.1	<i>Identifying the Installation Directory</i>	16
3.3.2	<i>Copying and Extracting the Software</i>	16
4	Installing the OFS AgileREPORTER Applications Pack	18
4.1	Running the OFS AgileREPORTER Applications Pack Installer	18
4.1.1	<i>Upgrades from Prior Versions of OFSAA AgileREPORTER</i>	19
4.1.2	<i>Running the Installer in GUI Mode</i>	21
4.1.3	<i>Running the Installer in GUI Mode for Upgrade</i>	37
4.1.4	<i>Running the Installer in SILENT Mode</i>	38
4.1.5	<i>Running the Installer in SILENT Mode for Upgrade</i>	43
4.1.6	<i>Verifying the Log File</i>	43
5	Trial Template Package Installation	44

- 5.1 Trial Template Package for US FED 44
- 5.2 Trial Template Package for RBI..... 44
- 5.3 Installing Trial Template Packages 44

- 6 Start or Stop AgileREPORTER Services 46**

- 6.1 Start AgileREPORTER Web Server..... 46
- 6.2 Stop AgileREPORTER Web Server 46

- 7 Error Dictionary..... 47**

- 7.1 Accessing Error Dictionary..... 47
- 7.2 Error Code Dictionary..... 47

1 Preface

This preface provides supporting information for the OFS AgileREPORTER Installation Guide and includes the following topics:

- [Summary](#)
- [Audience](#)
- [Prerequisites for the Audience](#)
- [Access to Oracle Support](#)
- [Conventions and Acronyms](#)

1.1 Summary

You can find the latest copy of this document in the [OHC](#) Library which includes all the recent additions or revisions (if any) done to date.

Before you begin the installation, ensure that you have access to the Oracle Support Portal with the required login credentials to quickly notify us of any issues at any stage. You can obtain the login credentials by contacting My Oracle Support.

1.2 Audience

The OFS AgileREPORTER Pack Installation and Configuration Guide is intended for Administrators, Business Users, Strategists, and Data Analysts, who are responsible for installing and maintaining the application pack components.

1.3 Prerequisites for the Audience

The document assumes you have experience in installing Enterprise components. Basic knowledge about the Oracle Financial Services Advanced Analytical Applications Infrastructure Applications Pack Components, OFSAA Architecture, UNIX Commands, Database Concepts, and Web Server or Web Application Server is recommended.

1.4 Access to Oracle Support

Oracle customers have access to electronic support through My Oracle Support. For information, visit <http://www.oracle.com/pls/topic/lookup?ctx=acc&id=info>

OR

Visit <http://www.oracle.com/pls/topic/lookup?ctx=acc&id=trs> if you are hearing impaired.

1.5 Conventions and Acronyms

The conventions and acronyms used in this guide are as follows.

Table 1: Conventions and Description

Conventions	Description
AIX	Advanced Interactive eXecutive
DEFQ	Data Entry Forms and Queries
DML	Data Manipulation Language
EAR	Enterprise Archive
EJB	Enterprise JavaBean
ERM	Enterprise Resource Management
J2C	J2EE Connector
J2EE	Java 2 Enterprise Edition
JDBC	Java Database Connectivity
JDK	Java Development Kit
JNDI	Java Naming and Directory Interface
JRE	Java Runtime Environment
JVM	Java Virtual Machine
RBI	Reserve Bank of India
US FED	US Federal Reserve

2 OFS AgileREPORTER

OFS AgileREPORTER is a form and workflow tool that enables the creation and submission of regulatory returns. The OFS AgileREPORTER Platform is configured with product configurations delivered using configuration packages. Different configuration packages are loaded into OFS AgileREPORTER to support different sets of regulatory returns, normally on jurisdictional lines.

For example, one configuration package may support US Broker or Dealer returns, whereas another configuration package may support European Common Reporting. When a regulation changes, only a new version of the related configuration package is required, there is usually no need to upgrade OFS AgileREPORTER.

A configuration package contains the following core artifacts:

- Return Template
- Description of the Submission Files for the Regulator
- XBRL Taxonomies
- Validation Rules and Edit Checks
- Bindings to the FSDF Data Model

If you are using an OFSAA - OFS AgileREPORTER Integrated Solution, two configuration packages are required. One is from VERMEG, containing artifacts 1-4 above; and one from Oracle, containing Artifact 5.

[Chapter 3 – Preparing for Installation](#) until [Chapter 6 – Start or Stop AgileREPORTER Services](#) describes how to Install, Update, Configure, Start, and Stop the OFS AgileREPORTER Platform.

2.1 OFS AgileREPORTER Platform Architecture

OFS AgileREPORTER has a web-based User Interface. Users interact with OFS AgileREPORTER to view and edit their regulatory returns using a Standard Web Browser. No browser plugins are required – the User Interface is completely standard compliant (HTML, CSS, and JavaScript).

OFS AgileREPORTER Platform contains an embedded Java EE Server. All the business logic of OFS AgileREPORTER is executed within this server. The server itself is a single Java process running on the Application Server.

OFS AgileREPORTER requires a relational database. Oracle Database is supported. For more details, see [Chapter 3 – Preparing for Installation](#).

Figure 1: AgileREPORTER Platform Architecture

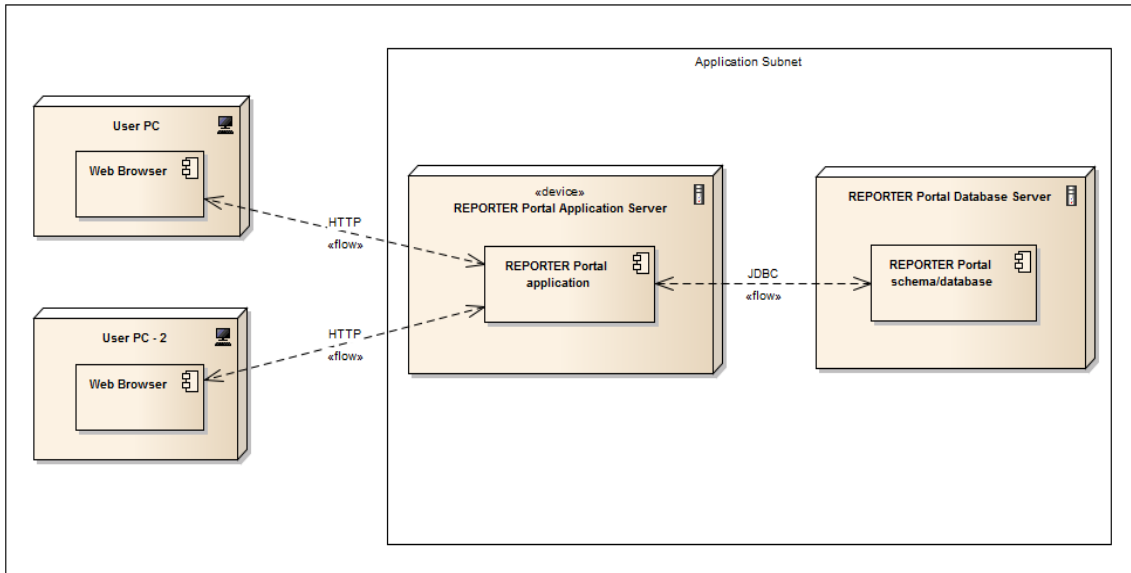

Installation of OFS AgileREPORTER has a prerequisite described in [Chapter 3 – Preparing for Installation](#) to correctly configure the OFS AgileREPORTER Database.

2.2 OFS AgileREPORTER Modules

If licensed sufficiently, OFS AgileREPORTER can also work with optional modules:

- **REPORTER:** AgileREPORTER® Suite provides Calculated Return Data and Form (template) Metadata for OFS AgileREPORTER. If the REPORTER Module is installed for OFS AgileREPORTER, the REPORTER Form (template) Metadata is used instead of OFS AgileREPORTER Return Metadata.
- **OFSAA:** The OFSAA Module for OFS AgileREPORTER provides integration with Oracle Financial Services Application Architecture. Oracle’s OFSAA provides Calculated Return Data which is read directly from OFSAA’s results area and applied to form (template) metadata in OFS AgileREPORTER.

3 Preparing for Installation

This chapter provides the necessary information to review before installing the OFS AgileREPORTER Applications Pack v8.1.2.6.0.

Topics:

- [Installer and Installation Prerequisites](#)
- [Download the OFS AgileREPORTER Application Pack Installer](#)
- [Common Installation Activities](#)

3.1 Installer and Installation Prerequisites

This section describes the installation prerequisites for OFS AgileREPORTER Pack.

3.1.1 Supported Operating Systems

OFS AgileREPORTER is supported on the following Operating System:

- Linux
 - Red Hat Enterprise Linux 8.x and 9.x
 - Oracle Enterprise Linux 8.x and 9.x

3.1.2 Required Software

The required software for this release are as follows:

- Java Runtime Environment (JRE) (version 8 update 202 or later updates of version 8, Oracle HotSpot™). The `JAVA_HOME` environment variable should point at the JRE Installation Folder, and Java (in UNIX) or `java.exe` (in Windows) should be placed in the system path.

NOTE Use the Oracle JRE distribution. Open JDK is not supported.

How is Java used?

If the Application Server that OFS AgileREPORTER is installed on has multiple versions of Java installed, OFS AgileREPORTER attempts to use Java in the following order, moving to the next location if Java cannot be found:

- `JAVA_HOME` properties defined in the `ocelot.properties` file. This is a local version of the `JAVA_HOME` properties and does not impact other applications using this variable.
- `JAVA_HOME` defined at the system level (if not defined or overridden in the `ocelot.properties` file). This variable can be shared by other applications, therefore, be careful if you want to modify it.
- The Java executable in the system path. This is the version of Java that is used when Java is entered at the command line.

Ensure that the `JAVA_HOME` property points to a valid Java folder. For example, if the Java executable is in `/opt/java/Jre17/bin/java`, then set `JAVA_HOME=/opt/java/Jre17`

Java Use Case Examples

- **Use the system-level `JAVA_HOME`**

Ensure that the System level `JAVA_HOME` is valid and that `JAVA_HOME` is not defined in the `ocelot.properties` file.

- **Use a different version of Java than the one defined by the system-level `JAVA_HOME`**

Define `JAVA_HOME` in the `ocelot.properties` file.

- **Unsure about `JAVA_HOME` and it is not defined on the installation computer**

Check if `JAVA_HOME` is defined in your system by entering the following at the command line:

Linux:

```
echo $JAVA_HOME
```

If `JAVA_HOME` is not defined in your system, then check if the `java -version` can be run at the command line. If yes, the OFS AgileREPORTER uses the same version.

- Oracle Financial AgileREPORTER 8.0.9.2.0 (Patch ID **31830937**) if upgrading from an earlier version. This is not applicable for a fresh installation.
- Oracle Financial Services Data Foundation (OFSDF) 8.1.0.0.0 (Patch ID) plus other prerequisite OFSDF Patches (see **Section 4.1 Pre-installation Checklist** of [OFSDF Installation Guide](#)) should be installed and configured on your Machine.

3.1.3 Supported Databases

OFS AgileREPORTER supports Oracle Database 19c.

NOTE	This guide mentions SQL Server throughout. Do not use these SQL Server Options and Settings. Full SQL Server Support will be finalized in a later version.
-------------	------------------------------------------------------------------------------------------------------------------------------------------------------------

3.1.3.1 Oracle-specific Settings

OFS AgileREPORTER requires a schema for installation and Runtime. The same schema can be used for both. If desired for security reasons, you can use the schemas as follows:

- An Owner Schema that has DDL Privileges. This schema is only used at installation and during Configuration Manager Operations and can otherwise be locked.
- An App Schema that only has DML Privileges. This schema is used at Runtime.

The Owner Schema requires the following privileges (granted by someone with System Database Administrator Privileges):

You require SYSDBA Privileges to Run the last four grants.

- Grant Create Session to <owner>;
- Grant Create Trigger to <owner>;
- Grant Create Table to <owner>;
- Grant Create Sequence to <owner>;
- Grant Create View to <owner>;
- Grant Select on pending_trans\$ to <owner>;
- Grant Select on dba_2pc_pending to <owner>;
- Grant Select on dba_pending_transactions to <owner>;
- Grant Execute on dbms_xa to <owner>;

The App Schema and all accessible schemas that appear in the required alias of installed configurations are granted the following privileges (granted by someone with System Database Administrator Privileges):

You need SYSDBA Privileges to Run the last four grants.

- Grant Create Session to <app>;
- Grant Select on pending_trans\$ to <app>;
- Grant Select on dba_2pc_pending to <app>;
- Grant Select on dba_pending_transactions to <app>;
- Grant Execute on dbms_xa to <app>;

Schema or Login examples

Following are examples of DDL (Owner) and DML (App) Schemas or logins for OFS AgileREPORTER in Oracle and SQL Server, with user-definable items shown in **bold**:

- **Oracle** Schema Owner
- CREATE USER **RP\$OWNER** IDENTIFIED BY **password**
- DEFAULT TABLESPACE users
- TEMPORARY TABLESPACE temp
- QUOTA UNLIMITED ON users;
- Grant Create Session to **RP\$OWNER**;
- Grant Create Trigger to **RP\$OWNER**;
- Grant Create Table to **RP\$OWNER**;
- Grant Create Sequence to **RP\$OWNER**;
- Grant Create View to **RP\$OWNER**;
- Grant Select on pending_trans\$ to **RP\$OWNER**;
- Grant Select on dba_2pc_pending to **RP\$OWNER**;
- Grant Select on dba_pending_transactions to **RP\$OWNER**;

- Grant Execute on `dbms_xa` to **RP\$OWNER**;

Application User

- CREATE USER **RP\$APP** IDENTIFIED BY **password**
- DEFAULT TABLESPACE `users`
- TEMPORARY TABLESPACE `temp`
- QUOTA UNLIMITED ON `users`;
- Grant Create Session to **RP\$APP**;
- Grant Select on `pending_trans$` to **RP\$APP**;
- Grant Select on `dba_2pc_pending` to **RP\$APP**;
- Grant Select on `dba_pending_transactions` to **RP\$APP**;
- Grant Execute on `dbms_xa` to **RP\$APP**;

Create and grant Object Privilege Role to the Application User to access the table of the Schema Owner

- CREATE ROLE **RP\$RW_ROLE**;
- CREATE ROLE **RP\$R_ROLE**;
- grant **RP\$RW_ROLE** to **RP\$APP**;

3.1.4 Other Requirements

The other requirements for this release are as follows:

- Shut down any OFS AgileREPORTER Web Server currently running on the Target Server.
- Ensure that there is a free service port for the OFS AgileREPORTER Web Server (default 8080) and a free service port for ActiveMQ (default 61616). If either default port is already being used by another application, find an alternative free port.
- To use Oracle functionality that fulfills General Data Protection Regulation (GDPR) requirements, set the `db.Redacted Property` equal to `True` in the `aliasinfo.properties` file.

For example:

```
config.sh -ea OFSAA_DW_DT -iv 1.11.0.1 -alias "OFSAA DS" -aif
aliasinfo.properties
```

From version 1.15.5, a new property is added related to encrypted passwords. If encrypted passwords are used in the properties file, the `password.encrypted` property in the alias properties file must be uncommented and its value set to `True`.

3.2 Obtaining the Software

This release of OFS AgileREPORTER Applications Pack 8.1.2.6.0 can be downloaded from [My Oracle Support](#) website. Log in and search for **37012162** under **Patches and Updates** and download the `p37012162_81200_Linux-x86-64.zip` archive file.

You need to have a valid Oracle Account in order to download the software.

3.3 Common Installation Activities

You must carry out the common pre-installation activities before installing the OFS AgileREPORTER Application.

Topics:

- [Identifying the Installation Directory](#)
- [Copying and Extracting the Software](#)

3.3.1 Identifying the Installation Directory

For installing any OFS AgileREPORTER Applications, the following directory can be created.

- **OFS AgileREPORTER Download Directory (Optional):** Create a Download Directory and copy the OFS AgileREPORTER Application Installer File (Archive). You can copy the downloaded installer or patches in this directory.

NOTE Ensure the user permission is set to 755 on the Installation and Download Directory.

3.3.2 Copying and Extracting the Software

After you obtain the installer, copy the installer (in BINARY Mode) to the system on which the OFS AgileREPORTER Applications Components are installed.

NOTE You must be logged in to the UNIX Operating System as a Non-Root User.

1. Download the unzip utility (OS-specific) `unzip_<os>.Z`, and copy it in Binary Mode to any directory, and include the directory in your PATH variable. If you already have the unzip utility to extract the contents of the downloaded archive, skip to the next step.
2. Uncompress the unzip installer file using the command:

```
uncompress unzip_<os>.Z
```

NOTE If you notice an error message "*uncompress: not found [No such file or directory]*" when the package is not installed, contact your UNIX Administrator.

3. Give EXECUTE permission to the file using the command:

```
chmod 751 unzip_<os>
```

For example, `chmod 751 unzip_sparc`

4. Extract the contents of the OFS AgileREPORTER Application 8.1.2.6.0 to the downloaded directory using the following command:

```
unzip p37012162_81200_Linux-x86-64.zip
```

NOTE **DO NOT** rename the Application Pack Installer Folder name on extraction from the archive.

5. Give the following permission to the Installer Folder. Navigate to the downloaded directory and execute the command:

```
chmod -R 755 OFS_AGILE_REPORTER
```

4 Installing the OFS AgileREPORTER Applications Pack

Follow the instructions in this chapter to install the OFS AgileREPORTER Applications Pack depending on the mode of installation.

4.1 Running the OFS AgileREPORTER Applications Pack Installer

OFS AgileREPORTER Applications Pack Installation supports the following modes of installation:

- [Upgrades from Prior Versions of OFSAA AgileREPORTER](#)
- [Running the Installer in GUI Mode](#)
- [Running the Installer in GUI Mode for Upgrade](#)
- [Running the Installer in SILENT Mode](#)
- [Running the Installer in SILENT Mode for Upgrade](#)
- [Verifying the Log File](#)

4.1.1 Upgrades from Prior Versions of OFSAA AgileREPORTER

If you are using older versions of OFSAA AgileReporter, see the following table on the supported AR Upgrade Path to upgrade from an older version to the latest version of AgileREPORTER.

Table 2: Supported OFSAA AgileREPORTER Upgrade Versions

Upgrade to and Upgrade from	8.0.6.1.0	8.0.7.3.0	8.0.7.4.0	8.0.8.0.0	8.0.8.1.0	8.0.9.0.0	8.0.9.6.5	8.1.0.0.0	8.1.0.0.1	8.1.0.0.2	8.1.1.0.0	8.1.2.0.0	8.1.2.1.0	8.1.2.2.0	8.1.2.3.0	8.1.2.4.0	8.1.2.5.0	8.1.2.6.0
8.0.6.1.0	Yes	Yes	Yes	Yes	Yes	Yes	Yes	No	No	No	No	No	No	No	No	No	No	No
8.0.7.3.0		Yes	Yes	Yes	Yes	Yes	Yes	No	No	No	No	No	No	No	No	No	No	No
8.0.7.4.0			Yes	Yes	Yes	Yes	Yes	Yes	Yes	Yes	Yes	Yes	Yes	Yes	Yes	Yes	Yes	Yes
8.0.8.0.0				Yes	Yes	Yes	Yes	Yes	Yes	Yes	Yes	Yes	Yes	Yes	Yes	Yes	Yes	Yes
8.0.8.1.0					Yes	Yes	Yes	Yes	Yes	Yes	Yes	Yes	Yes	Yes	Yes	Yes	Yes	Yes
8.0.9.0.0						Yes	Yes	Yes	Yes	Yes	Yes	Yes	Yes	Yes	Yes	Yes	Yes	Yes
8.0.9.6.5							Yes	No	Yes	Yes	Yes	Yes	Yes	Yes	Yes	Yes	Yes	Yes

INSTALLING THE OFS AGILEREPORTER APPLICATIONS PACK
 RUNNING THE OFS AGILEREPORTER APPLICATIONS PACK INSTALLER

Upgrade to and Upgrade from	8.0.6.1.0	8.0.7.3.0	8.0.7.4.0	8.0.8.0.0	8.0.8.1.0	8.0.9.0.0	8.0.9.6.5	8.1.0.0.0	8.1.0.0.1	8.1.0.0.2	8.1.1.0.0	8.1.2.0.0	8.1.2.1.0	8.1.2.2.0	8.1.2.3.0	8.1.2.4.0	8.1.2.5.0	8.1.2.6.0
8.1.0.0.0								Yes	Yes	Yes	Yes	Yes	Yes	Yes	Yes	Yes	Yes	Yes
8.1.0.0.1									Yes	Yes	Yes	Yes	Yes	Yes	Yes	Yes	Yes	Yes
8.1.0.0.2										Yes	Yes	Yes	Yes	Yes	Yes	Yes	Yes	Yes
8.1.1.0.0											Yes	Yes	Yes	Yes	Yes	Yes	Yes	Yes
8.1.2.0.0												Yes	Yes	Yes	Yes	Yes	Yes	Yes
8.1.2.1.0													Yes	Yes	Yes	Yes	Yes	Yes
8.1.2.2.0														Yes	Yes	Yes	Yes	Yes
8.1.2.3.0															Yes	Yes	Yes	Yes
8.1.2.4.0																Yes	Yes	Yes
8.1.2.5.0																	Yes	Yes

4.1.2 Running the Installer in GUI Mode

Before proceeding, ensure that all preinstallation requirements listed in [Chapter 3 - Preparing for Installation](#) are met.

ATTENTION In the previous release of AgileREPORTER (20.3), the Log4j Library was replaced with the Logback Library in the application. From this release onwards, since the application includes ZooKeeper which also uses Log4j, all the instances of Log4j is automatically removed from Zookeeper.

NOTE The following screenshots are taken from a Windows System; however, they look similar in Linux Configuration for GUI Mode Installation.

To install this product in GUI Mode, ensure the following software and configuration are available:

- Install and configure any PC X Server Software such as Open Text Exceed (formerly Hummingbird Exceed) on the Desktop System of the user from which the installation is triggered.
- Configure the DISPLAY variable.
- Ensure you set the DISPLAY variable (in user. profile) on the system on which the OFSAA Infrastructure is installed, to point to the Desktop System of the user where the PC X Server Software is installed.

Syntax:

```
export DISPLAY = hostname:n
```

where the **hostname** is the IP Address or Hostname of the User's Desktop System and **n** is the sequence number (usually 0).

For example: 10.XXX.XXX.XXX:0000 or myhostname:0

To install OFS AgileREPORTER using the installer GUI, follow these steps (click **Next** to advance after each step):

1. Navigate to the path where the OFS AgileREPORTER Installer Kit is unzipped.
2. Navigate to the OFS_AGILE_REPORTER/AgileREPORTER/Bin Directory.
3. Execute the `./Setup.sh` GUI command in the Console.
The initial Splash Screen is displayed.

Figure 2: Initial Splash Screen

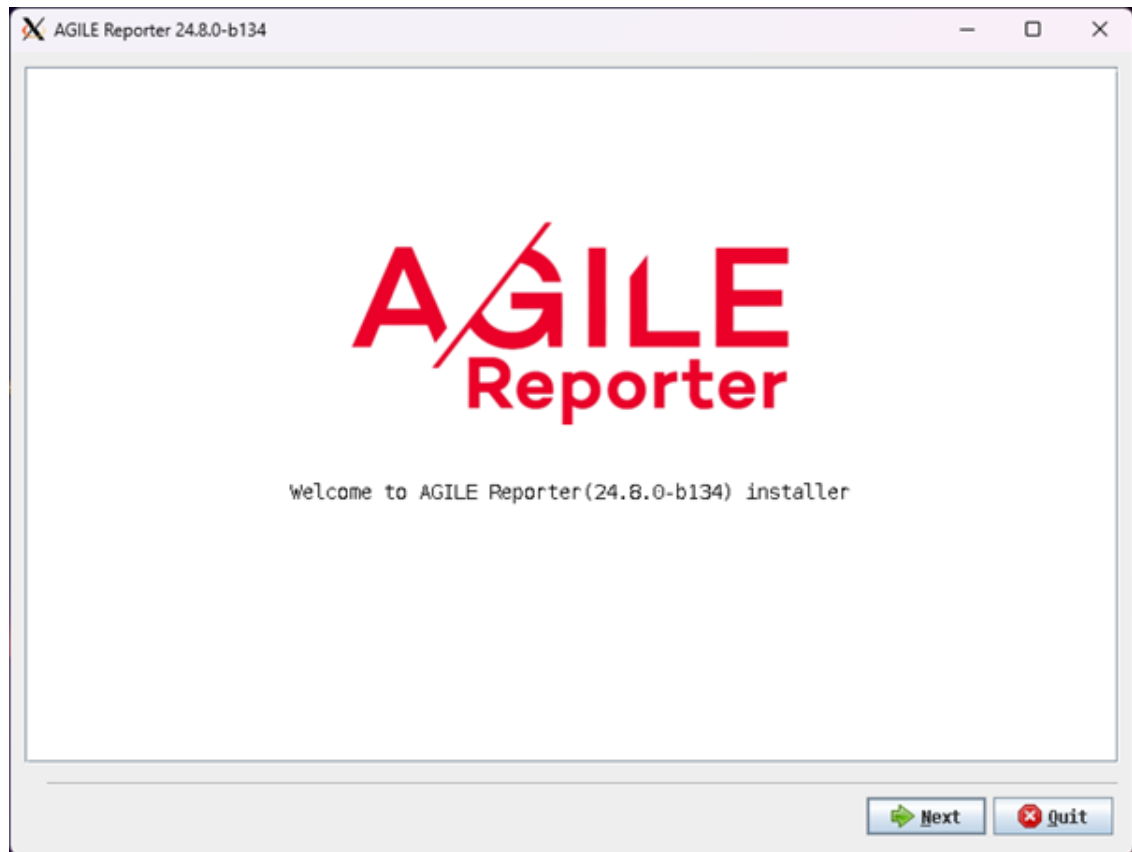

4. Select **Next** to continue the installation.
5. Select the location where OFS AgileREPORTER must be installed.

Figure 3: General Settings Screen

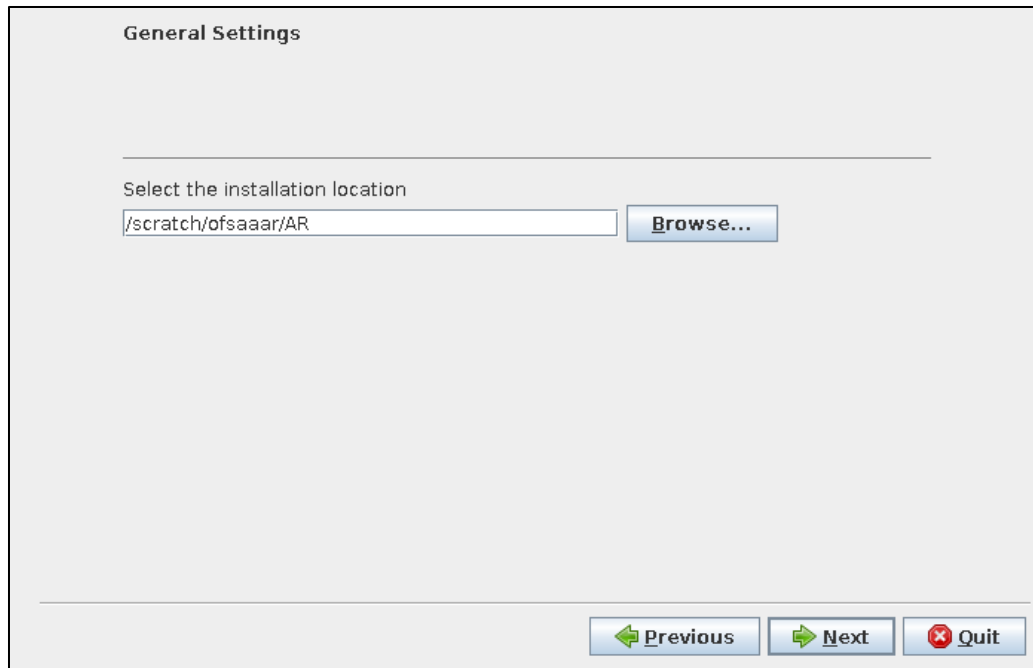

The screenshot shows a window titled "General Settings". Below the title bar, there is a horizontal line. Underneath, the text "Select the installation location" is displayed. A text input field contains the path "/scratch/ofsaar/AR". To the right of this field is a "Browse..." button. At the bottom of the window, there are three buttons: "Previous" with a left-pointing arrow, "Next" with a right-pointing arrow, and "Quit" with a red 'X' icon.

The installer checks for the OFSAA Database when the database details are entered.

Figure 4: Check OFSAA Database Screen

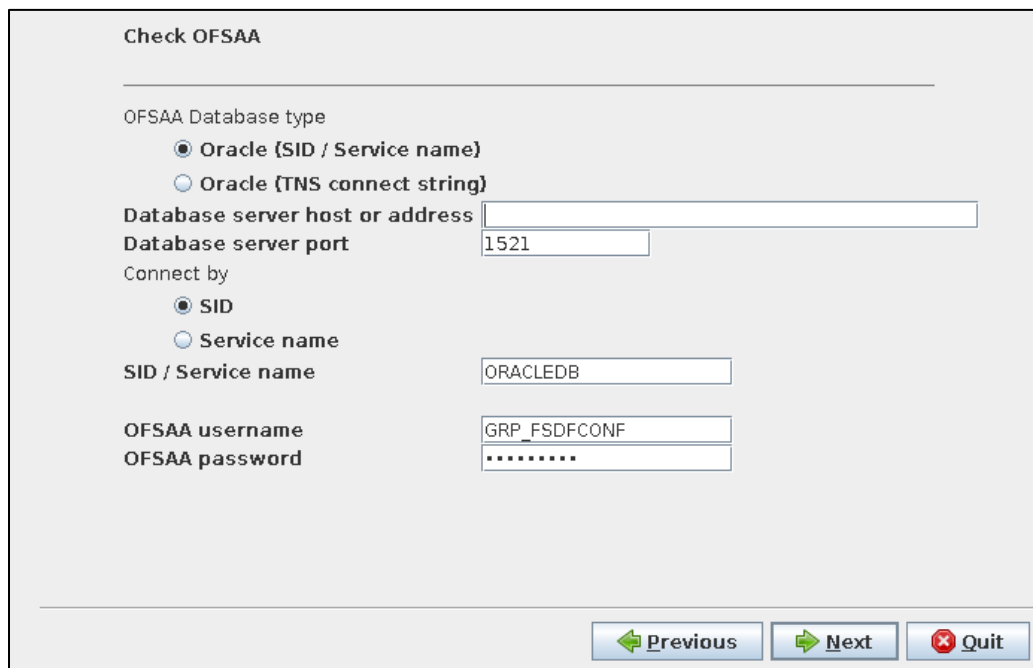

The screenshot shows a window titled "Check OFSAA". Below the title bar, there is a horizontal line. The text "OFSAA Database type" is followed by two radio button options: "Oracle (SID / Service name)" (which is selected) and "Oracle (TNS connect string)". Below these are three input fields: "Database server host or address" (empty), "Database server port" (containing "1521"), and "Connect by" (containing "SID"). Under "Connect by", there are two radio button options: "SID" (selected) and "Service name". Below these are two more input fields: "SID / Service name" (containing "ORACLEDB") and "OFSAA username" (containing "GRP_FSDFCNF"). The "OFSAA password" field is masked with "*****". At the bottom of the window, there are three buttons: "Previous" with a left-pointing arrow, "Next" with a right-pointing arrow, and "Quit" with a red 'X' icon.

NOTE If Oracle FSDFC is unavailable, the following message is displayed.

Figure 5: Validation Screen

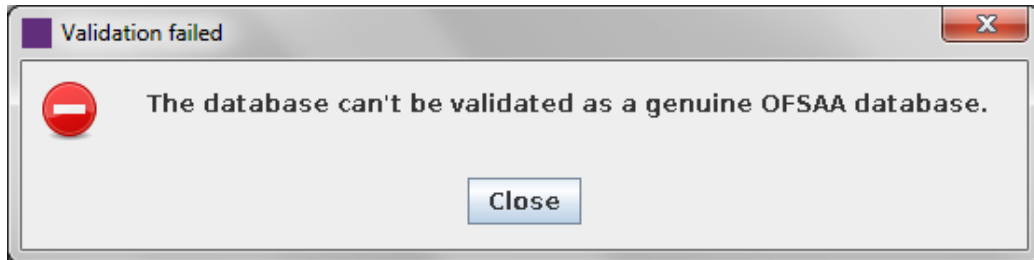

If Oracle FSDf is available, the following screens continue as part of the installation.

6. Select the JBOSS Options as applicable.

Figure 6: JBoss Options Screen



7. Select the Installation Mode as applicable.

Figure 7: Install Mode Screen



The screenshot shows a window titled "Install mode". Below the title bar, there is a horizontal line. Underneath, the text "AgileREPORTER Installation Mode" is displayed. Two radio button options are listed: "Default (Recommend)" which is selected, and "Customized". At the bottom right of the window, there are three buttons: "Previous" with a left arrow, "Next" with a right arrow, and "Quit" with a red X icon.

8. Select the Network Settings as applicable.
To enable HTTPS for AgileREPORTER see the *Enable HTTPS for AgileREPORTER* Section in the [AgileREPORTER 20.4 - Installation and Administration Guide.zip](#).

Figure 8: Network Settings Screen

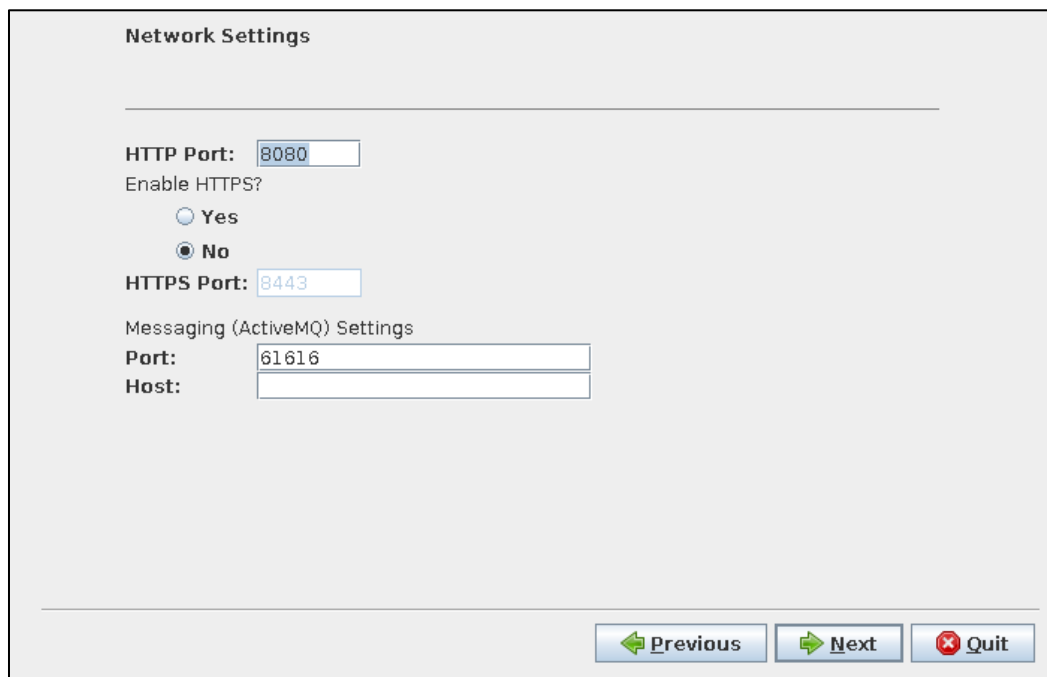

The screenshot shows a window titled "Network Settings". Below the title bar, there is a horizontal line. The "HTTP Port:" is set to "8080". Below this, the question "Enable HTTPS?" is followed by two radio button options: "Yes" and "No", with "No" selected. The "HTTPS Port:" is set to "8443". Under the heading "Messaging (ActiveMQ) Settings", there are two input fields: "Port:" with the value "61616" and "Host:" which is currently empty. At the bottom right of the window, there are three buttons: "Previous" with a left arrow, "Next" with a right arrow, and "Quit" with a red X icon.

9. Provide the MQ Authentication details.

Figure 9: ActiveMQ Authentication Screen

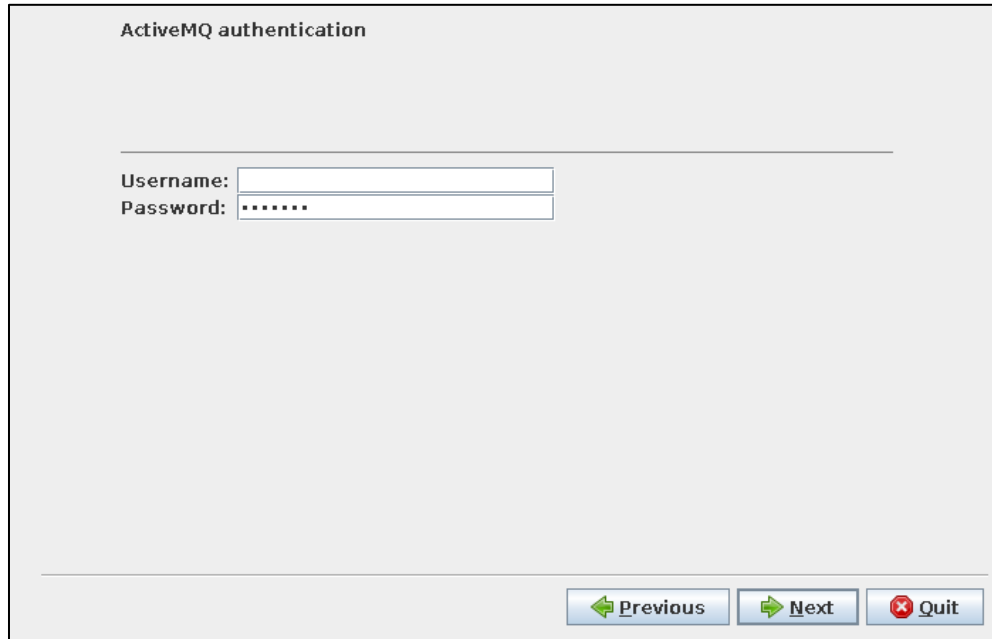

The screenshot shows a window titled "ActiveMQ authentication". It contains two input fields: "Username:" and "Password:". The "Password:" field is masked with seven dots. At the bottom right, there are three buttons: "Previous" (with a left arrow), "Next" (with a right arrow), and "Quit" (with a red X).

10. Select **Enable return workflow** to enable approval workflow for changes made to returns and set how many approvers are required per change.

Figure 10: Enable or Disable return workflow Screen

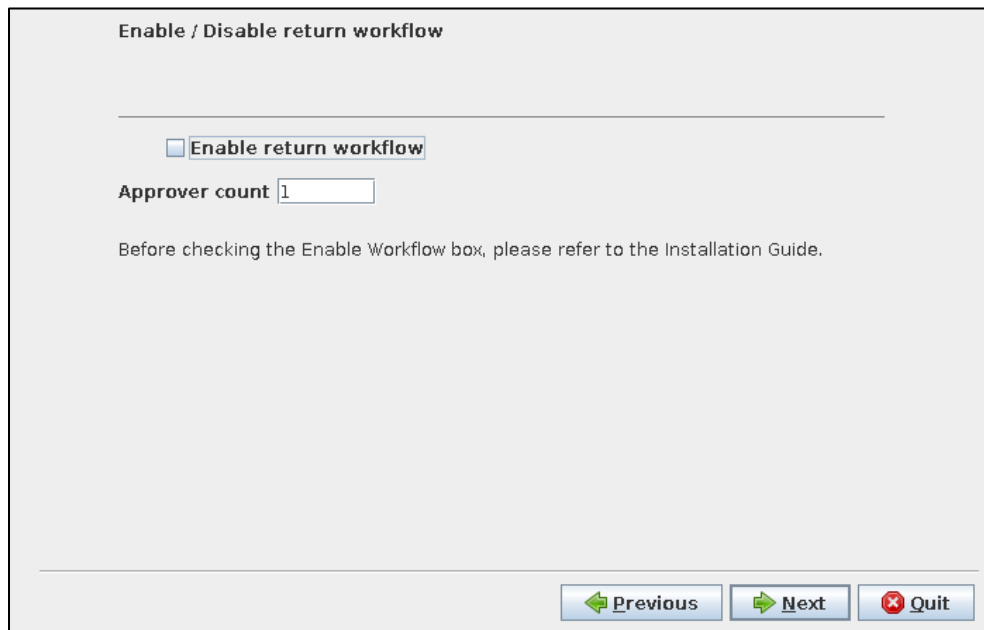

The screenshot shows a window titled "Enable / Disable return workflow". It features a checkbox labeled "Enable return workflow" which is currently unchecked. Below the checkbox is an input field for "Approver count" with the value "1". A note at the bottom of the main area reads: "Before checking the Enable Workflow box, please refer to the Installation Guide." At the bottom right, there are three buttons: "Previous" (with a left arrow), "Next" (with a right arrow), and "Quit" (with a red X).

NOTE The following screenshots are taken from a Windows System but will look similar in Linux Configuration for GUI Mode Installation.

If your installation of OFS AgileREPORTER is connected to the REPORTER Module, OFS AgileREPORTER uses approval workflow settings from there instead of showing you this step.

You may require a new license to enable the approval workflow feature; contact VERMEG.

11. Select how AgileREPORTER Users must be authenticated when logging in.

Figure 11: User Authentication Screen

User Authentication

AgileREPORTER User Access type

AgileREPORTER

Single Sign On

LDAP Only

Mixed - LDAP and AgileREPORTER

Users and passwords are stored in AgileREPORTER database.

Session Timeout

Value (in minutes):

NOTE

- **Single Sign-On:** Users are managed in the AgileREPORTER database, but passwords can be optional in AgileREPORTER. An SSO Server is used to provide user authentication.
- **LDAP Only:** Users are managed in the AgileREPORTER Database, but passwords can be optional in AgileREPORTER. An LDAP Server is used to provide user authentication.
- **Session Timeout:** Users' sessions will time out after a period of inactivity. Set the Timeout Value (allowed period of inactivity) in minutes. If no value is specified, AgileREPORTER will default to 15 minutes.

12. If you select **Single Sign-On**, enter values for **Identity Provider URL** and **Service Provider URL**.

Figure 12: Enable Single Sign-On Screen

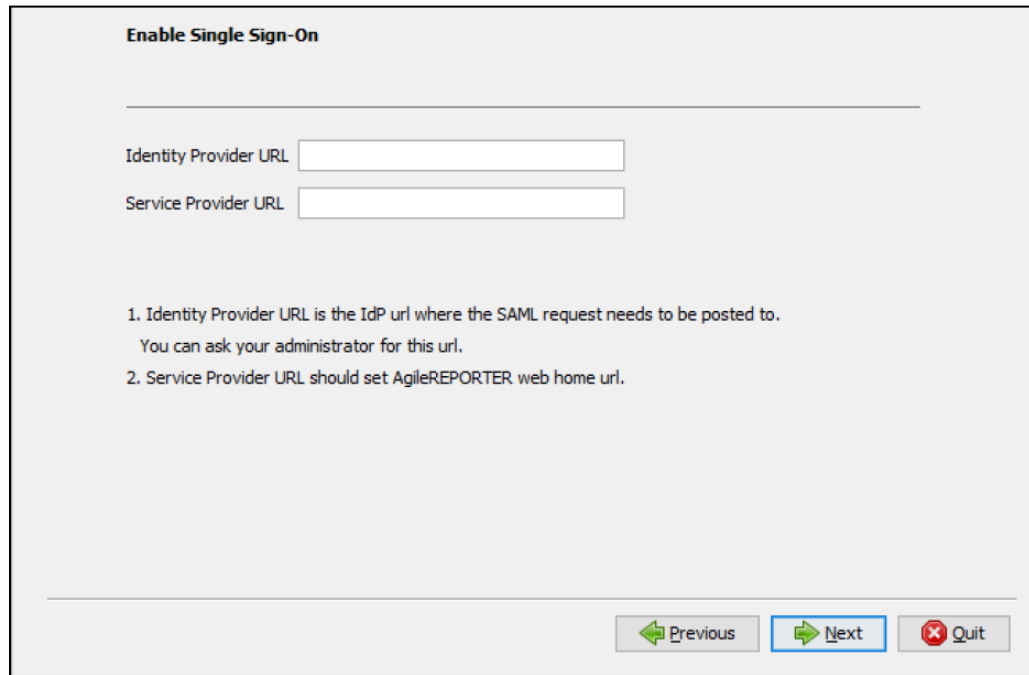

Enable Single Sign-On

Identity Provider URL

Service Provider URL

1. Identity Provider URL is the IdP url where the SAML request needs to be posted to.
You can ask your administrator for this url.
2. Service Provider URL should set AgileREPORTER web home url.

Identity Provider URL: Where Ofs AgileREPORTER sends SSO requests. For example, to an Identity Provider set up within your infrastructure.

Service Provider URL: Must be `http(s)://<hostname>:<port>/agilereporter/` (the Ofs AgileREPORTER URL).

NOTE

OFS AgileREPORTER supports **Single Sign-On** by using the SAML v2 protocol. If you have the SAML v2 compatible Identity Provider in your IT infrastructure already, the Identity Provider can be used to authenticate users of OFS AgileREPORTER.

One possible usage of this functionality is that OFS AgileREPORTER, OBIEE, and OFSAA Web Share **Single Sign-On** using SAML v2 implemented by Oracle Identity Federation. This requires that OFS AgileREPORTER as a SAML Service Provider (SP) is configured with the details of Oracle Identity Federation as a SAML v2 Identity Provider (IdP).

The OFSAA Results Area Database Credentials are added post-installation using OFS AgileREPORTER's Configuration Manager.

For accurate SSO usage in OFS AgileREPORTER, ensure the following:

- Time on the Identity Provider Server and the OFS AgileREPORTER Server is synchronized.
- The identity provider uses a plain text Username in the SAML assertion sent to OFS AgileREPORTER when attempting a user login.
- The same Username exists in OFS AgileREPORTER.
- The Identity Provider includes the role LRM_RP_USER in the SAML assertion sent to OFS AgileREPORTER when attempting a user login.

13. Enter the database connection information and credentials for the OFS AgileREPORTER Schemas with DDL (at installation) or DML (at Application Runtime).

NOTE

Credentials must match those defined in the schemas referenced in the [Supported Databases](#) Section.

Select **Oracle (SID / Service name)**. Full SQL Server Support will be supplied in a later version.

Figure 13: AgileREPORTER Database Configuration Screen

AgileREPORTER Database Configuration

AgileREPORTER Database type

- Oracle {SID / Service name}
- Oracle {TNS connect string}
- SQL Server {SQL Server authentication}
- SQL Server {Windows / Domain authentication}

Oracle (SID / Service Name)

Figure 14: AgileREPORTER Database Configuration Oracle (SID / Service name) Screen

AgileREPORTER Database Configuration

Database server host or address

Database server port

Connect by

- SID
- Service name

SID / Service name

AgileREPORTER owner username

AgileREPORTER owner password

AgileREPORTER application username

AgileREPORTER application password

AgileREPORTER database rolename

Oracle (TNS connect string)

Figure 15: AgileREPORTER Database Configuration Oracle (TNS connect string) Screen

AgileREPORTER Database Configuration

Oracle TNS connect string

AgileREPORTER owner username

AgileREPORTER owner password

AgileREPORTER application username

AgileREPORTER application password

Does this installation require Microsoft SQL Server database support for your data source?

NOTE

For domain single sign-on, enter the **OFS AgileREPORTER system domain** field, but leave the **Domain username** and **Domain password** fields blank.

For domain authentication, enter **OFS AgileREPORTER system domain**, **Domain username**, and **Domain password**.

14. Set up the initial **AgileREPORTER Administration User Account**.

NOTE

This step only appears during a fresh installation of OFS AgileREPORTER.

Figure 16: Create AgileREPORTER Administration User Screen

Create AgileREPORTER administration user

Username

Password:

Confirm password:

If the **Single Sign-On** is enabled, the **Username** must be a valid user in the Identity Provider and the password can be left blank. This user is created as an administrative user in OFS AgileREPORTER.

15. Select **Yes** for **Always validate database connection** to check if there is a firewall between the Application Server and Database Server.

Figure 17: Enable Check Database Valid Connection Screen

Enable Check Database Valid Connection

Tick on the radio box yes selected below, if there is a firewall between the application server and the database server.

If the radio box yes is selected the installer will add connection validation for all datasources.

Always validate database connection.

Yes

No

← Previous Next → × Quit

16. Enter the Java minimum and maximum heap sizes.

Figure 18: AgileREPORTER Java Settings Screen

AgileREPORTER Java Settings

Initial heap size (MB) 2048

Maximum heap size (MB) 4096

← Previous Next → × Quit

17. Select the shortcut settings, if required.

Figure 19: Shortcut Settings Screen

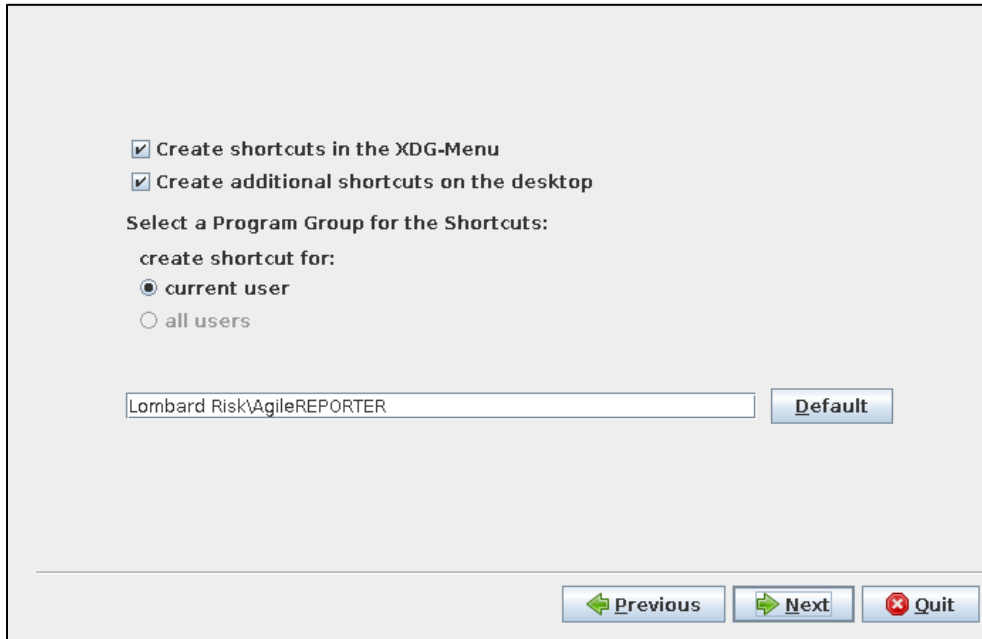

18. Select **Create UNIX Service** to create a UNIX Service on the server where OFS AgileREPORTER is running.

Enter the **starter user account name**, which is the Linux Operating System Account that starts the service.

Figure 20: Unix Settings Screen

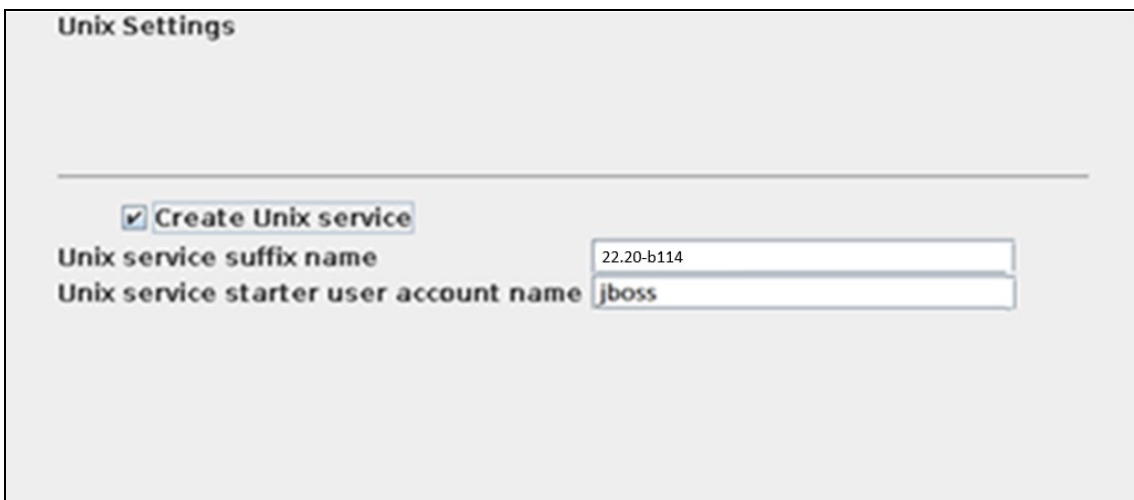

19. Wait for unpacking and installation to complete.

Figure 21: Installation progress Screen

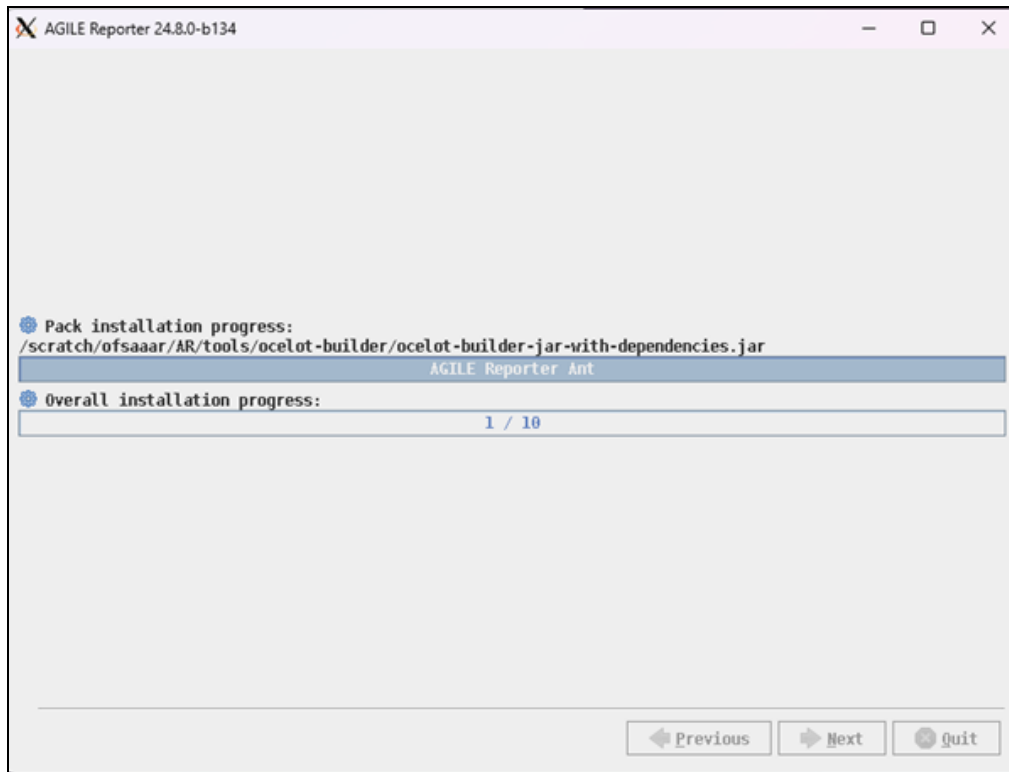

20. Select **Start AgileREPORTER now** (to open immediately) and click **Next**.

Figure 22: Start AgileREPORTER Now Screen

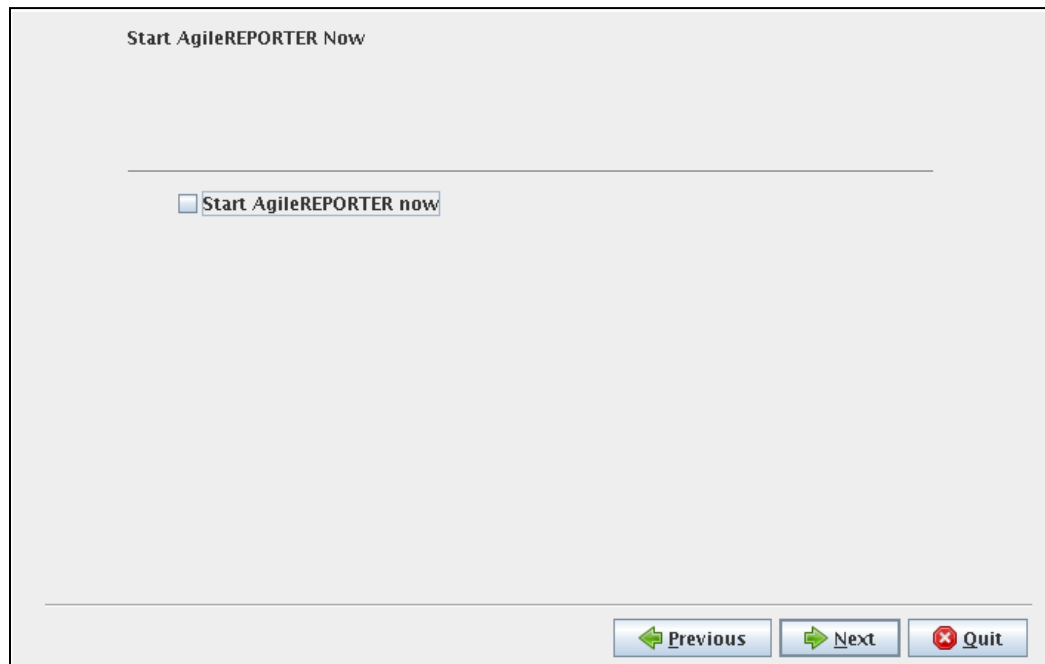

21. Click **Done** to finish the installation process.

Figure 23: Installation success Screen

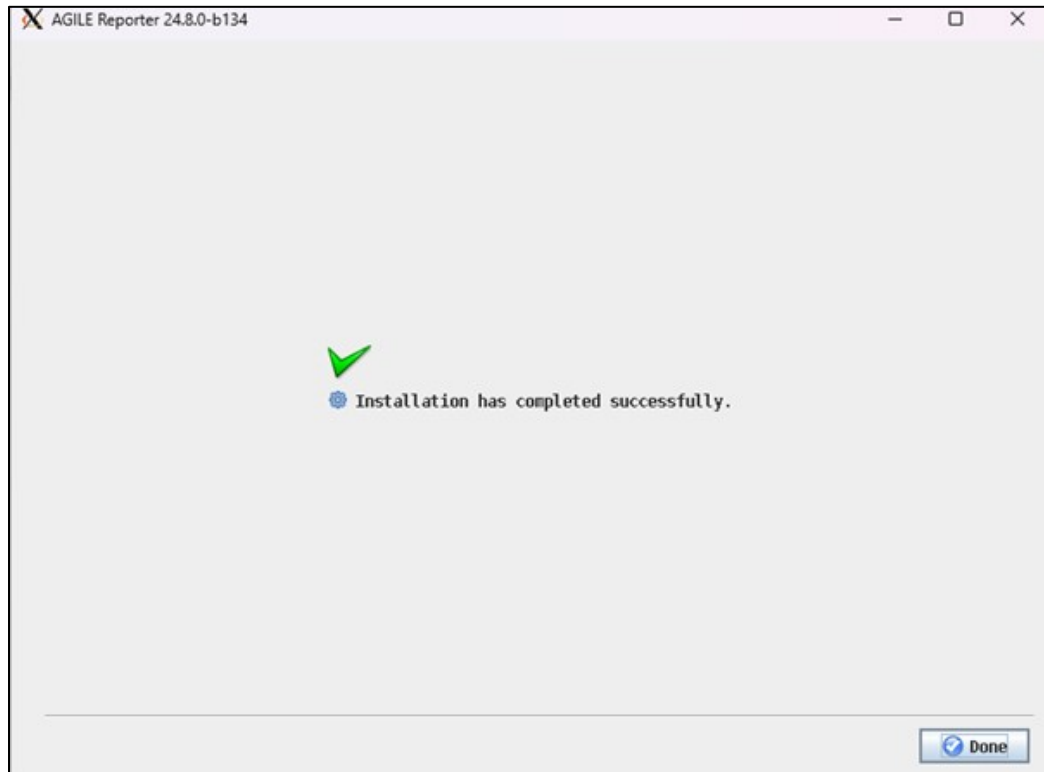

NOTE If required, the DDL Schema or login can be locked after successfully installing the OFS AgileREPORTER.

You can now try opening OFS AgileREPORTER in a Web Browser. For example, open Internet Explorer and enter `http(s) ://<server>:<port>` or `http(s) ://<server>:<port>/agilereporter`, specifying the chosen http Protocol, Server Address and Port.

Figure 24: AgileREPORTER Dashboard

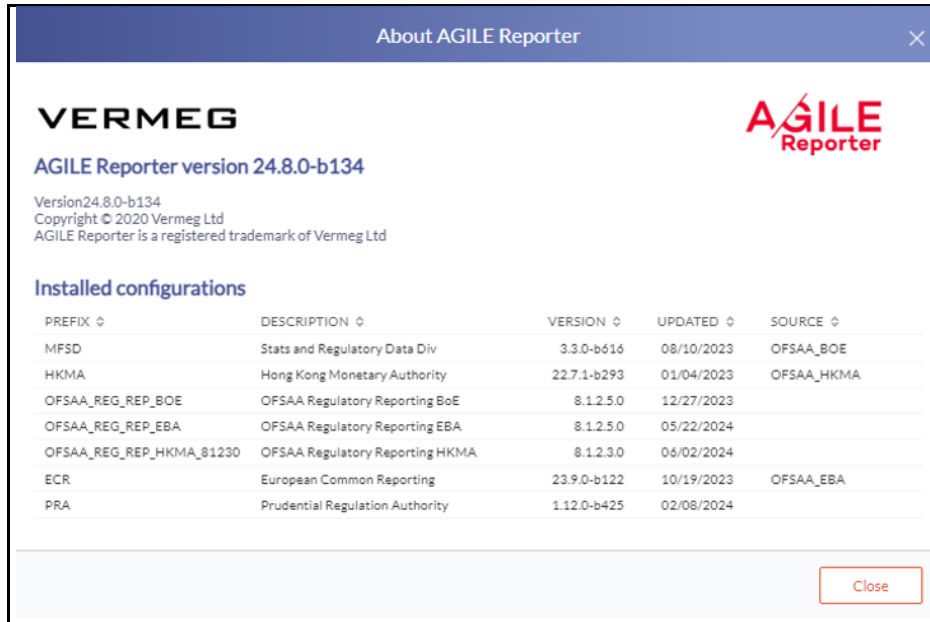

4.1.3 Running the Installer in GUI Mode for Upgrade

To upgrade OFS AgileREPORTER using the installer in GUI Mode, follow these steps (click **Next** after each step to continue):

1. Repeat the steps in section [4.1.2 Running the Installer in GUI Mode](#) till you specify the installation path.
2. Specify the installation path and click **Next**.
3. The subsequent GUI Screens get auto populated with the existing information. You must click **Next** to continue and complete the installation.

NOTE

After upgrading from a previous version of AgileREPORTER, any manual changes made to the AgileREPORTER configuration in the previous version must be reapplied to the configuration in the upgraded installation. For example, changes made to the `standalone.xml` file in the previous version will be overwritten when upgrading.

4.1.4 Running the Installer in SILENT Mode

NOTE

Before proceeding, ensure that all pre-installation requirements listed in [Chapter 3 – Preparing for Installation](#) are met. An additional parameter **Session Timeout** has been introduced in the AgileREPORTER 20.4 release. For more information, see [Table 4: Configuration Properties for Silent.props File](#)

Rename the `Silent.template` to `Silent.props` from the `OFS_AGILE_REPORTER/AgileREPORTER/conf` directory and then fill the `Silent.props` file from the `OFS_AGILE_REPORTER/AgileREPORTER/conf` directory before starting the installation.

The following table describes the installation properties that you must enter in the `Silent.props` Java Properties file. This file uses a standardized format consisting of a key followed by an equal to sign (=), followed by a value on each line.

The following characters must be appended with a backslash (\) for the Escaped version when used in keys and values.

Table 3: Installation properties for Silent.props File

Character Name	Character Symbol	Escaped Version
Equals	=	\=
Colon	:	\:
Backslash	\	\\

For example:

`\:\=\\\bin\\temp` when un-escaped translates to `:=\bin\temp`

For more information, see [http://docs.oracle.com/javase/6/docs/api/java/util/Properties.html#load\(java.io.Reader\)](http://docs.oracle.com/javase/6/docs/api/java/util/Properties.html#load(java.io.Reader)) or contact VERMEG support.

The configurable properties with a grey background are not shown in the OFS AgileREPORTER Installer user interface. Do not alter these unless instructed to do so by VERMEG Support.

NOTE

AgileREPORTER security is improved constantly. Earlier, the Blowfish Algorithm with a hard-coded secret key was used to encrypt the passwords saved in the `ocelot.properties` file. Now, the Blowfish Algorithm is deemed as weak encryption and therefore, AgileREPORTER uses AES (Advanced Encryption Standard) Algorithm for encryption.

Consequently, the Encoding Tool that encrypts a given password using the AES Algorithm has been updated and is delivered with AgileREPORTER.

If the password is encrypted in the properties file, the `ocelot.secret.key` property must be added to the `Silent.props` file to specify the secret key used to encrypt the password.

For upgrading an existing AR, use the existing `ocelot.properties` file and the installer will automatically generate a secret key for you.

For a new AgileREPORTER, use the `ocelot-encoding` tool to generate a secret key, then use this secret key to encrypt all passwords in the `Silent.props` file before you can use it to install AgileREPORTER.

To encrypt the password using an existing secret key, see [AppendixA-EncodingTool](#) Section in [AgileREPORTER Installation Guide 22.1.pdf](#).

All passwords mentioned in the `Silent.props` properties file must be encrypted. Execute the following command to encrypt all passwords using the password encryption utility `ocelot-encoding-1.4150.0.jar` under the `/utility` folder:

To generate a secret key:

```
java -jar ocelot-encoding-1.4150.0.jar -gk
```

To encrypt with an existing secret key:

```
java -jar ocelot-encoding-1.4150.0.jar -en  
<PASSWORD> -k <SECRET KEY>
```

To encrypt with a random secret key:

```
java -jar ocelot-encoding-1.4150.0.jar -en  
"password"
```

Table 4: Configuration Properties for Silent.props File

Property Name	Description of Property	Permissible Values	Comments
<code>ocelot.install.path</code>	AgileREPORTER Home Directory Install Path	Not applicable	For example: /scratch/ofsaapp/reporter_portal
<code>singleLoginModel</code>	Single Login Model	True False	The default value is False. NOTE: Enter True if you want to restrict to one user per session.

Property Name	Description of Property	Permissible Values	Comments
main.host.name	Current machine's IP address or hostname	Not Applicable	For example: 10.XXX.XXX.XXX
activemq.port	AgileREPORTER jBoss AMQ Port	Not Applicable	For example: 61616.
agile.reporter.web.app	AgileREPORTER Web Application	True False	The default value is True.
host.port	AgileREPORTER Web Host Port	Not Applicable	For example: 8091.
httpsMode	HTTPS/SSL Required or Not	True False	The default value is False. The value should be True only if HTTP is false. (Optional. Required only when HTTPS is used).
host.port.https	HTTPS Port	Not Applicable	(Optional. Required only when HTTPS is used). Default value: host.port.https = 0000
did.retrieve.job	DID Retrieve Job activation	True False	The default value is True.
data.schedule.export.job	Data Schedule Export Job activation	True False	The default value is True.
other.brokers	Other ActiveMQ Broker activation	True False	The default value is False.
other.brokers.hosts	Other ActiveMQ Broker Host Name and Port	Not Applicable	For example: 10.XXX.XXX.XXX:0000
ocelot.database.type	Ocelot Database Type	Oracle	The default value is Oracle.
ocelot.jdbc.url	Ocelot JDBC URL	For SID: jdbc:oracle:thin:@IPADDRESS:PORT:SID For Service Name: jdbc:oracle:thin:@//IPADDRESS:PORT/SERVICE_NAME	For example: jdbc:oracle:thin:@10.XXX.XXX.XXX:0000:AGILERP jdbc:oracle:thin:@//10.XXX.XXX.XXX:0000/SERVICE_NAME
ocelot.jdbc.username	RP OWNER Schema User Name	Not Applicable	For example: AGILE_RPOWNER
ocelot.jdbc.password	RP OWNER Schema Password	Not Applicable	For example: 5dfc52b51bd355539bd9a0b76da9b8e7
ocelot.database.role.name	RP Read/Write Role Name	Not Applicable	For example: AGILE_RPRW_ROLE
ocelot.app.jdbc.user.name	RP Application Schema User Name	Not Applicable	For example: AGILE_RPAPP

Property Name	Description of Property	Permissible Values	Comments
ocelot.app.jdbc.password	RP Application Schema Password	Not Applicable	For example: 5dfc52b51bd355539bd9a0b76da9b8e7
check.db.valid.connection.enable	Database Connection Validation activation	True False	Default value: False
ocelot.user.name	AgileREPORTER User Interface Login User Name	Not Applicable	For example: RP Admin
ocelot.user.password	AgileREPORTER User Interface Login Password	Not Applicable	For example: 5dfc52b51bd355539bd9a0b76da9b8e7
ocelot.user.authentication.mode	Agile Reporter User Interface Login Mode	SYSTEM, SSO, LDAP	Default Value: SYSTEM
sso.idp.url sso.service.provider.url	Agile Reporter UI using SSO Credentials	Not Applicable	Optional. Required only if ocelot.user.authentication.mode = SSO
ldap.host ldap.port ldap.baseDN ldap.adminDN ldap.username ldap.password ldap.search.filter ldap.userdn ldap.test.username ldap.test.password	Agile Reporter UI using LDAP Login Model	Not Applicable	Optional. Required only if ocelot.user.authentication.mode = LDAP
jvm.parameters.Xms jvm.parameters.Xmx	Java Heap Memory	1024 2048	Optional. For example: jvm.parameters.Xms = 1024 jvm.parameters.Xmx = 2048
ocelot.ofsaa.server	OFSAA Config Database server address	Host Name or IP address of the database server that has FSDf installed	For example: 10.XXX.XXXX.XXX
ocelot.ofsaa.port	OFSAA Config Database server port	Database Port	For example: 1521
ocelot.ofsaa.dbType	OFSAA database type (SID / Service name, TNS)	Oracle	The default value is Oracle.
ocelot.ofsaa.connectType	OFSAA connect by SID or Service name	SID Service Oracle TNS	For example: SID Service Oracle TNS
ocelot.ofsaa.instance	OFSAA SID or Service name to connect to OFSAA CONFIG schema	SID / Service Name	For example: ORACLEDB

Property Name	Description of Property	Permissible Values	Comments
ofsaa.database.tns	OFSAA Connect string	Leave empty if SID or Service name is used. jdbc:oracle:thin:@(TNS String)	For example: jdbc:oracle:thin:@(DESCRIPTION=(ADDRESS=(PROTOCOL=TCP)(HOST=10.XXX.XXX.XXX)(PORT=1521))(CONNECT_DATA=(SERVER=DEDICATED)(SERVICE_NAME=RP_SVC)))
ocelot.ofsaa.username	OFSAA Config Schema Username	Not Applicable	For example: AGILE_RPCOWNER
ocelot.ofsaa.password	OFSAA Config Schema password	Not Applicable	For example: 5dfc52b51bd355539bd9a0b76da9b8e7
ocelot.secret.key	The secret key used to encrypt the password	Not Applicable	For example: M7zsrc2WcWyhz9a0rbkPQw== (A random secret key can be generated using the ocelot-encoding tool.)
activemq.authentication.user	AgileREPORTER admin user	Not Applicable	For example: rpadmin
activemq.authentication.password	AgileREPORTER admin password (encrypted)	Not Applicable	For example: 5dfc52b51bd355539bd9a0b76da9b8e7
ocelot.session.timeout	# HTTP session timeout (in minutes) to be defined in web.xml.	Not Applicable	For example: ocelot.session.timeout=25 Default is 15 minutes if left blank.

To install OFS AgileREPORTER using the installer in SILENT Mode, follow these steps:

1. Navigate to the path where the contents of the OFS AgileREPORTER Installer Kit have been extracted.
2. Navigate to the `OFS_AGILE_REPORTER/AgileREPORTER/conf` directory.
3. Rename the file `Silent.template` to `Silent.props` and update the file as explained in [Section 4.1.4](#)
4. Navigate to the `OFS_AGILE_REPORTER/AgileREPORTER/bin` directory in the Console.
5. Execute the `./Setup.sh SILENT` command.

If the installation fails, check the log file at the `<RP_HOME>/log/install.log` directory.

You can now try opening OFS AgileREPORTER in a Web Browser. For example, open Internet Explorer and enter `http(s)://<server>:<port>/agilereporter`, specifying the chosen HTTP Protocol, Server Address, and Port.

4.1.5 Running the Installer in SILENT Mode for Upgrade

To upgrade OFS AgileREPORTER using the installer in SILENT Mode, follow these steps:

1. Take a backup of the `ocelot.properties` file that was used for installing the earlier version of AgileREPORTER and keep it for your reference to fill the `Silent.props` file.
2. Repeat the section [4.1.4 Running the Installer in SILENT Mode](#) to upgrade AgileREPORTER.

NOTE

After upgrading from one version of AgileREPORTER to another, any manual changes made to the AgileREPORTER configuration in the previous version must be reapplied to the configuration in the upgraded installation. For example, changes made to the `standalone.xml` file in the previous version will be overwritten when upgrading.

4.1.6 Verifying the Log File

The log file `install.log` can be found in the `<RP_HOME>/log/` directory. The log files contain a detailed summary of the installation processes. It also shows the number of Fatal Errors, Errors, Debug Statements, Information, and Warnings.

5 Trial Template Package Installation

As part of the AgileREPORTER Installer, you are allowed to install Trial Template Packages for RBI and US FED.

5.1 Trial Template Package for US FED

OFS AgileREPORTER US FED Configuration Package Installation is a new application, which is used for submitting the Regulatory Reports to the regulator.

This installer contains the following three US FED Return Templates:

- FR Y-9C
- FFIEC-101
- FFIEC-031

NOTE

This is a trial pack installer, which can be used only for three returns. Contact [My Oracle Support](#) to procure the license for complete US FED Return Templates.

5.2 Trial Template Package for RBI

OFS AgileREPORTER RBI Configuration Package Installation is a new application, which is used for submitting the Regulatory Reports to the regulator Reserve Bank of India.

This installer contains the following three RBI Return Templates:

- RCA3
- IRS
- RAQ

NOTE

This is a Trial Pack Installer, which can be used only for three returns. Contact [My Oracle Support](#) to procure the license for complete RBI Return Templates.

5.3 Installing Trial Template Packages

Follow these steps to install Sample Template Packages.

1. Navigate to the `/OFS_AGILE_REPORTER/Template_Packages/conf` Directory.
2. Update the parameters in `params.conf` file present in the directory. The update instructions are present in the file itself.

Table 5: Parameters Configuration

Parameter	Description	Values
RP_HOME	Agile Reporter Home Directory Install Path.	For example: /scratch/ofsaapp/reporter_portal
PACK_ID	Pack ID of Trial Template Package you want to install. NOTE: Only one value at a time is permitted.	The list of values expected is RBI and USFED. For example: USFED

3. Navigate to the /OFS_AGILE_REPORTER/Template_Packages/ Directory and execute the command:

```
chmod 755 *
```
4. Navigate to the /OFS_AGILE_REPORTER/Template_Packages/bin Directory.
5. Execute the install.sh file using the following command:

```
./install.sh
```
6. Verify if the release is applied successfully by checking the log file generated in the Installation Directory. Logs can be found in the [Installed path]/log/install.log file.

6 Start or Stop AgileREPORTER Services

This section describes the steps to start and stop the AgileREPORTER Services.

6.1 Start AgileREPORTER Web Server

Follow these steps to start the AgileREPORTER Web Server:

1. Navigate to the path where AgileREPORTER is installed and then go to the `/bin` directory under the installed location.
2. Execute the `nohup ./start.sh > rpllog.txt &` command.

6.2 Stop AgileREPORTER Web Server

Follow these steps to stop the AgileREPORTER Web Server:

1. Navigate to the path where AgileREPORTER is installed and then go to the `/bin` directory under the installed location.
2. Execute the `./stop.sh` command.

7 Error Dictionary

This section is intended to help you resolve installation issues, if any. It provides a compilation of all the possible errors that might arise during the Installation Process with the possible cause and the resolution to quickly fix the issue and proceed further with the installation.

7.1 Accessing Error Dictionary

Rather than scrolling through the document to find the error code, you can use the PDF Search functionality. In the Find dialog available in the Adobe Acrobat Version that you are using to view the PDF Document, follow the instructions to quickly find the error resolution.

1. With the Installation Guide PDF open, press **Ctrl+F** or on the **Edit** menu click **Find**.
2. The **Find** Dialog Box is displayed.
3. Enter the **Error code** that is displayed on-screen during infrastructure installation.
4. Press **Enter**.
The search results are displayed and highlighted as follows.

Table 6: Error Code – OFSAAI-1003

Cause	JAVA_HOME/bin not found in the PATH variable.
Resolution	Import <JAVA_HOME>/bin into the PATH variable. Example: PATH=\$JAVE_HOME/bin:\$PATH export PATH

View the details of the issues, their cause, and resolution specific to the error code. Repeat the step to find an answer to any other errors that you notice during installation. If you are unable to resolve the issue with the steps provided in the resolution, you can contact [My Oracle Support](#) along with log files and appropriate screenshots.

7.2 Error Code Dictionary

Sample Error Code

Table 7: Sample Error Code

Cause	No proper arguments are available.
Resolution	Provide proper arguments. Invoke Setup.sh using either SILENT or GUI Mode. Example: ./Setup.sh SILENT or ./Setup.sh GUI

OFSAA Support

Raise a Service Request (SR) in [My Oracle Support \(MOS\)](#) for queries related to the OFSAA Applications.

Send Us Your Comments

Oracle welcomes your comments and suggestions on the quality and usefulness of this publication. Your input is an important part of the information used for revision.

- Did you find any errors?
- Is the information clearly presented?
- Do you need more information? If so, where?
- Are the examples correct? Do you need more examples?
- What features did you like most about this manual?

If you find any errors or have any other suggestions for improvement, indicate the title and part number of the documentation along with the chapter or section or page number (if available) and contact the My Oracle Support.

Before sending us your comments, you might like to ensure that you have the latest version of the document wherein any of your concerns have already been addressed. You can access the My Oracle Support site that has all the revised or recently released documents.

