

Oracle® Communications EAGLE Hardware Reference



Release 46.7
E97355 Revision 1
December 2018



Oracle Communications EAGLE Hardware Reference, Release 46.7

E97355 Revision 1

Copyright © 1993, 2018, Oracle and/or its affiliates. All rights reserved.

This software and related documentation are provided under a license agreement containing restrictions on use and disclosure and are protected by intellectual property laws. Except as expressly permitted in your license agreement or allowed by law, you may not use, copy, reproduce, translate, broadcast, modify, license, transmit, distribute, exhibit, perform, publish, or display any part, in any form, or by any means. Reverse engineering, disassembly, or decompilation of this software, unless required by law for interoperability, is prohibited.

The information contained herein is subject to change without notice and is not warranted to be error-free. If you find any errors, please report them to us in writing.

If this is software or related documentation that is delivered to the U.S. Government or anyone licensing it on behalf of the U.S. Government, then the following notice is applicable:

U.S. GOVERNMENT END USERS: Oracle programs, including any operating system, integrated software, any programs installed on the hardware, and/or documentation, delivered to U.S. Government end users are "commercial computer software" pursuant to the applicable Federal Acquisition Regulation and agency-specific supplemental regulations. As such, use, duplication, disclosure, modification, and adaptation of the programs, including any operating system, integrated software, any programs installed on the hardware, and/or documentation, shall be subject to license terms and license restrictions applicable to the programs. No other rights are granted to the U.S. Government.

This software or hardware is developed for general use in a variety of information management applications. It is not developed or intended for use in any inherently dangerous applications, including applications that may create a risk of personal injury. If you use this software or hardware in dangerous applications, then you shall be responsible to take all appropriate fail-safe, backup, redundancy, and other measures to ensure its safe use. Oracle Corporation and its affiliates disclaim any liability for any damages caused by use of this software or hardware in dangerous applications.

Oracle and Java are registered trademarks of Oracle and/or its affiliates. Other names may be trademarks of their respective owners.

Intel and Intel Xeon are trademarks or registered trademarks of Intel Corporation. All SPARC trademarks are used under license and are trademarks or registered trademarks of SPARC International, Inc. AMD, Opteron, the AMD logo, and the AMD Opteron logo are trademarks or registered trademarks of Advanced Micro Devices. UNIX is a registered trademark of The Open Group.

This software or hardware and documentation may provide access to or information about content, products, and services from third parties. Oracle Corporation and its affiliates are not responsible for and expressly disclaim all warranties of any kind with respect to third-party content, products, and services unless otherwise set forth in an applicable agreement between you and Oracle. Oracle Corporation and its affiliates will not be responsible for any loss, costs, or damages incurred due to your access to or use of third-party content, products, or services, except as set forth in an applicable agreement between you and Oracle.

This documentation is in preproduction status and is intended for demonstration and preliminary use only. It may not be specific to the hardware on which you are using the software. Oracle Corporation and its affiliates are not responsible for and expressly disclaim all warranties of any kind with respect to this documentation and will not be responsible for any loss, costs, or damages incurred due to the use of this documentation.

The information contained in this document is for informational sharing purposes only and should be considered in your capacity as a customer advisory board member or pursuant to your beta trial agreement only. It is not a commitment to deliver any material, code, or functionality, and should not be relied upon in making purchasing decisions. The development, release, and timing of any features or functionality described in this document remains at the sole discretion of Oracle.

This document in any form, software or printed matter, contains proprietary information that is the exclusive property of Oracle. Your access to and use of this confidential material is subject to the terms and conditions of your Oracle Master Agreement, Oracle License and Services Agreement, Oracle PartnerNetwork Agreement, Oracle distribution agreement, or other license agreement which has been executed by you and Oracle and with which you agree to comply. This document and information contained herein may not be disclosed, copied, reproduced, or distributed to anyone outside Oracle without prior written consent of Oracle. This document is not part of your license agreement nor can it be incorporated into any contractual agreement with Oracle or its subsidiaries or affiliates.

Contents

1 Introduction

Overview	1-1
Scope and Audience	1-1
Documentation Admonishments	1-1
Manual Organization and Conventions	1-2
My Oracle Support (MOS)	1-3
Emergency Response	1-3
Related Publications	1-4
Customer Training	1-4
Locate Product Documentation on the Oracle Help Center Site	1-4
Regulatory Compliance and Certification	1-4
Hardware Repair and Return	1-8
Repair and Return Shipping Instructions	1-9
Returning a Crate	1-10

2 System Overview

Introduction	2-1
Oracle Communications EAGLE	2-1
Maintenance and Administration Subsystem	2-3
E5-based Control Cards	2-4
Communication Subsystem	2-5
Inter-processor Message Transport	2-6
High-Speed IMT Packet Router 2	2-6
Application Subsystem	2-6
Generic Program Loads	2-7
Link Interface Module	2-8
Measurements Collection and Polling Module	2-9
E5-MCPM-B Module	2-9
E5-SM8G-B Module	2-9
E5-B Interface Module	2-10
Timing Systems	2-13
Multi-Purpose Server (MPS) Systems	2-15

3 Hardware Descriptions - EAGLE

Introduction	3-1
EAGLE	3-1
Multi-Purpose Server (MPS)	3-2
Hardware Baselines	3-6
Frames	3-6
Extension Frame	3-9
Miscellaneous Frame	3-14
Control Frame	3-15
Control Shelf	3-15
Control Shelf Backplanes	3-17
Extension Shelf	3-20
Extension Shelf Backplanes	3-23
Locating the EAGLE System Number	3-24
Modules	3-25
High Speed IMT Packet Router 2	3-27
E5 Maintenance and Administration Subsystem Processor (E5-MASP) Card	3-31
Requirements and Dependencies	3-31
E5-MCAP	3-34
E5-TDM	3-34
E5-TDM Functions	3-34
Thermal Management	3-35
Switches and LEDs	3-36
Cabling and Technical Specifications	3-37
E5-MDAL	3-38
Alarms	3-38
Fan Control	3-38
LEDs	3-39
Technical Specifications	3-41
Time Slot Counter Synchronization	3-41
Link Interface Modules	3-41
Database Communications Module	3-50
Signaling Transport Card	3-52
Measurements Collection and Polling Module	3-52
E5-ATM-B Module	3-52
E5-E1T1-B Module	3-56
E5-ENET-B Module	3-61
SLIC	3-66

E5-MCPM-B Module	3-69
E5-SM8G-B Module	3-72
Air Management Card	3-75
Fan Tray	3-76
Fuse and Alarm Panels	3-77
Fuses	3-78
Fuse and Alarm Panel (P/N 870-2804-01)	3-79
Fuse and Alarm Panel (P/N 870-1606-xx/870-2320-xx)	3-82
Provision Rules for FAP Fuse Locations	3-84
Holdover Clock	3-85

4 Hardware Descriptions - OEM-Based Products

OEM-Based Product Descriptions	4-1
Extended Services Platform (ESP) Host Servers	4-1
OEM-Based Networking Elements	4-4
Routers	4-5
Ethernet Switches	4-6
OEM-Based Peripheral Elements	4-7
Breaker Panels	4-8
Eight-Port Connector Box	4-9

5 Site Engineering - EAGLE

Safety and Cautionary Information	5-1
Introduction	5-1
Location	5-1
Space Requirements	5-2
Lighting	5-2
Building Requirements	5-2
Earthquake Resistance	5-2
Environmental Requirements	5-3
Heating Ventilation and Air Condition Requirements	5-3
Floor Loading	5-3
Grounding	5-4
Power Requirements	5-6
Populating the System	5-7
Hardware Power Calculator Tool	5-7
Message Flow Control (MFC)	5-8
Database Communications Module (DCM) and Double-Slot Enhanced DCM (EDCM)	5-9

A Hardware Baselines

Baseline Tables	A-1
EAGLE Release 46.3 Through 46.6	A-1
EAGLE Cable Assemblies and Adapters	A-5
Notes	A-7

Index

List of Figures

1-1	European Directives CE Mark	1-5
1-2	Combined UL Mark for the United States and Canada	1-5
1-3	Hazardous Substances	1-5
2-1	EAGLE Functional Diagram	2-2
2-2	E5-based Maintenance and Administration Subsystem Block Diagram	2-4
2-3	Clock Routing	2-14
3-1	EPAP MPS Overview	3-3
3-2	Layered Design for MPS and Applications	3-4
3-3	MPS Hardware Overview	3-5
3-4	Frames	3-7
3-5	Frame End Panel with Lamp Indicators	3-8
3-6	Control Frame CF-00 Numbering Plan	3-9
3-7	Extension Frame EF-00 Numbering Plan	3-10
3-8	Extension Frame EF-01 Numbering Plan	3-11
3-9	Extension Frame EF-02 Numbering Plan	3-12
3-10	Extension Frame EF-03 Numbering Plan	3-12
3-11	Extension Frame EF-04 Numbering Plan	3-13
3-12	Extension Shelf Backplane ID (P/N 850-0356-03)	3-13
3-13	Extension Shelf Backplane ID (P/N 850-0356-04/06/7333417)	3-14
3-14	Miscellaneous Frame	3-15
3-15	Control Shelf Front with Card	3-17
3-16	Control Shelf Backplane (P/N 850-0330-03/04)	3-19
3-17	Control Shelf Backplane (P/N 850-0330-06/07 or 7333412)	3-20
3-18	Extension Shelf with LIMs	3-21
3-19	Shelves with DCM and LIM Cards in Control Frame	3-22
3-20	EAGLE System Number Frame View	3-24
3-21	EAGLE System Number Medium View	3-25
3-22	EAGLE System Number Close View	3-25
3-23	Cam-Out/Lock-In Levers on Cards	3-26
3-24	HIPR2 Switch Same Topology	3-29
3-25	HIPR2 LEDs	3-30
3-26	E5-MASP Card -01	3-32
3-27	E5-MASP Card -02	3-33
3-28	E5-MASP LEDs	3-37
3-29	E5-MDAL LEDs	3-40

3-30	E5-ATM-B Card	3-46
3-31	E5-E1T1-B Card	3-47
3-32	E5-ENET-B Card	3-48
3-33	E5-MCPM-B	3-49
3-34	Database Communications Module	3-51
3-35	E5-ATM-B	3-55
3-36	Channelized E5-E1T1-B Interfaces	3-57
3-37	Channel Bridging Schematic	3-58
3-38	E5-E1T1-B	3-60
3-39	E5-ENET-B	3-64
3-40	SLIC	3-68
3-41	E5-MCPM-B	3-71
3-42	E5-SM8G-B LED Indicators	3-74
3-43	Air Management card	3-76
3-44	Fan Tray	3-77
3-45	Fuse (GMT Brand Shown)	3-79
3-46	Fuse and Alarm Panel - Front View (P/N 870-2804-xx)	3-80
3-47	Fuse and Alarm Panel Rear (P/N870-2804-01).	3-81
3-48	Fuse and Alarm Panel (P/N 870-1606-xx/870-2320-xx) Front	3-82
3-49	Fuse and Alarm Panel (P/N 870-1606-xx/870-2320-xx) Rear	3-83
3-50	Holdover Clock, Card Location	3-86
3-51	Holdover Clock, Frame Connections	3-86
3-52	Maintenance Interface System Card Block Diagram	3-87
3-53	MCA-5 Card and Output Protection Matrix	3-90
4-1	ESP Server Front and Rear Views	4-3
4-2	8-Port Connector	4-4
4-3	Front View Routers	4-5
4-4	Rear View Isolation Router	4-5
4-5	Rear View Dial-in Router	4-6
4-6	Ethernet Switch	4-6
4-7	Telect Breaker Panel Front View	4-8
4-8	Telect Breaker Panel Rear View	4-8
4-9	Telect Breaker Panel Alarms	4-9
4-10	Eight Port Breakout Box	4-10
5-1	Logic Grounding with FAP (P/N 870-0243-08)	5-5
5-2	Logic Grounding with FAP (P/N 870-1606-xx/870-2320-xx)	5-5
5-3	Door Grounding	5-6

List of Tables

1-1	Admonishments	1-2
1-2	Basic RMA Types	1-8
1-3	RMA Reasons for Return	1-8
3-1	Card Specifications	3-27
3-2	HIPR2 Technical Specifications	3-31
3-3	Thermal Alarm Conditions	3-36
3-4	E5-MASP Technical Specifications	3-37
3-5	E5-MDAL Technical Specifications	3-41
3-6	Hardware Requirements-Maximum Number of Links	3-43
3-7	Thermal Alarm Conditions	3-54
3-8	T1 and T2 temperature thresholds	3-54
3-9	E5-ATM-B Technical Specifications	3-56
3-10	Channel Bridging E1/T1 Port Pairing	3-59
3-11	E5-E1T1-B Technical Specifications	3-60
3-12	E5-ENET-B Supported Protocols	3-61
3-13	E5-ENET-B Capacities	3-62
3-14	Thermal Alarm Conditions	3-62
3-15	T1 and T2 temperature thresholds	3-63
3-16	Interface Cable/Adapter	3-65
3-17	Interface Cable/Adapter	3-66
3-18	E5-ENET-B Technical Specifications	3-66
3-19	Thermal Alarm Conditions	3-67
3-20	SLIC Front Panel LEDs	3-68
3-21	Thermal Alarm Conditions	3-70
3-22	T1 and T2 temperature thresholds	3-70
3-23	E5-MCPM-B Technical Specifications	3-71
3-24	Thermal Alarm Conditions	3-73
3-25	T1 and T2 temperature thresholds	3-73
3-26	Front Faceplate LED Indicators	3-74
3-27	E5-SM8G-B Technical Specifications	3-75
3-28	Fuse Color Codes of Alarm Flags	3-79
3-29	Fuse and Alarm Panel Front Items (P/N 870-2804-xx)	3-80
3-30	Fuse State and LED condition (P/N 870-2804-01).	3-80
3-31	Fuse and Alarm Panel Rear Items (P/N870-2804-01).	3-81
3-32	Fuse and Alarm Panel Specifications (P/N 870-2804-01).	3-82

3-33	Fuse and Alarm Panel Front Items	3-83
3-34	Fuse and Alarm Panel (P/N 870-1606-xx/870-2320-xx) Rear	3-83
3-35	Fuse and Alarm Panel (P/N 870-1606-xx/870-2320-xx) Specifications	3-84
4-1	System Specifications	4-2
4-2	ESP Server LEDs	4-3
4-3	Router Front LEDs	4-5
4-4	Router Rear LEDs	4-6
4-5	Ethernet Switch LEDs	4-7
4-6	Breaker Panel LEDs	4-9
5-1	Power Usage by Component	5-7
A-1	Hardware Baseline EAGLE Release 46.3 Through 46.6	A-1
A-2	E1 Cable Assemblies	A-5
A-3	T1 MIM LIM Cable Assemblies	A-5
A-4	E5-ATM Adapter	A-6
A-5	ENET Adapters	A-6
A-6	SLIC Adapter	A-6
A-7	Fast Copy Adapters	A-6
A-8	Terminal/Printer Cables and Adapters	A-6
A-9	Modem Cables and Adapters	A-6
A-10	Application Server Site Specific Cables	A-7
A-11	Application Server Serial Adapters	A-7

1

Introduction

This chapter contains an overview of the available information for HLR alarms and events. The contents include sections on the scope and audience of the documentation, as well as how to receive customer support assistance.

Overview

This manual provides hardware descriptions for Oracle Communications signaling systems or components based on the **EAGLE** for releases 45.0 and later. For hardware descriptions of earlier releases, contact your sales representative.

This manual provides an overview of each system and its subsystems including details of standard and optional hardware components. In addition, this manual describes basic site engineering for signaling products.

Systems included in this manual are:

- EAGLE Signal Transfer Point (**STP**)
- Multi-Purpose Server(**MPS**)

For information on Oracle Communications EAGLE Application Processor Provisioning (**EPAP**) using the Oracle Communications EAGLE Application B Card (E5-APP-B) Platform, see *Application B Card Hardware and Installation Guide*.

Scope and Audience

This manual describes hardware for informational purposes; it does not describe how to install or replace hardware.

For installation information, refer to *Installation Guide* included in your current documentation suite. For replacement procedures of existing hardware components, refer to *Maintenance Guide*.





For configuration and provisioning, refer to *Database Administration – Features User's Guide* included in your current documentation suite.

This manual is intended for customers, system planners and personnel requiring detailed hardware information.

Documentation Admonishments

Admonishments are icons and text throughout this manual that alert the reader to assure personal safety, to minimize possible service interruptions, and to warn of the potential for equipment damage.

Table 1-1 Admonishments

Icon	Description
 DANGER	Danger: (This icon and text indicate the possibility of <i>personal injury</i> .)
 WARNING	Warning: (This icon and text indicate the possibility of <i>equipment damage</i> .)
 CAUTION	Caution: (This icon and text indicate the possibility of <i>service interruption</i> .)
 TOPPLE	Topple: (This icon and text indicate the possibility of <i>personal injury and equipment damage</i> .)

Manual Organization and Conventions

Hardware Reference is organized into the following chapters:

- [Introduction](#) — Contains general information about manual organization, the scope of this manual, its targeted audience, brief explanations of the various systems, typical content of a Documentation Suite delivered with each system, how to handle hardware repairs and returns, and how to get technical assistance.
- [System Overview](#) — Contains a high-level functional overview of the EAGLE. EAGLE subsystems include Maintenance and Administration, Communication and Application elements. [Hardware Descriptions - OEM-Based Products](#) also describes an overview of **OEM**-based products.
- [Hardware Descriptions - EAGLE](#) — Describes frames, shelves, and cards that make up an EAGLE.
- [Hardware Descriptions - OEM-Based Products](#) — Describes frames, shelves, and the Original Equipment Manufacturer (OEM) parts that make up a OEM-based product.
- [Site Engineering - EAGLE](#) — Describes installation site requirements, including floor plan requirements, environmental requirements, and power requirements.
- [Hardware Baselines](#) — Lists in cross-index tabular form the hardware components that can be configured for each system software release. The tables are divided into groups of similar systems for easier use. Use these tables to determine if a specific hardware module or OEM element can be configured.

Hardware Reference uses the following conventions:

- Components used only in a specific system are clearly labeled, for example, (EAGLE only).
- Components that are specific to a release are labeled with the system and release number; for example, (EAGLE 44.0 or earlier).

My Oracle Support (MOS)

MOS (<https://support.oracle.com>) is your initial point of contact for all product support and training needs. A representative at Customer Access Support (CAS) can assist you with MOS registration.

Call the CAS main number at 1-800-223-1711 (toll-free in the US), or call the Oracle Support hotline for your local country from the list at <http://www.oracle.com/us/support/contact/index.html>. When calling, make the selections in the sequence shown below on the Support telephone menu:

1. Select 2 for New Service Request
2. Select 3 for Hardware, Networking and Solaris Operating System Support
3. Select one of the following options:
 - For Technical issues such as creating a new Service Request (SR), Select 1
 - For Non-technical issues such as registration or assistance with MOS, Select 2

You will be connected to a live agent who can assist you with MOS registration and opening a support ticket.

MOS is available 24 hours a day, 7 days a week, 365 days a year.

Emergency Response

In the event of a critical service situation, emergency response is offered by the Customer Access Support (CAS) main number at 1-800-223-1711 (toll-free in the US), or by calling the Oracle Support hotline for your local country from the list at <http://www.oracle.com/us/support/contact/index.html>. The emergency response provides immediate coverage, automatic escalation, and other features to ensure that the critical situation is resolved as rapidly as possible.

A critical situation is defined as a problem with the installed equipment that severely affects service, traffic, or maintenance capabilities, and requires immediate corrective action. Critical situations affect service and/or system operation resulting in one or several of these situations:

- A total system failure that results in loss of all transaction processing capability
- Significant reduction in system capacity or traffic handling capability
- Loss of the system's ability to perform automatic system reconfiguration
- Inability to restart a processor or the system
- Corruption of system databases that requires service affecting corrective actions
- Loss of access for maintenance or recovery operations
- Loss of the system ability to provide any required critical or major trouble notification

Any other problem severely affecting service, capacity/traffic, billing, and maintenance capabilities may be defined as critical by prior discussion and agreement with Oracle.

Related Publications

For information about additional publications related to this document, refer to the Oracle Help Center site. See [Locate Product Documentation on the Oracle Help Center Site](#) for more information on related product publications.

Customer Training

Oracle University offers training for service providers and enterprises. Visit our web site to view, and register for, Oracle Communications training:

<http://education.oracle.com/communication>

To obtain contact phone numbers for countries or regions, visit the Oracle University Education web site:

www.oracle.com/education/contacts

Locate Product Documentation on the Oracle Help Center Site

Oracle Communications customer documentation is available on the web at the Oracle Help Center (OHC) site, <http://docs.oracle.com>. You do not have to register to access these documents. Viewing these files requires Adobe Acrobat Reader, which can be downloaded at <http://www.adobe.com>.

1. Access the Oracle Help Center site at <http://docs.oracle.com>.
2. Click `Industries`.
3. Under the Oracle Communications subheading, click the `Oracle Communications documentation` link.

The Communications Documentation page appears. Most products covered by these documentation sets will appear under the headings "Network Session Delivery and Control Infrastructure" or "Platforms."

4. Click on your Product and then the Release Number.
A list of the entire documentation set for the selected product and release appears.
5. To download a file to your location, right-click the PDF link, select `Save target as` (or similar command based on your browser), and save to a local folder.

Regulatory Compliance and Certification

Oracle Communications products are tested to meet the following regulatory standards:

- Network Equipment Building System (NEBS) level 3 as listed in Telcordia SR-3580.
- Applicable Telcordia Electromagnetic Compatibility and Electrical Safety requirements in GR-1089-CORE.
- Applicable Physical Protection requirements in GR-63-CORE.

- Relevant directives and harmonized standards in support of the products Compliance European (CE) mark required in Europe. Figure 1-1 shows the mark used to indicate this compliance.

Figure 1-1 European Directives CE Mark



- Relevant standards in ElectroMagnetic Compatibility (EMC) directive 2004/108/EC.
- Relevant standards in Safety directive 2006/95/EC, supported by Certified Body (CB) Test Certificates issued by the National Certification Body as tested to IEC 60950 with national differences for participating countries .
- Underwriters Laboratories (UL) listed under UL File E200146 for USA and c-UL for Canada. Figure 1-2 shows the mark used to indicate this compliance.

Figure 1-2 Combined UL Mark for the United States and Canada



- Relevant standards in SJ/T 11363-2006 for limits of certain hazardous substances.

Figure 1-3 Hazardous Substances

部件名称 (Parts)	有毒有害物质或元素 (Hazardous Substance)					
	铅 (Pb)	汞 (Hg)	镉 (Cd)	六价铬 (Cr ⁶⁺)	多溴联苯 (PBB)	多溴二苯醚 (PBDE)
金属部件 (Metal Parts)	○	○	○	○	○	○
电路模块 (Circuit Modules)	×	○	○	○	○	○
电缆及电缆组件 (Cables & Cable Assemblies)	×	○	○	○	○	○
塑料和聚合物部件 (Plastic and Polymeric parts)	○	○	○	○	○	○

○: 表示该有毒有害物质在该部件所有均质材料中的含量均在SJ/Txxxx-xxxx标准规定的限量要求以下。
Indicates that the concentration of the hazardous substance in all homogeneous materials in the parts is below the relevant threshold of the SJ/T 11363-2006 standard.

×: 表示该有毒有害物质至少在该部件的某一均质材料中的含量超出SJ/Txxxx-xxxx标准规定的限量要求。
Indicates that the concentration of the hazardous substance of at least one of all homogeneous materials in the parts is above the relevant threshold of the SJ/T 11363-2006 standard.

台灣標準文件 CNS 15663
Taiwan Standard CNS 15663
Eagle 通訊機架
Eagle Communication Rack
表格文件號碼：
Table part number: 7360209

產品中所含有毒或限用物質含有情況的名稱和含量
Names and Contents of Toxic or Hazardous Materials Contained in the Product

設備名稱：Eagle 通訊機架 Equipment Name: Eagle Communication Rack						
單元 Unit	限用物質及其化學符號					
	鉛 (Pb)	汞 (Hg)	鎘 (Cd)	六價鉻 (Cr ⁺⁶)	多溴聯苯 (PBB)	多溴二苯醚 (PBDE)
主機板 <i>Main Boards</i>	—	○	○	○	○	○
磁碟 <i>Disk Drive</i>	—	○	○	○	○	○
擴充卡/板 <i>Expansion cards/boards</i>	—	○	○	○	○	○
電纜 <i>Cables</i>	—	○	○	○	○	○
電源 <i>Power Supply</i>	—	○	○	○	○	○
機架機殼 <i>Rack and Enclosure</i>	—	○	○	○	○	○
風扇 <i>Fan</i>	—	○	○	○	○	○
電子，發光二極管 <i>Electronics, LEDs</i>	—	○	○	○	○	○
備考 1. “超出 0.1 wt%” 及 “超出 0.01 wt%” 係指限用物質百分比含量超出百分比含量基準值。 Note 1: “Exceeding 0.1 wt %” and “exceeding 0.01 wt %” indicate that the percentage content of the restricted substance exceeds the reference percentage value of presence condition. 備考 2. “○” 係指該項限用物質之百分比含量未超出百分比含量基準值。 Note 2: “○” indicates that the percentage content of the restricted substance does not exceed the percentage of reference value of presence. 備考 3. “—” 係指該項限用物質為排除項目。 Note 3: The “—” indicates that the restricted substance corresponds to the exemption.						

中国口准文件 SJ/T 11364
China Standard SJ/T 11364
Eagle 通口机架
Eagle Communication Rack
表文件号口：
Table part number:

7360209

产品中所含有毒有害物质或元素的名称及含量
Names and Contents of Toxic or Hazardous Materials Contained in the Product

部件名称 Part Name	有毒或有害物质和元素					
	铅 (Pb)	汞 (Hg)	镉 (Cd)	六价铬 (Cr ⁺⁶)	多溴联苯 (PBB)	多溴二苯醚 (PBDE)
主板 Main Boards	×	○	○	○	○	○
磁盘驱动器 Disk Drive	×	○	○	○	○	○
扩展卡/板 Expansion cards/boards	×	○	○	○	○	○
电缆 Cables	×	○	○	○	○	○
电源 Power Supply	×	○	○	○	○	○
机架机壳 Rack and Enclosure	×	○	○	○	○	○
风扇 Fan	×	○	○	○	○	○
电子, 发光二极管 Electronics, LEDs	×	○	○	○	○	○

该表依据 SJ/T 11364 所制。 This table is prepared according to SJ/T 11364.
 ○: 表示该有毒有害物质在该部件所有均质材料中的含量均在GB/T 26572 标准规定的限量要求以下。
 ○: Indicates that this toxic or hazardous substance contained in all of the homogeneous materials for this part is below the limit requirement in GB/T 26572.
 ×: 表示该有毒有害物质至少在该部件的某一均质材料中的含量超出GB/T 26572 标准规定的限量要求。
 ×: Indicates that this toxic or hazardous substance contained in at least one of the homogeneous materials used for this part is above the limit requirement in GB/T 26572.

版權所有 2018 年 Oracle 和 / 或其附屬公司。保留所有權利。本文檔中提供的信息僅用於規劃的目的，並且可以從一個或多個以下得出：在 Oracle 開發的□品信息；一般行業信息；第三方提供的信息，包括但不限於製 Oracle 供應鏈中的製造商和零部件供應商。此外，Oracle 可能在任何時間修改□品計劃，管理電子設備的法律，法規和規章也可能因司法管轄區而異。因此，本文件中提供的信息不成為任何形式的代表或保證，也無意以任何方式修改 Oracle 和此文件接收者間的任何協議的條款和條件，或任何由此□生的各方權益。

版□所有 201 8 年 Oracle 和 / 或其附屬公司。保留所有□利。本文檔中提供的信息□用於□劃的目的，並且可以從一個或多個以下得出：在 Oracle 開□的□品信息；一般行□信息；第三方提供的信息，包括但不□限於 Oracle 供□□中的製造商和零部件供□商。此外，Oracle 可能在任何□□修改□品□劃，管理□子□□的法律、法□和□章也可能因司法管□區而異。因此，本文件中提供的信息不□任何形式的代表或保□，也無意以任何方式修改 Oracle 和此文件接收者□的任何□□的條款和條件，或任何由此□生的各方□益。

Copyright 2018 Oracle and/or its affiliates. All rights reserved. The information provided in this document is for planning purposes only, and may be derived from one or more of the following: product information developed at Oracle; general industry information; and information furnished by third parties, including but not limited to manufacturers and

component suppliers in Oracle's supply chain. In addition, Oracle may modify product plans at any time, and the laws, rules and regulations governing electronic equipment may vary by jurisdiction. As a result, the information provided in this document is not intended to be a representation or warranty of any kind, nor is it intended to modify in any way the terms and conditions of any agreement between Oracle and the recipient of this information, or the rights of either party arising therefrom.

Hardware Repair and Return

Any system components being returned for repair or replacement must be processed through the Oracle Return Material Authorization (**RMA**) procedures. A hardware repair is defined as an item returned to Oracle due to a failure, with the returned item being repaired and returned to the customer. It is essential that serial numbers are recorded correctly. **RMAs** cannot be created without a valid serial number. All repair and quality information is tracked by serial number. [Table 1-2](#) lists the basic **RMA** types.

Table 1-2 Basic RMA Types

Replacement Type	Description	Turnaround
Priority Advance Replacement	Customer requests the URGENT replacement of a damaged product	Same Day Shipment
Advance Replacement	Customer request the replacement of a damaged product	Shipment Within 3 Business Days
Repair / Return	Customer will return a damaged product for repair	Shipment Within 5 Days After Receipt
Expendable	A damaged part, such as a cable, is replaced, but the Customer does not return the damaged product	Depends on Urgency - Shipment Within 3 Business Days

[Table 1-3](#) lists the **RMA** return reasons.

Table 1-3 RMA Reasons for Return

Reason for Return	Description
Damaged by Environment	Product damaged by environmental phenomena such as water damage or earthquake
Damaged in Shipment	Damaged between shipment from Oracle and receipt at the Customer's installation site.
DOA – Dead on Arrival	Product is not functional when it is first installed at the Customer's location.
Lab Return	Products returned from lab sites.
Product Capture	Defect to be captured by Quality or Engineering (not Product Recall).
Product Deficiency	Anything wrong with the part that doesn't fall into another category.
Product Recall	Products recalled by divisions for the repair of a defect or replacement of defective products.
Return – No Product Deficiency	Anything returned without the product being defective.

Repair and Return Shipping Instructions

All returned equipment, assemblies, or subassemblies must be shipped to the Repair and Return Facility specified by the Technical Services engineer. The item being returned must be shipped in the original carton or in an equivalent container assuring proper static handling procedures and with the freight charges prepaid.

The assigned **RMA** number must be clearly printed on the “**RMA#:**” line of the shipping label on the outside of the shipping package. If the **RMA** number is not placed on the label, the return could be delayed.

1. Obtain and confirm the following information before contacting the [My Oracle Support \(MOS\)](#):
 - a. Your name
 - b. Company name
 - c. Call-back number
 - d. Email address
 - e. Which product you are calling about?
 - f. Site location
 - g. **CLLI** number
 - h. System serial number (**NT**, **CE**, **LM**, **DS**, etc.)
 - i. Complete software release (e.g., 28.0.1-41.53.0)
 - j. Upgrade forms
 - **WI005153**
 - **WI005154**
 - **WI005218**
 - **WI005219**
 - **WI005220**
 - k. Card type: (e.g., **E5-MPL**, **DSM**, etc.)
 - l. Card part number (870-####-##)
 - m. Associated serial number (102#####)
 - n. Reason for return or replacement (isolated from system)
 - o. Full name of person the replacement card is being shipped to
 - p. Shipping address

 **Note:**

If possible, include associated alarms (**UAMs**) and a copy of the associated output (capture file).

2. Contact the Customer Contact Center and request a Return of Material Authorization (**RMA**).

Reference: [My Oracle Support \(MOS\)](#).

3. If the item is a like-for-like advance replacement, the Technical Services engineer arranges for shipment of the replacement item to the customer.
 - a. Wait for the replacement component to arrive.
 - b. Package the defective component in the box of materials you received with your replacement.

Use proper static handling procedures.
 - c. Label the outside and inside of the box with your **RMA** number clearly visible.

Place the packing slip from the received replacements on the inside of your box.
 - d. Ship the defective component to the return address listed on the packing slip.
4. If the item is a repair/return, the Technical Services engineer arranges for shipment of the replacement item to the customer.
 - a. Package the defective component in a suitable package for shipping.

Use proper static handling procedures.
 - b. Label the outside and inside of the box with your **RMA** number clearly visible.

Include a packing slip with all the information from 1 along with the **RMA** number.
 - c. Ship the defective component to the following address:

Oracle
Attn: RMA Department
5200 Paramount Parkway
Morrisville, NC 27560
RMA#: <assigned by Oracle>
 - d. Wait for the repaired component to arrive.

Returning a Crate

Use the following procedure to return a shipping crate and dollies to Oracle.

1. Replace the retaining brace.
2. Replace the shipping container front panel using the bolts saved previously and arrange the return shipment by contacting:

Shipping Manager **ORACLE**
Attn: **RMA** Department
5200 Paramount Parkway
Morrisville, NC
27560RMA#: <assigned by Oracle>
3. After the frame is positioned and the dollies are removed from the frame, the dollies are returned to the same address as the shipping container listed above.

If the equipment is being immediately installed ship the dollies back to Oracle in the crate after use. After installing the equipment bolt the dollies securely in the crate and return to Oracle.

OR

If the equipment is not being immediately installed ship the dollies back to Oracle in the box supplied with the crate. After unpacking the equipment return the crate to Oracle and retain the box to return the dollies. After installing the equipment remove the dollies and return to Oracle in the supplied box.

 **Note:**

It is the site supervisor's responsibility to assure the crate and dollies are returned to Oracle.

2

System Overview

Introduction

This chapter introduces the hardware in Oracle Communication's signaling products. The hardware components to support its processor and feature applications include the following:

- **EAGLE**
- Multi-purpose Server (**MPS**)

[Hardware Baselines](#) in this guide lists specific hardware (required or configurable components) by part number for each system type and release.

 **Note:**

Products are described generally in this chapter and in detail in [Hardware Descriptions - EAGLE](#).

In this document, modules or components that are used only in specific systems or releases are noted in the following syntax.

- Components used only in EAGLE systems are labeled (**EAGLE** only).
- Components that are specific to a system and release are labeled with the system name and release number. For example, (Sentinel 8.0 and later).

 **Note:**

The term “module” refers to a hardware card provisioned with software. In some cases, EAGLE cards are referred to by the name of the module in which they function, rather than the card name that appears on the label of the card. For ordering or service purposes, customers should use the card name and part number printed on the card itself.

Oracle Communications EAGLE

The EAGLE is a large capacity, multi-functional, fully scalable **Signaling Transfer Point (STP)**. High capacity and scalability allow the EAGLE to grow from a single-shelf, 80-link STP to a multi-frame, 2800-link STP. EAGLE also supports a variety of interface cards to support connectivity to a wide range of network elements. The EAGLE utilizes a modular design to provide ease of maintenance and expansion. Application and interface cards provide plug-and-play functionality. High reliability and redundancy maximize system availability.

The EAGLE consists of the following functional subsystems. Each subsystem is responsible for a specific task. These subsystems are depicted in [Figure 2-1](#).

- Maintenance and Administration Subsystem (MAS)
- Communication Subsystem (Gigabit backbone)
- Application Subsystem

Figure 2-1 EAGLE Functional Diagram

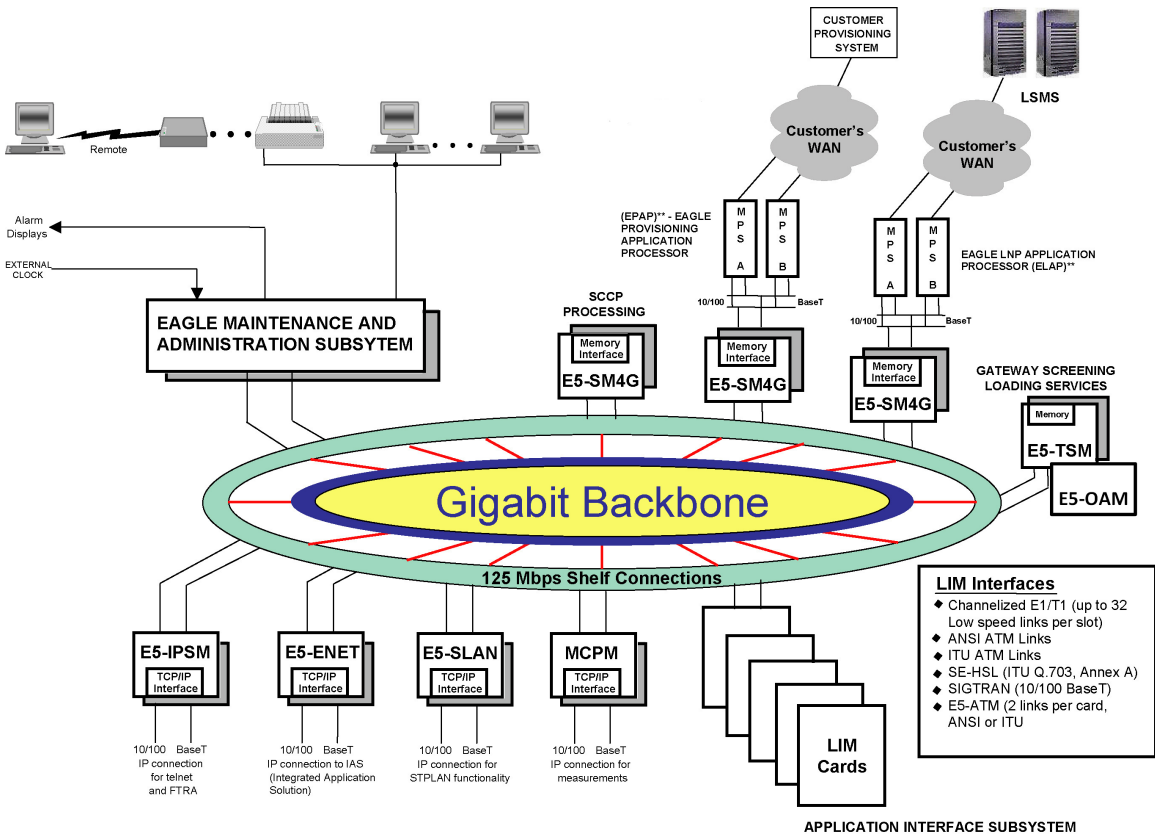

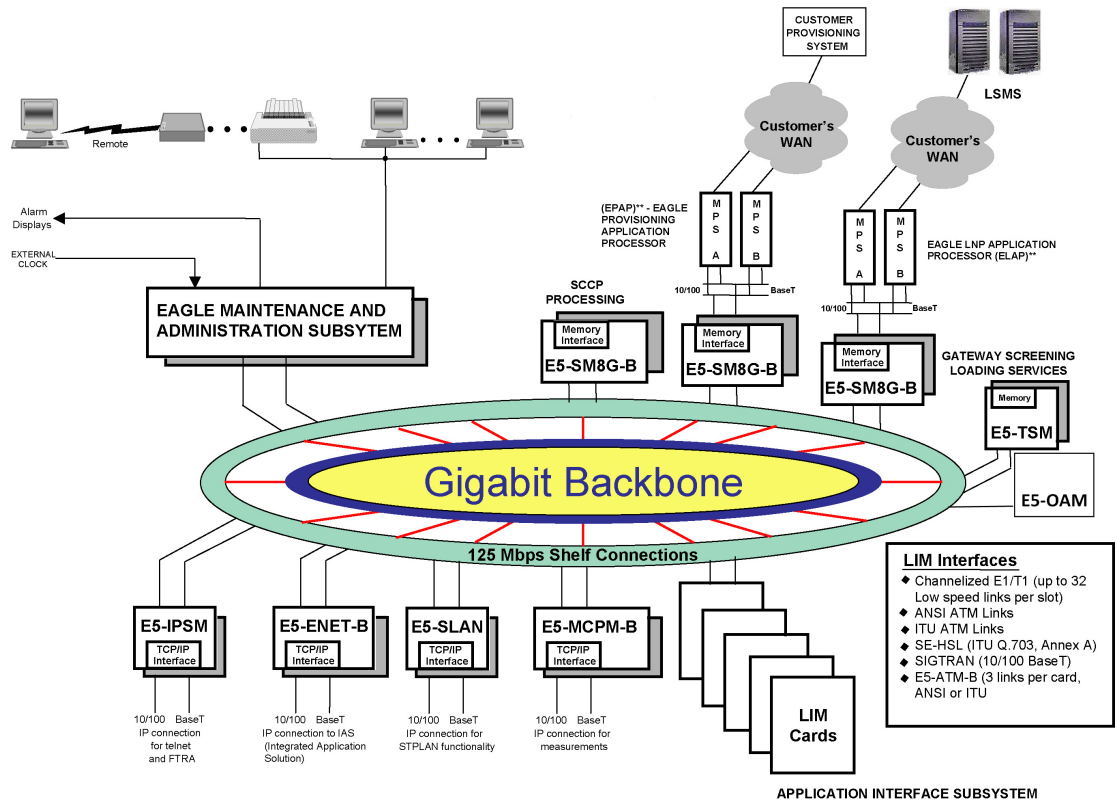

The EAGLE hardware platform consists of various frame types. Each frame holds shelves or rack mounted equipment. The shelves hold the plug-in application and interface cards. [Hardware Descriptions - EAGLE](#) provides detailed information about component requirements and hardware configuration.

In addition, EAGLE has a clock derived from the **Building Integrated Timing System (BITS)**. This connects to the 64KHz composite BITS signal and distributes clock signals to the rest of the cards in the systems.

Note: See the section [Timing Systems](#) for information about High-Speed Master Timing and Time Slot Counter (TSC) Synchronization features.

Maintenance and Administration Subsystem

The **Maintenance and Administration Subsystem (MAS)** is the central management point for the EAGLE. The MAS provides user interface, maintenance communication, peripheral services, alarm processing, system disk interface, measurements, and GLS and SNMP feature support. The EAGLE architecture provides Inter-processor Message Transport (IMT) connectivity directly to the maintenance and administration subsystem. The MAS includes redundancy ensuring continuous management control for the EAGLE. Management and redundancy is provided by use of two separate subsystem processors.

The MAS consists of two separate E5 Maintenance and Administration Subsystem Processor (E5-MASP) cards and a E5 Maintenance Disk and Alarm (E5-MDAL) card Maintenance and

Administration Subsystem Processor (MASP) cards and a Maintenance Disk and Alarm card (collectively referred to as control cards). The control cards are located in slots 1113 through 1118 of the EAGLE Control Shelf.

Note:
If FTRA is in use and E5-OAM cards are installed, EAGLE Release 41.0 and FTRA 4.2 are required.

E5-based Control Cards

The E5-based set of EAGLE **control cards** consist of the following cards:

- One E5-based **Maintenance Disk and Alarm (E5-MDAL)** card.
- Two E5-based **Maintenance and Administration Subsystem Processors (E5-MASP)** cards. The E5-MASP card is a dual-slot physical assembly made up of the following two cards:
 - E5-based **Maintenance Communication Application Processor (E5-MCAP)** card
 - E5-based Terminal Disk Module (**E5-TDM**) card

Note:
See "Hardware Baseline Table" in *Release Notes* for compatible card part numbers.

The E5-MASP is a dual-card/dual-slot assembly occupying slots 1113/1114 or 1115/1116 of the control shelf. The E5-MDAL is a dual-slot card occupying slots 1117/1118 of the control shelf.

The relationship between the control cards is depicted in [Figure 2-2](#).

Figure 2-2 E5-based Maintenance and Administration Subsystem Block Diagram

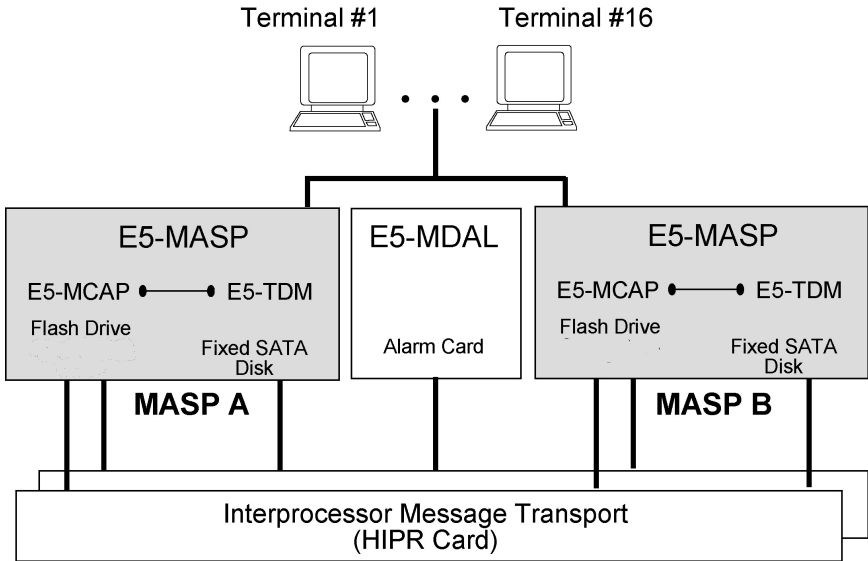

E5 Maintenance and Administration Subsystem Processor (E5-MASP) Card

The **Maintenance and Administration Subsystem Processor (E5-MASP)** cards contain all of the necessary logic to perform both application and communication processing of the data streams provided by the EAGLE. The cards provide connections to the IMT bus through the backplane and all of the necessary logic to perform both application and communication processing of the data streams through the EAGLE. The E5-MASP cards contains one fixed drive and USB connectors for two removable drives.

E5-MCAP

The E5-MCAP card is equipped with 4 GB of physical application processor memory. The primary data interface to the E5-MCAP is RS-232 interfaces (i.e.: terminals) through the E5-TDM.

The E5-MCAP card contains one **latched USB port** for use with removable flash media (“thumb drive”), and one flush-mounted USB port for use with a plug-in flash drive. The removable media drive is used to install and back up customer data. The flush-mounted USB port is used for upgrade and could be used for disaster recovery. The removable flash media is used as a replacement for the legacy Magneto-Optic (MO) Drive. The E5-MCAP card is a replacement for the obsoleted legacy GPSM-II card used for the **MCAP** function.

E5-TDM

The **E5-TDM** card contains four major subsystems: the Terminal Processor Subsystem, the System Clock/Control Subsystem, the SATA Subsystem, and a Power Subsystem. These subsystems provide the EAGLE 5 with 16 user-accessible terminals, distributes Composite Clocks and High Speed Master clocks throughout the EAGLE 5, distributes Shelf ID to the EAGLE 5, and disk storage for an E5-MCAP card. The E5-TDM card provides an interface to the E5-MDAL card for system alarms.

The E5-TDM card contains one fixed solid-state SATA drive that is removable and used to store primary and backup system databases, measurements, and Generic Program Loads (GPLs).

E5-MDAL

The **E5-MDAL** card processes alarm requests, provides general purpose relays, and provides fan control. There is only one **E5-MDAL** card in a control card set and it is shared between two **E5-MASP** cards. The E5-MDAL card is located in slots 1117 and 1118 of the control shelf.

Critical, major and minor system alarms are provided for up to 6 individual racks. In addition to the 3 system alarms, the E5-MDAL card provides the system audible alarm. All alarms are software controlled.

The E5-MDAL card provides control of fans on a per frame basis. The control logic allows for each fan relay to be set individually.

The **E5-MDAL** card does not contain a disk drive.

Communication Subsystem

The communication subsystem consists of the Inter-processor Message Transport (IMT) bus:

Inter-processor Message Transport

The Inter-processor Message Transport (IMT) bus is the main communications artery for all subsystems in the system. The IMT bus uses load sharing, so messages from the various subsystems are divided evenly across both buses. If one bus should fail, the other immediately assumes control of all messages.

IMT buses can function as a private LAN assigning internal IP addresses to LIM cards. By addressing cards on an internal LAN, the EAGLE and the Integrated Monitoring feature allows monitoring of SS7 links without external connections. SS7 link information from the EAGLELIM cards is collected by the Signaling Transport Cards (STCs) and is transferred to Expanded Service Platform (ESP) subassemblies. After processing in the ESP, the link information is forwarded to a monitoring server.

High-Speed IMT Packet Router 2

The High-Speed IMT Packet Router 2 (HIPR2) provides enhanced capabilities in existing EAGLE shelves by increasing system throughput. The HIPR2 enhances the IMT bus with the capability to operate the IMT inter-shelf bus at a rate of 2.5 Gbps. HIPR2 implements the HIPR scheme of transmitting data between shelves only when it is necessary.

Traffic between EAGLE cards on the same shelf will be switched directly to the destination slot and will not transit any other cards in the shelf. Traffic between shelves is not required to pass onto an intra-shelf IMT channel if it is not necessary.

As of Release 46.4, only the High-speed Fibre-channel cable (P/N 830-1344-XX) operating at a 2.5 Gbps inter-shelf bus rate is supported.

2.5 Gbps requires:

- All shelves within EAGLE be equipped with HIPR2
- High-speed Fibre-channel cables

Application Subsystem

The application subsystem consists of application cards. Application cards are capable of communicating with other cards through the redundant IMT buses. A Communications Processor (CP) on each application board provides control of communications from the cards to the IMT buses.

Software is downloaded to application cards on initial power-up from the **Maintenance and Administration Subsystem** Processors (MASP). Once EAGLE is loaded, software is downloaded to cards by the Generic Loader Services (GLS) and Operation Administration and Maintenance (OAM).

An Application Processor (AP) receives the software load on the application card. The type of software the AP receives depends on the function of the application board which is determined by the provisioning of the board. Presently, there are several types of application cards that support network specific functions:

- Signaling Transport Card (STC), E5-ENET, E5-ENET-B —Transmission Control Protocol/Internet Protocol (TCP/IP) interface over Ethernet for the **Signaling Transfer Point Local Area Network (STPLAN)** feature.

 **Note:**

Beginning with Release 38.0, any type dual-slot DCM card is no longer supported. An E5-ENET/E5-ENET-B card must be used.

- E5-TSM — Supports Gateway Screening, running the **GLS GPL**.
- **Database Service Module (DSM)** — **EAGLE** Application Processor(**EPAP**), Global System for Mobile Communications (**GSM**), **EAGLE 5 Local Number Portability (ELAP)**, and interface to **Local Service Management System (LSMS)**.
- E5-SM4G/E5-SM8G-B Database Service Module — **EAGLE** Application Processor (**EPAP**), Global System for Mobile Communications (**GSM**), **EAGLE** LNP Application Processor (**ELAP**), and interface to Oracle Communications LSMS (**Local Service Management System**). Supports 150K TPS GTT and 75K TPS G-Port features. The E5-SM8G-B module is capable of providing up to 13.6K TPS per card.

 **Note:**

The E5-SM4G/E5-SM8G-B does not support ELAP with databases greater than 192M or EPAP with databases greater than 84M.

- E5-ENET, E5-ENET-B — Has 4 physical 10/100 Mbps Ethernet ports. The PMC ports A0 and B0 are utilized as IP signaling link ports while PMC ports A1 and B1 support the Fast Copy feature when enabled. Each interface is independent of the others.
 - 2 physical 10/100 Mbps Ethernet ports.
 - Supports STP Local Area Network function, and 10/100 Base-T ethernet links to the STP.
- E5-MCPM-B - Requirement for the **FTP** measurements feature. The **FTP** measurements feature uses the **MCPM** card ethernet ports to transfer measurements information directly to a **FTP** server. Is used for nodes with link capacity of 2,400 (1,200 if 15 Minute Measurements is enabled) or greater.
- Multi-**Channel** Interface Module, E5-E1T1, E5-E1T1-B — 8 **HDLC** channels for **E1** or **T1** protocols.
- Multi-Port **Link** Interface Module, E5-ATM, E5-ATM-B — **SS7** links. Supports up to 3 links for ATMANSI and ATMITU application.

Generic Program Loads

Application software is downloaded to individual application cards by means of Generic Program Loads (GPLs). Hardware is defined to EAGLE by means of a series of administration commands. Software is then loaded from the fixed disk over the IMT bus directly to the cards. The type of the **GPL** loaded depends on the card that is chosen.

Example GPLs include the following:

- **VSCCP** —Signaling Connection Control Part. This software allows the Database Service Module (DSM) to be used as a memory board for Global Title Translation (GTT). Inbound SCCP messages from Link Interface Modules (LIMs) are sent to the DSM assigned to the LIM by system software. VSCCP software on the DSM performs the translation, and sends

messages through the IMT back to the appropriate LIM, which routes messages to the destination. The VSCCP application can run on the DSM cards.

 **Caution:**

It is recommended that cards running the VSCCP application be uniformly distributed in the EAGLE to provide a more even VSCCP load distribution. During normal operation unevenly distributed VSCCP cards in an EAGLE would not have any network or system impacts. However, should a particular VSCCP card database(s) become corrupted, inconsistent, or at a different level, depending on the amount of service provided by that card and the extent of the database issue, network impacts can occur.

- **SLAN**—Signaling Transfer Point Local Area Network. This software allows the system to support a TCP/IP interface to any external host with DCMs.
- **SS7**—This software provides access to remote SS7 network elements.
- **GLS**—Gateway Loading Service (GLS) software controls download of Gateway Screening (GWS) data to Link Interface Modules (LIMs) and DSM when necessary. This ensures a fast download of gateway screening data when a card re-initializes. Gateway screening data is downloaded when a card is re-initialized, when Gateway screening is changed by database administration, or when there is manual intervention with commands being entered at a terminal.
- **EROUTE**—Ethernet Routing transfers link information messaging from the EAGLE LIM cards to the Integrated Sentinel using TCP/IP and EAGLE Monitor Protocol (EMP). Implemented in Signaling Transport Cards (STC).

 **Note:**

For a full and current list of GPLs, see "Generic Program Loads" in *Release Notes*.

Link Interface Module

The application subsystem provides external services, relying on the Link Interface Module (**LIM**) as an interface. Each LIM provides one or more line interfaces (Ethernet, E1/T1/J1, ATM) that can support 1 or more **SS7** links (depending on configuration). A LIM consists of an application card equipped with a main assembly and an applique. This assembly provides level one and some level two functions on SS7 signaling links/line protocols.

The types of interfaces presently available through a LIM are:

- T1-**ATM** at 1.544 Mbps
- E1-**ATM** at 2.048 Mbps
- E1 at 2.048 Mbps
- T1 at 1.544 Mbps
- Channelized E1 at 64Kbps per TS
- Channelized T1 at 56Kbps per TS
- Channelized **J1** at 64Kbps per TS

- **IP/Ethernet** at 10/100 Mbps

Measurements Collection and Polling Module

The Measurements Collection and polling Module (**MCPM**) is an **E5-MCPM-B** card running MCPHC GPL.

 **Note:**

The Measurements Platform IP Security feature requires an MCPM card.

 **Note:**

The MCPM card is a requirement for the FTP measurements feature. The FTP measurements feature utilizes the MCPM card ethernet ports to transfer measurements information directly to a FTP server.

E5-MCPM-B Module

The E5-MCPM-B (P/N 870-3089-xx), Measurements Collection and polling Module (**MCPM**), is a requirement for the FTP measurements feature. The FTP measurements feature utilizes the E5-MCPM-B card ethernet ports to transfer measurements information directly to a FTP server.

 **Note:**

The Measurements Platform IP Security feature requires E5-MCPM-B or EDSM-2G MCPM cards.

E5-SM8G-B Module

The E5-SM8G-B (P/N 870-2990-xx) is a database service module (**DSM**) designed to operate in the EAGLE shelf. The E5-SM8G-B is a double-slot card with 8GB of total memory. It provides global title functions required for Local Number Portability (LNP), all Signaling Connection Control Part (SCCP), which is part of Global Title Translation (GTT), and Generic Load Services (GLS) which is part of Gateway Screening.

 **Note:**

All E5-based cards require **HIPR2**. For more information, see [High-Speed IMT Packet Router 2](#).

E5-B Interface Module

The E5-B interface module is a link interface card that utilizes an **Embedded Processor Module (EPM-B)** with an appliqué card. The E5-B card provides the EAGLE system a high performance general purpose-processing platform in a single-slot footprint. The E5-B card is used on existing EAGLE control and extension shelves.

 **Note:**

As of Release 46.6, all cards and references to E5 and EPM cards refer to E5-B and EPM-B cards.

The **EPM** appliqué cards provide **LIM** functionality such as **E1/T1** or **IP**. The EPM accepts up to two single-width or one double width **PCI Mezzanine** appliqué card(s). The EPM assembly contains all of the necessary logic to perform both application and communication processing of the data streams provided by the appliqué cards such as E1/T1 or IP. All EAGLE System interfacing to the EPM occurs through the EAGLE backplane signals and connects to the appliqué cards through the **PCI Mezzanine Card (PMC)** interface.

The EPM-B is a dual core base board with an appliqué interface to support the line interface cards. The **EPM-B** appliqué cards provide the same functionality as the obsoleted EPM cards, providing increased throughput and capacities.

 **Note:**

The EPM-B cards may take up to 30 seconds after they are plugged in before any LED activity is observed.

The types of E5-B cards presently available are:

- **E5-E1T1-B** (P/N 870-2970-xx)
- **E5-ENET-B** (P/N 870-2971-xx)
- **E5-ATM-B** (P/N 870-2972-xx)
- **E5-MCPM-B** (P/N 870-3089-xx)

E5-ATM-B Module

The **E5-ATM-B** card (P/N 870-2972-01) is a single slot card providing ATM over E1 and T1 connectivity for EAGLE control and extension shelves.

The card supports up to 3 links for ATMANSI and ATMITU application. The E5-ATM provides connectivity for two E1/T1 ports on the Port A backplane connector, allowing up to three links that may be provisioned. Both E1/T1 ports can be accessed with a 2-port or 4-port cable. An interface adapter (P/N 830-1342-05) allows the two ports to be physically split to two different cables/patch panels. If it is desired to move the second E1/T1 port to the Port B backplane connector, then an adapter and another cable (1-, 2-, or 4-port) must be used.

 **Note:**

Throughout this document, the term E5-ATM refers to the E5-ATM-B card (P/N 870-2972-01).

E5-E1T1-B Module

The E5-E1T1-B card (P/N 870-2970-xx) is a single slot card providing eight trunk terminations. The eight E1/T1 ports reside on backplane connectors A and B. The E5-E1T1-B supports up to 64 signaling links of configurable channelized E1 or T1 connectivity OR two SE-HSL/ST-HSL signaling links.

All ports on a single board operate in the same trunk format, E1 or T1. However, it is possible to have a mixture of trunk formats in a node with some E5-E1T1s operating in T1 mode with others operating in E1 mode for gateway node scenarios.

 **Note:**

Throughout this document, the term E5-E1T1 refers to the E5-E1T1-B card (P/N 870-2970-xx).

E5-ENET-B Module

The E5-ENET-B module (P/N 870-2971-xx) is a single slot card that has one or more Ethernet interfaces and provides increased transactions per second (TPS).

 **Note:**

Throughout this document, the term E5-ENET refers to the E5-ENET-B (P/N 870-2971-xx) card.

The E5-ENET provides support for the following:

- IPGW_x
 - **SCTP, M3UA, SUA**
 - Up to 50 SCTP connections per card
 - Up to 250 total E5-ENET cards per node. This total may be made up of cards running any application type (IPLIM, IPGW, IPSG) and any adapter type.
- IPSG
 - **M2PA, M3UA**
 - Up to 32 M2PA or M3UA links per IPSG E5-ENET card
 - Up to 32 M2PA or M3UA associations per IPSG E5-ENET card
 - Up to 128 SCTP associations per SLIC card
 - Up to 250 total E5-ENET cards per node. This total may be made up of cards running any application type (IPLIM, IPGW, IPSG) and any adapter type.

- STP Local Area Network (**SLAN**)
 - TCP/IP
 - Up to 32 cards per node
 - Up to 2 cards per shelf
- EROUTE (STC)
 - TCP/IP
 - Up to 32 cards per node

 **Note:**

The E5-ENET is provisionable for these functions, but does not support multiple functions on a single card simultaneously.

 **Note:**

The E5-ENET-B module (P/N 870-2971-xx) can run the IPS GPL to perform all functions as the E5-IPSM card. E5-ENET-B with IPS GPL can be exchanged with IPSM cards running IPS, without any changes in provisioning information. The E5-ENET-B running the IPS GPL supports SEAS Over IP functionality.

The E5-ENET module has 4 physical 10/100 Mbps Ethernet ports. The PMC ports A0 and B0 are utilized as IP signaling link ports while PMC ports A1 and B1 support the Fast Copy feature when enabled. Each interface is independent of the others. The E5-ENET card and other DCM-class cards have backplane cable pinout differences requiring an adaptor for the E5-ENET card.

E5-SLAN Module

The SLAN on the E5-ENET-B feature increases the transaction processing capacity (TPS) of the SLAN application by implementing the migration of the SLAN application to the E5-ENET assembly introduced in EAGLE Release 35.0. The E5-SLAN feature supports all features currently implemented on the SS-EDCM assembly to support the SLAN application.

The E5-SLAN card connects to an external host using the existing cabling required for the current SSEDCEM assemblies when backplane cable adaptor P/N 830-1103-xx is used. The E5-SLAN card connects to an external host using standard CAT-5 Ethernet cables when backplane adaptor P/N 830-1102-xx is used.

E5-STC Module

The STC on the E5-ENET-B feature implements the enhancement of EROUTE application and its migration to E5-ENET assembly. This module provides higher-card capacity with increased TPS support. E5-ENET-B card supports two Ethernet PMC cards (PMC A and PMC B) each having Ethernet interfaces, one for use and one for maintenance testing. Each interface independently supports 10/100 Mbps data rates, full/half duplex, fixed/auto-negotiate, DIX/802.3 MAC header modes. The E5-STC feature, and corresponding EAGLE provisioning capabilities supports up to 32 E5-STC modules per node.

Timing Systems

EAGLE uses synchronized timing systems to provide accurate reference standards to all cards on the IMT buses.

System Clock

EAGLE connects to the 64KHz composite Building Integrated Time System (**BITS**) clocks through two **DB-15** style connectors on the backplane of the control shelf. The two clocks are labeled primary and secondary and are sent to both **MASPs**. Each **MASP** selects between two **BITS** clock signals to provide a system clock to the rest of the EAGLE. The system clock is used by **Link Interface Modules (LIMs)** and **Signaling System #7 (SS7) Digital Service level-0 Applique (DS0A)** signaling links, with each **LIM** selecting either clock A or clock B for its own use.

EAGLE also distributes system clocks to all frames. All shelves, both extension shelves and control shelves, provide “clock in” and “clock out” connections. Clock cables from the control shelf connect to the “clock in” connector on the top shelf of each frame. From the “clock out” connector on the top shelf of each frame, the clock signals are connected to the “clock in” connector of the middle shelf of the frame and from that shelf to the bottom shelf.

Holdover Clock

An optional holdover clock can maintain clock synchronization for EAGLE **DS0A** links during brief interruptions of the **Building Integrated Timing System (BITS)** clock signals. In accordance with Telcordia Technologies **GR-1244-CORE**, **BITS** clock outages of up to 15 seconds can be tolerated.

BITS Clock Routing

BITS clock signals A and B are routed through the holdover clock and then to the system, allowing the holdover clock to continue Stratum 3 clock signals to the EAGLE (see [Figure 2-3](#)).

Figure 2-3 Clock Routing

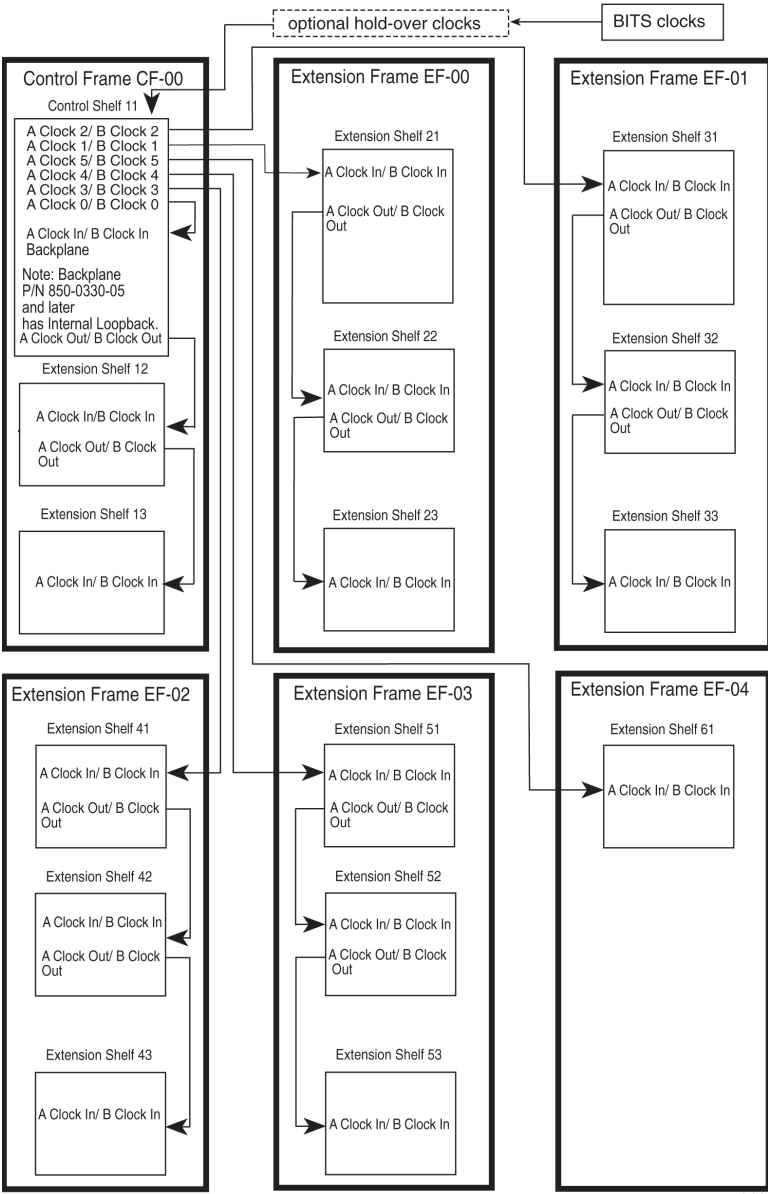

High-Speed Master Timing

The EAGLE can be configured with high-speed master timing capabilities. High-speed master timing allows synchronization of LIM cards at E1 or T1 rates. For more information about installing or upgrading to high-speed timing see the section on Master Timing in *Installation Guide*.

Time Slot Counter Synchronization

Time Slot Counter Synchronization (TSC) Synchronization allows all cards in the system that contain a Time Slot Counter (TSC) to synchronize with one another. The ability to have synchronized timing between cards is used in applications such as system wide message time stamping.

Multi-Purpose Server (MPS) Systems

The **MPS** system can be configured as an Oracle Communications **EAGLE** LNP Application Processor (**ELAP**) or **EAGLE** Application Processor (**EPAP**) server.

The **MPS** provides an interface between the customer provisioning network and the **EAGLE SM** cards. As the customer's data is updated, the **MPS** stores the data and updates the **SM** cards. An **MPS** is usually co-located with an **EAGLE**. If you need to install an **MPS** at a distance from the **EAGLE**, contact the [My Oracle Support \(MOS\)](#) for assistance.

MPS running the **EPAP** software supports the **GSM** Flexible Numbering (**G-Flex**), **GSM** Mobile Number Portability (**G-Port**), **INAP**-based Number Portability (**INP**), and other features.

These features allow a subscriber to change location, service provider, or service while keeping the same directory number and ensures that subscribers receive the same freedom of choice for local service as they do with long-distance service providers.

MPS running the (ELAP) software supports the North American **LNP** feature.

The **MPS** uses the **E5-APP-B** card. For more information on this card, see *Application B Card Hardware and Installation*.

OEM Products

OEM-Based Servers

OEM-based products use Commercial Off-The-Shelf (**COTS**) servers, network elements, and peripheral components. Server hosts provide processing power and database storage capacity to deliver a scalable range of application specific services. Components can be configured redundantly to provide a high level of reliability in processing applications. One such **OEM**-based Product server currently being used is the Sun Netra **T1DC200** server (used as Extended Services Platform (**ESP**) servers in the **Integrated Sentinel** systems).

OEM-based product capabilities are defined by specific application requirements. Optional processing components that provide application specific services can be integrated into **OEM**-based systems.

OEM-Based Network Elements

OEM-based products are configured as frame-mounted Local Area Networks (**LAN**) using Commercial Off-The-Shelf (**COTS**) routers, hubs, and switches. Typically **OEM**-based products are configured in redundant **LANs** with isolation and dial-up access **IP** links to customers networks.

 **Note:**

Telco switches are provisioned in Eagle.

Network components are typically configured in redundant pairs with dual power supply systems for reliability. Network components can include:

- Routers

- Hubs
- Ethernet Switches
- Application Servers
- Optional components

OEM-Based Peripheral Components

OEM-based products use **COTS** peripheral components to support the server and network elements. Peripheral components can include:

- Breaker panels
- Workstations
- Terminals
- Switch boxes
- Break-out boxes

3

Hardware Descriptions - EAGLE

Introduction

This chapter provides detailed descriptions of the various hardware associated with the EAGLE including **MPS** systems. This chapter is designed to aid personnel in configuration, planning, and replacing components in the systems.

This chapter contains detailed descriptions of the frames, shelves, modules, and power distribution in the systems.

EAGLE

EAGLE is a large-capacity, multi-functional, fully scalable Signaling Transfer Point (**STP**). The EAGLE is **NEBS**-compliant (**GR-63-CORE**, Network Equipment-Building Systems). High capacity and scalability allow the EAGLE to grow from a single-shelf, 80-link **STP** to a multi-frame, 2800-link **STP**.

Due to the distributed processor design, EAGLE does not have a separate central processing unit to bottleneck traffic throughput. Application and interface cards are designed to provide plug and play type functionality that facilitates future growth. EAGLE application and interface cards generally do not have specific shelf or frame limitations, allowing you to fully customize and define how your **STP** is configured. EAGLE also supports a variety of interface cards to support connectivity to a wide range of network elements. EAGLE provides connectivity interfaces for **IP**, **ATM**, **T1**, and **E1** protocols.

IP Connectivity

The **EAGLE** provides connectivity between **SS7** and **IP** networks. It receives and sends switched circuit network (**SCN**) native signaling at the edge of the **IP** network. The signaling gateway function may relay, translate, or terminate **SS7** signaling in an **SS7**-Internet gateway. The signaling gateway function may also be co-resident with the media gateway function to process **SCN** signaling associated with line or trunk terminations controlled by the media gateway.

Monitoring

In EAGLE **STP**, Signaling Transport Cards (**STC**) monitor the activity of Link Interface Modules (**LIM**) and transfer information to an Integrated Data Acquisition system such as the Extended Services Platform (**ESP**) subassembly.

Note:

STC cards are based on E5-ENET B cards (P/N 870-2971-xx) or SLIC cards (P/N 7094646), and can be configured in any slot (except slots reserved for HIPR2 cards).

Multi-Purpose Server (MPS)

Oracle Communications' Multi-purpose Server (**MPS**) is a hardware and software platform that can be configured to support ELAP or EPAP.

[Figure 3-1](#) shows an overview of how the **EPAP MPS** is used with the **EAGLE**.

The **MPS** provides an interface between the customer provisioning network and the **EAGLE SM** cards. As the customer's data is updated, the **MPS** stores the data and updates the **SM** cards. An **MPS** is usually co-located with an **EAGLE**.

Figure 3-1 EPAP MPS Overview

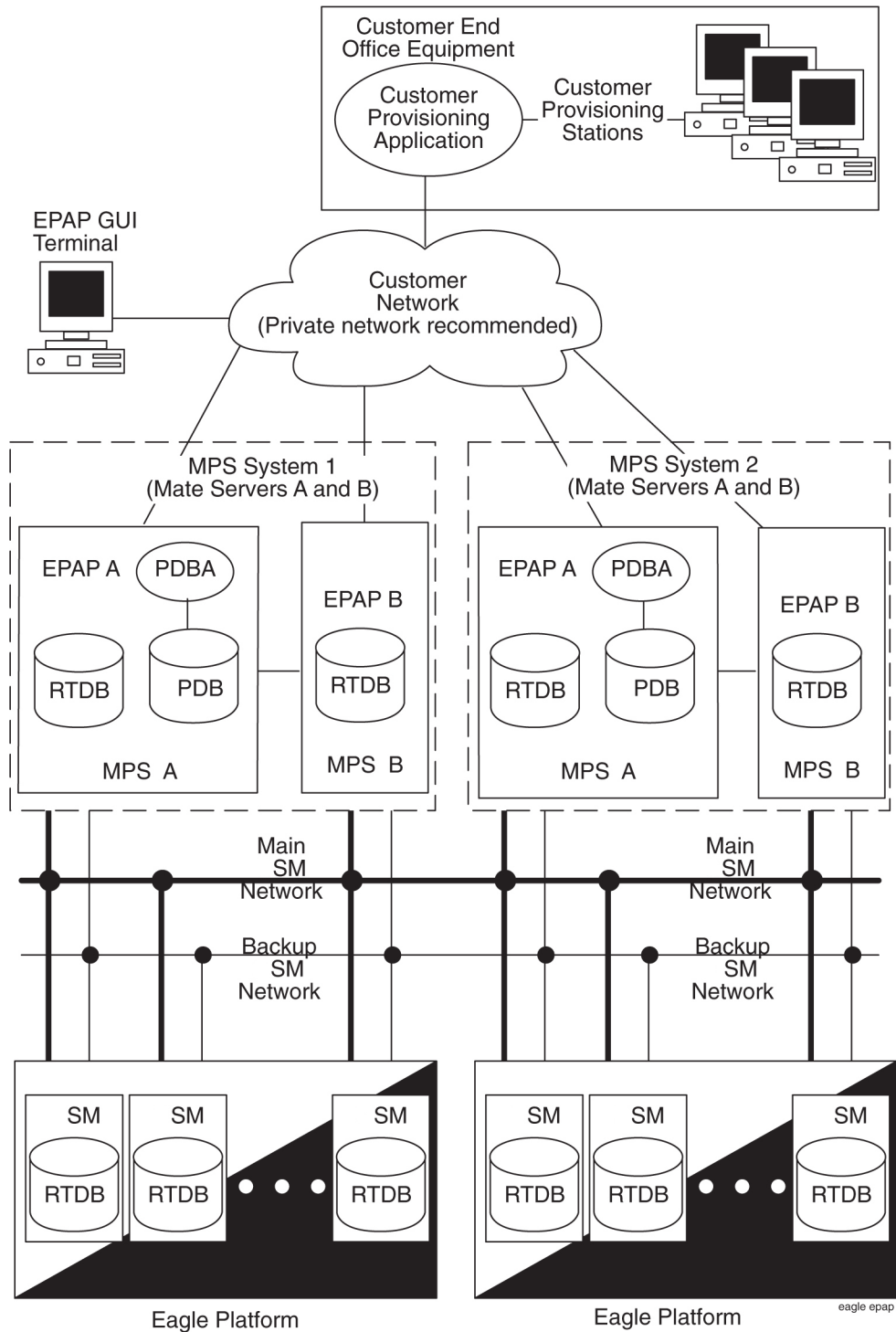

Layered Design

MPS is based on the E5-APP-B card and uses a layered design (see Figure 3-2) with defined interfaces to enable application and platform changes to be made independently. This design

provides an environment in which changes made to platform components need not cause changes in application.

Figure 3-2 Layered Design for MPS and Applications

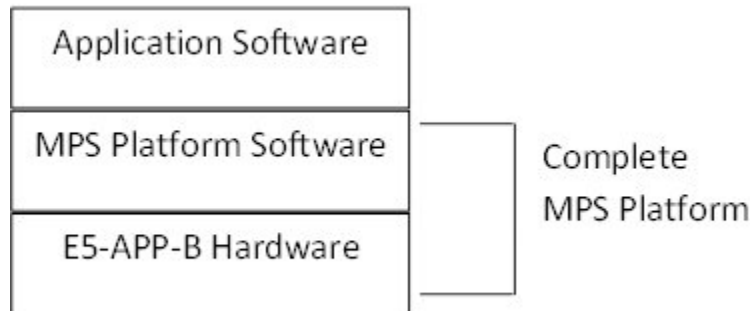

Hardware Components

This section includes a description of **MPS** hardware components and an overview of the disks and file systems. [Figure 3-3](#) illustrates the following equipment.

- One EAGLE **FAP**
- One Fan tray
- Two to four Switches
- Two **MPS** Servers
- One General Purpose Frame

Figure 3-3 MPS Hardware Overview

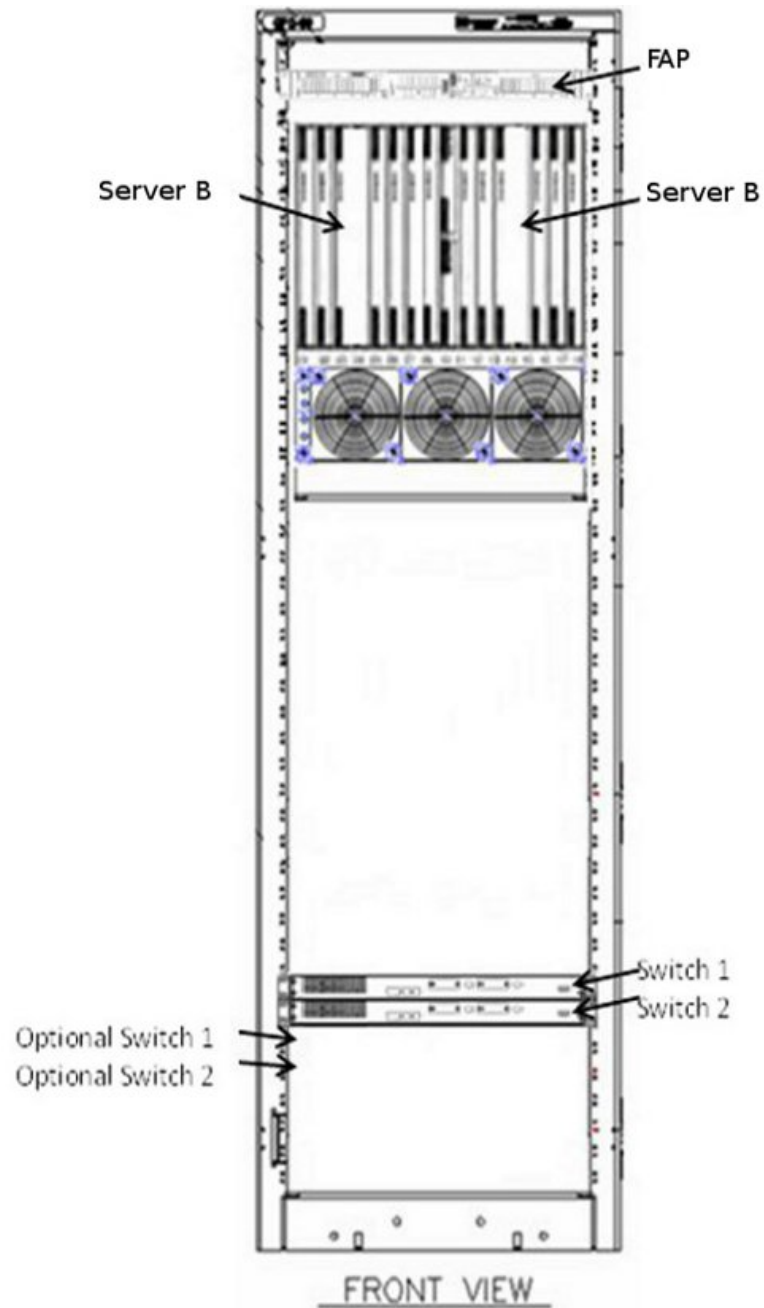

Note:

If the Dual ExAP Configuration feature is used, the MPS Frame would instead contain four to six switches and four MPS server.

NOT_SUPPORTED:

DO NOT install AC powered equipment in the **MPS** frame. No commercially powered AC equipment should be used or placed within 7 feet of -48VDC equipment. Doing so can create a shock hazard to personnel and equipment.

Hardware Baselines

[Hardware Baselines](#) contains a complete listing of the hardware available for each software release. The appendix lists configurable modules arranged in alphabetical order indexed to system software releases. For example, all hardware available will have a bold **X** where the hardware module row crosses the release column.

Frames

The system uses standard 7-foot high, 23-inch wide frames (inside dimension). These floor mounted frames are constructed from channel steel and painted with electrostatic powder. Depending on the configuration, the system uses from one to four frames to accommodate a maximum of 2800 **SS7** signaling links.

 **Note:**

A heavy-duty frame with the capability to support the greater weight of **COTS** equipment is shipped with all new systems. The generic frame is no longer being shipped but is supported in the documentation.

 **Note:**

With the large system feature, depending on configuration, the system can accommodate up to 2800 links. The large system feature applies to the **EAGLE** systems only.

Cross-connect panels, spare card storage, modems, and holdover clocks are configured in Miscellaneous Frames (**MF**).

The system can use five types of frames:

- Control Frame (**CF**)
- Extension Frame (**EF**)
- Miscellaneous Frame (**MF**)
- General Purpose Frame (**GPF**)

[Figure 3-4](#) shows a system with a Control Frame (CF-00) and two Extension Frames (EF-00 and EF-01).

Figure 3-4 Frames

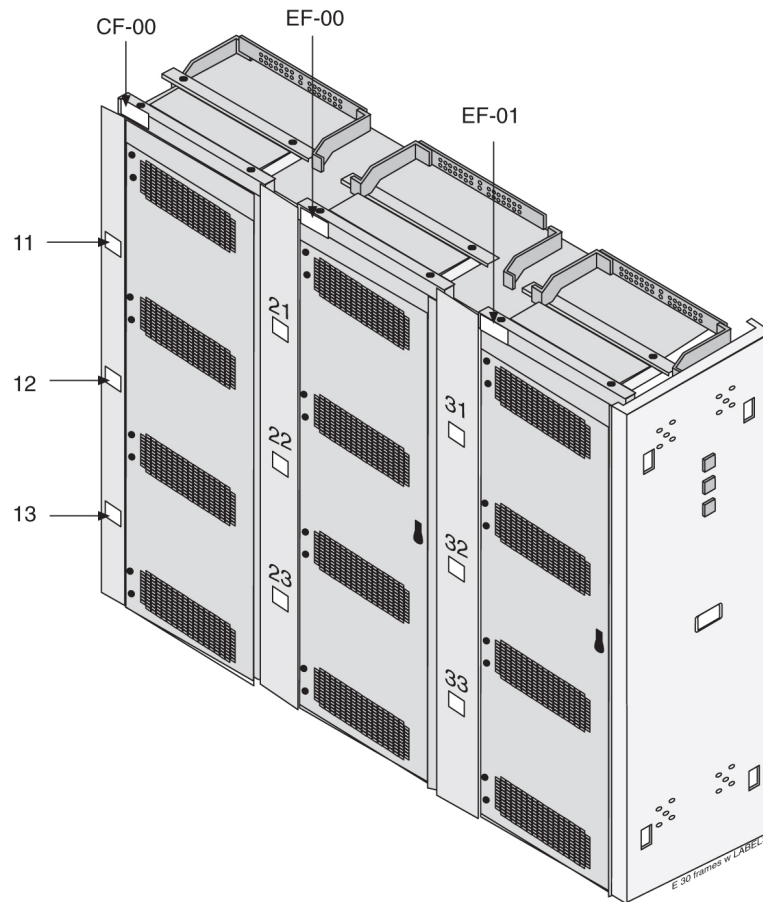

Lamp indicators (P/N 525-0067-R01) can be mounted on either side of the row of frames on the end panels (as shown in [Figure 3-5](#)), which show three levels of alarm conditions:

- Critical
- Major
- Minor

Figure 3-5 Frame End Panel with Lamp Indicators

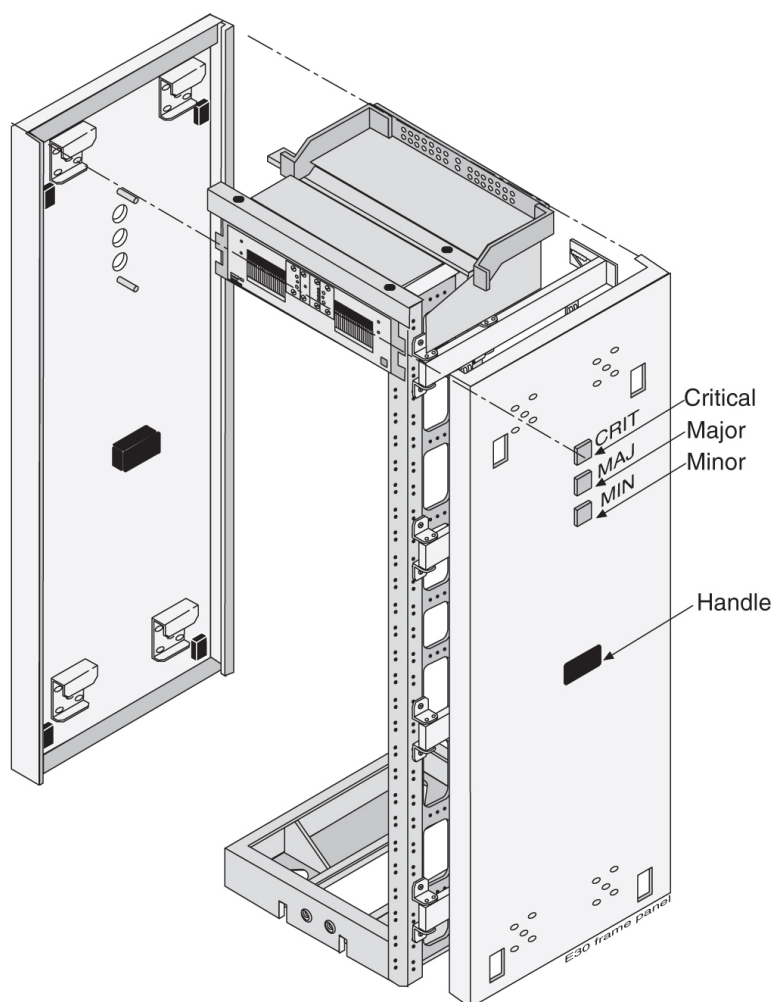

The doors on the front of each frame provide electromagnetic interference shielding and lock in place with a screw lock. Mounted on the inside of the doors are card locators, used to record the location of each card in a shelf and important data regarding the application that each card provides. The shelf backplanes are protected at the rear of the frame by removable transparent Plexiglas panels.

The following lists the part numbers for the panels for the frames:

- P/N 840-0064-01 End row panel, full depth, standard frame, **NTW**.
- P/N 840-0089-01 End row panel, full depth, heavy-duty **NTW**.
- P/N 870-2238-02 Extended panel, alarm side, **NEBS NTW**.
- P/N 870-2278-02 Full depth alarm side panel, heavy-duty frame, **NTW**.

A Fuse and **Alarm Panel (FAP)**, located at the top of each frame, distributes -48VDC to all the shelves in the frame. Fuses are located on the front of the fuse and alarm panel. For more information on the fuse and alarm panel (refer to [Fuse and Alarm Panels](#)).

The numbering of the shelves, with the shelf identification backplane wiring, circuit card location, and with the Inter-processor Message Transport (IMT) address in small print at the

Note:
6200 and 6300 shelf can be used for Telco switch and E5-APP-B cards.

Figure 3-11 Extension Frame EF-04 Numbering Plan

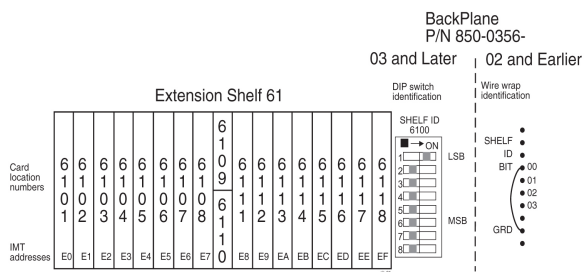

Figure 3-12 Extension Shelf Backplane ID (P/N 850-0356-03)

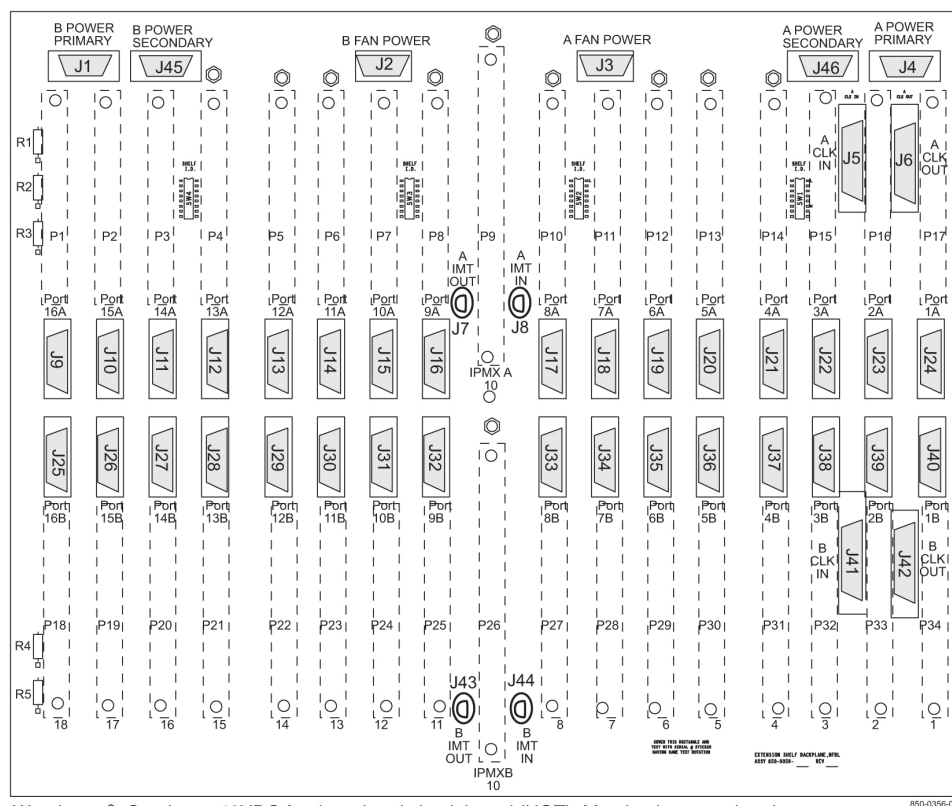
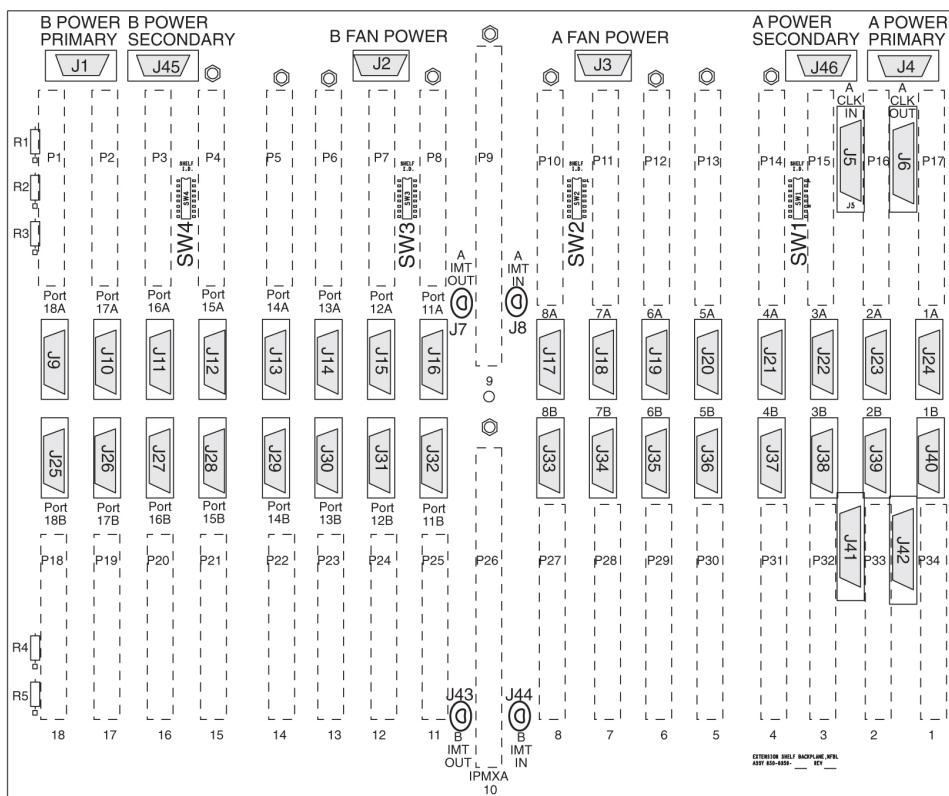

Figure 3-13 Extension Shelf Backplane ID (P/N 850-0356-04/06/7333417)



NOTE: ⦿ Conducts -48VDC for the printed circuit board (HOT)

850-0356-04
7333417

Miscellaneous Frame

The Miscellaneous Frame (**MF**) is an optional frame that can be used to mount holdover clocks, test equipment, jack panels, spare cards, and other customer-specified accessories or equipment. The optional spare card storage shelf is equipped with card guides and doors for safe storage of all system cards.

The Miscellaneous Frame (**MF**) is equipped with a Fuse and **Alarm Panel (FAP)** that can provide fused -48VDC to equipment mounted in the frame.

An example of a miscellaneous frame is shown in [Figure 3-14](#).

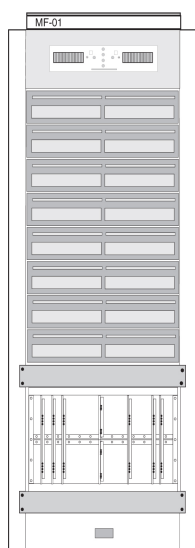
Figure 3-14 Miscellaneous Frame

Control Frame

The Control Frame (CF) is the principle frame for the system. The top shelf is the control shelf, containing all the components of the Maintenance and Administration Subsystem (MAS), and up to ten additional **Link** Interface Modules (LIMs), E5 Interface Modules, E5-TSM Modules, E5-SLAN Modules, E5-STC Modules or E5-MCPM-B Modules in any combination. E5-SM (E5-SMxG/E5-SMxG-B) Modules (E5-SM modules require two card slots).

The control frame can also contain up to two extension shelves. Each extension shelf can accommodate up to 16:

- Link Interface Modules (LIMs), E5 Interface Modules, E5-TSM Modules, E5-SLAN Modules, E5-STC Modules or E5-MCPM-B

Or each extension shelf can accommodate up to eight:

- E5-SM (E5-SMxG/E5-SMxG-B) Modules (E5-SM (E5-SMxG/E5-SMxG-B) Modules (E5-SM modules require two card slots).

All cards can be inserted in any slot except for those locations dedicated to the HIPR2 and **MASP** cards. In **EAGLE** systems and **IP**⁷ 4.0 and earlier systems, E5-SM (E5-SMxG/E5-SMxG-B) modules must be placed into odd-numbered slots, and due to their width the adjoining even-numbered slot will be taken as well.

Control Shelf

The control shelf is divided into two parts. One part is used by the **Maintenance and Administration Subsystem (MAS)** and contains the following hardware:

- Two E5-based Maintenance and Administration Subsystem Processors (E5-MASP) cards.
- One E5-based Maintenance Disk and Alarm (E5-MDAL) card

Two HIPR2 cards provide Inter-processor Message Transport (**IMT**) bus continuity for all cards connected to the IMT bus.

 **Note:**

HIPR2 cards are installed at the factory or by Technical Support and are not installed by customers.

The remainder of the control shelf can be occupied by up to ten of the following cards, in any combination and in any location not dedicated to an **MASP** pair or **HIPR2** card:

- Link Interface Module (**LIM**)
- E5 Interface Modules
- E5-TSM Modules
- E5-SLAN Modules
- E5-STC Modules
- E5-IPSM Modules
- E5-MCPM-B Modules

E5-SM (E5-SMxG/E5-SMxG-B) cards must be inserted into odd numbered slots in EAGLE systems.

 **Caution:**

After the frame has been shipped or moved, prior to applying power, remove all cards. Reset all cards carefully to avoid possible faulty connections. All cards are hot swappable.

The control shelf, shown in [Figure 3-15](#), consists of top and bottom assemblies with die-formed channel slots to accept the top and bottom edges of the cards. The assemblies are anchored to the sheet steel side panels which are equipped with integral flanges for attaching the shelf to a 23-inch rack. The shelf backplane consists of an epoxy-glass printed circuit board and associated connectors. The section [Control Shelf Backplanes](#) describes the control shelf backplane.

The control frame can also contain up to two extension shelves. Each extension shelf can accommodate up to 16 Link Interface Modules (**LIMs**) or E5 Interface Modules, E5-TSM Modules, E5-SLAN Modules, E5-STC Modules or E5-MCPM-B Modules in any combination; except for those locations dedicated to the HIPR2 and **MAS** cards. All cards can be inserted in any card location.

E5-SM (E5-SMxG/E5-SMxG-B) cards are only configured in available odd numbered slots, and require two card slots.

Figure 3-15 Control Shelf Front with Card

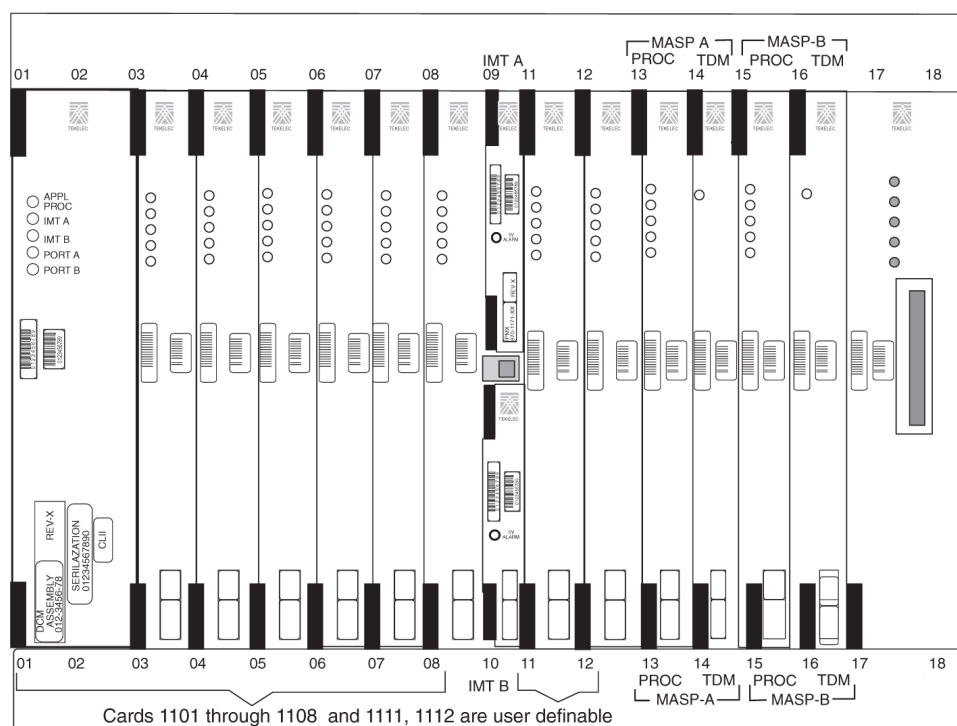

Control Shelf Backplanes

This section describes the control shelf backplanes (P/N 850-0330-03/04/06/07 and 7333412), all can be used in EAGLE systems.

Note:

Control Shelf Backplane can be used with the HIPR2 in the EAGLE system with minor modifications and the addition of adapter cable (P/N 830-1185-01). See "Hardware Baseline Table" in *Release Notes* for compatible control shelf and extension backplane part numbers. The adapter cable is not necessary for customers not wanting high speed links.

Note:

The clocking and fan control signals used to support extension frames 6 and 7 are eliminated in the 850-0330-06 version and later of the **Control Shelf** Backplane because those frames are no longer supported in the EAGLE system.

The control shelf backplane provides connectors for the system circuit cards. These connectors are four column High Density Interconnect (**HDI**) male headers with shrouds of varying pin quantities, depending on card position.

- **LIM**, **E5-ENET**, and **E5-E1T1** cards can be used in slots 1, 2, 3, 4, 5, 6, 7, 8, 11, and 12.

- HIPR2 cards are connected in slots 9 and 10.

 **Note:**

HIPR2 cards are installed at the factory or by Technical Support and are not installed by customers.

- The **HCMIM** and E5-SM4G cards, used in EAGLE systems, are mounted only in available odd numbered slots 1, 3, 5, 7, and 11.

 **Note:**

The E5-SM4G may also be mounted in available odd numbered slots 1, 3, 5, 7, 11, 13, 15, and 17 in the extension shelf.

 **Note:**

Throughout this document, the term E5-SM4G refers to both the E5-SM4G (P/N 870-2860-xx) and the E5-SM8G-B (P/N 870-2990-xx) cards unless specifically noted otherwise.

The control shelf backplane provides –48VDC power and ground to all card positions. The power is distributed into two parts, A and B. Power is brought to the shelf from the Fuse and **Alarm Panel (FAP)** using two cables. The connectors on the control shelf backplane are **DB-26** high density connectors. The power is distributed over two separate pins per power connection to handle the current load. The current capacity of the connector pins is 1.5A per pin for a total of 3A per pair. *Installation Guide* tables list the shelf location, card type, and fuse location in the fuse and alarm panel for the control shelf backplane.

 **Note:**

Cards that are provisioned in redundant pairs must be on separate power buses. This provides backup processing capabilities with the loss of either the A or B power buses. All **MASP** and HIPR2 cards are provisioned in pairs and are redundantly powered from separate power buses.

The control shelf power connectors are designated as:

- J1 (B Power) and J4 (A Power) on control shelf backplane (P/N 850-0330-04)
- J1 (B Power Primary) and J2 (B Power secondary) J11 (A Power primary) and J10 (A Power Secondary) on control shelf backplane (P/N 850-0330-06/07 and 7333412).

 **Caution:**

Disconnect both Input and supply sources when repairs require removal of power. This will take the system down.

Note:

Control Shelf Backplane (P/N 850-0330-03/04) can be used with the HIPR2 in the EAGLE system with minor modifications and the addition of adapter cable (P/N 830-1185-01).

The following figures depict the rear connector view of control shelf backplane (P/N 850-0330-03/04/06/07 or 7333412).

Figure 3-16 Control Shelf Backplane (P/N 850-0330-03/04)

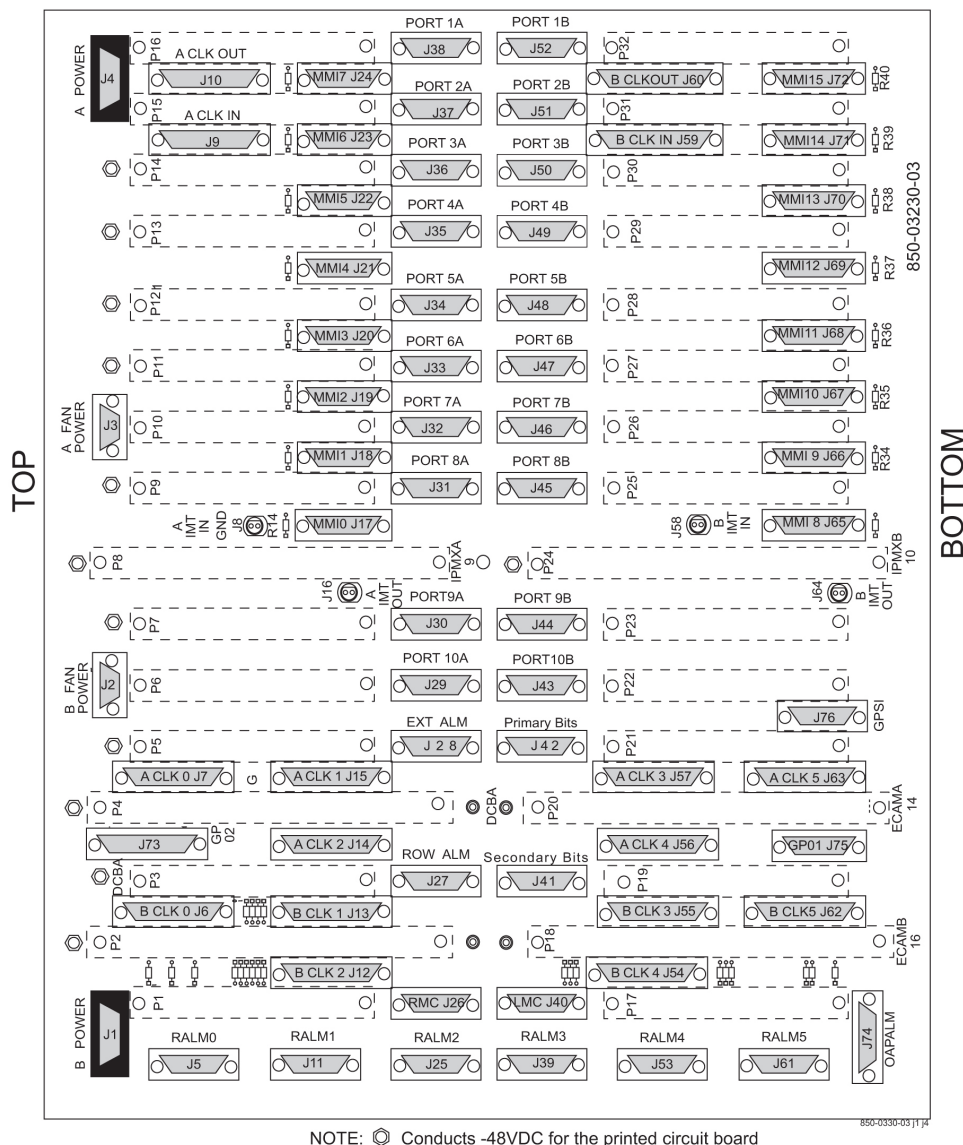
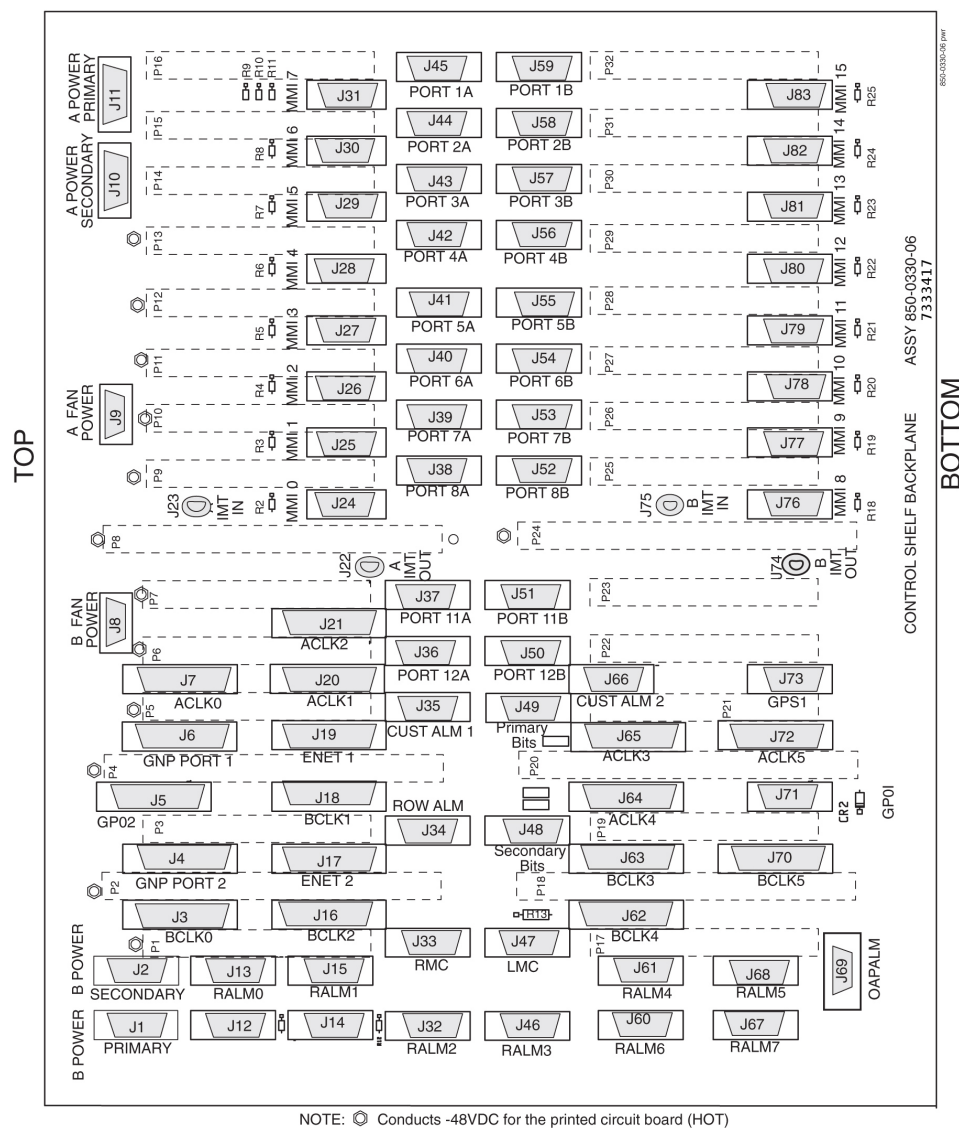

Figure 3-17 Control Shelf Backplane (P/N 850-0330-06/07 or 7333412)



Extension Shelf

The extension shelf provides the mounting space for up to 16 **Link Interface Modules (LIMs)**, E5 Interface Modules, E5-TSM Modules, E5-SLAN Modules, E5-STC Modules or E5-MCPM-B Modules and E5-SM (E5-SMxG/E5-SMxG-B) cards (mounted in odd numbered slots, requiring two slots).

 **Note:**

HIPR2 and **HIPR** cards are installed at the factory or by Technical Support and are not installed by customers.

Figure 3-18 Extension Shelf with LIMs

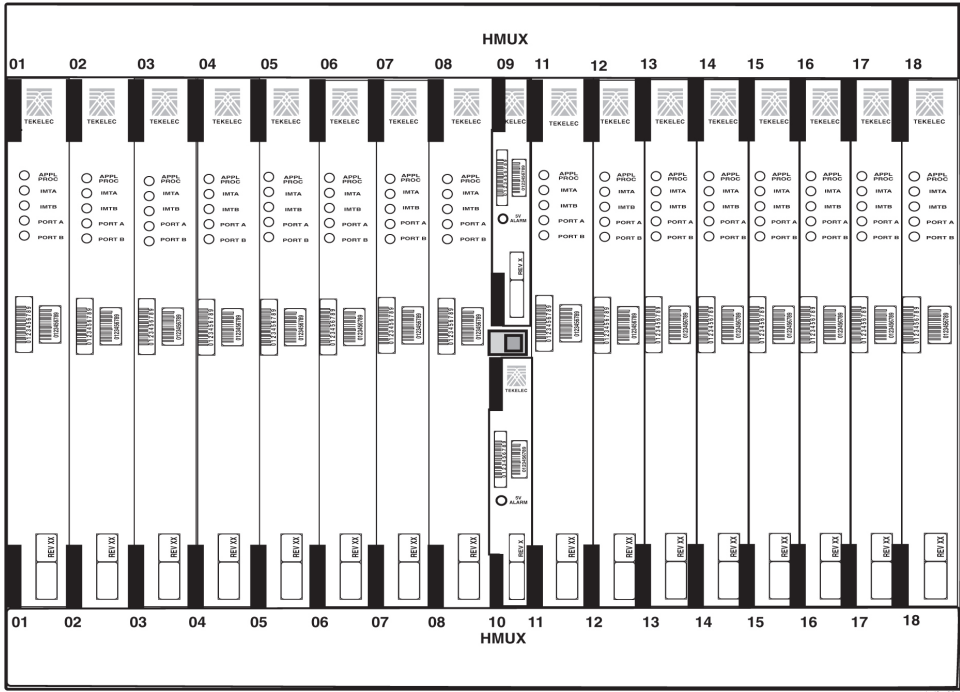

contshel x 22

Figure 3-19 Shelves with DCM and LIM Cards in Control Frame

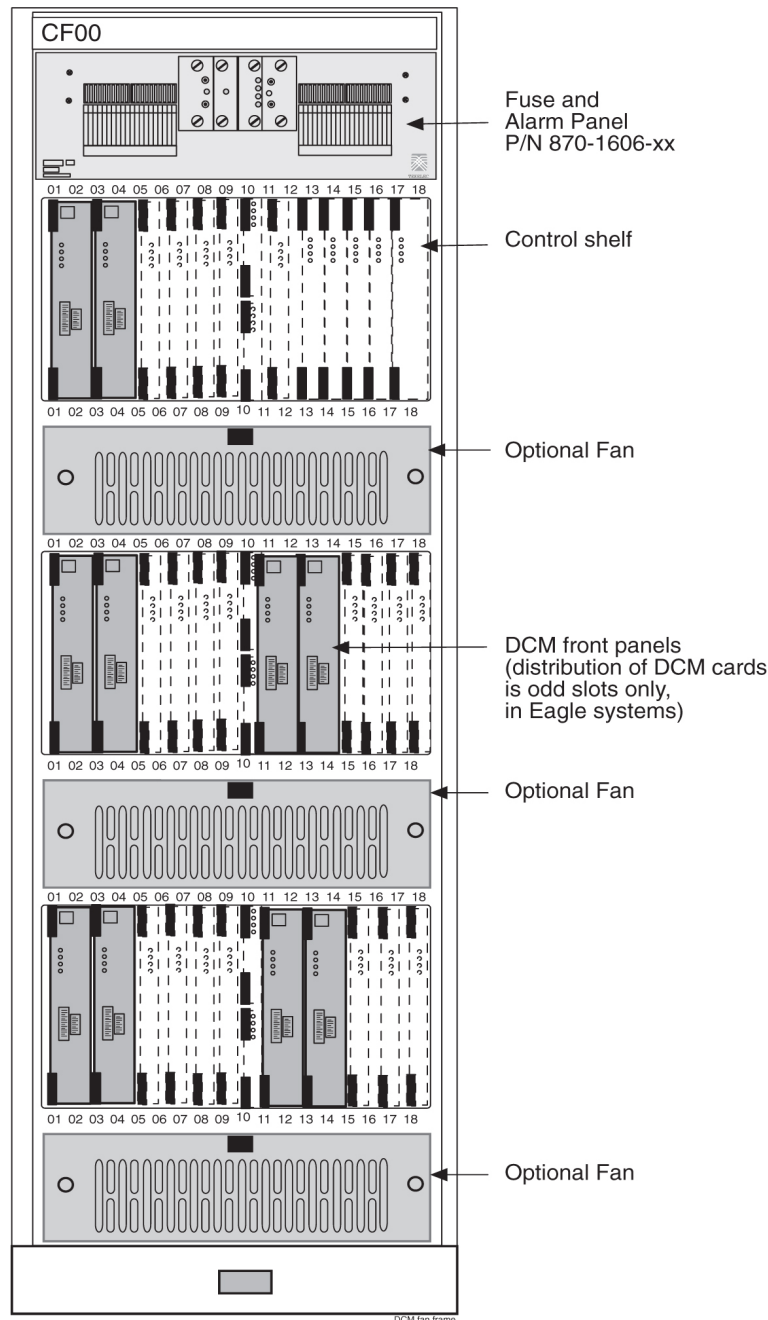

The extension shelf consists of die-formed top and bottom assemblies with die-formed channel slots to accept the top and bottom edges of the cards. The assemblies are anchored to the side panels which are equipped with integral flanges for attaching the shelf to a 23-inch rack in a 26-inch frame. The shelf backplane consists of an epoxy-glass printed circuit board and associated connectors.

The extension shelf backplane is shown in the figure for the [Extension Shelf Backplanes](#). Each card is equipped with a power converter that takes the -48VDC input from the backplane and converts it to $+5\text{VDC}$ and/or $+3\text{VDC}$.

Extension Shelf Backplanes

This section discusses the technical aspects of the extension shelf backplanes (P/N 850-0356-03/04/06 and 7333417) and the extension shelf backplanes (P/N 850-0356-01/02) used in the system.

The extension shelf backplane provides connectors for 18 circuit cards. These connectors are four column High Density Interconnect (**HDI**) male headers with shrouds of varying pin quantities depending on card position. The reverse or component side of the backplane contains **DB** style connectors for interfacing to the rest of the system. The extension shelf backplane provides shielding on all of the interface connectors to prevent Radio Frequency Interference (**RFI**).

Power Distribution

Caution:

This is a redundant system to allow service during normal maintenance. When repairs require a total power disconnect both input supply sources must be disconnected. This will cause service interruption and take down the system.

The extension shelf backplane provides –48VDC power and return to all card positions. The power is divided into parts A and B and brought to the shelf from the Fuse and **Alarm** Panel (**FAP**) using two cables (P/N 830-0315-xx). The power connectors on the extension shelf backplane are **DB-26** high density connectors with two pins per power connection to handle the current load. The current capacity of the connector pins is 1.5A per pin for a total of 3A per pair. The extension shelf primary power connectors are designated as J4 and J1, and the secondary power connection are on backplane (P/N 850-0356-03/04/06 and 7333417) are J45 and J46 secondary.

In *Installation Guide*, tables list the shelf location, card type, and fuse location in the fuse and alarm panel for the extension shelf backplane.

Note:

Cards that are provisioned in redundant pairs must be on separate power buses. This provides backup processing capabilities with the loss of either A or B buses.

Interface Connectors

Behind each slot on the extension shelf backplane are two **DB-26** connectors. These provide connection to the outside world in the form of **TCP/IP** networks, **SS7** links, or **X.25** networks. The interface connectors are designated as J9 through J40.

System Clock Connectors

Each extension shelf receives and passes along Clock signals A (J5 and J6) and B (J41 and J42).

Locating the EAGLE System Number

The Oracle Communications EAGLE System number is printed on a label affixed to the outside of an EAGLE frame. The number begins with either an NT or TA number.

The following figures provide examples of the label placement:

Figure 3-20 EAGLE System Number Frame View

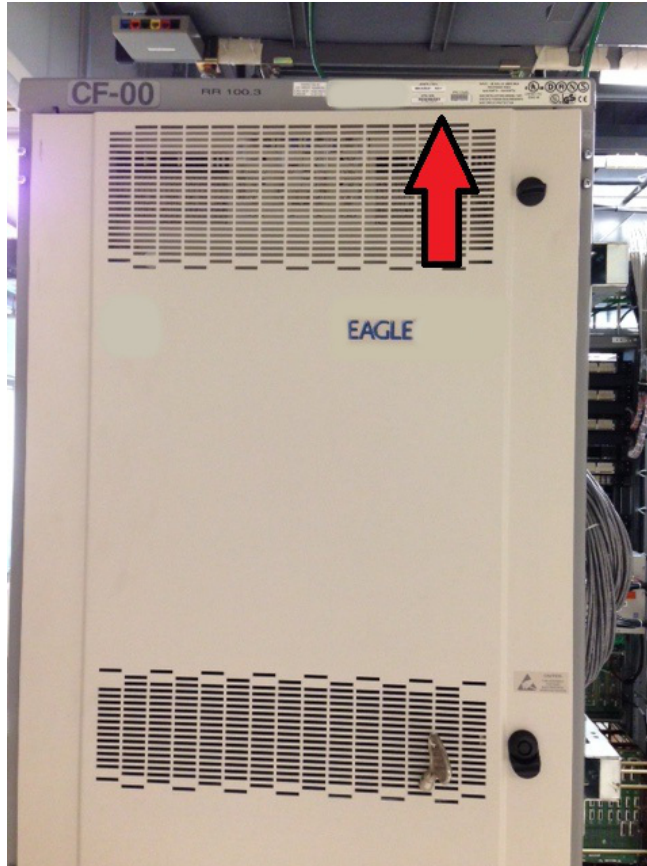

Figure 3-21 EAGLE System Number Medium View

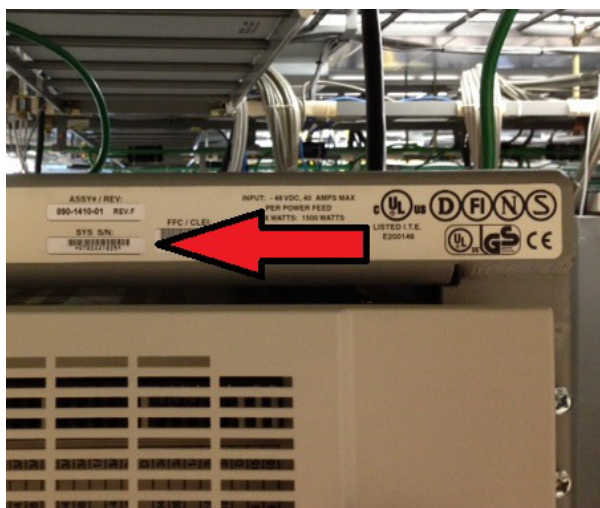
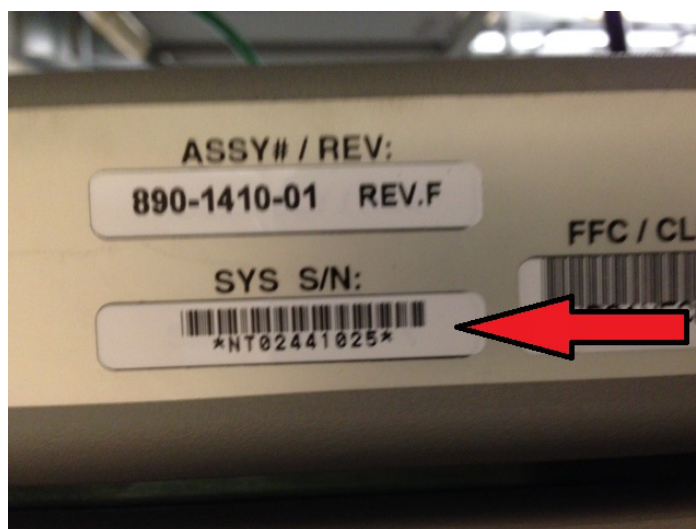

Figure 3-22 EAGLE System Number Close View



Modules

The EAGLE frames are configured with card modules (also known as “cards”) that provide specific functions and services. Cards are connected to the shelf backplane through connectors located on the rear of the card. See *Installation Guide, Cable and Adapter Use* for additional information about individual card adapters and cabling requirements.

Cam-out/lock-in levers, mounted on the front edge of the card, assist in insertion and removal of the card. Part numbers, LEDs, and tables are also located on the front of the cards.

Note:

To remove a card use both hands to toggle the levers out from the face of the card. To insert a card, align the card in the slot, push slowly in until the connectors engage and press both levers in until they lock the card in place. To ensure proper seating, the toggle levers must be held in the release position until the locking tabs can engage the upper and lower flange on the shelf. Once the locking tabs on the levers engage the shelf plane, the levers are pressed in toward the card faceplate, and must be flush with the faceplate when the card is completely seated.

Figure 3-23 Cam-Out/Lock-In Levers on Cards

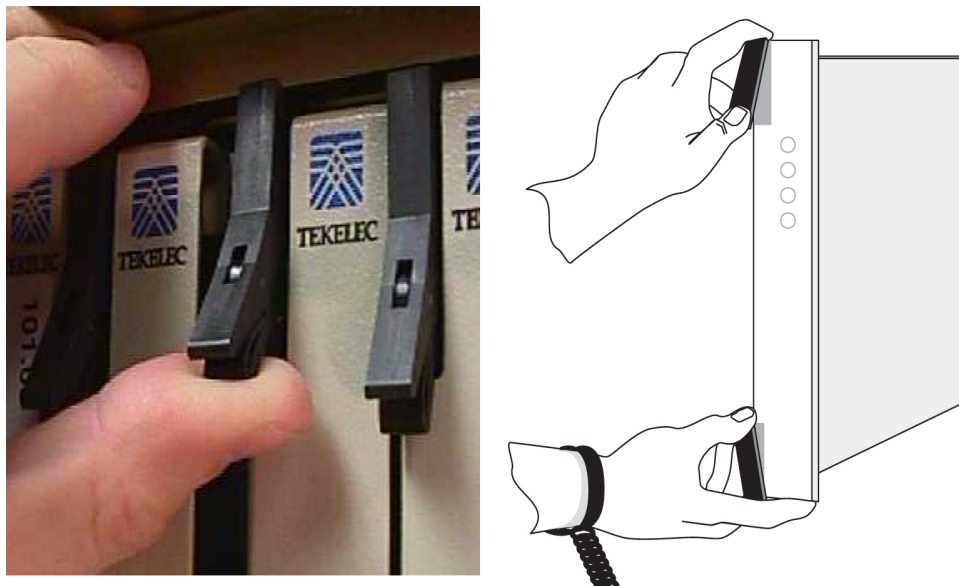

The modules used in the system are:

- [High Speed IMT Packet Router 2 \(HIPR2\)](#)

Note:

The HIPR2 card is installed by the factory for initial frame shipments or subsequent extension frame shipments. The HIPR2 card is a customer replaceable unit. If the IMT interface cables need to be replaced to support the higher 2.5 Gbps rate, contact Oracle Service to arrange for IMT cable replacement.

- [E5 Maintenance and Administration Subsystem Processor \(E5-MASP\) Card](#)
- [E5-MDAL](#)
- [Link Interface Modules \(LIM\)](#)
- [Signaling Transport Card](#)
- [#unique_71 \(HCMIM\)](#)

- E5-ATM-B Module
- E5-E1T1-B Module
- E5-ENET-B Module
- SLIC
- E5-MCPM-B Module
- E5-SM8G-B Module
- #unique_78
- Air Management Card
- Fan Tray

 **Note:**

See "Hardware Baseline Table" in *Release Notes* for compatible card part numbers.

The following table summarizes the environmental specifications common to all EAGLE cards. Other technical specifications are listed with the individual card types.

Table 3-1 Card Specifications

Operating Environment	
Operating temperature	+ 41° F to + 104° F + 5° C to + 40° C
Relative Humidity	5% to 85%
Altitude	–200 ft. to +13,000 ft. (–61 m to +3962 m)

 **Note:**

For ambient temperatures above 95° Fahrenheit, relative humidity must be less than 80 percent. At the short-term emergency condition of 120° Fahrenheit, the relative humidity must be below 20 percent.

 **Note:**

HIPR2 is fully NEBS compliant. However, if ambient temperatures above 40° C are likely, EAGLE Fan Trays are recommended to ensure proper airflow to the upper HIPR2 cards in those shelves.

High Speed IMT Packet Router 2

The High-Speed IMT Packet Router 2 provides enhanced capabilities by changes in bus architecture and increased packet processing (routing) capabilities, HIPR2 interfaces and operates with the high speed Fibre channel ring to provide the EAGLE system with increased inter-shelf bus (FC) bandwidth operating at 2.5 Gbps.

Traffic between EAGLE cards on the same shelf will be switched directly to the destination slot and will not transit any other cards in the shelf. Traffic between shelves is not required to pass onto an intra-shelf IMT channel if it is not necessary.

All shelves within an EAGLE node must be equipped with HIPR2.

HIPR2 feature overview:

- Requires control shelf and extension shelf backplanes that support HIPR2 and later IMT components.
- Two (2) HIPR2 cards are required in a shelf with up to a total of 32 for the system.
- Switched architecture.
- The ability to BIP the HIPR2 card reporting within the HIPR2 card.
- One IMT bit rate possible:
 - 2.5 Gbps requires that all shelves within EAGLE be equipped with HIPR2 and IMT interface cables upgraded to support new high-speed Fibre-channel.
- Re-programmable and ungradable in the field via software release.
- Fault Tolerance - Errors occurring on a switched slot do not bring down the inter-shelf IMT ring nor affect any other switched slot on its shelf.
- Does not require a fan tray assembly for thermal management.

 **Note:**

HIPR2 is fully NEBS compliant. However, if ambient temperatures above 40° C are likely, EAGLE Fan Trays are recommended to ensure proper airflow to the upper HIPR2 cards in those shelves. See "Hardware Baseline Table" in *Release Notes* for compatible card and fan tray part numbers.

Switched Architecture

The inter-shelf ring connects the shelves together and HIPR2 acts as a gateway between the intra-shelf IMT bus, running at 125 Mbps, and the inter-shelf Fibre channel ring operating at a high rate (2.5 Gbps). HIPR2 retains the high speed 1Gb Fibre Channel ring as a way to ensure interoperability with other HIPR2 equipped shelves. After HIPR2 recognizes that data from the high speed ring is destined for its shelf address, the data is immediately switched to the correct card within the shelf rather than traversing the intra-shelf IMT bus, running at 125 Mbps. The HIPR2 allows more bandwidth than in the HMUX-based ring architecture.

As shown in [Figure 3-24](#), in a same topology where all HIPR2 is used in an EAGLE the Fibre channel ring runs at either the low or high speed.

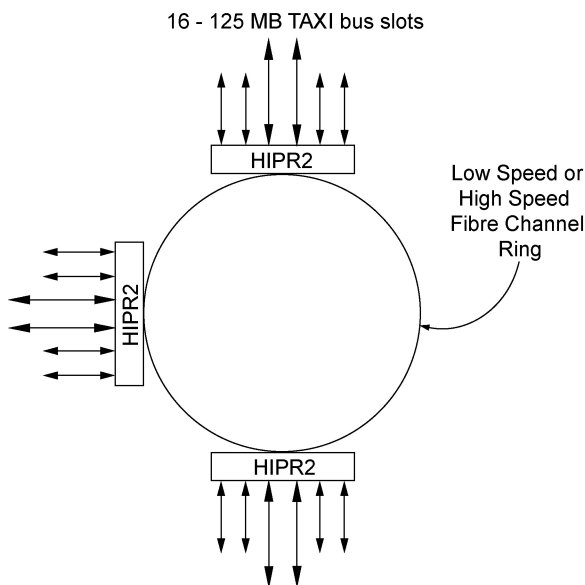
Figure 3-24 HIPR2 Switch Same Topology

The switched interface to each card is at 125 Mbps, the same speed as the intra-shelf IMT bus. This switched architecture has an inherent reliability advantage of point to point connections within the shelf. A ring can be broken, potentially causing all cards on the ring to be affected. However, a switched architecture automatically isolates a problem to a specific data path which immediately determines which card is experiencing problems. Trouble shooting and debugging are greatly enhanced. For example, corrupted packets can be isolated quickly because there is only a single path per card rather the multiple paths possible in a ring.

All routing decisions are controlled by the network processor on the HIPR2 card. A core processor performs the switching function. This allows future upgrades without changes to the hardware.

Upgrade Considerations

The HIPR2 card is compatible with the obsoleted HIPR card slot and can be fielded with any version of either the control or extension backplanes compatible with the obsoleted HMUX. One bus is taken out of service and upgraded to HIPR2s and then brought back online. This upgrade cycle is repeated on the second bus to get both busses upgraded. HIPR2 interfaces and operates with all the same cards that HIPR had been used with.

Two HIPR2 modules are required in shelves equipped with high-performance LIMs, such as the High-Capacity MIM, and for interfacing to application servers (such as the Tekelec 1x00 series of Application Servers) through IMT Bridge and IMT PCI modules. HIPR2 requires all other shelves be equipped with either all HIPR2 cards. High-rate (2.5 Gbps) operation requires that all shelves within EAGLE be equipped with HIPR2, IMT interface cables upgraded to support new high-speed Fibre-channel, and a system FAK installed to allow the high-rate channel.

LEDs

On the front edge of the HIPR2 card, there are four Light Emitting Diodes (LED) that provide status. Each LED has a red, green, or amber illumination state. The RATE LED indicates the IMT bus condition. The ALIGN LED indicates code initialization and programming status. The

SHELF LED indicates HIPR2 running and shelf ID address condition. The PROC LED indicates state of the HIPR2 processor.

Figure 3-25 summarizes the use of the front-panel LEDs.

Figure 3-25 HIPR2 LEDs

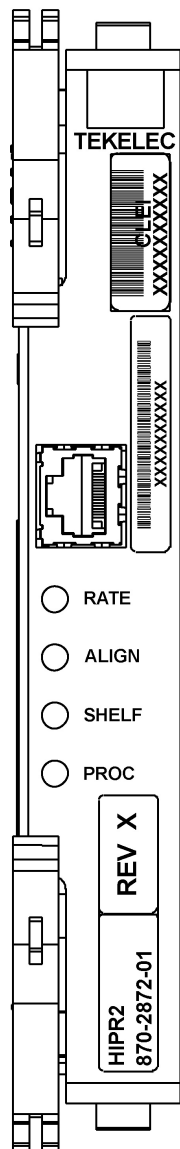

HIPR2 State	LED			
	RATE	ALIGN	SHELF	PROC
No power	Off	Off	Off	Off
Power on (cold start)	Off	Off	Off	RED
Reset (warm start)	Off	Off	AMBER	RED
Programming (cold start)	Off	Off	Off	AMBER
Programming (warm start)	Off	Off	AMBER	AMBER
Programming Complete	---	AMBER	AMBER	GREEN
Shelf Address Capture:				
Timer Started	---	AMBER	AMBER	GREEN
Successful	---	GREEN	AMBER	GREEN
Unsuccessful	---	RED	AMBER	GREEN
Code Running	---	GREEN	Note 2	GREEN
IMT is operational at:				
low-rate (1 Gbps)	GREEN			
high-rate (2.5 Gbps)	GREEN			
	Blinking			
IMT is rate negotiating or in proving period	AMBER			
IMT is not operational	RED			

Notes:

- ALIGN and SHELF LEDs are not accessible to software until the FPGA has been programmed. So for the same point in the HIPR bootstrap sequence, the state of these two LEDs can be different depending on whether a warm or cold start is in progress.
- State depends on the address received from OAM and written to Assigned Shelf Address Register and compared to the value previously read from the Assigned Shelf Address Register.
 - RED - Does Not Match
 - GREEN - Matches

Cabling

As of Release 46.4, the EAGLE will only operate at the HIPR2 card high rate (2.5 Gbps). High-speed Fibre-channel cables (P/N 830-1344-XX, length dependent upon site requirements) must replace existing cables (P/N 830-1141-xx/830-0221-xx) in order for HIPR2 high-rate operation and Release 46.4 compatibility.

Technical Specifications

Table 3-2 HIPR2 Technical Specifications

Physical Characteristics	
Height	7.7 in. (18.3 cm)
Width	1.8 in. (2 cm)
Depth	12.8 in. (32.5 cm)

E5 Maintenance and Administration Subsystem Processor (E5-MASP) Card

The **Maintenance and Administration Subsystem Processor (E5-MASP)** cards contain all of the necessary logic to perform both application and communication processing of the data streams provided by the EAGLE. The cards provide connections to the IMT bus through the backplane and all of the necessary logic to perform both application and communication processing of the data streams through the EAGLE. The E5-MASP cards contains one fixed drive and USB connectors for two removable drives.

Requirements and Dependencies

The E5-MASP has the following requirements and dependencies:

- Requires an E5-MDAL in the control shelf.
- Requires HIPR2 to be active on both IMT buses in the control shelf.

Note:

HIPR2 requires all other shelves to be equipped with all HIPR2 cards.

- The E5-MASP operates in backplanes 850-0330-03, 850-0330-04, 050-0330-06, 850-0330-07, or 7333412. See "Hardware Baseline Table" in *Release Notes* for compatible backplane part numbers.
- Does not require a fan tray assembly for thermal management.

The E5-MASP card is a single dual-card assembly of the E5-MCAP card mated to an E5-TDM card. The E5-MASP is a dual-slot card that occupies slots 1113/1114 and 1115/1116 in an EAGLE Control Shelf. The E5-MASP card must be used with the E5-MDAL card. See [Figure 3-26](#).

Figure 3-26 E5-MASP Card -01

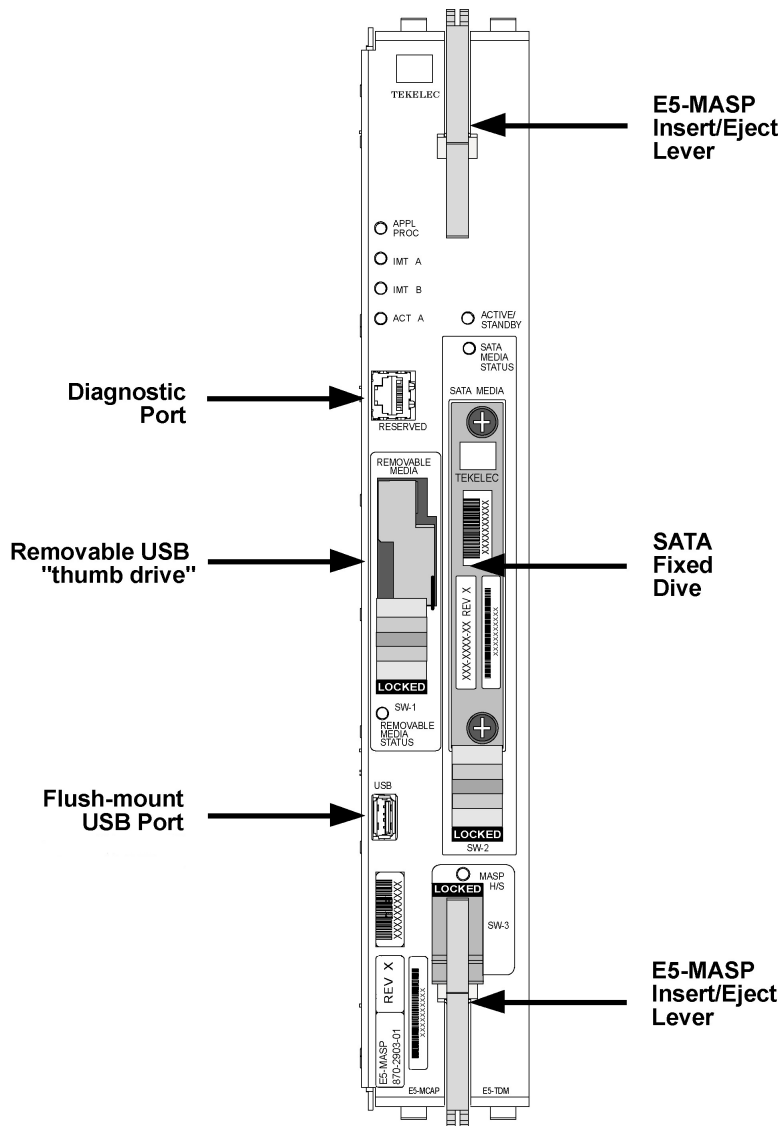

The -02 E5-MASP card has different hardware than the E5-MASP -01 card.

Figure 3-27 E5-MASP Card -02

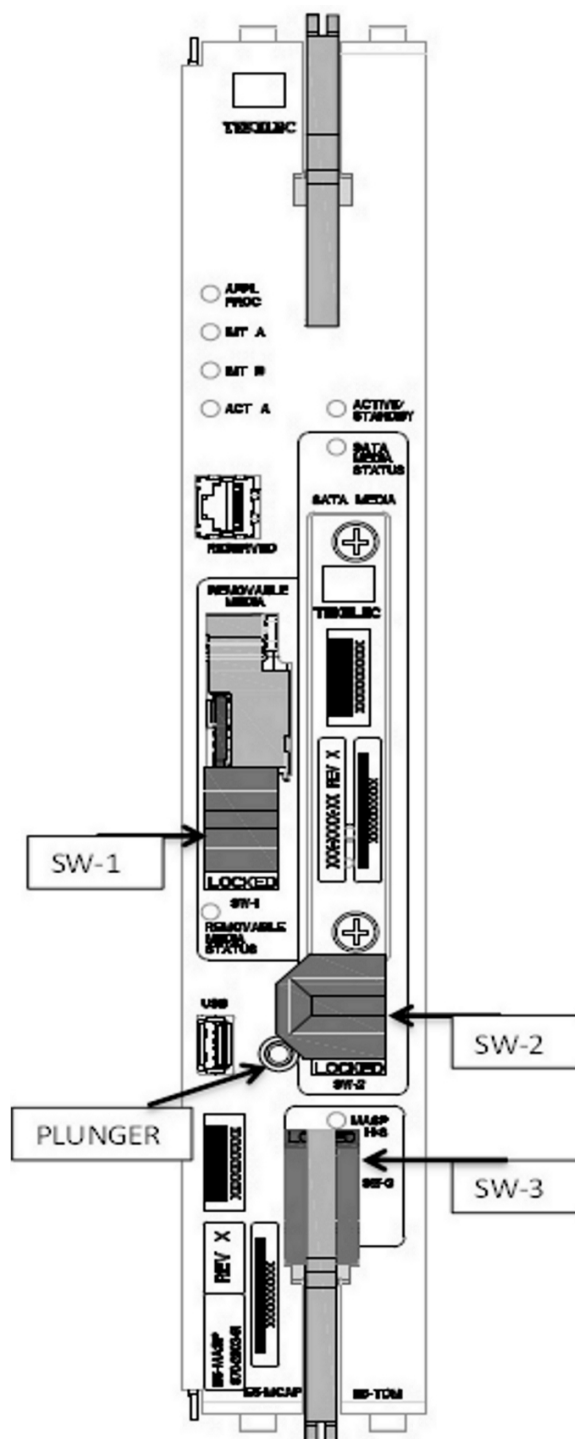

SW-1: Used to activate or de-activate Removable USB "thumb drive." The locked position activates the switch.

SW-2: Used to activate or de-activate hard drive. The locked position activated hard drive. The plunger must be depressed before the switch can be unlocked, which de-activates hard drive.

SW-3: Used to activate or de-activate the card and lock or unlock the lower E5-MASP Insert/Eject lever. The locked position activates the card and locks the lever.

E5-MCAP

The E5-MCAP card is equipped with 4 GB of physical application processor memory. The primary data interface to the E5-MCAP is RS-232 interfaces (i.e.: terminals) through the E5-TDM.

The E5-MCAP card contains one **latched USB port** for use with removable flash media (“thumb drive”), and one flush-mounted USB port for use with a plug-in flash drive. The removable media drive is used to install and back up customer data. The flush-mounted USB port is used for upgrade and could be used for disaster recovery. The removable flash media is used as a replacement for the legacy Magneto-Optic (MO) Drive. The E5-MCAP card is a replacement for the obsoleted legacy GPSM-II card used for the **MCAP** function.

E5-TDM

The **E5-TDM** card contains four major subsystems: the Terminal Processor Subsystem, the System Clock/Control Subsystem, the SATA Subsystem, and a Power Subsystem. These subsystems provide the EAGLE 5 with 16 user-accessible terminals, distributes Composite Clocks and High Speed Master clocks throughout the EAGLE 5, distributes Shelf ID to the EAGLE 5, and disk storage for an E5-MCAP card. The E5-TDM card provides an interface to the E5-MDAL card for system alarms.

The E5-TDM card contains one fixed solid-state SATA drive that is removable and used to store primary and backup system databases, measurements, and Generic Program Loads (GPLs).

E5-TDM Functions

The E5-TDM provides the following functions for the EAGLE.

- [System Clock Interface](#)
- [Time Slot Counter \(TSC\) Synchronization](#)
- [Master/Slave Control](#)
- [Alarm Interface](#)
- [Shelf ID UART Interface](#)

System Clock Interface

The primary purpose of the Clock LCA is to derive and/or distribute the system clocks for the EAGLE. There are two system clock outputs: the TEKCC clock and high-speed E1/T1 clock. The external clock sources are a BITS or composite clock input, a high-speed E1/T1 clock input, and a derivation of an E1/T1 clock generated on the E5-TDM. The terminal processor on the E5-TDM selects which source clock is used to derive and/or distribute the system clocks. Each external source has a primary and secondary that is received, verified and validated. The E5-TDM automatically switches the clock source between the primary and the secondary if the current source fails validation.

The BITS or composite clock is used to generate the TEKCC clock output. The high-speed clock input is distributed via the high-speed clock output. The terminal processor can force a switch of the system clock source between the primary and secondary clocks, or select the local oscillator as the system clock source. The local oscillator only generates a TEKCC output. It

cannot generate a high-speed E1/T1 clock output. Therefore, if the terminal processor selects the local clock and there is no high-speed clock input present, there will be no high-speed clock output.

The terminal processor can also select to derive the system clocks internally on the E5-TDM. This is known as the Global Timing Interface. A customer needs only to have an E1/T1 data stream as input to the E5-TDM. The E5-TDM will generate and distribute the TEKCC and high-speed E1/T1 clocks to the system.

Time Slot Counter (TSC) Synchronization

The Time Slot Counter (TSC) Synchronization feature is an advanced function enabled in all LIMs. The TSC Synchronization feature does not require any physical hardware changes to any of the boards in the EAGLE. TSC Synchronization is an optional feature for the EAGLE that will allow all cards in the system, which contain a Time Slot Counter, to synchronize with one another. The ability to have synchronized timing between cards is used in applications such as system wide message time stamping.

The TEKCC output includes Time Slot Synchronization information. In the EAGLE system, it is possible for the occurrence of the TSC Sync pulse to differ in time between the Active and the Standby E5-TDM. This difference is known as TSC skew. This skew must be detected and eliminated so that cards can switch between the two clocks and stay synchronized to the rest of the system. In the E5-TDM, the elimination of TSC skew is accomplished in hardware, a LIM card does not detect TSC skew. If skew occurs, hardware detects and corrects this and alerts the system that this condition has occurred.

TSC Sync affects all EAGLE cards that contain a Time Slot Counter. This includes:

- HCMIM, E5-E1T1, E5-E1T1-B, E5-ENET, E5-ATM

Master/Slave Control

The terminal processor can switch the status of the E5-TDM card from master to standby modes. The terminal processor can determine the state of the E5-TDM (active or standby) and can also force a switchover from active to standby.

Alarm Interface

The Alarm Interface gives the terminal processor visibility to E5-MDAL Alarms, External Alarms, and Customer Alarms. The interface is split into two parts: the terminal processor interface and the physical interface. The terminal processor interface contains registers to update E5-MDAL alarms and status registers to read E5-MDAL alarms. It also contains external and customer alarm registers.

The physical interface is made up of a bidirectional I2C interface to the E5-MDAL and direct connection to opto-isolator outputs for external and customer alarms. The physical interface provides input data to the registers which the terminal processor can read. The physical interface also provides a way for the E5-MDAL alarm update data to be sent to the E5-MDAL.

Shelf ID UART Interface

The Clock LCA implements a 9-bit UART, which is used to transmit Shelf ID information to each EAGLE shelf. The terminal processor selects which shelf to transmit the information.

Thermal Management

The E5-MASP provides thermal management and alarming provisions to protect the card from damage due to overheating. The E5-MASP contains a thermal monitor with software selectable

thresholds for temperature abnormal levels. Threshold crossings generate alarms and impair card operations. These alarms require the mitigation of the temperature rise to resume normal card operations interrupted by the threshold crossings. The E5-MASP is designed to operate in the EAGLE shelf with natural convection cooling and does not require a fan tray for cooling.

Table 3-3 Thermal Alarm Conditions

Board Temperature	E5-MASP Actions
Temp Level 1 Exceeded	Major alarm raised
Temp Level 2 Exceeded	Critical alarm raised; the application software responds to the notification by either preventing database updates or failing over to the standby
Temperature abated	Application re-allows database updates; Normal operation restored
Thermtrip - shutdown temperature exceeded	CPU shuts down automatically. Card must be reseated to restore operation once temperature returns to normal operating conditions

Switches and LEDs

The E5-MASP card provides faceplate switch interfaces for the removable drive (SW1), the fixed SATA drive (SW2), and the card (SW3). Each switch is used to notify software that the corresponding item is about to be unplugged or is plugged in and ready for use. Software may use this signal to gracefully shut down the card. An associated LED for each corresponding item indicates when it is safe to remove the item.

The E5-MASP card has six LEDs visible on the front of the card.

[Figure 3-28](#) shows the LED status and description.

Figure 3-28 E5-MASP LEDs

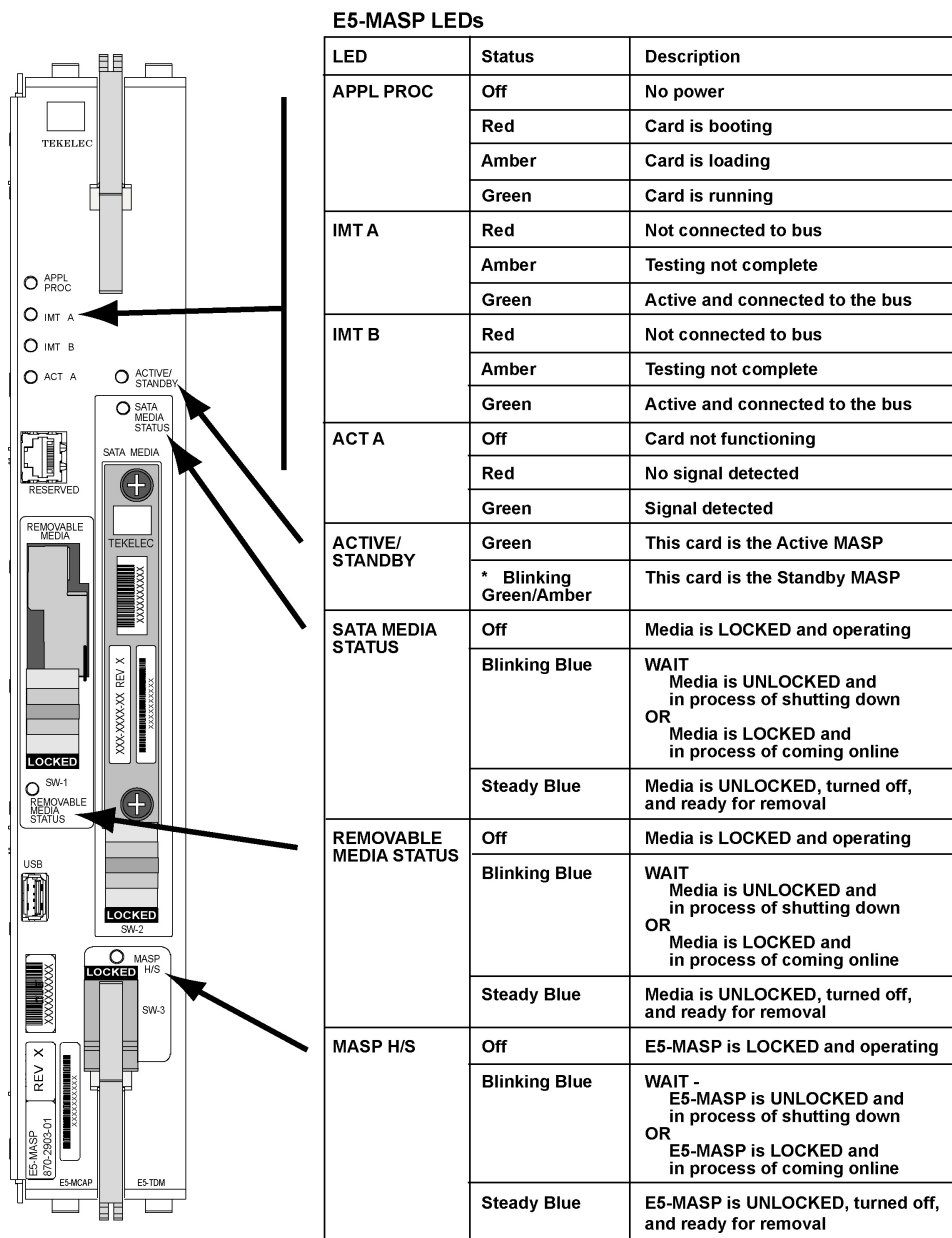

* The LED blinks Green/Amber at a rate of 3 Green to 1 Amber.

Cabling and Technical Specifications

The E5-MASP card utilizes an RS-232 cable for manufacturing and customer service installation diagnostics. The cable part number is 830-1327-XX.

Table 3-4 E5-MASP Technical Specifications

Physical Characteristics	
Height	14.43 in. (36.65 cm)

Table 3-4 (Cont.) E5-MASP Technical Specifications

Physical Characteristics	
Width	2.06 in. (5.23 cm)
Depth	12.80 in. (32.51 cm)

E5-MDAL

The **E5-MDAL** card processes alarm requests, provides general purpose relays, and provides fan control. There is only one **E5-MDAL** card in a control card set and it is shared between two **E5-MASP** cards. The E5-MDAL card is located in slots 1117 and 1118 of the control shelf.

Critical, major and minor system alarms are provided for up to 6 individual racks. In addition to the 3 system alarms, the E5-MDAL card provides the system audible alarm. All alarms are software controlled.

The E5-MDAL card provides control of fans on a per frame basis. The control logic allows for each fan relay to be set individually.

The **E5-MDAL** card does not contain a disk drive.

Alarms

Alarms are grouped into four categories: Rack, Remote Maintenance Center (RMC), Local Maintenance Center (LMC), and the Row End Panel. Critical, major and minor system alarms are provided for up to 6 individual racks. In addition to the 3 system alarms, the E5-MDAL card provides the system audible alarm. All alarms are software controlled.

Relays on the E5-MDAL provide switching for all of the alarm circuits. Regardless of which E5-MASP is master, the current state of the relays is read by both TDM_A and TDM_B alarm buses on the E5-MDAL. General Purpose Relays reset signals have not been carried over from the obsoleted legacy MDAL to the E5-MDAL. Critical relays are wired such that they are in the alarming state when the E5-MDAL is not powered.

Alarm indicator lights are provided in the Row End Panel, Fuse Panels, and E5-MDAL Card panel. The major and minor alarms are only active if there is a request from the E5-MASP and the E5-MDAL indicates that at least one of the E5-MASPs is sane. A critical alarm is generated if there is a request from the E5-MASP or the E5-MDAL card indicates that both E5-MASPs are insane or the E5-MDAL card loses power. The RMC signals are gated by the AlarmTransfer signals from the master E5-MASP. When the AlarmTransfer signal is active, the RMC signals are set to the output relays. When the AlarmTransfer signal is inactive, the RMC alarm signals are blocked. Optocouplers on the RMC alarms sense current when the alarms are active. If the alarm is active and there is no current sensed then it is assumed that the bulb/led on the row end panel is either burned out or missing.

Fan Control

The E5-MDAL card provides control of fans on a per frame basis. The control logic allows for each fan relay to be set individually. There are relays to control fans on a per frame basis. The control logic allows for each fan relay to be set individually. On the legacy fan tray an open circuit turns the fans on. A control signal from the controller must be present to turn the fans off on the legacy fan tray. Fan control and alarm signals are routed through the Clock B cables to each shelf. Signals are then available on each backplane at the DB15 pin connector labeled A

Fan Power and B Fan Power. Optocouplers have been added to detect fan alarms on a per frame basis.

 **Note:**

The control logic allows the each optocoupler to be read individually.

LEDs

There are 5 bicolor LEDs on the E5-MDAL that are controlled by the software in the E5-MASP. The critical, major and minor system alarm LEDs have four states per LED, which can be set by the E5-MASP. They are not tied to the alarm logic and are completely under control of the E5-MASP software. The MASP A and MASP B LEDs indicate which E5-MASP is master. Located on the E5-MDAL is a Sonalert electronic audible device. The buzzer is activated if both E5-MASPs are insane or if there is sanity and a request is made by the master E5-MASP.

Figure 3-29 E5-MDAL LEDs

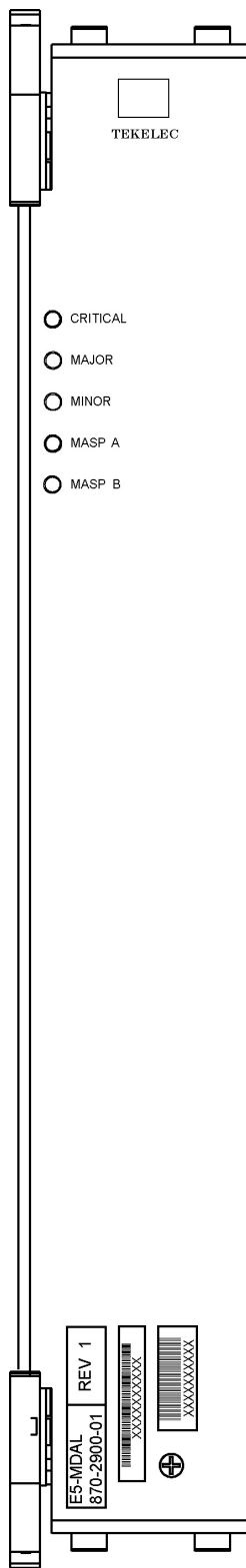

E5-MDAL LEDs

LED	Status	Description
CRITICAL	Red	A critical system alarm has been detected
	Green	No Alarm
MAJOR	Red	A major system alarm has been detected
	Green	No Alarm
MINOR	Amber	A minor system alarm has been detected
	Green	No Alarm
MASP A	Green	This is the master MASP
	Off	This is the standby MASP
MASP B	Green	This is the master MASP
	Off	This is the standby MASP

Technical Specifications

Table 3-5 E5-MDAL Technical Specifications

Physical Characteristics	
Height	14.43 in. (36.65 cm)
Width	2.06 in. (5.23 cm)
Depth	12.80 in. (32.51 cm)

Time Slot Counter Synchronization

The Time Slot Counter (**TSC**) Synchronization feature is an advanced function enabled in all **LIMs**. The **TSC** Synchronization feature does not require any physical hardware changes to any of the boards in the **EAGLE**. **TSC** Synchronization is an optional feature for the **EAGLE** that will allow all cards in the system, which contain a Time Slot Counter, to synchronize with one another. The ability to have synchronized timing between cards is used in applications such as system wide message time stamping.

The **TSC** Synchronization feature uses E5-OAM cards. The **EAGLE** must use an external **BITS** clock so that the system A and B clocks remain synchronous to each other. If either of the **TDMs** provides its internal clock to the system instead of the **BITS** clock, the A and B clocks may drift apart and introduce skew into the system.

After the **TSC** Sync feature is enabled there may be skew between the A clock and B clock **TSC** Reset Events. This skew must be detected and eliminated so that cards can switch between the two clocks and stay synchronized to the rest of the system. All cards with a **TSC** have a Skew Interrupt and the Skew Count register.

TSC Sync affects all **EAGLE** cards that contain a Time Slot Counter. This includes:

- **E5-E1T1-B, E5-ENET-B, SLIC**
- **E5-ATM-B**

Link Interface Modules

Caution:

After the frame has been shipped or moved, prior to applying power, remove all cards.

Caution:

Reset all cards carefully to avoid possible faulty connections. All cards are hot swappable

The **Link** Interface Module (**LIM**) provides access to remote **SS7**, **IP** and other network elements, such as a Signaling Control Point (**SCP**). The **LIMs** consist of a main assembly and

possibly, an interface applique board. These appliques provide level one and some level two functionality on **SS7** signaling links. The types of LIMs presently available are:

- E5-E1T1-B (P/N 870-2970-xx) cards.
- E5-ATM-B (P/N 870-2972-xx) cards.
- The E1/**T1** Multi-Channel Interface Module (MIM) (P/N 870-2198-02 and P/N 870-2198-01), provides a dual-port (A and B), framed, channelized connection to a customer's network. The interface to each port is mapped to the DS0 time-slots in the fractional E1 or T1 data streams. Each E1/T1MIM supports a maximum of eight High-Level Data Link Control (**HDLC**) channels that can be provisioned as using either E1 or T1 protocols and assigned to any unused time-slot.

 **Note:**

E1/T1MIM cards do not support internal clocking. E1/T1MIM cards must be provided with either a composite **BITS** clock or the High-Speed Master Timing clocks to function properly.

An extension port is provided to connect other boards in the EAGLE shelf to the E1/T1 data stream such that all channels can be mapped (E1 = 32 channels, T1 = 24 channels). This would require four E1/T1MIMs to map an entire E1 link or three E1/T1MIMs to map a T1 link. The two ports (1 and 2) can also be put into an **ADD/DROP** configuration. The E1/T1MIM would use a fractional part of the data channel connected to port 1 and forward the remaining channel data through port 2.

The E1/T1 MIM card requires a new cable T1MIMLIM (P/N 830-0894-xx) for T1 interface connections. If replacing existing MPL cards with E1/T1MIM cards the existing T1 interface cables (P/N 830-0772-xx) must be connected to T1LIM to MPL adapter cables (P/N 830-0895-xx) or replaced with the new cable (P/N 830-0894-xx).

The existing E1 interface cables (P/N 830-0622-xx) can continue to be used with the new E1/T1MIM card for E1 applications.

The E1/T1MIM will implement the **ANSIT1** standard for 1.544 MHz data transmission and the European (**ITU**) E1 standard for 2.048 **MHz** data transmission.

 **Note:**

Each E1/T1MIM port will be capable of operation for E1 or T1 line rates but the interfaces will never be mixed on a single circuit card (for example, one port operating at E1 rates and the other port at T1 rates). The E1/T1MIM does not support clear-channel (no channels) operation.

- LIM-**ATM** is a specialized LIM that provides one **Asynchronous Transfer Mode** over T1 Interface at 1.544 Mbps, (P/N 870-1293-xx). This module uses an Asynchronous Transfer Mode Applique (**AATM**) installed on a High Capacity Application Processor (HCAP or HCAP-T) main assembly.

Maximum Numbers of Links

A maximum of 2800 links can be configured in the EAGLE depending on the hardware, software release level, and features that are installed. A mixture of high-speed and low-speed signaling links is supported.

 **Note:**

If the addition of either a low-speed signaling link or a high-speed signaling link exceeds the total number of low-speed and high-speed signaling links allowed in the system, the `ent-slk` command is rejected. The addition of a high-speed signaling link decreases the number of low-speed signaling links that can be supported by the system.

Table 3-6 describes the required hardware for the maximum number of links with different configurations.

 **Note:**

Table 3-6 lists EAGLE base hardware requirements only. For complete provisioning rules and requirements, including tables listing all link types see *Database Administration - SS7 User's Guide*.

LIM Main Assembly**Table 3-6 Hardware Requirements-Maximum Number of Links**

Number of Links	Required Hardware
Up to 500 Links	HIPR2 cards on the IMT buses 2-port LIM cards or multi-port LIM cards (MPLs) Installed according to the provisioning rules for a system with up to 500 links in <i>Database Administration - SS7 User's Guide</i> .

 **Note:**

A Maximum of 42 High-speed LIM cards (of which up to 41 can be **IPLIMx** cards) can be installed

Table 3-6 (Cont.) Hardware Requirements-Maximum Number of Links





Number of Links	Required Hardware
From 501-700 Links	HIPR2 cards on the IMT buses
<p> Note:</p> <p>A Maximum 100 High-speed LIM cards (of which up to 41 can be IPLIMx cards) can be installed</p>	<p> Note:</p> <p>There are only enough slots to support 500 links using just 2-port LIMs.</p>
From 701--1500 Links	<ul style="list-style-type: none"> • HIPR2 cards on the IMT buses
<p> Note:</p> <p>A Maximum 115 High-speed LIM cards (of which up to 100 can be IPLIMx cards) can be installed</p>	<p> Note:</p> <p>There are only enough slots to support 500 links using just 2-port LIMs.</p>
	<p>Enough E5-E1T1-Bs to bring the total number of signaling links above 500, up to 700. Installed according to the provisioning rules for a system with 700 links in <i>Database Administration - SS7 User's Guide</i>.</p> <p>Enough multi-port LIMs (MPLs), P/N 870-2061-XX, to bring the total number of signaling links above 500, up to 700. Installed according to the provisioning rules for a system with 700 links in <i>Database Administration - SS7 User's Guide</i>.</p> <p>Enough E5-E1T1s to bring the total number of signaling links above 500, up to 700. Installed according to the provisioning rules for a system with 700 links in <i>Database Administration - SS7 User's Guide</i>.</p> <p>Enough Multi-Port LIMs (MPLs), P/N 870-2061-XX, and/or E1/T1MIMs, P/N 870-2198-XX, to bring the total number of signaling links to 1500. Installed according to the provisioning rules for a system with 1500 links in <i>Database Administration - SS7 User's Guide</i>.</p>

Table 3-6 (Cont.) Hardware Requirements-Maximum Number of Links

Number of Links	Required Hardware
From 1500 -- 2800 Links	<ul style="list-style-type: none"> • HIPR2 cards on the IMT buses • E5-MASP cards installed in 1113 and 1115, to run the active FTP • E5-MDAL cards installed in card locations 1117 and 1118

Note:
A maximum 250 IPLIMx cards can be installed.

Note:
There are only enough slots to support 500 links using just 2-port LIMs.

Enough E5-B cards to bring the total number of signaling links to 2800.
Installed according to the provisioning rules for a system with 2800 links in *Database Administration - SS7 User's Guide*.

Cam-out/lock-in levers, mounted on the front edge of LIM cards, (the exception being E1) assist in the insertion and the removal of the card from the shelf.

The figures below show the E5-B based LIM cards.

All four PCB assemblies have the same basic functions:

- Intel Dual Core processor: one core is used as the applications processor and the other core is used as the communications processor
- An Inter-processor Message Transport (IMT) interface that provides two 125 Mbps communications links that provide communications between modules
- -48VDC/+5VDC and -48VDC/+3.3VDC DC to DC power converter units

Figure 3-30 E5-ATM-B Card

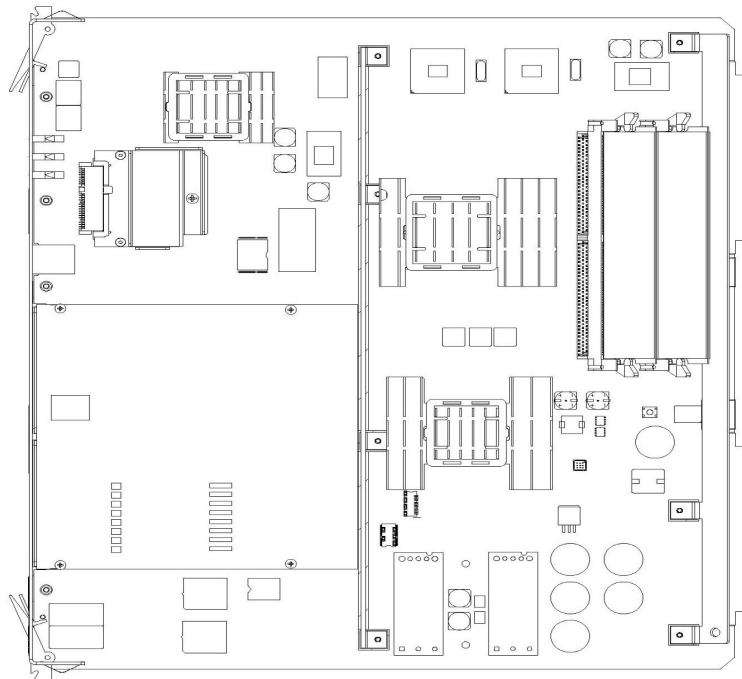

870-2972-01
E5_ATM-B_CARD_RDHS

Figure 3-31 E5-E1T1-B Card

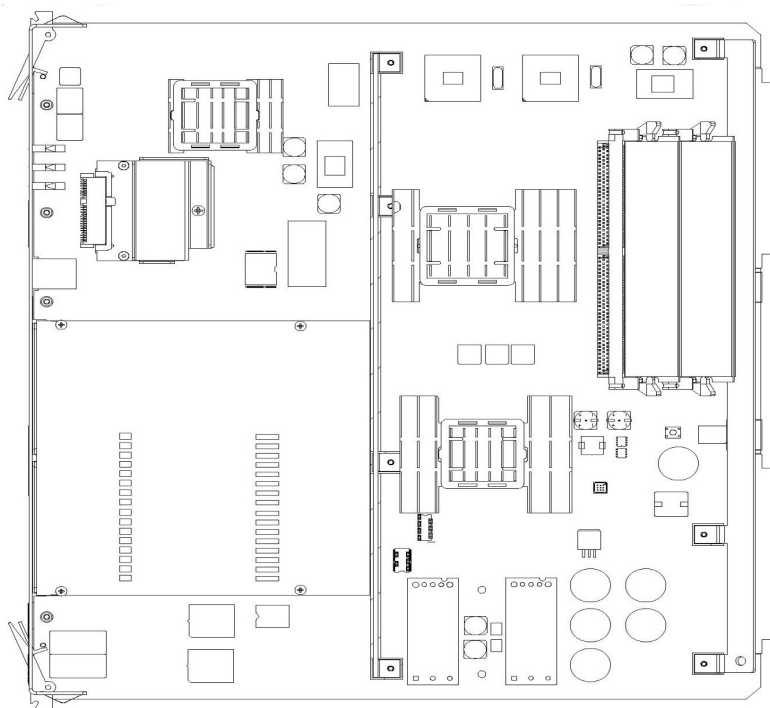

870-2970-01
E5_E1T1-B_CARD_ROHS

Figure 3-32 E5-ENET-B Card

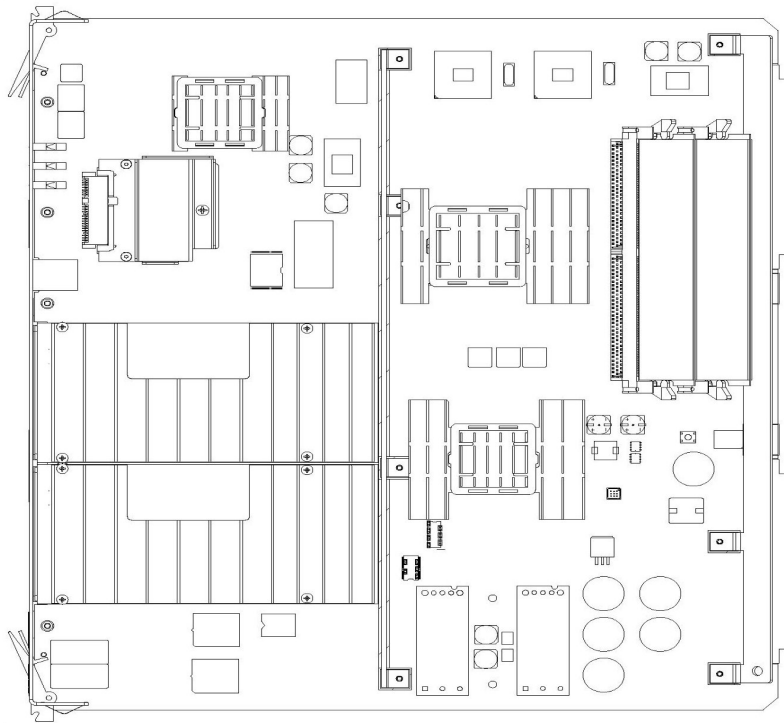

870-2971-01
E5_ENET-B_CARD_ROHS

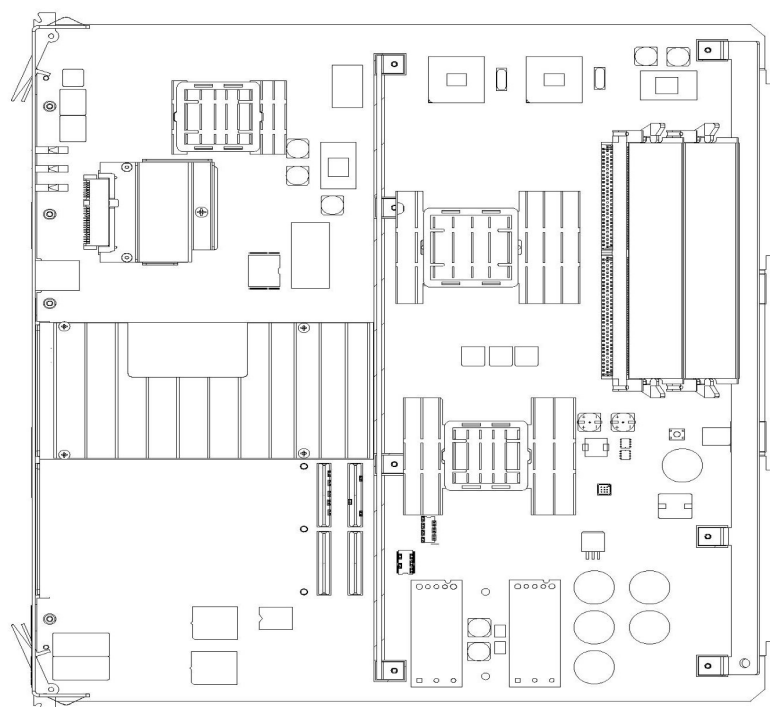
Figure 3-33 E5-MCPM-B870-3089-01
E5_MCPM-B_CARD_ROHS

Applications Processor

The Application Processor (**AP**) section of the LIM interfaces and controls the operation of the interface applique. The AP's operations are controlled by one core of the Intel Dual Core processor and peripherals.

Communications Processor

The Communications Processor (**CP**) is made up of one core of the Intel Dual Core Duo processor and peripherals. The CP section of the LIM controls the flow of transmit/receive data to and from the Inter-processor Message Transport (IMT) buses.

In the receive direction, the CP writes a receive initialization command to the IMT bus. The data packet is checked for the destination. If its destination is this LIM, the format is checked and a **Cyclic Redundancy Check (CRC)** is performed. The packet is then transferred to the CP memory by Direct Memory Access (**DMA**).

In the transmit direction, the CP forwards a packet along with 2 CRC bytes, calculated by the IMT circuitry, to the HIPR2 cards for transmission.

The CP also controls the selection of the IMT buses, A or B. In the other direction, the CP forwards data received from the IMT buses through the AP to the interface port (DB15) connector on the shelf backplane.

The CP is interrupt driven. Eight levels of the interrupts initiated by the IMT, the AP, and the **MAS**, are administered by a Programmable Interrupt Controller (**PIC**).

Inter-processor Message Transport

Each LIM unit has two Inter-processor Message Transport (IMT) interface circuits, IMT A and IMT B. The redundant IMT buses are used to transport:

- Generic Program Loads (GPLs) to various circuit cards
- All SS7 and traffic between circuit cards
- Maintenance traffic within the system

In the receive direction, a data packet is checked to see if it is destined for this particular LIM. If it is, the packet is checked for format and a cyclic redundancy check is performed. The packet is then transferred to the CP memory by Direct Memory Access (DMA). If the packet is not destined for this LIM, it is sent back onto the IMT bus towards the next module.

In the transmit direction, the Cyclic Redundancy Check (CRC) is calculated for a packet and the packet is transmitted through the HIPR2 cards to the IMT bus.

Power Converter Unit

LIM power is provided by two DC to DC converters that convert the -48VDC supplied to the system to +5VDC and +3VDC needed to power the LIM components.

Test and Maintenance Features

Colored LEDs are mounted on the front edge of the printed circuit board as LIM status and alarm indicators.

Database Communications Module

Note:

Beginning with Release 46.6, an E5-ENET-B or SLIC cards must be used.

A **Database Communications Module (DCM)** provides the following functions for the system:

- Signaling Transfer Point, **Local Area Network (SLAN)** function
- **ISUP** protocol data exchange between the IMT and the **IP** network
- **SS7** traffic exchange between B,C,D links and the **IP** network
- Enhanced bulk download
- When configured as a Sentinel Transport **Card (STC)** provides **TCP/IP** interfaces to the Extended Services Platform (**ESP**).
- When configured as an **IPLIMx** provides a point to point **TCP/IP** connection to be used to carry **SS7** traffic over B, C and D links. This feature will allow multiple point to point connections and not point to multi-point connections. Point to multi-point connectivity is provided by the **SS7IPGWGPL**.

The **DCM** card (P/N 870-1984-01) supports one to four plug-in memory cards. The primary board **DCM** with the addition of memory boards and software creates the **Database Service Modules (DSMs)**.

The **DCM** card can be mounted in the control shelf, require two slots for mounting, and must be assigned to an odd numbered slots with the next higher-numbered even slot left open. The **DCM** card are compatible with control shelf in backplanes 850-0330-04/06/07 and 7333412 and extension backplanes 850-0356-04/06 and 7333417.

 **Note:**

See "Hardware Baseline Table" in *Release Notes* for all compatible control shelf and extension backplane part numbers.

A **DCM** card is shown in [Figure 3-34](#) .

Figure 3-34 Database Communications Module

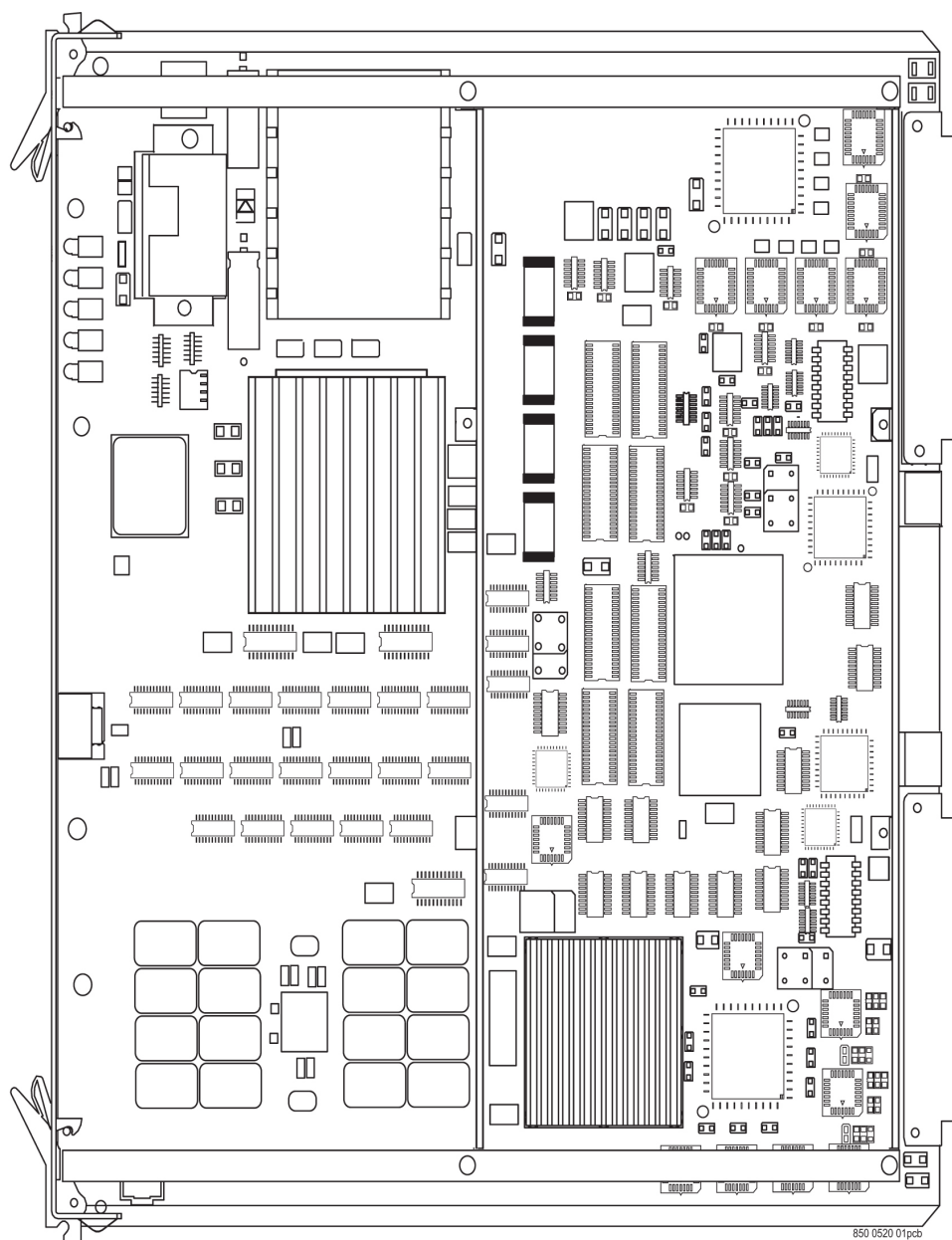

Signaling Transport Card

The Signaling Transport **Card (STC)** is a **DCM** card with an “eroute” generic program load (**GPL**) installed. The **STC** is based on the single-slot **EDCM** card. The **STC** card functions as an **IP** router between the IMT bus internal to an EAGLE and the ethernet networks used to communicate with an associated Extended Services Platform (**ESP**).

 **Note:**

The **STCs** provide the **IP** interface between the **LIM** cards on the IMT bus and the Extended Services Platform (**ESP**) subassembly.

Measurements Collection and Polling Module

The **MCPM** is an E5-MCPM-B card running MCPHC GPL.

 **Note:**

The E5-MCPM-B card is a requirement for the **FTP** measurements feature. The **FTP** measurements feature uses the **E5-MCPM-B** ethernet ports to transfer measurements information directly to a **FTP** server.

On the front edge of the **MCPM** card, there are five Light Emitting Diodes (**LED**) that provide status. The **MCPM LEDs** have four illumination states: red, amber, green, or off. The Application processor **LED** is off if -48VDC is not supplied. The Application Processor **LED** is red while booting, amber while loading, and green when the application is running. The IMT A and B **LEDs** indicate whether the **MCPM** is active on the A or B buses. IMT **LED** red—the card is off the bus, IMT **LED** amber—MUX card on the same shelf is seated and not inhibited; bus not available, IMT **LED** green—the card is active on the bus. The **PORT A** and **PORT B LEDs** are illuminated green when the A or B port is active.

E5-ATM-B Module

The **E5-ATM-B** card (P/N 870-2972-01) is a single slot card providing ATM over E1 and T1 connectivity for EAGLE control and extension shelves.

 **Note:**

Throughout this document, the term E5-ATM refers to the E5-ATM-B card (P/N 870-2972-01) card.

 **Note:**

All E5-based cards require **HIPR2**. For more information, see [High-Speed IMT Packet Router 2](#).

The E5-ATM assembly is comprised of the Embedded Processor Module (EPM) and an ATM/E1-T1 PCI Mezzanine Card (PMC). The E5-ATM provides:

- SS7 Link, ATM over T1 (ANSI)
- SS7 Link, ATM over E1 (ITU)
- TVG or MFC based load sharing
- STP/LAN (SLAN)
- Integrated Sentinel (e-route)
- Integrated Message Feeder
- Higher throughput than current HCAP-based LIMATM and LIME1ATM cards
- Automatic on/off CRC4 detection for E1 framing (default is on)
- Three ATM signaling links operating at 1 Erlang
- BICC support
- Thermal protection

The E5-ATM-B has the following requirements and dependencies:

- Requires HIPR2 in the shelf where the E5-ATM-B resides.
- E1 or T1 support, but will not support both physical port types on a single card simultaneously
- The E5-ATM-B requires a fan tray assembly for thermal management.
- Can interoperate with E1-ATM
- Is a hot-swap compatible replacement for the HCAP-based LIMATM and LIME1ATM cards

 **Note:**

Hot-swap is limited to one interface, but the second and third link can be provisioned once E5-ATM-B is installed. The Port B connector on the backplane may be used for link connectivity. To utilize the Port B connector on the backplane, a cable adapter (P/N 830-1342-05) and an additional cable are required.

- The E5-ATM-B requires Message Flow Control (MFC) feature
- The E5-ATM-B does not support TVG
- E5-ATM-B modules require a fan tray assembly for thermal management. Be sure to install the fan assembly before installing the E5-ATM-B card. See "Hardware Baseline Table" in *Release Notes* for compatible fan assembly part numbers.

Thermal Management

The **E5-ATM** includes thermal management and alarming provisions to protect the card from damage if environmental conditions hinder thermal stability.

When the CPU temperature rises above nominal range and exceeds a thermal threshold (Temperature Level1) a major alarm is raised against the card. When the temperature returns to its nominal range (below Temperature Level1) the alarm is automatically cleared.

If the temperature continues to increase and exceeds a second thermal threshold (Temperature Level2) a critical alarm is raised against the card. When this second thermal event occurs, the result is a local processor outage (LPO) and traffic is redirected to other cards (changeover), if possible. For ATM links, an LPO will take the links out-of-service. If the temperature recedes under the Temperature Level2 threshold, the LPO condition is cleared and the links can begin operation again.

If the CPU temperature goes above operating limits (approximately 99°C), the CPU will halt and the card will shut itself down to prevent permanent, catastrophic damage. In the event of thermal shutdown all processor activity will cease. If thermal shutdown occurs, the E5-ATM must then be reseated and allowed to load in order to clear the alarm and resume operation.

If the CPU temperature goes above operating limits (approximately 95°C for E5-ATM or 90°C for E5-ATM-B), the CPU will halt and the card will shut itself down to prevent permanent, catastrophic damage. In the event of thermal shutdown all processor activity will cease. If thermal shutdown occurs, the E5-ATM must then be reseated and allowed to load in order to clear the alarm and resume operation.

Table 3-7 identifies the appropriate responses.

Table 3-7 Thermal Alarm Conditions

Board Temperature	Actions
Temp1 Exceeded	Major alarm raised
Temp1 Exceeded	Major alarm raised; PST/SST of card transitions to IS-ANR/Restrict
Temp2 Exceeded	Critical alarm raised; failover initiated, traffic rerouted
Temp2 Exceeded	Critical alarm raised; failover initiated, traffic rerouted; PST/SST of card remains in IS-ANR/Restrict
Temperature abated	Normal operation restored
Thermtrip - shutdown temperature exceeded	CPU shuts down automatically. Card must be reseated to restore operation once temperature returns to normal operating conditions

The thermal thresholds (Temperature Level1 and Temperature Level2) are user configurable. The user configurable T1 and T2 values will always be less than or equal to the T1 (max) and T2 (max) defined for a particular board type respectively. See Table 3-8 and the `chg-th-alm` command for more details on thermal thresholds.

Table 3-8 T1 and T2 temperature thresholds

Cards	T1 Max (in Celsius)	T2 Max (in Celsius)	User Configurable T1 range (in %)	User Configurable T2 range (in %)
E5-ATM	92	95	(73-92)% of T2 max	(74-100)% of T2 max
E5-ATM-B	83	90	(73-92)% of T2 max	(74-100)% of T2 max

LED Indicators

The **E5-ATM** includes three front panel indicators (**LEDs**) for **APPL Proc** operation, **IMT A**, and **IMT B** status. In addition, four front panel **LED Link/Activity** indicators (two for each **IP** port used). **Figure 3-35** shows the LEDs and provides a description of indications.

Figure 3-35 E5-ATM-B

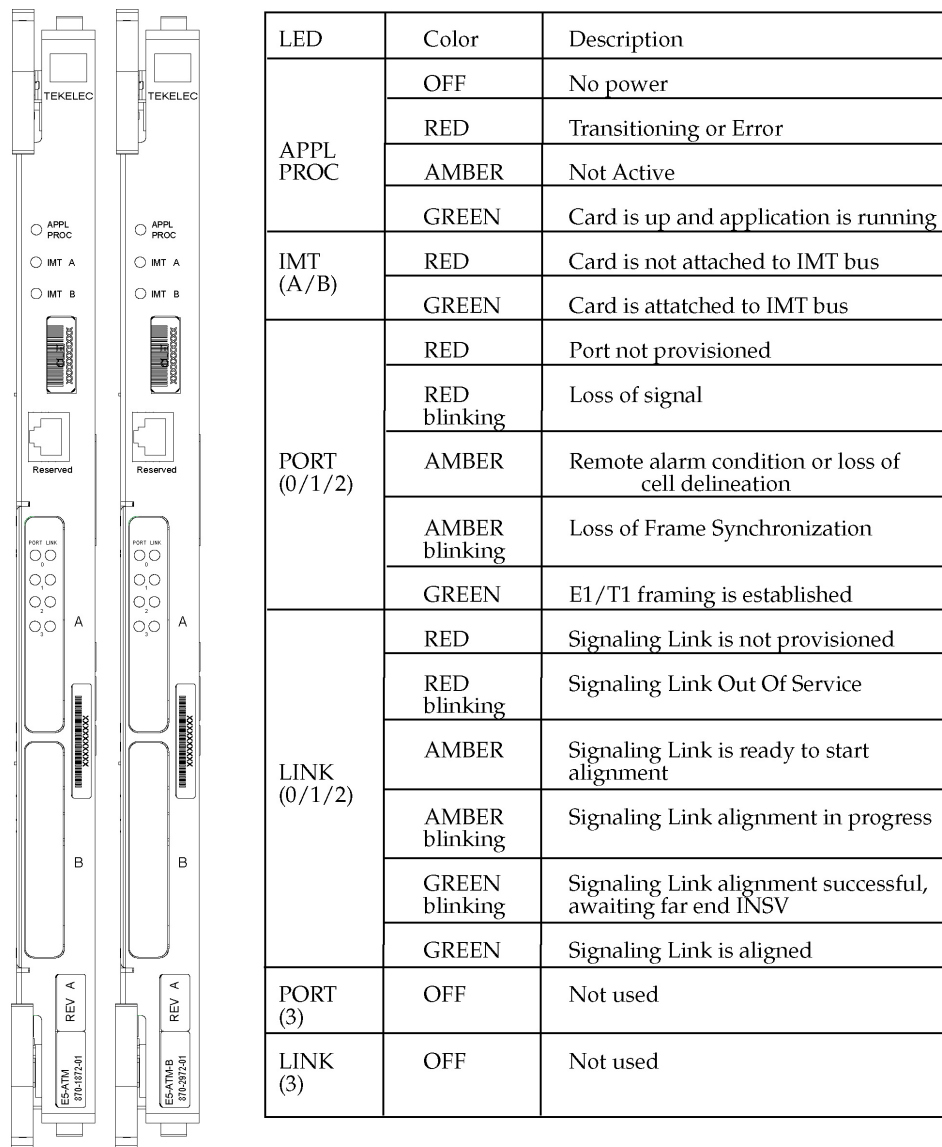

Interface Adapter

The **E5-ATM-B** provides connectivity for two **E1/T1** ports on the **Port A** backplane connector, allowing up to two links that may be provisioned. Both **E1/T1** ports can be accessed with a 2-port or 4-port cable. An interface adapter (P/N 830-1342-05) allows the two ports to be physically split to two different cables/patch panels. If it is desired to move the second **E1/T1** port to the **Port B** backplane connector, then an adapter and another cable (1-, 2-, or 4-port) must be used.

The following are existing interface cables that may be attached to the backplane connectors:

- 1-port connectivity (P/N 830-0849-XX or P/N 830-1184-XX)
- 2-port connectivity (P/N 830-0622-XX or P/N 830-1233-XX)
- 4-port connectivity (P/N 830-0932-XX, P/N 830-1196-XX, P/N 830-0948-XX, or 830-1197-XX)

Technical Specifications

Table 3-9 E5-ATM-B Technical Specifications

Physical Characteristics	
Height	14.43 in. (36.65 cm)
Width	1.013 in. (2.57 cm)
Depth	12.80 in. (32.51 cm)

E5-E1T1-B Module

The E5-E1T1-B card (P/N 870-2970-xx) is a single slot card providing eight trunk terminations. The eight E1/T1 ports reside on backplane connectors A and B. The E5-E1T1-B supports up to 64 signaling links of configurable channelized E1 or T1 connectivity OR two SE-HSL/ST-HSL signaling links.



Note:

The term E5-E1T1 used here refers to the E5-E1T1-B (P/N 870-2970-XX) card.

All ports on a single board operate in the same trunk format, **E1** or **T1**. However, it is possible to have a mixture of trunk formats in a node with some E5-E1T1-Bs operating in **T1** mode with others operating in **E1** mode for gateway node scenarios.

The **E5-E1T1-B** has the following requirements and dependencies:

- Requires **HIPR2** to be active on both IMT buses in the shelf where the **E5-E1T1** will reside.
- The **E5-E1T1** will not support channel cards as it uses all connections on the backplane.
- E5 modules do not require a fan tray assembly for thermal management.
- The **E5-E1T1** is a single-slot module that can be used in any slot that a **LIM** can be configured.
- The E5-E1T1-B requires the Message Flow Control (MFC) feature to be active.
- The E5-E1T1-B does not support TVG.
- The E5-E1T1-B requires a fan tray assembly for thermal management.

Total system signaling link capacity depends on other cards within the system and must not exceed the provisioning limit of the **EAGLE** system. Since the **E5-E1T1** has the capacity to process a full **T1** or **E1** on a single card, daisy chaining or channel card operation is not needed.

The maximum provisionable links for the **E5-E1T1** will be 32 links. If the **E5-E1T1** has more than 32 links provisioned, it will auto-inhibit. The fan feature is ignored for the **E5-E1T1**.

Channelized Mode

The **E5-E1T1** provides access to eight **E1/T1** ports residing on backplane connectors A and B. Each data stream consists of 24 **T1** or 31 **E1 DS0** signaling links assigned in a time-division multiplex (**TDM**) manner. Each channel occupies a unique time slot in the data stream and can be selected as a local signaling link on the interface card. Each card can select up to a total of 64 signaling links. The default configuration is 16 signaling links.

External interfaces (the **E1/T1** trunks) use both backplane interfaces of the single backplane slot used, each terminating four **E1/T1** ports (trunks). These two backplane interfaces will be referred to in this section as interfaces A and B. Interface A terminates **E1/T1** ports 1-4, while Interface B terminates **E1/T1** ports 5-8. Refer to [Figure 3-36](#).

Figure 3-36 Channelized E5-E1T1-B Interfaces

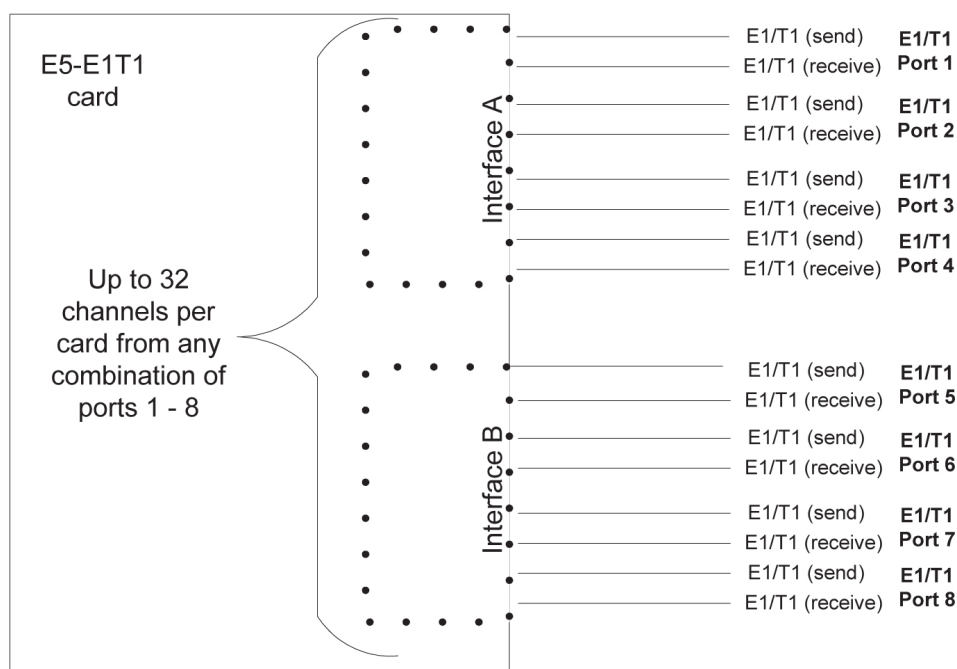

Note:

All ports on a single board must operate in the same trunk format, **E1** or **T1**, and that the total number of channels utilized as signaling links must not exceed the maximum allowable number in accordance with a **Feature Access Key** defining total channel capacity.

Channel Bridging

Channel Bridging is the processing of signaling channels that are intermixed on trunks with voice or data channels. The **HCMIM** provides **Channel Bridging** which allows for better utilization of bandwidth without dedicating entire trunks to signaling. Non-signaling channels are bridged to an adjacent **E1/T1** port for transport to other network devices. Likewise, signaling channels are merged to non-signaling data for transmission back to the mixed network.

In this configuration, the High-speed Master Timing option can only apply to one trunk format since only one high-speed clock rate can be provided. **Channel** bridging is available only in the channelized mode. Refer to [Figure 3-37](#).

Figure 3-37 Channel Bridging Schematic

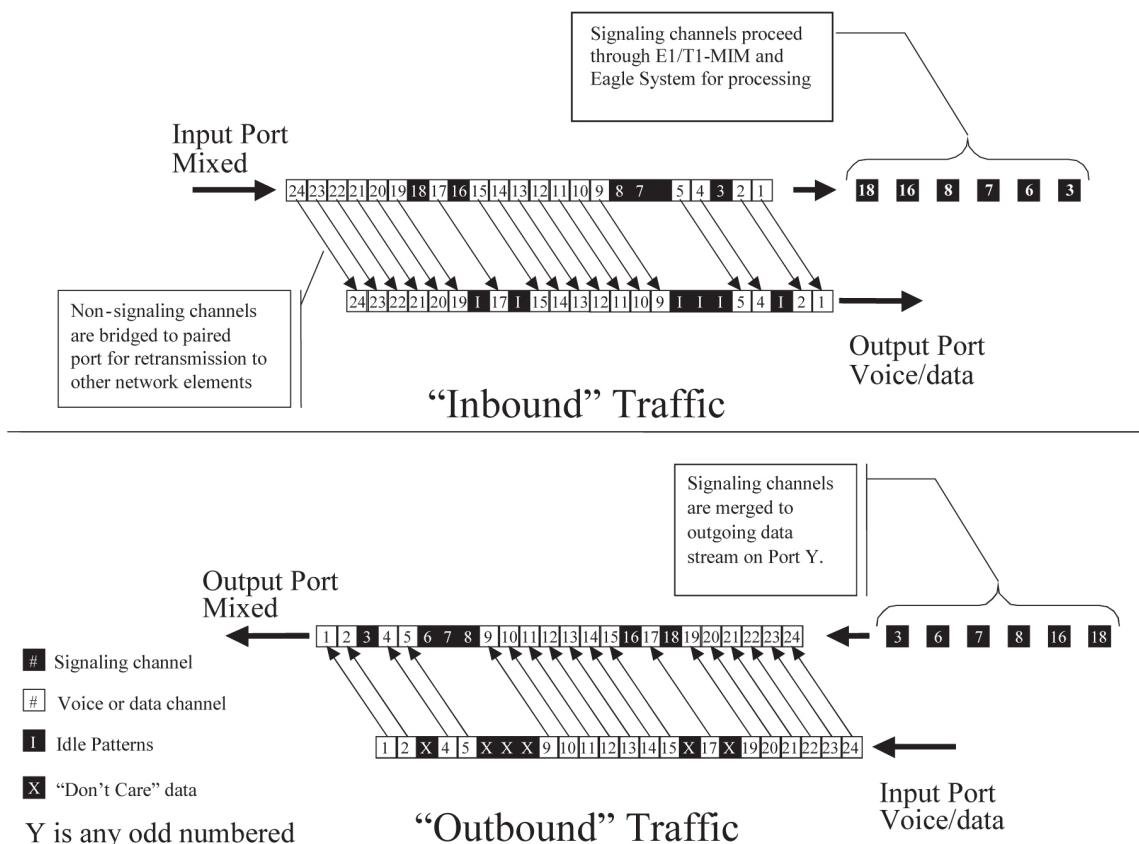

Time slots located on the bridging slave **E1/T1** port, (time slots that have been dropped from the bridging master **E1/T1** port), contain idle patterns provided by the **EAGLE**. All other idle time slots that are not dropped must contain an idle pattern provided by the remote network elements connected to both **E1/T1** ports (bridging master and slave). Without these patterns on the idle time slots, instability of the **E1/T1** may occur.

Note:
Provisioning of signaling links on the bridging slave **E1/T1** port is not allowed while channel bridging is activated.

Channel Bridging is implemented by pairing **E1/T1** ports; this pairing limits provisioning to odd **E1/T1** ports only (1,3,5,7) when channel bridging is enabled. The adjacent even numbered **E1/T1** ports (2, 4, 6, 8) are used to allow the original non-signaling data received on the bridging master (odd) **E1/T1** port to reach downstream network elements. This is a bi-directional interface so data is also able to enter the bridging slave **E1/T1** port and leave through the bridging master **E1/T1** port. This feature may be independently selected on **E1/T1** ports 1, 3, 5, and/or 7. When selected, the bridging slave (even) **E1/T1** port would be

provisioned as the pass-through **E1/T1** port. On ports operating in **Channel Bridging** mode, all time-slots not provisioned for signaling are handled as active data and not overwritten by the **E5-E1T1**.

Table 3-10 Channel Bridging E1/T1 Port Pairing

PrimaryE1/T1 Port		PairedE1/T1 Port	
Number	Payload Contents	Number	Payload Contents
1	Signaling Processed	2	Unprocessed
3	Signaling Processed	4	Unprocessed
5	Signaling Processed	6	Unprocessed
7	Signaling Processed	8	Unprocessed

Timing

In order to use channel bridging without facility errors, both bridging master and bridging slave **E1/T1** ports must be synchronous; that is, both master and slave must be timed off the same clock source. This synchronization may be accomplished two ways:

- The bridging master **E1/T1** port may use the timing recovered from the bridging slave **E1/T1** port or visa versa.
- Both the bridging master and bridging slave **E1/T1** ports are using an external clock source (the EAGLE's MASTER option for the **E1/T1** port provisioning).

Any other methods used for timing could cause problems on the **E1/T1** trunk and are not supported.

Alarms and LEDs

The channel bridging functionality requires no additional statistics collection for the bridging slave **E1/T1** port; however, standard statistics/measurements are made on the bridging master **E1/T1** port. Alarms for the bridging slave **E1/T1** port are limited to trunk-level synchronization and framing alarms. **Channel** alarm LEDs for the bridging slave **E1/T1** port are amber to indicate the **Channel** Bridging mode of operation.

Three LEDs provide conventional EAGLE card indications of APPL Proc operation, and IMT A and IMT B operation. Up to sixteen (16) LEDs, two for each **E1/T1** port, are used to indicate port and channel (signaling link) status. One LED per **E1/T1** port indicates **E1/T1** port Status and one LED per **E1/T1** port indicates aggregated channel status. See [Figure 3-38](#).

Figure 3-38 E5-E1T1-B

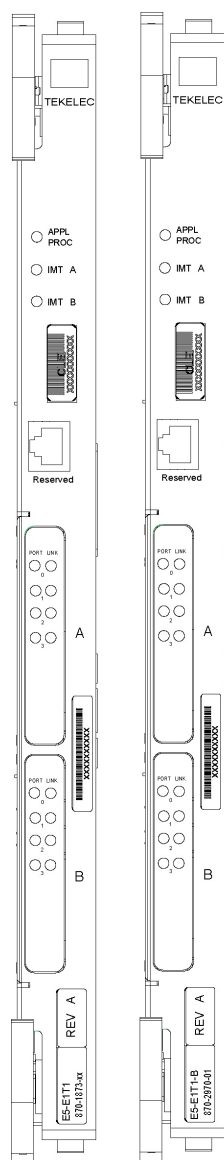

LED	Color	Description
APPL PROC	OFF	No power
	RED	Transitioning or Error
	AMBER	Not Active
	GREEN	Card is up and application is running
IMT (A/B)	RED	Card is not attached to IMT bus
	GREEN	Card is attached to IMT bus
PORT	RED	Port not provisioned
	RED blinking	Loss of signal and remaining errors
	AMBER	Remote alarm condition
	AMBER blinking	Loss of Frame Synchronization
	GREEN	No alarms, port has acquired timing and framing synchronization.
LINK (Aggregated Channel Status)	RED	No channels are provisioned
	RED blinking	All channels provisioned = OOS
	AMBER	Indicates port is the "reflected" port in Channel Bridging mode of operation. Applies only to "even" numbered ports.
	AMBER blinking	Any channel provisioned = OOS
	GREEN	All channels provisioned = IS-NR

Technical Specifications

Table 3-11 E5-E1T1-B Technical Specifications

Power Requirements	
Voltage	-48VDC
Current	0.67A
Power	32W
Physical Characteristics	
Height	14.43 in. (36.65 cm)
Width	1.013 in. (2.57 cm)
Depth	12.80 in. (32.51 cm)

E5-ENET-B Module

The E5-ENET-B module (P/N 870-2971-xx) is a single slot card that has one or more Ethernet interfaces and provides increased transactions per second (TPS).

Note:

Throughout this document, the term E5-ENET refers to the E5-ENET-B (P/N 870-2971-xx) card.

The E5-ENET card has the following requirements and dependencies:

- The **E5-ENET** has 2 physical 10/100 Mbps Ethernet ports.
- The E5-ENET supports STP Local Area Network function, and 10/100Base-T ethernet links to the STP.
- The **E5-ENET** supports protocols as identified in [Table 3-12](#):

Note:

The **E5-ENET** is provisionable for **IPLIMx** or **IPGWx**, but does not support both functions on a single card simultaneously.

- Requires **HIPR2** to be active on both IMT buses in the shelf where the **E5-ENET** will reside.
- An adapter cable per Ethernet port. See [Interface Cable Differences](#).
- Maximum number of cards per shelf is 10 for the control shelf and 16 for the extension shelf.
- Mix of **E5-ENET/HCMIM** on a shelf can be any up to shelf and power capacity.
- The E5-ENET does not require a fan tray assembly for thermal management.
- The E5-ENET-B requires the Message Flow Control (MFC) feature to be active.
- The E5-ENET-B does not support TVG.
- The E5-ENET-B requires a fan tray assembly for thermal management.

Table 3-12 E5-ENET-B Supported Protocols

Feature	Protocols Supported
IPGWY	SCTP,M3UA,SUA
IPSG	M2PA, M3UA
SLAN	TCP/IP
EROUTE	TCP/IP

Table 3-13 E5-ENET-B Capacities

Parameter	IPGWY
E5-ENET-B cards per node	250
SCTP entities per E5-ENET-B module	50 SCTP Connections
The maximum possible EAGLE currently supports 4000 in the link table.	

Thermal Management

The E5-ENET-B includes thermal management and alarming provisions to protect the card from damage if environmental conditions hinder thermal stability. Table 3-14 identifies the appropriate responses.

When the CPU temperature rises above nominal range and exceeds a thermal threshold (Temperature Level1) a major alarm is raised against the card. When the temperature returns to its nominal range (below Temperature Level1) the alarm is automatically cleared.

If the temperature continues to increase and exceeds a second thermal threshold (Temperature Level2) a critical alarm is raised against the card. The application software will treat the notification as a local processor outage (LPO) and begin redirecting traffic to other cards (changeover), if possible.

- For IPGWx the link will be taken out of service and the far end will be notified that the connections will no longer accept traffic.

If the CPU temperature goes above operating limits (approximately 125°C), the CPU will halt and the card will shut itself down to prevent permanent, catastrophic damage. In the event of thermal shutdown all processor activity will cease. If thermal shutdown occurs, the E5-ENET must then be reseated and allowed to load in order to clear the alarm and resume operation.

Table 3-14 Thermal Alarm Conditions

Board Temperature	Actions
Temp1 Exceeded	Major alarm raised
Temp2 Exceeded	Critical alarm raised; failover initiated, traffic rerouted
Temperature abated	Normal operation restored
Thermtrip - shutdown temperature exceeded	CPU shuts down automatically. Card must be reseated to restore operation once temperature returns to normal operating conditions

The thermal thresholds (Temperature Level1 and Temperature Level2) are user configurable. The user configurable T1 and T2 values will always be less than or equal to the T1 (max) and T2 (max) defined for a particular board type respectively. See Table 3-15 and the `chg-th-alrm` command for more details on thermal thresholds.

Table 3-15 T1 and T2 temperature thresholds

Cards	T1 Max (in Celsius)	T2 Max (in Celsius)	User Configurable T1 range (in %)	User Configurable T2 range (in %)
E5-ENET	92	95	(73-92)% of T2 max	(74-100)% of T2 max
E5-ENET-B	83	90	(73-92)% of T2 max	(74-100)% of T2 max

LED Indicators

The **E5-ENET-B** includes three front panel indicators (**LEDs**) for **APPL** Proc operation, IMT A, and IMT B status. In addition, eight front panel **LED Link/Activity** indicators (two for each **IP** port used).

Figure 3-39 E5-ENET-B

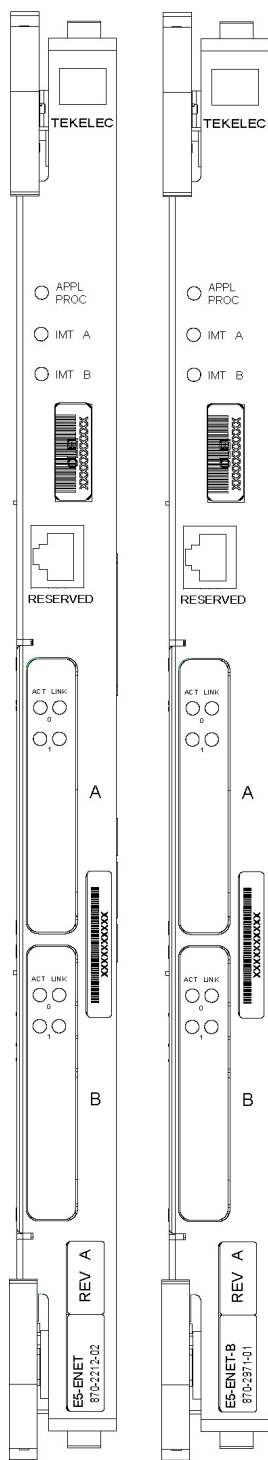

Front Faceplate LED Indicators

LED	Status	Description
APPL PROC	Off	No power
	Red	Card is booting
	Amber	Card is loading
	Green	Card is up and application is running
IMT A	Red	Not connected to bus
	Amber	Testing not complete
	Green	Active and connected to the bus
IMT B	Red	Not connected to bus
	Amber	Testing not complete
	Green	Active and connected to the bus

EROUTE/SLAN

LED	ACT	LINK
Red	Signaling links inactive, or 1 or more active links are out-of-service	N/A
Green	All active links are in-service	Ethernet signal detected
Off	Card nonfunctional	No Ethernet signal detected

ACT Status LED states for IPLIMx/IPSG

SLK States (Port A or Port B)	ACT Status LED
No links configured	Off
All provisioned links are OOS-MT-DSBLD	Red
Sync	Green

ACT Status LED states for IPGWx

IPGWx SLK PST	ACT Status LED	
	A0	B0
None configured (card must be inhibited)	Off	Off
OOS-MT-DSBLD	Red	Red
IS-NR or IS-ANR	Green	Green

Interface Cable Differences

The PMC ports A0 and B0 are utilized as IP signaling link ports while PMC ports A1 and B1 support the Fast Copy feature when enabled. Each interface is independent of the others. The E5-ENET card and other DCM-class cards have backplane cable pinout differences requiring an adapter for the E5-ENET card. See [Table 3-16](#).

The PMC ports A0 and B0 are utilized as IP signaling link ports while PMC ports A1 and B1 support the Fast Copy feature when enabled. Each interface is independent of the others. The E5-ENET card and other DCM-class cards have backplane cable pinout differences requiring an adapter for the E5-ENET card. See [Table 3-17](#).

The Ethernet cable pinouts differ between the card and the **DCM/SSEDCM** cards.

- Adapter P/N 830-1103-02 is required for each **E5-ENET** interface used when using the existing **DCM** cable (P/N 830-0978-xx). The adapter is connected between the backplane connector and the existing **DCM** cable for the card.
- Adapter P/N 830-1102-02 is required for installation of the **E5-ENET** when the **DCM** cable is replaced with an **RJ-45 CAT-5E** cable (P/N 830-0724-xx). The adapter is connected to the backplane and the **RJ-45 CAT-5E** cable is connected from the other side of the adapter to a switch, or a hubcopy feature, or a patch panel (same place the **DCM** cable was terminated). This adapter configuration can be used for IPSPG with the FAST COPY feature. When the adapter is connected (P1 to the backplane), the upper jack (P2) is for FAST COPY and the lower jack (P3) is the ethernet interface.
- Adapter P/N 830-1103-xx is required for each **E5-ENET** interface used when using the existing **DCM** cable (P/N 830-0978-xx). The adapter is connected between the backplane connector and the existing **DCM** cable for the card.
- Adapter P/N 830-1102-xx is required for installation of the **E5-ENET** when the **DCM** cable is replaced with an **RJ-45 CAT-5E** cable (P/N 830-0724-xx). The adapter is connected to the backplane and the **RJ-45 CAT-5E** cable is connected from the other side of the adapter to a switch, or a hubcopy feature, or a patch panel (same place the **DCM** cable was terminated). This adapter configuration can be used for IPSPG with the FAST COPY feature. When the adapter is connected (P1 to the backplane), the upper jack (P2) is for FAST COPY and the lower jack (P3) is the ethernet interface.
- For IPSPG with the FAST COPY feature, adapter P/N 830-1343-xx is required when using existing cables (P/N 830-1204-xx) and additional CAT-5 shielded cables P/N 830-1174-xx for the monitoring ports are also required. When the adapter is connected (P1 to the backplane), jack P2 is for FAST COPY and jack P3 is the ethernet interface.

Table 3-16 Interface Cable/Adapter

Protocol	Adapter	Cable
IPGWY	830-1103-02	830-0978-xx or 830-1204-xx
IPGWY	830-1102-02	830-0724-xx or 830-1174-xx
IPSPG with FAST COPY	830-1102-02	830-0724-xx or 830-1174-xx
	830-1343-01 (port A0, A1)	830-0978-xx or 830-1204-xx (backplane connector A)
	830-1343-02 (port B0, B1)	830-0978-xx or 830-1204-xx (backplane connector B)

Table 3-17 Interface Cable/Adapter

Protocol	Adapter	Cable
IPGWY	830-1103-xx	830-0978-xx or 830-1204-xx
IPGWY	830-1102-xx	830-0724-xx or 830-1174-xx
IPSG with FAST COPY	830-1102-xx	830-0724-xx or 830-1174-xx
	830-1343-01 (port A0, A1)	830-0978-xx or 830-1204-xx (backplane connector A)
	830-1343-02 (port B0, B1)	830-0978-xx or 830-1204-xx (backplane connector B)

If the card inserted into the slot does not match the backplane connector, the interface will not function.

Technical Specifications

Table 3-18 E5-ENET-B Technical Specifications

Physical Characteristics	
Height	14.43 in. (36.65 cm)
Width	1.013 in. (2.57 cm)
Depth	12.80 in. (32.51 cm)

SLIC

The Oracle Communications EAGLE Service and Link Interface Card (**SLIC**) is a single-slot, multi-use card that runs multiple applications. See "EAGLE Card Overview" in *Release Notes* for current GPL and Application compatibility. When provisioning the SLIC card, the card type will be SLIC when plugged in.

Thermal Management

The SLIC includes thermal management and alarming provisions to protect the card from damage if environmental conditions hinder thermal stability. In the event of thermal shutdown all processors activity ceases.

The SLIC requires a fan tray assembly for thermal management. Be sure to install the fan assembly before installing the SLIC card.

Thermal monitoring detects and provides notification of increasing card temperature, and disables the card when needed to prevent it from overheating.

- When the CPU temperature rises above nominal range and exceeds a thermal threshold (Temperature Level 1) a major alarm is raised against the card.
- If the temperature continues to increase and exceeds a second thermal threshold (Temperature Level 2), a critical alarm is raised against the card. When this second thermal event occurs, the application software auto-inhibits the card (refer to the table below).
- Once the temperature recedes under the Temperature Level 2 threshold, the application re-allows operation and sets its state to IS-NR/Idle. The raised critical alarm is cleared and the corresponding major alarm is raised.

- When the temperature returns to its nominal range (below Temperature Level 1) the raised major alarm is cleared.

 **Note:**

These thermal thresholds (Temperature Level 1 and Temperature Level 2) are user configurable. For more information refer to the `chg-th-alm` command in *Commands User's Guide*.

Table 3-19 Thermal Alarm Conditions

Board Temperature	SLIC Actions
Temp Level 1 Exceeded	Major alarm raised
Temp Level 2 Exceeded	Critical alarm raised; Auto-inhibit is allowed by the user on that card and set their status to OOS-MT-DSBLD/MEA. Set card state to out-of-service, maintenance fault.
Temperature abated	When temperature drops below Temperature Level 2, Temperature Level 1 action/state restored. When the temperature drops below Temperature Level 1, normal operation restored.
Thermtrip - shutdown temperature exceeded	CPU shuts down automatically. Card must be reseated to restore operation once temperature returns to normal operating conditions

Alarms and LEDs

The SLIC has 21 LEDs visible on the faceplate. The LEDs are visible with the aid of a light pipe, which directs the light from the LED to the front panel.

Figure 3-40 SLIC

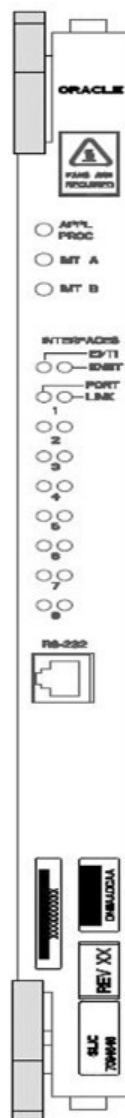

Table 3-20 SLIC Front Panel LEDs

LED Name	Control	Colors	Definition
APPL	FPGA / Application Software	Off / Red / Green	Off - No power Red - Card is booting Green - Card is running Application
IMTA	LIIC FPGA / Communication Software	Red / Green	Red -Not connected to BUS Green - Active and Connected to Bus Amber - MUX card on the same shelf is seated and not inhibited; bus not available

Table 3-20 (Cont.) SLIC Front Panel LEDs

LED Name	Control	Colors	Definition
IMTB	LIIC FPGA / Communication Software	Red / Green	Red - Not connected to BUS Green - Active and Connected to Bus Amber - MUX card on the same shelf is seated and not inhibited; bus not available
INTERFACE S E1/T1	FPGA / Application Software	Green / Off	Green - Enabled Off - Disabled
INTERFACE S ENET	FPGA / Application Software	Green / Off	Green - Enabled Off - Disabled
PORT1- PORT8	PHY / Application Software	Off / Red / Green	Off - Not configured Red - Cable removed and/or not synced Green - 10/100Mb link speed
LINK1- LINK8	FPGA / Application Software	Off / Red / Green	Off - No SLKS configured Red - All Configured SLKS OOS Green - All SLKS aligned

E5-MCPM-B Module

The single-slot E5-MCPM-B (P/N 870-3089-xx) card can be used for nodes larger than 1200 (if 15 Measurements is enabled). E5-OAM Integrated Measurements can still be used for smaller nodes.

E5-MCPM-B modules require a fan tray assembly for thermal management. Be sure to install the fan assembly before installing the E5-MCPM-B card. See "Hardware Baseline Table" in *Release Notes* for compatible fan assembly part numbers.

Note:

The E5-MCPM-B card is a requirement for the **FTP** measurements feature. The **FTP** measurements feature uses the **E5-MCPM-B** ethernet ports to transfer measurements information directly to a **FTP** server.

Thermal Management

The E5-MCPM-B includes thermal management and alarming provisions to protect the card from damage if environmental conditions hinder thermal stability.

When the CPU temperature rises above nominal range and exceeds a thermal threshold (Temperature Level1) a major alarm is raised against the card. When the temperature returns to its nominal range (below Temperature Level1) the alarm is automatically cleared.

If the temperature continues to increase and exceeds a second thermal threshold (Temperature Level2) a critical alarm is raised against the card. When this second thermal event occurs, the

result is a local processor outage (LPO) and critical thermal alarm on the primary MCP will initiate a role change arbitration with the secondary MCP, which may or may not result in a role change. The state of card will transition to 'in-service abnormal' state. If the temperature recedes under the Temperature Level2 threshold, the LPO condition is cleared and the card can begin operation again.

If the CPU temperature goes above operating limits (approximately 99°C), the CPU will halt and the card will shut itself down to prevent permanent, catastrophic damage. In the event of thermal shutdown all processor activity will cease. If thermal shutdown occurs, the E5-MCPM-B must then be reseated and allowed to load in order to clear the alarm and resume operation.

[Table 3-21](#) identifies the appropriate responses.

Table 3-21 Thermal Alarm Conditions

Board Temperature	Actions
Temp1 Exceeded	Major alarm raised
Temp2 Exceeded	Critical alarm raised; If the card is the primary MCP, a role change will be initiated. Card state transitions to IS-ANR.
Temperature abated	Normal operation restored
Thermtrip - shutdown temperature exceeded	CPU shuts down automatically. Card must be reseated to restore operation once temperature returns to normal operating conditions

The thermal thresholds (Temperature Level1 and Temperature Level2) are user configurable. The user configurable T1 and T2 values will always be less than or equal to the T1 (max) and T2 (max) defined for a particular board type respectively. See [Table 3-22](#) and the `chg-th-alrm` command for more details on thermal thresholds.

Table 3-22 T1 and T2 temperature thresholds

Cards	T1 Max (in Celsius)	T2 Max (in Celsius)	User Configurable T1 range (in %)	User Configurable T2 range (in %)
E5-MCPM-B	83	90	(73-92)% of T2 max	(74-100)% of T2 max

Alarms and LEDs

The E5-MCPM-B includes three front panel indicators (LEDs) for **APPL** Proc operation, IMT A, and IMT B status. In addition, four front panel LED Act/Link indicators (two for each IP port used). The Link indicator will illuminate Green when the interface is connected to an active Ethernet device and is Off when not connected. The Activity indicator will be Green when the IP signaling links are active and synchronized and RED otherwise.

Figure 3-41 E5-MCPM-B

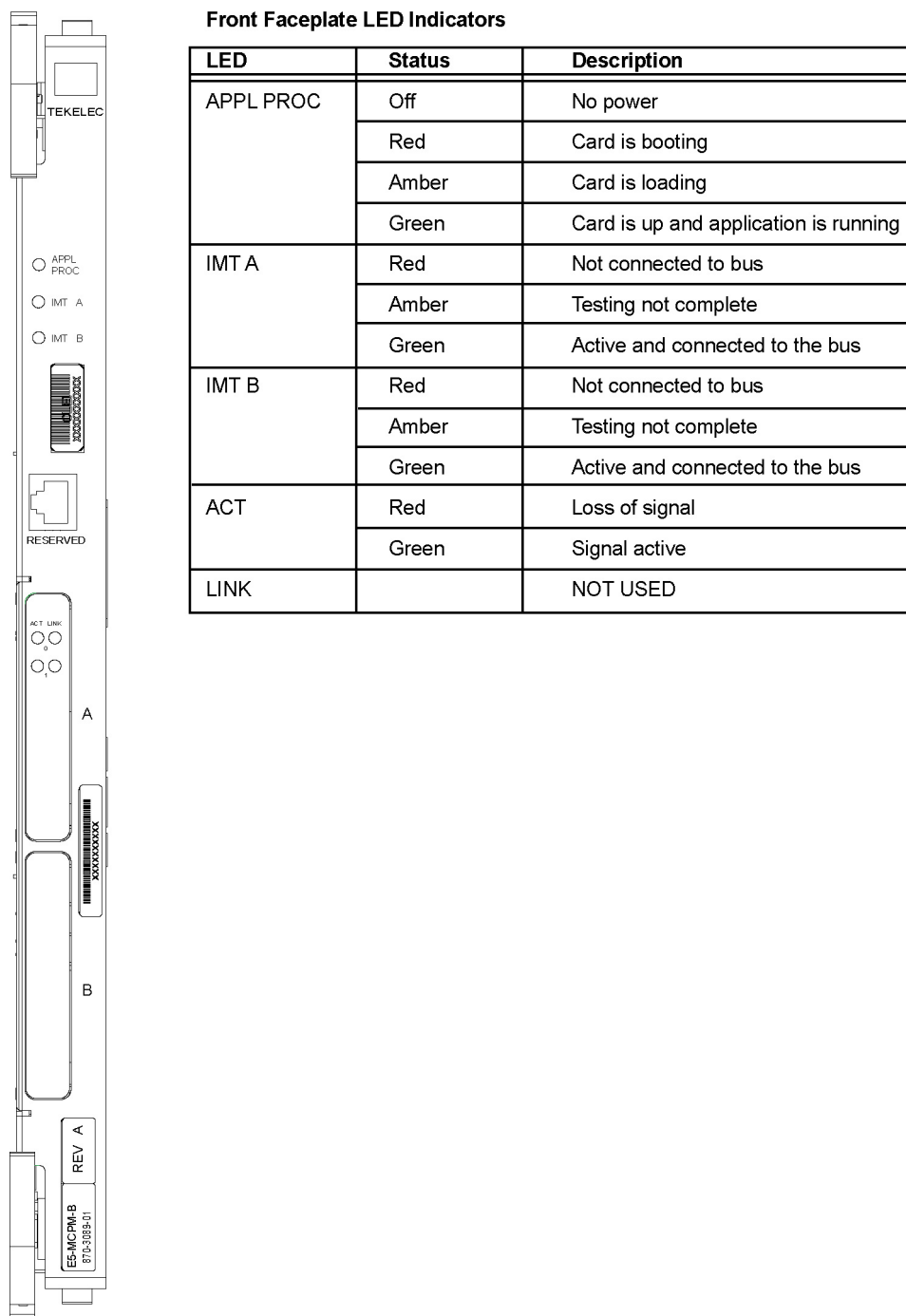

Technical Specifications

Table 3-23 E5-MCPM-B Technical Specifications

Physical Characteristics	
Height	14.43 in. (36.65 cm)

Table 3-23 (Cont.) E5-MCPM-B Technical Specifications

Physical Characteristics	
Width	1.013 in. (2.57 cm)
Depth	12.80 in. (32.51 cm)

E5-SM8G-B Module

The E5-SM8G-B (P/N 870-2990-xx) is a database service module (**DSM**) designed to operate in the EAGLE shelf. The E5-SM8G-B is a double-slot card with 8GB of total memory. It provides global title functions required for Local Number Portability (LNP), all Signaling Connection Control Part (SCCP), which is part of Global Title Translation (GTT), and Generic Load Services (GLS) which is part of Gateway Screening.



Note:

All E5-based cards require **HIPR2**. For more information, see [High-Speed IMT Packet Router 2](#).

The **E5-SM8G** (P/N 870-2990-xx) is a database service module (**DSM**) designed to operate in the EAGLE shelf. The E5-SM8G provides the following for the EAGLE system:

- Support for the VSCCP features
- SS7 traffic exchange between B,C,D links and the IP network
- Support for the 150K TPS GTT and 75K TPS G-Port features
- Enhanced bulk download

The E5-SM8G-B has the following requirements and dependencies:

- Requires HIPR2 to be active on both IMT buses in the shelf where the E5-SM8G-B will reside.
- Requires the Message Flow Control (MFC) feature to be active.
- Requires a fan tray assembly for thermal management.
- The E5-SM8G-B is restricted from accessing the IMT bus through hardware control.
- Can replace a DSM in the control or extension frame without requiring additional provisioning.
- Can interoperate with DSMs at an operating capacity of 850, 1100, or 1700 transactions per second (TPS).
- Can also interoperate with two channel LIM cards per node. The E5-SM8G-B provides two physical 10/100/1000 Mbps Ethernet ports.

Thermal Management

The E5-SM8G provides thermal management and alarming provisions to protect the card from damage due to overheating. The E5 SM8G contains a thermal monitor with software selectable thresholds for temperature abnormal levels. Threshold crossings generate alarms accompanied

by application processor interrupts. These interrupts require the mitigation of the temperature rise to resume normal card operations interrupted by the threshold crossings. The E5-SM8G is designed to operate in the EAGLE shelf with natural convection cooling and does not require a fan tray for cooling.

When the CPU temperature rises above nominal range and exceeds a thermal threshold, a major alarm is raised against the card. When the temperature returns to its nominal range the alarm is automatically cleared.

If the temperature continues to increase and exceeds a second thermal threshold, a critical alarm is raised against the card. When this second thermal event occurs, the result is a local processor outage (LPO) and outstanding grant requests shall be completed but no new grant requests shall be accepted, an LPO will take the card out-of-service. If the temperature recedes under the threshold, the LPO condition is cleared and the card can begin operation again.

If the CPU temperature goes above operating limits (approximately 125°C), the CPU will halt and the card will shut itself down to prevent permanent, catastrophic damage. In the event of thermal shutdown all processor activity will cease. If thermal shutdown occurs, the E5-SM4G must then be reseated and allowed to load in order to clear the alarm and resume operation.

Table 3-24 Thermal Alarm Conditions

Board Temperature	E5-SM8G Actions
Temp Level 1 Exceeded	Major alarm raised
Temp Level 2 Exceeded	Critical alarm raised; outstanding grant requests shall be completed but no new grant requests shall be accepted; card state set to out-of-service, maintenance fault.
Temperature abated	Normal operation restored.
Thermtrip - shutdown temperature exceeded	CPU shuts down automatically. Card must be reseated to restore operation once temperature returns to normal operating conditions

The thermal thresholds (Temperature Level1 and Temperature Level2) are user configurable. The user configurable T1 and T2 values will always be less than or equal to the T1 (max) and T2 (max) defined for a particular board type respectively. See [Table 3-25](#) and the `chg-th-alrm` command for more details on thermal thresholds.

Table 3-25 T1 and T2 temperature thresholds

Cards	T1 Max (in Celsius)	T2 Max (in Celsius)	User Configurable T1 range (in %)	User Configurable T2 range (in %)
E5-SM4G	92	95	(73-92)% of T2 max	(74-100)% of T2 max
E5-SM8G-B	83	90	(73-92)% of T2 max	(74-100)% of T2 max

Alarms and LEDs

Three LEDs provide conventional EAGLE card indications of APPL Proc operation, and IMT A and IMT B operation. Four (4) LEDs, two for each port, are used to indicate port and signaling link status.

Table 3-26 Front Faceplate LED Indicators

LED	PORT	ACT
RED		No signal detected
GREEN	Data link active operating at 10/100 Mbps	Signal detected
AMBER	Data link active operating at 1 Gbps	
OFF	Card non-functional	Card non-functional

Figure 3-42 E5-SM8G-B LED Indicators

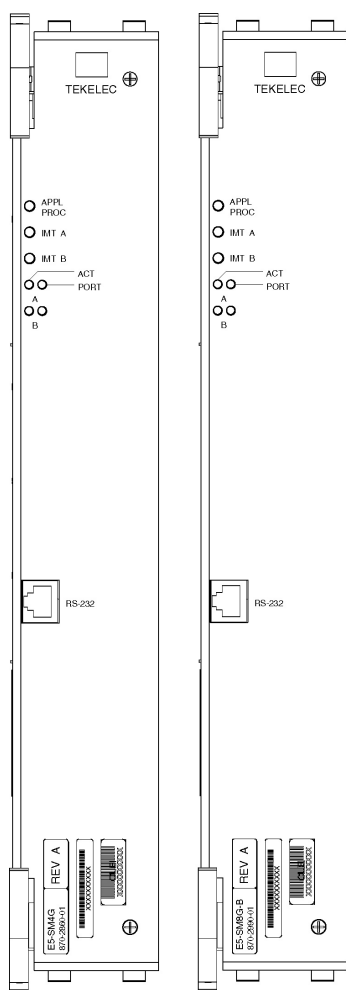

Front Faceplate LED Indicators

LED	Status	Description
APPL PROC	Off	No power
	Red	Card is booting
	Amber	Card is loading
	Green	Card is up and application is running
IMT A	Red	Not connected to bus
	Amber	Testing not complete
	Green	Active and connected to the bus
IMT B	Red	Not connected to bus
	Amber	Testing not complete
	Green	Active and connected to the bus
ACT	Off	Card non-functional
	Red	No signal detected
	Green	Signal detected
PORT	Off	Card non-functional
	Amber	Data link active operating at 1 Gbps
	Green	Data link active operating at 10/100 Mbps

Interface Cable Adapter

An adapter, P/N 830-1104-03, and a CAT 5E cable may be used in place of the existing DCM cable. The adapter is connected to the backplane and the RJ-45 CAT 5E cable is connected from the other side of the adapter to a switch, or a hub, or a patch panel (same place the DCM cable was terminated).

An adapter, P/N 830-1104-xx, and a CAT 5E cable may be used in place of the existing DCM cable. The adapter is connected to the backplane and the RJ-45 CAT 5E cable is connected from the other side of the adapter to a switch, or a hub, or a patch panel (same place the DCM cable was terminated).

Technical Specifications

Table 3-27 E5-SM8G-B Technical Specifications

Physical Characteristics	
Height	14.43 in. (36.65 cm)
Width	2.06 in. (5.23 cm)
Depth	12.80 in. (32.51 cm)

Air Management Card

The Air Management (P/N 870-1824-02) card is an unpowered filler card used to ensure efficient air flow in shelves equipped with fans. Air Management cards are required in all empty slots in the shelf immediately above the fan assembly.

 **Note:**

See "Hardware Baseline Table" in *Release Notes* for compatible fan assembly part numbers.

Figure 3-43 Air Management card

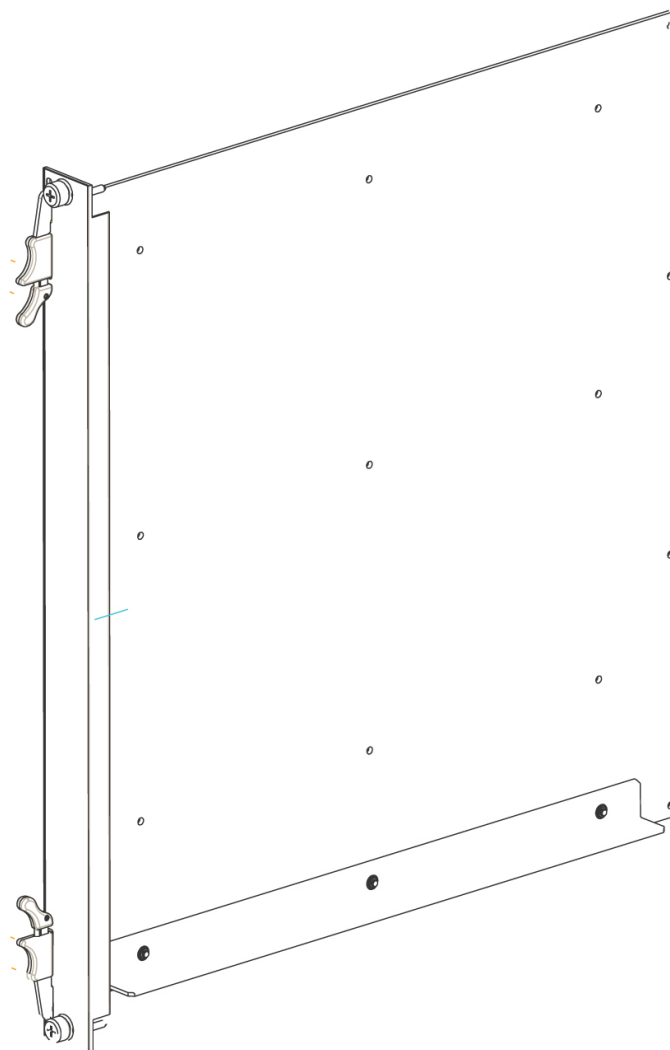

Fan Tray

The **EAGLE** fan tray contains three -48V fans that provide a redundant airflow for thermal management of the shelf. The **EAGLE** fan tray is powered by -48 VDC, at a fused rating of 3A. It has redundant power inputs (A and B). Each input is provided by a **DB-9**, keyed, positive locking connector. The contacts have 30 micro-inches of gold plating.

 **Note:**

Shelves with **HCMIM**, **E5-ENET-B**, **E5-ATM-B**, **E5-MCPM-B**, **E5-SM8G-B** or **SLIC** cards are required to be cooled by a fan tray.

Note:

See "Hardware Baseline Table" in *Release Notes* for compatible fan tray part numbers.

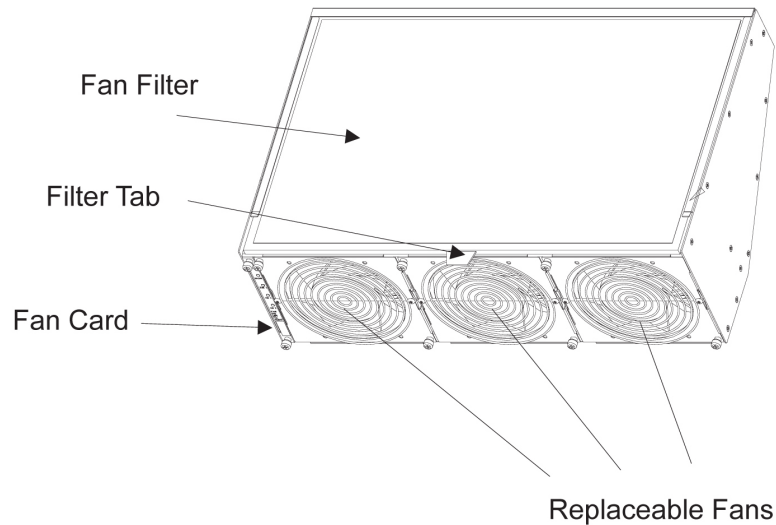
Figure 3-44 Fan Tray

Failover is governed by a fan controller card on the fan tray. The fan tray will provide adequate airflow if there is a single fan failure or during replacement of one of the three fans while the **EAGLE** fan tray is operational. The control card bracket provides mounting for the control **PCB** (P/N 850-0703-01). The control **PCB** inserts into the front face of the fan tray on card guides mounted to the left side wall, and is intended to be a field replaceable item.

The **EAGLE** fan tray is designed to be field installable, with mounting brackets, in both a Heavy Duty frame and a standard frame. There is one disposable air filter in the assembly (P/N 551-0032-01). The filters should be changed once a month.

The **EAGLE** fan tray is designed to be compliant to Bellcore Standards **GR-63-CORE**, **GR-78-CORE**, and **GR-1089-CORE** when mounted in a Heavy Duty Frame or standard frame. The **EAGLE** fan tray is also designed to be **UL** and **CE** compliant. The **EAGLE** fan tray is designed to operate in a Central Office environment with continuous operation at -5°C to 50°C and 5% to 90% **RH** in compliance with **GR-63-CORE**.

Fuse and Alarm Panels

The Fuse and Alarm Panel (**FAP**) provides protected distribution of -48VDC power to the shelves in the frame. The site voltage input to each frame should be between -40VDC and -57.5VDC . Allowing for the full population of a frame and for the failure of one primary supply, new installations of Control and Extension frames require two 60A feeds. See the "Hardware Power Calculator Tool" section in *Hardware* for more information.

The **FAP** is installed at the top of the frame and uses two cables to bring A and B power to the frame. The **FAP** contains two separate circuits, A and B. Current flows from the input terminals to the fuse bus. Protection is provided by fuses placed in fuse holders on the front panel. When a fuse is installed in a fuse holder, the circuit is completed to the output connector.

 **warning:**

Existing frames that are fused at 40 amps may be upgraded to support 60 amps with a FAP upgrade kit. Frames that contain HC-MIMs must be upgraded to support 60 amps. Customers do not perform a FAP upgrade; these upgrades are performed by Oracle Communications personnel.

 **warning:**

The FAP P/N 870-1606-02 Revs A-B can be upgraded to FAP P/N 870-1606-02 Rev C with FAP upgrade kit P/N 840-0139-01. The FAP P/N 870-2320-01 Revs A-I can be upgraded to FAP P/N 870-2320-01 Rev J with FAP upgrade kit P/N 870-0139-02.

 **Caution:**

All personnel associated with the installation of this system must adhere to all safety precautions and protection equipment required to avoid the possibility of injury to personnel, service degradation, and/or service interruption.

 **Caution:**

This is a redundant system to allow service during normal maintenance. When repairs require a total power disconnect, both input supply sources must be disconnected. This will cause service interruption and take down the system.

Fuses

The fuse and alarm panel uses **GMT**-type fuses of different amperage ratings for individual circuit protection. If a frame circuit fuse is blown the alarm is indicated by an **LED** on the front panel and a small colored flag on the fuse shows the fuse that has failed (refer to [Figure 3-45](#)). Refer to *Maintenance* for procedures on replacing fuses and the **FAP** assembly.

 **Caution:**

Always use a fuse of the same type and amperage rating when replacing a failed fuse.

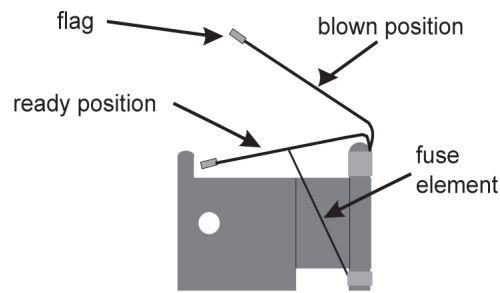
Figure 3-45 Fuse (GMT Brand Shown)**Table 3-28 Fuse Color Codes of Alarm Flags**

Fuse Amp	Fuse Flag Color	Fuse Amp	Fuse Flag Color
0.18A	Orange-Red	2A	Orange
0.2A	Black-Red	2.5A	White-Orange
0.25A	Violet	3A	Blue
0.33A	Yellow-Green	3.5A	White-Blue
0.375A	White-Green	4A	White -Brown
0.5A	Red	5A	Green
0.65A	Black	7.5A	Black-White
0.75A	Brown	10A	Red-White
1A	Gray	12A	Yellow-Green
1.33A	White	15A	Red-Blue
1.5A	White-Yellow		

Fuse and Alarm Panel (P/N 870-2804-01)

The FAP (P/N 870-2804-01) is a low-profile (1U) unit that can be installed in the Control Frame (CF) and the Extension Frame (EF).

The Power Alarm LED indicates the input power state to the FAP. The LED is green when input power is applied to that bus of the FAP and is red when there is no input power to that bus of the FAP. An unlit Power Alarm LED indicates a failed LED or no input power to either bus of the FAP.

Alarm LEDs to indicate Critical, Major, and Minor alarms are located to the left of the diode board. The LEDs indicate alarms generated by the system that are applicable to that frame which the FAP is installed.

The FAP contains a Diode board and a Shorting board. These boards are located at the front center of the FAP. The FAP also contains two fuse blocks, one to the left (A-side) and one to the right (B-side) of diode and shorting boards, consisting of 20 fuse positions each. The Fuse Alarm LED indicates the failure of a fuse.

The diode board in the FAP contains power diodes and circuitry which allow one bus to pick up the entire load when there is a loss of input power on the other bus.

The Shorting board allows the removal of the diode board without taking down the system. This permits periodic maintenance of the diodes without having to power down or remove the

unit from the shelf. For maintenance operation, the Shorting board has to be removed, flipped over, and reinstalled. In the bypass position, both A and B power is connected to the fuse blocks so the diode board can be safely removed. The Shorting board has an LED which is off when the board is in normal operational mode and is green when in the bypass mode of operation. With the Shorting board in the bypass mode, the OR'ing function is not available. Refer to *Maintenance* for additional information to place the FAP into Maintenance Mode of operation.

Figure 3-46 and Table 3-29 describes the front panel configuration of the fuse and alarm panel (P/N 870-2804-01).

Figure 3-46 Fuse and Alarm Panel - Front View (P/N 870-2804-xx)

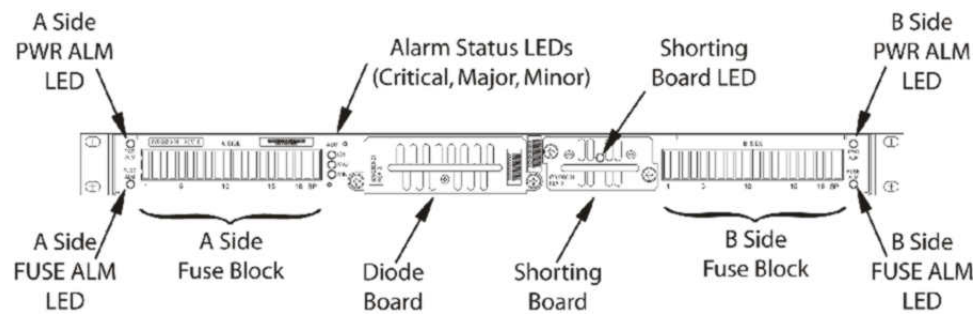

Table 3-29 Fuse and Alarm Panel Front Items (P/N 870-2804-xx)

Fuse Panel Item	Description
Fuse Positions	Two groups of 20 GMT fuses
Shorting Board LED	LED indicator for shorting board.
FuseAlarm	LED indicator for fuse fail alarm
PowerAlarm	LED indicator for input power
CriticalAlarm	LED indicator for critical alarm
MajorAlarm	LED indicator for major alarm
MinorAlarm	LED indicator for minor alarm

Table 3-30 presents possible alarm LED states and corresponding fuse conditions.

Table 3-30 Fuse State and LED condition (P/N 870-2804-01).

Fuse State A side	Fuse State B side	Fuse LEDs A side	Fuse LEDs B side
No fuses blown	No fuses blown	Green	Green
No fuses blown	At least 1 fuse blown	Green	Red
At least 1 fuse blown	No fuses blown	Red	Green
At least 1 fuse blown	At least 1 fuse blown	Red	Red
Shorting board enabled (in bypass mode), Shorting board LED is green.		Red	Red

Table 3-30 (Cont.) Fuse State and LED condition (P/N 870-2804-01).

Fuse State A side	Fuse State B side	Fuse LEDs A side	Fuse LEDs B side
Shorting board in normal operational mode, Shorting board LED is off. No fuses blown.		Green	Green

Figure 3-47 and Table 3-31 describes the rear panel configuration. Refer to *Installation* for cabling connection information.

Figure 3-47 Fuse and Alarm Panel Rear (P/N870-2804-01).

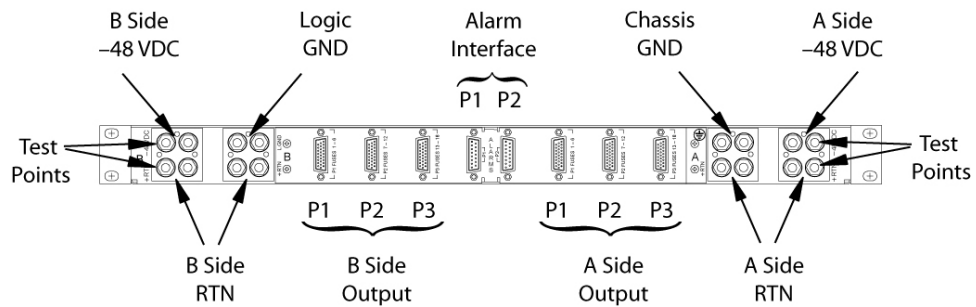

Table 3-31 Fuse and Alarm Panel Rear Items (P/N870-2804-01).

Fuse Panel Item	Description
Input Terminal Block A	Input and Return for power source A and FAP Chassis Ground
Input Terminal Block B	Input and Return for power source B and FAP Logic Ground
-48VDC Outputs A	26-pin "D" connectors for A-side outputs: <ul style="list-style-type: none"> • P1 - Fuses 1 through 6 • P2 - Fuses 7 through 12 • P3 - Fuses 13 through 18
-48VDC Outputs B	26-pin "D" connectors for B-side outputs: <ul style="list-style-type: none"> • P1 - Fuses 1 through 6 • P2 - Fuses 7 through 12 • P3 - Fuses 13 through 18
Alarm Interface	15-pin "D" connectors: <ul style="list-style-type: none"> • P1 to the EAGLE • P2 to a power distribution breaker panel

Table 3-32 presents the power requirements and physical dimensions for the FAP.

Table 3-32 Fuse and Alarm Panel Specifications (P/N 870-2804-01).

Dimensions	
Height	1.75 inches (4.4 cm)
Width	21.5 inches (53.8 cm)
Depth	10 inches (25 cm)

Fuse and Alarm Panel (P/N 870-1606-xx/870-2320-xx)

The **FAP** P/N 870-1606-xx can be installed in standard frames. The FAP P/N 870-2320-xx can be installed in heavy duty frames.

The FAP contains an alarm board, two diode boards, and a jumper board. These boards are located at the front center of the FAP. The fuse holders are to the left and right of these boards as shown in [Figure 3-48](#).

The alarm board contains a FUSELED to indicate a failed fuse (for either bus A or B) and LEDs to indicate Critical, Major, and Minor alarms generated by the system that are applicable to that frame which the FAP is installed.

There are two diode boards in the FAP, one for bus A and one for bus B. Each diode board contains power diodes and circuitry which allow one bus to pick up the entire load when there is a loss of input power on the other bus. An LED indicates the input power state to the FAP. The LED is green when input power is applied to that bus of the FAP and is red when there is no input power to that bus of the FAP.

The Maintenance (Jumper) board allows the removal of one or both diode boards without taking down the system. The Jumper board has two connectors and a connector plug. During normal operation, the connector plug is seated on the first connector. For maintenance operation, the jumper board has to be removed and the connector plug moved to the second connector. In the maintenance position, the connector plug connects both A and B power feeds to the fuse panels so one or both diode boards can be safely removed. The OP/MAINTLED is green when the Jumper board is in normal operational mode and is red when in the maintenance mode of operation. Refer to *Maintenance*.

[Figure 3-48](#) and [Table 3-33](#) describes the front panel configuration of the fuse and alarm panel (P/N 870-1606-xx/870-2320-xx).

Figure 3-48 Fuse and Alarm Panel (P/N 870-1606-xx/870-2320-xx) Front

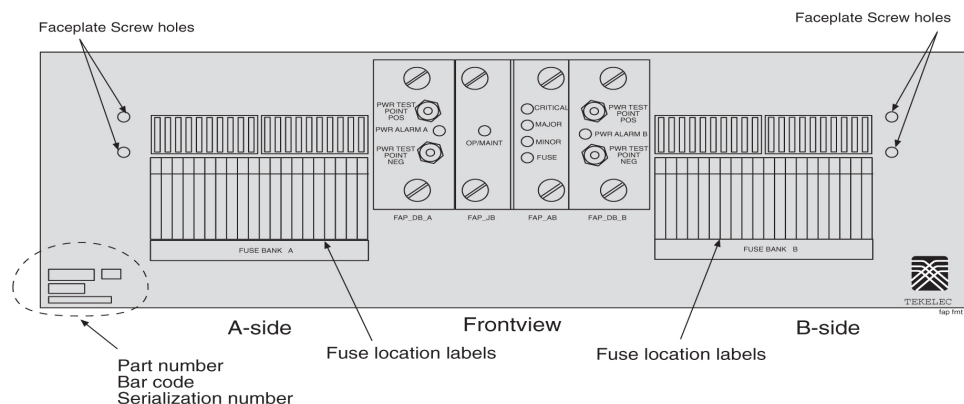

Table 3-33 Fuse and Alarm Panel Front Items

Fuse Panel Item	Description
Fuse Positions	Two groups of 20 GMT fuses
PWR ALARM	<p>LED indicator for A or B diode board input power</p> <ul style="list-style-type: none"> Green - input power applied Red - no input power to board
OP/MAINT	<p>LED indicator for mode of operation</p> <ul style="list-style-type: none"> Green - normal Red - maintenance
FUSE	<p>LED indicator for fuse fail alarm</p> <ul style="list-style-type: none"> Green - normal Red - blown fuse
CRITICAL	LED indicator for frame critical alarm
MAJOR	LED indicator for frame major alarm
MINOR	LED indicator for frame minor alarm

Figure 3-49 and Table 3-34 describes the rear panel configuration of fuse and alarm panel (P/N 870-1606-xx). Refer to *Installation* for cabling connection information.

Figure 3-49 Fuse and Alarm Panel (P/N 870-1606-xx/870-2320-xx) Rear

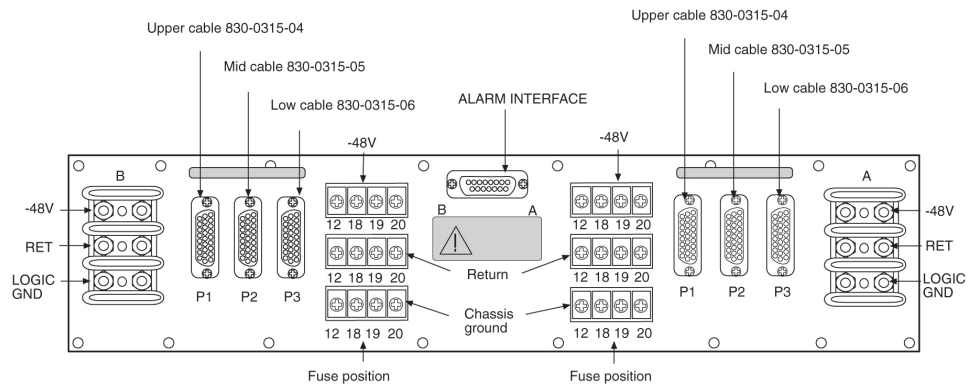

Table 3-34 Fuse and Alarm Panel (P/N 870-1606-xx/870-2320-xx) Rear

Fuse Panel Item	Description
Input Terminal Block A	Logic Ground, Return, and Input for power source A
Input Terminal Block B	Logic Ground, Return, and Input for power source B
Output Terminal Block A	<p>-48VDC, Chassis Ground, and RTN for Fuse location 12, 18, 19, and 20 for side A.</p> <p>These are miscellaneous extra capacity fuses refer to Provision Rules for FAP Fuse Locations .</p>

Table 3-34 (Cont.) Fuse and Alarm Panel (P/N 870-1606-xx/870-2320-xx) Rear

Fuse Panel Item	Description
Output Terminal Block B	–48VDC, Chassis Ground, and RTN for Fuse location 12, 18, 19, and 20 for side B. These are miscellaneous extra capacity fuses refer to Provision Rules for FAP Fuse Locations
–48VDC, Chassis Ground, and RTN Outputs A	26-pin “D” connectors, P1, P2, and P3 for A-side outputs.
–48VDC, Chassis Ground, and RTN Outputs B	26-pin “D” connectors, P1, P2, and P3 for B-side outputs.

Table 3-35 Fuse and Alarm Panel (P/N 870-1606-xx/870-2320-xx) Specifications

	Dimensions
Height	3 inches (7.6 cm)
Width	17 inches (43.2 cm)
Depth	10.25 inches (26 cm)

Provision Rules for FAP Fuse Locations

The following are provisioning rules for fuse placement apply to FAP P/N870-2804-xx:

- Maximum fuse size 3 amp.
- Fuse positions 19 and 20 not used.
- Power feed must originate from the same power source.
- Fuse and Alarm Panel Shorting board in bypass mode must be less than 40 amp per distributed output side.

These provisioning rules for fuse placement apply to **FAPs** P/N 870-1606-xx and P/N 870-2320-xx.

- Maximum fuse size 3 amp for Fuse one through Fuse 18 when P1, P2, or P3 are used for power output
- P2 cannot be used if the Terminal Strip (output) position 12 is used.
- P3 cannot be used if the Terminal Strip (output) position 18 is used.
- Fuse maximum of 15 amp for fuse positions 12, 18, 19, and 20, all other fuse positions are 3 amp.

 **Note:**

For fuse locations 12, 18, 19, and 20, the fuse maximum is 10 amp when adjacent locations are used.

- Power feed must originate from the same power source.

- Fuse and **Alarm** Panel, Jumper Board (P/N 870-1641-01) fuse size on boards 40 amp per side for P/N 870-1606-02 Rev A and B, and for P/N 870-2320-01 Rev A through I. Fuse size on boards 60 amp per side for P/N 870-1606-02 Rev C and 870-2320-01 Rev J.
- Fuse and **Alarm** Panel, Jumper board in maintenance mode must be less than 40 amp per distributed output side.

Holdover Clock

The holdover clock (refer to [Figure 3-50](#)) is an optional device that can maintain clock synchronization for system Digital Signal Level-0 Applique (**DS0A**) links during brief (up to 15 seconds) **Building Integrated Timing System (BITS)** clock signal outages. This follows Telcordia Technology requirements as specified in **GR-1244-CORE**.

The holdover clock is connected to the **BITS** clock source in the system. The **BITS** clock inputs to the system through the control shelf. The device is located in, and receives –48VDC power from, a miscellaneous frame (refer to [Figure 3-51](#)).

Connections from the holdover clock to the system control shelf consist of two clock cables and a cable to signal holdover clock alarm conditions to other parts of the system.

The holdover clock contains the following:

- Maintenance Interface System (**MIS**) (P/N 804-0175-01) card system alarm interface which provides alarms output to the system control shelf.
- Two Critical Status Indicators (**CI**) (P/N 804-0165-01) cards for clock inputs A and B.
- Two Signal Transfer, Stratum-3 (**ST-3**) (P/N 804-0173-01) cards for clocks A and B.
- Three Timing Output Composite Clock Automatic (**TOCA**) (P/N 804-0166-01) cards, clock outputs (**TO1** and **TO2**) for A and B through the system control shelf.

Note:

The **TOCA** cards may be replaced with **TOLA** cards. For wiring information on **TOLA** cards see *Installation*.

- One Matrix Controller Automatic-5 (**MCA**) (P/N 804-0251-01) card controls the output protection switch matrix just above the Data Carrier Detect (**DCD**) **DCD-523** shelf card slots.

The outputs of the **TOCA** cards are connected to a wire-wrap panel mounted on top of the holdover clock. The clock inputs on the system's control shelf are connected to the holdover clock wire-wrap panel.

Figure 3-50 Holdover Clock, Card Location

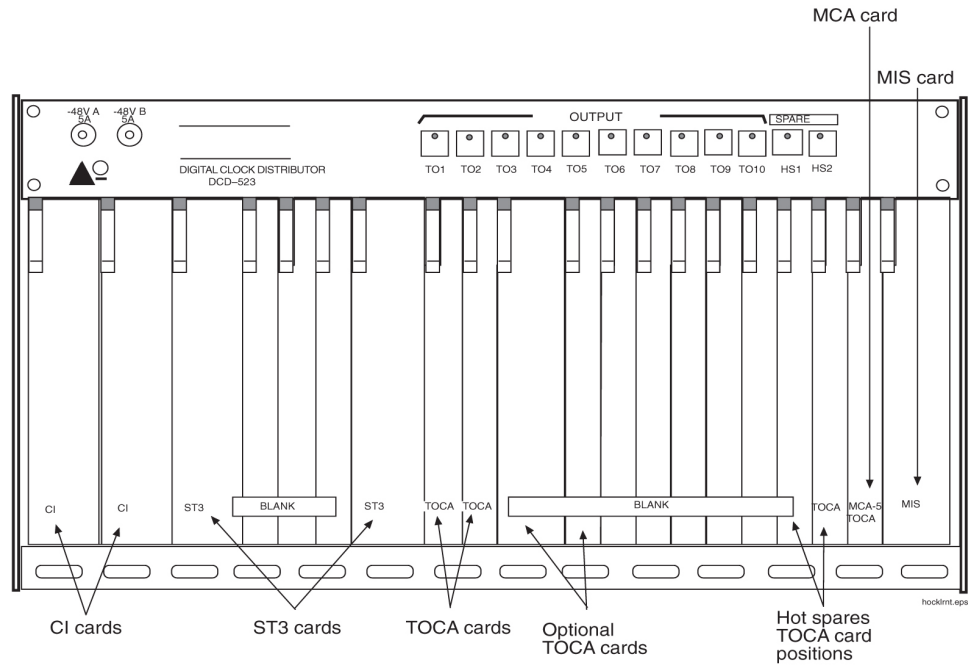
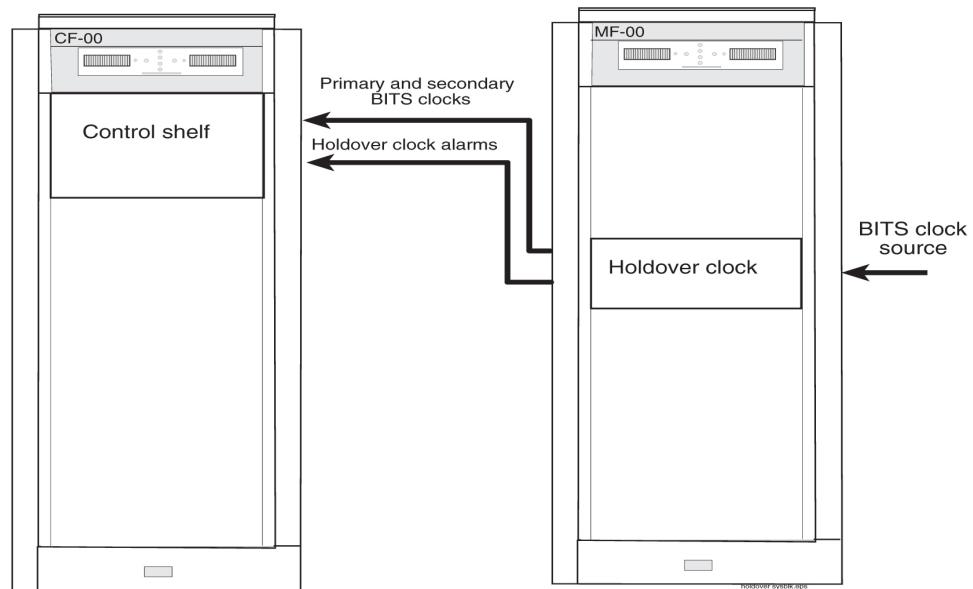

Figure 3-51 Holdover Clock, Frame Connections



Maintenance Interface System Card

The Maintenance Interface System (**MIS**)(P/N 804-0175-01) card provides local and remote command and control for the holdover clock. The **MIS** card is installed in the far right slot of the holdover clock shelf (refer to [Figure 3-52](#) for an **MIS** card block diagram).

The **MIS** provides Data Carrier Detect (**DCD**) alarm summary with office and remote alarm relay closures and status indicators, as well as remote **RS-232** communication.

Output alarms from the Timing Output Composite Clock Automatic (**TOCA**) cards, input reference alarms from the clock inputs, and failure alarms from any card in the shelf are sent to the **MIS** card. Status indications including clock loss and port alarms are also monitored by the **MIS** card.

Depending on which alarms are received, the **MIS** activates audible and visual alarm and Status Indicator (**SI**) outputs. An additional set of status leads on the back enables either a major, minor, or critical alarm in the event of the failure of a battery or blown fuse.

 **Note:**

Major, minor, and critical alarm leads have both Normally Open (**NO**) and Normally Closed (**NC**) dry relay contacts. Major, minor, and critical status indicators have **NO** relay contacts only. All other Status Indicators are open-collector outputs between the **SI** lead and battery return.

Alarm battery supply is not required for the system. When **DC** power is lost to the shelf, the normally open relays close, initiating an office alarm (refer to [Figure 3-52](#)).

Figure 3-52 Maintenance Interface System Card Block Diagram

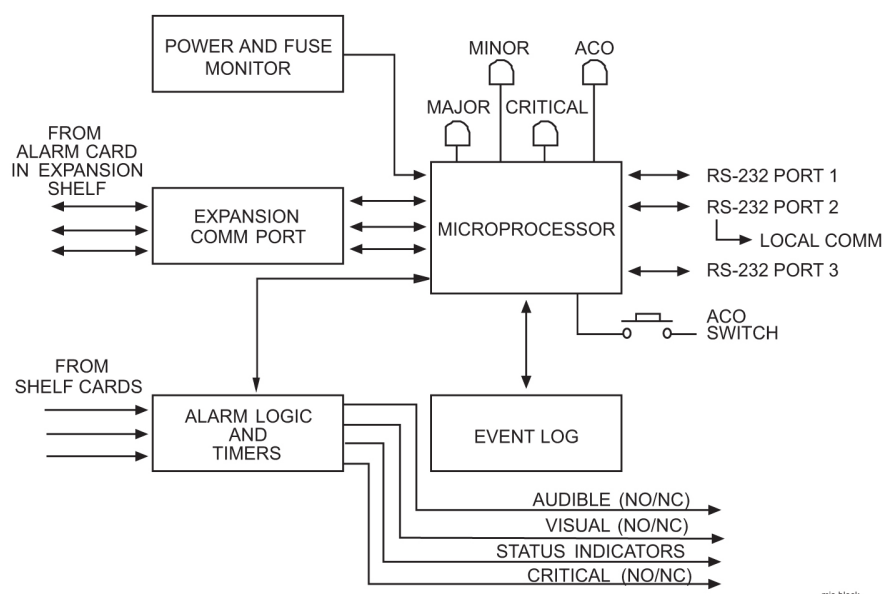

A front-panel **Alarm** Cut Off (**ACO**) push button, when pressed, silences the audible alarm and lights the **ACO** lamp. The **ACO** push buttons on all shelves in the system have the same effect. An external lead on the shelf backplane is provided for remote **ACO** operation.

The status of the shelf is available at the front panel lamps. A Major, Minor, or Critical lamp lights to indicate that one of those alarms exists on the shelf. The Fail lamp lights to indicate the **MIS** card has failed. The **Alarm** Cut Off (**ACO**) lamp lights when the **ACO** push button, is pressed to silence an audible alarm, before the alarm is cleared.

Critical Status Indicators Card

Two **Card Indicator (CI)**(P/N 804-0165-01) cards, provide input signal redundancy. Each **CI** card uses one Common **Channel (CC)** or one Digital Signal Level 1 (**DS1**) input as its timing reference. A switch on the **CI** card selects the type of input and the framing format, if **DS1**, of the input timing signal. Front panel lamps (**CC** and **DS1**) show which type of input is present.

Under normal operating conditions, **CI A** drives clock card A, and **CI B** drives clock card B. Both input reference signals are simultaneously monitored, and if an input fails, the clock card automatically switches to the other **CI** card, which then supplies both clock cards until the failed reference is restored. The **SOURCEACTIVE** lamp on the front panel indicates which **CI** card is on-line.

The **CI** card contains a source control circuit that causes the card to switch to the redundant **CI** card if the primary card, defined as the card currently in operation, fails.

Transfer between **CI** cards can be manually initiated by pressing the front-panel **XFR** switch on either **CI** card.

Switching activity between **CI A** and **CI B** will not cause the timing outputs to transmit phase hits, as the phase information of the active signal is transferred to the redundant **CI** card before switching. A Phase Locked Crystal Oscillator (**PLXO**) keeps the **CI** output stable while the transfer takes place. The **PLXO** also removes any phase jitter from the incoming signal before it passes the reference to the Timing Output Composite Clock Automatic (**TOCA**) cards.

If both **CI** cards fail, the clock cards go into holdover mode, and the system automatically uses the active clock card.

Stratum-3 Card

The Signal Transfer, Stratum-3 (**ST-3**) (P/N 804-0173-01) clock card provides timing signals at Stratum-3 accuracy to the **TOCA** cards. Select logic on each **TOCA** card automatically chooses the input timing signal of the highest priority.

The **ST-3** card is based on Phase Lock Loop (**PLL**) filtering and **VXCO** technology. The **ST-3** is a relatively wide-bandwidth, fast-tracking clock that provides the necessary jitter attenuations and holdover stability. The **PLL** output is compared to a Temperature-Compensated Oscillator (**TCXO**), and an offset is generated to phase lock to the clock input, A or B.

If an input source is unavailable or has failed, the circuit goes into clock holdover mode at the frequency of the last valid input. If the holdover clock is started without an input reference, the **ST-3** maintains accuracy at a predetermined rate.

If both **ST-3** cards fail, a major system alarm is issued and the **TOCA** cards use the output of the clock input cards.

A phase build out circuit between the two clock input cards, A and B, and each **ST-3** clock prevents transients from being transmitted to the Timing Output (**TOCA**) cards when there is a transfer between the two **ST-3** cards.

TOCA and TOLA Cards

A Timing Output Composite Clock Automatic (**TOCA**)(P/N 804-0166-01) card, provides 10 composite clock timing outputs. There is a third **TOCA** card in the hot spare slot.

A source select circuit obtains the timing signal from either **ST-3** clock card A or B. If no input timing signals are present, the **TOCA** card turns off both its **ST-3** and **INPUT** lamps, lights the **FAIL** lamp, and mutes the outputs.

A Phase Lock Loop (**PLL**) circuit reconstitutes the internal timing signal. The reconstituted Computer and Communications (**CC**) timing signal is then applied to each port driver and sent through an impedance matching transformer.

The outputs are fed to the interface panel.

If the **TOCA** card fails or the output monitor determines that one to five output drivers have failed or are shorted, the front panel **PORTALM** lamp lights, and a minor alarm is generated.

Whenever manual or automatic protection switching takes place, the **TOCA** cards automatically transfer option switch settings to the hot spare, **TOCA** card.

 **Note:**

An **OEM** purchased Timing Output Logic Automatic (**TOLA**) can be used as a composite clock source. The output cable connections are different from the **TOCA** card pin outs. See *Installation* for instructions about cabling both the **TOCA** and **TOLA** clock outputs.

MCA Card

The Matrix Controller Automatic-5 card (**MCA**)(P/N 804-0251-01) controls the output protection switch matrix just above the holdover shelf and card slots on the hold over clock. It monitors the protection matrix push-button for activation. The **MCA** card requires the presence of at least one Hot Spare (**HS**) **TOCA** card in the slots provided immediately to the left of the **MCA**. Each holdover clock shelf contains slots for two hot spare **TOCA** cards.

The **MCA** card monitors the protection matrix for activation and the **TO** cards for port and fail alarms. When an active **TO** card indicates a failure or is removed, the **MCA** activates the relays and lamps in the protection matrix and switches in the appropriate hot spare **TOCA** card, if installed.

To ensure that a hot spare **TOCA** card cannot be accidentally placed in service or accidentally taken out of service, activating the hot spare **TOCA** card requires that the **MCA** detect a timing output failure or the front panel be pressed in the correct sequence. In addition, no switch occurs if the **MCA** card is physically removed from the shelf.

 **Note:**

The **MCA-5** can only switch from one **TOCA** to a hot spare **TOCA** at a time. There are six different **TOCA** card types and two hot spare **TOCA** slots per shelf.

Figure 3-53 MCA-5 Card and Output Protection Matrix

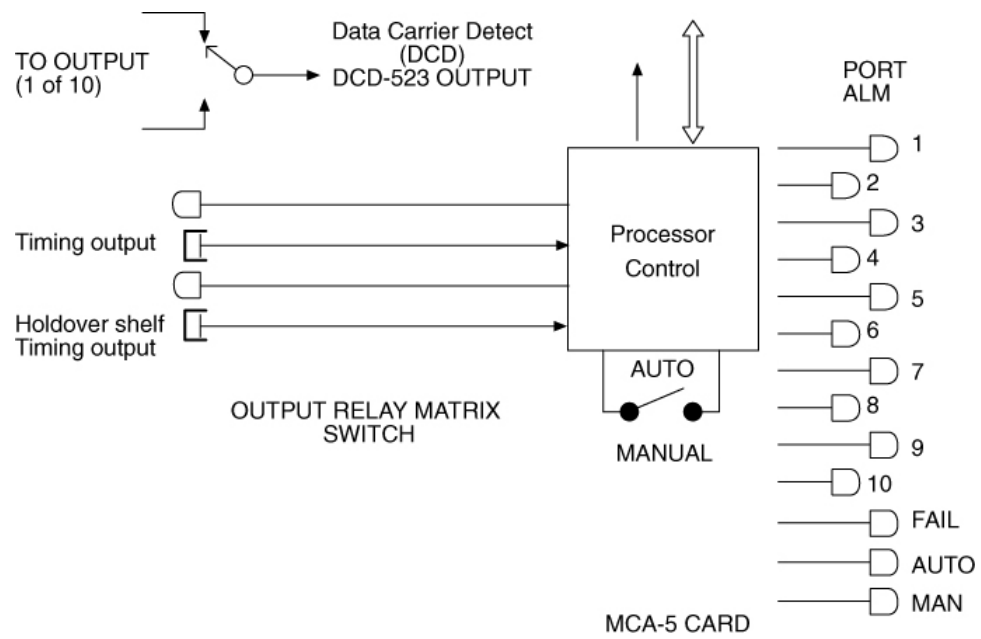

4

Hardware Descriptions - OEM-Based Products

OEM-Based Product Descriptions

Original Equipment Manufacturer (**OEM**)-based products use Common Off-The-Shelf (**COTS**) components configured in a standard or heavy-duty frame. Systems are configured at an Oracle Communications site for **NEBS** compliance and typically have redundant components for reliability and maintainability. **OEM**-based products support application specific services that interact with the **SS7** and **IP** networks.

Note:

Elements used in **OEM**-based products have components configured by Oracle Communications to conform to **Network Equipment-Building System (NEBS)** generic equipment requirements.

topple:

Systems with slide shelf mounted equipment must also be anchored to the overhead cable racks. Before beginning installation, ensure the frame is properly secured to the floor and overhead cable racks to prevent the frame from tipping over when the server slide shelves are extended.

Extended Services Platform (ESP) Host Servers

This section describes the parts of the **ESP** server nodes. An **ESP** server can monitor a maximum of 32 **SS7** links. **ESP** server nodes are populated in an N + 1 configuration for redundancy to a maximum of 17 in an **ESP** subassembly frame. **ESP** server nodes are rack mounted in heavy-duty frames.

The **ESP** server node is a one-processor device and has no frame buffer, audio capability, mouse port, or keyboard port. The console ports and Ethernet ports are the primary interfaces of model 120 server.

The server node provides the following:

- High performance processor.
- Modular internal design.
- High performance disk, system, memory and I/O subsystems.
- High performance Peripheral Component Interconnect (**PCI**)/Serial Asynchronous Interface connection I/O (8 port break-out box).
- Redundant hot swap power supply units.

- Powered by redundant –48VDC supplies.

Server Model 120 Features

The server primary board contains the Central Processing Unit (CPU) module, memory, system control Application-Specific Integrated Circuits (ASICs) and I/O ASICs.

Table 4-1 System Specifications

Server Node Specifications	
Dimensions and Weight	
Height	44.0 mm (1.73 in.)
Width	437.2 mm (17.21 in.)
Depth	487.4 mm (19.19 in.)
Weight (unpacked but fully configured)	10kg (22 lbs.)
CPU	
Processor type	UltraSPARC-II
Clock rate	650 MHz
CPU provided	One Processor (NEBS level 3 compliant)
Cache on module	256 Kbyte Internal
Memory	
Size	4GB maximum
Memory type	PC133 standard Registered DIMMs
Storage (Internal)	
Bus	66MB/second UltraSCSI
Disks	Two 3.5x1-in. disks (36GB); disk bays are front accessible and support hot-plug
CD-ROM	644MB Slim line CD-ROM drive; 24X speed or DVD-ROM
I/O Architecture	See Note:
PCI Interface/Serial Asynchronous Interface connection	Two RS-232C/RS-423 serial ports (RJ45) Expansion Serial port interface.
Serial ports	Two Ultra-SCSI port
I/O ports	Two standard 10/100BASE-T ports
Operating System	Solaris 8

 **Note:**

ESP server 1A (top server) has an expansion serial board connected by cable to the serial break-out box. ESP server 1B through 1-Q are accessible only through the standard Ethernet ports and serial ports.

Figure 4-1 ESP Server Front and Rear Views

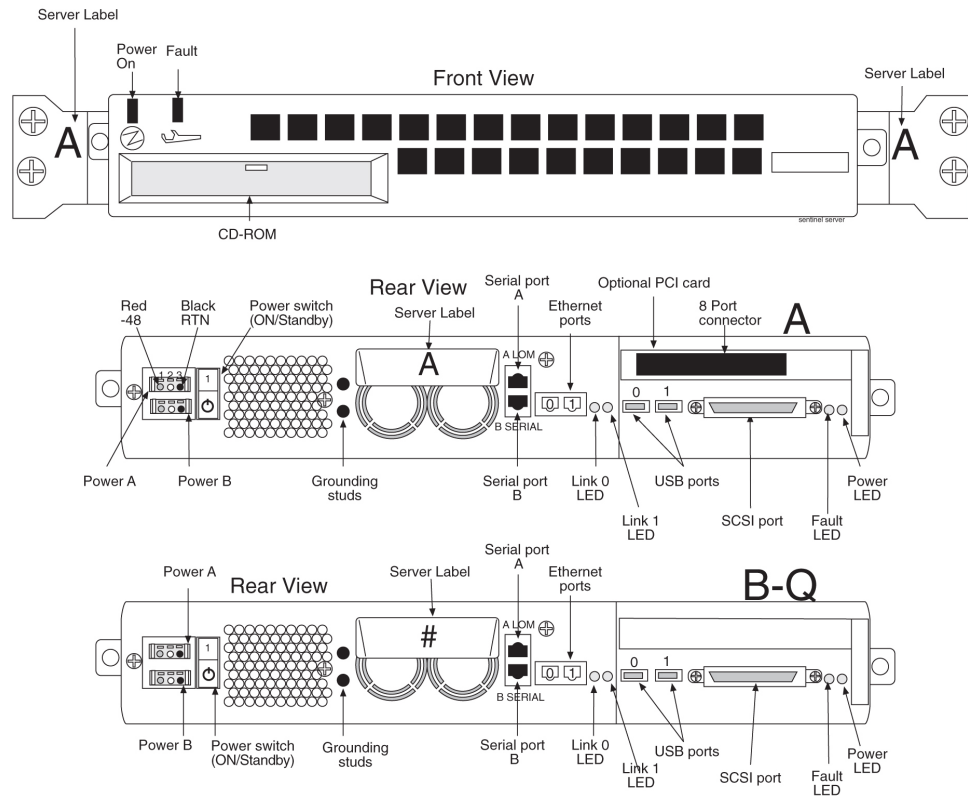

ESP Server LEDs

Table 4-2 lists the LED indicators of the ESP servers. The LEDs are located on the front and back of the ESP servers.

Table 4-2 ESP Server LEDs

Location	LED Name	Color	Description
Front and Rear Panel	Power	Green	Power feed available and Standby/on switch ON
Front and Rear Panel	Fault	Yellow	<ul style="list-style-type: none"> ON Operating system stopped OFF No faults detected Blinking — Fault detected
Rear Panel	Link Activity	Green	One LED for each standard IP interface (two)

SAI/P Card

The Sun SAI/P card (Serial Asynchronous Interface PCI Adapter) is used with the 8-Port Connector Box to provide eight programmable ports for low-speed devices for 50 bps to 115,200 bps transmission for the ESP subsystem. This module is installed in the expansion slot in ESP server 1A only.

8-Port Connector Box

The 8-Port Connector Box segments the output of the Sun SAI/P card into eight ports for the ESP subsystem. This box connects to the Sun SAI/P card with a 78-pin plug on a 40-inch cable in ESP server 1A only. Figure 4-2 shows the details of the Connector Box.

Figure 4-2 8-Port Connector

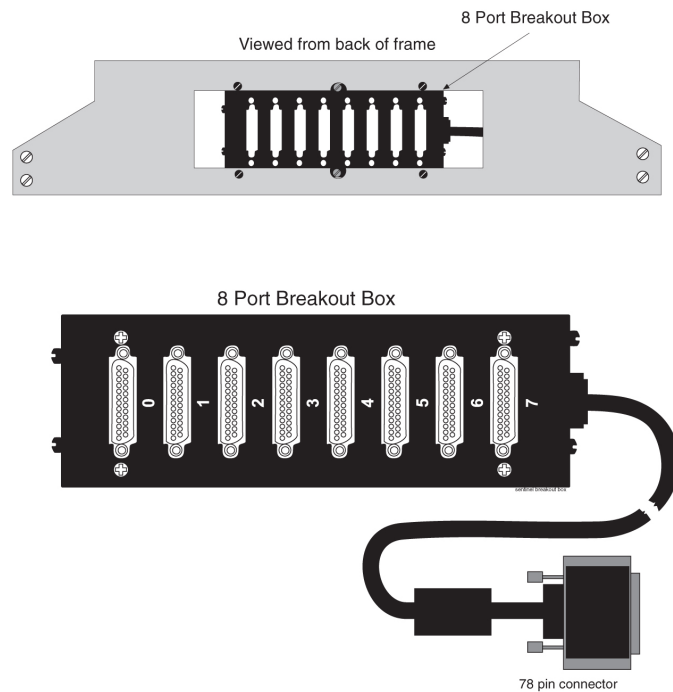

OEM-Based Networking Elements

This section describes the common networking elements that can be used in **OEM**-based products. Networking elements of **OEM**-based products provide the connections and communications links for interworking between the **SS7** networks, local customer networks, and the Internet.

Note:

Some **OEM**-based products do not use all of the networking components, for example, the **MPS** systems. Use [Baseline Tables](#) to determine the specific components that can be configured in system releases.

Common networking components described in this section include:

- [Routers](#)
- [Ethernet Switches](#)
- [OEM-Based Peripheral Elements](#)

Routers

The routers used in **OEM**-based products are configured by Oracle Communications for **NEBS** compliancy. Two types can be configured; isolation routers and dial-in routers.

Note:

Some **OEM**-based products do not use routers, for example, the **MPS** systems. Use [Baseline Tables](#) to determine the specific components that can be configured in system releases.

The isolation routers provide 10/100Mbps communications between the customer **LAN** or dedicated network and the IP7 Front End, hubs, and host servers. [Figure 4-3](#) shows the front view of the routers and [Table 4-3](#) describes the **LED** indicator functions on the front of the router.

Figure 4-3 Front View Routers

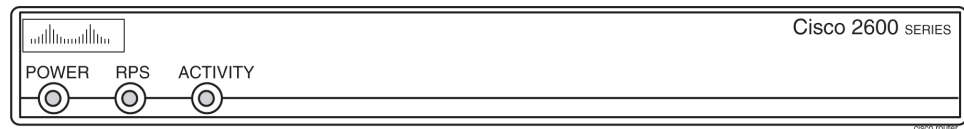

Table 4-3 Router Front LEDs

LED	Description
PWR	Indicates when power is present to the router and the power switch is in the ON position.
RPS (Always OFF)	Off when the redundant power supply is not present. On redundant power supply is present and functional.
Activity	Off-No network activity Blink-Network activity

[Figure 4-4](#) and [Figure 4-5](#) show rear views of the Isolation and Dial-In routers. **Link (LNK)** and activity (**ACT**) LEDs are located near each ethernet port at the rear of the routers. [Table 4-4](#) describes the **LED** indicators on the rear of the routers.

Figure 4-4 Rear View Isolation Router

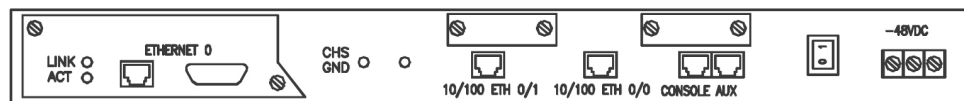

Figure 4-5 Rear View Dial-in Router

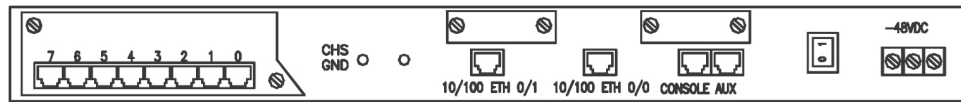

Table 4-4 Router Rear LEDs

LED	Description
LNK	Indicates link is established to far end connection.
ACT	Blink-indicates data activity on the link.

Ethernet Switches

The following section provides an overview of the Ethernet LAN switches used in some OEM products. The ethernet switches cross-connect the components in the frames functioning as an internal Local Area Network (LAN). The switches support 24 auto-sensing 10/100Mbps ports each.

Figure 4-6 illustrates the front and rear of the Ethernet switch.

Figure 4-6 Ethernet Switch

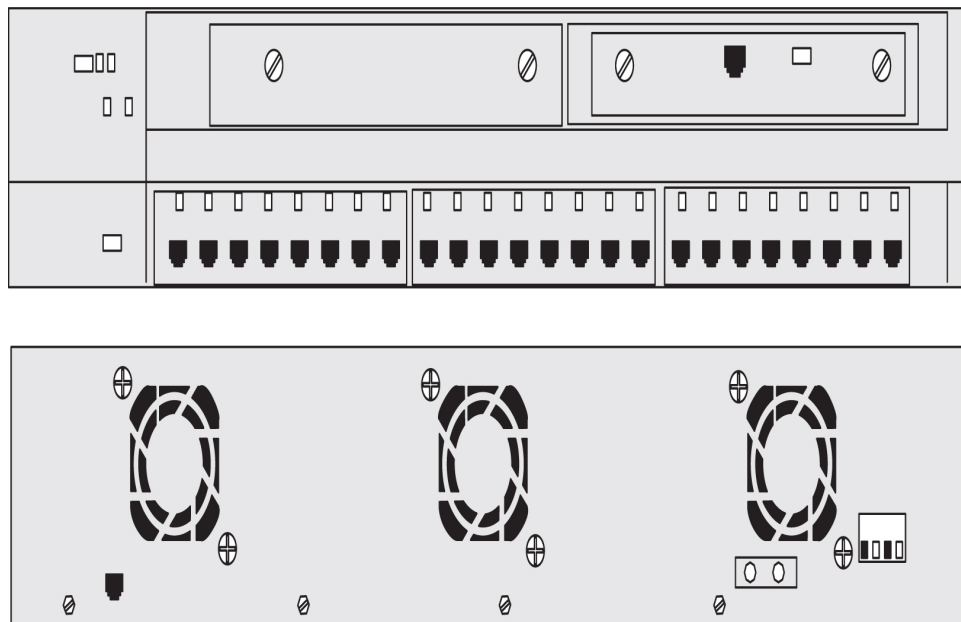



Table 4-5 describes the LEDs located on the front of the switches.

Table 4-5 Ethernet Switch LEDs

LED	Description
System	Green -Indicates when power is present to the switch and the power switch is in the ON position. Amber -Indicates power is present but system is not functioning properly
1 and 2	Indicates expansion boards WS-X2932-XL are installed and functioning LED 1 (Left board) LED 2 (Right board)
RPS (Always OFF)	Off when the redundant power supply is not present. Redundant power supply is not configured
Pressing the MODE switch on the front of the WS-C2924-XL-EN changes the per-port LED indications to the following.	
STAT (port status) Default	Off -No link. Solid green -Link present. Flashing green -Activity. Port is transmitting or receiving data. Alternating green/amber -Link fault. Error frames can affect connectivity, and errors such as excessive collisions, CRC errors, and alignment and jabber errors are monitored for a link-fault indication. Solid amber -Port is not forwarding. Port was disabled by management or an address violation or was blocked by Spanning Tree Protocol (STP).
<div style="border-left: 2px solid #0070C0; padding-left: 10px; margin-left: 20px;">  Note: After a port is reconfigured, the port LED can remain amber for up to 30 seconds as STP checks the switch for possible loops. </div>	
UTL (utilization)	Green -The LEDs display backplane utilization on a logarithmic scale all port LEDs are green, the switch is using 50 percent or more of its total bandwidth capacity. If the right-most LED is amber, the switch is using less than 50 percent of its total bandwidth. If the LED to the left of the right-most LED is amber, the switch is using less than 25 percent of its total capacity, and so on.
FDUP (port full-duplex)	Off -Port is operating in half duplex. Green -Port is operating in full duplex.
100 (port speed)	Off -Port is operating at 10 Mbps. Green -Port is operating at 100 Mbps.

OEM-Based Peripheral Elements

Peripheral elements used in the **OEM**-based products are common components required to provide service functionality. Peripheral components described in this section are:

- [Breaker Panels](#)
- [Eight-Port Connector Box](#)

Breaker Panels

The following section describes the components of the Telect Breaker Panels (**BP**) used in **OEM**-based products. The **BPs** provide the following features:

- Dual-feed power inputs (Input A and Input B) to each breaker panel, totalling four breakers for the system. (30-amp domestic or 32-amp international)
- Maximum of fourteen breakers each breaker panel
- Breaker panels accept circuit breakers up to 20 ampere rating
- Visual A and B input power alarms with single remote dry contact indicator
- Replaceable alarm card

 **Note:**

The drip tray, located under the breaker panels, is designed to assure compliance with **NEBS**, **UL**, and **CE** safety requirements, aiding damage control in the event of a fire. See [Figure 4-7](#) for the location of the breaker panel drip tray.

[Figure 4-7](#) shows the details of the front view of the breaker panel

Figure 4-7 Telect Breaker Panel Front View

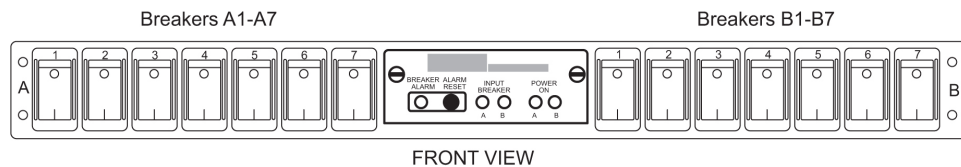

[Figure 4-8](#) shows the rear details of the breaker panel.

Figure 4-8 Telect Breaker Panel Rear View

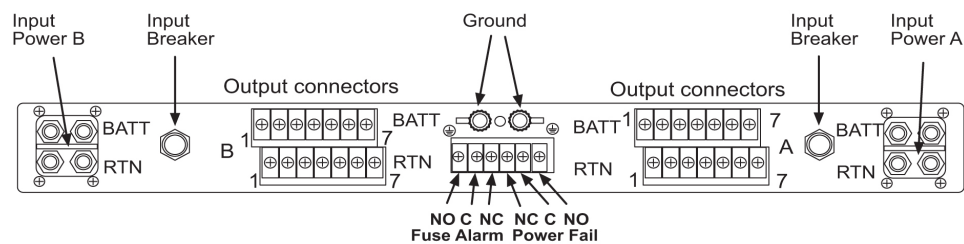

 **Note:**

When breakers trip to the half-way position as a result of an overload they must be switched completely **OFF** then **ON** to reset.

Figure 4-9 provides details of the alarm panel on the Telect Breaker Panel.

Figure 4-9 Telect Breaker Panel Alarms

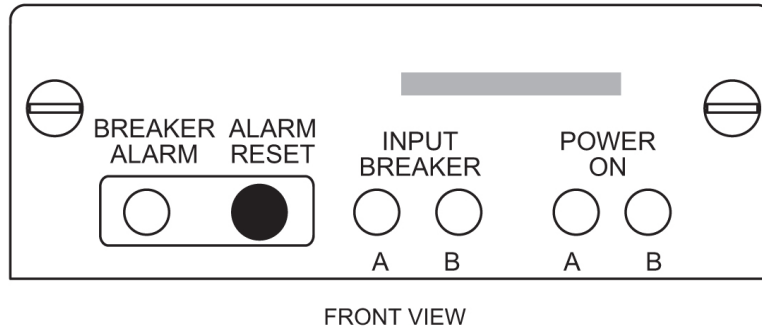

Table 4-6 lists the status **LEDs** on the Telect Breaker Panel.

Table 4-6 Breaker Panel LEDs

LED	Color	Description
Power On A	Green	Lights whenever Side A is receiving input power (LED will remain lit even if the input breaker has tripped)
Power On B	Green	Lights whenever Side B is receiving input power (LED will remain lit even if the input breaker has tripped)
Breaker Alarm	Red	Lights whenever an output circuit breaker has tripped or turned off
Input Breaker A/B	Green	Lights whenever Side A/B is receiving input power (Not lit if input breaker is tripped)

 **Note:**

If all breakers are not turned on, the alarm **LED** will light. To turn off the alarm **LED**, press **RESET** and the alarm **LED** will reset and turn off.

Eight-Port Connector Box

This sections shows the Eight-Port Connector Box used in the Sentinel and AXi systems.

Figure 4-10 Eight Port Breakout Box

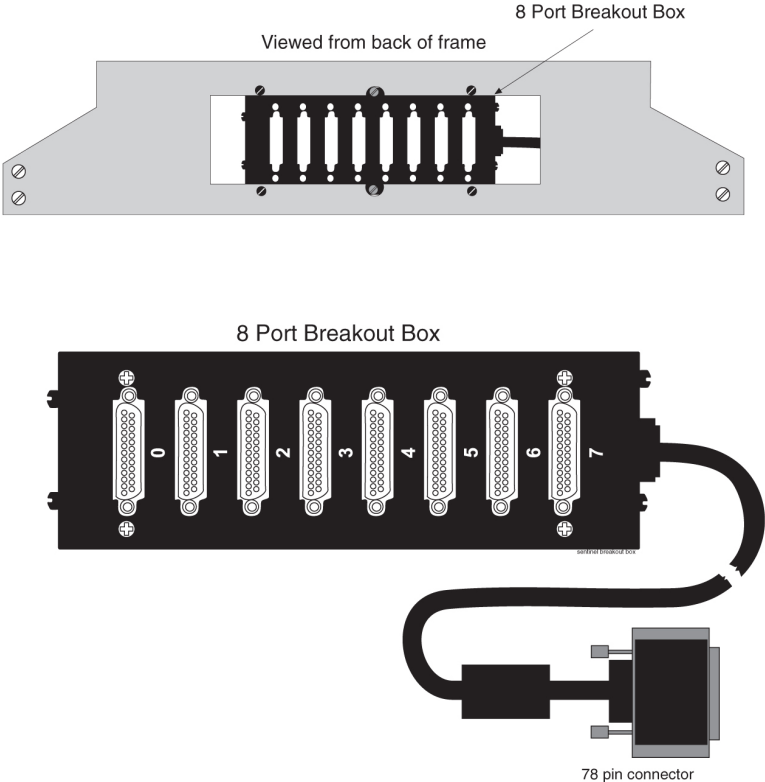

5

Site Engineering - EAGLE

Safety and Cautionary Information

NOT_SUPPORTED:

At least two people are required to safely move and position the frames.

NOT_SUPPORTED:

No commercially AC powered equipment may be used or placed within 7 ft. of –48VDC equipment. This may create a shock or current loop that can be severely hazardous to personnel and equipment.

 **topple:**

Frames with sliding shelves must be securely anchored to the floor and overhead frame racks. Extending a shelf without correctly anchoring the frame can cause it to topple, endangering personnel and damaging equipment.

Introduction

This chapter contains procedures for preparing the site for the installation of signaling products and is intended for use by personnel involved in planning and executing an installation. This chapter also provides power, environmental, and floor plan requirements relating to that installation.

This chapter covers only those areas unique to Oracle Communications systems and does not cover common telecommunications installation requirements.

Location

The system is designed to be installed and operated in a central office environment.

Local fire protection codes must be satisfied in the equipment room where the system is to be located.

Space Requirements

This system equipment is housed in 7 foot high, 23 inch wide, floor supported, unequal flange upright frames. Separator panels, and end panels add to the width of multiple frame systems.

The floor area taken up by this system is:

- 1 frame = 30 inches wide by 22 inches deep = 660 square inches (4.6 square feet)
- 2 frames = 62 inches wide by 22 inches deep = 1364 square inches (9.5 square feet)
- 3 frames = 94 inches wide by 22 inches deep = 2068 square inches (14.4 square feet)
- 4 frames = 126 inches wide by 22 inches deep = 2772 square inches (19.3 square feet)
- 5 frames = 158 inches wide by 22 inches deep = 3476 square inches (24.1 square feet)
- 6 frames = 190 inches wide by 22 inches deep = 4180 square inches (29 square feet)

The number of frames required for an installation is described in the Initial Sales Order for that site. The number of frames is determined by the space required by the module population of the system and optional items such as holdover clocks. See the *Planning Guide, STP, LNP, and LSMS* for information on populating the system.

When planning the installation, be sure to take into account spare module storage, modems, terminals, printers, cross connect panels, and all other items that might require space in a system.

Lighting

Adequate lighting should be provided in the room where the equipment is to be located. Lighting fixtures must be far enough from the equipment and cables to prevent heat damage and to allow safe access to equipment and cables.

Building Requirements

The building requirements for this system are standard telephony industry requirements for equipment installation.

The building must provide a clear, uncluttered route between the loading/receiving dock and the planned system location. In order to move the equipment to the proper location, recommended hall clearance is at least 4.5 feet (1.4 meters) wide by 8 feet (2.4 meters) tall.

Four foot, (1.2 meter) side aisles should be used to allow maneuvering frames into place and provide ample work space around the equipment.

The room selected for system installation should be large enough so the system frames can be at least 2.5 feet (76 cm) from the walls for front and rear access and at least 12 inches (31 cm) for side access.

Earthquake Resistance

All of the configurations are designed to assure the system remains operational during and after an earthquake, even when the system is located on the upper floors of a zone 4 central office.

Environmental Requirements

The environmental conditions for the system must be maintained to the following ambient temperature and humidity specifications:

- Normal operating temperature — +41° F to +104° F, (+5° C to +40° C)
- Maximum rate of temperature change — 15° F, (8° C)/hour
- Normal operating relative humidity — 5% to 85%
- Short-term relative humidity — 5% to 90% (not to exceed 0.024 kg of water per kg of dry air)
- Altitude — 200 feet (60 meters) below to 13,000 feet (3,900 meters) above sea level

 **Note:**

Short-term is a period of not more than 96 consecutive hours and a total of not more than 15 days in one year.

 **Note:**

Ambient is to conditions at a location 1.5 m (59 in) above the floor and 400 mm (15.8 in) in front of equipment.

 **Note:**

HIPR2 is fully NEBS compliant. However, if ambient temperatures above 40° C are likely, Eagle Fan Trays are recommended to ensure proper airflow to the upper HIPR2 cards in those shelves. See "Hardware Baseline Table" in *Release Notes* for compatible fan tray part numbers.

Heating Ventilation and Air Condition Requirements

To maintain the required temperature range, Heating, Ventilation, and Air Conditioning (**HVAC**) equipment should have the capacity to compensate for up to 1230 **BTUs/hr** for each installed system shelf.

The required **HVAC** capacity to compensate for a miscellaneous frame varies depending on the customer previously installed equipment. To calculate needed **HVAC** capacity, determine the wattage of the installed equipment and use the following formula: watts x 3.413 = **BTUs/hr**.

Floor Loading

It is recommended the floor or raised sub-flooring have a distributed load capacity of no less than 100 pounds per square foot (453 kg/m²). The floor loading is determined by using the following equation:

Total equipment weight/floor area = distributed floor capacity.

Following are the maximum weights of frames:

- Maximum weight of **EAGLE** Control or Extension frames: 850 lbs (386 kg).
- Maximum weight of a four E5-APP-B card frame with six Telco Switches: 500 lbs (226 kg).

See [Space Requirements](#) for the floor area of the combined system.

Grounding

The system operates as a digital isolated ground plane system in a central office environment and requires a single connection to the central office ground window. The system's ground bars and ground cables must provide the sole grounding connection between the entire system and the central office grounding.

The system uses three types of grounding paths:

- Battery return
- Frame/chassis ground
- Logic ground

Non-oxidizing grease will be applied to all lugs terminated on a copper system ground bar. Refer to [Figure 5-1](#).

The power return grounding path is the return path for all –48VDC loads in the system. This path is isolated from other system grounds and connects to the rest of the central office through the –48VDC return connections located on the Fuse and **Alarm Panel (FAP)** of each frame.

The frame/chassis ground path provides a low impedance connection for all metal parts of the entire system, including the frame, doors, card cages, and end panels. Each frame/chassis connection within the system lineup terminates to the frame and connects to the main ground bar by way of Htaps, #6 American Wire Gauge (**AWG**) to 1/0 cable.

The logic ground path provides a common voltage reference point between all circuit boards of a system. Each connection terminates to the system ground bar on the control frame.

The frame/chassis and logic ground paths are both noncurrent carrying paths.

warning:

The power (-48 VDC) and return connections of **FAP** (P/N 870-0243-08) and (P/N 870-1606-xx) are physically reversed at the input terminal. See [Figure 5-1](#) and [Figure 5-2](#) for wiring information.

Figure 5-1 Logic Grounding with FAP (P/N 870-0243-08)

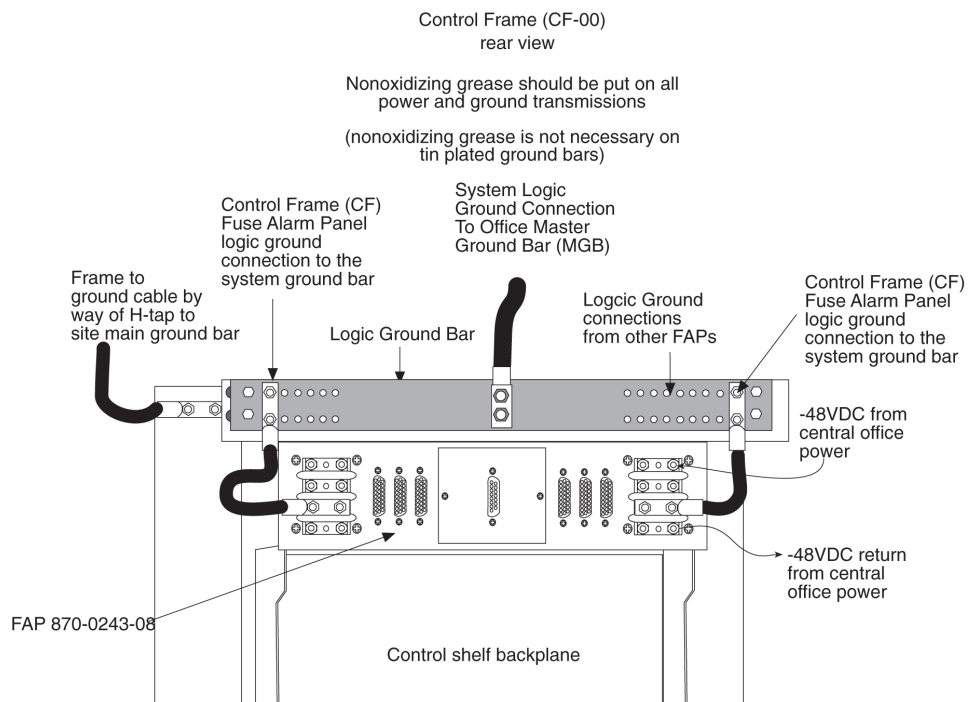
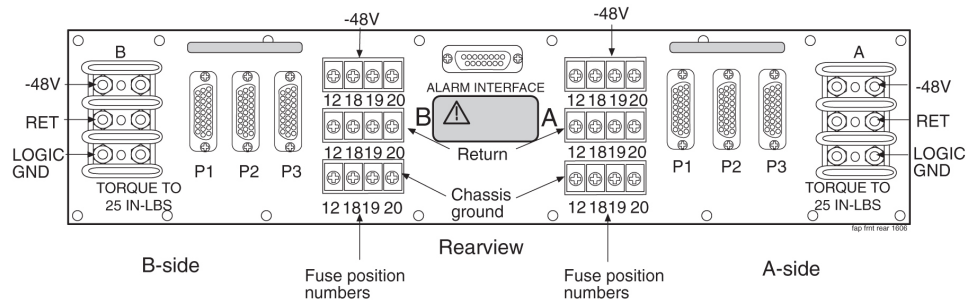
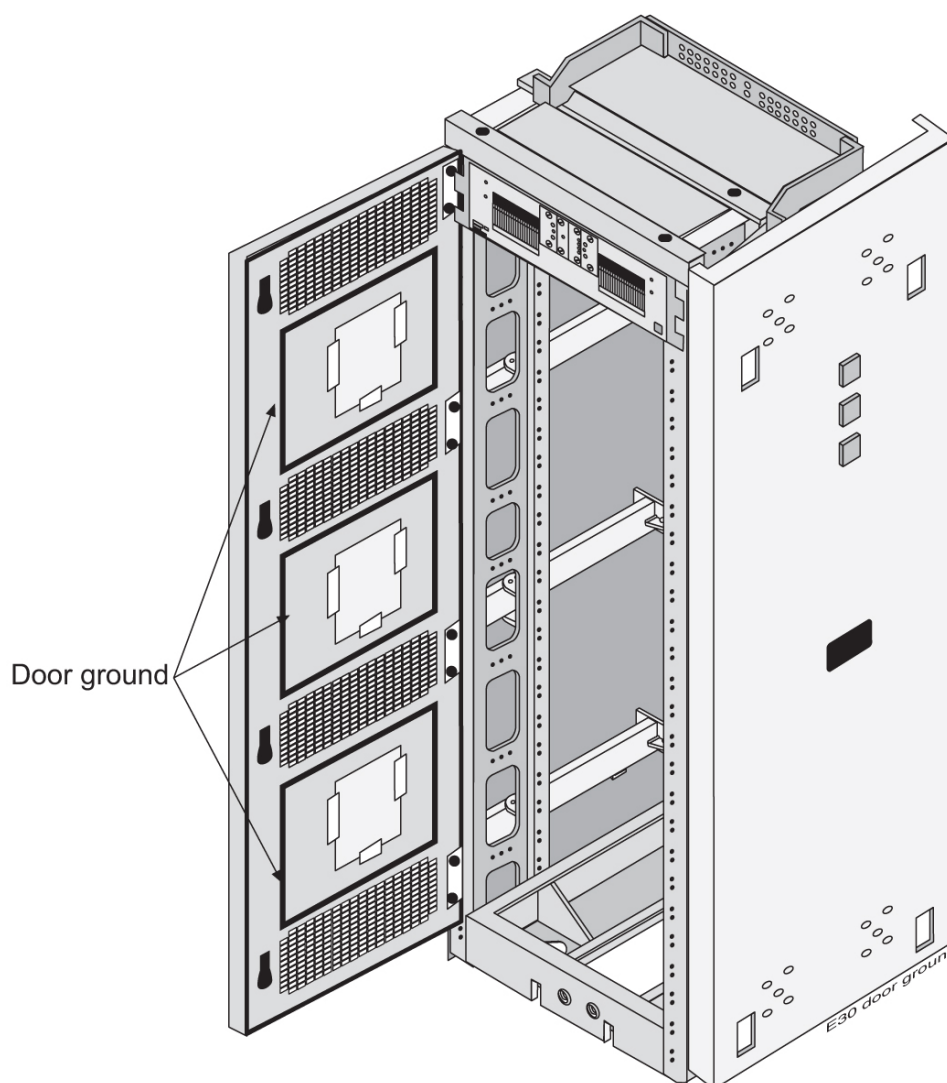

Figure 5-2 Logic Grounding with FAP (P/N 870-1606-xx/870-2320-xx)



The doors installed are grounded to the frame through a double lug ground wire (see [Figure 5-3](#)) and through a screw-down latch.

Figure 5-3 Door Grounding



Power Requirements

Each frame requires that power be provided from two fuses/breakers at -48VDC . Additional peripherals that require alternating current (for example but not limited to, terminals, printers, and modems) must be compatible with the system and have a separate ground from the frames.

Each frame is divided into A and B power buses. In the event of loss of power on one of the buses, the other bus must be able to supply current for the entire frame. Therefore, each bus requires wiring sized to handle up to the maximum amps at -48VDC , with a maximum voltage drop of 0.5 volts. To meet this specification you must:

- For new installations of Control and Extension Frames (as of Release 34.0) use 60 amp breakers (see note), the **ELAP** frames use 30 amp and 60 amp breakers, and the **EPAP** frames use 30 amp breakers. Local Alarms for the Frame's Power Distribution System are provided at each frame.

 **Note:**

Existing frames that are fused at 40 amps can be upgraded to support 60 amps with a **FAP** upgrade kit. 60 amps is required for frames that contain **HC-MIMs**.

- Use #6, two-hole, #10 Bolt, 5/8" on center lug with windows (P/N 502-0085-01) for fuse and alarm panel connectors.

 **Note:**

If breakers are tripped by an overload, they must be switched completely **OFF** and then **ON** to reset.

Populating the System

The number of frames, shelves, and modules needed to populate the system can be determined using the following procedures.

Hardware Power Calculator Tool

Fans are required for all shelves that contain E5-ENET-B, E5-ATM-B, E5-E1/T1-B, E5-MCPM-B, E5-SM8G-B, HCMIM, E5-APP-B cards or SLIC. Due to higher power B cards, dual 60 Ampere power feeds to a frame may be required depending on frame configuration.

The Frame Power Budget Alarm feature (R35) provides an alarm if the power consumption of cards in a frame nears the frame-level power capacity. The current capacity value can be provisioned in the Frame Power Threshold (FPT) table or a default value of 30 Amperes can be used (30 A through 60 A are values that can be used). The feature identifies the type of cards in a frame, calculates potential current consumption based on the frame-level population of cards, compares calculated current consumption to the frame-level current capacity figure, and raises alarms based on provisioned thresholds (90%, 95%, and 98%).

A Power Calculator Tool (SS005963) can be used to analyze current power requirements and to plan power requirements for future configurations.

This table summarizes the power usage of each component that can be installed in the EAGLE frame.

Table 5-1 Power Usage by Component

Component	Power (W)	Part Number
E5-APP-B	78	870-3096-XX
E5-ATM-B	34	870-2972-XX
E5-E1T1-B	32	870-2970-XX
E5-ENET-B	34	870-2971-XX
E5-MASP	58	7346924
		870-2903-XX
E5-MCPM-B	32	870-3089-XX
E5-MDAL	12	7346923
		870-2900-XX

Table 5-1 (Cont.) Power Usage by Component

E5-SM8G-B	63	870-2990-XX
Fan tray	125	890-0001-XX
HC MIM	75	870-2671-XX
HIPR2	18	7333484
		870-2872-XX
SLIC	34	7094646
Telco Switch	120	870-2904-01

Message Flow Control (MFC)

With Message Flow Control (MFC), an EAGLE card can inform all EAGLE cards that it has reached the allotted capacity of a particular advertised service. MFC contains the concept of system and card groups, and the groups can go into flow control independently based on the flow of messages through MFC. MFC controls all traffic across the IMT bus.

MFC is a framework that allows features such as MTP3 and SLAN to use MFC. Applications that use the MFC framework for message flow control between application cards include:

- MTP3 routing
- INM/SNM routing
- SLAN

Caution:

MFC can be used only with E5-based cards; however, it is required for E5-B type cards. Release 46.2 and later does not support TVG.

When a card determines that the rated capacity for a service is reached, it notifies all cards that the specified service is no longer available for the remainder of the time slice and specifies the time interval that defines the remainder of the time slice. When the time slice expires the service is automatically made available again on all cards. The tasks that use MFC are INM, SNM, Linkset Reroute, SCCP, EROUTE, and SLAN.

There are two general types of MFC services:

- **Card Service Flow**
Control Card services are provided by a card and the capacity stated by that card only affects the usage of that card. If the capacity of a card service is exhausted, only the services on that card are affected. The client card can look to another card to provide the service. A card service is used when supporting a feature with an "N+1" configuration.
- **System Service Flow**
Control System services are provided by the system as a whole. The capacity of the system service is rated as the capacity of the system. Several cards may provide the same system service, and it is possible that each card will have a different rated capacity. When a service request is sent to a system service, it is sent to all cards that provide the service. The capacity of the system service is limited to the rate of the lowest capacity card. If the capacity is exhausted on one card, the service for the whole system group is 'in flow

control.' A system service is used when the available pool of resources must be limited by the weakest link (the card with the lowest rated capacity).

Database Communications Module (DCM) and Double-Slot Enhanced DCM (EDCM)

The Database Communications Module (**DCM**) (P/N 870-1671-xx or P/N 870-1945-01) can be used in EAGLE or IP⁷GW systems). The Double Slot **EDCM** (P/N 870-2197-01) is used in IP⁷ SG release 4.0 systems and later. Both cards provide the following functions for the systems:

- Signaling Transfer Point, Local Area Network (**SLAN**) function, port to DCM or Double Slot EDCM
- Enhanced Bulk Download

Note:

The DCM card requires two slots for mounting and must be assigned to an odd numbered slot with the next even slot left open on EAGLE systems.

The DCM card is compatible with EAGLE control shelf backplanes and extension backplanes. See "Hardware Baseline Table" in *Release Notes* for all control shelf and extension backplane part numbers. The Double-Slot EDCM is compatible with IP⁷ SG control shelf backplanes P/N 850-0330-03/04/05 and 7333412, and extension shelf backplanes P/N 850-0356-01/02/03 and 7333417. These cards are provisioned in pairs for redundancy with mated pairs mounted in shelves. Size places some restrictions on the placement of DCM or Double-Slot EDCM cards.

The DCM cards require a unique cable interface that is not compatible with current LIM cables on a fully wired but unequipped shelf. The location of the DCM cards must be to odd numbered slots, requiring two slots with the next higher-numbered even slots left open.

Cabling DCM, Double-Slot EDCM, and E5-SM8G Cards

The **DCM** and E5-SM8G cards support only Category 5 (100-Ohm) shielded twisted pair cables. In order to meet Electromagnetic Interference (**EMI**) requirements, the cards may require a point-to-point connection or a connection to a hub/router. This must be identified to the customer who may be preparing the location. The figure that follows shows the cable types and part numbers.

The maximum cable length has not been determined but will be less than 100 meters.

Three specific **DCM** cables are required:

- Customer patch panel "straight through" (P/N 830-0788-xx)
- Customer patch panel "crossover" (P/N 830-0789-xx)
- 100-**BASETX** interface to unterminated (P/N 830-0711-xx)

Figure 5-4 Database Communications Cabling in System

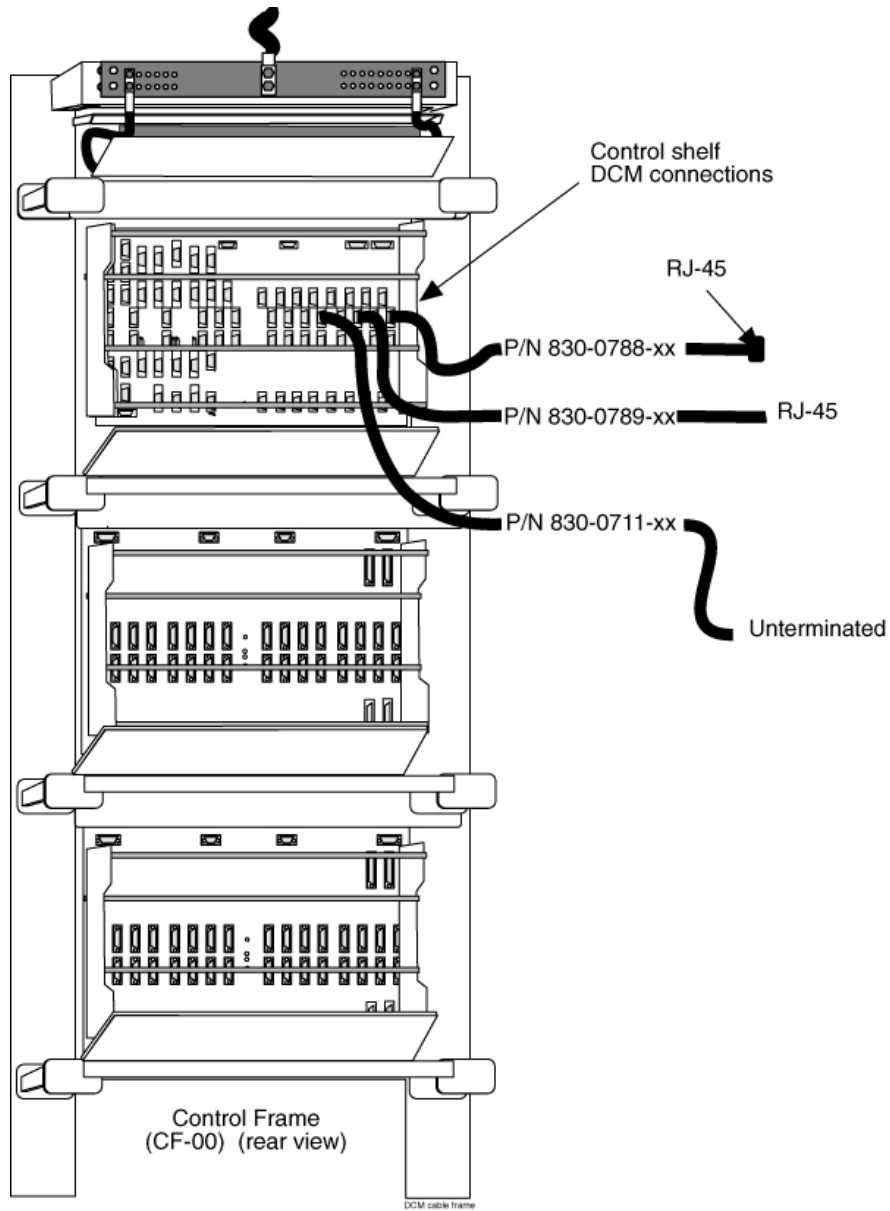

Hardware

The systems support a maximum of six cards for Internet Protocol Link Interface Module (IP LIM) application.

If more than one card is provisioned, each must be powered from different fuse positions and distributed evenly among “A” and “B” power feeds.

 **Note:**

In EAGLE systems care must be taken to be sure the DCM card is inserted into the correct odd numbered slots. Cards may be provisioned in any slot where they physically fit except for the MAS dedicated card slots.

A

Hardware Baselines

Baseline Tables

The following tables list the configurable hardware components for each release. A bold X in a table cell indicates the component listed on the left is valid for the release indicated at the top of the column. To obtain configuration information about hardware and release compatibility for each release use:

- EAGLE Release 46.3 through 46.6 in [EAGLE Release 46.3 Through 46.6](#)
- EAGLE Cable Assemblies and Adapters:
 - E1 Cable Assemblies in [Table A-2](#)
 - T1 MIM LIM Cable Assemblies [Table A-3](#)
 - E5-ATM Adapters [s](#)
 - ENET Adapters [Table A-5](#)
 - Fast Copy Adapters [Table A-7](#)
 - Terminal/Printer Cables and Adapters [Table A-8](#)
 - Modem Cables and Adapters [Table A-9](#)
 - Application Server [Table A-10](#)
 - Application Server Serial Adapters [Table A-11](#)

Note:

Exceptions, additions, and clarifications to the following tables are by superscript numeric notation relating to the listed notes located at the end of each table. The notations are indicated as a numbered step reference (such as [23](#)) which corresponds to the appropriate note which is shown at the end of this section. For example, a table cell with X ^{1,2} would indicate that notes 1 and 2 are applicable to that component being configurable in that release.

EAGLE Release 46.3 Through 46.6

Table A-1 Hardware Baseline EAGLE Release 46.3 Through 46.6

NAME	PART NUMBER	REV	46.3	46.4	46.5	46.6
Air ManagementCard	870-1824-01	A	X ¹⁶	X ¹⁶	X ¹⁶	X ¹⁶

Table A-1 (Cont.) Hardware Baseline EAGLE Release 46.3 Through 46.6

NAME	PART NUMBER	REV	46.3	46.4	46.5	46.6
Air ManagementCard	870-1824-02	A	X ¹⁶	X ¹⁶	X ¹⁶	X ¹⁶
CTRL SHELF	870-0775-03	E	X ¹¹	X ¹¹	X ¹¹	X ¹¹
CTRL SHELF	870-2321-02	A	X ^{2,7}	X ^{2,7}	X ^{2,7}	X ^{2,7}
CTRL SHELF	870-2321-04	A	X ^{2,7}	X ^{2,7}	X ^{2,7}	X ^{2,7}
CTRL SHELF	870-2321-08	A	X ^{2,7}	X ^{2,7}	X ^{2,7}	X ^{2,7}
CTRL SHELF	870-2377-01	A	X ^{3,7}	X ^{3,7}	X ^{3,7}	X ^{3,7}
CTRL SHELF	870-2377-02	A	X ^{3,7}	X ^{3,7}	X ^{3,7}	X ^{3,7}
CTRL SHELF	7335031	N/A	X ^{3,7}	X ^{3,7}	X ^{3,7}	X ^{3,7}
E5-APP-B	870-3096-xx	A	X	X	X	X
E5-ATM	870-1872-01	A	X ²²	X ²²	X ²²	No longer supported; replaced by E5-ATM-B
E5-ATM	870-1872-02	A	X ²²	X ²²	X ²²	No longer supported; replaced by E5-ATM-B
E5-ATM-B	870-2972-01	D	X ^{22,29}	X ^{22,29}	X ^{22,29}	X ^{22,29}
E5-E1T1	870-1873-02	A	X ²²	X ²²	X ²²	No longer supported; replaced by SLIC
E5-E1T1	870-1873-03	A	X ²²	X ²²	X ²²	No longer supported; replaced by SLIC
E5-E1T1	870-1873-04	A	X ²²	X ²²	X ²²	No longer supported; replaced by SLIC
E5-E1T1-B	870-2970-01	D	X ^{22,29}	X ^{22,29}	X ^{22,29}	X ^{22,29}
E5-ENET	870-2212-02	A	X ²²	X ²²	X ²²	No longer supported; replaced by SLIC
E5-ENET	870-2212-03	A	X ²²	X ²²	X ²²	No longer supported; replaced by SLIC
E5-ENET	870-2212-04	A	X ²²	X ²²	X ²²	No longer supported; replaced by SLIC

Table A-1 (Cont.) Hardware Baseline EAGLE Release 46.3 Through 46.6

NAME	PART NUMBER	REV	46.3	46.4	46.5	46.6
E5-ENET	870-2212-05	A	X ²²	X ²²	X ²²	No longer supported; replaced by SLIC
E5-ENET-B	870-2971-01	E	X ^{22, 29}	X ^{22, 29}	X ^{22, 29}	X ^{22, 29}
E5-MASP	870-2903-01	A	X ^{22, 26}	X ^{22, 26}	X ^{22, 26}	X ^{22, 26}
E5-MASP	870-2903-02	A	X ^{22, 26}	X ^{22, 26}	X ^{22, 26}	X ^{22, 26}
E5-MASP	7346924	N/A	X ^{22, 26}	X ^{22, 26}	X ^{22, 26}	X ^{22, 26}
E5-MCPM-B	870-3089-01	A	X ^{22, 29}	X ^{22, 29}	X ^{22, 29}	X ^{22, 29}
E5-MDAL	870-2900-01	C	X ^{22, 25}	X ^{22, 25}	X ^{22, 25}	X ^{22, 25}
E5-MDAL	7346923	N/A	X ^{22, 25}	X ^{22, 25}	X ^{22, 25}	X ^{22, 25}
E5-SM4G (Double-slot)	870-2860-01	F	X ²²	X ²²	X ²²	No longer supported; replaced by SLIC
E5-SM4G (Double-slot)	870-2860-02	A	X ²²	X ²²	X ²²	No longer supported; replaced by SLIC
E5-SM8G-B (Double-slot)	870-2990-01	A	X ^{22, 29}	X ^{22, 29}	X ^{22, 29}	X ^{22, 29}
E5-TSM	870-2943-03	B	X ²²	X ²²	X ²²	No longer supported; replaced by SLIC
EXTN SHELF	870-0776-02	C	X ²⁷	X ²⁷	X ²⁷	X ²⁷
EXTN SHELF	870-0776-03	D	X ²⁷	X ²⁷	X ²⁷	X ²⁷
EXTN SHELF	870-0776-06	A	X	X	X	X
EXTN SHELF	870-0776-07	A	X	X	X	X
EXTN SHELF	870-0776-08	A	X	X	X	X
EXTN SHELF	870-0776-11	A	X	X	X	X
EXTN SHELF	870-2378-01	A	X ⁵	X ⁵	X ⁵	X ⁵
EXTN SHELF	870-2378-02	A	X ⁵	X ⁵	X ⁵	X ⁵
EXTN SHELF	7335033	N/A	X ⁵	X ⁵	X ⁵	X ⁵
FAP	870-1606-01	A	X	X	X	X
FAP	870-1606-02	A	X ⁴	X ⁴	X ⁴	X ⁴
FAP	870-1606-02	C	X ¹³	X ¹³	X ¹³	X ¹³
FAP	870-1606-05	A	X ¹³	X ¹³	X ¹³	X ¹³
FAP	870-1823-01	B	X	X	X	X
FAP	870-2320-01	A	X ⁵	X ⁵	X ⁵	X ⁵

Table A-1 (Cont.) Hardware Baseline EAGLE Release 46.3 Through 46.6

NAME	PART NUMBER	REV	46.3	46.4	46.5	46.6
FAP	870-2320-01	J	X ¹²	X ¹²	X ¹²	X ¹²
FAP	870-2320-03	A	X ⁵	X ⁵	X ⁵	X ⁵
FAP-CF/EF	870-0243-08	C	X	X	X	X
FAP- MISC	870-0243-09	C	X	X	X	X
FAP	870-2804-01	B	X	X	X	X
HCMIM	870-2671-01	P	X ¹⁵	X ¹⁵	X ¹⁵	No longer supported; replaced by SLIC
HCMIM	870-2671-02	B	X ¹⁵	X ¹⁵	X ¹⁵	No longer supported; replaced by SLIC
HCMIM	870-2671-03	A	X ¹⁵	X ¹⁵	X ¹⁵	No longer supported; replaced by SLIC
HIGH-SPEED FIBER CHANNEL CABLE	830-1344-xx		X	X	X	X
HIGH-SPEED FIBER CHANNEL CABLE	830-1141-xx		X			
HIGH-SPEED FIBER CHANNEL CABLE	830-0221-xx		X			
HIPR2	870-2872-01	A	X ²⁸	X ²⁸	X ²⁸	X ²⁸
HIPR2	870-2872-02	A	X	X	X	X
HIPR2	870-2872-03	A	X	X	X	X
HIPR2	7333484	X	X	X	X	X
FAN ASSY	890-1038-01	D	X	X	X	X
FAN ASSY	890-0001-01	A	X ¹⁷	X ¹⁷	X ¹⁷	X ¹⁷
FAN ASSY	890-0001-02	A	X ¹⁷	X ¹⁷	X ¹⁷	X ¹⁷
FAN ASSY	890-0001-04	A	X ¹⁷	X ¹⁷	X ¹⁷	X ¹⁷
FAN ASSY	7315823	N/A	X ¹⁷	X ¹⁷	X ¹⁷	X ¹⁷
KIT,E1	890-1037-01	A	X	X	X	X
KIT,E1	890-1037-06	A	X	X	X	X
KIT, HLDVRCCLK ASSY	890-1013-01	A	X	X	X	X

Table A-1 (Cont.) Hardware Baseline EAGLE Release 46.3 Through 46.6

NAME	PART NUMBER	REV	46.3	46.4	46.5	46.6
MPS in Heavy Duty Frame	890-1801-01	E				
MPS in Heavy Duty Frame	890-1801-02	A				
MPSDC Frame	890-1843-01	C	X	X	X	X
MPSDC Frame	890-1843-02	A	X	X	X	X
MPS Netra-to-Tekelec 1000 Field Upgrade Kit	870-2735-01	A				
MPS Netra-to-Tekelec 1000 Field Upgrade Kit	870-2735-02	A				
SLIC	7094646	N/A	X	X	X	X
Telco 24 port switch for ExAP-SM interconnectivity	870-2904-01	N/A	X	X	X	X

EAGLE Cable Assemblies and Adapters

Table A-2 E1 Cable Assemblies

P/N		Description
non-ROHS	ROHS	
830-0622-xx	830-1233-xx	E1 Dual TX/RX, XX ft., NTW
830-0623-xx	830-1256-xx	E1 Patch, D26M to D26M, 120 OHM, XX ft., NTW

Table A-3 T1 MIM LIM Cable Assemblies

P/N		Description
non-ROHS	ROHS	
830-0949-xx	830-1198-01	T1 LIm to MPL Cable Adapter
830-0948-xx	830-1197-xx	T1 MIM Lim XX ft. Unterminated
830-0857-xx	830-1185-01	Adapter A Clk in HMUX
830-0846-xx	830-1183-01	DB-25M to DB-25F and DB-15F Y Clk / HS Timing

Table A-4 E5-ATM Adapter

P/N	Description
830-1342-05	Dual DB-26M to DB-26F / RJ11

Table A-5 ENET Adapters

P/N	Description
830-1102-02	DB-26M to Dual RJ45 10/100/1000
830-1103-02	DB-26M to DB-26F 10/100
830-1104-02	DB-26M to RJ45 10/100
830-1104-03	DB-26M to RJ45 10/100/1000

Table A-6 SLIC Adapter

P/N	Description
830-1102-03	DB-26M to Dual RJ45 10/100/1000

Table A-7 Fast Copy Adapters

P/N	Description
830-1343-01	CABLE ASSY_ADAPTER_PRE-MOLD_UPPER_EAGLE FAST COPY_DUAL DB26_RJ45 (E5_ENET)
830-1343-02	CABLE ASSY_ADAPTER_PRE-MOLD_LOWER_EAGLE FAST COPY_DUAL DB26_RJ45 (E5-ENET)

Table A-8 Terminal/Printer Cables and Adapters

Cable P/N	Necessary Adapter
830-0394-xx	830-0531-02
830-0535-xx	None
830-1154-xx (ROHS)	None

Table A-9 Modem Cables and Adapters

Cable P/N	Necessary Adapter
830-0394-xx	830-0531-03
830-0535-xx	830-0531-04
830-1154-xx (ROHS)	830-1153-04 (ROHS)
830-0680-01	None
830-1165-01 (ROHS)	None

Table A-10 Application Server Site Specific Cables

P/N		Description
non-ROHS	ROHS	
830-0963-xx	830-1201-xx	Optional DB9F/DB15M Serial w/Flow Control
830-0964-xx	830-1202-xx	DB9/DB25 M/M Site Specific Null Modem Serial Cable
830-0978-xx	830-1204-xx	DB26-RJ45 Site Specific Straight Through Cable - Non Shielded
830-0979-xx	830-1205-xx	DB26-RJ45 Site Specific Crossover Cable - Non Shielded

Table A-11 Application Server Serial Adapters

P/N	Description
830-0915-01	RJ45-DB15M Adapter_NTW
830-0915-02	RJ45-DB15M Adapter_MRV
830-0915-03	RJ45-DB15M Adapter_EAGLE/Cyclades

Notes

- Control shelf P/N 870-0775-03 with backplane P/N 850-0330-04 can be used with minor modifications and addition of adapter cable P/N 830-1185-01.
- Control shelf P/N 870-2321-08 with backplane P/N 850-0330-06/07 and 7333412 can be used with HIPR2 cards in standard frames.
- Control shelf P/N 870-2377-02 with backplane P/N 850-0330-06/07 and 7333412 can be used in heavy-duty frames.
- Required for standard frames. Rev. C required for **HCMIM** shelves.
- Required for heavy-duty frames. Rev. J required for **HCMIM** shelves.
- Required for Master Timing Feature (**T1** clocking).
- Required for **HIPR**/HIPR2 cards.
- Uses **HCAP** (P/N 850-0419-xx) main assembly board.
- Uses **HCAP-T** (P/N 850-0615-xx) main assembly boards.
- Beginning with **EAGLE** software release 33.0 through 46.0, all **IPMX** cards must be replaced by High-Speed IMT Router (**HIPR**) Cards (P/N 870-2574-02). Software release 46.1 requires HIPR2 cards. **HIPR2** cards are installed at the factory or by Technical Support and are not installed by customers.
- NEBS** will support Master Timing with adapter 830-1183-01.
- 60 Amp **FAP** required for Heavy-duty frames that contain shelves with **HCMIM** modules.
- 60 Amp **FAP** required for standard frames that contain shelves with **HCMIM** modules.
- Requires two **HIPR** modules for each shelf containing **HCMIM**, and requires fan tray 890-0001-04.
- Requires two **HIPR2** modules for each shelf containing **HCMIM**, and requires fan tray 890-0001-04.

16. Required in all empty slots in shelves when using fan tray 890-0001-xx.
17. Required for shelves that contain **HCMIM** modules.
18. Has **K6 II** processor.
19. Has **COMM** processor adapter.
20. Has **PQFP** processor.
21. Requires **HIPR2**.
22. Requires **HIPR2**.
23. Has **K6 III** processor.
24. Set of qualified features may be limited. Confirm feature set compatibility and performance ratings prior to use or upgrade.
25. Requires E5-MASP.
26. Requires E5-MDAL.
27. If any E5 type cards are used in the shelf, **HIPR2** 870-2872-02, -03, or 7333484 are required. The HIPR2 870-2872-01 is not supported.
28. Not supported on Extension shelf 870-0776-02 and -03.
29. Requires fan tray assembly.

Index

Numerics

8-Port Connector Box
description, [4-4](#)
840-0064-01, [3-8](#)
840-0089-01, [3-8](#)
870-2238-01, [3-8](#)
870-2278-01, [3-8](#)

A

Application Processor (AP), [3-49](#)

B

box, 8-Port Connector
Connector Box, 8-Port, [4-4](#)
Breaker panels, [4-8](#)

C

cable adapter, [3-74](#), [3-75](#)
Clock A, [3-23](#)
Communications Processor (CP), [3-49](#)
Control Frame (CF), [3-6](#)
Critical Alarm, [3-7](#)

D

DCM, [5-9](#)

E

E1, [2-8](#)
E1-ATM, [2-8](#)
E5-E1T1, [3-17](#), [3-27](#)
E5-ENET, [3-17](#), [3-27](#)
E5-SM4G, [2-9](#), [3-27](#), [3-72](#)
EDCM, [5-9](#)
Eight-Port Connector Box, [4-9](#)
end panels, [3-8](#)
EROUTE, [2-8](#)
Extension Frame (EF), [3-6](#)

F

FAP, [3-77](#), [3-82](#)
floor loading, [5-3](#)
Fuse and Alarm Panel, [3-77](#), [3-82](#)
Fuse and Alarm Panel (FAP), [3-8](#), [3-14](#), [3-18](#), [3-23](#)

G

General Purpose Frame (GPF), [3-6](#)
Global Title Translation, [2-9](#), [3-72](#)
GLS, [2-8](#)
GPL, [2-7](#)
GTT, [2-9](#), [3-72](#)

H

HCMIM, [3-26](#)
High Density Interconnect (HDI), [3-17](#), [3-23](#)
holdover clock, [3-85](#)
hub
description, [4-6](#)
front LEDs, [4-6](#)

I

IMT, [3-9](#), [3-15](#)
IMT interface circuits, [3-50](#)
Interprocessor Message Transport (IMT), [3-9](#), [3-45](#)

L

LEDs
hub front, [4-6](#)
LIM, [2-8](#), [3-17](#), [3-26](#)
LIM-ATM-, [3-42](#)
Link Interface Module, [2-8](#)
link interface module (LIM), [3-16](#)
Link Interface Modules, [3-16](#)
LNP, [2-9](#), [3-72](#)
Local Number Portability, [2-9](#), [3-72](#)

M

Maintenance and Administration Subsystem (MAS), [3-15](#)

Maintenance Interface System (MIS), [3-86](#)

Major Alarm, [3-7](#)

MAS, [3-15](#)

Matrix Controller Automatic, [3-89](#)

Maximum weight, [5-4](#)

MCA, [3-89](#)

MCPM, [2-9](#)

Measurements Collection and polling Module, [2-9](#)

Minor Alarm, [3-7](#)

MIS, [3-85](#)

miscellaneous frame (MF), [3-14](#)

Miscellaneous Frame (MF), [3-6](#)

MPL, [3-17](#)

MPS Server

- card
 - SAI/P, [4-3](#)
- interface
 - SAI/P card, [4-3](#)
- PCI cards
 - SAI/P, [4-3](#)
- serial ports SAI/P card, [4-3](#)

MPS system

- Ethernet hub description, [4-6](#)

P

P/N 850-0330-03, [3-19](#)

PLXO, [3-88](#)

ports

- 8-Port Connector Box, serial, [4-4](#)
- SAI/P card, [4-3](#)

R

Radio Frequency Interference (RFI), [3-23](#)

return shipment, [1-10](#)

S

SAI/P card

- description, [4-3](#)

SCCP, [2-9](#), [3-72](#)

serial ports

- 8-Port Connector Box, [4-4](#)
- SAI/P card, [4-3](#)

Signaling Connection Control Part, [2-9](#), [3-72](#)

Signaling Transfer Point, Local Area Network (SLAN), [5-9](#)

SLAN, [2-8](#)

SLIC, [3-27](#)

spare card storage shelf, [3-14](#)

SS7, [2-8](#)

Status Indicators (SI), [3-87](#)

Stratum-3 (ST3), [3-85](#), [3-88](#)

T

T1, [2-8](#)

T1-ATM, [2-8](#)

TCP/IP, [2-9](#)

thermal management, [3-36](#), [3-73](#)

TOCA, [3-85](#), [3-88](#)

Translation Service Modules, [3-16](#)

TSM, [3-17](#)

TXCO, [3-88](#)

V

VCXO, [3-88](#)

VSCCP, [2-8](#)

W

weights, [5-4](#)