

Oracle® Retail Enterprise Inventory Cloud Service

Administration Guide

Release 19.5

F55424-02

May 2022

Primary Author: Tracy Gunston

Contributing Author: Bipin Pradhan

This software and related documentation are provided under a license agreement containing restrictions on use and disclosure and are protected by intellectual property laws. Except as expressly permitted in your license agreement or allowed by law, you may not use, copy, reproduce, translate, broadcast, modify, license, transmit, distribute, exhibit, perform, publish, or display any part, in any form, or by any means. Reverse engineering, disassembly, or decompilation of this software, unless required by law for interoperability, is prohibited.

The information contained herein is subject to change without notice and is not warranted to be error-free. If you find any errors, please report them to us in writing.

If this is software or related documentation that is delivered to the U.S. Government or anyone licensing it on behalf of the U.S. Government, then the following notice is applicable:

U.S. GOVERNMENT END USERS: Oracle programs, including any operating system, integrated software, any programs installed on the hardware, and/or documentation, delivered to U.S. Government end users are "commercial computer software" pursuant to the applicable Federal Acquisition Regulation and agency-specific supplemental regulations. As such, use, duplication, disclosure, modification, and adaptation of the programs, including any operating system, integrated software, any programs installed on the hardware, and/or documentation, shall be subject to license terms and license restrictions applicable to the programs. No other rights are granted to the U.S. Government.

This software or hardware is developed for general use in a variety of information management applications. It is not developed or intended for use in any inherently dangerous applications, including applications that may create a risk of personal injury. If you use this software or hardware in dangerous applications, then you shall be responsible to take all appropriate fail-safe, backup, redundancy, and other measures to ensure its safe use. Oracle Corporation and its affiliates disclaim any liability for any damages caused by use of this software or hardware in dangerous applications.

Oracle and Java are registered trademarks of Oracle and/or its affiliates. Other names may be trademarks of their respective owners.

Intel and Intel Xeon are trademarks or registered trademarks of Intel Corporation. All SPARC trademarks are used under license and are trademarks or registered trademarks of SPARC International, Inc. AMD, Opteron, the AMD logo, and the AMD Opteron logo are trademarks or registered trademarks of Advanced Micro Devices. UNIX is a registered trademark of The Open Group.

This software or hardware and documentation may provide access to or information about content, products, and services from third parties. Oracle Corporation and its affiliates are not responsible for and expressly disclaim all warranties of any kind with respect to third-party content, products, and services unless otherwise set forth in an applicable agreement between you and Oracle. Oracle Corporation and its affiliates will not be responsible for any loss, costs, or damages incurred due to your access to or use of third-party content, products, or services, except as set forth in an applicable agreement between you and Oracle.

Value-Added Reseller (VAR) Language

Oracle Retail VAR Applications

The following restrictions and provisions only apply to the programs referred to in this section and licensed to you. You acknowledge that the programs may contain third-party software (VAR applications) licensed to Oracle. Depending upon your product and its version number, the VAR applications may include:

- (i) the **MicroStrategy** Components developed and licensed by MicroStrategy Services Corporation (MicroStrategy) of McLean, Virginia to Oracle and imbedded in the MicroStrategy for Oracle Retail Data Warehouse and MicroStrategy for Oracle Retail Planning & Optimization applications.
- (ii) the **Wavelink** component developed and licensed by Wavelink Corporation (Wavelink) of Kirkland, Washington, to Oracle and imbedded in Oracle Retail Mobile Store Inventory Management.
- (iii) the software component known as **Access Via**[™] licensed by Access Via of Seattle, Washington, and imbedded in Oracle Retail Signs and Oracle Retail Labels and Tags.
- (iv) the software component known as **Adobe Flex**[™] licensed by Adobe Systems Incorporated of San Jose, California, and imbedded in Oracle Retail Promotion Planning & Optimization application.

You acknowledge and confirm that Oracle grants you use of only the object code of the VAR Applications. Oracle will not deliver source code to the VAR Applications to you. Notwithstanding any other term or condition of the agreement and this ordering document, you shall not cause or permit alteration of any VAR

Applications. For purposes of this section, "alteration" refers to all alterations, translations, upgrades, enhancements, customizations or modifications of all or any portion of the VAR Applications including all reconfigurations, reassembly or reverse assembly, re-engineering or reverse engineering and recompilations or reverse compilations of the VAR Applications or any derivatives of the VAR Applications. You acknowledge that it shall be a breach of the agreement to utilize the relationship, and/or confidential information of the VAR Applications for purposes of competitive discovery.

The VAR Applications contain trade secrets of Oracle and Oracle's licensors and Customer shall not attempt, cause, or permit the alteration, decompilation, reverse engineering, disassembly or other reduction of the VAR Applications to a human perceivable form. Oracle reserves the right to replace, with functional equivalent software, any of the VAR Applications in future releases of the applicable program.

Contents

Send Us Your Comments	xix
Preface	xxi
Audience	xxi
Documentation Accessibility	xxi
Related Documents	xxi
Improved Process for Oracle Retail Documentation Corrections	xxii
Oracle Retail Documentation at the Oracle Help Center	xxii
Conventions	xxii
1 Technical Architecture	
Multiple Products	1-1
Logical Model	1-2
SaaS Deployment	1-2
Cloud Deployment	1-3
EICS Client	1-3
SOCS Mobile Client	1-3
Web Services	1-3
WTSS / IDCS or OCI IAM	1-3
EICS Application Server(s)	1-3
OBIEE Server	1-3
SFTP Server	1-3
Oracle DB Server (DBaaS)	1-3
Client-Server Communication	1-4
Integration	1-4
Oracle Retail Integration Bus (RIB)	1-4
SOAP Web Services	1-4
File-Based	1-4
Deployment with Other Products	1-4
Deployment - Performance: Bandwidth, Scaling	1-5
Bandwidth Requirements for Browser Clients	1-5
Network Latency Constraints	1-5
Application Server Clustering	1-5
Database Clustering with RAC	1-5

2 Data Seeding

What is Data Seeding?	2-1
Overview of Data Seeding Process	2-1
Pre-requisites.....	2-2
Configure EICS for Data Seeding.....	2-2
Security Settings	2-2
Configuration Parameters.....	2-3
Steps to Enable Data Seeding in SIOCS UI.....	2-4
Steps to Manual Control Importers	2-5
Optional Steps Prior Initial Seeding	2-5
Run BDI Data Seeding.....	2-5
BDI Process Flow Admin Console.....	2-5
Extractor	2-7
Downloader	2-7
Uploader/Receiver	2-8
Importer.....	2-8
Import Staging Data to Application Tables	2-9
Re-running EICS Importer Data Loads	2-10
BDI-Based Data Seeding Post-Load Processes.....	2-11

3 Reporting

EICS Reporting Framework	3-1
Report Service.....	3-2
Security Considerations	3-2
BI Publisher Server.....	3-2
Report URL Location	3-3
Previewing a Report.....	3-5
EICS Operational Reports	3-5

4 Internationalization

Supported Locales	4-1
SOCS Client Translations.....	4-3
EICS Client Translations	4-3
EICS Server Translations	4-3
Translation Topics.....	4-3
Translation Keys.....	4-4
Translation Setup Screen.....	4-4
Bundle Selection Dialog	4-4
Translation Setup Screen.....	4-5
Translation File Upload	4-7
Report Translations.....	4-7

5 Batches

Batch Overview.....	5-1
Batch Admin Users.....	5-2
Batch Configuration.....	5-2

Operational Batches	5-6
Archive Activity History	5-7
Archive Dump	5-7
Archive Item Uin History	5-8
Archive RFID History	5-8
Archive Store Item Stock History	5-8
Archive Ticket History	5-9
Auto Replenish Capacity	5-9
Auto Ticket Generate	5-10
Auto Ticket Print	5-10
Cleanup Batch Directories	5-11
Cleanup Shelf Replenishment	5-11
DSD Receiving Closure	5-12
Extract Subscription Usage	5-13
Fulfillment Order Pick Reminders	5-14
Fulfillment Order Reminders	5-14
Generate Problem Line Stock Count	5-15
Generate Unit Amount Stock Count	5-17
Generate Unit Stock Count	5-18
Inventory Extract File SFTP Push	5-20
Item Basket Maintenance	5-20
Item Price to History	5-20
Product Group Schedule Clean up	5-21
Return Not After Date Alert	5-21
Stock Count Authorize Recovery	5-22
Stock Count Export	5-23
Stock Count Export File SFTP Push	5-23
Stock Count Unit and Amount Snapshots	5-24
Store Order Auto Approve	5-24
Store Order Auto Cancel	5-25
Store Order Auto Generate	5-25
Transfer Close	5-26
Transfer Delivery Auto Receive	5-27
Transfer Delivery Close	5-28
Transfer Not After Date Alert Batch	5-28
Transfers Overdue	5-29
Vendor Return Closure	5-29
BDI-Based Batches	5-30
Clearance Transaction Import	5-30
Price Change Transaction Import	5-31
Rfid Transaction Import	5-31
Third Party Pricing Import	5-31
Warehouse Avail Inventory Import	5-32
SFTP File-Based Batches	5-33
Clearance Price Change Import (with On-premise RPM)	5-33
High Level Batch File Process Overview	5-33
Initial Inventory Import	5-33

Inventory Extract.....	5-34
Pos Transaction Import	5-35
Promotion Price Change Import (with On-premise RPM)	5-36
Regular Price Change Import (with On-premise RPM)	5-36
Retail Sale Audit Import	5-37
SFTP Nightly Batch File Uploads	5-38
Adding Authorized Keys.....	5-38
Login to WinSCP	5-40
Uploading a Batch File	5-41
Export File Downloads.....	5-42
Store Sequence Import.....	5-42
Third Party Stock Count Import	5-43
Warehouse Item Stock Import.....	5-44
Purge Batches	5-44
Purge Adhoc Stock Count.....	5-45
Purge Areas	5-46
Purge Batch Log	5-47
Purge Closed Transfers	5-47
Purge Completed UINs.....	5-48
Purge DSD and Purchase Orders.....	5-50
Purge Customer Orders	5-51
Purge Invalid Users	5-52
Purge Invalid User Roles	5-52
Purge Inventory Adjustments	5-53
Purge Item	5-54
Purge Item Baskets.....	5-56
Purge Item Hierarchy	5-57
Purge Item Price	5-57
Purge Lockings	5-58
Purge Notifications	5-59
Purge Price Change Worksheet	5-59
Purge Price Histories	5-60
Purge Related Items	5-60
Purge Resolved UIN Problems	5-61
Purge RFID.....	5-61
Purge Sales Posting.....	5-62
Purge Shelf Adjustments.....	5-63
Purge Shelf Replenishment.....	5-63
Purge Staged Message.....	5-64
Purge Stock Counts.....	5-65
Purge Temporary UINs.....	5-65
Purge Ticket Histories	5-66
Purge Vendor Returns.....	5-66
Data Purging Batches - BDI Staging Data	5-67
Purge BDI Inbound Price	5-67
Purge BDI Item	5-68
Purge BDI Item Loc.....	5-68

Purge BDI Location.....	5-69
Purge BDI Misc Group	5-70
Purge BDI Price Hist.....	5-70
Purge BDI Rfid.....	5-71
Purge BDI Store Inventory Avail.....	5-71
Purge BDI Supp Item.....	5-72
Purge BDI UDA	5-72
Purge BDI Warehouse Item Avail	5-73
Batch Job Administration	5-73
Job Administration.....	5-74
Job Admin Screen.....	5-75
Job Execution Log Screen.....	5-76
Job Launch Screen.....	5-77
Ad hoc Job.....	5-78
Data Seed Importer Job	5-79
Start an Ad hoc Job	5-80
View Details for Job.....	5-80
Start a Data Seed Job	5-81
Stop a Running Job	5-81
Job Scheduler	5-81
Job Scheduler Screen	5-85
Configuring a Job Schedule.....	5-87
Disabling a Job Schedule	5-87

6 Batch - Data Archive

Archive Data Batches.....	6-1
Archive Dump Batches.....	6-2
Archive Batch Scheduling Consideration	6-2
Archive Data Dump Files Export	6-2

7 Technical Maintenance Screens

Barcode Processor.....	7-1
Barcode Processors.....	7-3
Credential Administration	7-3
External Printer Setup	7-5
MPS Staged Message.....	7-7
MPS Work Type	7-9
POS Transaction Resolution	7-11
Sequence Administration	7-13

8 Integration

Overall Integration Touchpoints.....	8-2
Retail Integration Cloud Service (RICS) - based Integration	8-2
Customer Orders.....	8-3
Picking	8-3
Deliveries.....	8-3

Reverse Picking	8-4
Multi Leg	8-4
RIB Payloads	8-4
Purchase Orders and Vendor Deliveries	8-5
Inventory Adjustments.....	8-6
Items	8-6
Stock Counts	8-7
Transfers	8-7
Transfer Creation	8-7
Transfer Messages.....	8-7
Transfer Shipment Creation	8-7
Transfer Receiving	8-8
Transfer Doc.....	8-10
Transfer Shipment.....	8-11
Transfer Receiving	8-11
Vendor Return	8-11
RTV Creation	8-11
RTV Shipment	8-11
Batch Integration	8-15
Overview	8-15
BDI-Based Batch Integration	8-15
Initial Foundation Data Seeding.....	8-15
Recurring BDI Transaction Batches.....	8-17
BDI Transmitter CLI - Client Batch File Loader	8-17
SFTP-Based Batch File Integration	8-18
Web Services	8-20
Security Considerations	8-20
Functionality	8-20
Available Web Services	8-21
Web Services Basic Design Principles	8-22
Internally Managed vs Externally Managed.....	8-23
Web Service Operation Basic Design Standards	8-24
Interpreting Validation Errors.....	8-25
Common Error Codes	8-25
Validation Error (Fault Example)	8-26
Business Error (Fault Example)	8-27
Web Services	8-27
ActivityLock.....	8-27
FulfillmentOrderDelivery.....	8-28
FulfillmentOrderPick.....	8-28
FulfillmentOrderReversePick.....	8-29
InventoryAdjustment	8-30
ItemBasket.....	8-30
OrderRequest.....	8-31
POSTransaction.....	8-32
ProductGroup.....	8-32
ProductGroupSchedule.....	8-32

ReplenishmentGap	8-33
RfidInventory	8-33
ShelfAdjustment.....	8-34
ShelfReplenishment.....	8-34
StockCount.....	8-35
Store	8-35
StoreFulfillmentOrder	8-36
StoreInventory	8-36
StoreInventoryISN	8-37
StoreInventoryUIN	8-37
StoreItem	8-38
StoreItemPrice	8-38
StoreNotification	8-39
StoreShipmentManifest.....	8-39
StoreShipmentReason.....	8-39
StoreTicket.....	8-39
StoreTransfer	8-40
TransferDelivery	8-41
TransferShipment.....	8-42
VendorDelivery	8-43
VendorReturn.....	8-44
VendorShipment	8-45
Enterprise Documentation.....	8-46
Sales Integration	8-47
POS and Sales Audit Process Flow.....	8-47
Sales and Return Processing.....	8-48
Customer Order Processing	8-48
Item Disposition.....	8-49
Drop Ship	8-49
Item Types.....	8-49
RFID	8-49
Integration with Manifesting Systems	8-49
Customer Order.....	8-50
Integration for Ticket Printing	8-51
Integration for Sales Forecast	8-51
Integration for Store Order	8-51
Retail Home Integration	8-53
Launch SIOCS from Retail Home	8-53
Tile Reports	8-54
EICS Endpoints.....	8-55
Shop Floor Out of Stock Items	8-55
Stock Counts - Ready to Authorize	8-55
SIOCS Operational Views	8-55
Launch SIOCS Operational Views from Tile Report	8-56

9 Configuration

System Admin Parameters	9-1
-------------------------------	-----

Store Admin Parameters	9-33
Permissions.....	9-49
10 Operational Issues Screens	
Operational Issues List Screen	10-2
Operational Issues Review	10-2
Operational Review Screen Actions	10-2
Bulk Data Import	10-4
Data Purge.....	10-4
Message Processing.....	10-4
Transactional Execution	10-5
A Appendix: Run Importer Separately from SIOCS Job Admin	
Run Data Seeding Importer Jobs	A-1
BDI Transaction (TX) Importer Jobs.....	A-3
B Appendix: BDI Transmitter CLI Procedure - Load External Data File	
BDI Transmitter CLI Tool Setup.....	B-1
Tool Usage	B-3
File Processing	B-4
Output Logs	B-4
Error Reprocessing.....	B-5
Schedule EICS Importer Jobs for Transmitter Loaded Data	B-5
View EICS Importer Jobs Execution Details	B-6
C Appendix: BDI Security Roles and Groups	
BDI Batch Admin Security	C-1
BDI Process Flow Security	C-2
BDI Scheduler Security.....	C-2
D Appendix: Report Formats	
Reports.....	D-1
Report Formats.....	D-2
E Appendix: Batch File Layout Specifications	
Third Party Stock Count Parser Import File Layout Specification.....	E-1
Filename Format.....	E-1
Zip Filename Format	E-1
Third Party Stock Count Import File Format.....	E-1
File Layout.....	E-2
Clearance Price Change Import File Layout Specification	E-2
Filename Format.....	E-3
Zip Filename Format	E-3
File Record Types	E-3
File Layout.....	E-3

Regular Price Change Import File Layout Specification	E-4
Filename Format.....	E-4
Zip Filename Format	E-4
File Record Types	E-5
File Layout.....	E-5
Promotion Price Change Import File Layout Specification	E-6
Filename Format.....	E-6
Zip Filename Format	E-6
File Record Types	E-7
File Layout.....	E-7
POS Sale Transaction Import File Specification	E-10
Filename Format.....	E-10
Zip Filename Format	E-11
POS Sale Transaction Import File Format	E-11
File Layout.....	E-11
Retail Sale Audit Import File Specification	E-12
Filename Format.....	E-12
Zip Filename Format	E-12
ReSA Transaction Import File Format	E-13
File Layout.....	E-13
Stock Count Results Export File Specification	E-15
Store Sequence Data Parser Import File Layout Specification	E-16
Filename Format.....	E-16
Zip Filename Format	E-17
Store Sequence Import File Format	E-17
File Layout.....	E-17
Warehouse Stock Import File Layout Specification	E-18
Filename Format.....	E-18
Zip Filename Format	E-18
Warehouse Stock Import File Format	E-18
File Layout.....	E-19
Initial Inventory Import File Layout Specification	E-19
Filename Format.....	E-19
Initial Inventory Import File Format	E-19
File Layout.....	E-19
Inventory Extract Export File Specification	E-21
Filename Format.....	E-21
Inventory Extract File Format	E-21
File Layout.....	E-21

F Appendix: Auto-Authorized Third-Party Stock Count Process Overview

Third Party Processing	F-3
Third Party Recovery	F-3

G Appendix: Unit and Amount Stock Counts Export

Export File Layout	G-1
--------------------------	-----

Export File Location	G-1
Export File Name	G-1
H Appendix: UPC Barcode	
Differences between UPC-A and UPC-E	H-1
Conversion between UPC-A and UPC-E	H-2
I Appendix: EICS Provided URLs	
EICS web-client URL	I-1
SOCS (connections config) URL	I-1
EICS Web Service URLs.....	I-1
BDI Related URLs	I-3
EICS-RICS Integration URLs.....	I-3
EICS-RICS Message Publishing	I-3
Setting Up RIB Message Injector	I-3
BI Related URL	I-4
ORDS (Apex Data Viewer) URL	I-4
J Appendix: Data Seeding Process Flows	
Data Seeding Process Flows from Merchandising to EICS	J-1
Data Seeding Mapping Tables between SIOCS and BDI.....	J-3
K Appendix: Pricing Import with On-premise RPM	
Clearance Price Change Import with On-premise RPM.....	K-1
Promotion Price Change Import with On-premise RPM	K-2
Regular Price Change Import with On-premise RPM	K-3
L Appendix: Open Transaction Seeding via BDI	
Overview	L-1
BDI Implementation Considerations	L-2
Option A: BDI External Process Flow (via External Edge App)	L-2
Option B: BDI CLI Transmitter	L-2
Open Transaction Data Processing	L-2
Direct Delivery - Import Details	L-3
Transfer - Import Details.....	L-4
Purchase Order - Import Details.....	L-4
Data Mapping	L-5
Data Import Exception Handling	L-9
Additional Details for BDI CLI File Imports	L-14
DSD Interface Specification	L-14
Purchase Order Interface Specification.....	L-17
Transfer Interface Specification.....	L-17
Setup BDI CLI File Transmitter Tool	L-19
Run BDI CLI File Transmitter	L-21
Run Importer Job	L-22

M Appendix: Third Party Pricing Integration

Overview M-1
BDI Implementation Considerations M-1
Third Party Pricing Import via BDI CLI File Transmitter M-3
External Price File Layout M-4
File Contents Explanation..... M-5

N Appendix: Third-Party RFID Integration

Overview N-1
BDI Implementation Considerations N-1
Third-Party RFID Import via BDI CLI File Transmitter N-3
EXT_RFID_IN N-3
External RFID CSV File Fields N-4
File Contents Explanation..... N-4

O Appendix: Item Ticket

P Appendix: SFTP File Directory and Filename Format

File Upload Directory and Filename Format P-2
File Download Directory and Filename Format..... P-6

List of Tables

3-1	Report URL Location.....	3-3
3-2	Operational Reports.....	3-5
4-1	Translation Topics.....	4-3
4-2	Translation Data JET Screens	4-6
5-1	Batch Users and Roles	5-2
5-2	Batch System Configuration Options.....	5-2
5-3	Key Tables for Archive Activity History	5-7
5-4	Key Tables for Archive Dump	5-7
5-5	Key Tables for Archive Item Un History.....	5-8
5-6	Key Tables for Archive RFID History	5-8
5-7	Key Tables for Archive Store Item Stock History.....	5-9
5-8	Key Tables for Archive Ticket History	5-9
5-9	Key Tables for Auto Replenish Capacity Batch.....	5-9
5-10	Key Tables for Auto Ticket Generate Batch	5-10
5-11	Key Tables for Auto Ticket Print Batch	5-11
5-12	Key Tables for Cleanup Batch Directories.....	5-11
5-13	Key Tables for Cleanup Shelf Replenishment Batch	5-12
5-14	Key Tables for Close DSD Receiving Batch.....	5-12
5-15	Key Tables for Extract Subscription Usage	5-13
5-16	Key Tables for Fulfillment Order Pick Reminders Batch.....	5-14
5-17	Key Tables for Fulfillment Order Reminders Batch	5-14
5-18	Key Tables for Problem Line Stock Count Batch.....	5-15
5-19	Key Tables for Generate Unit Amount Stock Count Batch.....	5-17
5-20	Key Tables for Generate Unit Stock Count Batch	5-18
5-21	Key Tables for Item Basket Maintenance Batch.....	5-20
5-22	Key Tables for Item Price to History Batch	5-21
5-23	Key Table for Close Prod Group Schedule Batch.....	5-21
5-24	Key Tables for Return Not After Date Alert Batch	5-22
5-25	Key Tables for Stock Count Authorize Recovery Batch.....	5-22
5-26	Key Tables for Stock Count Export Batch	5-23
5-27	Key Tables for Stock Count Unit And Amount Snapshot Batch	5-24
5-28	Key Tables for Store Order Auto Approve Batch	5-24
5-29	Key Tables for Store Order Auto Cancel Batch	5-25
5-30	Key Tables for Store Order Auto Generate Batch	5-25
5-31	Key Tables for Close Transfers Batch.....	5-26
5-32	Key Tables for Auto Receive Transfer Deliveries.....	5-27
5-33	Key Tables for Close Transfer Deliveries Batch	5-28
5-34	Key Tables for Transfers Not After Date Alert Batch.....	5-29
5-35	Key Tables for Transfers Overdue Batch.....	5-29
5-36	Key Tables for Close Vendor Return.....	5-30
5-37	Key Tables for Clearance Transaction Import	5-30
5-38	Key Tables for Price Change Transaction Import	5-31
5-39	Key Tables for Rfid Transaction Import	5-31
5-40	Key Tables for Third Party Pricing Import	5-32
5-41	Key Tables for Warehouse Avail Inventory Import	5-32
5-42	Key Tables for Initial Inventory Import Batch.....	5-34
5-43	Key Tables for Inventory Extract Batch	5-35
5-44	Key Tables for Pos Transaction Import Batch.....	5-36
5-45	Key Tables for Retail Sale Audit Import Batch.....	5-38
5-46	Key Tables for Store Sequence Import Batch	5-43
5-47	Key Tables for Third Party Stock Count Import Batch.....	5-43
5-48	Key Tables for Warehouse Item Stock Import Batch.....	5-44
5-49	Key Tables for Purge AdHoc Stock Count Batch.....	5-46

5-50	Key Tables for Purge Area Batch.....	5-46
5-51	Key Tables for Purge Batch Log Batch.....	5-47
5-52	Key Tables for Purge Closed Transfers Batch.....	5-48
5-53	Key Tables for Purge Completed UIN Detail Batch	5-49
5-54	Key Tables for Purge DSD Receivings Batch.....	5-50
5-55	Key Tables for Purge Fulfillment Orders Batch	5-51
5-56	Key Tables for Purge Invalid Users Batch.....	5-52
5-57	Key Tables for Purge Invalid User Roles Batch.....	5-53
5-58	Key Tables for Purge Inventory Adjustments Batch	5-53
5-59	Key Tables for Purge Item Batch	5-54
5-60	Key Tables for Purge Item Basket Batch.....	5-56
5-61	Key Tables for Purge Item Hierarchy Batch	5-57
5-62	Key Tables for Purge Item Price Batch.....	5-58
5-63	Key Tables for Purge Lockings Batch	5-58
5-64	Key Tables for Purge Notifications Batch.....	5-59
5-65	Key Tables for Purge Price Change Worksheet Batch.....	5-59
5-66	Key Tables for Purge Price Histories Batch.....	5-60
5-67	Key Tables for Purge Related Items Batch	5-61
5-68	Key Tables for Purge Resolved UIN Problems Batch.....	5-61
5-69	Key Tables for Purge Notifications Batch.....	5-62
5-70	Key Tables for Purge Sales Posting Batch	5-62
5-71	Key Tables for Purge Shelf Adjustment Batch.....	5-63
5-72	Key Tables for Purge Shelf Replenishment Batch.....	5-64
5-73	Key Tables for Purge Staged Message Batch	5-64
5-74	Key Tables for Purge Stock Counts Batch	5-65
5-75	Key Tables for Purge Temporary UIN Detail Batch	5-66
5-76	Key Tables for Purge Ticket Histories Batch.....	5-66
5-77	Key Tables for Purge Vendor Returns Batch	5-67
5-78	Key Tables for Purge BDI Warehouse Item Avail.....	5-68
5-79	Key Tables for Purge BDI Item	5-68
5-80	Key Tables for Purge BDI Item Loc.....	5-69
5-81	Key Tables for Purge BDI Location	5-69
5-82	Key Tables for Purge BDI Misc Group	5-70
5-83	Key Tables for Purge BDI Price Hist	5-71
5-84	Key Tables for Purge BDI Rfid.....	5-71
5-85	Key Tables for Purge BDI Store Inventory Avail	5-72
5-86	Key Tables for Purge BDI Supp Item.....	5-72
5-87	Key Tables for Purge BDI UDA	5-73
5-88	Key Tables for Purge BDI Warehouse Item Avail.....	5-73
5-89	Interval Based Schedule	5-81
5-90	Batch Job Schedules	5-82
6-1	Archive Data Batch List	6-1
6-2	Archive Dump Batch List	6-2
7-1	Barcode Processors	7-3
8-1	BDI Foundation Data Seeding Integration Object List.....	8-16
8-2	BDI Transaction Batch List	8-17
8-3	BDI Transmitter CLI List	8-18
8-4	SFTP-Based Batch File Integration Modules.....	8-19
8-5	Shop Floor Out of Stock	8-55
8-6	Stock Counts - Ready to Authorize	8-55
9-1	System Admin Parameters	9-1
9-2	Store Admin Parameters.....	9-33
9-3	Security Permissions.....	9-49
10-1	Security Permissions for Delete Actions.....	10-3
A-1	BDI Transaction (TX) Importer Jobs.....	A-3

B-1	bdi-file-transmitter.properties.....	B-1
C-1	BDI Batch Admin Role/Groups	C-1
C-2	BDI Process Flow Security Roles/Groups.....	C-2
C-3	BDI Process Flow Security Roles/Groups.....	C-3
D-1	Reports.....	D-1
E-1	Third Party Stock Count Import File.....	E-2
E-2	Clearance Price Change File Layout	E-3
E-3	Regular Price Change File Layout	E-5
E-4	Promotion Price Change Output File Layout	E-7
E-5	T-LOG File.....	E-11
E-6	ReSA File Layout.....	E-13
E-7	Stock Count Export File	E-15
E-8	Store Sequence Import File	E-17
E-9	Warehouse Stock Import File	E-19
E-10	Initial Inventory Import File.....	E-19
E-11	Inventory Extract File	E-21
H-1	UPC Conversion Table.....	H-2
I-1	EICS Application URL.....	I-1
I-2	SOCS Connections URL	I-1
I-3	EICS Web Service URLs	I-1
I-4	BDI Related URLs	I-3
I-5	RIB Message Publishing.....	I-3
I-6	BI Related URL.....	I-4
I-7	ORDS (Apex Data Viewer) URL.....	I-4
J-1	Data Seeding Process Flow Dependencies List	J-1
J-2	Data Seeding Mapping Tables between SIOCS and BDI	J-3
K-1	Key Tables for Clearance Price Change with On-premise RPM.....	K-2
K-2	Key Tables for Promotion Price Change with On-premise RPM.....	K-3
K-3	Key Tables for Regular Price Change with On-premise RPM	K-4
K-4	Key Tables for Regular Price Change Batch.....	K-4
L-1	EXT_DSD_IN and SIOCS Transaction Table Mappings	L-4
L-2	Configuration Parameters for DSD Received Status	L-4
L-3	EXT_TSF_IN and SIOCS Transaction Table Mappings.....	L-4
L-4	EXT_PURCH_ORDER_IN BDI And App Table Mappings	L-5
L-5	1. Purchase Order.....	L-9
L-6	2. Transfer.....	L-10
L-7	3. Allocation	L-11
L-8	4. Direct Store Delivery (DSD)	L-12
O-1	Ticket Attributes - Print to Bluetooth Printer	O-1
O-2	Ticket Attributes - Print to Web-service	O-2
P-1	File Upload Directory and Filename Format	P-2
P-2	File Download Directory and Filename Format.....	P-6

Send Us Your Comments

Oracle Retail Enterprise Inventory Cloud Service Administration Guide, Release 19.5

Oracle welcomes customers' comments and suggestions on the quality and usefulness of this document.

Your feedback is important, and helps us to best meet your needs as a user of our products. For example:

- Are the implementation steps correct and complete?
- Did you understand the context of the procedures?
- Did you find any errors in the information?
- Does the structure of the information help you with your tasks?
- Do you need different information or graphics? If so, where, and in what format?
- Are the examples correct? Do you need more examples?

If you find any errors or have any other suggestions for improvement, then please tell us your name, the name of the company who has licensed our products, the title and part number of the documentation and the chapter, section, and page number (if available).

Note: Before sending us your comments, you might like to check that you have the latest version of the document and if any concerns are already addressed. To do this, access the Online Documentation available on the Oracle Help Center (OHC) website. It contains the most current Documentation Library plus all documents revised or released recently.

Send your comments to us using the electronic mail address: retail-doc_us@oracle.com

Please give your name, address, electronic mail address, and telephone number (optional).

If you need assistance with Oracle software, then please contact your support representative or Oracle Support Services.

If you require training or instruction in using Oracle software, then please contact your Oracle local office and inquire about our Oracle University offerings. A list of Oracle offices is available on our Web site at <http://www.oracle.com>.

Preface

This document describes the administration tasks for Oracle Retail Enterprise Inventory Cloud Service.

Audience

This document is intended for administrators.

Documentation Accessibility

For information about Oracle's commitment to accessibility, visit the Oracle Accessibility Program website at <http://www.oracle.com/pls/topic/lookup?ctx=acc&id=docacc>.

Access to Oracle Support

Oracle customers that have purchased support have access to electronic support through My Oracle Support. For information, visit <http://www.oracle.com/pls/topic/lookup?ctx=acc&id=info> or visit <http://www.oracle.com/pls/topic/lookup?ctx=acc&id=trs> if you are hearing impaired.

Related Documents

For more information, see the following documents in the Oracle Retail Store Inventory Operations Cloud Services Release 19.5 documentation set:

- *Oracle Retail Store Inventory Operations Cloud Services Release Notes*
- *Oracle Retail Store Inventory Operations Cloud Services Implementation Guide*
- *Oracle Retail Store Inventory Operations Cloud Services Data Model*
- *Oracle Retail Enterprise Inventory Cloud Service Security Guide*
- *Oracle Retail Enterprise Inventory Cloud Service User Guide*
- *Oracle Retail Store Operations Cloud Service User Guide*
- *Oracle Retail Store Operations Cloud Service Mobile Guide*

Improved Process for Oracle Retail Documentation Corrections

To more quickly address critical corrections to Oracle Retail documentation content, Oracle Retail documentation may be republished whenever a critical correction is needed. For critical corrections, the republication of an Oracle Retail document may at times not be attached to a numbered software release; instead, the Oracle Retail document will simply be replaced at the Oracle Help Center (OHC) website, or, in the case of Data Models, to the applicable My Oracle Support Documentation container where they reside.

This process will prevent delays in making critical corrections available to customers. For the customer, it means that before you begin installation, you must verify that you have the most recent version of the Oracle Retail documentation set. Oracle Retail documentation is available at the Oracle Help Center at the following URL:

<https://docs.oracle.com/en/industries/retail/index.html>

An updated version of the applicable Oracle Retail document is indicated by Oracle part number, as well as print date (month and year). An updated version uses the same part number, with a higher-numbered suffix. For example, part number F123456-02 is an updated version of a document with part number F123456-01.

If a more recent version of a document is available, that version supersedes all previous versions.

Oracle Retail Documentation at the Oracle Help Center

Oracle Retail product documentation is available on the following website:

<https://docs.oracle.com/en/industries/retail/index.html>

(Data Model documents are not available through Oracle Help Center. You can obtain them through My Oracle Support.)

Conventions

The following text conventions are used in this document:

Convention	Meaning
boldface	Boldface type indicates graphical user interface elements associated with an action, or terms defined in text or the glossary.
<i>italic</i>	Italic type indicates book titles, emphasis, or placeholder variables for which you supply particular values.
monospace	Monospace type indicates commands within a paragraph, URLs, code in examples, text that appears on the screen, or text that you enter.

Technical Architecture

This chapter describes the overall software architecture, offering a high-level discussion of the general structure of the system.

Overall there is no change in deployment from the previous release period.

There are underlying version updates to the technical stack (DB 19c, Web Logic 12.2.1.4, updated versions of UI libraries, Fusion middle ware libraries and so on.)

Multiple Products

EICS (Enterprise Inventory Cloud Service) and SOCS (Store Operations Cloud Service) are two separately licensed products.

EICS includes:

- EICS Browser Client
- EICS Web Services
- EICS Server Tier
- EICS Database tier with data access code, batches, reports

SOCS includes:

- Oracle MAF Client

In order to use SOCS, EICS needs to be deployed.

Logical Model

Figure 1-1 Logical Model

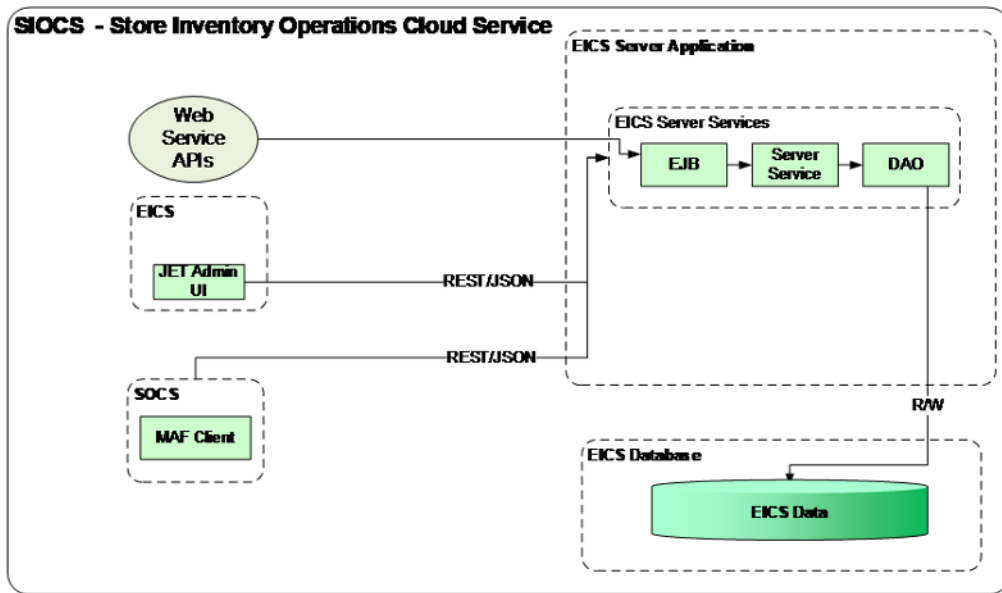

SaaS Deployment

Figure 1-2 SaaS Deployment

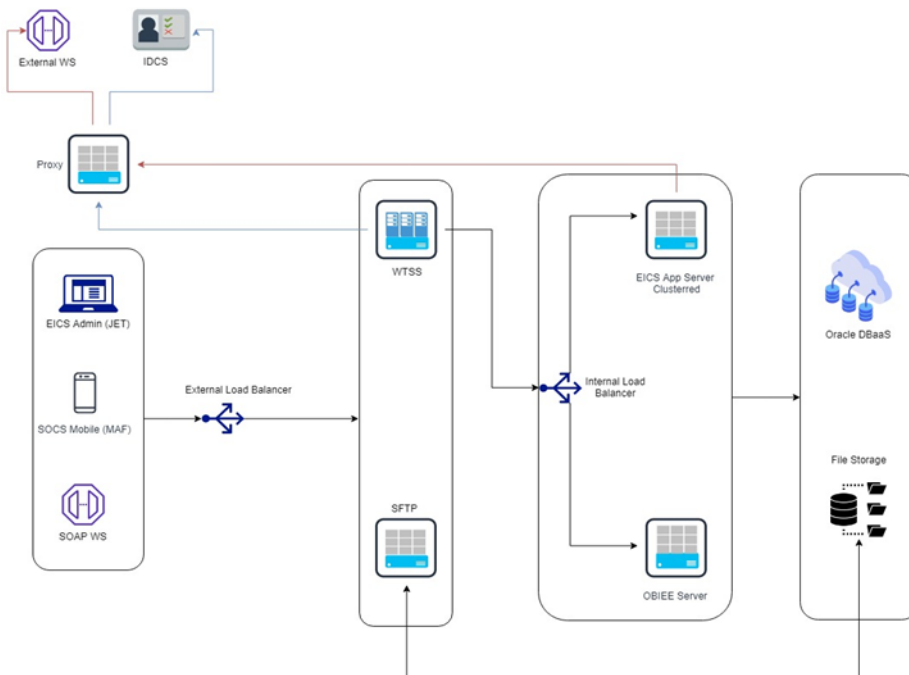

Cloud Deployment

EICS Client

Oracle JET based browser application that allows the user to perform a wide range of administrative functions.

SOCS Mobile Client

The mobile client provides all day-to-day transactional workflows within an Oracle Mobile Application Framework (MAF) platform. MAF is a hybrid-mobile platform that supports both iOS and Android devices. For more details, please see *Oracle Retail Store Operations Cloud Service Mobile Guide*.

Web Services

There is no GUI for the SOAP web services APIs that are provided by EICS. These APIs allow customers to create or develop applications or add-ons that can replicate some or all of the steps of a transaction workflow.

WTSS / IDCS or OCI IAM

WTSS: Web Traffic Security Service

Integration Cloud Services uses Oracle Identity Cloud Service (IDCS) as its identity provider (IDP) or Oracle Cloud Infrastructure Identity and Access Management (OCI IAM) as its identify provider (IDP).

EICS Application Server(s)

Server deployed as a J2EE application inside the WebLogic Application Server.

OBIEE Server

OBIEE / BIPublisher is used as reporting engine.

SFTP Server

The Secure File Transfer Protocol server is responsible for the moving of files from outside the internet firewall to within the internet firewall in a secure manner. This is used with File Storage Service.

Oracle DB Server (DBaaS)

Contains EICS schema. Uses JDBC to access data from the database.

WebLogic application server provides a connection pool to use database resources in an efficient fashion.

PL/SQL stored procedures are also used for high volume batch processing.

Client-Server Communication

Client(s) use ReST service calls to access the server.

External systems may use SOAP service calls to access the server.

All transactions are container managed.

Performance is sensitive to network latency (hence compression from client to server).

Integration

Oracle Retail Integration Cloud Server (RICS) is used for integration between multiple systems within the cloud as well as deployment of public web services by EICS and other systems.

Oracle Retail Integration Bus (RIB)

The RIB is a near-real time, message-based communication queue. Payloads are delivered in an asynchronous fashion between multiple systems on the enterprise in a non-blocking (fire and forget) manner. This broadcast of notifications is subscribed to by each application interested in an event notification.

SOAP Web Services

Numerous APIs into EICS Server are exposed through operations in a wide array of SOAP web services available to external applications.

File-Based

EICS receives information through several file-based scenarios in order to receive large volumes of data for more efficient processing. These include sales records, stock counts performed by a third party, and price change from a price management system.

Deployment with Other Products

EICS is deployed in three ways:

- It is deployed with the rest of Retail assets such as Retail Merchandising Foundation Cloud Service and Retail Integration Cloud Service.
- It is deployed with POS/Xstore typically with or without RIB.
- It is deployed as a stand-alone or point deployment.

EICS and SOCS have a distributed deployment model with browser and mobile devices running at stores, connecting with server and database hosted at corporate. The central server deployment allows real-time inventory queries for stock-on-hand positions across the enterprise but requires a fairly robust network connection between store and corporate environments.

Deployment - Performance: Bandwidth, Scaling

Bandwidth Requirements for Browser Clients

Installations with less than 128 KB bandwidth available between the device containing the browser or the mobile application and the data center are not recommended or supported. Limiting the client to less than 128 KB total available bandwidth causes unpredictable network utilization spikes, and the performance of the client degrades below requirements established for the product.

Network Latency Constraints

EICS is also sensitive to the network latency between the browser or mobile device and the data center. Oracle Retail does not recommend or support installations with more than 100 ms total round-trip network latency between the client device and the data center. Latency beyond the 100 ms limit causes unpredictable network utilization spikes, and the performance of the client degrades below requirements established for the product. The 100 ms limitation provides reasonable, predictable performance and network utilization for transactions.

Application Server Clustering

EICS supports application server clustering with a load balancer for Oracle WebLogic.

The EICS Server can run inside an application server cluster, but the load must be distributed among the nodes in the cluster.

It is also possible to configure a single application server instance with multiple JVMs inside the application server instance. When doing this, an upper limit of 1.5 to 2 JVMs per server CPU is recommended.

Clustering for Oracle WebLogic Server is also supported through a load balancer.

Database Clustering with RAC

EICS supports a RAC-enabled database for performance.

Data Seeding

This chapter contains the following:

- [What is Data Seeding?](#)
- [Overview of Data Seeding Process](#)
- [Pre-requisites](#)
- [Configure EICS for Data Seeding](#)
- [Run BDI Data Seeding](#)

What is Data Seeding?

EICS needs merchandising foundation data (stores, items, initial inventory positions, suppliers, and so on) in order to function.

Initial inventory data seeding is applicable for new or fresh full EICS installation and should only be run once. Once the initial set of data is seeded into EICS, subsequent inventory changes are communicated via Oracle Retail Integration Cloud Service (RICS - RIB).

EICS data seeding uses Oracle Retail Integration Cloud Service (RICS) BDI process to seed data from MFCS into the EICS. There are 35 processes that get extracted from MFCS into EICS. These processes have been grouped into nine (9) groups based on dependency and functionality. See [Table J-1, Data Seeding Process Flow Dependencies List](#) for details.

Data seeding can be used for a variety of use cases:

- Loading just the Foundation data from Merchandising
- Loading all stores data
- Loading a single store data

Overview of Data Seeding Process

1. An **Extractor** extracts data from a data producing system into an outgoing intermediate integration interface table.
2. A **Downloader** and **transporter** services data to receiver service.
3. An **Uploader** uploads the data to an incoming intermediate integration interface table.
4. An **Importer** imports the data from the interface tables into EICS application tables.

For additional detail on BDI Data Integration Topologies, please see *Oracle Retail Bulk Data Integration Implementation Guide*.

Pre-requisites

Prior to running data seeding, the following requirements must be met:

Sourcing System must be installed:

The sourcing system is the merchandising foundation data sourcing system, such as MFCS.

BDI Transport System must be installed:

BDI Process Flow: Mechanism to run multiple dependent batch jobs.

- BDI-RMS Batch Job Admin: Provides management of BDI for RMS batch jobs.
- BDI-SIM Batch Job Admin: Provides management of BDI for EICS batch jobs.

Target System must be installed:

EICS is the receiver target system, proper security settings and system configuration for data seeding must be set. See [Configure EICS for Data Seeding](#) section for details.

Configure EICS for Data Seeding

- [Security Settings](#)
- [Configuration Parameters](#)
- [Steps to Enable Data Seeding in SIOCS UI](#)

Security Settings

There are two types of security assignments. IDCS Integration Users Role and Application Permissions. Integration User Role is managed within IDCS or OCI IAM. EICS Application Permissions are managed via SIOCS. See *Oracle Retail Enterprise Inventory Cloud Service Security Guide* "User Provisioning" section for details.

The following table shows user security relevant to Data Seeding:

Task	IDCS or OCI IAM Application Role	Application Permission Name	Description
BDI Process Flow Integration to access EICS Importer Service	integration_users	N/A	<p>The Application integration user is meant for non-EICS application accessing EICS provided integration resources. The integration app user only needs to be assigned to enterprise security group.</p> <p>Notes:</p> <p>The application integration user does not require access to the SIOCS client applications, and therefore does not require store assignments or role assignments (permissions).</p>

Task	IDCS or OCI IAM Application Role	Application Permission Name	Description
View EICS Import Job Activities	sysop_users	Access Job Admin	Allows access to SIOCS batch job screen.
Manual Run Data Seed Importer	sysop_users	Access Data Seed	Allows SIOCS user to manually run data seeding importer jobs via SIOCS batch job admin.

Note: sysop_users IDCS or OCI IAM Application Role should only be assigned to Oracle Cloud Administrator users.

Configuration Parameters

The EICS Data Seeding Importer process in EICS imports data from the staged or intermediate tables into EICS application tables. The configuration parameters determine how the importer process operates in EICS.

The data seeding system configuration flags are disabled upon EICS installation because the full set of data should only be loaded once for foundation inventory data and store inventory data.

The following table shows the configuration parameters and their default values.

Configuration Name	Description
Data Seed Foundation Data	<p>The foundation data can be used for initial bulk load of EICS foundation data (such as Supplier, Merchandise Hierarchy, Item and others) from data producing system during initial setup of EICS system. This option should be disabled after EICS data seeding is completed. Default value is set to No.</p> <p>If you set this parameter to Yes, then data from sourcing system is automatically loaded into EICS application tables during BDI Process Flow process. If you leave this parameter to No, the process loads the data from sourcing system into EICS BDI inbound interface tables, then you must run Importer Job to load data from interface tables into application tables manually via SIOCS Batch Job Admin Console, see Appendix: Run Importer Separately from SIOCS Job Admin for details.</p>
Data Seed Store Data	<p>The seed store data can be used for initial bulk data load of EICS store inventory data (such as Store Item, and Store Item Stock) from a data producing system. Default value is set to No.</p> <p>If you set this parameter to Yes, then store data from sourcing system are automatically loaded into EICS application tables during BDI Process Flow process. If you leave this parameter to No, the process loads the store data from sourcing system into EICS BDI inbound interface tables, then you must run Importer Job to import store data from interface tables into application tables manually via SIOCS Batch Job Admin Console, see Appendix: Run Importer Separately from SIOCS Job Admin for details.</p>

Configuration Name	Description
Data Seed By Store	Determines whether the store data are automatically loaded for a single store only when Data Seed Store Data is set to Yes. By default, this parameter is set to No, then all stores and inventory are seeded. To rollout a single store, enable this configuration allows only a single store's inventory data to be seeded. Default value is set to No . If you set this parameter to Yes , then you must run Importer Job for store data manually via SIOCS Batch Job Admin Console, see Appendix: Run Importer Separately from SIOCS Job Admin for details.
Data Seed Chunk Limit	Controls the data seeding transaction size limit. Default value is set to 10000.
Data Seed On Error Continue	This flag determines how the error should be handled during data seeding import process. If the flag is turned on (true), the process will skip the current chunk of data, and continue to process next chunk of data. If the flag is turned off (false), the data loading process will be terminated when an error occurs. Default value is set to No .

To change configuration values:

1. Login to Oracle Enterprise Inventory Cloud Service page as EICS System Ops user.

Note: Full details about the configuration screens can be found in the *Oracle Retail Enterprise Inventory Cloud Service User Guide*.

2. On Main Menu, select Admin - Configuration - System Administration.
3. Search for data seed in option field, change value and save the change.

Figure 2–1 Data Seed Settings

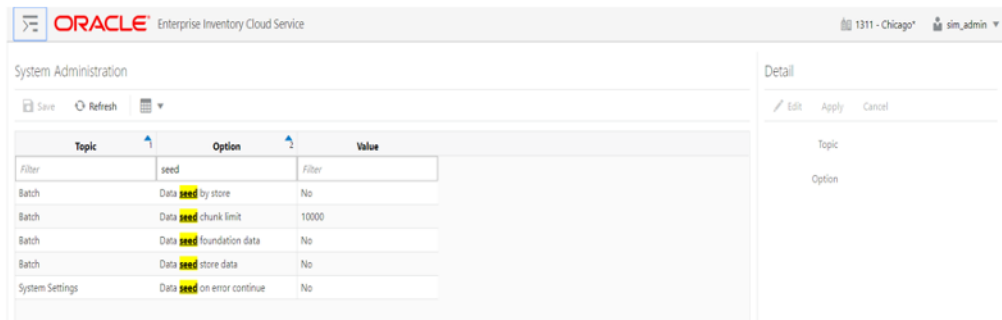

Steps to Enable Data Seeding in SIOCS UI

To seed initial inventory foundation data from sourcing system directly into destination application tables, an application implementation consultant must perform the following configuration steps:

1. Use SIOCS System Administration Console to set **data seeding foundation** to **Yes**.
2. Use SIOCS System Administration Console to set **data seeding store** to **Yes**.

Steps to Manual Control Importers

Optionally, if you want to manually control importer steps, perform the following steps:

1. Use SIOCS System Administration Console to set **data seeding foundation** to **No**.
2. Use SIOCS System Administration Console to set **data seeding store** to **No**.
3. Start BDI Process Flow (see [BDI Process Flow Admin Console](#) section for details).
4. Once data is loaded into inbound interface table, if you want to import interface data into application tables, set **data seeding foundation** to **Yes**, set **data seeding store** to **Yes**.
5. Use SIOCS Batch Job Admin Data Seeding jobs to manually start data seeding importer job.

Optional Steps Prior Initial Seeding

For initial data seeding into EICS, if slowness is observed due to validating data integrity constraints, sysop user can disable the data seeding constraints prior to running initial data seeding (Note: only certain predefined database constraints can be disabled via Data Seeding Console). The database constraints must be enabled after initial data seeding is completed.

To disable data seeding constraints:

1. Login Oracle Enterprise Inventory Cloud Service page as EICS System Ops user.
2. On Main Menu, select **Admin/ Technical Maintenance/Job Admin**.
3. On Job Admin Screen, click **Data Seed**, this will bring you to the Data Seed screen.
4. Select Job Name **Database Constraints**.
5. From Seed Option drop down list, select **Disable Constraint**.
6. Click **Start Job**.

Notes: See Post Data Seeding steps for enable data seeding constraints

Run BDI Data Seeding

You only need to run one- time full data seeding to initially seed functional inventory data into EICS.

The data seeding processes can be started via [BDI Process Flow Admin Console](#).

BDI Process Flow Admin Console

To start the process flow:

1. Login to BDI Process Flow Console.
2. Click **Manage Process Flow**.
3. Choose group **SIM** from **Select Group** drop-down list.

Note: For data seeding process flow list, see [Appendix: Data Seeding Process Flows](#) that shows a list of Data Seeding Process Flows from Merchandising to EICS with groups. There are no dependencies within the same data seeding process group.

Figure 2–2 BDI Process Flow Console

The screenshot shows the Oracle Process Flow Admin Console interface. At the top, it says "ORACLE Process Flow Admin Console" and "Welcome, bdiprocessadmin, logout Thu Nov 01 15:48 CDT 2018". Below this are several tabs: "Process Flow Live", "Live Progress View", "Manage Process Flow", "Historical Process Flow Executions", "Manage Configurations", and "System Logs". The main content area is titled "All Process Definitions". There is a checkbox for "Hide Disabled process" and a "Select Group" dropdown menu set to "SIM". A search box contains the text "Enter process name to search...". Below this is a table with the following data:

			split]	CDT 2018	CDT 2018
CodeDetail_Fnd_ProcessFlow_From_RMS	CodeDetail	SIM,EXTERNAL	[sender- side- split]	Fri Oct 05 00:00:01 CDT 2018	Thu Oct 18 19:56:36 CDT 2018
CodeHead_Fnd_ProcessFlow_From_RMS	CodeHead	SIM,EXTERNAL	[sender- side- split]	Fri Oct 05 00:05:00 CDT 2018	Thu Oct 18 19:57:29 CDT 2018

To start the process:

1. Select the process name.
2. Navigate to the lower panel and click **Launch Process Flow**.
3. Click **Run**.

Figure 2–3 Launch Process

The screenshot shows the "Launch Process" dialog box in the Oracle Process Flow Admin Console. The dialog has a title bar "Launch Process:". Below the title bar are two tabs: "Process Flow Executions" and "Process Flow Configurations". Under "Process Flow Executions" are sub-tabs "Process Flow Details", "Start Process", and "Stop Process". The "Process Name" field is populated with "CodeHead_Fnd_ProcessFlow_From_RMS". The "Process Parameters (Optional)" field is empty, with a "For eg:" example below it: "keyName1=value1,keyName2=value2,keyName3=value3". A "Run" button is located at the bottom right of the dialog.

To view BDI Process Flow details, navigate to **Process Flow Execution** tab to track the status of process flow.

Figure 2–4 Process Flow Details

Process Name	Process Execution Start Time	Process Execution End Time	Process Status
CodeHead_Fnd_ProcessFlow_From_RMS	Wed Nov 07 11:38:06 EST 2018	Wed Nov 07 11:40:08 EST 2018	PROCESS_COMPLETED

View Process Flow component details:

- [Extractor](#)
- [Downloader](#)
- [Uploader/Receiver](#)
- [Importer](#)

Extractor

To view extract data from source app, launch edge app batch job admin. The following shows the steps to view extractor from RMS:

1. Launch RMS Batch Job Admin console.
2. Login as BDI Job Admin user.

Figure 2–5 RMS Batch Job

Job Name	Job Class	Job ID	Job Status	Start Time	End Time	Status
Wh_Fnd_ExtractorJob	Wh	17254	17439	Thu Mar 08 01:00:00 PST 2018		COMPLETED
WhAdd_Fnd_ExtractorJob	WhAdd	17253	17438	Thu Mar 08 00:55:01 PST 2018		COMPLETED
UomConversion_Fnd_ExtractorJob	UomConversion	17252	17437			COMPLETED
UomClass_Fnd_ExtractorJob	UomClass	17251	17436	Thu Mar 08 00:45:00 PST 2018		COMPLETED
UdaValues_Fnd_ExtractorJob	UdaValues	17250	17435	Thu Mar 08 00:40:00 PST 2018		COMPLETED
UdaItemLov_Fnd_ExtractorJob	UdaItemLov	17249	17434	Thu Mar 08 00:35:01 PST 2018		COMPLETED

For details, please see *Oracle Retail Bulk Data Integration Implementation Guide*.

Downloader

To view BDI Downloader job details:

1. Launch BDI for edge app batch admin console.
Follow these steps to view download from RMS.

2. Launch BDI RMS Batch Job Admin console.
3. Login as BDI RMS Job Admin user.

Figure 2–6 BDI RMS Batch Job

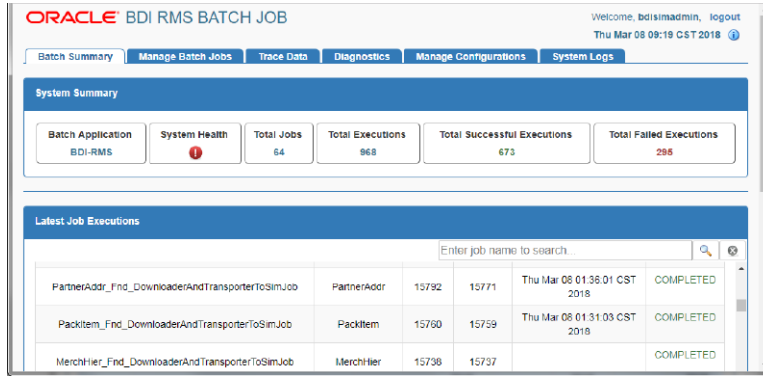

For details, please see *Oracle Retail Bulk Data Integration Implementation Guide*.

Uploader/Receiver

To view BDI SIM uploader details:

1. Launch BDI SIM Edge Batch Job Admin console.
2. Login as SIM BDI Job Admin user.

Figure 2–7 BDI SIM Batch Job

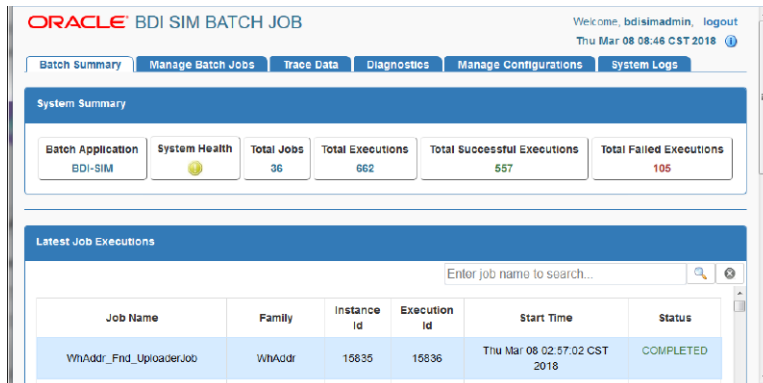

For details, please see *Oracle Retail Bulk Data Integration Implementation Guide*.

Importer

To View EICS Importer details:

1. Launch SIOCS application, login SIOCS as System Ops user.
2. On Main Menu, select Admin - Technical Maintenance - Job Admin.

Figure 2–8 SIOCS Job Admin

Execution ID	Job Name	Instance ID	Status	Start Time
4664	CodeHead_Fnd	4644	Completed	11/2/18 8:58:58 AM

- To view detail record, select the record, then click hyperlink on the execution id. This will bring you to the **Job Execution Detail** screen.

Figure 2–9 Job Execution

Detail ID	Processed	Failed	Message	Filter
4888	Yes	No		

Import Staging Data to Application Tables

If you set the EICS seed options to enabled, the data from external source system is automatically imported into the application table, and you can skip the following steps.

If you set the seed options to disabled, and want to import data from staging table to applications through manual steps, please refer to the following:

Task	Step
Enable Data Seed Flags	<p>Login SIOCS as System Ops user.</p> <p>On Main Menu, select Admin - Configuration - System Administration.</p> <p>Search for data seed on option field, change to desired value and save the change.</p> <p>Enabled Data Seed Foundation Data: true</p> <p>Enable Data Seed Store Data: true</p>
Import data from stage tables to application tables	See Appendix: Run Importer Separately from SIOCS Job Admin .

Re-running EICS Importer Data Loads

After correcting the errors during process flow, you may re-run the initial data seeding process flow.

Important: Before executing additional runs of data seeding, please choose the appropriate re-seed options in SIOCS Job Admin Console.

Note: To import data for a specific store, please see Addition Notes: Importing Data for Single Store section

EICS system ops user login SIOCS, from Main Menu, navigate to Admin Technical Maintenance - Job Admin

On Job Admin Screen, click **Data Seed**. This will bring you to the Data Seed screen (for screen details, see [Data Seed Importer Job](#)), perform the following steps:

Task	Step
Delete the previous seeded module data	<p>Choose desired module from job drop-down list, and then select Data Seed Option Deleted.</p> <p>For example:</p> <p>Choose Job Name Store End.</p> <p>Select Seed Option Delete Seeded.</p> <p>If you enter the store id, then only the seed data for that store is deleted.</p>
Re-import data from stage tables (see Re-import data from Source System, Re-import data step)	<p>Choose Job Name Store from job drop-down list, and then select Data Seed Option Seed.</p> <p>For example:</p> <p>If you enter the store id, then only the seed data for that store is seeded.</p> <p>If you want to import all stores, leave the store id as blank.</p>
Re-import data from Source System	<p>Delete the previous seeded module data</p> <p>Go to BDI process flow, choose the flow to be re-run, start the BDI process flow.</p>

BDI-Based Data Seeding Post-Load Processes

1. Enable Oracle Enterprise Inventory Cloud Service (EICS) constraints after data seeding.
 - a. Login SIOCS as EICS System Ops user.
 - b. On Main Menu, navigate to Admin - Technical Maintenance - Job Admin
 - c. On Job Admin Screen, click **Data Seed**. This will bring you to the Data Seed screen.
 - d. Select **Job Name** Database Constraints.
 - e. From **Seed Option** drop-down list, select **Enable Constraint**, click **Start Job**.

2. Purge data from inbound data seeding stage tables.

The inbound data seeding stage tables can be purged by batch job, the purge job purge group of data seeding interface tables, see [Data Purging Batches - BDI Staging Data](#) in the [Batches](#) chapter.

Alternatively, if you want to purge individual interface table, then follow following steps:

- a. Login SIOCS as EICS System Ops user.
 - b. On Main Menu, navigate to Admin Technical Maintenance - Job Admin.
 - c. On Job Admin Screen, click **Data Seed**. This will bring you to the Data Seed screen.
 - d. Select Each Importer Job Name (for example Code Head), then choose **Seed Option Delete In**, click **Start Job**.
3. Delete Starter Store

The starter store (store id = 0) is for System Ops User to login SIOCS application prior seeding the stores into the system. After stores are seeded into SIOCS, the starter store needs to be removed, the operation only deletes starter store 0 if there are other non-starter stores in SIOCS database.

To delete starter store, perform the following steps:

- a. Login SIOCS as EICS System Ops user.
 - b. On Main Menu, navigate to Admin Technical Maintenance - Job Admin.
 - c. On Job Admin Screen, click **Data Seed**. This will bring you to the Data Seed screen.
 - d. Select Each Importer Job Name (Store), then choose **Delete Starter Store**, click **Start Job**.
4. Turn off EICS Data Seeding System Configuration Flags.
 - a. Login SIOCS as EICS System Ops user.
 - b. On Main Menu, navigate to Admin - Configuration - System Administration.
 - c. Search for data seed on option field, change value and save the change.
 - d. Set the following values:
 - Enabled Seed Foundation:** No
 - Enable Seed Store Data:** No

EICS can produce reports for retails to view.

Reports are generated from within the functional areas of EICS and includes information about shipping documentation, delivery reports, pick detail reports and so on. EICS uses a report screen to preview the report by sending the request parameters as report name and required parameter for the corresponding listed reports.

This section covers the following:

- [EICS Reporting Framework](#)
- [Report URL Location](#)
- [Previewing a Report](#)
- [EICS Operational Reports](#)

EICS Reporting Framework

The following section describes the reporting framework.

Figure 3–1 Reporting Framework

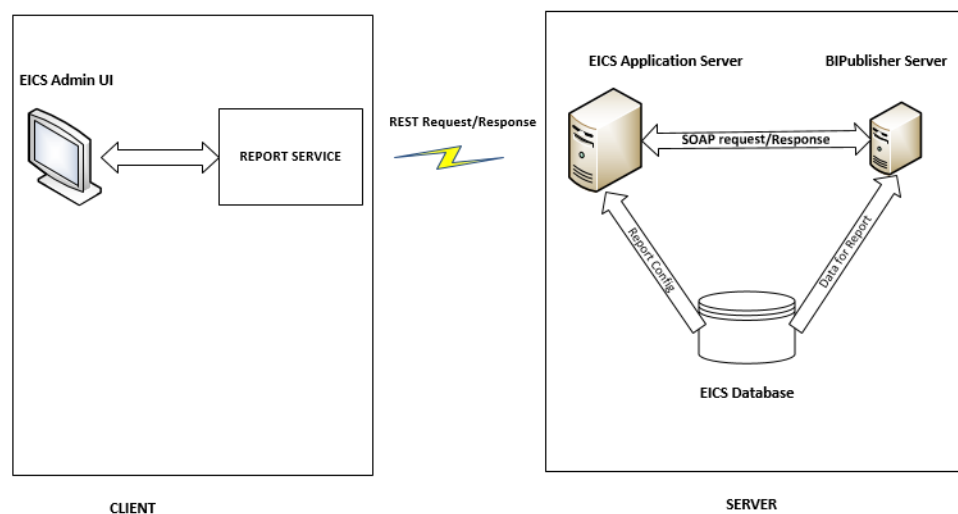

Report Service

The report format type is predefined as pdf format in the client. The report service use REST service calls to access the EICS server.

Security Considerations

Customers should create an IDCS or OCI IAM user and the user should be assigned the following BI IDCS or OCI IAM groups to access the report endpoints.

IDCS or OCI IAM groups required for production environment:

- BIConsumer
- BIContentAuthor
- BIAdministrator

IDCS or OCI IAM groups required for non-production environment:

- BIConsumer_preprod
- BIContentAuthor_preprod
- BIAdministrator_preprod

BI Publisher Server

EICS uses BI Publisher as the printing engine. BI Publisher gets the report data from the database by sql and generates the report in pdf format.

The following is the workflow for the process of Preview Reports:

1. A retailer makes a request on the JET Client to preview a report.
2. Format type of reports (pdf) which is added to the report detail parameters requested by retailers.
3. The client calls the reporting service to request the REST call.
4. The REST request hit the EICS server and fetch the report configuration from the EICS database to request the BI Publisher.
5. The BI Publisher server receives URLs or parameters, runs a query to retrieve data to be printed, and formats the data.
6. That data is then sent back to the UI as response and reports are download in the pdf format.

Note: EICS tables (REPORT_TEMPLATE) refer to the report format. The EICS server fetches the report configuration detail from this table.

Report URL Location

The URL Location for each report type:

Table 3–1 Report URL Location

Type	URL Location
Customer Order Report	<BIP_XMLPSEVER_URL>/SIOCS/CustomerOrderReport/CustomerOrderReport.xdo
Customer Order Delivery BOL Report	<BIP_XMLPSEVER_URL>/SIOCS/CustomerOrderDeliveryBOLReport/CustomerOrderDeliveryBOLReport.xdo
Customer Order Bin Label Report	<BIP_XMLPSEVER_URL>/SIOCS/CustomerOrderBinLabelReport/CustomerOrderBinLabelReport.xdo
Customer Order Delivery Report	<BIP_XMLPSEVER_URL>/SIOCS/CustomerOrderDeliveryReport/CustomerOrderDeliveryReport.xdo
Customer Order Pick Report	<BIP_XMLPSEVER_URL>/SIOCS/CustomerOrderPickReport/CustomerOrderPickReport.xdo
Customer Order Pick Discrepancy Report	<BIP_XMLPSEVER_URL>/SIOCS/CustomerOrderPickDiscrepancyReport/CustomerOrderPickDiscrepancyReport.xdo
Customer Order Reverse Pick Report	<BIP_XMLPSEVER_URL>/SIOCS/CustomerOrderReversePickReport/CustomerOrderReversePickReport.xdo
Direct Delivery Report	<BIP_XMLPSEVER_URL>/SIOCS/DirectDeliveryReport/DirectDeliveryReport.xdo
Direct Delivery AGSN Report	<BIP_XMLPSEVER_URL>/SIOCS/VendorDeliveryAGSNReport/VendorDeliveryAGSNReport.xdo
Direct Delivery Discrepant Item Report	<BIP_XMLPSEVER_URL>/SIOCS/DirectDeliveryDiscrepantItemsReport/DirectDeliveryDiscrepantItemsReport.xdo
Direct Delivery Label Report	<BIP_XMLPSEVER_URL>/SIOCS/VendorDeliveryLabel/VendorDeliveryLabel.xdo
Inventory Adjustment Report	<BIP_XMLPSEVER_URL>/SIOCS/InventoryAdjustmentReport/InventoryAdjustmentReport.xdo
InventoryAdjustmentAGSN Report	<BIP_XMLPSEVER_URL>/SIOCS/InventoryAdjustmentAGSNReport/InventoryAdjustmentAGSNReport.xdo
Item Basket Report	<BIP_XMLPSEVER_URL>/SIOCS/ItemBasketReport/ItemBasketReport.xdo
Item Detail Report	<BIP_XMLPSEVER_URL>/SIOCS/ItemDetailReport/ItemDetailReport.xdo
Purchase Order Report	<BIP_XMLPSEVER_URL>/SIOCS/PurchaseOrderReport/PurchaseOrderReport.xdo
RFID History Report	<BIP_XMLPSEVER_URL>/SIOCS/RFIDHistoryReport/RFIDHistoryReport.xdo
RTV Report	<BIP_XMLPSEVER_URL>/SIOCS/RTVReport/RTVReport.xdo
RTV Shipment Report	<BIP_XMLPSEVER_URL>/SIOCS/VendorShipmentReport/VendorShipmentReport.xdo

Table 3-1 (Cont.) Report URL Location

Type	URL Location
RTV Shipment BOL Report	<BIP_XMLPSEVER_URL>/SIOCS/VendorShipmentBOLReport/VendorShipmentBOLReport.xdo
RTV Shipment Container Report	<BIP_XMLPSEVER_URL>/SIOCS/VendorShipmentCartonReport/VendorShipmentCartonReport.xdo
RTV Shipping Label Report	<BIP_XMLPSEVER_URL>/SIOCS/VendorShippingLabel/VendorShippingLabel.xdo
Scan List Report	<BIP_XMLPSEVER_URL>/SIOCS/ReplenishmentGapReport/ReplenishmentGapReport.xdo
Shelf Adjustment Report	<BIP_XMLPSEVER_URL>/SIOCS/ShelfAdjustmentReport/ShelfAdjustmentReport.xdo
Shelf Replenishment Report	<BIP_XMLPSEVER_URL>/SIOCS/ShelfReplenishmentReport/ShelfReplenishmentReport.xdo
Stock Count All Location Report	<BIP_XMLPSEVER_URL>/SIOCS/StockCountAllLocReport/StockCountAllLocReport.xdo
Stock Count Report	<BIP_XMLPSEVER_URL>/SIOCS/StockCountReport/StockCountReport.xdo
Stock Count Export Report	<BIP_XMLPSEVER_URL>/SIOCS/StockCountExportReport/StockCountExportReport.xdo
Stock Count Rejected Item Report	<BIP_XMLPSEVER_URL>/SIOCS/StockCountRejectedItemReport/StockCountRejectedItemReport.xdo
Store Order Report	<BIP_XMLPSEVER_URL>/SIOCS/StoreOrderReport/StoreOrderReport.xdo
Transfer Report	<BIP_XMLPSEVER_URL>/SIOCS/TransferReport/TransferReport.xdo
Transfer Receiving Report	<BIP_XMLPSEVER_URL>/SIOCS/TransferDeliveryReport/TransferDeliveryReport.xdo
Transfer Receiving AGSN Report	<BIP_XMLPSEVER_URL>/SIOCS/TransferDeliveryAGSNReport/TransferDeliveryAGSNReport.xdo
Transfer Receiving Exception Report	<BIP_XMLPSEVER_URL>/SIOCS/TransferDeliveryExceptionReport/TransferDeliveryExceptionReport.xdo
Transfer Receiving Label Report	<BIP_XMLPSEVER_URL>/SIOCS/TransferDeliveryLabel/TransferDeliveryLabel.xdo
Transfer Shipment Report	<BIP_XMLPSEVER_URL>/SIOCS/TransferShipmentReport/TransferShipmentReport.xdo
Transfer Shipment BOL Report	<BIP_XMLPSEVER_URL>/SIOCS/TransferShipmentBolReport/TransferShipmentBolReport.xdo
Transfer Shipment Container Report	<BIP_XMLPSEVER_URL>/SIOCS/TransferShipmentCartonReport/TransferShipmentCartonReport.xdo
Transfer Shipping Label Report	<BIP_XMLPSEVER_URL>/SIOCS/TransferShippingLabel/TransferShippingLabel.xdo

Note: <BIP_XMLPSEVER_URL> is the folder where EICS reports have been uploaded on the BI Publisher server.

Previewing a Report

Users can download the report from EICS JET UI Home/Operations/Report.

Figure 3–2 Reports Screen

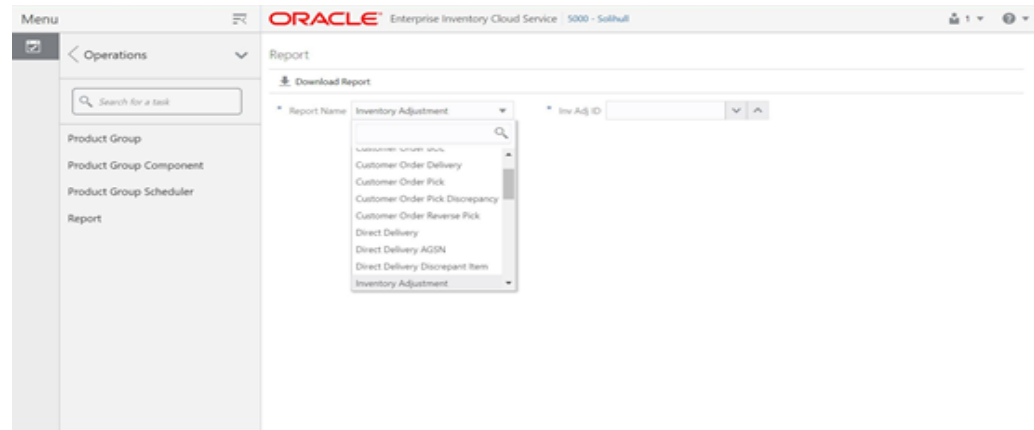

EICS Operational Reports

The following list shows the EICS Operational Reports.

Table 3–2 Operational Reports

Report Name	Report Parameters	Primary Views or Tables
Customer Order Bin Label Report	PICK_ID, COPIES	RPRT_FUL_ORD_BIN_V
Customer Order BOL Report	DELIVERY_ID, LOCALE_ID, STORE_TIMEZONE, COPIES	RPRT_FUL_ORD_DLV_BOL_V
Customer Order Delivery Report	DELIVERY_ID, LOCALE_ID, STORE_TIMEZONE, COPIES	RPRT_FUL_ORD_DLV_V
Customer Order Pick Discrepancy Report	PICK_ID, LOCALE_ID, STORE_TIMEZONE, COPIES	RPRT_FUL_ORD_PICK_DISC_V
Customer Order Pick Report	PICK_ID, LOCALE_ID, STORE_TIMEZONE, COPIES	RPRT_FUL_ORD_PICK_V
Customer Order Report	ORDER_ID, LOCALE_ID, STORE_TIMEZONE, COPIES	RPRT_FUL_ORD_V

Table 3–2 (Cont.) Operational Reports

Report Name	Report Parameters	Primary Views or Tables
Customer Order Reverse Pick Report	REVERSE_PICK_ID, LOCALE_ID, STORE_TIMEZONE, COPIES	RPRT_FUL_ORD_RV_PICK_V
Direct Delivery AGSN Report	CARTON_ID, COPIES	DSD_LINE_ITEM_UIN, ITEM_UIN
Direct Delivery Discrepant Items Report	RECEIPT_ID, LOCALE_ID, STORE_TIMEZONE, COPIES	RPRT_DSD_DISCREPANT_IT M_V, RPRT_DSD_V
Direct Delivery Label Report	CARTON_ID, LOCALE_ID	STOREDSD,DSD_ CARTON,DSD_LINE_ ITEM,SUPPLIER,ADDRESS,
Direct Delivery Report	RECEIPT_ID, LOCALE_ID, STORE_TIMEZONE, COPIES	RPRT_DSD_V, NOTES
Inventory Adjustment AGSN Report	INV_ADJUST_ID, COPIES	ITEM_UIN, INV_ADJUST_ LINE_ITEM_UIN
Inventory Adjustment Report	INV_ADJUST_ID, LOCALE_ID, STORE_TIMEZONE, COPIES	RPRT_INV_ADJUST_V, CONFIG_SYSTEM
Item Basket Report	ITEM_BASKET_ ID,LOCALE_ID,STORE_ TIMEZONE,COPIES	ITEM_BASKET, CODE_DETAIL
Item Detail Report	ITEMID, STOREID, LOCALE_ID, STORE_TIMEZONE, COPIES	STORE_SEQUENCE_ITEM, STORE_SEQUENCE_AREA, PRINT_FORMAT, TSF_ALLOCATION, ITEM, WAREHOUSE, RPRT_ITEM_DE TAIL_V
Purchase Order Report	PURCHASE_ORDER_ID, LOCALE_ID, STORE_TIMEZONE, COPIES	RPRT_PURCHASE_ORD_V
RFID History Report	ITEM_ID, FROM_DATE, TO_DATE, LOCALE_ID, COPIES	RPRT_RFID_HISTORY_V

Table 3-2 (Cont.) Operational Reports

Report Name	Report Parameters	Primary Views or Tables
RTV Report	RETURN_ID, LOCALE_ID, STORE_TIMEZONE, COPIES	RPRT_RTV_V
RTV Shipment BOL Report	SHIP_NUMBER, LOCALE_ID, STORE_TIMEZONE, COPIES	RPRT_RTV_SHIP_BOL_V, NOTES
RTV Shipment Container Report	CARTON_ID, LOCALE_ID, STORE_TIMEZONE, COPIES	RPRT_RTV_SHIP_V
RTV Shipment Report	SHIP_NUMBER, LOCALE_ID, STORE_TIMEZONE, COPIES	RPRT_RTV_SHIP_V
RTV Shipping Label Report	CARTON_ID, LOCALE_ID, COPIES	RPRT_RTV_SHIP_BOL_V, RTV_SHIP, CODE_DETAIL
Scan List Report	REPLENISH_GAP_ID, LOCALE_ID, STORE_TIMEZONE, COPIES	RPRT_REPLENISH_GAP_V
Shelf Adjustment Report	SHELF_ADJUST_ID, LOCALE_ID, STORE_TIMEZONE, COPIES	RPRT_SHELF_ADJUST_V
Shelf Replenishment Report	SHELF_REPLENISH_ID, LOCALE_ID, STORE_TIMEZONE, COPIES	RPRT_SHELF_REPLENISH_V
Stock Count All Location Report	STORE_ID, STOCK_COUNT_ID, COPIES	RPRT_STOCK_COUNT_V
Stock Count Detail Report	STOCK_COUNT_ID, STOCK_COUNT_CHILD_ID, STORE_TIMEZONE, PHASE, COPIES	RPRT_STOCK_COUNT_V

Table 3–2 (Cont.) Operational Reports

Report Name	Report Parameters	Primary Views or Tables
Stock Count Export Report	STOCK_COUNT_ID, COPIES	STOCK_COUNT_LINE_ITEM, STOCK_COUNT, STOCK_COUNT_LINE_ITEM_UIN
Stock Count Rejected Item Report	STORE_ID, LOCALE_ID, COPIES	RPRT_STOCK_COUNT_NOF_V
Store Order Report	STORE_ORDER_ID, STORE_TIMEZONE, LOCALE_ID	RPRT_STORE_ORDER_V, STORE_ORDER, STORE_ORDER_CFA, STORE_ORDER_CDA, CUSTOM_ATT_ADMIN
Transfer Receiving AGSN Report	CARTON_ID, COPIES	TSF_DELV_LINE_ITEM_UIN, ITEM_UIN
Transfer Receiving Exception Report	DELIVERY_ID, LOCALE_ID, STORE_TIMEZONE, COPIES	TSF_DELV, TSF_DELV_CARTON, TSF_DELV_LINE_ITEM, ITEM, STORE, WAREHOUSE, PARTNER, CONFIG_SYSTEM
Transfer Receiving Label Report	CARTON_ID,LOCALE_ID	TSF_DELV, TSF_DELV_CARTON, TSF_DELV_LINE_ITEM, STORE, ADDRESS
Transfer Receiving Report	DELIVERY_ID, LOCALE_ID, STORE_TIMEZONE, COPIES	TSF_DELV, TSF_DELV_CARTON, TSF_DELV_LINE_ITEM, ITEM, STORE_ITEM_STOCK, STORE, WAREHOUSE, PARTNER, CONFIG_SYSTEM, NOTES
Transfer Report	TRANSFER_ID, LOCALE_ID, STORE_TIMEZONE, COPIES	RPRT_TRANSFER_V

Table 3-2 (Cont.) Operational Reports

Report Name	Report Parameters	Primary Views or Tables
Transfer Shipment BOL Report	SHIPMENT_ID, LOCALE_ID, STORE_TIMEZONE, COPIES	TSF_SHIP,TSF_SHIP_ CARTON,TSF_SHIP_LINE_ ITEM,ITEM,CONFIG_ SYSTEM,SHIPMENT_ BOL,SHIPMENT_CARTON_ DIM,SHIPMENT_CARRIER_ SERVICE, SHIPMENT_CARRIER, STORE,ADDRESS,NOTES
Transfer Shipment Container Report	CARTON_ID, LOCALE_ID, STORE_TIMEZONE, COPIES	TSF_SHIP, TSF_SHIP_CARTON, TSF_SHIP_LINE_ITEM, ITEM, STORE, WAREHOUSE, PARTNER, CONFIG_SYSTEM, SHIPMENT_REASON
Transfer Shipment Report	SHIPMENT_ID, LOCALE_ID, STORE_TIMEZONE, COPIES	RPRT_TSF_SHIP_V, NOTES
Transfer Shipping Label	CARTON_ID, LOCALE_ID	TSF, TSF_SHIP, TSF_SHIP_CARTON, TSF_SHIP_LINE_ITEM, ITEM, SHIPMENT_BOL, STORE, ADDRESS

Internationalization

Internationalization is the process of creating software that can be translated easily. SIOCS has been internationalized to support multiple languages.

This section covers the following:

- [Supported Locales](#)
- [SOCS Client Translations](#)
- [EICS Client Translations](#)
- [EICS Server Translations](#)
- [Translation Topics](#)
- [Translation Keys](#)
- [Translation Setup Screen](#)
- [Translation File Upload](#)
- [Report Translations](#)

Supported Locales

SIOCS supports translation into following locales:

1. Arabic
2. Chinese (Simplified)
3. Chinese (Traditional)
4. Croatian
5. Dutch
6. English
7. French
8. German
9. Greek
10. Hungarian
11. Italian
12. Japanese
13. Korean

14. Polish
15. Portuguese (Brazilian)
16. Russian
17. Spanish
18. Swedish
19. Turkish

Apart from these, extension hooks are added for following new locales on EICS:

1. Albanian
2. Armenian
3. Azerbaijani
4. Belarusian
5. Bengali
6. Bosnian
7. Bulgarian
8. Burmese
9. Czech
10. Danish
11. Estonian
12. Filipino
13. Finnish
14. Georgian
15. Hebrew
16. Hindi
17. Indonesian
18. Kazakh
19. Khmer
20. Lao
21. Latvian
22. Lithuanian
23. Malay
24. Norwegian
25. Romanian
26. Serbian
27. Slovak
28. Slovene
29. Thai
30. Ukrainian

- 31. Urdu
- 32. Uzbek
- 33. Vietnamese

Translation records for these locales are defaulted to English. Translation value can be updated for these locales by accessing administration screen.

SOCS Client Translations

Translation of SOCS Graphical User Interface (GUI) and client-based display messages fall under this category.

SOCS client follows an XML format to organize translation records within a translation bundle. Each supported locale will have its own XLF file. For example, translations for French locale could be found under `SimMobileViewControllerBundle_fr.xlf` file. These XLF files are packaged with the rest of the application when the mobile application is built for deployment and any changes to them will require a new deployment of the mobile application.

EICS Client Translations

Translation of EICS Graphical User Interface (GUI) and client-based display messages fall under this category.

EICS Admin UI translations relies on following two bundle categories:

- Framework bundles: owned by JET/JRAF/LUX.
- EICS bundles: owned by EICS.

All these bundles are merged at runtime to provide an overall translation bundle which is used to provide translated UI content.

EICS owned translation are maintained in the EICS database. EICS client translation bundle is generated at runtime depending on the user locale and is applied on top of framework bundles by a custom plugin to provide an overall translation bundle for the client.

EICS Server Translations

Translation of server data, report data, notifications, server error messages, and other server-based message, fall under this category. These translation records are maintained in EICS database and are translated via a cached server translation provider.

Translation Topics

EICS translation records are grouped under translations topics for ease of management through the administration screens. Each translation key belonging to one of the translation topics below:

Table 4–1 Translation Topics

Translation Topic	Comments
Barcode	Captures translation keys for barcode processors.
Batch	Captures translation keys for batches.

Table 4–1 (Cont.) Translation Topics

Translation Topic	Comments
Carrier	Captures translation keys for shipment carrier and carrier services.
Code Info	Captures translation keys for code type and code details.
Configuration	Captures translation keys for system, store and store default configuration parameters.
Custom Attributes	Captures translation keys related to custom attributes.
Data	Captures translation keys related to system data like status, types and so on.
Date Import	Captures translation keys related to data import.
Inventory Adjustment Reason	Captures translation keys for inventory adjustment reason codes.
Isn Type	Captures translation keys related to ISN types.
Message	Captures translation keys related to server messages which are mostly error messages.
Non Sellable Type	Captures translation keys for non-sellable types.
Notification	Captures notification related translation keys
Reports	Captures translation keys related to reports.
Retail Home	Captures translation keys related to retail home tile reports.
Security	Captures translation keys for security permissions, groups and roles.
Shipment Reason	Captures translation keys for shipment reason codes.
UI	Captures translation keys related to user interface.

Translation Keys

EICS translation keys follow a dotted naming convention (for example, functional.area.key). The key name also identifies the functional area it belongs to which makes it easy to locate on the Translation Setup EICS Admin Client screen. Each key has a corresponding translation for each language. These translations can be modified using the administration screen.

Translation Setup Screen

This EICS admin client screen can be used to look up and edit EICS client and server translation records for a translation locale supported by the system. This screen does not support addition and deletion of translation records.

Bundle Selection Dialog

Bundle selection dialog automatically pops up when you navigate to the [Translation Setup Screen](#).

Select a bundle here and click **Apply** to load translation records.

Figure 4–1 Bundle Selection Dialog

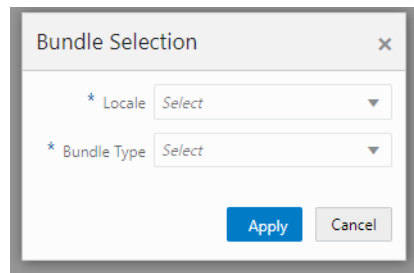

- **Locale Selection:** This drop-down will list all the translation locales supported by EICS server.
- **Bundle Type Selection:** This drop-down will list the translation bundles available for customization.

The screen supports following two bundle types:

- **Server:** This bundle identifies EICS Server translation records.
- **Operations UI:** This bundle identifies EICS Client translation records.

Dialog Buttons

- **Apply:** Clicking this button will load the translation records for the selected bundle criteria.
- **Cancel:** Clicking this button will close the dialog without performing any action.

Translation Setup Screen

The screen allows customization of EICS owned translation records only.

Figure 4–2 Translation Setup Screen

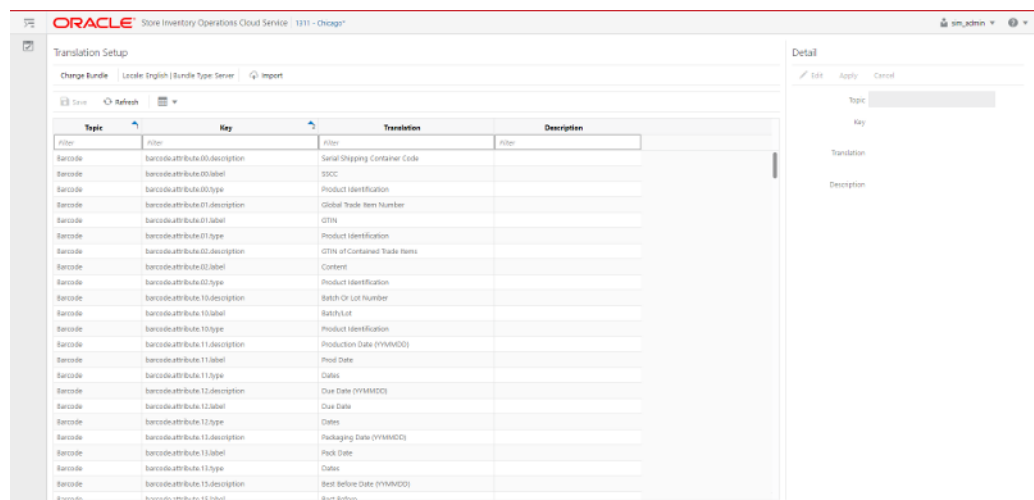

Navigation: Main Menu/ Admin/Translations/Translation Setup

Search Bar Options

- **Change Locale:** Clicking this button will popup bundle selection dialog.
- **Filter criteria:** This area displays the current search criteria.
- **Import:** Clicking this button will display the file import dialog. Refer to [Translation File Upload](#) section for more details.

List Buttons

- **Save:** Saves any changes made to the translation records.
- **Refresh:** Refreshes the translation records by loading them again.
- **Grid View Menu:** It's a drop-down menu that provides access to options like reset view, enable/disable column filter and export grid data to a CSV file.

List Attributes

- **Topic:** Translation topic for the translation record.
- **Key:** Translation key for the translation record.
- **Translation:** Actual translated text for the translation record.
- **Description:** Any additional description for the translation record.

Detail Buttons

- **Edit:** Enable editing of translation record.
- **Apply:** Apply changes to the translation record.
- **Cancel:** Cancel any changes made to the translation record.

Detail Attributes

- **Topic:** Translation topic for the translation record. It is not editable.
- **Key:** Translation key for the translation record. It is not editable.
- **Translation:** Actual translated text for the translation record. It is editable.
- **Description:** Any additional description for the translation record. It is editable.

In addition to the Translation Setup screen, the system maintains translation records for the following JET screens:

Table 4-2 Translation Data JET Screens

JET Screen	Column
Barcode Processor	Processor Name
Carrier	Description
Carrier Service	Description
Code Info	Description
Inventory Adjustment	Description
Shipment Reason	Description
Sub-bucket	Description
Custom Flexible Attribute	Display Label
Role Detail	Description

Translation File Upload

Translation Setup Screen allow the user to upload translations file. This allows the user to update translations in a file and import that file into the product.

Clicking on the **Import** button on **Translation Setup Screen** displays this dialog that can be used to download the template and upload updated files for the current locale.

Figure 4-3 *Import Translation File*

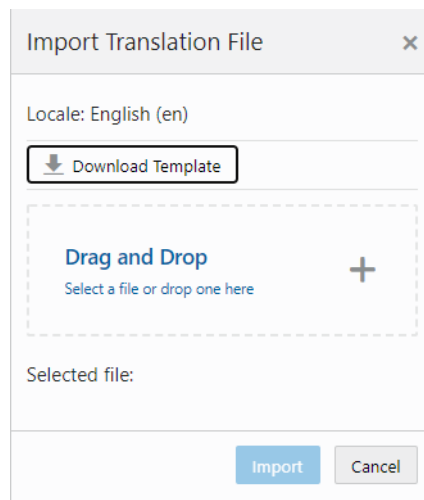

- **Locale:** It displays the selected locale.
- **Download Template:** Clicking on this button downloads a template CSV file which can be used to edit translation values across all available bundles for the selected locale. It does not matter which bundle is currently selected on the **Translation Setup Screen**. The file name would be of the format SIOCS_Translations_<locale>_Template.xlsx where locale is the selected locale.
- **Drag and Drop:** To select an updated file for import, the file can be dragged and dropped into the 'Drag and Drop' space on the dialog. Alternatively, a user can browse the file using the file selection wizard by clicking inside the 'Drag and Drop' space. File size should be > 0 MB and <= 5MB and should belong to the selected locale.
- **Selected File:** It displays the name of the selected file.
- **Import:** Clicking this button initiates the file import process. If there were any errors in the processing, an error file will be generated, and the user will be prompted if they want to save the file.
- **Cancel:** Clicking this button will close the dialog without taking any action.

Report Translations

Translation of report templates fall under this category. EICS provides XLF files for each report. At runtime BI publisher identifies the user locale and selects the appropriate XLF file to translate report template.

This section information describes the following topics:

- [Batch Overview](#)
- [Batch Admin Users](#)
- [Batch Configuration](#)
- [Operational Batches](#)
- [BDI-Based Batches](#)
- [SFTP File-Based Batches](#)
- [Purge Batches](#)
- [Batch Job Administration](#)

Batch Overview

The batch processes are designed to process large volume of data.

The batch jobs which are available for the retailer can be differentiated in following categories:

Operational Batch Jobs

These jobs are mostly used to perform background operations on the transaction and includes such tasks as generation of a transaction, closing the transaction after a specified date is passed, auto confirmation of the transaction, and so on.

Data Purge Jobs

These jobs are used to perform the purge operation on the application table. Each job is designed to purge the data from specific functional database tables. The number for day to retain the records in database can be configured separately via System Administration parameters.

Importer Batch Jobs

These jobs are used to perform import data from another system.

Batch Admin Users

The following list shows the batch related users. For additional details, please see the *Oracle Retail Enterprise Inventory Cloud Service User Guide*.

Table 5–1 Batch Users and Roles

Job Duties	SIOCS Application Role	IDCS or OCI IAM Application Role
Manage Batch System Configuration	ADMINISTRATOR	admin_users
Access SIOCS Job Admin UI	ADMINISTRATOR	admin_users
Manage SIOCS Adhoc Job	ADMINISTRATOR	batch_users

Batch Configuration

To access the System Configuration screen, navigate Main Menu/Admin/Configuration/System Administration.

To view the Batch configuration, filter by Batch topic.

Figure 5–1 Batch System Administration Screen

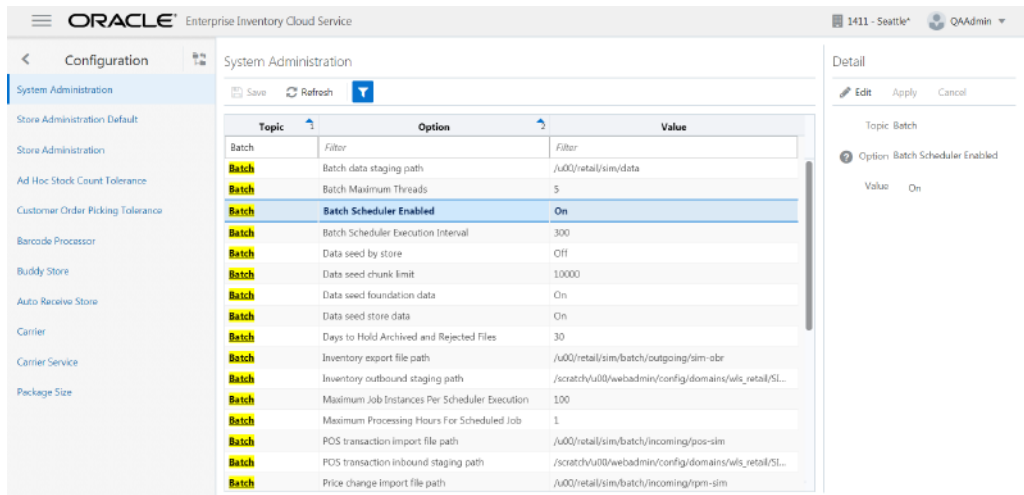

Table 5–2 Batch System Configuration Options

Name	Option	Description	Restricted
archive.dump.interval.days	Archive dump internal days	Interval in days to create dump files for archived purged data.	Yes
archive.max.rows.per.job	Archive maximum rows per batch job	Archive maximum rows per batch job.	Yes
batch.max.file.per.job	Batch max file per job	Batch max files per job run.	No
batch.data.staging.path	Batch data staging path	Base staging directory for the file processing.	Yes
batch.job.max.threads	Batch Maximum Threads	Maximum number of threads to be instantiated for batch execution.	No

Table 5–2 (Cont.) Batch System Configuration Options

Name	Option	Description	Restricted
batch.scheduler.enabled	Batch Scheduler Enabled	Batch Scheduler Enabled	Yes
batch.scheduler.interval.du ration.secs	Batch Scheduler Execution Interval	Batch Scheduler Execution Interval	No
batch.scheduler.max.job.per .run	Maximum Job Instances Per Scheduler Execution	Maximum Job Instances Per Scheduler Execution	No
batch.scheduler.max.proces sing.hours.for.job	Maximum Processing Hours For Schedule Job	Maximum Processing Hours For Schedule Job	No
days.to.hold.archived.reject ed.files	Days to Hold Archived and Rejected Files	Number of days to hold the archived and rejected files after being processed.	No
dataseed.by.store	Data seed by store	Enables/Disables data seeding per store.	Yes
dataseed.chunk.limit	Data seed chunk limit	Chunk limit for records processed in data seeding.	Yes
dataseed.foundation.enable d	Data seed foundation data	Enables/Disables the foundation data seeding.	Yes
dataseed.storedata.enabled	Data seed store data	Enables/Disables the store data seeding.	Yes
file.export.arvdump.path	Archive dump file export path	Archive dump file export path.	Yes
file.export.inventory.path	Inventory export file path	Outgoing directory for inventory extract zip files.	Yes
file.export.stock.count.path	Stock count export file path	Outgoing directory for U/A Stock count extract zip files.	Yes
file.import.initial.inventory. path	Initial inventory import file path	Incoming directory for Initial inventory upload files.	Yes
file.import.pos.transaction. path	POS transaction import file path	Incoming directory for POS transaction zip files.	Yes
file.import.price.change.pat h	Price change import file path	Incoming directory for Price change zip files. This is for on-Premise RPM, will be phased out in future release.	Yes
file.import.resa.path	Retail sale audit import file path	Incoming directory for Sales audit zip files.	Yes
file.import.stock.count.path	Third-party stock import file path	Incoming directory for Third-party stock count zip files.	Yes
file.import.store.sequence.p ath	Store sequence import file path	Incoming directory for store sequencing zip files.	Yes
file.import.warehouse.stock .path	Warehouse item stock import file path	Incoming directory for warehouse inventory import zip files.	Yes

Table 5–2 (Cont.) Batch System Configuration Options

Name	Option	Description	Restricted
file.in.stage.initial.inventory.path	Initial inventory inbound staging path	Staging directory for the Initial inventory import file processing.	Yes
file.in.stage.pos.transaction.path	POS transaction inbound staging path	Staging directory for the POS transaction import file processing.	Yes
file.in.stage.price.change.path	Price Change inbound staging path	Staging directory for the Price change import file processing.	Yes
file.in.stage.resa.path	Retail sale audit inbound staging path	Staging directory for the Sales audit import file processing.	Yes
file.in.stage.stock.count.path	Stock count inbound staging path	Staging directory for the third-party stock count import file processing.	Yes
file.in.stage.store.sequence.path	Store sequence inbound staging path	Staging directory for the Sequencing data import file processing.	Yes
file.in.stage.warehouse.stock.path	Warehouse item stock inbound staging path	Staging directory for the Warehouse inventory import file processing.	Yes
file.out.stage.arvdump.path	Archive dump file outbound staging path	Archive dump file outbound staging path.	Yes
file.out.stage.inventory.path	Inventory outbound staging path	Staging directory for the inventory extract file.	Yes
file.out.stage.stock.count.path	Stock count outbound staging path	Staging directory for the U/A Stock Count export file.	Yes
procedure.logPurgingInfo.enabled	Procedure Log Purging Info Enabled	Procedure Log Purging Info Enabled.	Yes
search.limit.batch.job.days	Search Limit Default for Batch Job Days	Default number of days search limit to load the job activity.	No
sftp.mfcs.dest.path	MFCS SFTP incoming default path	MFCS SFTP incoming default path. For example, /mfcsftpuser.	Yes
sftp.mfcs.file.out.compress	MFCS Compress data files	MFCS Compress data files. if true, compress data files in zip file.	Yes
sftp.mfcs.file.out.push	MFCS SFTP push	MFCS SFTP push. if true, push data files to MFCS sftp default incoming path; if set to false, the files will be moved to EICS's sftp export location.	Yes
sftp.mfcs.host	MFCS SFTP host	MFCS SFTP host	Yes
sftp.mfcs.port	MFCS SFTP port	MFCS SFTP port	Yes
sftp.mfcs.user.name	MFCS SFTP User	MFCS SFTP User name	Yes

Table 5–2 (Cont.) Batch System Configuration Options

Name	Option	Description	Restricted
sftp.obr.dest.path	Order Broker SFTP incoming default path	Order Broker SFTP incoming default path, for example, /obrftpuser.	Yes
sftp.obr.file.out.compress	Order Broker Compress data files	Order Broker Compress data files. If true, compress data files in zip file.	Yes
sftp.obr.file.out.push	Order Broker SFTP push	Order Broker SFTP push. if true, push data files to OBR sftp default incoming path; if set to false, the files will be moved to EICS's sftp export location.	Yes
sftp.obr.host	Order Broker SFTP host	Order Broker SFTP host.	Yes
sftp.obr.port	Order Broker SFTP port	Order Broker SFTP port.	Yes
sftp.obr.user.name	Order Broker SFTP user	Order Broker SFTP user.	
sftp.push.max.files	The max files push to SFTP server per job run	The max files push to SFTP server per job run, default to 100 files.	Yes
sftp.push.timeout	The SFTP push timeout in milliseconds	The SFTP push timeout in milliseconds.	Yes
sftp.shell.log.path	The SFTP push shell script log path	The SFTP push shell script log path.	Yes
sftp.shell.working.path	The SFTP push shell script working path	The SFTP push shell script working path.	Yes
stock.count.import.chunk.limit	Stock Count Import Chunk Limit	Stock Count Import Chunk Limit	Yes

Note: Purge related configurations are listed under purge topic, for complete list of system configuration list, see [Configuration](#) chapter for details. Configuration marked as restricted can only be managed by sys op admin user.

Operational Batches

Operational batches are used to perform background operations on the transaction and includes such tasks as generation of a transaction, closing the transaction after a specified date is passed, auto confirmation of the transaction, and so on.

- [Archive Activity History](#)
- [Archive Dump](#)
- [Archive Item Uin History](#)
- [Archive RFID History](#)
- [Archive Store Item Stock History](#)
- [Archive Ticket History](#)
- [Auto Replenish Capacity](#)
- [Auto Ticket Generate](#)
- [Auto Ticket Print](#)
- [Cleanup Batch Directories](#)
- [Cleanup Shelf Replenishment](#)
- [DSD Receiving Closure](#)
- [Extract Subscription Usage](#)
- [Fulfillment Order Reminders](#)
- [Fulfillment Order Pick Reminders](#)
- [Generate Problem Line Stock Count](#)
- [Generate Unit Amount Stock Count](#)
- [Generate Unit Stock Count](#)
- [Inventory Extract File SFTP Push](#)
- [Item Basket Maintenance](#)
- [Item Price to History](#)
- [Product Group Schedule Clean up](#)
- [Return Not After Date Alert](#)
- [Stock Count Authorize Recovery](#)
- [Stock Count Export](#)
- [Stock Count Export File SFTP Push](#)
- [Stock Count Unit and Amount Snapshots](#)
- [Store Order Auto Approve](#)
- [Store Order Auto Cancel](#)
- [Store Order Auto Generate](#)
- [Transfer Close](#)
- [Transfer Delivery Auto Receive](#)
- [Transfer Delivery Close](#)

- [Transfer Not After Date Alert Batch](#)
- [Transfers Overdue](#)
- [Vendor Return Closure](#)

Archive Activity History

This batch moves aged activity history into archive table.

Batch Job Definition Name

Audits_ArchiveJob

Batch Job Parameters

<input_date>

Where input date parameter is defaulted to current timestamp if not specified. System batch input date format is used for parsing input date if specified.

Key Tables

Table 5–3 Key Tables for Archive Activity History

Table	Select	Insert	Update	Delete
ACTIVITY_HISTORY	Yes			Yes
ARV_ACTIVITY_HIST		Yes		

Archive Dump

This batch generates the Oracle data dump files from archived data purging record tables. After the data dump files are generated, the archived tables are truncated. For Archive Data Dump Files Export, see [Batch - Data Archive](#) chapter.

Batch Job Definition Name

ArchiveDump_OpsJob

Batch Job Parameters

<input_date>

Where input date parameter is defaulted to current timestamp if not specified. System batch input date format is used for parsing input date if specified.

Key Tables

Table 5–4 Key Tables for Archive Dump

Table	Select	Insert	Update	Delete
ARV_ACTIVITY_HIST	Yes			Yes
ARV_ITEM_UIN_HIST	Yes			Yes
ARV_STORE_ITEM_STOCK_HIST	Yes			Yes
ARV_RFID_HIST	Yes			Yes
ARV_EXPORT	Yes	Yes	Yes	

Archive Item Uin History

This batch moves aged activity history into archive table.

Batch Job Definition Name

ItemUinHistory_ArchiveJob

Batch Job Parameters

<input_date>

Where input date parameter is defaulted to current timestamp if not specified. System batch input date format is used for parsing input date if specified.

Key Tables

Table 5–5 Key Tables for Archive Item Uin History

Table	Select	Insert	Update	Delete
ITEM_UIN_HISTORY	Yes			Yes
ARV_ITEM_UIN_HIST		Yes		

Archive RFID History

This batch moves aged RFID history records into archive table.

Batch Job Definition Name

RfidHistory_ArchiveJob

Batch Job Parameters

N/A

Key Tables

Table 5–6 Key Tables for Archive RFID History

Table	Select	Insert	Update	Delete
RFID_HISTORY	Yes			
ARV_RFID_HIST		Yes		

Archive Store Item Stock History

This batch moves aged store item stock history records into archive table.

Batch Job Definition Name

StoreItemStockHistory_ArchiveJob

Batch Job Parameters

<input_date>

Where input date parameter is defaulted to current timestamp if not specified. System batch input date format is used for parsing input date if specified.

Key Tables

Table 5–7 Key Tables for Archive Store Item Stock History

Table	Select	Insert	Update	Delete
STORE_ITEM_STOCK_HISTORY	Yes			Yes
ARV_STORE_ITEM_STOCK_HIST		Yes		

Archive Ticket History

This batch moves aged ticket history records into archive table.

Batch Job Definition Name

TicketHistory_ArchiveJob

Batch Job Parameters

<input_date>

Where input date parameter is defaulted to current timestamp if not specified. System batch input date format is used for parsing input date if specified.

Key Tables

Table 5–8 Key Tables for Archive Ticket History

Table	Select	Insert	Update	Delete
TICKET_HISTORY	Yes			Yes
ARV_TICKET_HIST		Yes		

Auto Replenish Capacity

This job automatically updates the shopfloor to capacity for certain items based on a product group.

Batch Job Definition Name

AutoReplenishCapacity_OpsJob

Batch Job Parameters

<input_date>

input_dateinput date parameter is defaulted to current timestamp if not specified. System batch input date format is used for parsing input date if specified.

<store id>

Where store id is store identifier. If store id is not specified, then data for all managed stores will be processed in parallel processing.

Key Tables

Table 5–9 Key Tables for Auto Replenish Capacity Batch

Table	Select	Insert	Update	Delete
config_system	Yes			

Table 5–9 (Cont.) Key Tables for Auto Replenish Capacity Batch

Table	Select	Insert	Update	Delete
shelf_replenish	Yes	Yes	Yes	Yes
shelf_replenish_line_item	Yes	Yes	Yes	Yes

Restart/Recovery

This batch can be re-run by starting a new batch job after the issues are resolved.

Auto Ticket Generate

This job automatically generates the item tickets and labels depending on the store parameters for events which are subscribes. The events are price changes, clearance event, promotions and item description changes.

Batch Job Definition Name

TicketAutoGenerateFromEvent_OpsJob

Batch Job Parameters

<input_date>

input_date input date parameter is defaulted to current timestamp if not specified. System batch input date format is used for parsing input date if specified.

<store id>

Where store id is store identifier. If store id is not specified, then data for all managed stores will be processed in parallel processing.

Key Tables**Table 5–10 Key Tables for Auto Ticket Generate Batch**

Table	Select	Insert	Update	Delete
config_system	Yes			
ticket_event	Yes	Yes	Yes	
ticket	Yes	Yes	Yes	Yes
ticket_format	Yes			

Restart/Recovery

This batch can be re-run by starting a new batch job after the issues are resolved.

Auto Ticket Print

This batch sends the tickets generated to the 3rd party printing service. The tickets/labels generated for the items identified in the product group will be automatically sent to the 3rd party printing service.

Batch Job Definition Name

TicketAutoPrint_OpsJob

Batch Job Parameters

<input_date>

input_date input date parameter is defaulted to current timestamp if not specified. System batch input date format is used for parsing input date if specified.

<store id>

Where store id is store identifier. If store id is not specified, then data for all managed stores will be processed in parallel processing.

Key Tables

Table 5–11 Key Tables for Auto Ticket Print Batch

Table	Select	Insert	Update	Delete
config_system	Yes			
Store_printer	Yes			
ticket	Yes	Yes	Yes	Yes
ticket_format	Yes			

Restart/Recovery

This batch can be re-run by starting a new batch job after the issues are resolved.

Cleanup Batch Directories

This job deletes the processed files from batch archive folder and failed files from reject folder of the respective job's directory. The retention period is specified by system configuration parameter **Days to Hold Archived and Rejected Files**.

Batch Job Definition Name

CleanupBatchDirectories_OpsJob

Batch Job Parameters

<input_date>

input_date input date parameter is defaulted to current timestamp if not specified. System batch input date format is used for parsing input date if specified.

Key Tables

Table 5–12 Key Tables for Cleanup Batch Directories

Table	Select	Insert	Update	Delete
ACTIVITY_HISTORY	Yes			

Cleanup Shelf Replenishment

The end of day batch process runs at the end of each day to reset the delivery bay and close any open pending shelf replenishments. The system takes the entire inventory from the delivery bay and moves it to the back room. Any pending or in progress shelf replenishment are changed to a cancelled state. Users who are performing a shelf replenishment are kicked out of the system. That is, the batch process takes over the shelf replenishment user's application activity locking. The current user's shelf replenishment process is discarded without being saved. After the batch process is run, all shelf replenishments are either completed or cancelled, and the delivery bay has zero inventory.

Batch Job Definition Name

CleanupShelfReplenishment_OpsJob

Batch Job Parameters

input_date>

input_date input date parameter is defaulted to current timestamp if not specified. System batch input date format is used for parsing input date if specified.

Key Tables**Table 5–13 Key Tables for Cleanup Shelf Replenishment Batch**

Table	Select	Insert	Update	Delete
shelf_replenish			Yes	
stock_item_stock			Yes	

DSD Receiving Closure

This batch program looks for all the open vendor deliveries whose expected date added to store parameter “Auto Close Days after Expected Date” is before today and automatically confirms all the vendor deliveries.

Batch Job Definition Name

DSDReceivingClosure_OpsJob

Batch Job Parameters

<input_date>

Where input date parameter is defaulted to current timestamp if not specified. System batch input date format is used for parsing input date if specified.

Key Tables**Table 5–14 Key Tables for Close DSD Receiving Batch**

Table	Select	Insert	Update	Delete
activity_history		Yes		
config_store	Yes			
dsd	Yes		Yes	
dsd_carton	Yes		Yes	
dsd_line_item	Yes		Yes	
dsd_line_item_att	Yes		Yes	
dsd_line_item_uin	Yes		Yes	
inv_adjust_reason	Yes			
purchase_order	Yes		Yes	
stock_item_v	Yes			
store	Yes			

Extract Subscription Usage

This batch is used to extract subscription usage for EICS and SOCS respectively during the subscription period.

It is a restricted batch which by default is scheduled to run every month. This schedule can only be updated by a sysop user.

The batch inserts a usage record in the SUBSCRIPTION_USAGE table for each month within the subscription period starting from the last extract date+1 (or subscription start date) till the end of last month from the batch run date.

When calculating usage metrics, the from date is the latest date between the subscription start date and the last extract date+1. If there were no previous extractions, the subscription start date is considered.

The subscription start date is obtained from PSRAF view RAF_SUBS_CURRNT_METRIC_QTY_VW.

The batch also inserts a record in the PSRAF table RAF_SUBS_METRIC_USAGE with monthly usage and running usage info for EICS and SOCS respectively.

The monthly usage for a month is defined below:

EICS: The total quantity of items that were sold and returned plus the total quantity of items that were fulfilled as part of web orders.

SOCS: The distinct users that logged into SOCS.

The running usage is as defined below:

EICS: Pooled monthly usage over the subscription period starting from the subscription start date till usageToDate.

SOCS: Average monthly usage during a subscription year within the subscription period where each subscription year is 12 months long.

Batch Job Definition Name

ExtractSubscriptionUsage_OpsJob

Batch Job Parameters

<input_date>

Where input date parameter is defaulted to current timestamp if not specified. System batch input date format is used for parsing input date if specified.

Key Tables

Table 5-15 Key Tables for Extract Subscription Usage

Table	Select	Insert	Update	Delete
subscription_usage	Yes	Yes		
pos_transaction	Yes			
ful_ord	Yes			
ful_ord_line_item	Yes			
activity_history	Yes			

Fulfillment Order Pick Reminders

This batch process sends out alerts for fulfillment order picks for which create date has expired by minutes to hold customer orders before sending alert parameter value and the status is new or in progress.

Batch Job Definition Name

FulfillmentOrderPickReminders_OpsJob

Batch Job Parameters

<input_date>

Where input date parameter is defaulted to current timestamp if not specified. System batch input date format is used for parsing input date if specified.

Key Tables

Table 5–16 Key Tables for Fulfillment Order Pick Reminders Batch

Table	Select	Insert	Update	Delete
ful_ord_pick	Yes			
ful_ord_pick_line_item	Yes			
store_item_stock	Yes			
store	Yes			
comfig_system	Yes			

Fulfillment Order Reminders

This batch process sends out alerts for fulfillment orders for which create date has expired by minutes to hold customer orders before sending alert parameter value.

Batch Job Definition Name

FulfillmentOrderReminders_OpsJob

Batch Job Parameters

<input_date>

Where input date parameter is defaulted to current timestamp if not specified. System batch input date format is used for parsing input date if specified.

<store id>

Where store id is store identifier. If store id is not specified, then data for all managed stores will be processed in parallel processing.

Key Tables

Table 5–17 Key Tables for Fulfillment Order Reminders Batch

Tables	Select	Insert	Update	Delete
config_system	Yes			
config_store	Yes			
store	Yes			

Table 5–17 (Cont.) Key Tables for Fulfillment Order Reminders Batch

Tables	Select	Insert	Update	Delete
store_item_stock	Yes			
ful_ord	Yes			
ful_ord_line_item	Yes			

Generate Problem Line Stock Count

Before the batch process runs, the retailer establishes a group of items and item hierarchies (by associating them to the problem line group type) and selects applicable parameters (negative SOH, negative available, and so on). The problem line batch process goes through the list of items in the group, determining which fall within the parameters. The system automatically creates a stock count from those items that do fall within the parameters.

If an item is a problem line item (negative inventory for example) on a stock count, and the user does not get the chance to perform the stock count on it that day, the next day the item may no longer be a problem line (positive inventory). However, the system continues to create a stock count for that item because a problem existed at one time.

Batch Job Definition Name

GenerateProblemLineStockCount_OpsJob

Batch Job Parameters

<input_date>

Where input date parameter is defaulted to current timestamp if not specified. System batch input date format is used for parsing input date if specified.

<store id>

Where store id is store identifier. If store id is not specified, then data for all managed stores will be processed in parallel processing.

Key Tables

Table 5–18 Key Tables for Problem Line Stock Count Batch

Tables	Select	Insert	Update	Delete
group_schedule_extract	Yes	Yes		
prod_group_item_bkdn			Yes	Yes
stock_count	Yes	Yes	Yes	Yes
stock_count_line_item	Yes	Yes	Yes	Yes
stock_count_line_item_uin	Yes	Yes	Yes	Yes
stock_count_child	Yes	Yes	Yes	Yes
product_group_schedule	Yes		Yes	
product_group	Yes			

Table 5–18 (Cont.) Key Tables for Problem Line Stock Count Batch

Tables	Select	Insert	Update	Delete
product_group_ sched_store	Yes			
item	Yes			
store_item	Yes			
stock_count_line_item	Yes			

Generate Unit Amount Stock Count

This batch program generates Unit Amount stock counts.

Daily, the batch process creates the stock counts that are scheduled for the current day or future date which matches the next scheduled date. The system looks at all the scheduled stock count records and determines whether any are scheduled for today or the user-specified future date. The process creates the stock counts for each individual store. For example, if a scheduled count includes a list of five stores, then five separate stock count records are created.

If an all-location stock count is being run, the batch processing generates individual counts for every macro sequence location.

The date parameter is optional when running the Extract Stock Counts batch. If no date is provided, today's date is used.

Batch Job Definition Name

GenerateUnitAmountStockCount_OpsJob

Batch Job Parameters

<input_date>

Where input date parameter is defaulted to current timestamp if not specified. System batch input date format is used for parsing input date if specified.

<store id>

Where store id is store identifier. If store id is not specified, then data for all managed stores will be processed in parallel processing.

Key Tables

Table 5–19 Key Tables for Generate Unit Amount Stock Count Batch

Table	Select	Insert	Update	Delete
group_schedule_extract		Yes		Yes
product_group	Yes			
product_group_hierarchy	Yes			
product_group_item	Yes			
product_group_sched_store	Yes			
product_group_schedule	Yes		Yes	
product_group_item_bkdn		Yes		Yes
stock_count	Yes	Yes	Yes	
stock_count_child		Yes	Yes	
stock_count_line_item		Yes	Yes	
stock_count_line_item_uin		Yes	Yes	
item	Yes			
store_item	Yes			
store_item_stock	Yes			
item_component	Yes			

Generate Unit Stock Count

This batch program generates Unit stock counts.

Daily, the batch process creates the stock counts that are scheduled for the current day or future date which matches the next scheduled date. The system looks at all the scheduled stock count records and determines whether any are scheduled for today or the user specified future date. The process creates the stock counts for each individual store. For example, if a scheduled count includes a list of five stores, then five separate stock count records are created.

If the system is configured to use unguided stock counts, the batch process does not generate multiple counts even if the item is located at multiple locations within the store.

The date parameter is optional when running the Extract Stock Counts batch. If no date is provided, today's date is used.

Batch Job Definition Name

GenerateUnitStockCount_OpsJob

Batch Job Parameters

<input_date>

Where input date parameter is defaulted to current timestamp if not specified. System batch input date format is used for parsing input date if specified.

<store id>

Where store id is store identifier. If store id is not specified, then data for all managed stores will be processed in parallel processing.

Key Tables

Table 5–20 Key Tables for Generate Unit Stock Count Batch

Table	Select	Insert	Update	Delete
group_schedule_extract		Yes		Yes
product_group	Yes			
product_group_hierarchy	Yes			
product_group_item	Yes			
product_group_sched_store	Yes			
product_group_schedule	Yes		Yes	
product_group_item_bkdn		Yes		Yes
stock_count	Yes	Yes	Yes	Yes
stock_count_child		Yes	Yes	Yes
stock_count_line_item		Yes	Yes	Yes
stock_count_line_item_uin		Yes	Yes	
item	Yes			
store_item	Yes			

Table 5–20 (Cont.) Key Tables for Generate Unit Stock Count Batch

Table	Select	Insert	Update	Delete
store_item_stock	Yes			
item_component	Yes			

Inventory Extract File SFTP Push

This batch scan the inventory extract staging out directories, move the files which have the completer files from EICS app server to Order Broker SFTP Server if system configuration - **OBR SFTP push** is set to true.

Batch Job Definition Name

InventoryExtractSftpPush_OpsJob

Batch Job Parameters

<input_date>

Where input_date is defaulted to current timestamp if not specified. System batch input date format is used for parsing input date if specified.

Key Tables

N/A

Restart/Recovery

This batch can be re-run by starting a new batch job after the issues are resolved.

Item Basket Maintenance

This batch updates the item basket status cancelled when item basket has expired.

Batch Job Definition Name

ItemBasketMaintenance_OpsJob

Batch Job Parameters

<input_date>

Where input_date is defaulted to current timestamp if not specified. It is used for comparing if a record date is a configured number of days prior to the input date. System batch input date format is used for parsing input date if specified.

Key Tables

Table 5–21 Key Tables for Item Basket Maintenance Batch

Table	Select	Insert	Update	Delete
config_system	Yes			
Item_basket	Yes		Yes	

Restart/Recovery

This batch can be re-run by starting a new batch job after the issues are resolved.

Item Price to History

This batch writes the active item price records into item price history table. After the active item prices are recorded in the item price history table, the batch updates the ITEM_PRICE table statuses as completed for these records.

Batch Job Definition Name

ItemPriceToHistory_OpsJob

Batch Job Parameters

<input_date>

Where input date parameter is defaulted to current timestamp if not specified. System batch input date format is used for parsing input date if specified.

<store id>

Where store id is store identifier. If store id is not specified, then data for all managed stores will be processed in parallel processing.

Key Tables**Table 5–22 Key Tables for Item Price to History Batch**

Table	Select	Insert	Update	Delete
item_price	Yes		Yes	Yes
item_price_history		Yes		

Product Group Schedule Clean up

This batch program searches for all open product group schedules that have ended date before today (or user specified date) and change the product group schedule status to closed.

Batch Job Definition Name

ProductGroupScheduleCleanup_OpsJob

Batch Job Parameters

<input_date>

Where input date parameter is defaulted to current timestamp if not specified. System batch input date format is used for parsing input date if specified.

Key Tables**Table 5–23 Key Table for Close Prod Group Schedule Batch**

Table	Select	Insert	Update	Delete
Product_group_schedule	Yes		Yes	

Return Not After Date Alert

This batch process warns users a number of days in advance that the RTV/RTW is about to reach the **Not After** date and must be dispatched. The value for the number of days of advance warning is configurable using the system's administration screens.

Batch Job Definition Name

ReturnNotAfterDateAlert_OpsJob

Batch Job Parameters

<input_date>

Where input date parameter is defaulted to current timestamp if not specified. System batch input date format is used for parsing input date if specified.

Key Tables

Table 5–24 Key Tables for Return Not After Date Alert Batch

Tables	Select	Insert	Update	Delete
rtv	Yes			
rtv_line_item	Yes			
shipment_reason	Yes			
stock_item	Yes			

Stock Count Authorize Recovery

This batch process looks for stock counts that are stuck in Authorize Processing state. This is a unique state that appears when an error occurs during the final processing of a stock count. The batch attempts to fully authorize the stock count. Errors that occur during the batch process are logged to the server error logs and will indicate the reason for any further processing failures. Successfully authorized stock counts will move to authorized completed state.

Batch Job Definition Name

StockCountAuthorizeRecovery_OpsJob

Batch Job Parameters

<input_date>

Where input date parameter is defaulted to current timestamp if not specified. System batch input date format is used for parsing input date if specified.

Key Tables

Table 5–25 Key Tables for Stock Count Authorize Recovery Batch

Tables	Select	Insert	Update	Delete
stock_count	Yes		Yes	
stock_count_child	Yes		Yes	
stock_count_line_item	Yes		Yes	
stock_count_line_item_uin	Yes			
item_uin	Yes		Yes	
store_item	Yes			
store_item_stock			Yes	
product_group_schedule	Yes			
product_group_sched_store	Yes			
store	Yes			
stock_count_sale	Yes			Yes

Table 5–25 (Cont.) Key Tables for Stock Count Authorize Recovery Batch

Tables	Select	Insert	Update	Delete
inv_adjust_reason	Yes			

Stock Count Export

This batch process looks for a stock count that is stuck in approval authorized state during authorizing a unit amount stock count process. This is a unique state that appears when an error occurs during the final processing of a unit amount stock count. The batch attempts to generate stock count export file and set stock count status to authorize complete state. Errors that occur during the batch process are logged to the server error logs and will indicate the reason for any further processing failures. See [Appendix: Unit and Amount Stock Counts Export](#) for details.

Batch Job Definition Name

StockCountExport_OpsJob

Batch Job Parameters

<stock_count_id>

Where the stock_count_id is the stock count identifier

Key Tables

Table 5–26 Key Tables for Stock Count Export Batch

Table	Select	Insert	Update	Delete
stock_count	Yes		Yes	
stock_count_child	Yes		Yes	
stock_count_line_item	Yes		Yes	
stock_count_line_item_uin	Yes			
item_uin	Yes		Yes	
store_item	Yes			
stock_count_export	Yes		Yes	Yes

Stock Count Export File SFTP Push

This batch scan the stock count export staging out directories, move the files which have the completer files from EICS app server to MFCS SFTP Server if system configuration - MFCS SFTP push is set to true.

Batch Job Definition Name

StockCountExportSftpPush_OpsJob

Batch Job Parameters

<input_date>

Where input_date is defaulted to current timestamp if not specified. System batch input date format is used for parsing input date if specified.

Key Tables

N/A

Restart/Recovery

This batch can be re-run by starting a new batch job after the issues are resolved.

Stock Count Unit and Amount Snapshots

This job takes the snapshot of current inventory for Unit and Amount Type of Stock Counts for the items across all stores or for a specific store.

Batch Job Definition Name

StockCountUnitAndAmountSnapshot_OpsJob

Batch Job Parameters

<store id>

Where store id is store identifier. If store id is not specified, then data for all managed stores will be processed in parallel processing.

Key Tables**Table 5–27 Key Tables for Stock Count Unit And Amount Snapshot Batch**

Table	Select	Insert	Update	Delete
stock_count	Yes		Yes	
stock_count_child	Yes		Yes	
stock_count_line_item	Yes		Yes	
Store_item	Yes			
store_item_stock	Yes			

Store Order Auto Approve

This batch processes looks for store orders which requested date is X days of old than the system defined **Days before auto approving Store Orders**, and the process attempts to set those store orders to approved state when applicable.

Batch Job Definition Name

StoreOrderAutoApprove_OpsJob

Batch Job Parameters

N/A

Key Tables**Table 5–28 Key Tables for Store Order Auto Approve Batch**

Table	Select	Insert	Update	Delete
store_order	Yes		Yes	
store_order_line_item	Yes		Yes	

Store Order Auto Cancel

This batch processes looks for store orders which requested date is X days of old than the system defined **Days to hold before Auto Canceling Store Orders**, and the process attempts to set those store orders to cancel state when applicable.

Batch Job Definition Name

StoreOrderAutoCancel_OpsJob

Batch Job Parameters

N/A

Key Tables

Table 5–29 Key Tables for Store Order Auto Cancel Batch

Table	Select	Insert	Update	Delete
store_order	Yes		Yes	
store_order_line_item	Yes		Yes	

Store Order Auto Generate

This batch processes generate store order records for store order product group schedules.

Batch Job Definition Name

StoreOrderAutoGenerate_OpsJob

Batch Job Parameters

N/A

Key Tables

Table 5–30 Key Tables for Store Order Auto Generate Batch

Table	Select	Insert	Update	Delete
store_order	Yes	Yes	Yes	
store_order_line_item	Yes	Yes	Yes	
group_schedule_extract		Yes		Yes
product_group	Yes			
product_group_hierarchy	Yes			
product_group_item	Yes			
product_group_sched_store	Yes			
product_group_schedule	Yes		Yes	

Transfer Close

This batch program looks for all the open transfers which have past their not after date and are in valid state for closure.

Batch Job Definition Name

TransferClose_OpsJob

Batch Job Parameters

<input_date>

Where input date parameter is defaulted to current timestamp if not specified. System batch input date format is used for parsing input date if specified.

Key Tables

Table 5–31 Key Tables for Close Transfers Batch

Table	Select	Insert	Update	Delete
activity_history		Yes		
config_store	Yes			
mps_staged_message		Yes		
store	Yes			
store_item_stock	Yes		Yes	
tsf	Yes		Yes	
tsf_line_item	Yes		Yes	
tsf_ship	Yes			
tsf_ship_carton	Yes			
tsf_ship_line_item	Yes			

Transfer Delivery Auto Receive

Transfer Delivery Auto Receive batch does the following:

- Retrieves a list of all stores.
- Retrieves the auto receive configuration option for the location types (Store, Warehouse, and Finisher).
- For each store, if the Auto Receive store parameter is set to Date Driven, then the batch auto-receives all deliveries that are in New and In Progress status and whose Ship Date added to the Auto Receive Number of Days is less than the current date.

Batch Job Definition Name

TransferDeliveryAutoReceive_OpsJob

Batch Job Parameters

<input_date>

Where input date parameter is defaulted to current timestamp if not specified. System batch input date format is used for parsing input date if specified.

Key Tables

Table 5–32 Key Tables for Auto Receive Transfer Deliveries

Table	Select	Insert	Update	Delete
activity_history		Yes		
config_store	Yes			
inv_adjust_reason	Yes			
item_uin	Yes		Yes	Yes
store_item_stock	Yes		Yes	
store_item_stock_history		Yes		
store_sequence_area	Yes			
store_sequence_item	Yes			
tsf	Yes		Yes	
tsf_allocation	Yes		Yes	
tsf_delv	Yes			
tsf_delv_carton	Yes		Yes	Yes
tsf_delv_line_item	Yes		Yes	
store	Yes			

Transfer Delivery Close

This batch program looks for all the open transfer deliveries and auto confirms all the transfer deliveries based on the store parameter "Auto Close Receipt".

When the parameter value is "0", close the deliveries at the end of day today and when value is "x" close the deliveries at the end of "x" days starting from today.

Batch Job Definition Name

TransferDeliveryClose_OpsJob

Batch Job Parameters

<input_date>

Where input date parameter is defaulted to current timestamp if not specified. System batch input date format is used for parsing input date if specified.

Key Tables

Table 5–33 Key Tables for Close Transfer Deliveries Batch

Table	Select	Insert	Update	Delete
activity_history		Yes		
config_store	Yes			
inv_adjust_reason	Yes			
item_uin	Yes		Yes	Yes
store_item_stock	Yes		Yes	
store_item_stock_history		Yes		
store_sequence_area	Yes			
store_sequence_item	Yes			
tsf	Yes		Yes	
tsf_allocation	Yes		Yes	
tsf_delv	Yes			
tsf_delv_carton	Yes		Yes	Yes
tsf_delv_line_item	Yes		Yes	
store	Yes			

Transfer Not After Date Alert Batch

This batch process generates alerts for any pending transfer requests with not after date coming up within number of days specified in the system parameter "Days to Send Email Alert Before Not After Date for Transfer Requests".

Batch Job Definition Name

TransferNotAfterDateAlert_OpsJob

Batch Job Parameters

<input_date>

Where input date parameter is defaulted to current timestamp if not specified. System batch input date format is used for parsing input date if specified.

Key Tables

Table 5–34 Key Tables for Transfers Not After Date Alert Batch

Tables	Select	Insert	Update	Delete
tsf	Yes			
tsf_line_item	Yes			
store	Yes			

Transfers Overdue

This batch process sends user alert for dispatched transfers which have not been received after a number of days. The value for the number of days of alert is configurable using the system's administration screen.

Batch Job Definition Name

TransfersOverdueBatch_OpsJob

Batch Job Parameters

<input_date>

Where input date parameter is defaulted to current timestamp if not specified. System batch input date format is used for parsing input date if specified.

Key Tables

Table 5–35 Key Tables for Transfers Overdue Batch

Tables	Select	Insert	Update	Delete
tsf_delv	Yes			
tsf_delv_carton	Yes			

Vendor Return Closure

This batch program looks for all the open vendor returns which are in valid state (Closed /Rejected) for closure.

Batch Job Definition Name

VendorReturnClosure_OpsJob

Batch Job Parameters

<input_date>

Where input date parameter is defaulted to current timestamp if not specified. System batch input date format is used for parsing input date if specified.

Key Tables

Table 5–36 Key Tables for Close Vendor Return

Table	Select	Insert	Update	Delete
rtv	Yes	Yes	Yes	
rtv_line_item	Yes	Yes	Yes	Yes
rtv_line_item_uin				Yes
store_item_stock	Yes		Yes	
shipment_reason	Yes			

BDI-Based Batches

BDI (Bulk Data Integration) is the Oracle Retail Integration tool for bulk data movement. The BDI infrastructure applications move data from one application to another. So, there is data producing applications and data consuming applications. See [BDI-Based Batch Integration](#) in [Integration](#) chapter for BDI Integration Process details.

This section describes the importer details.

- [Clearance Transaction Import](#)
- [Price Change Transaction Import](#)
- [Rfid Transaction Import](#)
- [Third Party Pricing Import](#)
- [Warehouse Avail Inventory Import](#)

Clearance Transaction Import

This batch imports the clearance price changes from BDI Inbound Interface tables into EICS application tables. This importer job is an integral part of the Clearance Price BDI Process Flow.

Batch Job Definition Name

Clearance_Tx_ImporterJob

Batch Job Parameters

<dataSetId>

Key Tables

Table 5–37 Key Tables for Clearance Transaction Import

Table
CLEARANCE_IN
ITEM_PRICE

Price Change Transaction Import

This batch imports the regular price changes from BDI Inbound Interface tables into EICS application tables. This importer job is an integral part of the Price Change TX BDI Process Flow.

Batch Job Definition Name

PriceChange_Tx_ImporterJob

Batch Job Parameters

<dataSetId>

If dataSetId is not specified, then each batch job run will find the last 5 datasets within last 7 days and process the datasets in parallel threads via Batch partitioning.

Key Tables

Table 5–38 Key Tables for Price Change Transaction Import

Table
PRICE_CHANGE_IN
ITEM_PRICE

Rfid Transaction Import

This batch imports the external RFID from BDI Inbound Interface tables into EICS application tables.

This importer job is an integral part of the BDI process.

Batch Job Definition Name

ExtRfid_Tx_ImporterJob

Batch Job Parameters

<dataSetId>

If dataSetId is not specified, then each batch job run will find the last 5 datasets within last 7 days and process the datasets in parallel threads via Batch partitioning.

Key Tables

Table 5–39 Key Tables for Rfid Transaction Import

Table
EXT_RFID_IN
RFID

Third Party Pricing Import

This batch imports the external item pricing from BDI Inbound Interface tables into EICS application tables. This importer job is an integral part of the BDI process.

Batch Job Definition Name

ExtPrice_Tx_ImporterJob

Batch Job Parameters

<dataSetId>

If dataSetId is not specified, then each batch job run will find the last 5 datasets within last 7 days and process the datasets in parallel threads via Batch partitioning.

Key Tables**Table 5–40 Key Tables for Third Party Pricing Import****Table**

EXT_PRICE_IN

ITEM_PRICE

Note: Special Notes to Pricing Imports:

By default, EICS integrate with RPCS clearance and regular price change via BDI process flow.

EICS does not integrate with Promotion Offer interface due to it does not provide pricing at item/date level, so there is nothing for SIOCS to consume.

Third Party Pricing Import provides an alternative for import promotion data into EICS.

See [Appendix: Third Party Pricing Integration](#) for additional details.

Warehouse Avail Inventory Import

This batch imports the warehouse available inventory from BDI Inbound Interface tables into EICS application tables. This importer job is an integral part of the BDI process.

Batch Job Definition Name

InvAvailWh_Tx_ImporterJob

Batch Job Parameters

<dataSetId>

If dataSetId is not specified, then each batch job run will find the last 5 datasets within last 7 days and process the datasets in parallel threads via Batch partitioning.

Key Tables**Table 5–41 Key Tables for Warehouse Avail Inventory Import****Table**

INV_AVAIL_WH_IN

WAREHOUSE_ITEM

SFTP File-Based Batches

EICS SFTP-Based File batches are file integration via SFTP.

The following topics are covered:

- [Clearance Price Change Import \(with On-premise RPM\)](#)
- [High Level Batch File Process Overview](#)
- [Initial Inventory Import](#)
- [Inventory Extract](#)
- [Pos Transaction Import](#)
- [Promotion Price Change Import \(with On-premise RPM\)](#)
- [Regular Price Change Import \(with On-premise RPM\)](#)
- [Retail Sale Audit Import](#)
- [SFTP Nightly Batch File Uploads](#)
- [Store Sequence Import](#)
- [Third Party Stock Count Import](#)
- [Warehouse Item Stock Import](#)

Clearance Price Change Import (with On-premise RPM)

See [Appendix: Pricing Import with On-premise RPM](#).

Note: Pricing file import with On-premise RPM will be phased out in future release.

See Clearance Transaction Import for clearance pricing integration with RPCS.

High Level Batch File Process Overview

- The file import job processes each file from incoming directory when a corresponding completer file presents. The completer is a zero-byte file which indicates file transfer is complete and ready for processing.
- The batch file process also handles the movement of input, output and reject files to the respective directories.
- Output files and reject files will be pushed to outgoing for client review and usage.
- Incoming files can be placed on SFTP as single file or zipped by each file type.
- Outgoing files will be zipped by file type and pushed to outgoing location.

Initial Inventory Import

Most Oracle Retail customers implement Retail Merchandising Foundation Cloud Service (RMFCS) followed by SIOCS. In some instances, SIOCS is implemented prior to RMFCS. In those cases, there is a need for importing initial inventory data for a store or group of stores from legacy or non-Oracle/third-party systems during the implementation phase.

This enhancement addresses a specific use case of initial inventory upload when stores are brought live on SIOCS by seeding initial inventory without any validations.

This batch is meant to be used **ONLY** during implementation. It is designed for optimal upload to rewrite SOH. This batch will not perform any validations. It should not be used after the one-time inventory upload.

Note: UINs must be uploaded only once. Unlike stock on hand, UINs are state driven and control the stock on hand. Only new UINs in the flat file will be considered for stock on hand update. As such, if UINs already exist, they will not reflect into the new SOH.

The Initial Inventory Import batch is used to wipe out the existing SOH data for items in a store and override it with the new SOH data from the third-party/non-Oracle/legacy systems.

The data gets imported via a flat file.

File Specification

File Name format: EXTSTK_<date in YYYYMMDDHH24MISS format>.dat

File Layout: See [Initial Inventory Import File Layout Specification](#).

Batch Job Definition Name

InitialInventoryImport_OpsJob

Batch Job Parameters

<File name>

If not specified, then the data file in incoming directory are processed.

File Error Handling

The batch job will be marked as failed if file staging fails. The staging process is all or none, so if an error occurs during the batch import process, none of the transactions in the file will be staged. The user will need to rerun the batch using the same file after resolving the errors.

For all invalid records in the file such as Unit UOM items with decimal quantity, items that are not ranged to the store, item records with negative quantity, an error record will be inserted in the BATCH_DATA_ERROR table for each invalid record.

Key Tables

Table 5–42 Key Tables for Initial Inventory Import Batch

Tables	Select	Insert	Update	Delete
store_item_stock	Yes		Yes	
item_uin	Yes	Yes	Yes	

Inventory Extract

This batch extracts the inventory to a file that has been altered on or after the specified date for the specified store.

File Specification

File Name format: PRODUCT_LOCATION_INV_<store id>_<date in YYYYMMDDHH24MISS format>.txt

Where the store id is unique store identifier.

File Layout: See [Inventory Extract Export File Specification](#).

Batch Job Definition Name

InventoryExtract_OpsJob

Batch Job Parameters

<input_date>

Where input date parameter is defaulted to current timestamp if not specified. System batch input date format is used for parsing input date if specified.

<storeId>: If provided, only specified store will be processed. When store id is not specified, the batch will generate exports for all EICS managed stores.

Key Tables

Table 5–43 Key Tables for Inventory Extract Batch

Table	Select	Insert	Update	Delete
item	Yes			
store_item	Yes			
store_item_stock	Yes			

Pos Transaction Import

This batch imports pos transaction records from the flat file (SIMT-LOG file) that came from POS database staging table where polling timer framework will pick those staged requests and update the stock tables.

The batch process takes the sales/order transaction data and stage them to the database staging table from where they are picked up by the polling timer framework to update the store item's inventory buckets (for example, store item's total quantity, shop floor quantity), if applicable.

The file will contain both sale and order transactions. The batch will assign separate request IDs to sales and order transactions.

For sale transactions, a single request ID cannot contain more than MAX_VALUE = 500 transaction line items with an exception that a single transaction ID cannot span across multiple request IDs.

For order transactions, a single request ID cannot contain more than MAX_VALUE = 500 transaction line items with an exception that a single customer order ID cannot span across multiple request IDs.

The file contains transactions for a single store.

Each job run will pick number of files (defined by **Maximum Job Instances Per Batch**) in system configuration and process them in multi-threads. The number of files to be processed is default to 20, the value can be configured via system configuration screen.

Customer can set the job scheduler to be run multiple times per day by changing the schedule intervals.

File Specification

File Name format: SIMTLOG _<date in YYYYMMDDHH24MISS format>_<loc id>.dat

where loc id is the store identifier.

Note: The integration incoming files from file provider which are in old release which are not using the .zip and completer indicator file. EICS is backward compatible with the incoming files which are not in zip and without completer indicator file.

File Layout: See [POS Sale Transaction Import File Specification](#).

Batch Job Definition Name

PosTransactionImport_OpsJob

Batch Job Parameters

<File name>

If not specified, then the data file in incoming directory are processed.

File Error Handling

The batch job will be marked as failed if the file staging fails. The staging process is all or none transaction so if an error occurs during the batch process, none of the transactions in the file will be staged. The user will need to rerun the same file again after resolving any errors.

Key Tables

Table 5–44 Key Tables for Pos Transaction Import Batch

Table	Select	Insert	Update	Delete
pos_transaction	Yes	Yes		
item	Yes			
inv_adjust_reason	Yes			

Promotion Price Change Import (with On-premise RPM)

See [Appendix: Pricing Import with On-premise RPM](#).

Note: Pricing file import with On-premise RPM will be phased out in future release.

See [Appendix: Third Party Pricing Integration](#) batch for promotional price import as alternative.

Regular Price Change Import (with On-premise RPM)

See [Appendix: Pricing Import with On-premise RPM](#).

Note: Pricing file import with On-premise RPM will be phased out in future release.

See Price Change Transaction Import for price integration with RPCS.

Retail Sale Audit Import

This batch program imports sales/order transaction data (ReSA File) that originated in Oracle Retail Xstore Point of Service. The external audit system will provide in its sales upload file a percentage or quantity that indicates how much the inventory needs to be reduced by, in addition to the sold quantity.

For example, meat will become lighter as fluids evaporate. Other items, for example cheese or ham, will only be reduced when of the outside layers are cut off to sell the item.

The batch process takes the sales transaction data to update the store item's inventory buckets. From the batch program, SIOCS learns about inventory movement (that is, what is sold, what is returned, what is reserved and what is fulfilled). Once SIOCS attains the data, SIOCS assumes that sales should be taken from the store's shelf-related inventory buckets. This assumption is important to SIOCS's shelf replenishment processing. SIOCS assumes that returns should go to the backroom bucket; the system's logic is that returns must be inspected.

The batch takes the sales/order transaction data and stage them to the SIOCS database staging table from where they are picked up by the polling timer framework to update the store item's inventory buckets (for example, store item's total quantity, shop floor quantity), if applicable.

The file will contain both sales and order transactions. The batch job combines the transaction number and register number to form the transaction ID in SIOCS. Request IDs are assigned to the transactions in such a way that a single request ID will not contain more than MAX_SIZE=500 records with an exception that a single transaction ID should not span across multiple request IDs.

During processing staging records, batch also writes each failure record into a transaction log table.

Each job run will pick number of files (defined by Maximum Job Instances Per Batch) in system configuration and process them in multi-threads. The number of files to be processed is default to 20, the value can be configured via system configuration screen.

Customer can set the job scheduler to be run multiple times per day by changing the schedule intervals.

File Specification

File Name format: SIMT_<date in YYYYMMDDHH24MISS format>_<loc id>

Where <loc id> is store id.

File Layout: See [Retail Sale Audit Import File Specification](#) Specification.

Batch Job Definition Name

RetailSalesAuditImport_OpsJob

Batch Job Parameters

<File name>

If not specified, then the data file in incoming directory are processed.

File Error Handling

The batch job will be marked as failed if the file staging fails. The staging process is all or none transaction so if an error occurs during the batch process, none of the transactions in the file will be staged. The user will need to rerun the same file again after resolving any errors.

Key Tables**Table 5–45 Key Tables for Retail Sale Audit Import Batch**

Table	Select	Insert	Update	Delete
pos_transaction		Yes		
inv_adjust_reason	Yes			

SFTP Nightly Batch File Uploads

The following is the SFTP file upload process. The Private/Public Keys must be generated, and the public Key must be associated with your SFTP Account for the file uploads. The [Adding Authorized Keys](#) section describes the step-by-step method to generate the Keys (2048-bit RSA Keys).

- [Adding Authorized Keys](#)
- [Login to WinSCP](#)
- [Uploading a Batch File](#)
- [Export File Downloads](#)

Adding Authorized Keys

Use this process to generate a 2048-bit RSA key and add the same to the SFTP server. With Windows, use the WinSCP tool or with Linux, use ssh-keygen.

1. Launch WinSCP and select Tools/Run PuttyGen.
2. Select SSH-2 RSA for the type of key to generate and enter 2048 for the number of bits in a generated key field and click **Generate**.

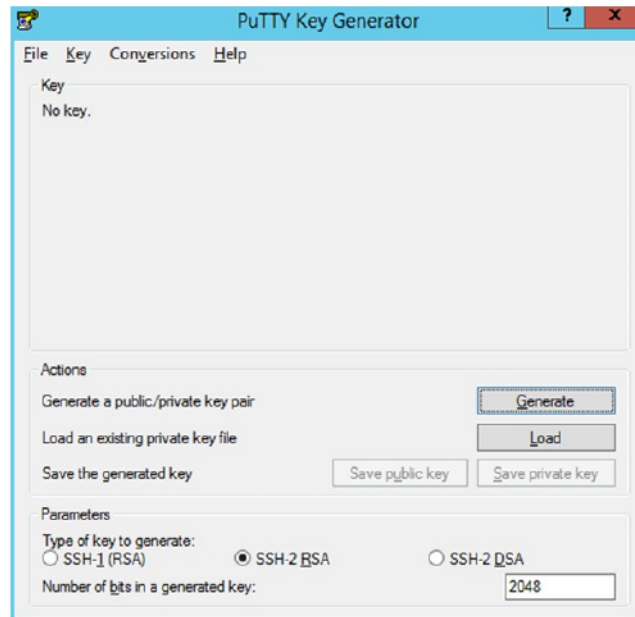
Figure 5–2 Key Generator

3. Move the mouse over the blank space in the window until the key is generated.

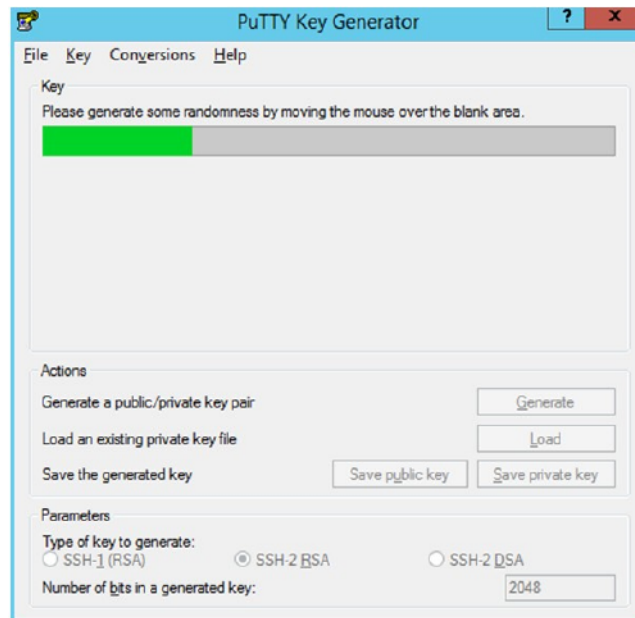
Figure 5–3 Key Generator Progress

4. Once the key is generated, click **Save public key** to save the public key to a file.
5. Click **Save private key** to save the Private key to a file. Confirm to save it with or without a passphrase.
6. Open an SR with Oracle Support, to associate the Public half of the Key with your SFTP account (attach the Key with the SR).

Login to WinSCP

These upload steps use the private key generated in section, [Adding Authorized Keys](#).

1. Launch WinSCP and connect to <SFTP Server> using port 22.
2. Enter the username and then click **Advanced**.
3. Click **Authentication**.
4. In the Private Key File field, click **Browse** and select the private key created in the section, [Adding Authorized Keys](#).

Figure 5–4 Advanced Site Settings

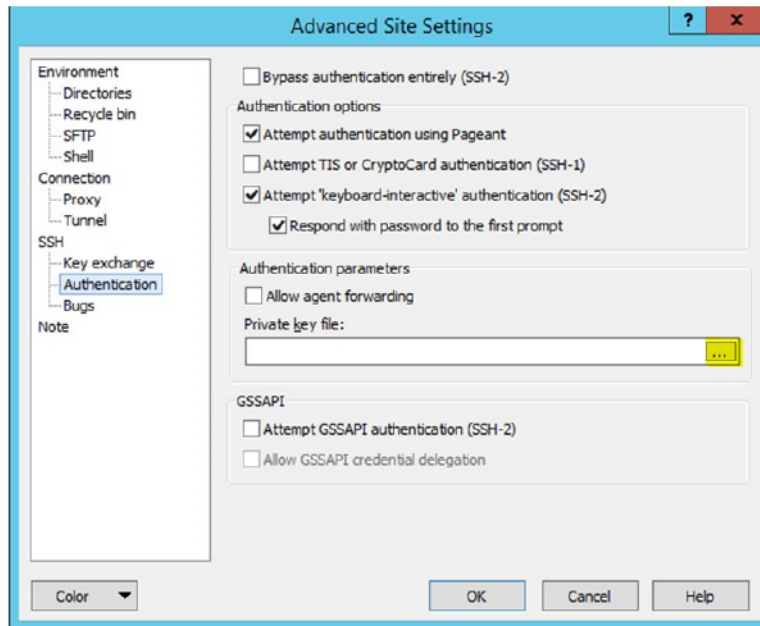

5. After loading the private key file, click **OK**.

Figure 5–5 Private Key File Loaded

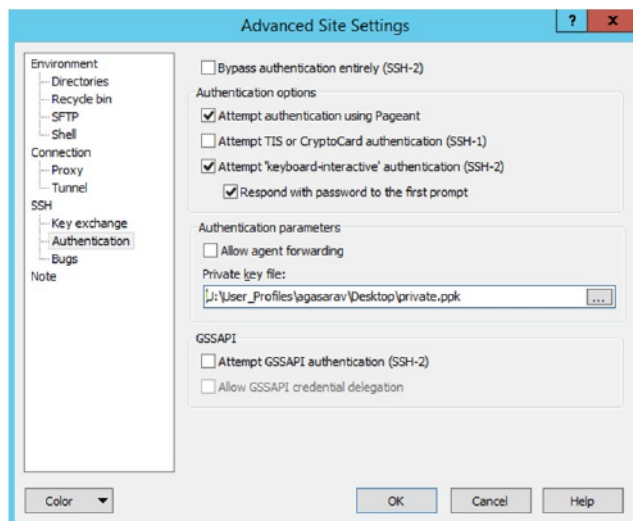

- Click **Login**. The window does not prompt for a password and logs into the SFTP server. Provide a passphrase if one has been set up.

Note: Login can only be performed using the authorized keys. Login with username / password is not supported.

Uploading a Batch File

Login to the WinSCP by following the steps in [Login to WinSCP](#).

- Transfer the file to be copied (for example, test) to /<SFTP User>.

Figure 5–6 <SFTP User> Directory

Name	Type	Changed	Name	Changed
..	Parent directory	2/9/2017 4:36:54 PM	..	2/8/2017 2:49:59 PM
test.complete	COMPLETE File	11/28/2016 9:43:43 PM	COMMAND	2/9/2017 4:36:48 PM
test	File	11/28/2016 9:43:43 PM	COMPLETE	11/28/2016 9:43:43 PM

- Transfer an empty file <filename>.complete (for example, test.complete) to the directory /<SFTP User>.

Figure 5–7 Transferring Empty File

Name	Type	Changed	Name	Changed
..	Parent directory	2/9/2017	..	2/8/2017 2:49:59 PM
test.complete	COMPLETE File	11/28/2016 9:43:43 PM	COMMAND	2/9/2017 4:36:48 PM
test	File	11/28/2016 9:43:43 PM	COMPLETE	11/28/2016 9:43:43 PM
			test	11/28/2016 9:43:43 PM
			test.complete	11/28/2016 9:43:43 PM

- If multiple files have to be transferred, copy all the files to /<SFTP_user>.

Figure 5–8 Transferring Multiple Files

Name	Type	Changed	Name	Changed
..	Parent directory	2/9/2017	..	2/8/2017 2:49:59 PM
test	File	11/28/2016 9:43:43 PM	COMMAND	2/9/2017 4:36:48 PM
test1	File	11/28/2016 9:43:43 PM	COMPLETE	11/28/2016 9:43:43 PM
test2	File	11/28/2016 9:43:43 PM	test	11/28/2016 9:43:43 PM
			test1	11/28/2016 9:43:43 PM
			test2	11/28/2016 9:43:43 PM

- Transfer all the corresponding <filename>.complete files to the /<SFTP_user> directory for the transfer to complete.

Figure 5–9 Transferring .complete Files

Name	Type	Changed	Name	Changed
..	Parent directory	2/9/2017	..	2/8/2017 2:49:59 PM
test.complete	COMPLETE File	11/28/20	COMMAND	2/9/2017 4:36:48 PM
test1.complete	COMPLETE File	11/28/20	COMPLETE	11/28/2016 9:43:43 PM
test2.complete	COMPLETE File	11/28/20	test	11/28/2016 9:43:43 PM
			test.complete	11/28/2016 9:43:43 PM
			test1	11/28/2016 9:43:43 PM
			test1.complete	11/28/2016 9:43:43 PM
			test2	11/28/2016 9:43:43 PM
			test2.complete	11/28/2016 9:43:43 PM

Export File Downloads

The following steps show the download file process.

1. Login to the WinSCP by following the steps in [Login to WinSCP](#).
2. Change the directory to /<SFTP User>/EXPORT.
3. Download all data files.

Store Sequence Import

This batch imports store sequencing information from a flat file. Before importing, the batch will delete the existing sequencing information including sequence items and sequence areas excluding no-location store area which is the default store sequence area.

Each job run will pick number of files (defined by **Maximum Job Instances Per Batch**) in system configuration and process them in multi-threads. The number of files to be processed is default to 20, the value can be configured via system configuration screen.

Customer can set the job scheduler to be run multiple times per day by changing the schedule intervals.

File Specification

File Name format: SSEQ_<date in YYYYMMDDHH24MISS format>_<loc id>

Where <loc id> is store id.

File Layout: See [Store Sequence Data Parser Import File Layout Specification](#).

Batch Job Definition Name

StoreSequenceImport_OpsJob

Batch Job Parameters

<File name>

If not specified, then the data file in incoming directory are processed.

File Error Handling

The file loading process is all or none transaction so if an error occurs during the batch process, none of the transactions in the file will be committed. The user will need to rerun the same file again after resolving any errors.

Key Tables

Table 5–46 Key Tables for Store Sequence Import Batch

Tables	Select	Insert	Update	Delete
store_sequence_area		Yes		Yes
store_sequence_item		Yes		Yes

Third Party Stock Count Import

This batch imports the stock count quantities which are setup in SIOCS and physical counting is conducted by a third-party. The batch updates the store stock on hand quantities; invalid records are saved in the rejected item table.

When the stock count is set up as auto-authorize **Unit and Amount Stock Count**, a **Unit and Amount Stock Counts Export** file is generated as a result of stock count auto authorization. See [Appendix: Unit and Amount Stock Counts Export](#) for details.

Each job run will pick number of files (defined by **Maximum Job Instances Per Batch**) in system configuration and process them in multi-threads. The number of files to be processed is default to 20, the value can be configured via system configuration screen.

Customer can set the job scheduler to be run multiple times per day by changing the schedule intervals.

File Specification

File Name format: STK_<date in YYYYMMDDHH24MISS format>.dat

File Layout: See [Third Party Stock Count Parser Import File Layout Specification](#).

Batch Job Definition Name

ThirdPartyStockCountImport_OpsJob

Batch Job Parameters

<File name>

If not specified, then the data file in incoming directory are processed.

File Error Handling

The batch job will be marked as failed if the file staging fails. The staging process is all or none transaction so if an error occurs during the batch process, none of the transactions in the file will be staged. The user will need to rerun the same file again after resolving any errors.

Key Tables

Table 5–47 Key Tables for Third Party Stock Count Import Batch

Tables	Select	Insert	Update	Delete
stock_count_import	Yes		Yes	
stock_count_rejected_item		Yes		
stock_count	Yes		Yes	
stock_count_child	Yes		Yes	
stock_count_line_item	Yes		Yes	

Table 5–47 (Cont.) Key Tables for Third Party Stock Count Import Batch

Tables	Select	Insert	Update	Delete
item_price	Yes			
item	Yes			
store_item	Yes			
item_uin	Yes			
stock_count_line_ item_uin	Yes			

Warehouse Item Stock Import

This batch imports the inventory of an items in a warehouse from flat files into warehouse item table. The batch updates the warehouse item total quantity.

Each job run will pick number of files (defined by **Maximum Job Instances Per Batch**) in system configuration and process them in multi-threads. The number of files to be processed is default to 20, the value can be configured via system configuration screen.

Customer can set the job scheduler to be run multiple times per day by changing the schedule intervals.

File Specification

File Name format: WHIMS_<date in YYYYMMDDHH24MISS format>.dat

File Layout: See [Warehouse Stock Import File Layout Specification](#).

Batch Job Definition Name

WarehouseItemStockImport_OpsJob

Batch Job Parameters

<File name>

If not specified, then the data file in incoming directory are processed.

File Error Handling

The import process is all or none transactions so if an error occurs during the batch process, the batch job will be marked as failed. The user will need to rerun the same file again after resolving any errors.

Key Tables

Table 5–48 Key Tables for Warehouse Item Stock Import Batch

Tables	Select	Insert	Update	Delete
warehouse_item		Yes		Yes

Purge Batches

- [Purge Adhoc Stock Count](#)
- [Purge Areas](#)
- [Purge Batch Log](#)

- Purge Closed Transfers
- Purge Completed UINs
- Purge DSD and Purchase Orders
- Purge Customer Orders
- Purge Invalid Users
- Purge Invalid User Roles
- Purge Inventory Adjustments
- Purge Item
- Purge Item Baskets
- Purge Item Hierarchy
- Purge Item Price
- Purge Lockings
- Purge Notifications
- Purge Price Change Worksheet
- Purge Price Histories
- Purge Related Items
- Purge Resolved UIN Problems
- Purge RFID
- Purge Sales Posting
- Purge Shelf Adjustments
- Purge Shelf Adjustments
- Purge Staged Message
- Purge Stock Counts
- Purge Temporary UINs
- Purge Ticket Histories
- Purge Vendor Returns

Purge Adhoc Stock Count

PurgeAdHocStockCount batch does the following:

- Deletes ad hoc stock counts with a status of in progress.
- Any ad hoc stock count with a creation date/time stamp older than the **Days to Hold In Progress Ad Hoc Counts** parameter value will be deleted. For example, the default value is 1. If the batch program is run with the default value, the batch program would delete all in-progress counts more than 24 hours old.

This batch program deletes ad hoc stock counts with a status of in progress. Any ad hoc stock count with a creation date/time stamp older than the **Days to Hold In Progress Ad Hoc Counts** parameter value will be deleted. For example, the default value is 1. If the batch program is run with the default value, the batch program would delete all in-progress counts more than 24 hours old.

Batch Job Definition Name

AdhocStockCount_PurgeJob

Batch Job Parameters

<input_date>

Where input_date is defaulted to current timestamp if not specified. It is used for comparing if a record date is a configured number of days prior to the input date. System batch input date format is used for parsing input date if specified.

Key Tables**Table 5–49 Key Tables for Purge AdHoc Stock Count Batch**

Tables	Select	Insert	Update	Delete
config_system	Yes			
stock_count	Yes			Yes
stock_count_rejected_item	Yes			Yes
stock_count_child	Yes			Yes
stock_count_line_item	Yes			Yes
stock_count_line_item_uin	Yes			Yes
stock_count_line_item_att	Yes			Yes

Restart/Recovery

This batch can be re-run from by starting a new batch job after the issues are resolved.

Purge Areas

Purges product basket records (with status of cancelled) based on the retention period. The retention period is specified by system configuration parameter- **Days to Hold Area**.

Batch Job Definition Name

ProductBasket_PurgeJob

Batch Job Parameters

<input_date>

Where input_date is defaulted to current timestamp if not specified. It is used for comparing if a record date is a configured number of days prior to the input date. System batch input date format is used for parsing input date if specified.

Key Tables**Table 5–50 Key Tables for Purge Area Batch**

Tables	Select	Insert	Update	Delete
config_system	Yes			
product_basket_store	Yes			Yes

Table 5–50 (Cont.) Key Tables for Purge Area Batch

Tables	Select	Insert	Update	Delete
product_basket	Yes			Yes

Restart/Recovery

This batch can be re-run by starting a new batch job after the issues are resolved.

Purge Batch Log

Purge Batch Log batch does the following:

- Deletes old batch log records.
- Batch log record with an end date/timestamp older than the **Days To Hold Batch Logs** system configuration value and with the Status value of 2 (COMPLETED) is deleted. For example, if the default value is 30 and the batch program is run with the default value, the batch program would delete all the records that are more than 30 days old and are in completed status.
- Delete purge error logs.

Batch Job Definition Name

BatchLog_PurgeJob

Batch Job Parameters

<input_date>

Where input_date is defaulted to current timestamp if not specified. It is used for comparing if a record date is a configured number of days prior to the input date. System batch input date format is used for parsing input date if specified.

Key Tables**Table 5–51 Key Tables for Purge Batch Log Batch**

Tables	Select	Insert	Update	Delete
config_system	Yes			
batch_data_error	Yes			Yes
batch_execution	Yes			Yes
purge_error_log	Yes			Yes
purge_error_log	Yes			Yes

Restart/Recovery

This batch can be re-run by starting a new batch job after the issues are resolved.

Purge Closed Transfers

Purge Closed Transfers batch does the following:

- Deletes all the closed transfer which are in either cancelled or completed status and shipments related to them.
- Any closed transfer with an update date older than the **Days to Hold Transfer Documents** parameter value will be deleted.

- For example, the default value is 30. If the batch program is run with the default value, the batch program would delete all closed transfers, transfer requests and related shipments which are closed and was last updated 30 days ago.

Batch Job Definition Name

ClosedTransfers_PurgeJob

Batch Job Parameters

<input_date>

Where input_date is defaulted to current timestamp if not specified. It is used for comparing if a record date is a configured number of days prior to the input date. System batch input date format is used for parsing input date if specified.

Key Tables

Table 5–52 Key Tables for Purge Closed Transfers Batch

Tables	Select	Insert	Update	Delete
config_system	Yes			
tsf	Yes			Yes
tsf_line_item				Yes
tsf_ship	Yes			Yes
tsf_ship_carton				Yes
tsf_ship_line_item	Yes			Yes
tsf_ship_line_item_uin				Yes
tsf_ship_line_item_att				Yes
shipment_bol				Yes
tsf_delv	Yes			
tsf_delv_line_item	Yes			

Restart/Recovery

This batch can be re-run by starting a new batch job after the issues are resolved.

Purge Completed UINs

Purge CompletedUINs batch does the following:

- Deletes completed UIN Detail records. A completed UIN is any UIN with a status of Removed from Inventory, Missing, Sold, Shipped to Vendor, or Shipped to Warehouse.
- Any UIN detail record with a complete status and update date at least X days in the past (where X is with system parameter **Days to Hold Completed UINs**) will be deleted from ITEM_UIN and ITEM_UIN_PROBLEM table.

Batch Job Definition Name

CompletedUin_PurgeJob

Batch Job Parameters

<input_date>

Where `input_date` is defaulted to current timestamp if not specified. It is used for comparing if a record date is a configured number of days prior to the input date. System batch input date format is used for parsing input date if specified.

Key Tables

Table 5–53 *Key Tables for Purge Completed UIN Detail Batch*

Tables	Select	Insert	Update	Delete
<code>config_system</code>	Yes			
<code>item_uin</code>	Yes			Yes
<code>item_uin_problem</code>	Yes			Yes

Restart/Recovery

This batch can be re-run by starting a new batch job after the issues are resolved.

Purge DSD and Purchase Orders

Purge DSD Receiving and Purge orders batch process does the following:

- Deletes the Direct Store Delivery receiving.
- Any DSD record which is in Closed/Cancelled status, and which has a complete date older than **Days to Hold Received Shipments** is an eligible record for purge.
- In effect, a DSD record can be purged only if its associated PO records can be purged.

Batch Job Definition Name

DsdAndPurchaseOrders_PurgeJob

Batch Job Parameters

<input_date>

Where input_date is defaulted to current timestamp if not specified. It is used for comparing if a record date is a configured number of days prior to the input date. System batch input date format is used for parsing input date if specified.

Key Tables

Table 5–54 Key Tables for Purge DSD Receiving Batch

Tables	Select	Insert	Update	Delete
config_system	Yes			
purchase_order	Yes		Yes	Yes
purchase_order_line_item	Yes			Yes
dsd	Yes			Yes
notes	Yes			Yes
dsd_adjustment	Yes			Yes
dsd_carton	Yes			Yes
dsd_line_item	Yes			Yes
dsd_line_item_uin	Yes			Yes
dsd_line_item_att	Yes			Yes
purchase_order	Yes			Yes
purchase_order_line_item				Yes

Restart/Recovery

This batch can be re-run by starting a new batch job after the issues are resolved.

Purge Customer Orders

Purge Customer Orders Batch does the following:

- Deletes all the fulfillment order records which are not in New or In Progress status and for which the update date has expired the purge_date by number of days more than **Days to Hold Customer Order** parameter value.
- Additionally, only those fulfillment orders will be deleted for which customer order ID and fulfillment order ID combination does not exist for any Transfer, Return, Purchase Order, and Warehouse delivery transaction.

Batch Job Definition Name

FulfillmentOrders_PurgeJob

Batch Job Parameters

<input_date>

Where input_date is defaulted to current timestamp if not specified. It is used for comparing if a record date is a configured number of days prior to the input date. System batch input date format is used for parsing input date if specified.

Key Tables

Table 5–55 Key Tables for Purge Fulfillment Orders Batch

Tables	Select	Insert	Update	Delete
config_system	Yes			
tsf	Yes			
purchase_order	Yes			
tsf_delv_line_item	Yes			
ful_ord	Yes			Yes
ful_ord_line_item	Yes			Yes
ful_ord_dlv	Yes			Yes
ful_ord_dlv_line_item	Yes			Yes
ful_ord_dlv_line_item_uin	Yes			Yes
ful_ord_dlv_line_item_att	Yes			Yes
ful_ord_rv_pick	Yes			Yes
ful_ord_rv_pick_line_item	Yes			Yes
ful_ord_pick	Yes			Yes
ful_ord_pick_line_item	Yes			Yes
ful_ord_bin	Yes			Yes

Restart/Recovery

This batch can be re-run by starting a new batch job after the issues are resolved.

Purge Invalid Users

This job deletes invalid application users from data store for those usernames are not found in identity store.

Batch Job Definition Name

InvalidUser_PurgeJob

Batch Job Parameters

<input_date>

Where input_date is defaulted to current timestamp if not specified. It is used for comparing if a record date is a configured number of days prior to the input date. System batch input date format is used for parsing input date if specified.

Key Tables

Table 5–56 Key Tables for Purge Invalid Users Batch

Tables	Select	Insert	Update	Delete
config_system	Yes			
security_user	Yes			
security_user_store	Yes			
security_user_role	Yes			Yes

Restart/Recovery

This batch can be re-run by starting a new batch job after the issues are resolved.

Purge Invalid User Roles

PurgeInvalidUserRoles batch program does the following:

- Removes all expired user roles and orphaned user roles (roles that were deleted by removing a store) from the SIOCS system.
- The batch process finds user role assignments that have an end date that is at least X days in the past (where X is specified by the system parameter **Days to Hold Expired User Roles**) and deletes these expired role assignments.
- The users (excluding super users) with role assignments that have no matching store assignments (orphaned role assignments) are also deleted from SECURITY_USER_ROLE table.

Batch Job Definition Name

InvalidUserRole_PurgeJob

Batch Job Parameters

<input_date>

Where input_date is defaulted to current timestamp if not specified. It is used for comparing if a record date is a configured number of days prior to the input date. System batch input date format is used for parsing input date if specified.

Key Tables

Table 5–57 Key Tables for Purge Invalid User Roles Batch

Tables	Select	Insert	Update	Delete
config_system	Yes			
security_user	Yes			
security_user_store	Yes			
security_user_role	Yes			Yes

Restart/Recovery

This batch can be re-run by starting a new batch job after the issues are resolved.

Purge Inventory Adjustments

Deletes inventory adjustments records with a create date/timestamp older than **Days To Hold Completed Inventory Adjustments** parameter value will be deleted. For example, the default value is 30. If the batch program is run with the default value, the batch program would delete all the inventory adjustment records, which are more than 30 days old.

Batch Job Definition Name

InventoryAdjustment_PurgeJob

Batch Job Parameters

<input_date>

Where input_date is defaulted to current timestamp if not specified. It is used for comparing if a record date is a configured number of days prior to the input date. System batch input date format is used for parsing input date if specified.

Key Tables

Table 5–58 Key Tables for Purge Inventory Adjustments Batch

Tables	Select	Insert	Update	Delete
config_system	Yes			
inv_adjust	Yes			Yes
inv_adjust_line_item	Yes			Yes
inv_adjust_line_item_uin	Yes			Yes
inv_adjust_line_item_att	Yes			Yes

Restart/Recovery

This batch can be re-run by starting a new batch job after the issues are resolved.

Purge Item

This batch program deletes items with a status of Delete (D).

There are two segments in the PurgeItem Batch which do the following different tasks:

- Validate if the Item should be deleted.
- Delete item from all associated tables if validation check is passed.
- Validate if the item should be deleted. The Validations include:
 - If SOH of item, item parent and item grandparent is 0.
 - If any transfers exist for item, item parent and item grandparent.
 - If any RTV exists for item, item parent and item grandparent.
 - If any Inventory adjustment exists for item, item parent and item grandparent and so on.
 - If any Item Basket exists for the item.
 - If any Product Group exists for the item.
 - If any Stock Count exists for the item.
 - If any Store Order exists for the item.
 - If any Item Request exists for the item.
 - If any Direct Store Delivery exists for the item.
 - If any Warehouse Delivery exists for the item.
- Delete item from all associated table. If the validations checks are met, the records related to the item which is marked for the purge action are deleted.

Batch Job Definition Name

Item_PurgeJob

Batch Job Parameters

<input_date>

Where input_date is defaulted to current timestamp if not specified. It is used for comparing if a record date is a configured number of days prior to the input date. System batch input date format is used for parsing input date if specified.

Key Tables

Table 5–59 Key Tables for Purge Item Batch

Tables	Select	Insert	Update	Delete
item_componen	Yes			Yes
Item	Yes			Yes
store_item_stock	Yes			
purchase_order_line_item	Yes			
rtv_line_item	Yes			
stock_count_line_item	Yes			
tsf_line_item	Yes			

Table 5-59 (Cont.) Key Tables for Purge Item Batch

Tables	Select	Insert	Update	Delete
rtv_ship_line_item	Yes			
dsd_line_item	Yes			
dsd_adjustment	Yes			
stock_count_line_item_uin	Yes			
tsf_ship_line_item	Yes			
tsf_delv_line_item	Yes			
item_basket_line_item	Yes			
print_store_order_item	Yes			
item_request_line_item	Yes			
ful_ord_line_item	Yes			
ful_ord_pick_line_item	Yes			
inv_adjust_line_item	Yes			
inv_adjust_template_item	Yes			
shelf_adjust_line_item	Yes			
shelf_replenish_line_item	Yes			
tsf_allocation	Yes			
item_uin	Yes			Yes
store_item	Yes			Yes
item_image	Yes			Yes
store_sequence_item	Yes			Yes
store_item_stock	Yes			Yes
store_item_stock_nonsell	Yes			Yes
supplier_item_manufacture	Yes			Yes
warehouse_item	Yes			Yes
partner_item	Yes			Yes
supplier_item_uom	Yes			Yes
supplier_item	Yes			Yes
supplier_item_country	Yes			Yes
supplier_item_country_dim	Yes			Yes
item_component	Yes			Yes
item_price	Yes			Yes

Table 5–59 (Cont.) Key Tables for Purge Item Batch

Tables	Select	Insert	Update	Delete
item_price_history	Yes			Yes
store_uin_admin_item	Yes			Yes
item_uda	Yes			Yes
product_group_item	Yes			Yes
related_item	Yes			Yes

Restart/Recovery

This batch can be re-run by starting a new batch job after the issues are resolved.

Purge Item Baskets

Purges item basket records (with status of cancelled or completed) based on the retention period. The retention period is specified by system configuration parameter- **Days to Hold Item Basket**.

Batch Job Definition Name

ItemBasket_PurgeJob

Batch Job Parameters

<input_date>

Where input_date is defaulted to current timestamp if not specified. It is used for comparing if a record date is a configured number of days prior to the input date. System batch input date format is used for parsing input date if specified.

Key Tables**Table 5–60 Key Tables for Purge Item Basket Batch**

Tables	Select	Insert	Update	Delete
config_system	Yes			
scan_block_item_att	Yes			Yes
scan_block	Yes			Yes
item_basket_line_item	Yes			Yes
item_basket_cda	Yes			Yes
item_basket_hierarchy	Yes			Yes
item_basket	Yes			Yes

Restart/Recovery

This batch can be re-run by starting a new batch job after the issues are resolved.

Purge Item Hierarchy

Purges all Item Hierarchies that is in delete status. It also records from referencing tables such as STOCK_COUNT_ADHOC_CONFIG and ITEM_HIERARCHY_ATTRIB.

Batch Job Definition Name

ItemHierarchy_PurgeJob

Batch Job Parameters

<input_date>

Where input_date is defaulted to current timestamp if not specified. It is used for comparing if a record date is a configured number of days prior to the input date. System batch input date format is used for parsing input date if specified.

Key Tables

Table 5–61 Key Tables for Purge Item Hierarchy Batch

Table	Select	Insert	Update	Delete
item	Yes			
product_group_hierarchy	Yes			
stock_count_adhoc_config	Yes			Yes
item_hierarchy_attrib	Yes			Yes
item_hierarchy	Yes			Yes

Restart/Recovery

This batch can be re-run by starting a new batch job after the issues are resolved.

Purge Item Price

Purge Item Price batch process does the following:

- Purges records which were expired or were marked as deleted from ITEM_PRICE table based on the retention period. The retention period is specified by system configuration parameter **Days to hold expired item price**.

Following are the rules defining records to be purged:

- **Regular Price Change:** Has status of completed or deleted, effective date was X number of days in the past (relative to the specified date if specified). At any given time, at least one completed latest regular price must be retained in ITEM_PRICE for a store item.
- **Promotion Change:** Has status of completed or deleted, and end date is number of days in the past (relative to the specified date if specified).
- **Clearance Change:** Has status of completed or deleted, and end date is number of days in the past (relative to the specified date if specified).

Batch Job Definition Name

ItemPrice_PurgeJob

Batch Job Parameters

<input_date>

Where input_date is defaulted to current timestamp if not specified. System batch input date format is used for parsing input date if specified.

<store id>

Where store id is store identifier. If store id is not specified, then data for all managed stores will be processed in parallel processing.

Key Tables**Table 5–62 Key Tables for Purge Item Price Batch**

Tables	Select	Insert	Update	Delete
item_price	Yes			Yes

Restart/Recovery

This batch can be re-run by starting a new batch job after the issues are resolved.

Purge Lockings

This batch process deletes lockings records from ACTIVITY_LOCK table. Any lock record with a lock date/timestamp older than **Days to Hold Locking Records** system configuration value will be deleted. For example, the default value is 30. If the batch program is run with the default value, the batch program would delete all the shelf replenishment records, which are more than 30 days old.

Batch Job Definition Name

Lockings_PurgeJob

Batch Job Parameters

<input_date>

Where input_date is defaulted to current timestamp if not specified. It is used for comparing if a record date is a configured number of days prior to the input date. System batch input date format is used for parsing input date if specified.

Key Tables**Table 5–63 Key Tables for Purge Lockings Batch**

Tables	Select	Insert	Update	Delete
config_system	Yes			
activity_lock	Yes			Yes

Restart/Recovery

This batch can be re-run by starting a new batch job after the issues are resolved.

Purge Notifications

This job deletes notifications. The retention period is specified by system configuration parameter **Days to Hold Notifications**.

Batch Job Definition Name

Notifications_PurgeJob

Batch Job Parameters

<input_date>

Where input_date is defaulted to current timestamp if not specified. It is used for comparing if a record date is a configured number of days prior to the input date. System batch input date format is used for parsing input date if specified.

Key Tables

Table 5–64 Key Tables for Purge Notifications Batch

Tables	Select	Insert	Update	Delete
config_system	Yes			
notification	Yes			Yes

Restart/Recovery

This batch can be re-run by starting a new batch job after the issues are resolved.

Purge Price Change Worksheet

This batch process deletes price change worksheet records from the staging table which are in Rejected/Completed status. Any price change record with an effective date/timestamp older than **Days To Hold Price Changes** parameter value will be deleted. For example, the default value is 30. If the batch program is run with the default value, the batch program would delete all the price change records, which are more than 30 days old.

Batch Job Definition Name

PriceChangeWorksheet_PurgeJob

Batch Job Parameters

<input_date>

Where input_date is defaulted to current timestamp if not specified. System batch input date format is used for parsing input date if specified.

<store id>

Where store id is store identifier. If store id is not specified, then data for all managed stores will be processed in parallel processing.

Key Tables

Table 5–65 Key Tables for Purge Price Change Worksheet Batch

Tables	Select	Insert	Update	Delete
config_system	Yes			

Table 5–65 (Cont.) Key Tables for Purge Price Change Worksheet Batch

Tables	Select	Insert	Update	Delete
price_change_worksheet	Yes			Yes
item_price				Yes

Restart/Recovery

This batch can be re-run by starting a new batch job after the issues are resolved.

Purge Price Histories

This batch process deletes price histories. At least a minimum of 4 historical prices are maintained for an item/store. **Days To Hold Price History** will determine the number of days that price histories can be kept in the database.

Batch Job Definition Name

PriceHistories_PurgeJob

Batch Job Parameters

<input_date>

Where input_date is defaulted to current timestamp if not specified. It is used for comparing if a record date is a configured number of days prior to the input date. System batch input date format is used for parsing input date if specified.

<store id>

Where store id is store identifier. If store id is not specified, then data for all managed stores will be processed in parallel processing.

Key Tables**Table 5–66 Key Tables for Purge Price Histories Batch**

Tables	Select	Insert	Update	Delete
config_system	Yes			
item_price_history	Yes			Yes

Restart/Recovery

This batch can be re-run by starting a new batch job after the issues are resolved.

Purge Related Items

This batch process deletes the related items for which the end date has expired for more than **Days To Hold Related Items** system configuration value.

Batch Job Definition Name

RelatedItems_PurgeJob

Batch Job Parameters

<input_date>

Where `input_date` is defaulted to current timestamp if not specified. It is used for comparing if a record date is a configured number of days prior to the input date. System batch input date format is used for parsing input date if specified.

Key Tables

Table 5–67 Key Tables for Purge Related Items Batch

Tables	Select	Insert	Update	Delete
<code>config_system</code>	Yes			
<code>related_item</code>	Yes			Yes

Restart/Recovery

This batch can be re-run by starting a new batch job after the issues are resolved.

Purge Resolved UIN Problems

Deletes resolved UIN exception records. UIN exception records with status of resolved and resolved date is at least X days in the past (where X is system parameter **Days to Hold Resolved UIN Exceptions**) are deleted from `ITEM_UIN_PROBLEM` table.

Batch Job Definition Name

`ResolvedUinProblem_PurgeJob`

Batch Job Parameters

<`input_date`>

Where `input_date` is defaulted to current timestamp if not specified. It is used for comparing if a record date is a configured number of days prior to the input date. System batch input date format is used for parsing input date if specified.

Key Tables

Table 5–68 Key Tables for Purge Resolved UIN Problems Batch

Table	Select	insert	Update	Delete
<code>config_system</code>	Yes			
<code>item_uin_problem</code>	Yes			Yes

Restart/Recovery

This batch can be re-run by starting a new batch job after the issues are resolved.

Purge RFID

This job deletes RFIDs which is not present in location. The retention period is specified by system configuration parameter **Days to Hold RFID**.

Batch Job Definition Name

`Rfid_PurgeJob`

Batch Job Parameters

<`input_date`>

Where `input_date` is defaulted to current timestamp if not specified. It is used for comparing if a record date is a configured number of days prior to the input date. System batch input date format is used for parsing input date if specified.

Key Tables

Table 5–69 Key Tables for Purge Notifications Batch

Tables	Select	Insert	Update	Delete
<code>config_system</code>	Yes			
<code>Rfid</code>	Yes			Yes

Restart/Recovery

This batch can be re-run by starting a new batch job after the issues are resolved.

Purge Sales Posting

This batch process deletes the Point-of-Service transaction from the Oracle Retail Xstore Point of Service transaction staging table. It reads the **Days to Hold Sales Posting** and **Days to Hold Failed Sales** configuration parameters and all the transactions which are present beyond the configuration parameter are deleted. It also purges the POS transaction logs for the request IDs that are in processed status.

Batch Job Definition Name

`SalesPosting_PurgeJob`

Batch Job Parameters

<`input_date`>

Where `input_date` is defaulted to current timestamp if not specified. It is used for comparing if a record date is a configured number of days prior to the input date. System batch input date format is used for parsing input date if specified.

Key Tables

Table 5–70 Key Tables for Purge Sales Posting Batch

Tables	Select	Insert	Update	Delete
<code>config_system</code>	Yes			
<code>pos_transaction</code>	Yes			
<code>pos_transaction_log</code>	Yes			

Restart/Recovery

This batch can be re-run by starting a new batch job after the issues are resolved.

Purge Shelf Adjustments

Purges shelf adjustment records (with status of completed) based on the retention period. The retention period is specified by system configuration parameter- **Days to Hold Shelf Adjustment List**.

Batch Job Definition Name

ShelfAdjustments_PurgeJob

Batch Job Parameters

<input_date>

Where input_date is defaulted to current timestamp if not specified. It is used for comparing if a record date is a configured number of days prior to the input date. System batch input date format is used for parsing input date if specified.

Key Tables

Table 5–71 Key Tables for Purge Shelf Adjustment Batch

Tables	Select	Insert	Update	Delete
config_system	Yes			
shelf_adjust_line_item	Yes			Yes
shelf_adjust_cda	Yes			Yes

Restart/Recovery

This batch can be re-run by starting a new batch job after the issues are resolved.

Purge Shelf Replenishment

This batch process deletes shelf replenishment lists which are in Completed/Cancelled state. Any shelf replenishment list record with a status date/timestamp older than **Days To Hold Shelf Replenishment** parameter value will be deleted. For example, the default value is 1. If the batch program is run with the default value, the batch program would delete all the pick list records, which are more than a day old.

In addition, the batch will also delete shelf adjustment lists which are in Complete state. Any shelf adjustment record with an update date/timestamp older than **Days to Hold Shelf Adjustment Lists** parameter value will be deleted.

Batch Job Definition Name

ShelfReplenishments_PurgeJob

Batch Job Parameters

<input_date>

Where input_date is defaulted to current timestamp if not specified. It is used for comparing if a record date is a configured number of days prior to the input date. System batch input date format is used for parsing input date if specified.

Key Tables

Table 5–72 Key Tables for Purge Shelf Replenishment Batch

Tables	Select	Insert	Update	Delete
config_system	Yes			
shelf_adjust	Yes			
product_group	Yes			
shelf_replenish_line_item	Yes			Yes
shelf_replenish	Yes			Yes

Restart/Recovery

This batch can be re-run by starting a new batch job after the issues are resolved.

Purge Staged Message

This batch finds integration staging records that are marked as processed or deleted, and update date is at least *X* days in the past (where *X* is the system parameter **Days to Hold Completed Staging Records**), the batch process deletes these records from MPS_STAGED_MESSAGE table.

Rebuilding the indexes on the MPS_STAGED_MESSAGE table each day is recommended after batch process completes.

Batch Job Definition Name

StagedMessage_PurgeJob

Batch Job Parameters

<input_date>

Where input_date is defaulted to current timestamp if not specified. It is used for comparing if a record date is a configured number of days prior to the input date. System batch input date format is used for parsing input date if specified.

Key Tables

Table 5–73 Key Tables for Purge Staged Message Batch

Tables	Select	Insert	Update	Delete
config_system	Yes			
mps_staged_message	Yes			Yes

Restart/Recovery

This batch can be re-run by starting a new batch job after the issues are resolved.

Purge Stock Counts

This batch process deletes stock counts which are in Completed/Cancelled status. Any stock count with a schedule date/timestamp older than **Days To Hold Completed Stock Counts** parameter value will get deleted. For example, the default value is 30. If the batch program is run with the default value, the batch program would delete all the stock return records, which are more than 30 days old.

Batch Job Definition Name

StockCounts_PurgeJob

Batch Job Parameters

<input_date>

Where input_date is defaulted to current timestamp if not specified. It is used for comparing if a record date is a configured number of days prior to the input date. System batch input date format is used for parsing input date if specified.

Key Tables

Table 5–74 Key Tables for Purge Stock Counts Batch

Table	Select	Insert	Update	Delete
config_system	Yes			
stock_count	Yes			Yes
stock_count_child	Yes			Yes
stock_count_rejected_item	Yes			Yes
shelf_replenish_line_item	Yes			Yes

Restart/Recovery

This batch can be re-run by starting a new batch job after the issues are resolved.

Purge Temporary UINs

This batch process deletes temporary UIN records. UIN records with no status and update date is at least *X* days in the past (where *X* is system parameter **Days to Hold Temporary UINs**) are deleted from ITEM_UIN table.

Batch Job Definition Name

TemporaryUin_PurgeJob

Batch Job Parameters

<input_date>

Where input_date is defaulted to current timestamp if not specified. It is used for comparing if a record date is a configured number of days prior to the input date. System batch input date format is used for parsing input date if specified.

Key Tables

Table 5–75 Key Tables for Purge Temporary UIN Detail Batch

Table	Select	Insert	Update	Delete
Item_uin	Yes			Yes

Restart/Recovery

This batch can be re-run by starting a new batch job after the issues are resolved.

Purge Ticket Histories

Purges ticket history records based on the retention period. The retention period is specified by system configuration parameter- **Days to Hold Ticket History**.

Batch Job Definition Name

TicketHistory_PurgeJob

Batch Job Parameters

<input_date>

Where input_date is defaulted to current timestamp if not specified. It is used for comparing if a record date is a configured number of days prior to the input date. System batch input date format is used for parsing input date if specified.

Key Tables

Table 5–76 Key Tables for Purge Ticket Histories Batch

Table	Select	Insert	Update	Delete
config_system	Yes			
ticket_history	Yes			

Restart/Recovery

This batch can be re-run by starting a new batch job after the issues are resolved.

Purge Vendor Returns

This batch process deletes vendor returns which are in closed or completed status. Any vendor return record with a closed date/timestamp older than **Days to Hold RTV** system configuration value will be deleted. For example, the default value is 30. If the batch program is run with the default value, the batch program would delete all the vendor return records, which are more than 30 days old.

Batch Job Definition Name

VendorReturn_PurgeJob

Batch Job Parameters

<input_date>

Where input_date is defaulted to current timestamp if not specified. It is used for comparing if a record date is a configured number of days prior to the input date. System batch input date format is used for parsing input date if specified.

Key Tables

Table 5–77 Key Tables for Purge Vendor Returns Batch

Tables	Select	Insert	Update	Delete
config_system	Yes			
rtv_ship	Yes			Yes
rtv_ship_line_item				Yes
rtv_ship_line_item_att				Yes
rtv_ship_line_item_uin				Yes
rtv		Yes		Yes
rtv_line_item				Yes
notes				Yes

Restart/Recovery

This batch can be re-run by starting a new batch job after the issues are resolved.

Data Purging Batches - BDI Staging Data

- [Purge BDI Inbound Price](#)
- [Purge BDI Item](#)
- [Purge BDI Item Loc](#)
- [Purge BDI Location](#)
- [Purge BDI Misc Group](#)
- [Purge BDI Price Hist](#)
- [Purge BDI Rfid](#)
- [Purge BDI Store Inventory Avail](#)
- [Purge BDI Supp Item](#)
- [Purge BDI UDA](#)
- [Purge BDI Warehouse Item Avail](#)

Purge BDI Inbound Price

This job deletes BDI pricing staging data. The retention period is default to 6 months.

Batch Job Definition Name

BdiTxPriceGrp_PurgeJob

Batch Job Parameters

<input_date>

input_date is defaulted to current timestamp if not specified. It is used for comparing if a record date is a configured number of days prior to the input date. System batch input date format is used for parsing input date if specified.

Key Tables

Table 5–78 Key Tables for Purge BDI Warehouse Item Avail

Tables

EXT_PRICE_IN
PRICE_CHANGE_IN
CLERANCE_IN

Restart/Recovery

This batch can be restarted/re-run from previous failures after the issues are resolved.

Purge BDI Item

This job deletes BDI item hierarchy and item staging data. The retention period is default to 6 months.

Batch Job Definition Name

BdiFndMerchItemGrp_PurgeJob

Batch Job Parameters

<input_date>

input_date is defaulted to current timestamp if not specified. It is used for comparing if a record date is a configured number of days prior to the input date. System batch input date format is used for parsing input date if specified.

Key Tables

Table 5–79 Key Tables for Purge BDI Item

Tables

ITEM_HDR_IN
ITEM_IMAGE_IN
MERCH_HIER_IN
RELATED_ITEM_DTL_IN
RELATED_ITEM_IN
PACKITEM_BREAKOUT_IN

Restart/Recovery

This batch can be restarted/re-run from previous failures after the issues are resolved.

Purge BDI Item Loc

This job deletes item location records from BDI inbound interface staging tables. The retention period is default to 6 months.

Batch Job Definition Name

BdiFndItemLocGrp_PurgeJob

Batch Job Parameters

<input_date>

input_date is defaulted to current timestamp if not specified. It is used for comparing if a record date is a configured number of days prior to the input date. System batch input date format is used for parsing input date if specified.

Key Tables**Table 5–80 Key Tables for Purge BDI Item Loc****Tables**

ITEM_LOC_IN

REPL_ITEM_LOC_IN

Restart/Recovery

This batch can be restarted/re-run from previous failures after the issues are resolved.

Purge BDI Location

This job deletes BDI location entities and their addresses staging data. The retention period is default to 6 months.

Batch Job Definition Name

BdiFndLocationGrp_PurgeJob

Batch Job Parameters

<input_date>

input_date is defaulted to current timestamp if not specified. It is used for comparing if a record date is a configured number of days prior to the input date. System batch input date format is used for parsing input date if specified.

Key Tables**Table 5–81 Key Tables for Purge BDI Location****Tables**

PARTNER_IN

PARTNER_ADDR_IN

PARTNER_ORG_UNIT_IN

STORE_IN

STORE_ADDR_IN

SUPS_IN

SUPPLIER_ADDR_IN

SUPS_CFA_EXT_IN

WH_IN

WH_ADDR_IN

Restart/Recovery

This batch can be restarted/re-run from previous failures after the issues are resolved.

Purge BDI Misc Group

This job deletes BDI code and UOM miscellaneous staging data. The retention period is default to 6 months.

Batch Job Definition Name

BdiFndMiscGrp_PurgeJob

Batch Job Parameters

<input_date>

input_date is defaulted to current timestamp if not specified. It is used for comparing if a record date is a configured number of days prior to the input date. System batch input date format is used for parsing input date if specified.

Key Tables

Table 5–82 Key Tables for Purge BDI Misc Group

Tables

CODE_HEAD_IN

CODE_DETAIL_IN

DELIVERY_SLOT_IN

UOM_CONVERSION_IN

UOM_CLASS_IN

Restart/Recovery

This batch can be restarted/re-run from previous failures after the issues are resolved.

Purge BDI Price Hist

This job deletes BDI price history staging data. The retention period is default to 6 months.

Batch Job Definition Name

BdiFndPriceHist_PurgeJob

Batch Job Parameters

<input_date>

input_date is defaulted to current timestamp if not specified. It is used for comparing if a record date is a configured number of days prior to the input date. System batch input date format is used for parsing input date if specified.

Key Tables**Table 5–83 Key Tables for Purge BDI Price Hist****Tables**

PRICE_HIST_IN

Restart/Recovery

This batch can be restarted/re-run from previous failures after the issues are resolved.

Purge BDI Rfid

This job deletes BDI Rfid staging data. The retention period is default to 6 months.

Batch Job Definition Name

BdiTxRfid_PurgeJob

Batch Job Parameters

<input_date>

input_date is defaulted to current timestamp if not specified. It is used for comparing if a record date is a configured number of days prior to the input date. System batch input date format is used for parsing input date if specified.

Key Tables**Table 5–84 Key Tables for Purge BDI Rfid****Tables**

EXT_RFID_IN

Restart/Recovery

This batch can be restarted/re-run from previous failures after the issues are resolved.

Purge BDI Store Inventory Avail

This job deletes BDI Available store inventory staging data. The retention period is default to 6 months.

Batch Job Definition Name

BdiTxInvAvailStore_PurgeJob

Batch Job Parameters

<input_date>

input_date is defaulted to current timestamp if not specified. It is used for comparing if a record date is a configured number of days prior to the input date. System batch input date format is used for parsing input date if specified.

Key Tables

Table 5–85 Key Tables for Purge BDI Store Inventory Avail

Tables

INV_AVAIL_STORE_IN

Restart/Recovery

This batch can be restarted/re-run from previous failures after the issues are resolved.

Purge BDI Supp Item

This job deletes BDI Supplier items staging data. The retention period is default to 6 months.

Batch Job Definition Name

BdiFndSupItemGrp_PurgeJob

Batch Job Parameters

<input_date>

input_date is defaulted to current timestamp if not specified. It is used for comparing if a record date is a configured number of days prior to the input date. System batch input date format is used for parsing input date if specified.

Key Tables

Table 5–86 Key Tables for Purge BDI Supp Item

Tables

ITEM_SUPPLIER_IN

ITEM_SUP_CTY_DIM_IN

ITEM_SUPP_COUNTRY_IN

ITEM_SUP_MAN_CTY_IN

ITEM_SUPP_UOM_IN

Restart/Recovery

This batch can be restarted/re-run from previous failures after the issues are resolved.

Purge BDI UDA

This job deletes BDI UDA staging data. The retention period is default to 6 months.

Batch Job Definition Name

BdiFndUdaGrp_PurgeJob

Batch Job Parameters

<input_date>

input_date is defaulted to current timestamp if not specified. It is used for comparing if a record date is a configured number of days prior to the input date. System batch input date format is used for parsing input date if specified.

Key Tables

Table 5–87 Key Tables for Purge BDI UDA

Tables

UDA_IN

UDA_VALUES_IN

UDA_ITEM_DATE_IN

Restart/Recovery

This batch can be restarted/re-run from previous failures after the issues are resolved.

Purge BDI Warehouse Item Avail

This job deletes BDI warehouse item available inventory staging data. The retention period is default to 6 months.

Batch Job Definition Name

BdiTxInvAvailWh_PurgeJob

Batch Job Parameters

<input_date>

input_date is defaulted to current timestamp if not specified. It is used for comparing if a record date is a configured number of days prior to the input date. System batch input date format is used for parsing input date if specified.

Key Tables

Table 5–88 Key Tables for Purge BDI Warehouse Item Avail

Tables

INV_AVAIL_WH_IN

Restart/Recovery

This batch can be restarted/re-run from previous failures after the issues are resolved.

Batch Job Administration

This provides information about the processing and operating details of batch job administration and operations, and covers the following topics:

- [Job Administration](#)
- [Job Scheduler](#)

The batch jobs are installed and configured by the EICS application installer. The batch processes are designed to process large volume of data. The batch jobs can be scheduled as per the retailer's choice to be executed on specific intervals on the SIOCS GUI.

The following diagram illustrates the high-level architecture of the current batch processing implemented for the EICS Application Server.

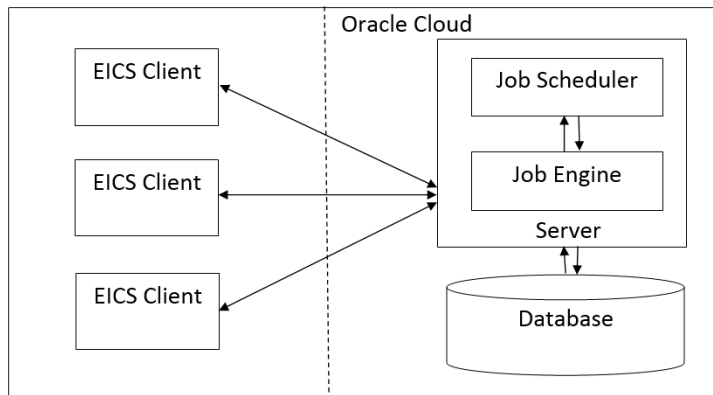
Figure 5–10 EICS Application Server Batch Processing Architecture

- **EICS Client - Server Communication**

EICS client provides an option to the retailer to run the batch jobs on demand. This call to the server is made via HTTP REST service call. The batch job selected, and the parameter selected by the user are set on the request and sent to the server on this call. The server handles this request and invokes a start job on the batch engine for the respective job.

- **Job Engine**

The job engine manages the state of a running job and guarantees the execution of each step defined for the job. The call made from the client or job scheduler is passed onto the job engine to start a new instance of the batch job. Users also have an option to stop the running job or to restart any particular job which failed during the processing.

- **Job Scheduler**

This feature of EICS allows a retailer to schedule the batch jobs to run at a specific time interval. Each batch job will initially execute at a pre-configured schedule interval. Retailers will have an option to enable or disable specific batch job schedules as well. For more information, please refer to Job Scheduler Section below.

Note: A few of the jobs which are system required will not be available for the retailer to change the schedule interval or disable them. These jobs will always be enabled and can be managed only by cloud admin.

Job Administration

SIOCS Job Admin is a web application that provides the runtime and GUI for managing batch jobs.

SIOCS provides an independent user interface for executing and scheduling of the batch jobs. These user interface screen will facilitate users to perform following operations:

- Execute Ad hoc Jobs
- Manual Data Seeding Importer Jobs

- View the Job Execution Log
- View the list of Jobs executed
- Schedule Jobs for execution on specific intervals

The following diagrams show the Batch Admin and relevant GUI components:

Figure 5–11 Batch Admin and GUI Components

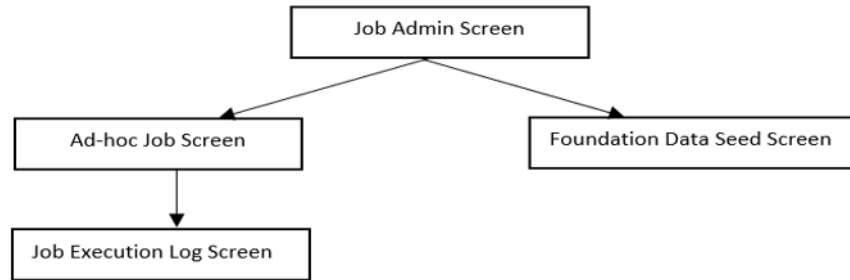

Job Admin Screen

This screen views the list of the job that have been instantiated on the server. User can filter the list of the job loaded on screen on Job Status, Reviewed and Search Limit. The default filter will load the list of the failed job when the screen is initially loaded.

User requires appropriate permission to access this screen on SIOCS. Navigation path for the Job Admin screen is:

Admin/Technical Maintenance/Job Admin

Figure 5–12 Job Admin Screen

Execution ID	Job Name	Instance ID	Status	Start Time	End Time	User	Reve...	Parameter
7546	Generate Problem Line Stock Count	7546	Failed	10/23/20 7:25:53 AM		sim_ga3	No	
7544	Generate Problem Line Stock Count	7544	Failed	10/23/20 7:22:29 AM		sim_ga3	No	
7540	Generate Problem Line Stock Count	7540	Failed	10/23/20 7:14:41 AM		sim_ga3	No	
7539	Generate Problem Line Stock Count	7539	Failed	10/23/20 7:11:08 AM		sim_admin	No	

Screen Options

- **Search**
Allows user to filter the list of the batch jobs instantiated by user and the scheduler.
- **Refresh**
This option refreshes the list loaded on the screen; call is made to server to load the list of batch jobs with current state.
- **Ad hoc Job**

This option refreshes the list loaded on the screen; call is made to server to load the list of batch jobs with current state.

- **Data Seed**

This option navigates user to Data Seed Job Launcher screen. User can start a new data seed job from this screen by setting the required parameters and data seeding options on the job. User will require appropriate access permission to view this option on the screen.

- **Stop Job**

This option allows user to stop a running job. This option is available only when selected job is in running state that is, *STARTED* and *STARTING*.

Table Information

- **Execution ID**

This column displays the job execution identifier generated by the job engine.

- **Job Name**

This column displays the name of the batch job.

- **Instance ID**

This column displays the job instance identifier generated by the job engine.

- **Status**

This column displays the current status of the batch job.

- **Start Time**

This column displays the time when job was started.

- **End Time**

This column displays the time when job was completed. If the job is currently in running state, the end time will not be available.

- **User**

This column displays the user name of the user who started the job. The job started by the scheduler will have server user name in this column.

- **Reviewed**

This column denotes if user has review this job.

- **Parameter**

This column displays the parameter if entered while starting the batch job.

Job Execution Log Screen

This screen displays the execution details for the batch job. Users can navigate to this screen by clicking **Job Execution ID** on the Job Admin screen. This screen is designed to view the error logs for the batch jobs and to mark the job as reviewed.

Review flag denotes the selected job has been reviewed by the user. By using this, the user can keep a track of which of the failed jobs have already been reviewed and take necessary actions as required.

The execution detail table load the entries of the execution record if exist for the select batch job.

Figure 5–13 Job Execution Screen

Detail ID	Process...	Failed	Message	Data File	Additional Info
40116	Yes	No			6088

Screen Options

- **Mark Review**

This option allows user to mark the batch job as review. Once the job is marked as review user is navigated back to the Job Admin screen.

- **Cancel**

This option allows user to navigate back to the Job Admin screen.

Table Information

- **Detail ID**

This column displays the execution identifier generated by the job engine.

- **Processed**

This column denotes if the execution record for the job was successfully processed.

- **Failed**

This column denotes if the execution records was failed during the processing.

- **Message**

This column displays the message from the server to viewing the further details on the job status. This column will be empty for the execution records which are been successfully processed.

- **Data File**

This column displays the file name for which the execution record was created. This column holds data only if the job details with file import processing for example, Retail Sales Audit Import Job.

- **Additional Info**

This column holds the addition info if any for the execution record.

Message Details

This section is non-editable and displays the detailed explanation for the job failure. This section will display respective data on selection job execution record. The log traces of the exact point of failure shall be printed on this section of the screen.

Job Launch Screen

This screen allows user to start a new instance for a job. Select the batch job and enter the parameter, if required, to start job.

The job launcher screen has the following categories:

- [Ad hoc Job](#)
- [Data Seed Importer Job](#)
- [Start an Ad hoc Job](#)
- [View Details for Job](#)
- [Start a Data Seed Job](#)
- [Stop a Running Job](#)

Ad hoc Job This screen allows user to run an ad hoc job. All the job which are either operational or purge job can be started from this screen. All the batch job will not support the execution date and store identifier parameters. The job for which store level processing can be performed will consider these parameters. User will not receive an error or confirmation if the parameters are not valid for the selected job.

User will require appropriate data permissions to select and run a particular job. Navigation to this screen is as follows:

Admin/Technical Maintenance/Job Admin /Ad hoc Job

Figure 5–14 Ad hoc Job Screen

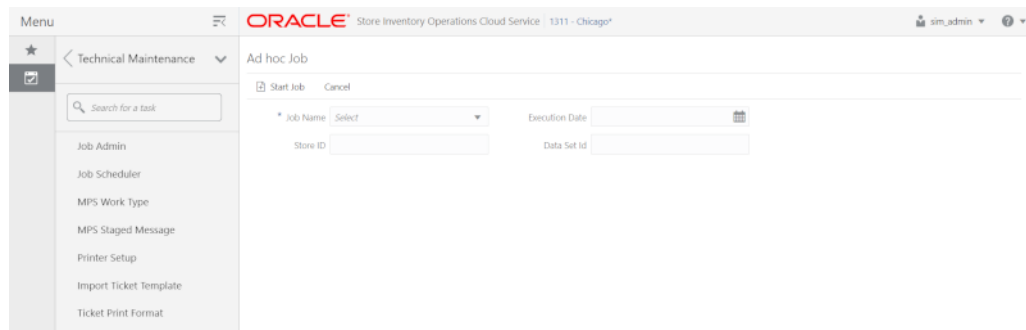

Screen Options

- **Start Job**

This option allows user to start a new instance of the selected job. When the user selects this option a call is made to server to start a selected batch job. Server internally makes a call to Batch Operator specifying the Job Name and the parameter if any.

- **Cancel**

This option navigates user back to Job Admin Screen.

Menu Options

- **Job Name**

Allows user to select the job to be started. This is a required field on this screen. The user will be able to view only those jobs in the drop-down list which are permitted to the user via data permissions.

- **Store ID**

Allow user to enter the store identifier if the job is expected to be executed for specific store. Not all job accepts store identifier as parameter. For the jobs which doesn't take store identifier as parameter for execution shall ignore this parameter.

- **Execution Date**

Allows user to enter the execution date for the job, if not entered the job will consider the current date for the execution. Not all job accepts execution date as parameter. For the jobs which doesn't take execution date as parameter for execution shall ignore this parameter.

- **Data Set Id**

The Data Set Id is optional parameter for importer job to process the specified data set from bulk data interface table.

Data Seed Importer Job This screen allows user to start data seeding importer specific jobs only. For additional details, please refer to [Data Seeding](#).

User will need appropriate access privileges to navigate to this screen.

Navigation to this screen is as follows:

Admin / Technical Maintenance / Job Admin / Data Seed

Figure 5–15 Data Seed Screen

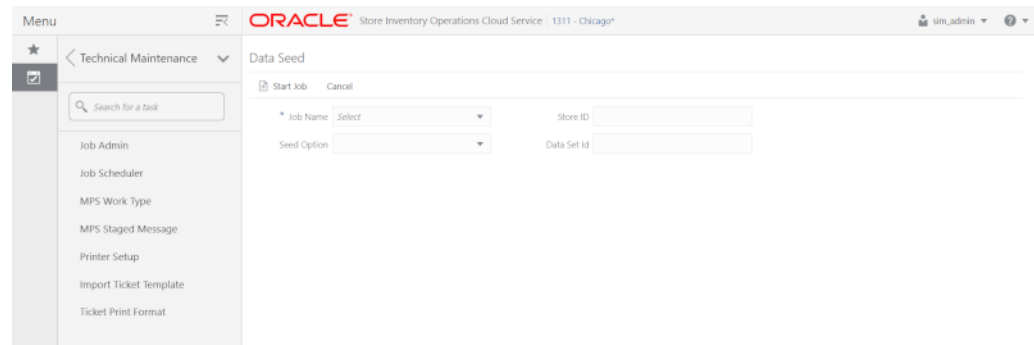

Screen Options

- **Start Job**

This option allows user to start a new instance of the selected job. When the user selects this option a call is made to server to start a selected batch job. Server internally makes a call to Batch Operator specifying the Job Name and the parameter if any.

- **Cancel**

This option navigates user back to Job Admin screen.

Menu Options

- **Job Name**

Allows user to select the job to be started. This is a required field on this screen. The user will be able to view only those jobs in the drop-down list which are permitted to the user via data permissions.

- **Seed Option**

User can select one of the option available as per the operation to be performed. The seed options are more over job specific and are not applicable for all job. If the invalid seed option is selected for the job, server will ignore it and perform a normal seed operation.

The options available are:

1. Seed: Seeds the data from BDI integration tables to the application tables.
2. Delete and Seed: Deletes the data from the application tables and reseed the available data in BDI integration tables.
3. Delete Seeded: Deletes the data from the application tables.
4. Delete In: Deletes the data from BDI integration tables.
5. Disable Constraint: Disable the constraints for all the application tables.
6. Enable Constraint: Enable the constraint for the application tables.

For example, if user selects Disable Constraint Option for Store Job, this won't disable the constraint for store table. The server will simply ignore the seed option and continue this as not seed operation.

- **Store ID**

Allows user to perform store level data seeding. The store identifier is not applicable for all the job. For the job which does not support store level data processing for example, Item Header or Supplier will simply ignore the store identifier if entered.

- **Data Set Id**

The Data Set Id is optional parameter for importer job to process the specified data set from bulk data interface table.

Start an Ad hoc Job

1. Login to SIOCS and navigate to **Job Admin** screen.
2. Click on **Ad hoc Job** menu to navigate to **Ad hoc Job** screen
3. Select the required **Job** from the drop-down menu.
4. Set the required job parameter for the job, that is, Store ID and/or Execution Date.

Note: Job Parameter doesn't apply to all available batch jobs, for the job which do not take any parameter input will simply ignore the value in case entered.

Some of batch jobs belongs BDI TX (Transaction) category, see [Appendix B, BDI Transaction \(TX\) Importer Jobs](#) section for details.

5. Click on **Start Job** to start the new instance of job.
6. The new execution record will be populated on the **Job Admin** screen list.

View Details for Job

1. Login to SIOCS and navigate to **Job Admin** screen.
2. Click the **Job Execution Id** to navigate to details.
3. To navigate back to **Job Admin** screen, click **Cancel**.

- To mark job execution reviewed, click **Mark Reviewed**.

Start a Data Seed Job

- Login to SIOCS and navigate to **Job Admin** screen.
- Click on **Data Seed** menu to navigate to **Data Seed** screen.
- Select the required job populated in the drop-down menu.
- Select required **Seed Option** from drop down.
- Enter **Store ID** if required.

Note: Store ID is not supported by all job, will be applicable only for jobs which processed store level data

Stop a Running Job

- Login to SIOCS and navigate to **Job Admin** screen.
- Select the job which is currently in running state that is, **STARTED** or **STARTING**.
- Click on **Stop Job** to stop the execution of the running job.
- Prompted to confirm if the job needs to be stopped. Click **Yes** to continue.
- Request is sent to job engine to stop the instance of the job. In case the job is already completed or stopped appropriate message shall be displayed to user.
- Refresh the list on the screen to view the changes.

Job Scheduler

EICS Job Scheduler allows user to schedule the job available to run under **Ad hoc Job** screen.

The key features of Job Scheduler are as follows:

- **Interval Based Schedule**

User can schedule the job to run on interval basis. User will be provided below specified interval to be set for each job for execution.

Table 5–89 Interval Based Schedule

Interval	Detail	Execution Hour
30th Minute	Job execution will be every 30th minute of the hour starting from 01:00.	01:00, 01:30, 02:00, 02:30, 03:00, 03:00 ... 23:00, 23:30, 00:00, 00:30.
1 Hour	Job execution will be every 1 hour starting from 01:00.	01:00, 02:00, 03:00, 04:00, 05:00 ... 22:00, 23:00, 00:00.
2 Hours	Job execution will be every 2nd hour of the day starting from 01:00.	01:00, 03:00, 05:00, 07:00, 09:00 ... 21:00, 23:00.
3 Hours	Job execution will be every 3rd hour of the day starting from 01:00.	01:00, 04:00, 07:00, 10:00, 13:00, 16:00, 19:00, 22:00.
4 Hours	Job execution will be every 4th hour of the day starting from 01:00.	01:00, 05:00, 09:00, 13:00, 17:00, 21:00.

Table 5–89 (Cont.) Interval Based Schedule

Interval	Detail	Execution Hour
6 Hours	Job execution will be every 6th hour of the day starting from 01:00.	01:00, 07:00, 13:00, 19:00.
8 Hours	Job execution will be every 8th hour of the day starting from 01:00.	01:00, 09:00, 17:00.
12 Hours	Job execution will be every 12th hour of the day starting from 01:00.	01:00, 13:00.
24 Hours	Job execution will be every 24th hour of the day starting from 01:00.	01:00.

- **Schedule Management**

User will have an option enabling or disabling the scheduler feature for a job at any given point of time. Once disabled the auto execution on the future scheduled interval will be stopped.

- **Scheduler Configuration**

User will have option of configuring the scheduler related configuration.

Table 5–90 Batch Job Schedules

Batch Job	Interval	Restricted
AdhocStockCount_PurgeJob	24 hours	No
ArchiveDump_OpsJob	24 hours	Yes
Audits_ArchiveJob	24 hours	No
AutoReplenishCapacity_OpsJob	24 hours	No
BatchLog_PurgeJob	24 hours	No
BdiFndItemLocGrp_PurgeJob	24 hours	No
BdiFndLocationGrp_PurgeJob	24 hours	No
BdiFndMerchItemGrp_PurgeJob	24 hours	No
BdiFndMiscGrp_PurgeJob	24 hours	No
BdiFndPriceHist_PurgeJob	24 hours	No
BdiFndSupItemGrp_PurgeJob	24 hours	No
BdiFndUdaGrp_PurgeJob	24 hours	No
BdiTxInvAvailStore_PurgeJob	24 hours	No
BdiTxInvAvailStore_PurgeJob	24 hours	No
BdiTxPriceGrp_PurgeJob	24 hours	No
BdiTxRfid_PurgeJob	24 hours	No
CleanupBatchDirectories_OpsJob	24 hours	Yes
CleanupShelfReplenishment_OpsJob	24 hours	Yes
ClearancePriceChange_OpsJob	24 hours	No
Clearance_Tx_ImporterJob	24 hours	Yes

Table 5–90 (Cont.) Batch Job Schedules

Batch Job	Interval	Restricted
ClosedTransfers_PurgeJob	24 hours	No
CompletedUin_PurgeJob	24 hours	No
DSDReceivingClosure_OpsJob	24 hours	Yes
DsdAndPurchaseOrders_PurgeJob	24 hours	No
ExtPrice_Tx_ImporterJob	30 minutes	No
ExtPrice_Tx_ImporterJob	30 minutes	No
FulfillmentOrderPickReminders_OpsJob	24 hours	Yes
FulfillmentOrderPickReminders_OpsJob	24 hours	Yes
FulfillmentOrders_PurgeJob	24 hours	No
GenerateProblemLineStockCount_OpsJob	24 hours	No
GenerateUnitAmountStockCount_OpsJob	24 hours	No
GenerateUnitStockCount_OpsJob	24 hours	No
InvAvailWh_Tx_ImporterJob	30 minutes	No
InvalidUserRole_PurgeJob	24 hours	Yes
InvalidUser_PurgeJob	12 hours	Yes
InventoryAdjustment_PurgeJob	24 hours	No
InventoryExtractSftpPush_OpsJob	24 hours	No
InventoryExtract_OpsJob	24 hours	No
ItemBasketMaintenance_OpsJob	24 hours	No
ItemBasket_PurgeJob	24 hours	No
ItemBasket_PurgeJob	24 hours	No
ItemPriceToHistory_OpsJob	24 hours	Yes
ItemPriceToHistory_OpsJob	24 hours	No
ItemUinHistory_ArchiveJob	24 hours	No
Item_PurgeJob	24 hours	No
Lockings_PurgeJob	24 hours	No
Notifications_PurgeJob	24 hours	No
PosTransactionImport_OpsJob	24 hours	No
PriceChangeWorksheet_PurgeJob	24 hours	No
PriceChange_Tx_ImporterJob	24 hours	Yes
PriceHistories_PurgeJob	24 hours	No
ProductBasket_PurgeJob	24 hours	No
ProductGroupScheduleCleanup_OpsJob	24 hours	Yes
PromotionPriceChange_OpsJob	24 hours	No
RegularPriceChange_OpsJob	24 hours	No
RelatedItems_PurgeJob	24 hours	No
ResolvedUinProblem_PurgeJob	24 hours	No

Table 5–90 (Cont.) Batch Job Schedules

Batch Job	Interval	Restricted
RetailSalesAuditImport_OpsJob	24 hours	No
ReturnNotAfterDateAlert_OpsJob	24 hours	Yes
RfidHistory_ArchiveJob	24 hours	No
Rfid_PurgeJob	24 hours	No
SalesPosting_PurgeJob	24 hours	No
SftpLogFile_PurgeJob	24 hours	No
ShelfAdjustments_PurgeJob	24 hours	No
ShelfReplenishments_PurgeJob	24 hours	No
StagedMessage_PurgeJob	24 hours	No
StockCountAuthorizeRecovery_OpsJob	24 hours	No
StockCountExportSftpPush_OpsJob	24 hours	No
StockCountUnitAndAmountSnapshot_OpsJob	24 hours	No
StockCounts_PurgeJob	24 hours	No
StoreItemStockHistory_ArchiveJob	24 hours	No
StoreSequenceImport_OpsJob	24 hours	No
TemporaryUin_PurgeJob	24 hours	No
ThirdPartyStockCountImport_OpsJob	24 hours	No
TicketHistory_PurgeJob	24 hours	No
TransferClose_OpsJob	24 hours	Yes
TransferDeliveryAutoReceive_OpsJob	24 hours	Yes
TransferDeliveryClose_OpsJob	24 hours	Yes
TransferNotAfterDateAlert_OpsJob	24 hours	Yes
TransfersOverdueBatch_OpsJob	24 hours	Yes
VendorReturnClosure_OpsJob	24 hours	Yes
VendorReturn_PurgeJob	24 hours	No
WarehouseItemStockImport_OpsJob	24 hours	No

Note: Batch job schedules which are marked as restricted are scheduled by default to execute in 24-hour intervals as defined in [Table 5–90, "Batch Job Schedules"](#). Most of these batches are keeping the system healthy and accurate by execution maintenance task. These are not visible to the Retailers' Admin Users and are disabled from being scheduled.

However, they can be executed on an adhoc basis from the **Adhoc Job** screen for testing purpose or to correct a malfunction.

Please use caution while running adhoc jobs since they can interfere with scheduled batch runs on same data set leading to records getting locked for one of the batches. So please run ad-hoc jobs when it is safe to do so by either waiting for same batch to complete its scheduled run OR making sure ad-hoc job can get completed before next scheduled job run for that batch.

Job Scheduler Screen

This screen allows user to manage the schedules for the batch jobs. The list of job available to be scheduled will be sort by the enabled flag followed by Job Name alphabetically that is, the jobs for which the scheduling is enable will be on the top of the list sorted by the Job Names in alphabetical order.

User can edit the batch job and perform following operations:

1. Enable / Disable a schedule.
2. Setting the execution interval for a batch job.

User will require appropriate authorization to access this screen. Retailer will not be able to view or disable the batch jobs which are system required. This batch jobs will be accessible to Cloud Admin user will have a predefined schedule. Navigation to this screen is as follows: Admin/Technical Maintenance/Job Scheduler

Figure 5–16 Job Scheduler Screen

The screenshot shows the Oracle Job Scheduler interface. On the left is a navigation menu with 'Technical Maintenance' selected. The main area displays a table of jobs. The 'Generate Unit Stock Count' job is selected, and its details are shown on the right.

Job Name	Enabled	Interval	Execution Time
Archive RFID History	Yes	24 Hours	12/7/20 8:00:00 PM
Generate Unit and Amount Stock Count	Yes	24 Hours	12/8/20 1:00:00 AM
Generate Unit Stock Count	Yes	24 Hours	12/8/20 1:00:00 AM
POS Transaction Import	Yes	24 Hours	12/7/20 8:00:00 PM
Third Party RFID Import	Yes	24 Hours	12/7/20 8:00:00 PM
Third Party Stock Count Import	Yes	24 Hours	12/7/20 8:00:00 PM
Archive Activity History	No	24 Hours	
Archive Item Uln History	No	24 Hours	
Archive store item stock history	No	24 Hours	
Auto Replenish Capacity	No	24 Hours	
Clearance Price Change Import	No	24 Hours	
Generate Problem Line Stock Count	No	24 Hours	
Inventory Extract	No	24 Hours	
Inventory Extract File SFTP Push Job	No	24 Hours	
Item Basket Maintenance	No	24 Hours	
Promotion Price Change Import	No	24 Hours	
Purge Adhoc Stock Count	No	24 Hours	
Purge Areas	No	24 Hours	
Purge Batch Item	No	24 Hours	

Detail for 'Generate Unit Stock Count':
 Job Name: Generate Unit Stock Count
 Description: This job generates unit type stock counts that have been setup as a product group.
 Interval: 24 Hours
 Enabled: Yes

Screen Options

- Save

This option allows user to save the changes made to the job schedules. User can make changes to multiple schedules in edit mode and apply the changes, however the changes will take affect only when the save operation is performed.

- **Refresh**

This option refreshes the list of values on the screen.

- **Edit**

This option will be enabled only when a schedule is selected to be edited and user have privileges to edit the job schedule. This option takes user to the edit mode in which user can change the execution interval for the job and enable or disable the schedule.

- **Apply**

This option will only apply the changes which are been made during edit mode. This option does not save the changes, it only applies the changes for the job and exit the edit mode. Click the Save option to save the changes.

- **Cancel**

This option is enabled only when user is in edit mode. This option allows user to discard any changes made to the schedule on edit mode or to exit the edit mode.

Menu Options

- **Interval**

User have option to select the appropriate interval for the batch job execution. Depending on the selected interval, server calculates the execution time for the batch job and runs it according. The base time for calculating the execution time on basis of the interval is 01:00 AM. For the store-based job this is as per the store time zone and for system jobs this is as per the server time zone.

Option for selecting the execution interval are as follows:

1. 30 Minutes - Runs every 30 minutes.
2. 1 Hour - Runs every hour.
3. 2 Hours - Runs every second hour of the day.
4. 3 Hours - Runs every third hour of the day.
5. 4 Hours - Runs every fourth hour of the day.
6. 6 Hours - Runs every sixth hour of the day.
7. 8 Hours - Runs every eighth hour of the day.
8. 12 Hours - Expected to be executed twice a day.
9. 24 Hours - Expected to be executed only once a day.

- **Enabled**

Table Information

- **Job Name**

This column displays the name of the job.

- **Enabled**

This column denotes whether a job is current scheduled.

- **Interval**

This column denotes the interval of the job execution.

- **Execution Time**

This column denotes the next execution time for the batch job. This column will not contain data for the jobs which are been disabled.

Configuring a Job Schedule

1. Login in SIOCS and navigate to the **Job Scheduler** screen.
2. Select the desired job from the list.

Note: If the Edit option is not available in the menu section, the user is not authorized to edit the batch job. Kindly assign appropriate user group or contact system admin for desired changes.

Some of batch jobs belongs BDI TX (Transaction) category, see [Appendix B, BDI Transaction \(TX\) Importer Jobs](#) section for details.

3. Edit the Job details on right panel.
4. Set required interval for execution and **Enabled** to **Yes**.
5. Click **Apply** to exit the edit mode.
6. For configuring multiple jobs on a go, repeat Step 2 for each job.
7. Click **Save** to save the current changes made on the screen.

Disabling a Job Schedule

1. Login in SIOCS and navigate to Job Scheduler screen.
2. Select the job from the list which needs to be disabled.
3. Edit the Job details on right panel.
4. Set **Enabled** as **No**.
5. Click **Apply** to exit the edit mode.
6. For disabling multiple jobs on a go, repeat Step 2 for each job.
7. Click **Save** to save the current changes made on the screen.

Batch - Data Archive

SIOCS is an inventory transaction system and not a data warehouse.

Large volume of data can cause performance issues for transnational products. It could also cause other operational challenges such as backups could take longer time and storage could go up.

To reduce overall size of the operational tables and improve performance, for selected history tables, SIOCS archives data into archive tables. These archive tables can be purged at later point.

Archive Data Batches

Figure 6–1 Archive Data Batches

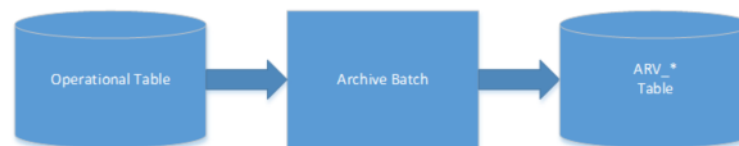

Table 6–1 Archive Data Batch List

Batch Job	Description
Archive RFID History	Archive RFID history records into archive table. See batch chapter Archive RFID History for batch details.
Archive Activity	Archive activity data into activity archive tables. See batch chapter Archive Activity for batch details.
Archive Item UIN History	Archive item UIN data into item UIN archive tables. See batch chapter Archive Item UIN History for batch details.
Archive Store Item Stock History	Archive store item stock history data into store item stock history archive tables. See batch chapter Archive Store Item Stock History for batch details.

Archive Dump Batches

The archive dump process creates the data dump files and truncates the archive tables.

The dump files are created using oracle Data Pump API, these files are written in a proprietary, binary format which are made up of one or more disk files that contain table data.

Figure 6–2 Archive Dump Batches

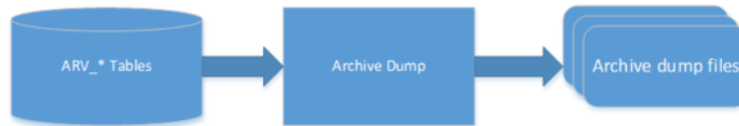

Table 6–2 Archive Dump Batch List

Batch Job	Description
Archive Dump	Export archive history data into Dump files and truncate archive history tables. See Batches chapter: Archive Dump for batch details.

Archive Batch Scheduling Consideration

Archive Data Batches need to be run prior to Archive Dump Batches.

The Archive Dump Batch Job need to be run after Archive Data batches.

Archive Data Dump Files Export

The archived history data dump files can be collected from database directory and exported to retailer per customer's request, Oracle AMS team will need to raise ticket to cloud DBA team to collect the data dump files. Once the data dump files are exported, it is up to retailer to take the files. EICS will no longer keep the data dump files after files are exported to customer.

If customer does not request to be exported to customers, these data dump files will be kept in database archive locations up to time determined by Oracle cloud service agreement.

Note: The data dump file location in database server can be queried using following:

```

Login to SIOCS PDB: SELECT DIRECTORY_PATH FROM DBA_
DIRECTORIES WHERE DIRECTORY_NAME = 'SIOCS_DATA_
PUMP_DIR';
  
```

Technical Maintenance Screens

This section covers the following topics:

- [Barcode Processor](#)
- [Credential Administration](#)
- [External Printer Setup](#)
- [MPS Staged Message](#)
- [MPS Work Type](#)
- [POS Transaction Resolution](#)
- [Sequence Administration](#)

Barcode Processor

Barcode Processors are used within EICS to scan items. When the application takes a barcode (or manual entry of one), it passes it along to the barcode processors to extra the correct sku number from the barcode in order to retrieve the item. This form allows the control of which barcode processors the application uses and what order they are used in. The barcode processor form is located under Configuration Barcode Processor.

Figure 7–1 Barcode Processor

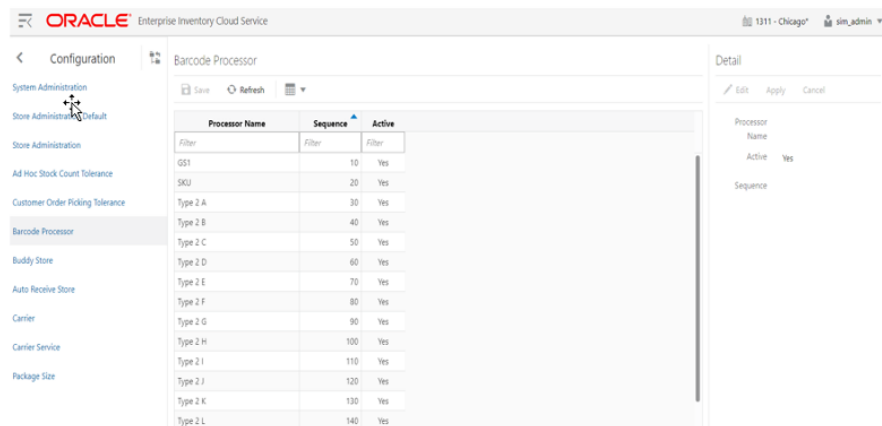

Processor Name	Sequence	Active
Filter	Filter	Filter
GS1	10	Yes
SKU	20	Yes
Type 2 A	30	Yes
Type 2 B	40	Yes
Type 2 C	50	Yes
Type 2 D	60	Yes
Type 2 E	70	Yes
Type 2 F	80	Yes
Type 2 G	90	Yes
Type 2 H	100	Yes
Type 2 I	110	Yes
Type 2 J	120	Yes
Type 2 K	130	Yes
Type 2 L	140	Yes

The above screen picture shows the list and detail panel in display mode.

List Buttons

- **Save:** Persists currently altered information.

- **Refresh:** Refreshes the screen with currently persisted information.
- **Filter:** Enable or disable the filtering row in the table.

Barcode Processor Attributes

- **Processor Name:** The name of the processor. This does not alter how the processor works. For example, Type 2 E will continue to parse Type 2 E, even if it is renamed to Type 2 K.
- **Sequence:** Sequence indicators the order the barcode processors will attempt to analyze the item scanned. It starts with the lowest sequence number and proceeds upward. Items will be returned by the first barcode processor that finds a valid item within the barcode.
- **Active:** Yes, indicates that the barcode processor is active and will be used when scanning items.

Detail Panel

Figure 7–2 Barcode Processor Detail Panel in Edit Mode

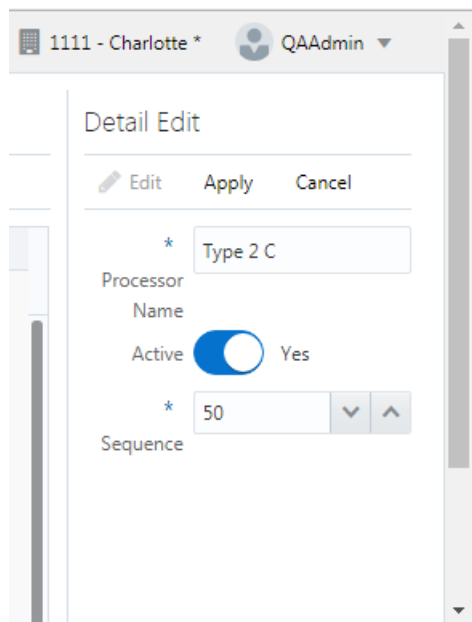

Detail Buttons

- **Edit:** Places the detail information displayed into edit mode.
- **Apply:** Applies the current data to the barcode processor and updates the list information.
- **Cancel:** Places the panel back into display mode without applying the information.

Barcode Processors

Table 7–1 Barcode Processors

Barcode Processor	Description
SKU	Parses the data scanned as a direct sku number or Universal Identification Number.
GS1	Parses the data scanned as a GS1 (Global Standards One) seeking out item number within.
Type 2 A-L	Barcode processor parses the data as a Universal Product Code (Type 2), otherwise known as random weight barcodes. There is a whole series of available code patterns from sub-type A to sub-type L.
UPC E	Parses the data scanned as a Universal Product Code (Type E), a six- digit barcode.
VPN	Parses the data scanned is a Vendor Product Number.
RFID	Parses the data as Radio Frequency Identification (RFID) tag.
RFID GTIN-12	Parses the data as Radio Frequency Identification (RFID) GTIN-12 tag.
RFID GTIN-13	Parses the data as Radio Frequency Identification (RFID) GTIN-13 tag.
ISN	Parses the data as Item Scan Number (ISN) seeking out the IMEI number.

Note: Any changes to the Barcode Processor configuration require EICS server restart. You can request a server bounce by contacting Oracle Support via a Service Request on My Oracle Support.

Credential Administration

The Credential Administration screen is used to setup integration credentials to connect with external/third-party systems.

To access this screen, user need to be assigned the following role/permission:

- **IDCS or OCI IAM app roles:** <SIOCS Primary APP>.admin_users
- **Security Permission:** Access Credential Administration

Figure 7-3 Credential Administration

The screenshot shows the Oracle Credential Administration interface. At the top, it displays 'ORACLE Store Inventory Operations Cloud Service 4241 - EIT_CFS_Company_Store'. Below this is the 'Credential Administration' header with buttons for 'Save', 'Refresh', 'Delete Selected', and a grid icon. The main content is a table with the following columns: Alias, Description, User, Password, Update Date, and Update User. The table contains several rows of user credentials, with 'report-user' highlighted in blue.

Alias	Description	User	Password	Update Date	Update User
<i>Filter</i>	<i>Filter</i>	<i>Filter</i>		<i>Filter</i>	<i>Filter</i>
rib-user	RIB Publisher User Credentials	ribadmin	<input checked="" type="checkbox"/>		
manifest-user	Manifest Web Service User Credentials		<input type="checkbox"/>		
notification-user	Notification Web Service User Credentials		<input type="checkbox"/>		
oms-user	Fulfillment Order Web Service User Credentials		<input type="checkbox"/>		
report-user	Reporting Web Service User Credentials		<input type="checkbox"/>		
store-order-user	Store Order Web Service User Credentials		<input type="checkbox"/>		
ticket-user	Ticket Print Web Service User Credentials		<input type="checkbox"/>		

List Buttons

- **Save:** Persists currently altered information.
- **Refresh:** Refreshes the screen with currently persisted information.
- **Delete Selected:** Delete the user and password value for the records selected from database.
- **Filter:** Activates the filter dialog allowing the user to filter information.

List Attributes

- **Alias:** The alias for the user.
- **Description:** The description of the user.
- **User:** The user name.
- **Password:** Displays whether a password has been set currently for the user.
- **Update Date:** The last update date.
- **Update User:** The user who updated the record last.

Detail Panel

Figure 7-4 Credential Administration Detail Panel in Edit Mode

The screenshot shows the 'Detail Edit' panel. At the top, there are buttons for 'Edit', 'Apply', and 'Cancel'. Below these are four input fields: 'Alias' (with value 'rib-user'), 'User *' (with value 'ribadmin'), 'Description' (with value 'RIB Publisher User Credentials'), and 'Password *' (empty). Below the password field is a 'Confirm Password *' field, also empty.

Detail Buttons

- **Edit:** Places the detail information displayed into edit mode.
- **Apply:** Applies the current data to the credential admin and updates the list information.
- **Cancel:** Places the panel back into display mode without applying the information.

Detail Attributes

- **Alias:** Shows the alias for the user. Pre-defined read only field.
- **Description:** Displays the user description. Pre-defined read only field.
- **User:** Field to enter user name.
- **Password:** Field to enter password for the user.
- **Confirm Password:** Field to enter password one more time in order to make sure the user has entered the right password.

External Printer Setup

The Printer's screen is used to configure printers. The user can add, view, edit, and delete a printer as well as assign a network address for each printer. They can also indicate whether the printer is the default printer for manifest printing or pre-shipment printing.

Figure 7–5 Print Setup Navigation and List Screen

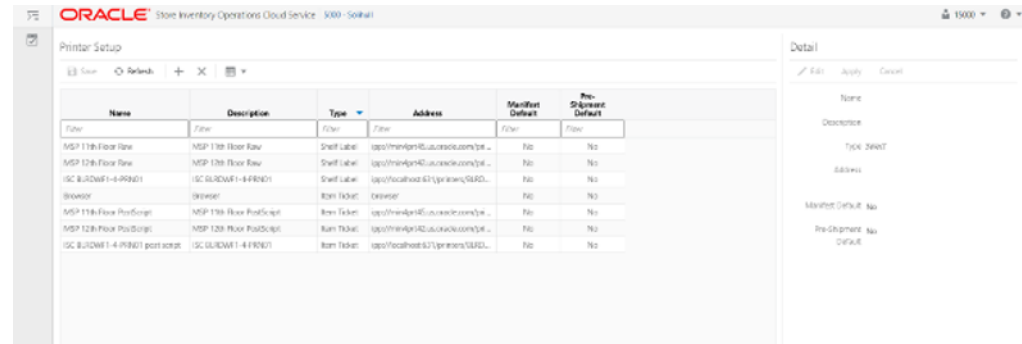

List Buttons

- **Save:** Persists currently altered information.
- **Refresh:** Refreshes the screen with currently persisted information.
- **+**: Add a new printer to configuration. It clears out the detail panel so the user can enter new printer information.
- **x:** Remove a printer from configuration. A dialog confirmation warning will occur prior to deletion of the record.
- **Filter:** Activates the filter dialog allowing the user to filter information.

Printer Attributes

- **Name:** The name of the printer.
- **Description:** Longer name for the printer.

- **Type:** The type of the printer. Valid values are: Item Ticket, Shelf Label and Postscript.
- **Address:** The address of the printer.
- **Manifest Default:** Yes, if this is the default printer for manifest printing, otherwise No.
- **Pre-Shipment Default:** Yes, if this is the default printer for pre-shipment printing, otherwise No.

Detail Panel

Figure 7-6 Printer Setup Detail Panel In Edit Mode

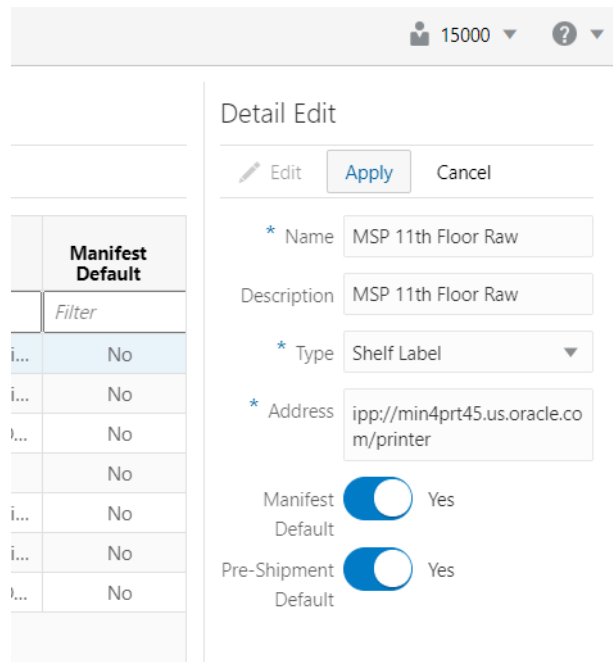

Detail Buttons

- **Edit:** Places the detail information displayed into edit mode.
- **Apply:** Applies the current data to the printer and updates the list information.
- **Cancel:** Places the panel back into display mode without applying the information.

MPS Staged Message

The MPS Staged Message administration form is used to monitor the messages in the Message Processing System queue. Each message contains the detailed information being transmitted between EICS and an external system.

Figure 7–7 MPS Staged Message

Record ID	In/Out	Type	Family	Create Time	Update Time	Execution Count	Business ID	Store ID	Job ID	Description
3725	Inbound	SOCre	BookOrder	9/18/18 8:52:16 AM	10/1/18 5:38:10 AM	31	1	1101	3725	SoDocTest
3728	Inbound	SOCre	BookOrder	9/18/18 9:07:40 AM	10/1/18 5:39:10 AM	31	10	1111	3728	SoDocTest

Filter Bar

- **Search:** This is a button that displays a filtering dialog.
- **Description:** A non-labeled text field follows the Filter button that displays what criteria are currently selected to filter the staged message table.

Filter Dialog Attributes

- **Family:** Limits the search results to only those messages in the specified family.
- **In/Out:** Indicates if the message is inbound to EICS or outbound to an external system.
- **Search Limit:** Limits the number of messages found to the specified limit or less.
- **Show Pending:** If true, only messages that are pending will be displayed.
- **Show Retry:** If true, only messages that are in retry will be displayed.

Figure 7–8 MPS Staged Message Filter

Filter Dialog Buttons

- **Search:** Executes a search for staged messages based on the selected criteria and refreshes the list table with that information.
- **Reset:** Results the filter dialog back to its default settings.
- **Cancel:** Closes the dialog without taking any action.

List Buttons

- **Refresh:** Refreshes the staged message list with current information.
- **Retry:** If a staged message is selected, selecting this button will retry the processing of the staged message.
- **Delete Selected:** If a stage message is selected, selecting this button will attempt to delete the message.
- **Filter:** Activates the filter dialog allowing the user to filter information.

List Attributes

- **Record Id:** A unique identifier assigned to the stage message.
- **In/Out:** Indicates if the message is inbound to EICS or outbound to an external system.
- **Type:** Type of message within a family. For example, most families of messages have a create, modify, and delete type of message.
- **Family:** Describes the family that the message belongs to. This will align with a MPS Work Type scheduled to process this family of messages.
- **Create Time:** The timestamp of the first time the message was created.
- **Update Time:** The timestamp of the last time the message was updated.
- **Execution Count:** The number of times the system has attempted to process the message.
- **Business ID:** A business identifier associated to the message. More than one message may carry a business identifier, and so this can be used to associate messages that may be related to the same activity.
- **Store ID:** The identifier of the store associated to the message.
- **Job ID:** The job identifier is a server-generated sequence number used for grouping related messages. If a message is singular with no other related messages, then its record identifier and job identifier will be identical. For messages, that must be executed sequentially together as a group, they will be assigned the same job identifier but different record identifiers.
- **Description:** A brief formatted description of the staged message that gives some indication of the contents within.

MPS Work Type

The MPS Work Type administration form is used to configure the MPS work types. MPS stands for Message Processing System and each work type represents an external inbound or outbound message family or grouping to be delivered to another system. These work types do not represent the messages themselves (see MPS Staged Message) but the working queue that handles the processing of these external messages.

Figure 7–9 MPS Work Type List

Work Type	Direction	Active	Retry Limit	Pending Count	Retry Count	Fail Count	Last Update	Last New	Retry Delay Secs	Retry Delay Max. Secs	Retry Delay Factor	Retry Delay Random	Purge Processed
ASIn	Inbound	Yes	1	0	0	0	9/27/18 12:45...	9/27/18 12:45...	1	1	1	1	No
ASOut	Outbound	No	-1	2	0	0	10/1/18 9:10:3...		-1	-1	-1	-1	No
CPInChg	Inbound	Yes	-1	0	0	0			-1	-1	-1	-1	No
Diffs	Inbound	Yes	-1	0	0	0			-1	-1	-1	-1	No
DaySR	Inbound	Yes	-1	0	0	0			-1	-1	-1	-1	No
DSDReceipt	Outbound	No	-1	2	0	0	10/10/18 11:5...		-1	-1	-1	-1	No
FuInOrd	Inbound	Yes	-1	0	0	0	9/18/18 3:53:3...	9/18/18 9:19:6...	-1	-1	-1	-1	No
FuInOrdCh	Outbound	No	-1	0	0	0			-1	-1	-1	-1	No
FuInOrdChCnc	Outbound	No	-1	0	0	0			-1	-1	-1	-1	No
ASOut	Outbound	No	-1	0	0	0			-1	-1	-1	-1	No

Detail

Retry Limit:
 Retry Delay Secs:
 Retry Delay Max. Secs:
 Retry Delay Factor:
 Retry Delay Random:
 Purge Processed:
 Active:

List Buttons

- **Save:** Persists currently altered information.
- **Refresh:** Refreshes the screen with currently persisted information.
- **Filter:** Activates the filter dialog allowing the user to filter information.

List Attributes

- **Work Type:** The work type is the name of the message queue being worked on.
- **Direction:** Indicates if the message queues is inbound to EICS or outbound to an external system.
- **Active:** Yes, indicates the work type is currently active and attempting to process messages. No indicates it has been disabled.
- **Retry Limit:** The number of times to attempt to process a single message before marking it as failed.
- **Pending Count:** Number of messages pending processing.
- **Retry Count:** Number of times the system as attempted to process the message. Zero times means processing has not been attempted yet.
- **Fail Count:** Number of messages that have failed to be processed.
- **Last Update:** The timestamp of the last time a staged message record was updated in the database for this specific work type.
- **Last New:** The timestamp of the last time a staged message record was created in the database for this specific work type.
- **Retry Delay Secs:** The delay in seconds between retries.
- **Retry Delay Max Secs:** The maximum delay in seconds between retries.

- **Retry Delay Random:** The factor used to limit the range of retry delay randomization.
- **Purge Processed:** Indicates if automatic purging of messages that are processed successfully is enabled.

Detail Panel

Figure 7–10 MPS Work Type Detail Panel In Edit Mode

The screenshot shows a 'Detail Edit' window with the following controls:

- Buttons:** Edit, Apply, Cancel
- Fields:**
 - Retry Limit: 2
 - Retry Delay Secs: -1
 - Retry Delay Max. Secs: -1
 - Retry Delay Factor: -1
 - Retry Delay Random: -1
- Toggles:**
 - Purge Processed: No
 - Active: No

Detail Buttons

- **Edit:** Places the detail information displayed into edit mode.
- **Apply:** Applies the current data to the work type and updates the list information.
- **Cancel:** Places the panel back into display mode without applying the information.

Detail Attributes

- **Retry Limit:** The number of times to attempt to process a single message before marking it as failed. Zero indicates it should only be attempted once and will not be retried. A positive value indicates how many attempts to process the message should be made in addition to the original attempt.
- **Retry Delay Seconds:** The number of seconds between attempts to process a message. Zero indicates no delay whereas a value of 30 indicates 30 seconds between attempting to process the message. This value does not represent an absolute value as it used with other parameters below to produce a calculated message time delay.
- **Retry Delay Max Seconds:** This is the maximum number of seconds for a delay between processing messages. This caps the maximum value for the calculated delay.
- **Retry Delay Factor:** This attribute produces an increased delay between each retry of a failed message in the queue. It is a decimal value starting at 1.0 and increasing. If you enter 1.0, it means there will be no increase in the retry delay seconds during repeated attempts to process a message. A value of 1.5 indicates that the retry delay seconds will be 150% of the retry delay seconds on retry.

A linear delay of 1.0 can be used but may result in messages reaching their retry limit prior to any issues being resolved. A value of 1.5 or larger will produce an increased delay that may allow time for other dependent messages that could be holding up execution to arrive.

- **Retry Delay Random:** Defines the amount of the delay to increase or decrease by a random amount. It accepts values from 0.0 to 1.0. A value of 0.0 disables random variation of the delay. A value of 0.5 indicates the calculated delay may be

randomly altered by up to 50% of its value whereas 1.0 indicates it could be randomly altered up to 100% of its value. It is recommended to use at least some small random variation to improve message throughout as this will reduce resource contention and help avoid timing issues.

- **Notes:** The parameters are applied to retries in the following manner. The retry delay seconds is first increased by the retry delay factor, then the retry delay max seconds is applied, and finally the random delay is added or subtracted to determine the final number of seconds to wait between message processing attempts.
- **Purge Processed:** Switch to enable/disable automatic purge of messages that are processed successfully.
- **Active:** Switch to enable/disable a work type.

POS Transaction Resolution

The POS Transaction Resolution dialog is used to view the list of Troubled POS transactions that are not processed in the system due to various data issues in the inbound data. The interface allows the user to edit the unrestricted data fields to rectify the data and let the system to process the transaction and resolve.

This dialog is mostly used by technical members to resolve the POS transactions that are in trouble.

Based on the nature of the field and to maintain the integrity of the data, the system allows the user to modify certain fields and update the transactions.

Figure 7–11 POS Transaction Resolution List

ID	Request ID	Date	Transaction Type	Source Type	Transaction ID	Item	Description	Quantity	UOM
7233	5801	4/17/21	Sale	POS	42	100000024	Washing Machine	3	Cases
7234	5801	4/17/21	Sale	POS	42	100000112	Test Item 100000112	9,999,999	Cases
7235	5801	4/17/21	Sale	POS	42	100000059	Washing Machine	3	Cases
7236	5801	4/17/21	Sale	POS	42	100000083	Test Item 100000083	3	Cases
7127	5706	4/8/21	Sale	POS	38	100000112	Test Item 100000112	3	Cases
7128	5706	4/8/21	Sale	POS	38	100000059	Washing Machine	3	Cases
7130	5707	4/8/21	Sale	POS	39	100000024	Washing Machine	3	Cases
7131	5707	4/8/21	Sale	POS	39	100000112	Test Item 100000112	3	Cases
7132	5707	4/8/21	Sale	POS	39	100000059	Washing Machine	3	Cases
7225	5799	4/8/21	Sale	POS	40	100000024	Washing Machine	3	Cases
7226	5799	4/8/21	Sale	POS	40	100000112	Test Item 100000112	3	Cases
7227	5799	4/8/21	Sale	POS	40	100000059	Washing Machine	3	Cases
7228	5799	4/8/21	Sale	POS	40	100000083	Test Item 100000083	3	Cases
7231	5800	4/8/21	Sale	POS	41	100000059	Washing Machine	3	Cases

The POS Transaction Resolution List screen appears when the user selects the POS Transaction Resolution menu from the Admin/Technical Maintenance.

When the user enters this screen, the system set the search criteria to current date and displays the current day failed transactions that can be resolved.

The user can select the search option to refine the search by providing the search criteria.

The retry option allows the user to retry processing a selected transaction. The user must select a row and the system will process the complete transaction of the selected block id.

Selecting the link on the item will take the user to the item detail screen for that item. On this screen, the list shows the details of the transaction for the user to know and act.

Figure 7-12 POS Transaction Resolution List Search Criteria

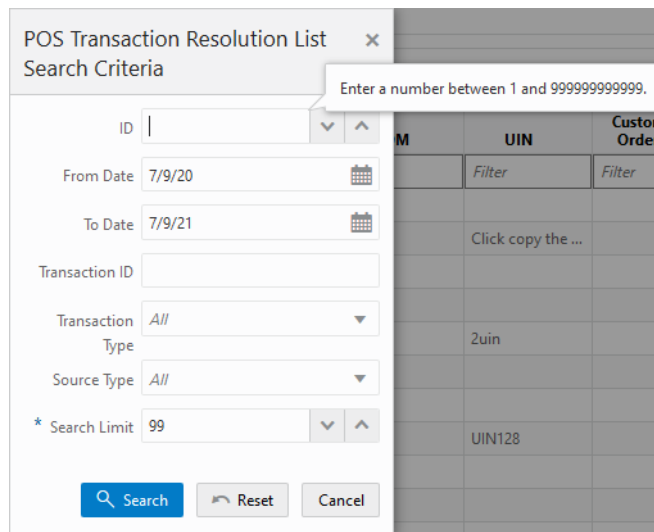

This search criteria screen can be used to filter the records based on the given criteria. By default, the system sets the date range for the current day and allows the user to set various criteria to search the failed POS transactions. The data on the list screen is shown based on the criteria provided.

Figure 7-13 POS Transaction Resolution Detail

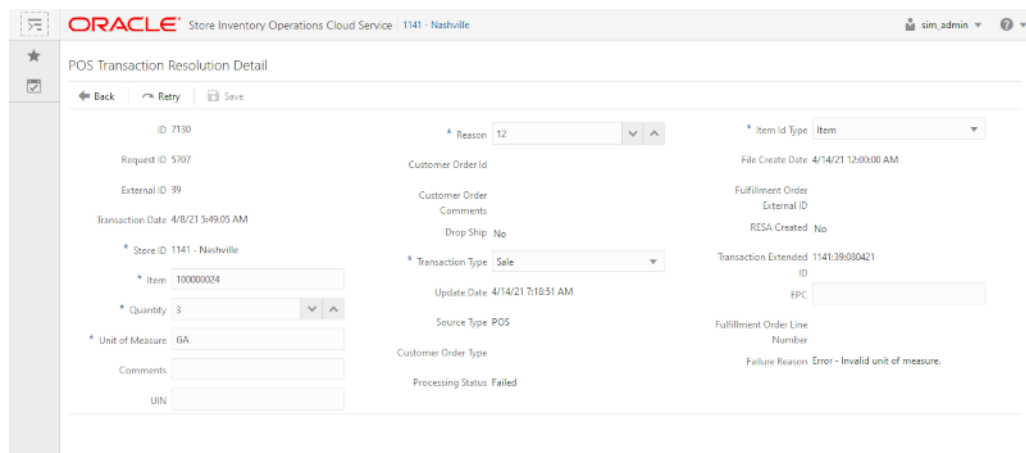

On the POS Transaction Resolution Detail screen, the system displays the transaction attributes of the selected transaction and allows the user to edit certain values and update the transaction.

Once the transaction is updated, the system will automatically retry and process it successfully if the system finds the transaction without any error.

The user must enter all the required fields on this screen.

Sequence Administration

The Sequence Administration screen is intended to be used for initial implementation between integration systems to split the sequence ranges between integrated applications.

If sequence reaches maximum value, the retailer would need to make decision if need to cycle the sequence and raise service request to have oracle DBA to alter the sequence.

To access this screen, user need to be assigned the following role/permission:

- **IDCS or OCI IAM app roles:** <SIOCS Primary APP>.admin_users
- **Security Permission:** Access Sequence Admin

Figure 7–14 Sequence Administration

Description	Current Sequence	Cache Size	Minimum Value	Maximum Value	Modified Start	Modified End	Update Date	Update User
DSD	287	20	1	999,999,999,999	287	999,999,999,999	6/7/21 1:52:49 AM	sim_qa5
DSD Carton	5,828	20	1	999,999,999,999	5,548	999,999,999,999	5/6/21 6:58:51 AM	sim_qa5
RTV	6,545	20	1	999,999,999,999,999	6,345	999,999,999,999,999	5/13/21 2:11:29 AM	sim_qa5
RTV Shipment	7,265	20	1	999,999,999,999,999	6,885	999,999,999,999,999	5/6/21 3:10:56 AM	sim_admin
RTV Shipment Carton	62,635	20	1	999,999,999,999,999	62,235	999,999,999,999,999	5/6/21 3:25:25 AM	sim_admin
Shipment BOL	17,251	20	1	999,999,999,999	16,451	999,999,999,998	5/5/21 3:22:45 AM	sim_qa3
Transfer	667	20	1	999,999,999,999,999	267	999,999,999,999,999	5/13/21 2:12:50 AM	sim_qa5
Transfer Delivery Carton	5,092	20	1	999,999,999,999,999	4,752	999,999,999,999,999	5/5/21 3:10:41 AM	sim_qa3
Transfer Shipment	9,545	20	1	999,999,999,999,999	9,065	999,999,999,999,997	5/5/21 2:47:30 AM	sim_qa3
Transfer Shipment Carton	8,451	20	1	999,999,999,999,999	7,971	999,999,999,999,998	5/5/21 2:54:06 AM	sim_qa3

List Buttons

- **Save:** Persists currently altered information.
- **Refresh:** Refreshes the screen with currently persisted information.

List Attributes

- **Description:** Description of the Sequence.
- **Current Sequence:** The last currently used number written to Database Disk (Including the sequence caching size).
- **Cache Size:** The number of sequences kept in DB cache.
- **Minimum Value:** The minimum value the sequence can become.
- **Maximum Value:** The maximum value the sequence can become.
- **Modified Start:** Retailer specified start number for the sequence.
- **Modified End:** Retailer specified end number for the sequence.
- **Update Date:** The last update date.
- **Update User:** The last update user.

Detail Panel

Figure 7–15 Sequence Administration Detail Panel In Edit Mode

Detail

Description DSD

Current Sequence 287

Cache Size 20

Minimum Value 1

Maximum Value 999999999999

Modified Start 287

Modified End 999,999,999,999

Detail Buttons

- **Edit:** Places the detail information displayed into edit mode.
- **Apply:** Applies the current data to the work type and updates the list information.
- **Cancel:** Places the panel back into display mode without applying the information.

Detail Attributes

- **Description:** Description of the sequence.
- **Current Sequence:** The last currently used number written to Database Disk (Including the sequence caching size).
- **Cache Size:** The number of sequences kept in DB cache.
- **Minimum Value:** The minimum value the sequence can become.
- **Maximum Value:** The maximum value the sequence can become.
- **Modified Start:** Retailer specified start number for the sequence.
- **Modified End:** Retailer specified end number for the sequence.

This section describes the integration through RIB, Batches and web services.

- [Overall Integration Touchpoints](#)
- [Retail Integration Cloud Service \(RICS\) - based Integration](#)
- [Batch Integration](#)
- [Web Services](#)
- [Sales Integration](#)
- [Integration with Manifesting Systems](#)
- [Integration for Ticket Printing](#)
- [Integration for Sales Forecast](#)
- [Integration for Store Order](#)
- [Retail Home Integration](#)

Overall Integration Touchpoints

Figure 8–1 Overall Integration Touchpoints

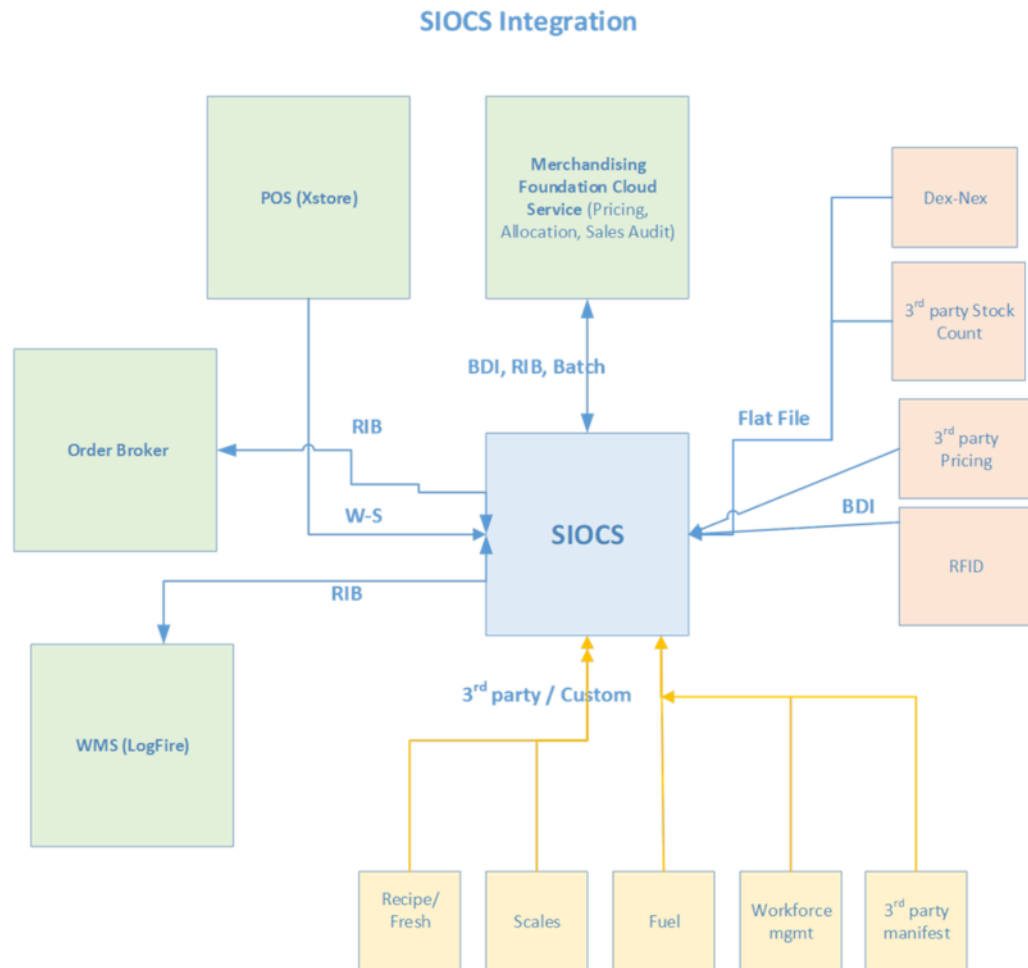

Retail Integration Cloud Service (RICS) - based Integration

RICS is a platform containing RIB and BDI.

- Customer Orders
- Picking
- Deliveries
- Reverse Picking
- Multi Leg
- RIB Payloads
- Purchase Orders and Vendor Deliveries
- Inventory Adjustments
- Items
- Stock Counts

- [Transfers](#)
- [Transfer Creation](#)
- [Transfer Messages](#)
- [Transfer Shipment Creation](#)
- [Transfer Receiving](#)
- [Transfer Doc](#)
- [Transfer Shipment](#)
- [Transfer Receiving](#)
- [Vendor Return](#)

Customer Orders

- Customer Order Create is used for Customer Orders that are a type of Web Order integrated through a message (FulfilOrdDesc). These integrations are used for the customer order from the Order Management System (OMS).
- The Customer Order Create failure message (FulfilOrdCfmDesc) is a message that will be sent out to external system when we get a Customer Order that comes into the system through the RIB and fails due to validation issues such as an invalid item. The purpose of the create failure is so other systems will know it has failed when it came in and that it is not being processed.
- The Stock Order Status message (SOStatusDesc) will be sent out with an SI upon reserving inventory for the customer order.

Picking

- A Stock Order Status message (SOStatusDesc) is sent out with a type of SI upon reserving inventory. This happens when more is picked than what was on the order due to tolerances. This could also occur when a substitute item is added during the picking process.
- The Stock Order Status message (SOStatusDesc) with a type of SD will be published to un-reserve the original items inventory when a substitute item has been added during picking.
- A Stock Order status message (SOStatusDesc) is sent out with a type of PP when picking is completed.
- Item Substitutes are sent to EICS from the merchandising system through the item message (ItemDesc).

Deliveries

- An ASN Out message (ASNOutDesc) is sent out upon dispatching of the Delivery. This will be done for pick-ups and for shipments.
- The Stock Order Status message (SOStatusDesc) with a type of PP will be published for the pick quantity in the scenario that more was delivered than what was picked.
- The Stock Order Status message (SOStatusDesc) with a type of SI will be published for the reserved quantity. This will occur when more was delivered than what was reserved. This can happen when picking was not required, the

reservation occurs upon receipt of a delivery, and the full amount had not been received, therefore not reserved.

Reverse Picking

- Customer Order Cancellations (FulfilOrdRef) will come into EICS from external system such as an OMS through the RIB. This service will perform all the validations to determine if it should create a reverse pick and whether that reverse pick should be auto completed.
- Customer Order Cancellation Confirmation (FulfilOrdRef) is a message to send to OMS upon completing of the system-generated reverse pick.
- Stock Order Status message (SOStatusDesc) with a type of SD will be published for the reserved quantity to un-reserve the inventory for the reverse pick for system-generated picks.
- Stock Order Status message (SOStatusDesc) with a type of PU will be published for the reverse picked quantity to un-pick the inventory for system-generated picks.

Multi Leg

The following integrations are in addition to the standard integrations that already exist such as receipt message, and so on:

- The Stock Order Status message (SOStatusDesc) with a type of SI will be published for the reserved quantity.
- The Stock Order Status message (SOStatusDesc) with type of PP will be published for the picked quantity.

RIB Payloads

RIB payloads are used to communicate information to external systems through RIB Integration.

RIB Payload	Description
FulfilOrdDesc	RIB payload that contains information about a new web order type of fulfillment order to be created in.
FulfilOrdCfmDesc	RIB payload sent from EICS that contains fulfillment order information when that order creating in EICS failed
FulfilOrdRef	RIB payload that contains information about a fulfillment order cancelation. It is sent to EICS to convey a cancelation request and sent from EICS to convey actual cancellations.
SOStatusDesc	Sent from EICS to convey changes in item status for a specific fulfillment order. Such changes of status include (un)reservation and (un)picking.
ASNOutDesc	Sent from EICS to convey a delivery for specified fulfillment order.

Purchase Orders and Vendor Deliveries

MERCHANDISING publishes the Purchase Orders created for the direct store deliveries using RIB messages. EICS subscribes to these messages and stores them in the EICS database to enable receipt against Purchase Orders.

MERCHANDISING publishes the unit cost of the item at the item/supplier/country level for EICS to use in the receiving process.

EICS publishes the receipts done against the Purchase Order to the merchandising system (Receiving message).

EICS publishes the DSD receipts created in EICS without a Purchase Order to the merchandising system (DSDReceipts and DSD Deals messages).

EICS publishes the receiver unit adjustment done for the deliveries that are already confirmed (receiving message).

EICS is also capable of subscribing to the vendor EDI ASNs through RIB using the ASN In message format.

RIB payloads are used to communicate information from EICS to external systems and from external system to EICS through RIB Integration.

RIB Payload (Subscriber)	Description
PORef	RIB payload that contains reference level information of a purchase order. This payload is used for removal of purchase orders.
PODesc	RIB payload that contains detailed information of a purchase order. This payload is used for creation and modification of purchase orders.
ASNInRef	RIB payload that contains reference level information of an ASN. This payload is used for removal of an ASN.
ASNInDesc	RIB payload that contains detailed information about the ASN. This payload is used for creation of a direct delivery (document type= 'P') or a warehouse delivery (document type= 'D'). EICS consumes this payload from warehouse when source and/or destination for ASN is a warehouse system.

RIB Payload	Description
ReceiptDesc	RIB payload that contains detailed information of the direct delivery receipt. This is published when the purchase order is not null. EICS also consumes this payload for warehouse receiving.
DSDReceiptDesc	RIB payload that contains detailed information of the direct delivery receipt. This is published when the purchase order is null.
SOStatusDesc	RIB payload sent from EICS to convey changes in item status for a specific fulfillment order. EICS also consumes this payload from warehouse for stock movements originating at the warehouse.
InvAdjustDesc	RIB payload that contains information about destination of the adjustment and an InvAdjustDtl.

Inventory Adjustments

Inventory adjustments integrate to MERCHANDISING at the item level using the RIB. EICS creates the adjustments and groups them together by a header with multiple items, but for integration purposes they are published out at an item level.

Inventory adjustments are published for all manual and external system generated adjustments where the Publish indicator for the reason code is checked. Adjustments are also published for other types of transactions in EICS where the merchandise system is expecting an adjustment for stock on hand updates, for example, receiving a DSD with damaged goods. An adjustment is created behind the scenes only for publishing purposes to notify the merchandising system to move the goods into the unavailable bucket. These system type adjustments are not considered an adjustment within EICS; however, they are published as such for integration purposes.

EICS subscribes to inventory adjustment messages from warehouse systems and updates the warehouse inventory buckets in EICS.

RIB payloads are used to communicate to external systems through RIB Integration.

The following table shows the list of RIB Payloads available for inventory adjustments.

RIB Payload	Description
InvAdjustDesc	RIB payload that contains information about destination of the adjustment and an InvAdjustDtl.
InvAdjustDtl	Contains detailed information about the item adjustment.

Items

Items come to EICS from a merchandising system through the RIB (items, item loc messages). EICS also gets information about items associated to a supplier through the RIB. Extended attributes are not received or sent on RIB payloads.

RIB Payload	Description
ItemDesc	This payload contains information about an item. It contains a wide variety of information about the item including suppliers, UPCs, ticketing information, image information, UDAs, and related items
ItemLocDesc	This payload contains information about an item at a specific location.
ItemSupDesc	This payload contains information about an item for a specific supplier.
ItemSupCtyDesc	This payload contains information about an item for a specific supplier within a specific country.

Stock Counts

Stock counts generate inventory adjustment when completed.

RIB payloads are used to communicate to external systems through RIB.

RIB Payload	Description
InvAdjustDesc	RIB payload that contains information about destination of the adjustment and an InvAdjustDtl.
InvAdjustDtl	Contains detailed information about the item adjustment.

EICS does not integrate using a web service to any other Oracle Retail products for stock counts.

Transfers

The Transfer Shipping allows for creating shipment, dispatching shipment, canceling shipment, creating container, approving container, adjusting container, and canceling the container.

The Transfer Receiving dialog allows for confirming receipt, copying misdirected container, receiving container and detailed receiving.

This section covers creating transfer documents which are then included in a transfer shipment and dispatched to another store, warehouse, or finisher.

Transfer Creation

Transfer documents can be created in the following ways:

- Requesting store can create a transfer request.
- Sending store can initiate a transfer by creating a transfer.
- Merchandising can create a transfer request.

Each transfer document will have one or more items.

Transfer Messages

EICS will publish messages to Merchandising when the following happen:

- Transfer is rejected.
- Transfer is approved.
- Transfer quantity is updated from the shipment.

Transfer Shipment Creation

Transfer Shipment describes the containers and the items for the shipment taking place. The shipment may be for one or more transfer documents if the transfer is going to the same destination. Dispatching a shipment will update the transfer document.

The user can create a shipment without referencing existing transfers or can create a new transfer on fly (Ad hoc transfer) based on the shipment information.

Transfer Receiving

This transaction captures a delivery that took place from a warehouse, store, or finisher to the store receiving the delivery. It describes the containers and the items of the delivery that should be received by the store. Receiving a container of the delivery will update the transfer document.

Figure 8–2 Transfer Request Flow

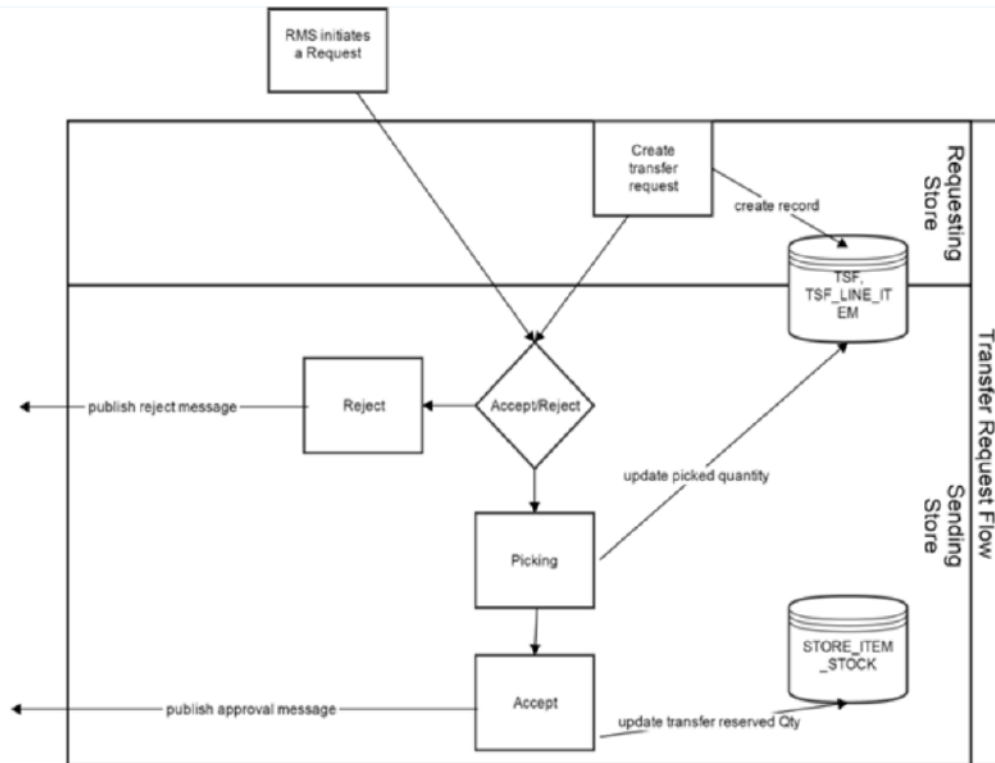

Figure 8–3 Transfer Create Flow

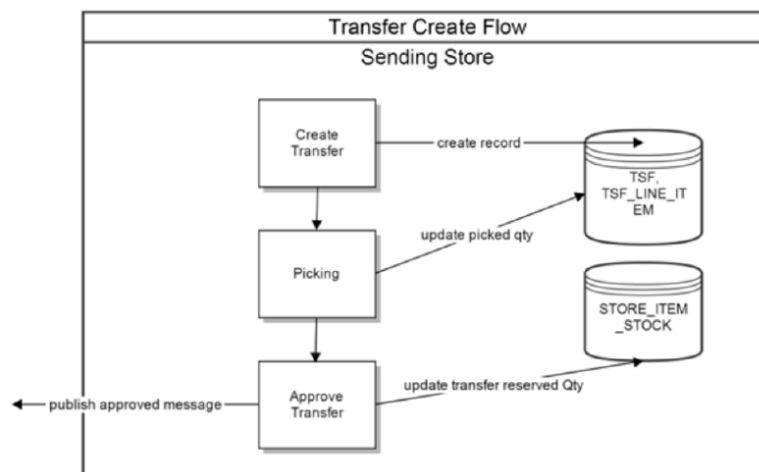

Figure 8-4 Transfer Shipment Creation Flow

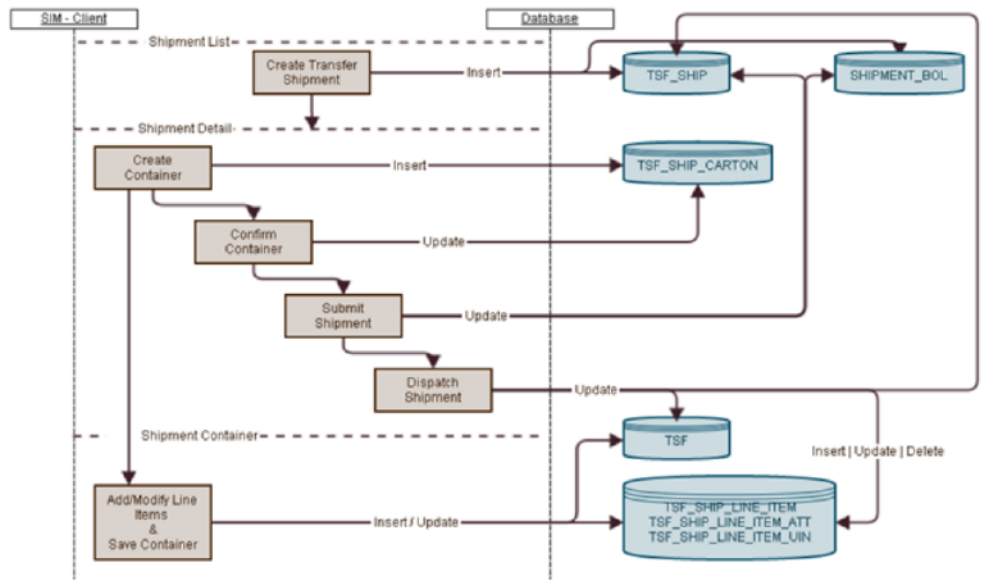
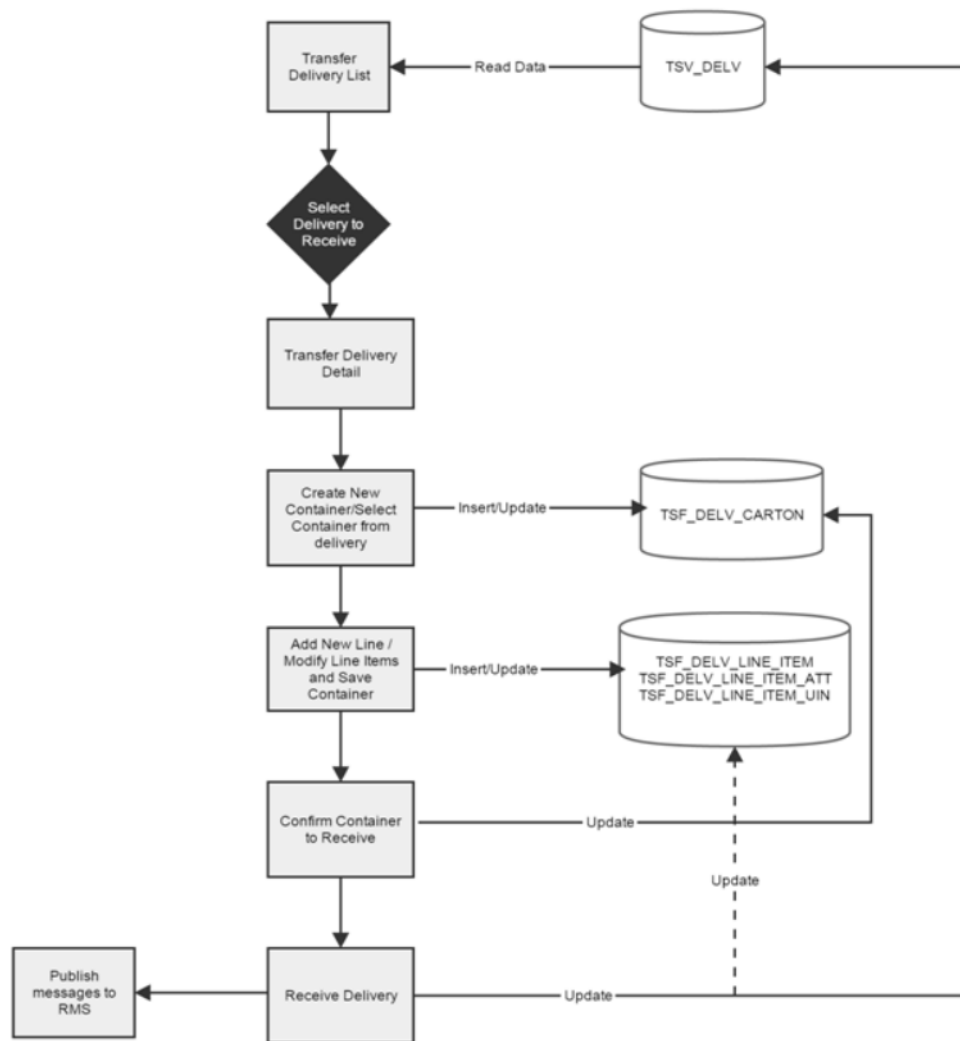

Figure 8-5 Transfer Receiving Process Flow

Transfer Doc

RIB Payload	Description
SODesc	This message is received from external systems when a stock order/transfer has been created
SOStatusDesc	This message is received from external systems when a stock order/transfer has been modified.
SORef	This message is received from external systems when a stock order/transfer has been deleted.

Transfer Shipment

RIB Payload	Description
ASNOutDesc	This message is sent to external systems when the transfer shipment is dispatched.
ManifestCloseVo	This message is received from an external system to indicate physical shipment has been accepted. This will attempt to auto close the transfer shipment if all items are shipped.
ManifestDesc	This message is sent to an external system when manifesting is activated, and a transfer shipping container is confirmed.
ShipInfoDesc	This message is sent to an external system when pre-shipment notifications are active, and a transfer shipment is either submitted or dispatched (without previously being submitted).
SOStatusDesc	This message is sent to an external system when a transfer shipment container is saved with shipping quantities. It is also sent when a transfer shipment container is canceled but had shipping quantities. Increase and decrease of quantities is indicated by the SI or SD codes.

Transfer Receiving

RIB Payload	Description
ASNInDesc	Sent from external system to indicate a delivery is tracking place. It creates a transfer delivery record within EICS when a store location is involved.
ReceiptDesc	Sent to external system when a transfer delivery is confirmed. Sent from external warehouse system when a transfer delivery is received at the warehouse.

Vendor Return

RTV Creation

RTVs can only be created by a request from MERCHANDISING:

Each vendor return will have one or more items.

RTV Shipment

Each RTV shipment will tie back to a single vendor return document.

RTV shipment can be created in two ways:

- From an externally initiated approved vendor return document.
- Creation of ad hoc vendor return shipment which will create an approved vendor return on the fly.

Each vendor return shipment will have one or more containers; each container in turn will have one or more items.

EICS may publish messages when the following happens:

- RTV shipment container is updated, and saved (Return To Vendor Publish)

- RTV shipment is cancelled or rejected (Return To Vendor Publish)
- RTV shipment is dispatched (Return to Vendor Publish and Ship Info Desc Publish, if dispatched without submitting)
- RTV shipment is submitted (Ship Info Desc Publish)
- RTV shipment container is confirmed (RTV manifesting, if configured)
- RTV shipment is submitted (Pre-shipment notification, if configured)

Figure 8–6 RTV Creation Flow

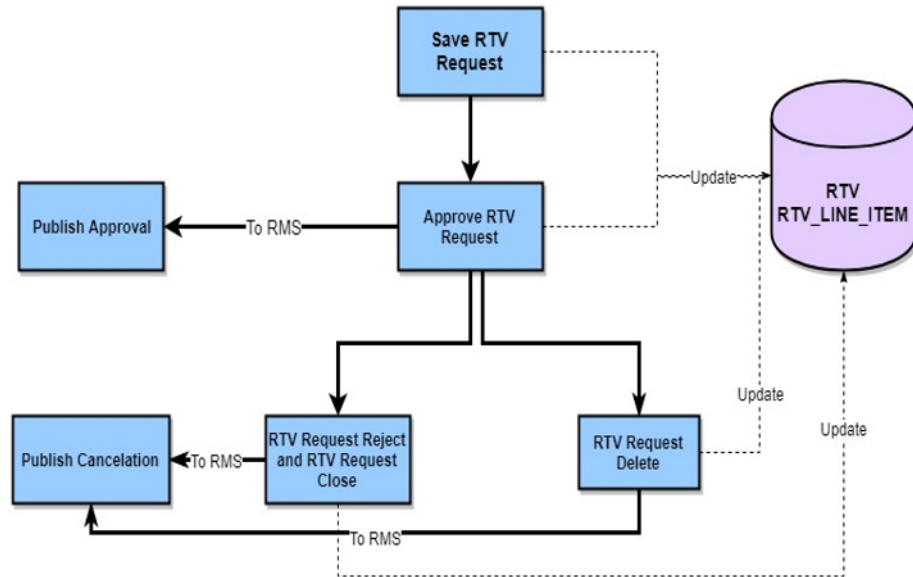

Figure 8-7 RTV Shipment Flow

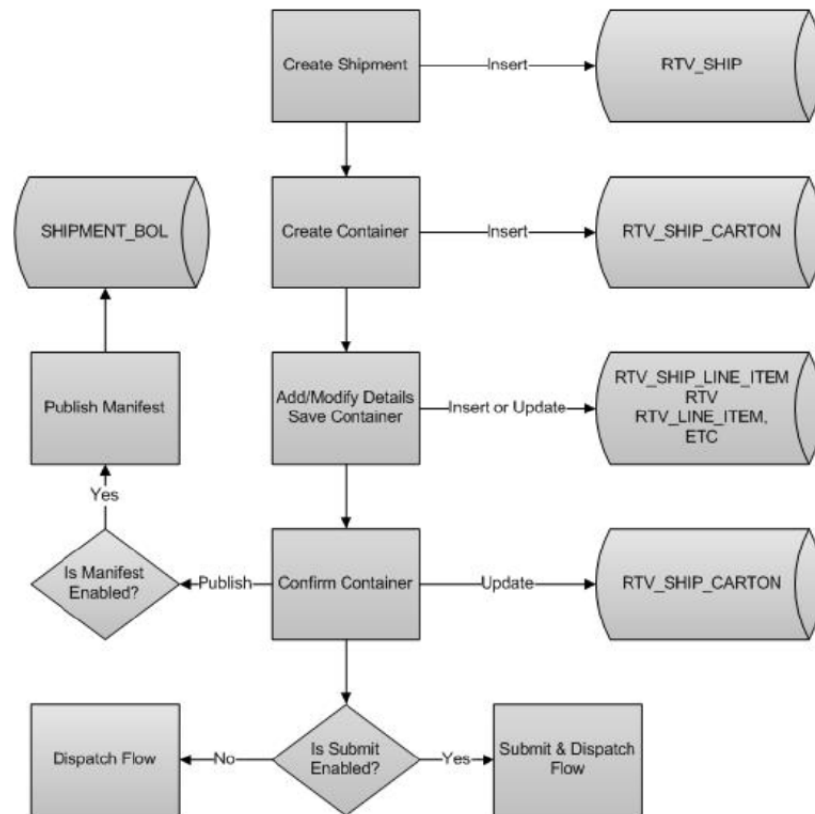

Figure 8-8 RTV Shipment Submit and Dispatch Flow

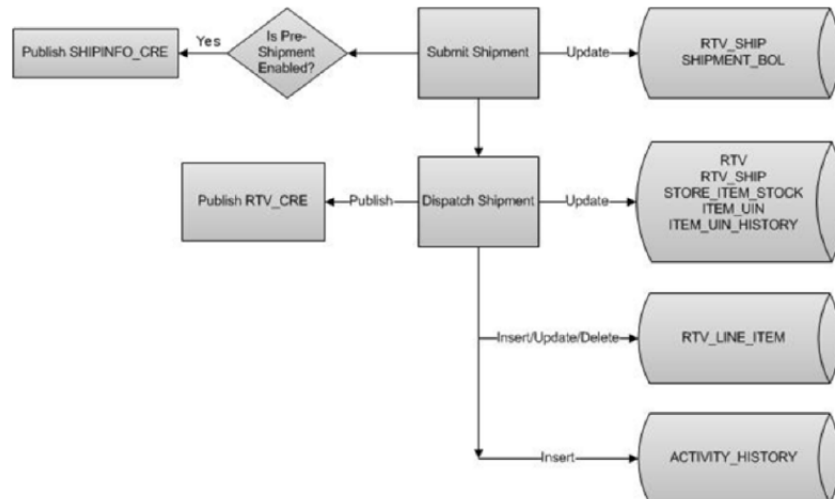
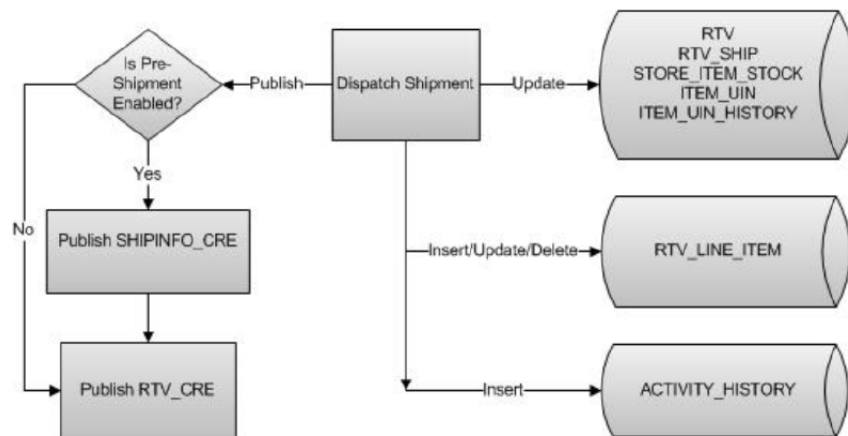

Figure 8–9 RTV Shipment Dispatch Flow

The following payloads are used in RTV operations.

RIB Payload	Description
RTVReqDesc	This payload is sent from an external system to indicate a request for a vendor return. It creates or updates a vendor return document within EICS. It contains a series of RTVReqDtl.
RTVReqDtl	This payload contains the detailed information about the items on the vendor return.
RTVReqRef	This payload contains reference information about a vendor return when an external system wishes to attempt to cancel the return.
RTVDesc	This payload is sent from EICS to external systems when an RTV shipment is dispatched. This payload is sent from external warehouse system for vendor returns originating at warehouse.

Batch Integration

This section contains the following:

- [Overview](#)
- [BDI-Based Batch Integration](#)
- [SFTP-Based Batch File Integration](#)

Overview

Batch bulk data is still a predominant integration style within Oracle Retail and its customers. Currently SIOCS bulk data integrations are implemented as BDI-Based batch integration or SFTP-Based batch integration.

BDI-Based Batch Integration

Oracle BDI (Bulk Data Integration) is the latest Oracle Retail Integration tool for bulk data movement. The BDI infrastructure applications move data from one application to another. So, there is data producing applications and data consuming applications.

Figure 8–10 BDI-Based Batch Integration Process

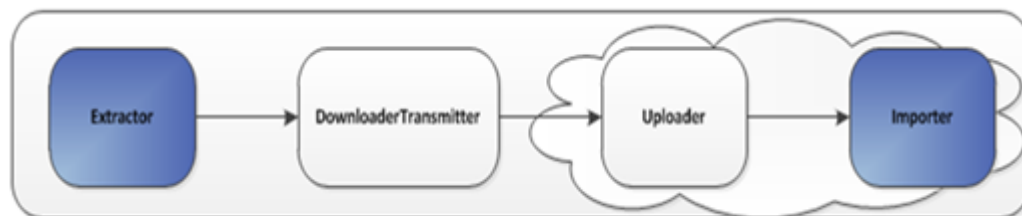

The BDI process:

- An Extractor extracts data from a data producing system into an outgoing intermediate integration interface table.
- A Downloader and transporter services data to receiver service.
- An Uploader uploads the data to an incoming intermediate integration interface table.
- An Importer imports the data from the interface stage tables into SIOCS application tables.

For more information about data seeding, see the *Oracle® Retail Enterprise Inventory Cloud Service Administration Guide*.

Initial Foundation Data Seeding

Using BDI (Bulk Data Integration) Process Flow, you can load foundation data in bulk, including inventory and stock holding entities, from a data producing system into Oracle SIOCS.

Data Seeding is most suitable for:

- Loading initial inventory holding data
- Loading large volumes of data

Typically, you use data seeding for an initial data seeding and maintain the data in SIOCS thereafter, or through near-real time data integration with data producing system systems.

Table 8–1 BDI Foundation Data Seeding Integration Object List

Business Object	Inbound/Outbound	Source/Destination
Code Detail	Inbound	RMFCS
Code Head	Inbound	RMFCS
Delivery Slot	Inbound	RMFCS
Differentiator Group	Inbound	RMFCS
Differentiator	Inbound	RMFCS
Item Header	Inbound	RMFCS
Item Image	Inbound	RMFCS
Item Location	Inbound	RMFCS
Inventory Available Store	Inbound	RMFCS
Item Supplier	Inbound	RMFCS
Item Supplier Country Dimension	Inbound	RMFCS
Item Supplier Country	Inbound	RMFCS
Item Supplier Manufacturing Country	Inbound	RMFCS
Item Supplier UOM	Inbound	RMFCS
Merchandise Hierarchy	Inbound	RMFCS
Partner	Inbound	RMFCS
Partner Address	Inbound	RMFCS
Partner Org Unit	Inbound	RMFCS
Price History	Inbound	RMFCS
Pack Item	Inbound	RMFCS
Related Item	Inbound	RMFCS
Replenishment Item Location	Inbound	RMFCS
Supplier	Inbound	RMFCS
Supplier Address	Inbound	RMFCS
Store	Inbound	RMFCS
Store Address	Inbound	RMFCS
UDA	Inbound	RMFCS
UDA Item Date	Inbound	RMFCS
UDA Item Free Form	Inbound	RMFCS
UDA Item LOV	Inbound	RMFCS
UDA Values	Inbound	RMFCS
UOM Class	Inbound	RMFCS
UOM Conversion	Inbound	RMFCS
Warehouse	Inbound	RMFCS

Table 8–1 (Cont.) BDI Foundation Data Seeding Integration Object List

Business Object	Inbound/Outbound	Source/Destination
Warehouse Address	Inbound	RMFCS

Recurring BDI Transaction Batches

BDI Transaction batches are recurring batches to move bulk data between integrated applications. You can use BDI Scheduler to schedule selective transaction data batches. For details, please see *Oracle Retail Bulk Data Integration Implementation Guide*.

Table 8–2 BDI Transaction Batch List

Batch Name	Source/ Destination
Clearance TX Import	RPCS
Price Change TX Import	RPCS
Promotion TX Import	RPCS
Inventory Available Warehouse TX Import	RPCS

Transfer Transaction Import

Purchase Order Transaction Import

Clearance TX	Import clearance price from Oracle Retail Pricing Cloud Service via BDI Process Flow.
Price Change TX	Import clearance price from Oracle Retail Pricing Cloud Service via BDI Process Flow.
Promotion TX	Import promotion from Oracle Retail Pricing Cloud Service via BDI Process Flow.
Inventory Available Warehouse TX	Import warehouse available inventory from third-party via BDI Process Flow.

BDI Transmitter CLI - Client Batch File Loader

The BDI CLI Transmitter is a standalone command line tool to transmit batch interface data files to a destination BDI receiver system.

It is particularly used where the source system is non-BDI (that is, the source system does not have or use BDI Batch Job Admin application) but needs to send interface data files to a receiver system running the BDI Job Admin application.

The tool uses the BDI Job Admin Receiver REST service URL to transmit the data to the destination system. So, it is necessary that the destination system runs the BDI Job Admin application to use the tool.

Note: When use BDI Transmitter CLI tool to integrate with EICS, the app name for EICS in BDI is called SIM (Store Inventory Management).

The following figure illustrates the basic process for importing data using the BDI Transmitter CLI and EICS importer.

Figure 8–11 BDI Transmitter CLI

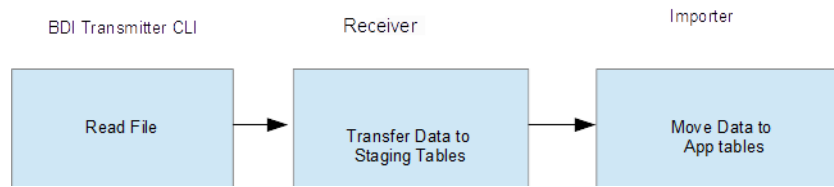

The BDI Transmitter CLI client tool process the data files from client machine, and load data into receiver application's staging inbound tables. The transmitter tool only load data into the Receiver's staging tables. To move data from receiver's staging tables into application's tables, you can use schedule EICS importer job to import the data from staging tables into EICS application tables.

Following is a list of batch file import implementations using BDI Transmitter CLI tool, alternatively the BDI External Process Flow can be chosen by integration implementation consultant, please see *Oracle Retail Bulk Data Integration Implementation Guide*.

Table 8–3 BDI Transmitter CLI List

Batch Name	Description	Source/ Destination
External Price TX Import	Import pricing data from external source into EICS, you can use BDI CLI Transmitter client tool to load CVS data file into BDI inbound interface tables, then setup SIOCS Batch job schedule to import data from inbound interface tables into EICS application tables. For additional detail, please see Appendix: BDI Transmitter CLI Procedure - Load External Data File .	Third Party
External RFID TX Import	Import RFID data from external source, typically this can be implemented using BDI External Process Flow when external system implemented BDI Job Admin; alternatively, you can use BDI CLI Transmitter for CVS data file. For additional detail, please see Appendix: BDI Transmitter CLI Procedure - Load External Data File .	Third Party
Direct Delivery Transaction Import	Initial Seed Open Direct Delivery from External System. See Appendix: Open Transaction Seeding via BDI for details.	Third Party
Purchase Transaction Import	Initial Seed Open Purchase Order from External System. See Appendix: Open Transaction Seeding via BDI for details.	Third Party
Transfer Transaction Import	Initial Seed Open Transfer from External System. See Appendix: Open Transaction Seeding via BDI for details.	Third Party

SFTP-Based Batch File Integration

In additional to BDI-Based Batch to move data between applications, EICS also supports SFTP-Based Batch File Integrations for list of batch modules. For additional detail, please see [File Processing](#) and [SFTP Nightly Batch File Uploads](#).

SFTP-Based Batch File Integration Modules:

Table 8–4 SFTP-Based Batch File Integration Modules

Object Name	Description	Source/Destination
POS Transaction Import	This batch imports POS Transaction records from the flat file that came from POS into the database staging table where polling timer framework will pick those staged requests and update the stock tables.	External POS
Retail Sale Audit Import	This batch program imports sales/order transaction data (SIM-ReSA file) that originated in Oracle Retail Xstore Point of Service. The batch also writes each failure record into a transaction log table.	ReSA
Store Sequence Import	This batch file import sequencing information like store sequence areas and items mapped to those areas from a flat file.	Third Party
Warehouse Item Stock Import	This batch imports the inventory of an items in a warehouse from flat files into warehouse item table.	Third Party
Inventory Extract	This batch extracts the inventory to a file that has been altered on or after the specified date for the specified store. The store id is not mandatory for the batch process. In case store id is not passed the files will be generated per store. The scheduled job will always generate files for all stores.	Order Broker
Stock Count Export	The stock count export files are generated when unit amount stock count is authorized.	Third Party
Clearance Price Change Import with On-prem RPM	<p>This batch process imports the clearance price changes from flat files into item price table. Application uses this data to update price information of the items.</p> <p>For details, see Appendix: Pricing Import with On-premise RPM.</p> <p>This batch will be phased out in future release.</p> <p>For Clearance pricing integration with RPCS, see Clearance Transaction Import</p>	On-prem RPM
Promotion Price Change Import with On-prem RPM	<p>This batch process imports the promotion price changes from flat files into item price table. Application uses this data to update price information of the items.</p> <p>For details, see Appendix: Pricing Import with On-premise RPM.</p> <p>This batch will be phased out in future release.</p> <p>For cloud promotion Pricing Integration, see Third Party Pricing Import</p>	On-prem RPM

Table 8–4 (Cont.) SFTP-Based Batch File Integration Modules

Object Name	Description	Source/Destination
Regular Price Change Import with On-prem RPM	<p>This batch process imports the price changes from flat files into item price table. Application uses this data to update price information of the items.</p> <p>For details, see Appendix: Pricing Import with On-premise RPM.</p> <p>This batch will be phased out in future release.</p> <p>For cloud Pricing Integration, see Price Change Transaction Import</p>	On-prem RPM

Web Services

EICS provides a large range of web services to manage the processing of information that is controlled within EICS. Each web service covers a topical area of functionality within EICS and contains numerous operations within to accomplish this functionality. This document is only meant as an outline or summary into using EICS web services and assumes the user has access to the fully documented APIs through the publishing of the web services themselves.

- [Security Considerations](#)
- [Functionality](#)
- [Available Web Services](#)
- [Web Services Basic Design Principles](#)
- [Internally Managed vs Externally Managed](#)
- [Web Service Operation Basic Design Standards](#)
- [Interpreting Validation Errors](#)

Note: The WSDL files are available to download from My Oracle Support (MOS) Document 2614551.1.

Security Considerations

Customers should create IDCS or OCI IAM user and the user should be assigned integration_users IDCS or OCI IAM application role to access the web-service endpoints.

See *Oracle Retail Enterprise Inventory Cloud Service Security Guide* and *Oracle Retail Enterprise Inventory Cloud Service User Guide - Security* chapter.

Functionality

This document is intended to be used by someone who has read and understands all the functional areas and business functionality described in the *Oracle Retail EICS User Guide* and *Oracle Retail EICS Administration Guide*.

Available Web Services

The following list contains a summary of the web services available in EICS.

Web Service	Description
ActivityLock	This service is used to manage the locking of data within EICS. Data needs to be locked to be updated securely.
FulfillmentOrderDelivery	This service is used to manage fulfillment order deliveries (outgoing shipment to customers). It allows the creation, cancellation and dispatch of deliveries.
FulfillmentOrderPick	This service is used to manage fulfillment order picking within EICS. It allows the creation, deletion and confirmation of a pick to complete a fulfillment order.
FulfillmentOrderReversePick	This service is used to manage fulfillment order reverse picking within EICS. It allows the creation, update, deletion and confirmation of a reverse pick.
InventoryAdjustment	This service is used to manage inventory adjustments within EICS. It allows the creation, update, cancellation and confirmation of inventory adjustments.
ItemBasket	This service is used to manage item baskets within EICS. It allows the creation, update, and removal of item baskets.
OrderRequest	This service is used to create, read, update, approve, cancel and lookup store orders.
POSTransaction	This service processes external point-of-sale transactions updating the inventory accordingly. A point-of-sale is considered an externally managed transaction (internally and externally managed transaction are covered later in this document).
ProductGroup	This service is used to create or update a product group.
ProductGroupSchedule	This service is used to create, update, or cancel a product group schedule.
ReplenishmentGap	This service is used to create, update, or delete a replenishment gap.
RfidInventory	This service is used to create, update or delete a RFID facility zone. It is also used to refresh inventory and to process RFID events.
ShelfAdjustment	This service is used to create, update, cancel or confirm a shelf adjustment.
ShelfReplenishment	This service is used to create, update, cancel or confirm a shelf replenishment.
StockCount	This service is used to retrieve the details of a stock count or a stock count child (section of stock count).
Store	This service is used to retrieve information about stores such as store detail, associated stores, or transfer zones.
StoreFulfillmentOrder	This service is used to manage fulfillment orders within EICS. It allows for the cancellation and rejection of orders and items.
StoreInventory	This service is used to lookup information about inventory positions and has several different operations to do so.
StoreInventoryUIN	This service is used to create, update, generate or read a UINs.
StoreInventoryISN	This service is used to create, update or delete ISN data in EICS.

Web Service	Description
StoreItem	This service is used to lookup various information about an item within the store.
StoreItemPrice	This service is used to lookup prices about items within a store.
StoreNotification	This service is used to create new notifications within the system.
StoreShipmentManifest	This service is used to close documents based on shipped container information.
StoreShipmentReason	This service is used to retrieve shipment reasons codes to use when creating shipments.
StoreTicket	This service is used to create tickets and lookup ticket formats.
StoreTransfer	This service is used to create, update and request a transfer, which describes the intent to ship items to another store or to a warehouse. It is also used to approve or reject that request. It can be used to directly create, update, approve, cancel, or close an actual transfer.
TransferDelivery	This service is used to update, receive, or confirm a transfer delivery (delivery arriving from another store or warehouse). It is also used to create, update, receive, cancel, or confirm the containers on that delivery.
TransferShipment	This service is used to create, update, submit, or dispatch a transfer shipment (shipment going out to another store or warehouse). It is also used to create, update, cancel, or confirm the containers on that shipment.
VendorDelivery	This service is used to update, receive, reject, or confirm a vendor delivery (delivery arriving from a supplier). It is also used to create, update, cancel, or confirm the containers on that delivery.
VendorReturn	This service is used to create, update, approve, cancel, or close a vendor return document, which describes the intent to ship items to a supplier.
VendorShipment	This service is used to create, update, open, submit, cancel submit or dispatch a vendor shipment (outgoing shipment to a supplier). It is also used to create, update, cancel, submit or confirm the containers on that shipment.

Web Services Basic Design Principles

Empty Response

In the cast that a web service does not return any information (an empty list), the external system needs to understand that this is a valid response that indicates no item, transaction or queried information was found or retrieved. For example, performing a lookup in which the search criteria entered matched no input.

Error Return Key

Errors returned through a web service will be in the form of a key. This key should be translated into correct language and verbiage by the external system. EICS will not do this translation or provide English verbiage for the encountered web service error.

Boolean Data Type

If a Boolean is the data type on the interface to EICS, and no value is provided, EICS will default the value to False.

Configured System Options in EICS

Web services apply system configurations to the request that are coming in through the web service but assumes that all input validation that requires user interaction to confirm has been completed by the access or of the web service. This system configuration user-interaction option will be assumed to have been confirmed during the web service processing. In case the system option is a fixed restriction that does not require user interaction, and the input fails this restriction, the web service will return an error. For example:

- Shipping inventory when inventory is less than 0 can be allowed by the user of EICS. The web service assumes that the third-party application did prompt the user or that their business always allows the user to do this activity.
- Adding a non-ranged item requires both a system configuration option to be enabled and the user to confirm the process. If the system configuration does not allow it, the web service will block the transaction and return an error. If the system configuration does allow adding non-ranged items, it is automatically assumed that a user confirmed its addition, and the web service adds the item.
- Allowing Receiver Unit Adjustments are dependent on a period of time. If a receiver unit adjustment were to come into EICS after that period of time, it would automatically be rejected, and the web service would return an error regardless of presentation or confirmation of user done by the external system.

Internally Managed vs Externally Managed

Internally Initiated

Internally initiated indicates the EICS was responsible for the original creation of the transaction being processed. A web service that creates a new transaction within EICS to be managed creates an internally initiated transaction.

Externally Initiated

Externally initiated indicates that another system created the transaction, has information about it, and notifies EICS of its creation through a notification system, not by requesting EICS create new information. EICS might manage the data after the notification but did not create the data.

Internally Managed

Internally managed data is information in which EICS is responsible for tracking its state and processing its life cycle. Our deliveries and shipments are primary examples of this. They may be externally initiated or internally initiated, but either way, they are internally managed. EICS is responsible for approving, picking, packing, manifesting, and dispatching the system and internally manages that process.

Externally Managed

Externally managed data is information that EICS does not process or track and is simply informed about after the externally managed data is complete. Point-of-sale transactions are a perfect example of this. We do not manage the sale, but once it is complete, EICS is notified and adjusts the inventory accordingly.

Web Services

EICS web services are intended for integration in order to allow a system using those services to control the flow and processing within EICS. Our web services are primarily designed (almost all of them) to internally manage the information. The

services are intended to be used real time with the steps such as approving, picking, and dispatching occurring with real time access to EICS web services while the process is happening.

EICS web services are not designed for externally managed information. If a system is controlling the state managements itself and not informing EICS until later, this will produce out-of-sync inventory. For example, if you create a shipment, pack the shipment, and send it out and then a day later use the web service, to create, update, and dispatch the shipment, all dates and processing of inventory movements will be tagged with the later date as if they occurred real time when the web service is used.

The point-of-sale service is an externally managed service, where the timestamp on the service can be any date and EICS handles the logic of dating things according to that timestamp. Inventory Adjustment also has an "adjustment date" which represents the time the adjustment took place and so the movement of inventory can be controlled externally.

Web Service Operation Basic Design Standards

This section discusses the general approach and design standards for naming and intent regarding operations within a web service.

Lookup

Lookup operations take either an identifier of a set of criteria and find all the relevant records associated to it. A thin or light view of the data being asked for is returned giving reference to information you can do further interrogation on.

Read

Read operations take an identifier and return all relevant information to it. It may only be one level, however. For example, reading a transfer shipment returns only all the information at the shipment level and does not read information at the container or item level. Usually, the entity that contains items will also retrieve the items. Reading a container will return the container information and the item information within.

Create

Create usually inserts and generates something new and returns an identifier, reference, or handler to that information. Create normally does not take a great deal of information, such as items or anything, but rather gives you a set of IDs that then lets you update the transaction with that reference.

Save or Update

Save or update is used to modify the data usually without changing state on the transaction. The save or update operation is used to add items, remove items, edit attributes, change quantities and all the other tasks one does during a process.

Approve, Cancel, Confirm or Dispatch

Activities that change state take in a simple identifier and then process that state change. To dispatch a shipment, you pass in a reference only to the shipment and it becomes shipped, updating the inventory. This means all changes are done through the save operations prior to making the state change.

Interpreting Validation Errors

If some data could not be processed, the web service will return a fault or a validation fault. The general form that a fault will take is to be a series of problem detail nodes containing a key and value that describes the fault. The first problem detail node will have the key `ERROR` and the value will be a description of the error type such as `INVALID_INPUT`. This will be followed by a series of nodes where the `KEY` is an object class name (ex: `Transfer`) and the value is its identifier (ex: `123`) describing the hierarchy of data the error took place in. For example, a transfer container fault would have two nodes (`Transfer:123`) and then (`TransferCarton:456`). If a specific attribute is known, the final node in any problem detail series is will have the key `ATTRIBUTE` and the value will be the name of the attribute of the error (ex: `ITEM_ID:A5X`).

Problem Detail Name	Value
<code>ERROR</code>	This describes the error (for example: <code>INVALID_INPUT</code>)
<code>ATTRIBUTE</code>	Identifies the specific attribute that had an error.

EICS follows the same business rules when processing information from a web service as it does from any of its clients, so the same business rules and functionality that exist in the User's Guide also exists for the web service. Understanding the basic functionality will help interpret why the validation or processing error occurred.

Common Error Codes

The following codes are paired as values to the `ERROR` Key:

Error Code	Description
<code>ACTIVITY_LOCK_NOT_GRANTED</code>	Indicates that a requested activity lock on a piece of data was not granted.
<code>DUPLICATE_INPUT</code>	Indicates the service would create a duplication of input that should be unique.
<code>INVALID_DATE_RANGE</code>	Indicates the end date of a date range is prior to the start date.
<code>INVALID_INPUT</code>	Indicates that the input is invalid. This error is usually followed by object and attribute information.
<code>INVALID_ITEM</code>	Indicates the item does not exist in the system.
<code>INVALID_STATE_FOR_UPDATE</code>	Indicates the transaction or data specified is not in a state that allows it to be updated (such as canceled).
<code>INPUT_MISMATCH</code>	Indicates the input to the web service has been altered incorrectly when compared to existing data. For example, the store identifier is different on the web service request than the currently existing transaction.
<code>INPUT_TOO_LARGE</code>	Indicates the input in the web service is larger than is allowed in the transaction date.
<code>ITEM_NOT_RANGED</code>	Indicates the item has not been activated in the location for which the request is made.
<code>MULTIPLE_STORE</code>	Indicates a batch of input data (such as a point-of-sale transaction) was for more than one store in a single web service call.
<code>TIMEZONE_NOT_GMT</code>	Indicates the time input of the web services was not in GMT.

Error Code	Description
UOM_MISMATCH	Indicates a mismatch of unit of measure information between the input and currently existing data that does not allow the information to be accurately merged.

Validation Error (Fault Example)

```
<S:Envelope xmlns:S="http://schemas.xmlsoap.org/soap/envelope/">
  <S:Body>
    <ns0:Fault xmlns:ns0="http://schemas.xmlsoap.org/soap/envelope/"
      xmlns:ns1="http://www.w3.org/2003/05/soap-envelope">
      <faultcode>ns0:Server</faultcode>
      <faultstring>VALIDATION_ERROR</faultstring>
      <detail>
        <ns0:ValidationWSFaultException
          xmlns:ns0="http://www.oracle.com/retail/integration/services/exception/v1">
          <ns0:shortErrorMessage>VALIDATION_ERROR</ns0:shortErrorMessage>
          <ns0:BusinessProblemDetail>
            <ns0:problemDescription>VALIDATION_
ERROR</ns0:problemDescription>
            <ns0:ProblemDetailEntry>
              <ns0:name>ERROR</ns0:name>
              <ns0:value>INVALID_INPUT</ns0:value>
            </ns0:ProblemDetailEntry>
            <ns0:ProblemDetailEntry>
              <ns0:name>ShlfAdjRef</ns0:name>
              <ns0:value>1</ns0:value>
            </ns0:ProblemDetailEntry>
            <ns0:ProblemDetailEntry>
              <ns0:name>ATTRIBUTE</ns0:name>
              <ns0:value>shelfAdjustmentId</ns0:value>
            </ns0:ProblemDetailEntry>
          </ns0:BusinessProblemDetail>
        </ns0:ValidationWSFaultException>
      </detail>
    </ns0:Fault>
  </S:Body>
</S:Envelope>
```

Business Error (Fault Example)

```

<S:Envelope xmlns:S="http://schemas.xmlsoap.org/soap/envelope/">
  <S:Body>
    <ns0:Fault xmlns:ns0="http://schemas.xmlsoap.org/soap/envelope/"
xmlns:ns1="http://www.w3.org/2003/05/soap-envelope">
      <faultcode>ns0:Server</faultcode>
      <faultstring>BUSINESS_ERROR</faultstring>
      <detail>
        <ns0:ValidationWSFaultException
xmlns:ns0="http://www.oracle.com/retail/integration/services/exception/v1">
          <ns0:shortErrorMessage>BUSINESS_ERROR</ns0:shortErrorMessage>
          <ns0:BusinessProblemDetail>
            <ns0:problemDescription>BUSINESS_ERROR</ns0:problemDescription>
            <ns0:ProblemDetailEntry>
              <ns0:name>ERROR_CODE</ns0:name>
              <ns0:value>ADJUSTMENT_NOT_FOUND</ns0:value>
            </ns0:ProblemDetailEntry>
          </ns0:BusinessProblemDetail>
        </ns0:ValidationWSFaultException>
      </detail>
    </ns0:Fault>
  </S:Body>
</S:Envelope>

```

Web Services

Web services available in EICS:

ActivityLock

The following operations are available within the ActivityLock web service.

Operation	Description
lookupActivityLock	Retrieves information about one or more activity locks that match the input criteria.
readActivityLock	Retrieves detailed information about a single lock using its identifying reference.
createActivityLock	Created an activity lock on a transaction.
deleteActivityLock	Deletes an activity lock thereby releasing processing on a transaction.

Standard Usage

An activity lock is a record indicating the user, time, and a piece of information (a transaction) that should be considered "locked". All server processing validates that

the accessing user has a lock on the information before updating, notifying the current user if someone else has modified the information while they were locked and preventing the stale update.

Developers should create locks on information prior to performing update calls and delete locks when the update is finished. For example, create a lock on inventory adjustment with ID 123 with the ActivityLock service, then use `saveInventoryAdjustment` in the Inventory Adjustment service with Adjustment 123, and then delete the activity lock using the ActivityLock service. If you do not gain the lock, you will receive an error when attempting to save an inventory adjustment.

FulfillmentOrderDelivery

The following operations are available within the FulfillmentOrderDelivery web service.

Operation	Description
<code>lookupFulfillmentOrderDeliveryHeaders</code>	Retrieves summary information for fulfillment order deliveries that match the search criteria input.
<code>readFulfillmentOrderDeliveryDetail</code>	Reads the complete detailed information about a fulfillment order including items and quantities.
<code>createFulfillmentOrderDelivery</code>	Creates a new fulfillment order delivery including items and quantities in an in-progress status to be further worked on.
<code>cancelFulfillmentOrderDelivery</code>	Cancel the fulfillment order delivery.
<code>cancelFulfillmentOrderDeliverySubmission</code>	Cancel the fulfillment order review and moves it back into in-progress status for further work.
<code>dispatchFulfillmentOrderDelivery</code>	Dispatches the fulfillment order delivery completing the delivery and updating the inventory.
<code>submitFulfillmentOrderDelivery</code>	Submits the fulfillment order delivery for review prior to dispatching.
<code>updateFulfillmentOrderDelivery</code>	Updates a fulfillment order delivery including items and quantities. This operation requires an activity lock.
<code>lookupCustomAttributeAdmins</code>	Retrieves the custom attribute administration information that describes what customized attributes are available on the fulfillment order delivery.

Standard Usage

A user can create a delivery by using `createFulfillmentOrderDelivery` references the fulfillment order to make a delivery for. The user can then use `updateFulfillmentOrderDelivery` to fill in all the quantities that are going to be shipped and finally use `dispatchFulfillmentOrderDelivery` to indicate that the order has been shipped out, which moves the inventory appropriately.

FulfillmentOrderPick

The following operations are available within the FulfillmentOrderPick web service.

Operation	Description
<code>lookupFulfillmentOrderPickHeaders</code>	Retrieves summary information for fulfillment order picks that match the search criteria input.

Operation	Description
readFulfillmentOrderPick	Reads the complete detailed information about a fulfillment order pick including items and quantities.
confirmFulfillmentOrderPick	Confirm the fulfillment order pick which allows it to move on to the delivery cycle.
deleteFulfillmentOrderPick	Deletes a fulfillment order pick.
createFulfillmentOrderPickByFulfillmentOrder	Generate a pick based on the information in a fulfillment order.
createFulfillmentOrderPickByBin	Generate a pick based on a number of bins selecting orders as needed to fill the bins.
updateFulfillmentOrderPick	Update the item and quantity information about a pick. This operation requires an activity lock.
lookupCustomAttributeAdmins	Retrieves the custom attribute administration information that describes what customized attributes are available on the fulfillment order pick.

Standard Usage

Picking is used to reserve or set aside quantities for a later delivery. The user can create a pick for an order using `createFulfillmentOrderPickByFulfillmentOrder` or create a bin to places multiple orders in with `createFulfillmentOrderPickByBin`. The picked quantities can be updated through the `updateFullfillmentOrderPick` operation and when the pick is finished, it can be finalized with `confirmFulfillmentOrderPick` which sets assigned the goods as reserved in inventory.

FulfillmentOrderReversePick

The following operations are available within the `FulfillmentOrderReversePick` web service.

Operation	Description
lookupReversePickHeaders	Retrieves summary information for fulfillment order reverse picks that match the search criteria input.
lookupReversePickDetail	Reads the complete detailed information about a fulfillment order reverse pick including items and quantities.
createReversePick	Creates a new fulfillment order reverse pick for the specified fulfillment order.
deleteReversePick	Deletes a fulfillment order reverse pick.
updateFulfillmentOrderReversePick	Updates the items and quantities on a fulfillment order reverse pick. This operation requests an activity lock.
confirmReversePick	Confirms the fulfillment order reverse pick completing the process and assigning the inventory back to a location within the store system.
lookupCustomAttributeAdmins	Retrieves the custom attribute administration information that describes what customized attributes are available on the fulfillment order reverse pick.

Standard Usage

Reverse Picking is used to take reserved quantities and place them back into available inventory. The user can create a reverse pick with `createReversePick`. The quantities to return can be updated through the `updateFulfillmentOrderReversePick` operation and

when the reverse pick is ready, it can be finalized with `confirmReversePick` which moves reserved inventory back into available inventory.

InventoryAdjustment

The following operations are available within the InventoryAdjustment web service.

Operation	Description
<code>lookupInventoryAdjustmentReason</code>	Retrieve a complete list of adjustment reasons that can be used when updating or saving an inventory adjustment. Reason codes are attached to each line item.
<code>lookupNonSellableQuantityType</code>	Retrieve a complete list of non-sellable quantity types. These codes indicate the reason that unavailable inventory is unavailable.
<code>lookupInventoryAdjustmentHeader</code>	Retrieve summary information about inventory adjustment transactions based on the search criteria sent.
<code>readInventoryAdjustmentDetail</code>	Retrieve the complete detailed information about an inventory adjustment, including its item information, based on a unique reference/id.
<code>saveInventoryAdjustment</code>	Creates or updates the information about an inventory adjustment in the data store. You can alter information about items and quantities using this operation. This operation requires having an activity lock.
<code>confirmInventoryAdjustment</code>	Confirms the inventory adjustment, updating all the inventory positions, and closing the adjustment.
<code>saveAndConfirmInventoryAdjustment</code>	Performs the functionality of <code>saveInventoryAdjustment</code> and immediately thereafter performs the <code>confirmInventoryAdjustment</code> functionality. See those operations.
<code>cancelInventoryAdjustment</code>	Cancel an inventory adjustment. This can only be done prior to the inventory adjustment being confirmed.
<code>lookupCustomAttributeAdmins</code>	Retrieves the custom attribute administration information that describes what customized attributes are available on the inventory adjustment.

Standard Usage

A new inventory adjustment can be created using the `saveInventoryAdjustment` operation. Alternatively, the user can `lookupInventoryAdjustmentHeader` to find a specific inventory adjustment to work on. Either way, `saveInventoryAdjustment` can be used to update the information on an open adjustment. The `lookupInventoryAdjustmentReasons` will retrieve the reasons codes that need to be assigned to items when you update an adjustment. When the adjustment contains all the information you need, the `confirmInventoryAdjustment` operation will finalize the inventory adjustment and shift the inventory appropriately.

ItemBasket

The following operations are available within the Item Basket web service.

Operation	Description
<code>lookupItemBasketHeaders</code>	Retrieve a list of item basket headers based on search criteria which contain summary information about the item basket.
<code>lookupItemBasketTypes</code>	Retrieve a complete list of item basket types to use when creating a new item basket.

Operation	Description
createItemBasket	Creates a new item basket.
readItemBasketDetail	Retrieve the complete detailed information about an item basket based on an identifier.
deleteItemBasket	Cancels an item basket. The basket will no longer be usable and will be marked for eventual purge from the data store. This operation requires an activity lock.
saveItemBasket	Updates an item basket. This operation requires an activity lock.
copyItemBasket	Creates a new item basket with the same information as an existing item basket.
confirmItemBasket	Moves the item basket to a completed state and allows it to be used within logic throughout the system. This operation requires an activity lock.
lookupCustomAttributeAdmins	Retrieves the custom attribute administration information that describes what customized attributes are available on the item basket.

Standard Usage

A new item basket can be created using the `saveItemBasket` operation. Alternatively, the user can `lookupItemBasketHeader` to find a specific item basket to work on. Either way, `saveItemBasket` can be used to update the information on an item basket. When the item basket contains all the information you need, the `confirmItemBasket` operation will finalize the item basket and make it available to use in other areas of the system.

OrderRequest

The following operations are available within the Order Request web service.

Operation	Description
lookupOrderRequestHeader	Retrieves store order request headers based on the query criteria.
readOrderRequest	Retrieves detailed information about a store order request.
createOrderRequest	Creates a new store order request.
updateOrderRequest	Updates an existing store order request.
approveOrderRequest	Approve a store order request.
cancelOrderRequest	Cancels a store order request.
lookupDeliveryTimeSlot	Retrieves delivery time slots.
lookupOrderContext	Retrieves contexts available for store order requests.
lookupOrderArea	Retrieves store order request areas that could be used for restriction.
lookupCustomAttributeAdmins	Retrieves all the custom attributes admins configured for store order requests.

Standard Usage

A new store order can be created using the `createOrderRequest` operation. The information about store order can be read by `readOrderRequest`. The store order can be updated using `updateOrderRequest` and can be approved using `approveOrderRequest` and can be canceled using `cancelOrderRequest`. The `lookupOrderRequestHeader` is used to find the store orders.

POSTransaction

The following operations are available within the StoreNotification web service.

Operation	Description
processPOSTransactions	Processes a point-of-sale transaction or transactions through an asynchronous process. This is designed to optimize the processing of large numbers of point-of-sale transaction (up to a limit of 5,000 PosTrnItm details).

Standard Usage

POS may integrate its transactions to EICS using this web service. The service processes point-of-sale transactions through an asynchronous process. This service is restricted to a maximum amount of overall PosTrnItms, though they may be distributed between any number of actual PosTrn transactions. The limit is determined by an operation only configuration value: POS Transaction Max Limit. Exceeding this limit causes a web service fault to occur. These transactions may belong to multiple store identifiers. The processing operation validates the input, parses the payload information, creates a POSTransaction object within EICS, and stores these records to be processed later. See [Sales Integration](#) for additional information.

ProductGroup

The following operations are available within the ProductGroup web service.

Operation	Description
lookupProductGroupHeader	Retrieves list of summary information about a product group that match the search criteria input.
readProductGroup	Retrieves the detailed information about a single product group based on its unique reference.
saveProductGroup	Creates or updates a product group. The input contains all the detailed information about the product group. An activity lock is needed for this operation.

Standard Usage

With this web service, the user can create or update the contents of a product group, a collection of items associated with a certain type of grouping, such as stock counts. The user can find the product group with `lookupProductGroupHeader`, read in the entire product group with `readProductGroup` and then, if the group is still open, update the contents of the product group with `saveProductGroup`.

ProductGroupSchedule

The following operations are available within the ProductGroupSchedule web service.

Operation	Description
lookupProductGroupScheduleHeader	Retrieves list of summary information about a product group schedule that match the search criteria input.
readProductGroupSchedule	Retrieves the detailed information about a single product group schedule based on its unique reference.
saveProductGroupSchedule	Creates or updates a product group. The input contains all the detailed information about the product group schedule. An activity lock is needed for this operation.

Operation	Description
cancelProductGroupSchedule	Cancels the product group schedule.

Standard Usage

With this web service, the user can create or update the contents of schedule, which uses a product group to generate activity within EICS. The user can find the schedule with `lookupProductGroupScheduleHeader`, read in the entire schedule with `readProductScheduleGroup` and then, if the schedule is still open, update the contents of the schedule with `saveProductGroupSchedule`.

ReplenishmentGap

The following operations are available within the ReplenishmentGap web service.

Operation	Description
lookupReplenishmentGapHeaders	Retrieves list of summary information about replenishment gaps that match the search criteria input
readReplenishmentGap	Retrieves the detailed information about a single replenishment gap based on its unique reference.
saveReplenishmentGap	Creates a new replenishment gap or updates the detailed information about a replenishment gap. If update, this operation requires an activity lock.
deleteReplenishmentGap	Deletes a replenishment gap.
lookupCustomAttributeAdmins	Retrieves the custom attribute administration information that describes what customized attributes are available on the replenishment gap.

Standard Usage

With this web service, the user can create or update the contents of replenishment gap list which can then be used in creation of shelf replenishment within EICS. A new replenishment gap list can be created using `saveReplenishmentGap`. The user can update existing replenishment gap list with `saveReplenishmentGap`, find replenishment gap lists with `lookupReplenishmentGapHeaders`, read in the entire replenishment gap list with `readReplenishmentGap` and delete a replenishment gap list with `deleteReplenishmentGap`.

RfidInventory

The following operations are available within the RfidInventory web service.

Operation	Description
deleteRfidZone	Deletes a zone within a facility. A zone cannot be deleted if RFID tags still exist within the zone.
lookupRfidZones	Returns details about all the zones within a particular facility.
processRfidEvents	Processes Radio-Frequency-Identification based events.
saveRfidZone	Creates or updates the details of a facility zone.

Standard Usage

With this web service, the user can create or update RFID zone within EICS. A new RFID zone can be created using `saveRfidZone`. The user can update existing RFID zone

list with `saveRfidZone`, find RFID zone lists with `lookupRfidZones` and delete a RFID zone with `deleteRfidZone`. The user can process a RFID based events using `processRfidEvents` and refreshes the inventory for items with `refreshInventory`.

ShelfAdjustment

The following operations are available within the ShelfAdjustment web service.

Operation	Description
<code>lookupShelfAdjustmentHeaders</code>	Retrieves list of summary information about shelf adjustments that match the search criteria input.
<code>readShelfAdjustment</code>	Retrieves the detailed information about a single shelf adjustment gap based on its unique reference.
<code>saveShelfAdjustment</code>	Creates a new shelf adjustment or updates the detailed information about a current shelf adjustment. If update, this operation requires an activity lock.
<code>confirmShelfAdjustment</code>	Confirms a shelf adjustment completing the workflow and moving inventory positions.
<code>cancelShelfAdjustment</code>	Deletes a shelf adjustment.
<code>lookupCustomAttributeAdmins</code>	Retrieves the custom attribute administration information that describes what customized attributes are available on the shelf adjustment.

Standard Usage

Shelf adjustments are used to adjust the shop-floor or backroom stock in case of any discrepancy. A new shelf adjustment can be created using `saveShelfAdjustment`. The user can update existing shelf adjustment with `saveShelfAdjustment`, find shelf adjustment with `lookupShelfAdjustmentHeaders`, read in the entire shelf adjustment with `readShelfAdjustment`, cancel a shelf adjustment with `cancelShelfAdjustment` and confirm a shelf adjustment with `confirmShelfAdjustment`.

ShelfReplenishment

The following operations are available within the ShelfReplenishment web service.

Operation	Description
<code>lookupShelfReplenishmentHeaders</code>	Retrieves list of summary information about shelf replenishments that match the search criteria input.
<code>readShelfReplenishment</code>	Retrieves the detailed information about a single shelf replenishment gap based on its unique reference.
<code>createShelfReplenishment</code>	Creates a new shelf replenishment.
<code>updateShelfReplenishment</code>	Updates the detailed information about a current shelf replenishment. This operation requires an activity lock.
<code>confirmShelfReplenishment</code>	Confirms a shelf replenishment completing the workflow and moving inventory positions.
<code>cancelShelfReplenishment</code>	Deletes a shelf replenishment.
<code>lookupCustomAttributeAdmins</code>	Retrieves the custom attribute administration information that describes what customized attributes are available on the shelf replenishment.

Standard Usage

Shelf replenishment is used to replenish shop-floor stock from backroom or delivery bay. A new shelf replenishment can be created with `createShelfReplenishment`. The user can find shelf replenishments with `lookupShelfReplenishmentHeaders`, read in the entire shelf replenishment with `readShelfReplenishment`, update the shelf replenishment with `updateShelfReplenishment`, confirm the shelf replenishment with `confirmShelfReplenishment` and cancel the shelf replenishment with `cancelShelfReplenishment`.

StockCount

The following operations are available within the StockCount web service.

Operation	Description
<code>lookupStockCountHeaders</code>	Retrieves list of summary information about a stock count that match the search criteria input.
<code>readStockCountDetail</code>	Retrieves the detailed information about a single stock count based on its unique reference. This contains a list of summary information about the child counts.
<code>readStockCountChild</code>	Retrieves the detailed information about a single stock count child.
<code>activateStockCount</code>	This activates and starts the stock counting process including taking a snapshot of current inventory positions.
<code>completeStockCountChild</code>	Completes the counting or recounting of a stock count child, depending on which phase the stock count is in. This process will calculate discrepancies and move the child to the next phase.
<code>updateCountQuantities</code>	Updates the counted or recounted quantity fields for a stock count child based on the current phase of the stock count.
<code>lookupCustomAttributeAdmins</code>	Retrieves the custom attribute administration information that describes what customized attributes are available on the stock count.

Standard Usage

The stock count web services are design primarily to export information for third-party counting. You first lookup the headers, choose your head, retrieve all the details for the stock count, which does not contain item information but does contain a list of child count references. You can use these references to grab the full details of a child count which includes items and quantities.

Store

The following operations are available within the Store web service.

Operation	Description
<code>lookupAutoReceiveStore</code>	Retrieves all stores that allow auto-receiving of inventory from the input store.
<code>lookupAssociatedStore</code>	Retrieves all stores that are associated to the input store. They are sometimes called buddy stores.
<code>lookupStoresInTransferZone</code>	Retrieves all stores in the same transfer zone as the input store.
<code>readStoreDetail</code>	Retrieves the detailed information about a single store from the input unique reference.

Standard Usage

The Store web service is used to retrieve information about stores. There are no updates. They are used to determine such information as whether you can ship to certain stores (such as those in transfer zones).

StoreFulfillmentOrder

The following operations are available within the StoreFulfillmentOrder web service.

Operation	Description
lookuFulfillmentOrdersHeads	Retrieves summary information for fulfillment orders that match the search criteria input.
readFulfillmentOrderDetail	Reads the complete detailed information about a fulfillment order including items and quantities.
createFulfillmentOrderDetail	Creates a new fulfillment order with detailed information, including items and quantities.
cancelFulfillmentOrderDetail	Cancels quantities on a fulfillment order. This may cancel the entire order or just reduce or cancel quantities for specific items
rejectFulfillmentOrder	Rejects the fulfillment order indicating that the store will be unable to fulfill that particular order
lookupCustomAttributeAdmins	Retrieves the custom attribute administration information that describes what customized attributes are available on the fulfillment order.

Standard Usage

Unlike some of the other web services, fulfillment order is not managed within EICS. Instead, EICS manages the picking and delivery, but the order itself is managed by an external order management system.

Oracle Retail Order Broker (OB) calls SIOCS for inventory availability.

Web services are supplied to find and read the details of a fulfillment order, but updates are not allowed. Instead, the external system uses `createFulfillmentOrderDetail` to notify EICS of a new order to ship, `cancelFulfillmentOrderDetail` to reduce or cancel quantities (note that they cannot be increased) or call `rejectFulfillmentOrder` to notify EICS that the order has been rejected.

StoreInventory

The following operations are available within the StoreInventory web service.

Operation	Description
lookupAvailableInventory	Retrieves basic availability information for multiple items at multiple locations. Only transaction-levels items are processed (UPCs are not allowed) and only current inventory is returned. The service supports up to 200 items at 150 locations.
lookupAvailableInventoryAllStores	Retrieves basic availability information for a single item at all store locations. Only transaction-levels items are processed (UPCs are not allowed) and only current inventory is returned.
lookupInventoryInStore	Retrieves a broad set of inventory information for several items at several stores, broken down into various inventory groupings.

Operation	Description
lookupInventoryInTransferZone	Retrieves a broad set of inventory information for items within the specific transfer zone, broken down into various inventory groupings.
lookupInventoryForBuddyStores	Retrieves a broad set of inventory information for associated or buddy stores, broken down into various inventory groupings.
lookupFutureInventory	Retrieves the future inventory information (such as inbound, ordered quantities and expected dates) for an item and store location.
lookupAvailableInventoryAllWarehouses	Retrieves inventory information for a single item at multiple warehouses. Only transaction-level items are processed, and only current inventory is returned.

Standard Usage

The StoreInventory is meant to retrieve inventory position information. Available inventory lookups are much smaller and quicker to respond than full inventory lookups. Future inventory is separated from current positions as it is much more time consuming to retrieve. Those who access the web services should consider the purpose before choosing which operation to use.

StoreInventoryISN

The following operations are available within the StoreInventoryISN web service.

Operation	Description
lookupIsnTypes	Returns a complete list of Item Scan Number types.
lookupIsn	Returns details about matching Item Scan Numbers in store inventory.
createIsn	Create a new Item Scan Number without changing store inventory.
updateIsn	Updates an existing Item Scan Number without changing store inventory.
deleteIsn	Deletes an Item Scan Number without changing store inventory.
lookupCustomAttributeAdmins	Retrieves all the custom attribute admins configured for ISNs.

Standard Usage

This web service is used to create, update or delete ISN in store inventory. An item scan number is any number meant to be scanned to find an item, and potentially a Unique Identification Number, that is not already an item, UPC, UIN, VPN, or other value. Items Scan Numbers are only used to find information and are not tracked as inventory.

StoreInventoryUIN

The following operations are available within the StoreInventoryUIN web service.

Operation	Description
createUIN	Create a new UIN without changing store inventory.
generateUIN	Generate new UINs without changing store inventory.

Operation	Description
lookupUINDetails	Retrieves a collection of UINs matching a set of search criteria input.
readUINDetail	Returns details about a UIN in store inventory. A UIN reference is not unique, so this may return detailed information for UINs across multiple items.
updateUIN	Updates an existing UIN without changing store inventory.

Standard Usage

This web service is used to create, generate, update or read UIN in store inventory.

StoreItem

The following operations are available within the StoreItem web service.

Operation	Description
lookupItemHeaderByItem	Retrieves list of summary information about an item that match the item-based search criteria input.
lookupItemHeaderBySource	Retrieves list of summary information about an item that match the source or location-based search criteria input.
lookupItemHeaderByUDA	Retrieves list of summary information about an item that match the UDA (User Defined Attribute)-based search criteria input.
lookupItemHeaderByInventory	Retrieves list of summary information about an item that match the inventory-based search criteria input.
lookupItemCfa	Retrieve a list of custom flexible attributes for the specified item and store.
lookupItemUda	Retrieve a list of user defined attributes for the specified item and store.
readItemDetail	Retrieves the complete detailed information a single item based on its unique reference.
lookupRelatedItem	Retrieves a list of summary information about items related to the item used as input criteria.
saveItemImage	Inserts a new display image or QR code image for the specified item. The service returns immediately, and the information is processed asynchronously.

Standard Usage

This web service is used to find items and retrieve information about items. The only exception is the ability to create new image-based information about an item.

StoreItemPrice

The following operations are available within the StoreItemPrice web service.

Operation	Description
lookupItemPriceHeader	Retrieve a summary list of item price information based on input criteria. This only retrieves information known to EICS and has no access to a pricing system.
readItemPrice	Retrieves the full details a single item price record based on its unique reference.

Operation	Description
lookupItemPriceOnEffectiveDate	Retrieves the item price of an item for a specific date.

Standard Usage

This web service is used to retrieve information about prices that are known to EICS. Integration with pricing systems updates EICS information about item prices on a continual basis. These web services give a view into EICS information only.

StoreNotification

The following operations are available within the StoreNotification web service.

Operation	Description
createNotification	Creates a new notification within the system. These notifications are displayed in the client applications.

Standard Usage

This web service is designed for external system that handle related activities to EICS. With this web service, they can send notifications into EICS of activity that needs to take place based on something that has occurred in another system.

StoreShipmentManifest

The following operations are available within the StoreShipmentManifest web service.

Operation	Description
closeManifest	Closes the manifest shipments.

Standard Usage

This web service is designed to close manifest shipments. All manifest shipments matching the input criteria like carrier code, carrier service code will be closed.

StoreShipmentReason

The following operations are available within the StoreShipmentReason web service.

Operation	Description
lookupAllShipmentReasons	Retrieves all the shipment reasons configured for store shipments.

Standard Usage

This web service exists to allow customers to retrieve information about shipment reasons that can be assigned to line items on outgoing shipments. The shipment based web services taking the code identifier and thus, you will need to read in these shipment reasons to be able to select and apply valid reason codes.

StoreTicket

The following operations are available within the StoreTicket web service.

Operation	Description
createTickets	Create a new group of up to 999 tickets to be managed and printed.
lookupTicketFormats	Retrieves available ticket formats for the criteria specified.

Standard Usage

The `createTickets` operation is used to create a new group up to 999 tickets to be managed and printed. The ticket formats can be retrieved using `lookupTicketFormats` operation based on the criteria specified.

StoreTransfer

The following operations are available within the StoreTransfer web service.

Operation	Description
lookupTransferHeader	Retrieve a summary list of transfers that matches the input criteria.
lookupTransferContext	Retrieves all the transfer context options available to assign to a transfer.
readTransfer	Retrieves the detailed information about transfer, including its items and quantities, based on a unique reference.
createTransferRequest	Creates a brand-new transfer request (Location 1 requesting a transfer from Location 2).
saveTransferRequest	Updates a transfer request allowing user to change items and quantities. This must be done prior to requesting it, which finalizes the transfer request. This requires an activity lock.
createTransfer	Generates a new transfer that you can add details to. The <code>saveTransfer</code> method must be used to update details such as items and quantities of the transfer.
saveTransfer	Updates a previously approved transfer item and quantity details. This operation requires an activity lock.
saveTransferApproval	Updates items and quantities on a transfer in requested status that is currently in the process of being approved but has not yet been approved. This operation requires an activity lock.
requestTransfer	Updates the status to Requested, finally the transfer request. This allows the opposite location to view the new request for transfer of goods. This operation requires an activity lock.
approveTransfer	Approves a transfer request converted the transfer request into an approved transfer. This operation requires having an activity lock.
rejectTransfer	Rejects a transfer in request status which prevents the transfer request from becoming a transfer. This operation requires having an activity lock.
cancelTransfer	Cancels an approved transfer. This operation requires having an activity lock.
closeTransfer	Closes a processed or partially processed transfer finalizing the state of the transfer. This operation requires having an activity lock.
lookupCustomAttributeAdmins	Retrieves the custom attribute administration information that describes what customized attributes are available on the transfer.

Standard Usage

The process is started by one store creating a transfer request from a shipping store using `createTransferRequest`. The requesting store can continue modifying the transfer request using `saveTransferRequest` until it is ready to notify the shipping store, when it then uses the `requestTransfer` to the shipping store. The shipping store can then begin picking items for the transfer and updating the transfer using the `saveTransferApproval` operation. When all the quantities the shipping store are willing to ship are determined, the shipping store uses `approveTransfer` to finalize the approval of the transfer. Alternatively, they can choose to reject the transfer using `rejectTransfer`. It is possible for a shipping store to create a transfer document without going through the request and approval process by using `createTransfer` and `saveTransfer`.

TransferDelivery

The following operations are available within the TransferDelivery web service.

Operation	Description
<code>lookupTransferDeliveryHeaders</code>	Retrieves basic information about one or more transfer deliveries that match the criteria specified. This operation is used to find a delivery arriving at the store.
<code>readTransferDeliveryDetail</code>	Retrieves the entire set of information about a transfer delivery header based on the identifier you pass to it.
<code>updateTransferDelivery</code>	Updates the header information on a transfer delivery. This operation requires an activity lock.
<code>receiveTransferDelivery</code>	Receives all the currently open and active containers on a transfer delivery by defaulting quantities into all the unreceived items. This does not move inventory, only defaults quantities. This operation requires an activity lock.
<code>confirmTransferDelivery</code>	Confirms a transfer delivery receiving the goods into inventory and updating all the inventory positions. This moves the transfer delivery to a completed status. This operation requires an activity lock.
<code>lookupTransferDeliveryContainerHeaders</code>	Retrieves summary information about every container on a transfer delivery based on the unique delivery reference.
<code>readTransferDeliveryContainerDetail</code>	Reads the entire details of a container including items and quantities based on a unique container reference.
<code>createTransferDeliveryContainer</code>	Generates a new container on the transfer delivery and returns a reference to use so that items and quantity can be added later.
<code>updateTransferDeliveryContainer</code>	Updates the items and quantities on a transfer delivery container. This operation requires an activity lock.
<code>receiveandConfirmTransferDeliveryContainer</code>	It first defaults receiving quantity on the items within the container and then executes the same locking as the <code>confirmTransferDeliveryContainer</code> . This operation requires an activity lock.
<code>confirmTransferDeliveryContainer</code>	Confirms a transfer delivery container as received and updates all the inventory positions. This operation requires an activity lock.
<code>cancelTransferDeliveryContainer</code>	Cancels a transfer delivery container moving it to missing status. Changes cannot be made to a canceled container.
<code>openTransferDeliveryContainer</code>	Re-opens an already confirmed container moving it back into in-progress status.

Operation	Description
lookupTransferDeliveryOrders	Retrieves any customer orders associated with the transfer delivery based on the delivery's unique reference.
lookupMisdirectedTransferDeliveryContainers	Retrieves summary information about containers that may have been misdirected based on a set of search criteria as input into the operation.
lookupCustomAttributeAdmins	Retrieves the custom attribute administration information that describes what customized attributes are available on the transfer delivery.

Standard Usage

After reading a transfer delivery using `lookupTransferDeliveryHeader`, you can read the header detail with `readTransferDelivery` or container list with `lookupTransferDeliveryContainers`. You can then use `updateTransferDelivery` to update header attributes and `updateTransferDeliveryContainer` to update items and quantities in the container. To quickly receive the quantities, `receiveTransferDeliveryContainer` automatically fills in quantities, and when quantities are entered `confirmTransferDeliveryContainer` finalizes the container (and if appropriate configurations and business rules apply) immediately updates the inventory. If `receiveTransferDelivery` or `confirmTransferDelivery` is used, then all containers will either be received or confirmed respectively.

TransferShipment

The following operations are available within the TransferShipment web service.

Operation	Description
lookupTransferShipmentHeader	Retrieves basic information about one or more transfer shipments that match the criteria specified. This operation is used to find a shipment.
readTransferShipmentDetail	Retrieves the entire set of information about a transfer shipment header based on a unique reference.
createTransferShipment	Creates a new and empty transfer shipment and returns a reference to the shipment.
saveTransferShipment	Updates the information on a transfer shipment header.
submitTransferShipment	Submits the transfer shipment for review before final dispatch.
cancelSubmittedTransferShipment	Cancels the submission of the transfer shipment for review.
dispatchTransferShipment	Dispatches a transfer shipment. This moves the shipment to dispatched state and updates the inventory. A transfer shipment cannot be modified after dispatch. Dispatch should occur only after all containers are confirmed.
cancelTransferShipment	Cancels a transfer shipment.
lookupTransferShipmentContainer	Finds all the containers on a specific shipment and retrieves basic identification information about each container.
readTransferShipmentContainer	Reads the specific and complete contents of a container.
createTransferShipmentContainer	Creates a new transfer shipment container on the shipment and returns a reference to it.
saveTransferShipmentContainer	Updates the information about a transfer shipment container including adding and removing items and quantities.

Operation	Description
confirmTransferShipmentContainer	Confirms that a transfer shipment container is ready for shipment and marks the container as no longer editable.
cancelTransferShipmentContainer	Cancels a transfer shipment container on the shipment.
openTransferShipmentContainer	Re-opens a confirmed container on a shipment prior to the shipment being dispatched so that changes can be made to the container.
lookupCustomAttributeAdmins	Retrieves the custom attribute administration information that describes what customized attributes are available on the transfer shipment.

Standard Usage

To create a shipment for a transfer document, you look up the transfer shipment using `lookupTransferShipmentHeader`. If it does not exist, you could create one for the document using `createTransferShipment`. You then create a container on the shipment using `createTransferShipmentContainer`. You can update the container with items and quantities using `saveTransferShipmentContainer`. You then confirm the container using `confirmTransferShipmentContainer`. Repeat the process for each container as needed. Once all containers are confirmed, you submit if configured using `submitTransferShipment` and finally dispatch the shipment using `dispatchTransferShipment`. Dispatching the shipment finalizes the shipment and relieves the inventory.

VendorDelivery

The following operations are available within the VendorDelivery web service.

Operation	Description
lookupVendorDeliveryHeaders	Retrieves basic information about one or more vendor deliveries that match the criteria specified. This operation is used to find a delivery from a supplier.
lookupPurchaseOrderHeaders	Retrieves basic information about one or more purchase orders that match the criteria specified.
readVendorDeliveryDetail	Retrieves the entire set of information about a vendor delivery header based on a unique reference.
createVendorDelivery	Generate a new vendor delivery header and returns a referenced to the delivery.
updateVendorDelivery	Updates the information on a vendor delivery header. This does not include containers, items, or quantities. This operation requires an activity lock.
receiveVendorDelivery	Updates the quantities on a vendor delivery filling in any unreceived items within the containers of the delivery with a default value. It "receives" missing quantities, but no inventory positions are updated. This operation requires an activity lock.
confirmVendorDelivery	Confirms the vendor delivery updating inventory positions and completing the delivery. This operation requires an activity lock.
rejectVendorDelivery	Rejects the vendor delivery placing it in rejected status. This operation requires an activity lock.
cancelVendorDelivery	Cancels the vendor delivery placing it in canceled status. This operation requires an activity lock.

Operation	Description
lookupVendorDeliveryContainerHeaders	Retrieves summary information about every container on a vendor delivery based on the unique delivery reference.
readVendorDeliveryContainerDetail	Reads the entire details of a container including items and quantities based on a unique container reference.
createVendorDeliveryContainer	Generates a new container on the vendor delivery and returns a reference to use so that items and quantity can be added later.
updateVendorDeliveryContainer	Updates the items and quantities on a vendor delivery container. This operation requires an activity lock.
confirmVendorDeliveryContainer	Confirms a vendor delivery container as received and updates all the inventory positions. This operation requires an activity lock.
cancelVendorDeliveryContainer	Cancels a vendor delivery container moving it to missing status. Changes cannot be made to a canceled container.
openVendorDeliveryContainer	Open Vendor delivery container. This will re-open a container after receipt allowing it to be received again.
lookupVendorDeliveryOrders	Retrieves any customer orders associated with the vendor delivery based on the delivery's unique reference.
lookupVendorDeliveryAdjustments	Retrieves any external receipt adjustments that exist for the delivery based on the specified unique reference.
cancelSubmitVendorDeliveryContainer	Opens a submitted container for further updates, moving the status to in-progress.
submitVendorDeliveryContainer	Moves the status of the container to submitted and prevents further updates. The container may still be confirmed. No inventory positions are updated via this operation.
lookupCustomAttributeAdmins	Retrieves the custom attribute administration information that describes what customized attributes are available on the vendor delivery.

Standard Usage

After reading a vendor delivery using `lookupVendorDeliveryHeader`, you can read the header detail with `readVendorDelivery` or container list with `lookupVendorDeliveryContainers`. You can then use `updateVendorDelivery` to update header attributes and `updateVendorDeliveryContainer` to update items and quantities in the container. To quickly receive the quantities, `receiveVendorDeliveryContainer` automatically fills in quantities, and when quantities are entered `confirmVendorDeliveryContainer` finalizes the container (and if appropriate configurations and business rules apply) immediately updates the inventory. If `receiveVendorDelivery` or `confirmVendorDelivery` is used, then all containers will either be received or confirmed respectively. You can re-open container using `openVendorDeliveryContainer`. To prevent further updates to the container can use `submitVendorDeliveryContainer`. Submitted container can be re-opened and moved to in-progress status for further updates using `cancelSubmitVendorDeliveryContainer`.

VendorReturn

The following operations are available within the VendorReturn web service.

Operation	Description
lookupVendorReturnHeader	Retrieves basic information about one or more vendor return documents that match the criteria specified.
readVendorReturnDetail	Retrieves the entire set of information about a vendor return, including items and quantities, based on a unique reference.
saveVendorReturn	Updates the entire set of information about a vendor return, including items and quantities. This operation requires an activity lock.
approveVendorReturn	This marks an in-progress vendor return as approve for shipment. This operation requires an activity lock.
cancelVendorReturn	Cancels a vendor return indicating no further items and quantities should be shipped for the return.
closeVendorReturn	Closes a vendor return document moving it from in-progress to canceled, rejected, or complete status depending on the state of shipped quantities.
lookupCustomAttributeAdmins	Retrieves the custom attribute administration information that describes what customized attributes are available on the vendor return.

Standard Usage

The user may access `lookupVendorReturnHeader` to find vendor returns to deal with. Once the proper vendor return is found, `readVendorReturnDetail` will retrieve all the details of the vendor return including items and quantities. The `saveVendorReturn` operation is then used to update quantities that are expected to ship. Once the vendor return reaches its final state, the operation `approveVendorReturn` will approve the return and get it ready for shipment.

VendorShipment

The following operations are available within the VendorShipment web service.

Operation	Description
lookupVendorShipmentHeaders	Retrieves basic information about one or more vendor shipment headers that match the criteria specified.
lookupReturnContext	Retrieves all the context options that are available to assign to a vendor return shipment.
readVendorShipmentDetail	Retrieves the detailed information about a vendor return header based on a unique reference. It does not include information about containers or items.
saveVendorShipment	Creates a new vendor shipment header if not identifying reference is set or updates the vendor shipment header information if a unique reference is sent as part of the date. When used as an update, an activity lock is needed.
submitVendorShipment	Submits the vendor shipment for review before final dispatch.
cancelVendorShipmentSubmission	Cancels the submission of the vendor shipment for review.
cancelVendorShipment	Cancels a vendor shipment. This moves the shipment to canceled status. Changes cannot be made to a canceled shipment.

Operation	Description
dispatchVendorShipment	Dispatches a vendor shipment. This moves the shipment to dispatched state and updates the inventory. A vendor shipment cannot be modified after dispatch. Dispatch should occur only after all containers are confirmed. This operation requires an activity lock.
closeVendorShipment	Closes a vendor shipment using business logic to determine its final state. It cancels the shipment of remaining quantities. Changes cannot be made after a shipment is closed.
lookupVendorShipment ContainerHeaders	Retrieves summary information about all containers within a vendor shipment based on the unique reference of the shipment.
readVendorShipment ContainerDetail	Reads the specific details, including items and quantities, about a container specified by its unique reference.
saveVendorShipmentContai ner	Update the details of a container, including items and quantities. This operation requires an activity lock.
confirmVendorShipmentCo ntainer	Confirms that the container is ready for shipment. A confirmed container cannot be modified. This operation requires an activity lock.
cancelVendorShipmentCont ainer	Cancels a container on the shipment removing it from the shipment.
openVendorShipmentContai ner	Opens a confirmed container placing it back into in-progress status so that items can be added or removed from the container.
lookupCustomAttributeAd mins	Retrieves the custom attribute administration information that describes what customized attributes are available on the vendor shipment.

Standard Usage

To create a shipment for a vendor return document, you look up the vendor shipment using `lookupVendorShipmentHeader`. If it does not exist, you could create one using `createVendorShipment`. You then create a container on the shipment using `createVendorShipmentContainer`. You can update the container with items and quantities using `saveVendorShipmentContainer`. You then confirm the container using `confirmVendorShipmentContainer`. Repeat the process for each container as needed. Once all containers are confirmed, you submit if configured using `submitVendorShipment` and finally dispatch the shipment using `dispatchVendorShipment`. Dispatching the shipment finalizes the shipment and relieves the inventory.

Enterprise Documentation

Full web service API documentation can be found at:

https://docs.oracle.com/cd/E82085_01/160/RIB%20Integration%20Guide/Output/ServiceTOC.html

Sales Integration

EICS integrates with POS systems and Sales Audit systems to ensure that the inventory positions are accurate. This is especially important where accurate up-to-date inventory positions are required to reduce customer disappointment when trying to locate items that appear in inventory or delays in filling customer orders.

POS is the primary source of sales, returns, void, and some customer order transaction information to EICS.

ReSA sends only modified or new POS transaction records to EICS.

POS systems integrated with EICS can do the transaction notifications using a web service.

Sales Audit systems can only communicate through a file import process.

Figure 8–12 POS and Sales Audit Integration

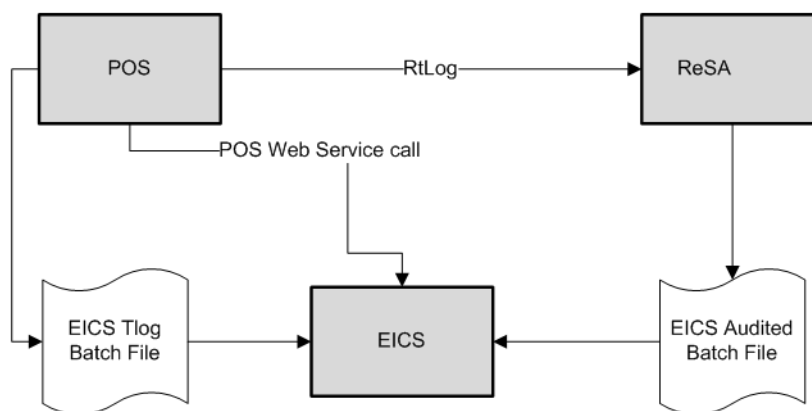

The following features are part of this integration:

- Real-time web service integration
- Batch integration
- Audited sales data integration
- Automatic disposition processing for returns

Batch processing and ReSA processing are discussed elsewhere as are the store and system configurations that might determine how the sale is processed.

POS and Sales Audit Process Flow

The following figure shows how a POS, Retail Sales Audit, and EICS are integrated. A POS generates an RTLog containing all the POS transactions and sends it to the Oracle Retail Sales Audit system (ReSA). ReSA sends the audited modified or new transactions to EICS. ReSA also sends the POS transaction upload file to merchandising to update inventory.

Please note that Oracle Retail Xstore is interfaced with EICS to update the inventory transactions near real time only through web service. It does not use batch.

Non-Oracle POS systems can use a batch to import transactions directly into EICS. EICS also processes the POS transactions that have been changed or entered the sales audit system and updates the inventory based on the delta.

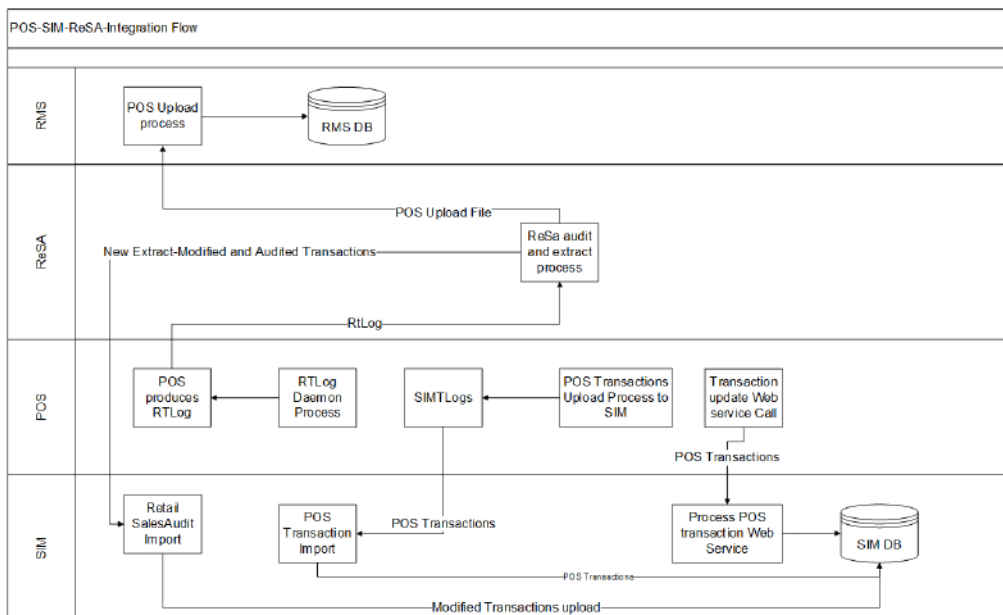
Figure 8–13 POS and Sales Audit Process Flow

There are two reasons for POS to send sales data directly to EICS and not to the auditing system:

- Real-time inventory updates to support Commerce Anywhere are critical. A possible round trip from POS to ReSA to EICS takes too long in the dynamic inventory environment of today.
- POS is the application that owns sales data and ReSA owns audited data. Architecturally, it makes more sense to have data supplied by the owner of that data. POS sends sales data and ReSA sends audit changes to EICS.

Sales and Return Processing

As part of the sales processing, EICS updates the inventory depending on the nature of the transaction. The following are the supported transaction types for the sales processing: Sale, Return, and Post Void of these transactions. The audit system should not modify the post void transactions. A change to a void is not supported by EICS.

Customer Order Processing

In EICS, the Retail Sales Audit import process, POS Transaction import process, and POS Transaction web service process support the following types of customer orders.

- For layaway and on hold, EICS supports create, update, cancel, and pickup/delivery. For external web order type, only pickup transactions performed in POS are sent to EICS.
- Pickup transactions, both in-store and external, cannot be voided or modified by sales audit and if these transactions are modified by sales audit system, EICS just drops the transaction and does not process.

Note: Current Xstore functionality is limited to only layaway and on hold orders. Web order processing is not supported in this release.

Item Disposition

POS can move inventory for return and post void transactions to 'unavailable' or 'out of stock'. This is especially useful in some environments where items returned must be disposed of or have to be reprocessed.

The external sale transaction coming into EICS may include a reason code that is mapped to the inventory adjustment reason codes in EICS. Point of Service maps the EICS reason codes, and the reason codes are sent to EICS in the web service or file extract for the return and post void transactions. EICS first processes the return or post void and updates stock on hand. Next, if the reason code exists, EICS checks this reason code with the one in inventory adjustment reason code table. If a valid match is found, EICS generates an inventory adjustment to notify external systems and execute the disposition instructions tied to the inventory adjustment reason code. Based on the disposition mapped to the reason code, EICS moves the returned inventory to not for sale or out of stock and updates the history trail. If sub-buckets are used, they are also updated if the movement is to not for sale.

If the reason code received is invalid/not present/mapped incorrectly, the system writes an error log and continues to process the stock on hand part of the transaction.

Drop Ship

When the sales records indicate the record is a drop ship, EICS does not perform any processing of this record since the drop ship process implies the inventory is shipped from a third-party location and not from the store.

Item Types

EICS only processes SKU or UPC numbers. GS1 databars, or any other smart barcodes such as VPLUs or Type-E barcodes, should have been extracted to their SKU or UPC number by the POS system.

In addition, EICS only updates inventory for stock holding items. Non-inventory items do not update any stock on hand and are not processed.

Items with the store pack inventory indicator turned off are automatically broken down and the inventory of the component items is updated.

RFID

If the point-of-sale record for an item includes an RFID tag, the tag will be moved to a SOLD status indicating it should be out-of-store.

Integration with Manifesting Systems

For access to an external manifesting system to take place, the customer must first setup Carrier Type as "Third Party" and the Carrier Service (Manifest Type) must be Parcel (P). Configuration controls whether manifesting is done for a transfer to store, finisher, or warehouse. In addition, configuration controls manifesting for a return to vendor shipment or a customer order delivery.

Carrier services with manifest type of "O" (Other) and "H" (Home Fleet) do not go through the manifesting system. When Manifest Type is "O," EICS prompts the user to enter the carrier address where the shipment is to be sent for fulfillment. Manifest Type of "H" is within the company and therefore, does not prompt the user for an address.

Some carriers require weight, dimension, or both values to be sent in the manifest payload. If so, the carrier's service should have either the weight indicator or carton dimension indicate set to active (or both) during their carrier service setup.

EICS supplies an outbound and inbound Shipment Manifest SOAP web service. The following are supported service operations:

A web service is used to send all the shipment information to the external manifesting system and to receive close shipment requests from external systems.

A web service accepts requests from external systems to close shipments. It is used to find those "Submitted" shipments for the provided tracking ID, carrier, service and date, and dispatch those shipments.

Note: EICS supplies a WSDL and XSD that defines the web service, operation, and data content. This web service will need to be implemented either for the manifesting system or a plug-in set up.

ShipmentManifestService

This web service notifies an external manifesting system that a manifest needs to be created.

Service Operation	Description
createManifest	Requests the external manifesting system to create a new parcel manifest for an input transaction.

StoreShipmentManifestService

This web service receives a message from an external manifesting system that the items on the manifest have been picked up.

Service Operation	Description
closeManifest	Instructs EICS that submitted shipments have been picked up by the carrier.

Customer Order

CustomerOrderAddressService

When shipping to customer during the fulfillment order workflow, EICS retrieves the address for the order delivery from an external order managements system. When viewing delivery address information within the client application, it also retrieves it from an external system. The web service is defined to connect to an OrderManagementService.

Service Operation	Description
queryCustomerOrderAddress	Retrieves detailed address information for the order and customer information passed to it.

CustomerOrderService

This service connects to OrderManagementService to manage customer orders. It includes operations to create a customer order, query for customer orders, pickup/cancel items from a customer order and return items from customer orders.

Service Operation	Description
requestNewCustomerOrderId	Requests new customer order Id.
cancelNewCustomerOrderId	Cancels the new customer order id.
createCustomerOrder	Creates customer order.
queryCustomerOrder	Queries the customer order present in the system.
PickupCustomerOrderItems	Pickup items from the customer order.
ReturnCustomerOrderItems	Returns items from the customer order.
UpdateReceipt	Updates the receipt of customer order.

Integration for Ticket Printing

TicketPrintService

When printing tickets, EICS sends ticket information to an external system for printing. This web service needs to be implemented for printing tickets to a physical printer.

Service Operation	Description
printTickets	Sends item tickets to an external system to be printed. It must be implemented by the external system in order to receive the tickets.

Integration for Sales Forecast

SalesForecastService

If implemented by a third-party sales analytic system, EICS can retrieve sales forecasting information from this system. It retrieves the specific date and quantity for that date extending out to up to 30 days.

Service Operation	Description
retrieveSalesForecast	Retrieves the sales forecast data for a store and item over the next 30 days.

Integration for Store Order

OrderApproveNotificationService

When store order is approved, EICS sends notification to a third-party item management system.

This notification will be sent out for store orders that are created manually or system generated.

It is not applicable to store orders created by external system.

Service Operation	Description
orderRequestApproved	Sends notification to external item management system that the order request is approved.

StoreExtNotificationService

When store order with external ID is approved, EICS sends notification to the external system.

This service is applicable only for externally created store orders.

Service Operation	Description
createNotification	Sends notification to external system on approving the externally created store orders with its items information.

Retail Home Integration

EICS now supports following integration scenarios with Retail Home:

- Launch SIOCS web client from Retail Home
- Launch SIOCS favorites from Retail Home
- Display a tile report for items that are out of stock on shop floor
- Display a tile report for stock counts that are pending authorization
- Launch detailed operational views in SIOCS web client from related tile reports in Retail Home

Launch SIOCS from Retail Home

Launching SIOCS client requires an entry to be made under the application navigator section of Retail Home. It enables the user to launch SIOCS web client in a new browser tab from within Retail Home. Please refer to *Oracle Retail Home Administration Guide* for information on how to work with application navigator in Retail Home.

The SIOCS application configuration should look like this:

Figure 8–14 Add Application Info

The screenshot shows the 'Add Application Info' dialog box. The 'Seeded' field is set to 'No'. The 'Application Navigator' toggle is turned on. The 'Application Name' is 'Store Inventory Operations Cloud Servi', 'Color Set' is 'Cyan', 'Application Code' is 'SIOCS', and 'Application Link' is 'https://bur00afs-ext-vip1.us.oracle.com'. The 'Platform Service' toggle is also turned on. A sub-dialog is open showing 'URL' as 'https://bur00afs-ext-vip1.us.oracle.co', 'Supported' with 'Notifications' unchecked, and 'Features' with 'Favorites' checked and 'Resource Bundle Customization' unchecked. At the bottom, there is an 'Import Role Mapping' section with a 'Choose File' button, and 'OK and Create Another', 'Cancel', and 'OK' buttons.

- **Seeded:** Disabled and set to No.
- **Application Navigator:** Enable it to launch SIOCS client from Retail Home.
- **Application Name:** The name of the application that is, Store Inventory Operations Cloud.
- **Color Set:** Any color that you want to allocate to SIOCS.

- **Application Code:** Select SIOCS from the drop down.
- **Application Link:** The URL of SIOCS web client.
- **Platform Service:** Enable it to use Favorites feature.
 - **URL:** The base URL of the platform services. The URL would be of the form `https://<SIOCS-HOST>/RetailAppsPlatformServices<SIOCS-HOST>` is the same host in Application Link.
 - **Supported Features:** Check only the favorites feature.

The user needs to be part of RETAIL_HOME_ADMIN security group in order to access Application Navigator in Retail Home.

Tile Reports

EICS supports following two types of two metric reports:

- Shop Floor Out of Stock Items
- Stock Counts - Ready to Authorize

Adding an application navigator entry for SIOCS will automatically configure EICS tiles on Retail Home.

The data seed features do the following:

1. Creates a custom report for EICS tiles on Retail Home.
2. Creates two tiles from the custom report and maps them to retail_home_users IDCS or OCI IAM application role.
3. The data seed features will also configure tile states for the two tiles and hook them up with EICS end points.

After all the configuration, you should be able to see EICS tiles on the dashboard. They should look like the ones below:

Figure 8–15 Example EICS Tiles

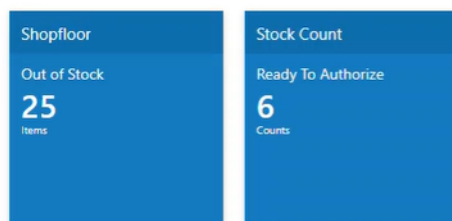

EICS Endpoints

EICS exposes following two endpoints:

Shop Floor Out of Stock Items

This endpoint can be used as a data source for **Shop floor Out of Stock** tile state.

The response contains information on number of items that are out of stock across all the stores that are accessible to the user.

If the percentage of out of stock items to total items is greater than the **Shopfloor Out of Stock Items Critical Percentage** system configuration, EICS marks the response as important which displays a '!' mark next to the number on the tile report.

Table 8–5 Shop Floor Out of Stock

Endpoint	Operational View
https://<EICS-HOST>:<EICS-PORT>/sim-mobile/internal/rhreports/outofstock/shopfloor/tile	Shopfloor Out of Stock

Stock Counts - Ready to Authorize

This endpoint can be used as a data source for **Stock Count - Ready to Authorize** tile state.

The response contains information on number of stock counts that are pending authorization across all stores that are accessible to the user.

Table 8–6 Stock Counts - Ready to Authorize

Endpoint	Operational View
https://<EICS-HOST>:<EICS-PORT>/sim-mobile/internal/rhreports/readytoauthorize/tile	Stock Count - Ready To Authorize

The response payloads of both these endpoints confirm to the two metric payload specifications of Retail Home.

User should be a part of retail_home_users IDCS or OCI IAM application role to access these endpoints.

For convenience, EICS also provides a RETAIL HOME security role that captures security permissions required to access these operational views. The user still needs appropriate functional area permissions to navigate to transaction detail screens.

SIOCS Operational Views

EICS has added following operational views that can be hooked with related tiles:

- **Shopfloor Out of Stock Items**

This view gives a store and item level breakdown of the information that is displayed on the tile. The user can look at item level records for each store and navigate to the item detail screen for any store/item combination provided he or she has the required permissions.

This view is available under Operations - Operational Views - Shopfloor Out of Stock menu.

- **Stock Count - Ready to Authorize**

This view gives a store and stock count level breakdown of the information that is displayed on the tile. The user can look at stock count level records for each store and navigate to the stock count detail for any store/count combination provided he or she has the required permissions.

This view is available under Operations - Operational Views - Stock Count - Ready to Authorize menu.

Launch SIOCS Operational Views from Tile Report

Launching SIOCS operational views from related tile report requires the tile report to be configured with the URL of the related operational view. Once that is done, clicking on tile report header should open the related EICS operational view in a new browser tab.

Configuration

This chapter describes how you can configure functionality usage.

Configuration can be achieved by adjusting:

1. [System Admin Parameters](#)
2. [Store Admin Parameters](#)
3. [Feature Permissions](#)

System Admin Parameters

Table 9–1 System Admin Parameters

Options	Description	Default Value	Topic	Type
Allow Non-Range Item	Values: Yes/No This parameter is to determine to give stores the ability to add non ranged items to functional areas in the application.	Yes	Admin	Boolean
Auto Default UIN Attributes	Auto default UIN attributes is used during ItemLocCre to default UIN attributes for an item taking values from the store defaults (STORE_UIN_ADMIN_DEPT table). It is also checked whenever we range an item to a store.	No	Admin	Boolean
Barcode Scan/Entry Log - Receiving	Values: Yes/No Yes: Captures, on the mobile, all container and item scans or manual entries by user, location, and time at the point of receiving deliveries. Containers are captured in the quick receiving dialog when item level is captured in the Item Receiving function of the Container Summary for DSD and Transfer Receiving. No: Does not capture any container or item information in the mobile receiving dialogs.	Yes	Admin	Boolean
Default UOM	Values: Standard UOM / Cases Standard UOM the system will default to the standard UOM until the UOM is changed. Cases the system will default to cases until the UOM is changed.	2	Admin	Integer
Disable Pack Size	Values: Yes/No Yes: Pack size is disabled and cannot be changed. No: Pack size is editable and can be updated.	No	Admin	Boolean

Table 9–1 (Cont.) System Admin Parameters

Options	Description	Default Value	Topic	Type
Enable Extended Attributes	<p>Values: Yes/No</p> <p>This is a master switch that will turn on and off the feature for collecting extended attributes.</p> <p>If set to 'Yes', the system will capture the extended attributes when scanning a GS1 DataBar</p> <p>If set to 'No', the Ext Attributes are not captured when scanning a GS1 Databar and the button/menu option will not be available on either the EICS or SOCS regardless of the store parameter.</p>	No	Admin	Boolean
Enable Sub-buckets	<p>Values: Yes/No</p> <p>Yes: Sub-buckets will be used throughout the application.</p> <p>No: Sub-buckets will not be used in the application.</p>	Yes	Admin	Boolean
Item Description Translation Preference	<p>Values: System/User</p> <p>System: The Item description displayed in the application would be the item description from STORE_ITEM table (store description) or from ITEM table if the item is not ranged. This is existing functionality.</p> <p>User: The Item description will be displayed in the user's preferred language if translation is available.</p> <p>If the translation is not available in the user's preferred language, then the item description will be displayed in the store locale language, if it is available.</p> <p>If the translation is not available in the store locale language, then the item description displayed will be item description from STORE_ITEM (store description). If the item is a non ranged item, then the item description displayed will be from the ITEM table.</p>	System	Admin	Boolean
Maintain RFID History	<p>Values: Yes/No</p> <p>Yes: will create history records in the history table for every transaction occurred for the RFID Tag.</p> <p>No: will not create the history records however the integration with the RFID solution and RFID tag tracking could still be on.</p>	Yes	Admin	Boolean
Shopfloor Out of Stock Items Critical Percentage	<p>Values: 0.01 - 100%</p> <p>If the percentage of out of stock items on shop floor to total items is greater than this percentage, then there will be an '!' alert with the number of items out of stock on the tile report.</p>	0.01%	Admin	Integer
System Code	Code identifying the application for integration with an external system. This often is a company ID. This is only used for outbound integration.	INV	Admin	String
Audit Direct Store Delivery	Audit Records are log of activities and usage information in the system. This parameter is to determine whether activity records for actions (confirm/submit/update and so on) performed on vendor delivery and vendor delivery carton will be created.	Yes	Audit	Boolean

Table 9–1 (Cont.) System Admin Parameters

Options	Description	Default Value	Topic	Type
Audit Publish Message	Audit Records are log of activities and usage information in the system. This parameter is to determine whether activity records for outbound messages will be created.	Yes	Audit	Boolean
Audit Receive Message	Audit Records are log of activities and usage information in the system. This parameter is to determine whether activity records for inbound messages will be created.	Yes	Audit	Boolean
Audit RTV Update	Values: Yes/No Yes: Enables activity logging for rtv request and rtv shipments. No: Disables activity logging for rtv request and rtv shipments.	Yes	Audit	Boolean
Audit Security	Values: Yes/No Yes: Enables activity logging for security events. It includes login success/failure, security management changes (roles, user assignments, and so on). No: Disables activity logging for security events.	Yes	Audit	Boolean
Audit Stock Count Completed	Audit Records are log of activities and usage information in the system. This parameter is to determine whether activity records will be created for count or recount complete for stock count child.	Yes	Audit	Boolean
Audit Transfer Dispatch	Values: Yes/No Yes: Enables activity logging for transfer shipments. No: Disables activity logging for transfer shipments.	Yes	Audit	Boolean
Audit Transfer Receiving	Values: Yes/No Yes: Enables activity logging for transfer receiving. No: Disables activity logging for transfer receiving.	Yes	Audit	Boolean
Audit Transfer Update	Values: Yes/No Yes: Enables activity logging for transfer requests. No: Disables activity logging for transfer requests.	Yes	Audit	Boolean
Batch max files per job run	Batch max files per job run.	20	Batch	Integer
Batch Maximum Threads	Gives the maximum number of batch partitions for a batch to run.	5	Batch	Integer
Batch Scheduler Execution Interval	Gives the batch scheduler execution delay interval duration to throttle batch execution calls.	300	Batch	Integer
Data seed by store	Values: Yes/No Enables/Disables data seeding per store.	No	Batch	Boolean
Data seed chunk limit	Chunk limit for records processed in data seeding.	10000	Batch	Integer
Data seed foundation data	Values: Yes/No Enables/Disables the foundation data seeding.	No	Batch	Boolean

Table 9–1 (Cont.) System Admin Parameters

Options	Description	Default Value	Topic	Type
Data seed store data	Values: Yes/No Enables/Disables the store data seeding.	No	Batch	Boolean
Days to Hold Archived and Rejected Files	Gives the days to hold rejected and archived batch files before deleting them from the batch directory.	30	Batch	Integer
Maximum Job Instances Per Scheduler Execution	Gives the maximum number of jobs allowed per run of the scheduler.	100	Batch	Integer
Maximum Processing Hours For Scheduled Job	Determines the maximum processing time for a batch job. After this time, the batch schedule record is updated to failed status.	5	Batch	Integer
Procedure Log Purging Info Enabled	Determines whether the procedure log purging info is enabled.	Yes	Batch	Boolean
Search Limit Default for Batch Job Days	Gives the default number of days in past for batch job records to be displayed on Batch Job Admin screen on EICS.	7	Batch	Integer
Display Item Image For Container Lookup - Operations	Values: Yes/No Yes: Indicates item image will be displayed in Container Lookup on EICS. No: Image will not be displayed in Container Lookup on EICS.	No	Container Lookup	Boolean

Table 9-1 (Cont.) System Admin Parameters

Options	Description	Default Value	Topic	Type
Customer Order Fulfillment Restriction	<p>Values: Restricted/Transaction Controlled/Line Controlled</p> <p>Transaction Controlled: The Allow Partial Delivery indicator that comes in on the customer order will be used as it was sent.</p> <p>Restricted: The Allow Partial Delivery Indicator will be updated to 'No' on the Customer Order or Transfer Request upon coming into the system.</p> <p>- Customer Order Deliveries and Transfer Request/Shipment will validate the Allow Partial Delivery indicator as usual, however, it will be set to 'No' and force the user to have a full delivery (with the exception of a user override in customer order deliveries).</p> <p>- Customer Order Picking: When creating a pick, the user will not be able to create the pick if there is not enough available to pick. When confirming a pick, everything must be picked on the customer order.</p> <p>- Reverse Picking: when creating a reverse pick, the user must reverse pick everything that was picked.</p> <p>Line Controlled: If an item is getting delivered, it must be delivered in its entirety.</p> <p>- Customer Order Deliveries and Transfer Request/Shipment will validate the Allow Partial Delivery indicator as usual. When Allow Partial Delivery indicator is set to 'Yes', the system will force the user to approve/ship an item fully, if it is getting approved/shipped. When Allow Partial Delivery indicator is 'No', the system will force the user to ship the full order to the customer (with the exception of a user override in customer order deliveries). In case the user has override permission, the customer order can be shipped partially however an item getting shipped should be shipped fully.</p> <p>- Customer Order Picking: When creating a pick, the user will not be able to create the pick if there is not enough available to pick at least one item. When confirming a pick, if an item is getting picked, it must be picked fully.</p>	Transaction Controlled	Customer Order	Integer
Customer Order Reauthorization Notification	<p>Values: Yes/No</p> <p>Yes: User will get a notification if a customer order has been reauthorized successfully, that is, when SIOCS successfully consumes and processes a RIB message from OBCS that a customer order has been released from on hold, a notification will be sent to the user</p> <p>No: User will not get a notification if a customer order has been reauthorized successfully.</p>	No	Customer Order	Boolean
Customer Order Receipt Notification	<p>Values: Yes/No</p> <p>Yes: A receipt notification will be generated when a customer order related transfer receipt or Direct Store Delivery (DSD) has been confirmed.</p> <p>No: The notification will not be generated.</p>	No	Customer Order	Boolean

Table 9–1 (Cont.) System Admin Parameters

Options	Description	Default Value	Topic	Type
Customer Order Tracking ID Required	Yes: If the store parameter Manifest Customer Order Deliveries is set to No, the Tracking ID must be captured before dispatching the Customer Order Delivery. If 'Manifest Customer Order Deliveries' is set to Yes, then it is not required. No: Capturing Tracking ID becomes optional while dispatching the Customer Order Delivery.	No	Customer Order	Boolean
Display Item Image for Customer Order Delivery	Values: Yes/No Yes: This parameter indicates that item image will be displayed in Customer Order Deliveries. No: Images will not be displayed in Customer Order Deliveries	No	Customer Order	Boolean
Display Item Image for Customer Order Picking	Values: Yes/No Yes: This parameter indicates that item image will be displayed in Customer Order Picking. No: Images will not be displayed in Customer Order Picking.	No	Customer Order	Boolean
Display Item Image for Customer Order Reverse Picking	Values: Yes/No Yes: This parameter indicates that item image will be displayed in Customer Order Reverse Picking. No: Images will not be displayed in Customer Order Reverse Picking.	No	Customer Order	Boolean
Display Item Image for Customer Orders	Values: Yes/No Yes: Indicates item image will be displayed in Customer Orders. No: Image will not be displayed in Customer Orders.	No	Customer Order	Boolean
Minutes To Hold New Customer Order Before Sending Notification	Values: 0-999 This system parameter indicates the time interval in minutes to send a follow-up message to a store associated after a customer order (web order) has arrived, but no user has accessed the customer order.	5	Customer Order	Integer
Minutes To Hold Open Customer Order Pick Before Sending Notification	Values: 0-999 This system parameter dictates the time interval in minutes to send a follow-up message to a store associate after a pick list has been created but no one has started the pick list.	15	Customer Order	Integer
New Customer Order Notification	Values: Yes/No Yes: This parameter generates a notification for a new cross channel (web order) customer order. No: No notification is generated.	No	Customer Order	Boolean
New Customer Order Reverse Pick Notification	Values: Yes/No Yes: A notification alert is generated when a new system generated reverse pick comes into the system. No: A notification is not generated upon getting a new system generated reverse pick.	No	Customer Order	Boolean

Table 9-1 (Cont.) System Admin Parameters

Options	Description	Default Value	Topic	Type
Always Send DSD Receipt Cost	<p>Values: Yes/No</p> <p>Yes: When the receipt is published, the unit cost will be sent if there is not an override cost.</p> <p>No: When the receipt is published, only the override cost will be sent if it exists.</p>	No	DSD Receiving	Boolean
Days Beyond PO Not After Date	<p>This parameter is used to determine the Purchase Orders returned in the deliveries on Item Detail as well as calculating the On Order Qty.</p> <p>1. Planned Deliveries</p> <p>Ordered Qty needs to be taking the Not After Date into account.</p> <p>Purchase Order – only include those PO’s where Not After Date \geq Today + Days Beyond PO Not After Date</p> <p>Transfer – only include those transfers where Not After Date \geq Today</p> <p>2. Deliveries – Only display deliveries where:</p> <p>Purchase Order – only include those PO’s where Not After Date \geq Today + Days Beyond PO Not After Date</p> <p>Transfer – only include those transfers where Not After Date \geq Today</p>	50	DSD Receiving	Integer
Display Unit Cost for Direct Deliveries	<p>Values: Yes/No</p> <p>Yes: Display Unit Cost and allow editing when receiving. If On the system displays the original cost and allows entering the new cost for the on-the-fly and Dex/Nex deliveries. For the delivery with PO and ASN, it displays the unit cost. Display the Unit Cost on the Direct Delivery Report when printing.</p> <p>No: Do not display this data to the user in the DSD Receiving Containers screen. Do not display the unit cost on the Direct Delivery Report. If No the system does not display the unit cost and does not allow editing or entering new cost.</p>	Yes	DSD Receiving	Boolean
Displays Item Image for DSD Receiving	<p>Values: Yes/No</p> <p>Yes: This parameter indicates whether the item image will be displayed in Container Items and Item detail screens.</p> <p>No: Image will not be displayed in that functional area.</p>	No	DSD Receiving	Boolean
Displays Item Image for Purchase Order	<p>Values: Yes/No</p> <p>Yes: This parameter indicates if the item image will be displayed in Purchase Order Items screen.</p> <p>No: Image will not be displayed in that functional area.</p>	No	DSD Receiving	Boolean
DSD Receiving Preferred Currency	<p>Values: Store Currency/Supplier Currency</p> <p>This parameter will default the store or supplier currency to newly created POs depending on preference.</p>	Store Currency	DSD Receiving	Integer

Table 9–1 (Cont.) System Admin Parameters

Options	Description	Default Value	Topic	Type
Ignore the Supplier DSD indicator to create a PO on the fly	<p>Values: Yes/No</p> <p>Allows the system to ignore the supplier level indicator when creating a PO in the system.</p> <p>Yes: The system ignores the supplier level flag and will always allow stores to create purchase orders for any supplier based on the receipt.</p> <p>No: The system will verify creating a purchase order on the fly is allowed based on the supplier level flag.</p>	Yes	DSD Receiving	Boolean
Number of days received direct deliveries can be adjusted	<p>Values: 0-999</p> <p>0: no adjustment</p> <p>1: allowed to adjust until the end of today</p> <p>2: allowed to adjust until the end of tomorrow</p> <p>X: allowed to adjust until X number of days starting with today as day 1</p> <p>This parameter specifies the number of days received direct deliveries can be reopened and adjusted. If a direct delivery falls within the number of days, the system allows to adjust the received delivery. The user will be allowed to edit values and confirm the delivery.</p>	0	DSD Receiving	Integer
Over Received Quantity Notification	<p>Values: Yes/No</p> <p>This parameter will generate a notification when more than the expected quantity has been received and the store parameter Direct Delivery Auto Remove Over Received Quantity is set to yes.</p>	Yes	DSD Receiving	Boolean
Display Item Image for Inventory Adjustments - Execution	<p>Values: Yes/No</p> <p>Yes: The item image is displayed within Inventory Adjustments in SOCS.</p> <p>No: The item image is not displayed in Inventory Adjustments.</p>	No	Inventory Adjustment	Boolean
Display Item Image for Inventory Adjustments - Operations	<p>Values: Yes/No</p> <p>Yes: The item image is displayed within Inventory Adjustments in EICS.</p> <p>No: The item image is not displayed in Inventory Adjustments.</p>	No	Inventory Adjustment	Boolean
Display Item Image for Item Baskets - Execution	<p>Values: Yes/No</p> <p>Yes: The item image is displayed within Item Basket on the mobile.</p> <p>No: The item image is not displayed in Item Basket on the mobile.</p>	No	Item Basket	Boolean
Display Item Image for Item Baskets - Operations	<p>Values: Yes/No</p> <p>Yes: The item image is displayed within Item Basket on the desktop.</p> <p>No: The item image is not displayed in Item Basket on the desktop.</p>	No	Item Basket	Boolean

Table 9–1 (Cont.) System Admin Parameters

Options	Description	Default Value	Topic	Type
Display Item Image for Item Lookup - Execution	Values: Yes/No Yes: The item image is displayed within Item Lookup on SOCS. No: The item image is not displayed in Item Lookup.	No	Item Lookup	Boolean
Display Item Image for Item Lookup - Operations	Values: Yes/No Yes: This parameter indicates if the item image will be displayed in Item Lookup in EICS. It is in the list and the details. No: Image will not be displayed in Item Lookup.	No	Item Lookup	Boolean
Display Price in Search Result - Operations	Values: Yes/No This parameter decides whether Price and Pricing Type will be displayed in the search results in the Item Lookup screen in the desktop application. Yes: Price and Price Type will be displayed in the search results. No: Price and Price Type will not be displayed in the search results.	Yes	Item Lookup	Boolean
Display SOH/Price in Search Result - Execution	Values: Yes/No This parameter decides whether Price and Pricing Type will be displayed in the search results in the Item Lookup screen in the mobile application. Yes: Price and Price Type will be displayed in the search results. No: Price and Price Type will not be displayed in the search results.	Yes	Item Lookup	Boolean
Background Thread Count	Gives the thread count for background tasks in SOCS.	1	Mobile	Integer
Barcode Attribute Refresh Rate Milliseconds	Determines the cache refresh rate for barcode attribute labels in milliseconds.	3600000	Mobile	Integer
Configuration Refresh Rate Milliseconds	Determines the cache refresh rate for system configurations, store configurations, batch scheduler and MPS work type in milliseconds.	3600000	Mobile	Integer
Date Output Chinese China	This is to determine the date format based on the locale.	yy-MM-dd	Mobile	String
Date Output Chinese Hong Kong	This is to determine the date format based on the locale.	yy-MM-dd	Mobile	String
Date Output Chinese Taiwan	This is to determine the date format based on the locale.	yy-MM-dd	Mobile	String
Date Output English Australia	This is to determine the date format based on the locale.	dd-MM-yy	Mobile	String
Date Output English Canada	This is to determine the date format based on the locale.	dd-MM-yy	Mobile	String
Date Output English India	This is to determine the date format based on the locale.	dd-MM-yy	Mobile	String

Table 9–1 (Cont.) System Admin Parameters

Options	Description	Default Value	Topic	Type
Date Output English Ireland	This is to determine the date format based on the locale.	dd-MM-yy	Mobile	String
Date Output English South Africa	This is to determine the date format based on the locale.	yy-MM-dd	Mobile	String
Date Output English United Kingdom	This is to determine the date format based on the locale.	dd-MM-yy	Mobile	String
Date Output English United States	This is to determine the date format based on the locale.	MM-dd-yy	Mobile	String
Date Output French Belgium	This is to determine the date format based on the locale.	dd-MM-yy	Mobile	String
Date Output French Canada	This is to determine the date format based on the locale.	yy-MM-dd	Mobile	String
Date Output French France	This is to determine the date format based on the locale.	dd-MM-yy	Mobile	String
Date Output French Luxembourg	This is to determine the date format based on the locale.	dd-MM-yy	Mobile	String
Date Output French Switzerland	This is to determine the date format based on the locale.	dd-MM-yy	Mobile	String
Date Output German Austria	This is to determine the date format based on the locale.	dd-MM-yy	Mobile	String
Date Output German Germany	This is to determine the date format based on the locale.	dd-MM-yy	Mobile	String
Date Output German Luxembourg	This is to determine the date format based on the locale.	dd-MM-yy	Mobile	String
Date Output German Switzerland	This is to determine the date format based on the locale.	dd-MM-yy	Mobile	String
Date Output Italian Italy	This is to determine the date format based on the locale.	dd-MM-yy	Mobile	String
Date Output Japanese Japan	This is to determine the date format based on the locale.	yy-MM-dd	Mobile	String
Date Output Korean South Korea	This is to determine the date format based on the locale.	dd-MM-yy	Mobile	String
Date Output New Zealand	This is to determine the date format based on the locale.	dd-MM-yy	Mobile	String
Date Output Portuguese Brazil	This is to determine the date format based on the locale.	dd-MM-yy	Mobile	String
Date Output Portuguese Portugal	This is to determine the date format based on the locale.	dd-MM-yy	Mobile	String

Table 9–1 (Cont.) System Admin Parameters

Options	Description	Default Value	Topic	Type
Date Output Russian Russia	This is to determine the date format based on the locale.	dd-MM-yy	Mobile	String
Date Output Spanish Argentina	This is to determine the date format based on the locale.	dd-MM-yy	Mobile	String
Date Output Spanish Bolivia	This is to determine the date format based on the locale.	dd-MM-yy	Mobile	String
Date Output Spanish Chile	This is to determine the date format based on the locale.	dd-MM-yy	Mobile	String
Date Output Spanish Columbia	This is to determine the date format based on the locale.	dd-MM-yy	Mobile	String
Date Output Spanish Costa Rica	This is to determine the date format based on the locale.	dd-MM-yy	Mobile	String
Date Output Spanish Dominican Republic	This is to determine the date format based on the locale.	MM-dd-yy	Mobile	String
Date Output Spanish Ecuador	This is to determine the date format based on the locale.	dd-MM-yy	Mobile	String
Date Output Spanish El Salvador	This is to determine the date format based on the locale.	MM-dd-yy	Mobile	String
Date Output Spanish Guatemala	This is to determine the date format based on the locale.	dd-MM-yy	Mobile	String
Date Output Spanish Honduras	This is to determine the date format based on the locale.	MM-dd-yy	Mobile	String
Date Output Spanish Mexico	This is to determine the date format based on the locale.	dd-MM-yy	Mobile	String
Date Output Spanish Nicaragua	This is to determine the date format based on the locale.	MM-dd-yy	Mobile	String
Date Output Spanish Panama	This is to determine the date format based on the locale.	MM-dd-yy	Mobile	String
Date Output Spanish Paraguay	This is to determine the date format based on the locale.	dd-MM-yy	Mobile	String
Date Output Spanish Peru	This is to determine the date format based on the locale.	dd-MM-yy	Mobile	String
Date Output Spanish Puerto Rico	This is to determine the date format based on the locale.	MM-dd-yy	Mobile	String
Date Output Spanish Spain	This is to determine the date format based on the locale.	dd-MM-yy	Mobile	String
Date Output Spanish Uruguay	This is to determine the date format based on the locale.	dd-MM-yy	Mobile	String

Table 9–1 (Cont.) System Admin Parameters

Options	Description	Default Value	Topic	Type
Date Output Spanish Venezuela	This is to determine the date format based on the locale.	dd-MM-yy	Mobile	String
Enable Device Camera Barcode Scan	Used for enabling device camera for scanning on SOCS.	No	Mobile	Boolean
External Scanner Refresh Rate Milliseconds	Determines the cache refresh rate for external scanner in millisecond.	3600000	Mobile	Integer
Inventory Adjustment Reason Refresh Rate Milliseconds	Determines the cache refresh rate for inventory adjustment reason in milliseconds on SOCS.	3600000	Mobile	Integer
Item Image Refresh Rate Milliseconds	Determines the cache refresh rate for item image in milliseconds on SOCS.	3600000	Mobile	Integer
Manual Quantity Entry Default Mode	Values: Scan Mode/Override Scan Mode - the numeric entry popup on mobile will have its mode defaulted per the scan mode (as it has always done) Override - the numeric entry popup on mobile will have its mode always defaulted to override, and it will not look at the scan mode.	Scan Mode	Mobile	Integer
Non-Sellable Quantity Type Refresh Rate Milliseconds	Determines the cache refresh rate for non-sellable quantity types in milliseconds on SOCS.	3600000	Mobile	Integer
Notification Count Refresh Rate Milliseconds	Determines the cache refresh rate for notifications in milliseconds on SOCS.	300000	Mobile	Integer
RFID Zone Refresh Rate Milliseconds	Determines the cache refresh rate for RFID zones in milliseconds in the system.	3600000	Mobile	Integer
Scan Focus Item Detail	Determines if sticky focus is enabled on SOCS screens. Yes: Focus will automatically be in the Scan field when on a screen with the scan bar. The system will retain focus in the scan bar field until an error arises or until the user/system moves focus to somewhere else. The keyboard will display on the mobile device while scanning/entering the scan bar field. This is because the system believes you are typing into the field. No: Focus will not stay in the scan bar.	No	Mobile	Boolean
Sound Error Enabled	Determines if severe error sound will be played in case of severe errors on SOCS.	Yes	Mobile	Boolean
Sound Information Enabled	Determines if information sound effect will be played on SOCS.	Yes	Mobile	Boolean
Sound Scan Enabled	Determines if beep sound will be played on scan on SOCS.	Yes	Mobile	Boolean

Table 9-1 (Cont.) System Admin Parameters

Options	Description	Default Value	Topic	Type
Sound Warning Enabled	Determines if a business error sound will be played on business errors on SOCS.	Yes	Mobile	Boolean
Store Printer Refresh Rate Milliseconds	Determines the cache refresh rate for store printer in milliseconds on SOCS.	3600000	Mobile	Integer
Store Refresh Rate Milliseconds	Determines the cache refresh rate for notifications in milliseconds on EICS and SOCS.	3600000	Mobile	Integer
Tablet Mode Screen Size	Determines the screen size for tablet mode for SOCS.	16,5	Mobile	.Double
UOM Conversion Refresh Rate Milliseconds	Determines the cache refresh rate for UOM conversion in milliseconds	3600000	Mobile	Integer
Vibration Enabled	Determines if vibration is enabled on errors on SOCS.	No	Mobile	Boolean
MPS Enabled	Determines if MPS is enabled which in turn determines if MPS work types can be enabled.	Yes	MPS	Boolean
MPS Increment Threads	Determines the allowed thread increment factor for MPS work types.	2	MPS	Integer
MPS Maximum Queue Age Seconds	Determines the maximum seconds before MPS work queue needs to be refreshed.	180	MPS	Integer
MPS Maximum Queue Size	Determines the maximum size limit for generating MPS work queues.	1000	MPS	Integer
MPS Maximum Threads	Determines the maximum thread count for MPS work types.	8	MPS	Integer
MPS Refresh Rate Seconds	Determines the MPS work queue refresh rate after checking for the system parameter MPS Maximum Queue Age Seconds. If the MPS Maximum Queue Age Seconds has not exceeded, then this parameter is checked to determine if MPS work queue needs to be refreshed.	15	MPS	Integer
Seconds to Check for Notifications	Defines how many seconds the system will check for new notifications. This applies to any notification inserted into the system.	300	Notification	Integer
Days to Hold Areas	Values: 1-999 Purge all areas that are greater than or equal today's date minus the days to hold value.	60	Purge	Integer
Days to Hold Audit Records	Audit Records are log of activities and usage information in the system. This parameter is to determine the number of days to hold the audit records. The batch will delete all records where the create date is less than or equal to current date minus the days to hold.	45	Purge	Integer
Days To Hold Batch Logs	Delete all logs where the log date is less than or equal to the current date minus the days to hold for any records.	30	Purge	Integer

Table 9-1 (Cont.) System Admin Parameters

Options	Description	Default Value	Topic	Type
Days to Hold Completed Inventory Adjustments	Delete records in 'Complete' Status where the inventory complete date is less than or equal to the current date minus the days to hold.	30	Purge	Integer
Days to Hold Completed Purchase Orders	Purge all records in 'Closed' status after 'x' number of days defined by user, where the complete date (the date of when all items were received on the order) is less than or equal to the current date minus the days to hold.	30	Purge	Integer
Days to Hold Completed Staging Records	Delete all records that have been processed successfully or deleted where the update date is less than or equal to the current date minus the days to hold for any records.	3	Purge	Integer
Days to Hold Completed Stock Counts	Purges any records 'x' days after the last stock count event has occurred. In other words, when the schedule date is less than or equal to the current date the system will subtract the days to hold completed stock counts from the date and delete when this date is reached. The purging will occur when the stock count has a status of 'Complete'.	30	Purge	Integer
Days to Hold Completed UINs	Indicates how long completed UINs are kept in the system. Completed UINs are defined as any UIN that is in one of the following statuses: Sold Shipped to Warehouse Shipped to Vendor Shipped to Finisher Removed from Inventory Customer Fulfilled	120	Purge	Integer
Days to Hold Customer Orders	Indicates the number of days that Cancelled and Fulfilled Customer Orders will be held in the system before being purged.	60	Purge	Integer
Days to Hold Expired item price	Indicates the number of days to hold the expired price changes in the system before being purged.	30	Purge	Integer
Days to Hold Expired User Roles	Values: 0-999 This will determine the number of days after which the expired roles will be purged from the system	30	Purge	Integer
Days to Hold In Progress Ad Hoc Stock Counts	Ad hoc stock counts that are In Progress will be deleted through the purge process. Any ad hoc count with a creation date/time stamp older than this parameter value will be deleted. For example, the default value of 1 would delete all in progress counts more than 24 hours old when the batch is run.	1	Purge	Integer
Days to Hold Item Basket	Values: 1-999 This will determine the number of days to hold 'Canceled' and 'Completed' Item Baskets.	60	Purge	Integer

Table 9-1 (Cont.) System Admin Parameters

Options	Description	Default Value	Topic	Type
Days to Hold Locking Records	Locking records will be purged through a batch process and the batch process will account for all locking activity across all functional areas. This is to determine the number of days to hold the locking records. The batch will delete all locking behavior around all functional areas where the lock date is less than or equal to the current business date minus the days to hold.	3	Purge	Integer
Days to Hold Notifications	This parameter is used to purge notifications which are greater than or equal to this value.	14	Purge	Integer
Days to Hold Price Change Worksheet Records	Records in the price change staging / worksheet table will be purged based upon this parameter.	30	Purge	Integer
Days to Hold Price History	The 'Days to Hold Price History' parameter allows the user to keep records beyond the 4 most recent historical prices for 'x' number of days if desired. Prices in the future will not be deleted and will not be included as part of the four historical prices that will remain on the database.	90	Purge	Integer
Days to Hold Received Shipment Records	Values: 0 - 999 Purge all PO and DSD Delivery records in 'Received' and 'Cancelled' status after 'x' number of days defined by user, where the inventory completed date is less than the current date minus the days to hold. There is a receipt record that will be deleted along with any record that is in 'Received' status.	30	Purge	Integer
Days to Hold Related Items	To determine when a related item should be purged. Program will purge Related items that have an end date in the past. The system will purge the related items after 'x' number of days defined by user, where the related items End Date is less than the current date minus the days to hold.	60	Purge	Integer
Days to Hold Resolved UIN Exceptions	Indicates how long resolved UIN exceptions are kept in the system. The date the exception was resolved is the date the system uses to determine if the exception is ready to be purged.	120	Purge	Integer
Days to Hold RFID	Indicates how long the RFID data that are not present in the store is kept in the system.	999	Purge	Integer
Days to Hold RFID History	Values: 0 - 999 This parameter will purge RFID history that is greater than or equal today's date minus the days to hold value.	120	Purge	Integer
Days to Hold RTV	Values: 0 - 999 This parameter will decide that which RTV documents and Shipments need to be purged. The value in this parameter will decide the number of days after a RTV document or shipment gets into cancelled or completed status for document and cancelled or shipped for shipment	30	Purge	Integer

Table 9–1 (Cont.) System Admin Parameters

Options	Description	Default Value	Topic	Type
Days to Hold Sales Posting	The audit trail for the sales posting will be purged on a periodic basis based on the specified parameter. The system will purge all records from the database after the configurable number of days, where the processed date is less than or equal to current date minus the days to hold	120	Purge	Integer
Days to Hold Scan Lists	Purge any records in 'Complete' or 'Cancelled' status where the post date is less than or equal to the current date minus the days to hold	1	Purge	Integer
Days to Hold Shelf Adjustment Lists	Purge any records in 'Complete' or 'Cancelled' status where the post date is less than or equal to the current date minus the days to hold	30	Purge	Integer
Days to Hold Shelf Replenishments	Purge any records in 'Complete' or 'Cancelled' status where the post date is less than or equal to the current date minus the days to hold.	1	Purge	Integer
Days to Hold Store Orders	Purge any records in 'Approved' or 'Canceled' status where the post date is less than or equal to the current date minus the days to hold.	60	Purge	Integer
Days to Hold Temporary UINs	To indicate how long the temporary UINs must stay in the system.	120	Purge	Integer
Days to Hold Ticket History	To indicate how long the tickets that printed and persisted in the history table must stay.	60	Purge	Integer
Days to Hold Transaction History	Determines the number of days after which store_item_stock_history records can be purged.	30	Purge	Integer
Days to Hold Transfer Documents	Values: 0 -999 This parameter would decide the number of days after which a Transfer document, shipments, and deliveries can be purged.	30	Purge	Integer
Days to Hold UIN Audit Information	Indicates how long UIN audit information is kept in the system. Audit information can be purged for a UIN within the system. The date the audit transaction was captured is used to determine if the record needs to be purged.	120	Purge	Integer
Number of days to keep the SFTP Log file	To determine the number days to hold the SFTP log files.	7	Purge	Integer
Display Item Image for RFID Locator	Values: Yes/No Yes: This parameter indicates if the item image will be displayed in the RFID Locator dialog in mobile application. No: The image will not be displayed.	No	RFID Locator	Boolean
Days to send Notification before not after date for return requests	Values: 0-999 RTV requests generated in an external system sometimes require the RTV to be dispatched to supplier before a certain date. This option prompts the recipient of the e-mail the specified number of days before the not after date is reached, if the RTV was not dispatched.	2	RTV	Integer

Table 9-1 (Cont.) System Admin Parameters

Options	Description	Default Value	Topic	Type
Displays Item Image for RTV Requests	<p>Values: Yes/No</p> <p>Yes: This parameter indicates if the item image will be displayed in that transaction. It is in the item list and the details of the transaction.</p> <p>No: Image will not be displayed in that functional area.</p>	No	RTV	Boolean
DSD delivery supplier for RTV	<p>Values: Yes/No</p> <p>This indicator will check to see if the DSD allowed indicator needs to be set in addition to the return allowed values when creating a supplier return.</p> <p>Yes: If the “DSD delivery supplier for RTV” system option is set to ‘On’, then the system needs to check both the DSD indicator (Indicator on Supplier table which determines whether a supplier can create a new Purchase Order) and the return allowed indicator (also an indicator on the supplier table).</p> <p>No: If the “DSD delivery supplier for RTV” system option is set to ‘No’, then only the return allowed indicator needs to be validated for supplier returns.</p> <p>Note: regardless of the indicator, the system should always be able to dispatch the RTV if it was created in an external system.</p>	Yes	RTV	Boolean
RTV Unavailable Request Qty Notification	<p>Values: Yes/No</p> <p>This system parameter will generate notification when “Auto Approve RTV request” parameter is set to On, and the request has unavailable quantity greater than the stock.</p>	Yes	RTV	Boolean
Displays Item Image for RTV Shipment	<p>Values: Yes/No</p> <p>Yes: This parameter indicates if the item image will be displayed in that transaction. It is in the item list and the details of the transaction.</p> <p>No: Image will not be displayed in that functional area.</p>	No	RTV Shipment	Boolean
Display Item Image for Replenishment Pick	<p>Values: Yes/No</p> <p>Yes: This parameter indicates if the item image will be displayed in the replenishment pick. It is in the item list and the details of the transaction.</p> <p>No: Image will not be displayed in that functional area.</p>	No	Shelf Replenishment	Boolean
Display Item Image for Scan List	<p>Values: Yes/No</p> <p>Yes: This parameter indicates if the item image will be displayed in the scan list. It is in the item list and the details of the transaction.</p> <p>No: Image will not be displayed in that functional area.</p>	No	Shelf Replenishment	Boolean

Table 9–1 (Cont.) System Admin Parameters

Options	Description	Default Value	Topic	Type
Display Item Image for Shelf Adjustment	<p>Values: Yes/No</p> <p>Yes: This parameter indicates if the item image will be displayed in the shelf adjustment. It is in the item list and the details of the transaction.</p> <p>No: Image will not be displayed in that functional area.</p>	No	Shelf Replenishment	Boolean
Display Item Image for Stock Counts - Execution	<p>Values: Yes/No</p> <p>Yes: This parameter indicates if the item image will be displayed in the stock counts. It is in the item list and the details of the transaction.</p> <p>No: The image will not be displayed.</p>	No	Stock Counts	Boolean
Display Item Image for Stock Counts - Operations	<p>Values: Yes/No</p> <p>Yes: This parameter indicates if the item image will be displayed in the stock counts functionality in EICS.</p> <p>No: The image will not be displayed.</p>	No	Stock Counts	Boolean
Stock Count Display Default Timeframe	<p>This parameter is to determine whether the system must prompt the user to select to whether it is performed before store open or after store close.</p>	No	Stock Counts	Boolean
Stock Count Lockout Days	<p>Stock Count Lockout Days is used to determine when a Unit and Amount Stock Count can be generated. The system will take this value plus the system date and enforce a start date of the schedule to be greater than or equal to that date.</p> <p>Note: If the system is integrated with the merchandising system, the values in the two systems must be the same.</p>	1	Stock Counts	Integer
Stock Count Null Count Quantity = 0	<p>Values: Yes/No</p> <p>Yes: The system changes the quantity to zero for items not counted (null quantity to zero), which makes the items appear as though they were counted.</p> <p>No: The system does not change the quantity to zero for items not counted, but rather leaves the value as null. These items will still appear as though they were not counted.</p> <p>Note This parameter does not apply to Unit and Amount stock counts.</p>	No	Stock Counts	Boolean
Unguided Stock Count Allow Multiple Users	<p>Values: Yes/No</p> <p>This parameter controls whether more than one user can scan simultaneously again the same child stock count for an unguided count.</p> <p>Yes: The system will allow more than one user to access the same stock count, child count.</p> <p>No: The system will allow more than one user to access the same stock count, but only one user may access a child stock count at a time.</p>	No	Stock Counts	Boolean

Table 9–1 (Cont.) System Admin Parameters

Options	Description	Default Value	Topic	Type
Unguided Stock Counts Automatic Save	<p>Values: Yes/No</p> <p>Yes: The physical count timestamp and item count quantity are automatically saved when the next item on the count is scanned.</p> <p>No: The physical count timestamp and item count quantity are saved when the user manually saves the count. It is assumed with this option the user frequently saves.</p> <p>Note: The physical count timestamp is taken when the user scans the item for the first time.</p>	No	Stock Counts	Boolean
Unit and Amount Stock Count Sales Processing	<p>Values: Timestamp Processing, Daily Sales Processing</p> <p>Timestamp Processing: This option is used when sales data is available near real-time with a date and time available on the transaction. The user is not prompted to select Before Store Open or After Store Close when starting the stock count since the sales timestamp will be used to compare with the timestamps taken during the stock count.</p> <p>Daily Sales Processing: This option is used when sales data is only available with a date and no time is provided and/or when integrated with RMFCS. The user is either prompted or the store parameter determines when the stock count is performed, (before store opens or after store close). The date is used to determine if a sale is late or not.</p> <p>Note:</p> <p>Unit and Amount stock counts require some dual processing in RMFCS for capturing the financial value. RMS is only capable of processing sales data on a daily basis and disregards the time value if included.</p>	Timestamp	Stock Counts	Integer
Unit Stock Count Sales Processing	<p>Values: Timestamp Processing, Daily Sales Processing</p> <p>Timestamp Processing: This option is used when sales data is available near real-time with a date and time available on the transaction. The user is not prompted to select Before Store Open or After Store Close when starting the stock count since the sales timestamp will be used to compare with the timestamps taken during the stock count.</p> <p>Daily Sales Processing: This option is used when sales data is only available with a date and no time is provided. The date is used to determine if a sale is late or not.</p>	Timestamp	Stock Counts	Integer
Update Stock On Hand	<p>Values: Yes/No</p> <p>Yes will update SOH.</p> <p>No will not update SOH.</p>	No	Stock Counts	Boolean

Table 9–1 (Cont.) System Admin Parameters

Options	Description	Default Value	Topic	Type
Update Stock On Hand	<p>Values: All/Discrepant</p> <p>Discrepant Items only: The system will update only items identified as discrepant when the Update Auth Qty button is selected and when the stock count has been authorized, only the SOH is updated for the discrepant items only.</p> <p>All Items: The system will update all items regardless of if they are discrepant or not when the Update Auth Qty button is selected and when the stock count has been authorized, the SOH is updated for all items, including the non-discrepant.</p> <p>Note: Discrepant items are defined as items having a counted to actual variance greater than the pre-configured allowed variance. Non-discrepant items have a difference between the counted and actual qty, but they are within a tolerated variance. Unit and Amount stock counts will disregard this setting since all items will always be updated for that type of stock count.</p>	1	Stock Counts	Integer
Auto Approve Store Orders	<p>Values: Yes/No</p> <p>Yes: external store orders will be auto approved based upon the Days before auto approving Store Orders parameter</p> <p>No: external store orders will not be auto approved.</p>	Yes	Store Order	Boolean
Days before auto approving Store Orders	<p>Values: 0-999</p> <p>The number of days before setting external Store Orders to approved status.</p>	0	Store Order	Boolean
Days to hold before Auto Canceling Store Orders	<p>Values: 0-999</p> <p>The number of days before setting store orders to canceled status.</p>	0	Store Order	Integer
Display Item Image Store Orders - Execution	<p>Values: Yes/No</p> <p>Yes: This parameter indicates that item image will be displayed in Store Orders.</p> <p>No: Images will not be displayed in Store Orders.</p>	No	Store Order	Boolean
Carrier Service Refresh Rate Milliseconds	Determines the cache refresh rate for carrier service in milliseconds	3600000	System Settings	Integer
Carton Type Refresh Rate Milliseconds	Determines the cache refresh rate for carton type in milliseconds.	3600000	System Settings	Integer
Context Type Refresh Rate Milliseconds	Determines the cache refresh rate for context type in milliseconds	3600000	System Settings	Integer
Data seed on error continue	<p>Values: Yes/No</p> <p>Indicating if terminate data Boolean seeding process on data failures.</p>	No	System Settings	Boolean
Database Clock Refresh Rate Milliseconds	Determines the cache refresh rate for database clock in milliseconds.	10800000	System Settings	Integer

Table 9-1 (Cont.) System Admin Parameters

Options	Description	Default Value	Topic	Type
Default POS transaction max size	Determines the max size of pos transaction records that can be processed in one pos transaction web service call.	1000	System Settings	Integer
Item Image Request Timeout Milliseconds	When loading an item image from an external server, the amount of time before we timeout the request.	25000	System Settings	Integer
JNDI Context Refresh Rate Milliseconds	Determines the cache refresh rate for JNDI context for RIB message publisher in milliseconds.	900000	System Settings	Integer
Merchandise Hierarchy Refresh Rate Milliseconds	Determines the cache refresh rate for merchandise hierarchy in milliseconds.	3600000	System Settings	Integer
POS Transaction Max. Size for Synchronous Processing	Determines the maximum processing size for pos transaction records. All pos transaction records above this value are staged first.	10	System Settings	Integer
Price default extract size	Determines the default extract size for price change import file for Regular, Promotion and Clearance price change batch jobs.	1000	System Settings	Integer
Price History Refresh Rate Milliseconds	Determines the cache refresh rate for item price history in milliseconds.	3600000	System Settings	Integer
Print Format Refresh Rate Milliseconds	Determines the cache refresh rate for print format types in milliseconds.	3600000	System Settings	Integer
Publish Non Inventory Items	Values: Yes/No This parameter indicates whether the non-inventory items will be published in the outgoing messages or not.	Yes	System Settings	Boolean
Serialization Label Refresh Rate Milliseconds	Indicates serialization label refresh rate in milliseconds.	3600000	System Settings	Integer
Shipment Reason Refresh Rate Milliseconds	Determines the cache refresh rate for finisher shipment reason in milliseconds.	3600000	System Settings	Integer
Store Shipment Reason Refresh Rate Milliseconds	Determines the cache refresh rate for store shipment reason in milliseconds.	3600000	System Settings	Integer
Supplier Refresh Rate Milliseconds	Determines the cache refresh rate for supplier in milliseconds.	3600000	System Settings	Integer
Supplier Shipment Reason Refresh Rate Milliseconds	Determines the cache refresh rate for supplier shipment reason in milliseconds.	3600000	System Settings	Integer
Translation Refresh Rate Milliseconds	Determines the cache refresh rate for locale and translations in milliseconds.	3600000	System Settings	Integer
Uda Details Refresh Rate Milliseconds	Determines the cache refresh rate for UDA details in milliseconds.	3600000	System Settings	Integer

Table 9–1 (Cont.) System Admin Parameters

Options	Description	Default Value	Topic	Type
User Authorization Cache Refresh Rate Milliseconds	Determines the cache refresh rate for user authorization cache in milliseconds.	600000	System Settings	Integer
Warehouse Refresh Rate Milliseconds	Determines the cache refresh rate for warehouse in milliseconds.	3600000	System Settings	Integer
Warehouse Shipment Reason Refresh Rate Milliseconds	Determines the cache refresh rate for warehouse shipment reason in milliseconds.	3600000	System Settings	Integer
Display Item Image for Ticket - Execution	This indicates whether the item image must be displayed in the ticketing dialog in mobile application.	No	Ticketing	Integer
Display Item Image for Ticket - Operations	This indicates whether the item image must be displayed in the ticketing dialog in desktop application.	No	Ticketing	Integer
Daily GMT Batch Run	Values: Yes/No Yes: Program will only be run once a day. The server is running on GMT and the dates for processing are still stored in GMT. The batch will process everything for the GMT day the server is in, including future records for the same day as the server GMT day.	Yes	Time Zone	Boolean
Enable GMT for Customer Orders	Values: Yes/No This is to determine whether the customer orders uploaded in the system are in GMT.	No	Time Zone	Boolean
Enable GMT for Dex/Nex	Values: Yes/No This parameter will dictate whether the DEX/NEX data being loaded into the system is in GMT.	No	Time Zone	Boolean
Enable GMT for Direct Deliveries	Values: Yes/No This parameter will dictate whether the Direct Delivery messages published by an external system should have dates in GMT or not. Yes: When publishing the Direct Delivery messages, it means that the dates in the message should be written in GMT. When subscribing to the purchase order messages, it means that the dates are coming in, in GMT time and no conversion needs to occur. When publishing a purchase order message, it means that the dates in the message should be written in GMT. No: When publishing the direct delivery messages, it means that the dates in the message should be converted from GMT and written in the store's local date/time. When subscribing to the purchase order message, it means that the dates are coming in, in are in the store's local date/time and must be converted to GMT prior to persisting the date in the database. When publishing the purchase order message, it means that the dates in the message should be converted from GMT and written in the store's local date/time.	No	Time Zone	Boolean

Table 9–1 (Cont.) System Admin Parameters

Options	Description	Default Value	Topic	Type
Enable GMT for Foundation Data	Values: Yes/No This parameter will dictate whether any foundation data messages being loaded into the system are in GMT.	No	Time Zone	Boolean
Enable GMT for Initial Inventory Import	Values: Yes/No This parameter will determine whether the date/time stamp in the Initial Inventory Import file (.DAT file) is in GMT or not.	No	Time Zone	Boolean
Enable GMT for Inventory Adjustments	Values: Yes/No This new system parameter will determine which date/time stamp is used in the inventory adjustment message when it is being published. Yes: When publishing the inventory adjustment message, it means that the dates in the message should be written in GMT. No: When publishing the inventory adjustment message, it means that the dates in the message should be converted from GMT and written in the store's local date/time.	No	Time Zone	Boolean
Enable GMT for POS sale import process	Values: Yes/No This parameter will dictate whether the POS data being loaded into the system are in GMT.	No	Time Zone	Boolean
Enable GMT for Price Changes	Values: Yes/No This parameter will dictate whether the price changes being subscribed to by the system are time zone sensitive. Yes: When subscribing to a price change, it means that the effective date is coming in GMT time and no conversion needs to occur. No: The effective date must be converted prior to storing the price change in the system.	No	Time Zone	Boolean
Enable GMT for Receiving	Values: Yes/No This parameter will dictate whether receiving messages need to be published in GMT or not.	No	Time Zone	Boolean
Enable GMT for ReSA sale import process	Values: Yes/No This parameter will dictate whether the ReSA data being loaded into the system are in GMT.	No	Time Zone	Boolean

Table 9–1 (Cont.) System Admin Parameters

Options	Description	Default Value	Topic	Type
Enable GMT for RTVs	<p>Values: Yes/No</p> <p>This system parameter will dictate whether the RTV message being loaded into the system is in GMT. Likewise, if the system publishes any RTV message this will determine which date/time stamp is used on the message as well</p> <p>Yes: When subscribing to the RTV message, it means that the dates are coming in, in GMT time and no conversion needs to occur.</p> <p>When publishing the RTV message, it means that the dates in the message should be written in GMT.</p> <p>No: When subscribing to the RTV message, it means that the dates are in the store's local date/time and must be converted to GMT prior to persisting the date in the database.</p> <p>When publishing the RTV message, it means that the dates in the message should be converted from GMT and written in the store's local date/time</p>	No	Time Zone	Boolean
Enable GMT for Stock Counts	<p>Values: Yes/No</p> <p>This parameter will determine which date/time stamp is used in the stock count message when it is being published.</p> <p>Yes: When publishing the stock count message, it means that the dates in the message should be written in GMT.</p> <p>No: When publishing the stock count message, it means that the dates in the message should be converted from GMT and written in the store's local date/time.</p>	No	Time Zone	Boolean
Enable GMT for Store Orders	<p>Values: Yes/No</p> <p>This parameter will determine which date/time stamp is used in the store order message when it is being published.</p> <p>Yes: When publishing the store order message, it means that the dates in the message should be written in GMT.</p> <p>No: When publishing the store order message, it means that the dates in the message should be converted from GMT and written in the store's local date/time.</p>	No	Time Zone	Boolean

Table 9–1 (Cont.) System Admin Parameters

Options	Description	Default Value	Topic	Type
Enable GMT for Store Transfers	<p>Values: Yes/No</p> <p>This new system parameter will dictate whether the Transfer messages being loaded into the system from an external system has dates in GMT or not. Likewise, if the system publishes any Transfer messages to an external system this will determine which date/time stamp is used on the message as well.</p> <p>Yes: When subscribing to the Transfer messages, it means that the dates are coming in, in GMT time and no conversion needs to occur.</p> <p>When publishing a transfer message, it means that the dates in the message should be written in GMT.</p> <p>No: When subscribing to the transfer message, it means that the dates are coming in, in are in the store's local date/time and must be converted to GMT prior to persisting the date in the database.</p> <p>When publishing the transfer message, it means that the dates in the message should be converted from GMT and written in the store's local date/time.</p>	No	Time Zone	Boolean
Enable GMT for Third Party Stock Counts	<p>Values: Yes/No his parameter will determine whether the date/time stamp in the Third party stock count file (DSL DAT) is in GMT or not.</p>	No	Time Zone	Boolean
Enable GMT for Vendor ASN	<p>Values: Yes/No</p> <p>This parameter will dictate whether the Vendor ASN messages being loaded into the system have dates in GMT or not.</p>	No	Time Zone	Boolean
Enable GMT for Warehouse Transfers	<p>Values: Yes/No</p> <p>This new system parameter will dictate whether the transfer messages being loaded into the system have GMT dates or not. Likewise, if the system publishes any transfer message to an external system this will determine which date/time stamp is used on the message as well.</p> <p>Yes: When subscribing to the transfer messages, it means that the dates are coming in, in GMT time and no conversion needs to occur.</p> <p>When retrieving transfer data, it means that the dates are in GMT time and no conversions needs to occur. This includes both reading and writing data.</p> <p>When publishing a transfer message, it means that the dates in the message should be written in GMT.</p> <p>No: When subscribing to the transfer message, it means that the dates are coming in, in are in the store's local date/time and must be converted to GMT prior to persisting the date in the database.</p> <p>When retrieving transfer data, it means that the dates are not in GMT time and must be converted to GMT. This includes both reading and writing data.</p> <p>When publishing the transfer message, it means that the dates in the message should be converted from GMT and written in the store's local date/time.</p>	No	Time Zone	Boolean

Table 9–1 (Cont.) System Admin Parameters

Options	Description	Default Value	Topic	Type
Damaged Delivery Notification	<p>Values: Yes/No</p> <p>Yes: Sends a notification to the receiving store when damaged items are received on the delivery.</p> <p>No: No alert is sent. This parameter generates a notification for transfers with items marked as damaged (Warehouse, Store, Finisher).</p>	Yes	Transfer Receiving	Boolean
Days Shipped Delivery Overdue Notification	<p>Values: 1-999</p> <p>This parameter generates a notification when the delivery is overdue. The delivery will be considered overdue when the create date of the delivery plus the days from this parameter have passed. This will include only deliveries from source type store.</p>	7	Transfer Receiving	Integer
Display Item Image for Transfer Receiving	<p>Values: Yes/No</p> <p>Yes: This parameter indicates if the item image will be displayed in that transaction. It is in the item list and the details of the transaction.</p> <p>No: Image will not be displayed in that functional area.</p>	No	Transfer Receiving	Boolean
External Finisher UIN Qty Discrep Notification	<p>Values: Yes/No</p> <p>This system parameter will generate notification when there is a discrepancy with the number of UINs on the ASN and the UINs received when auto receiving with a Source Type of 'Finisher'.</p> <p>Yes: Whenever the transaction cannot be auto received, the system generates a notification when there is a discrepancy with the number of UINs on the Finisher Return and the UINs received.</p> <p>Auto Received by batch</p> <p>Auto Received thru RIB Injector.</p> <p>No: No alert is generated.</p>	Yes	Transfer Receiving	Boolean
Misdirected Container Notification	<p>Values: Yes / No</p> <p>Yes: Sends a notification when a location receives a container belonging to another location.</p> <p>No: No notification is sent.</p> <p>This system parameter will generate a notification when there is a misdirected container that has been received in another location.</p>	Yes	Transfer Receiving	Boolean
Number of Days Received Transfer Deliveries can be Adjusted	<p>Values: 0-999</p> <p>This parameter controls the number of days a container can be adjusted within a receipt after (Warehouse, Store, Finisher) are received.</p> <p>0: no adjustment allowed</p> <p>1: allowed to adjust until the end of today</p> <p>2: allowed to adjust until the end of tomorrow</p> <p>X: allowed to adjust until x days starting from today</p>	0	Transfer Receiving	Integer

Table 9-1 (Cont.) System Admin Parameters

Options	Description	Default Value	Topic	Type
Quick Receiving - Receive misdirected containers	<p>Values: Yes/No</p> <p>Yes: Enables the ability to receive misdirected containers.</p> <p>No: Disables the ability to receive misdirected containers.</p>	Not Allowed	Transfer Receiving	Integer
Quick Receiving - Receive missing containers	<p>Values: Yes/No</p> <p>Yes: Enables the ability to receive missing containers.</p> <p>No: Disables the ability to receive missing containers.</p>	Yes	Transfer Receiving	Boolean
Receive Entire Transfer	<p>Values: Yes/No</p> <p>Yes: User is ONLY allowed to receive the entire delivery. It is not allowed to add any items, only confirmation of the receipt is allowed (Warehouse, Store, Finisher).</p> <p>No: The user is not limited to only receiving the entire delivery.</p>	No	Transfer Receiving	Boolean
Store Receiving Force Close Indicator	<p>Values: RL / SL / NL This parameter applies to deliveries with a Source Type of 'Store'.</p> <p>RL: (Receiver Loss) Any shipped quantity that was not received is a loss at the receiving store.</p> <p>SL: (Sending Loss) Any shipped quantity that was not received is a loss at the sending store.</p> <p>NL: (No Loss) Any shipped quantity that was not received does not affect the receiving or the sending store.</p>	Receiving Loss	Transfer Receiving	Integer
Store Receiving Over/Under Notification	<p>Values: Yes / No</p> <p>This parameter generates a notification to the receiving store when items on a transfer receipt with a Source Type of 'Store' is greater than or less than the expected quantity or if the expected quantity is null or zero. A notification should not be sent in the case of a manually created container or a copied misdirected container.</p> <p>On: Sends a notification when the receiving store over or under receives goods.</p> <p>No: No alert is sent.</p>	Yes	Transfer Receiving	Boolean
Warehouse/Store UIN Qty Discrep Notification	<p>Values: Yes/No</p> <p>This system parameter will generate notification when there is a discrepancy with the number of UINs on the ASN and the UINs received when auto receiving a warehouse or store delivery with a Source Type of 'Warehouse' or 'Store'.</p> <p>Yes: Sends a notification when there is a discrepancy with UINs on the ASN. The number of UINs on the ASN and the Qty received do not match and cannot be auto received.</p> <p>Auto Received by batch (Store), (Warehouse) Auto Received thru RIB Injector</p> <p>No: No notification is generated.</p>	Yes	Transfer Receiving	Boolean

Table 9–1 (Cont.) System Admin Parameters

Options	Description	Default Value	Topic	Type
Display Item Image for Transfer Shipment	<p>Values: Yes/No</p> <p>Yes: This parameter indicates if the item image will be displayed in that transaction. It is in the item list and the details of the transaction.</p> <p>No; Image will not be displayed in that functional area.</p>	No	Transfer Shipment	Boolean
Days to send Notification before not after date for transfer requests	<p>Values: 0-999</p> <p>For transfer requests generated in an external system (warehouse, store or finisher), his option sends a notification the specified number of days before the not after date is reached, if the transfer was not dispatched.</p>	2	Transfers	Integer
Display Item Image for Transfer	<p>Values: Yes/No</p> <p>Yes: This parameter indicates if the item image will be displayed in that transaction. It is in the item list and the details of the transaction.</p> <p>No: Image will not be displayed in that functional area.</p>	No	Transfers	Boolean
Transfer Request Approve Notification	<p>Values: Yes/No</p> <p>Yes: A notification will be generated when a requested transfer is approved.</p> <p>No: No notification will be generated.</p> <p>Note: The notification will only be generated for SIOCS initiated store to store requests.</p>	No	Transfers	Boolean
Transfer Request Notification	<p>Values: Yes/No</p> <p>Yes: A notification will be generated when a transfer is requested.</p> <p>No: No notification will be generated.</p> <p>Note: The notification will only be generated for SIOCS initiated store to store requests.</p>	No	Transfers	Boolean
Transfer Request Reject Notification	<p>Values: Yes/No</p> <p>Yes: A notification will be generated when a transfer is rejected.</p> <p>No: No notification will be generated.</p> <p>Note: The notification will only be generated for SIOCS initiated store to store requests.</p>	No	Transfers	Boolean
Unavailable Qty Discrepancy Notification	<p>Values: Yes/No</p> <p>Yes: A notification will be generated when a transfer request fails auto-approval.</p> <p>No: No notification will be generated.</p> <p>Note: Auto Accept External Generated Request is set to On and Unavailable quantity requested is more than the sending store has.</p>	No	Transfers	Boolean
Currency Default Type	Gives the default currency for EICS and SOCS.	USD	UI	String

Table 9–1 (Cont.) System Admin Parameters

Options	Description	Default Value	Topic	Type
Display Item Description	<p>Values: Short Description / Long Description</p> <p>Short Item Description: The description displayed everywhere will be the short item description.</p> <p>Note that when integrated with Oracle Retail's merchandising system, the short description of an item is a product of the first 20 characters of the long description.</p> <p>Long Item Description: The description displayed everywhere will be the long item description.</p> <p>Note that when integrated with Oracle Retail's merchandising system, the Merchandising system concatenates the diff descriptions with the long item description so the user can view all diff information. The diffs display in order from Diff 1 to Diff 4.</p>	Short Description	UI	Integer
Display Item Description Diffs	<p>Values: Yes/No</p> <p>Yes: A second item description line for diffs will be used wherever an item description is displayed where applicable.</p> <p>No: The second line will not be displayed for the item description and the diffs will not be displayed separately.</p>	Yes	UI	Boolean
Maximum Manual Quantity Entry	<p>Values: 1-100,000,000</p> <p>The value set here will be the maximum value a user can enter for a quantity via the Numeric Entry on the mobile.</p>	999	UI	Integer
Problem Line UI Limit	<p>Gives the recommended item count in product group component screen for problem line stock count product group.</p>	1500	UI	Integer
Search Date Range Default for Transaction History	<p>Values: 0-99</p> <p>This holds the default number of days for which the transaction history records need to be listed in the Transaction History List screen.</p>	0	UI	Integer
Search Limit Default for Area - Operations	<p>Values: 1-999</p> <p>This parameter indicates the default search limit for the Area.</p>	50	UI	Integer
Search Limit Default for Container Lookup - Execution	<p>Values: 1-999</p> <p>Indicates the default search limit for Container Lookup.</p>	50	UI	Integer
Search Limit Default for Container Lookup - Operations	<p>Values will be 1-999</p> <p>This parameter will determine the number of records to be displayed on container lookup list screen.</p> <p>The default value on container lookup list screen should be set to the value for the system parameter.</p>	50	UI	Integer
Search Limit Default for Customer Order Picking	<p>Values: 1-999</p> <p>Indicates the default search limit for Customer Order Picking.</p>	50	UI	Integer

Table 9-1 (Cont.) System Admin Parameters

Options	Description	Default Value	Topic	Type
Search Limit Default for Customer Orders	Values: 1-999 Indicates the default search limit for Customer Orders.	50	UI	Integer
Search Limit Default for DSD Receiving	This is to determine the default search limit for DSD receiving list.	50	UI	Integer
Search Limit Default for Finisher Lookup - Operations	Values: 1-999 Indicates the default search limit for Finisher Lookup.	50	UI	Integer
Search Limit Default for Format Assignment - Operations	Values: 1-999 This parameter will determine the number of records to be displayed on the Format Assignment List screen in desktop application. The default value on the ticketing search screen should be set to the value from this parameter.	50	UI	Integer
Search Limit Default for Inventory Adjustments - Execution	Values: 1-999 Indicates the default search limit for Inventory Adjustments on SOCS.	50	UI	Integer
Search Limit Default for Inventory Adjustments - Operations	Values: 1-999 Indicates the default search limit for Inventory Adjustments on EICS.	50	UI	Integer
Search Limit Default for Item Baskets - Execution	Values: 0-999 Indicates the default search limit for Item Baskets on SOCS.	50	UI	Integer
Search Limit Default for Item Baskets - Operations	Values: 0-999 Indicates the default search limit for Item Baskets on EICS.	50	UI	Integer
Search Limit Default for Item Lookup - Execution	Values: 1-999 Indicates the default search limit for Item Lookup on SOCS.	50	UI	Integer
Search Limit Default for Item Lookup - Operations	Values: 1-999 Indicates the default search limit for Item Lookup on EICS.	50	UI	Integer
Search Limit Default for Item Scan Number Lookup	Values: 1-999 This parameter will determine the number of records to be displayed on the Item Scan Number Lookup screen. The default value on the ISN Lookup search screen should be set to the value from this parameter.	500	UI	Integer
Search Limit Default for MPS Staged Messages	Values: 1-999 Indicates the default search limit for MPS staged messages on MPS staged message screen in EICS.	50	UI	Integer

Table 9-1 (Cont.) System Admin Parameters

Options	Description	Default Value	Topic	Type
Search Limit Default for Notifications	Values: 1-999 Indicates the default search limit for Notifications.	50	UI	Integer
Search Limit Default for Open Transaction	Values: 1-999 Indicates the default search limit for Open Transactions.	50	UI	Integer
Search Limit Default for Operational Views - Operations	Values: 1-999 This parameter will determine the number of records to be displayed on various operational view screens. The default value on various operational views screens should be set to the value from the system parameter.	50	UI	Integer
Search Limit Default for POS Transaction Resolution	Values: 1-999 This parameter will determine the number of records to be displayed on the POS Transaction resolution dialog in desktop application. The default value on the ticketing search screen should be set to the value from this parameter.	50	UI	Integer
Search Limit Default for Purchase Order	This parameter will determine the default number of records to be displayed on PO list screen.	50	UI	Integer
Search Limit Default for Replenishment Pick	Values: 1-999 Indicates the default search limit for shelf replenishment.	50	UI	Integer
Search Limit Default for RTV	Values: 1-999 Indicates the default search limit for Returns.	50	UI	Integer
Search Limit Default for Scan List	Values: 1-999 Indicates the default search limit for scan lists.	50	UI	Integer
Search Limit Default for Shelf Adjustment	Values: 1-999 Indicates the default search limit for shelf adjustments.	50	UI	Integer
Search Limit Default for Stock Count	Values: 1-999 Indicates the default search limit for Stock Counts.	50	UI	Integer
Search Limit Default for Store Order	Values: 1-999 Indicates the default search limit for Store Orders.	50	UI	Integer
Search Limit Default for Supplier Lookup	Values: 1-999 Indicates the default search limit for Supplier Lookup.	50	UI	Integer
Search Limit Default for Supplier Lookup - Operations	Values: 1-999 This parameter will determine the number of records to be displayed on supplier lookup list screen. The default value on supplier lookup list screen should be set to the value for the system parameter.	50	UI	Integer

Table 9–1 (Cont.) System Admin Parameters

Options	Description	Default Value	Topic	Type
Search Limit Default for Ticket - Operations	Values: 1-999 This parameter will determine the number of records to be displayed on the ticketing dialog in desktop application. The default value on the ticketing search screen should be set to the value from this parameter.	50	UI	Integer
Search Limit Default for Transaction History	Values: 1-999 Indicates the default search limit for Transaction History.	50	UI	Integer
Search Limit Default for Transfer Receipts	Values: 1-999 Indicates the default search limit for Transfer receipts.	50	UI	Integer
Search Limit Default for Transfer Shipment	Values: 1-999 Indicates the default search limit for Transfer shipments.	50	UI	Integer
Search Limit Default for Transfers	Values: 1-999 Indicates the default search limit for Transfer documents.	50	UI	Integer
Search Limit Default for Troubled Transaction List	Values: 1-999 Indicates the default search limit for Troubled Transactions	50	UI	Integer
Search Limit Default for UIN Lookup	Values: 1-999 Indicates the default search limit for UIN Lookup.	50	UI	Integer
Shelf Replenishment UI Limit	Gives recommended item count in product group component screen for shelf replenishment pick product groups.	1500	UI	Integer
Store Order UI Limit	This parameter indicates the UI limit for store orders, used in generation of the store orders. It is also used in the Recommended # of Items in Product Group Components.	1500	UI	Integer
Ticketing UI Limit	This parameter indicates the UI limit for ticketing, used in generation of the auto ticket print. It is also used in the Recommended # of Items in Product Group Components.	1500	UI	Integer
Unit and Amount Count UI Limit	Gives the recommended item count in product group component screen for unit and amount stock count product group.	1500	UI	Integer
Unit Count UI Limit	Gives the recommended item count in product group component screen for unit stock count product group.	5000	UI	Integer
Allow Store UIN Relocation	Values: Yes/No Indicates whether UIN can be relocated from one store to another.	Yes	UIN	Boolean

Store Admin Parameters

Table 9-2 Store Admin Parameters

Options	Description	Default Value	Topic	Type
Display Shopfloor/Backroom Quantity	<p>Values: Yes/No</p> <p>Yes: This parameter indicates if the shop floor and back room SOH should be displayed in various areas of the system including item lookup as well as transactions.</p> <p>No: Shop floor and back room SOH will not be displayed in various areas of the system.</p>	No	Admin	Boolean
Manifest Weight UOM	<p>Values: List of UOMs from the Weight UOM table</p> <p>The UOM selected for this store admin will be used as the Weight UOM for the weight on the BOL in store to store transfer shipments, customer order deliveries and returns.</p>	LBS	Admin	String
SSCC Shipping Label ID Generation	<p>Values: Yes/No</p> <p>Yes: The system will generate an identifier for printing on the shipping label.</p> <p>No: The user will need to enter an identifier for printing on the shipping label.</p> <p>This store parameter will be used for RTV Shipping and Transfer Shipping.</p>	Yes	Admin	Boolean
UIN Processing Enabled	<p>Values: Yes/No</p> <p>Yes: Enables UIN processing for the store.</p> <p>No: UIN functionality is disabled for the store.</p>	No	Admin	Boolean
Use Extended Attribute Entry	<p>This will turn on and off the feature for editing transaction item level attributes, the capturing of Extended Attributes will be skipped.</p> <p>Values: Yes/No</p> <p>Yes: Extended Attributes will be captured in the functional areas in EICS and SOCS.</p> <p>No: Extended Attributes will be captured in the functional areas in EICS and SOCS. The Ext Attributes data entry screen will not be available.</p>	No	Admin	Boolean
Allow Picking By Area	<p>Values: Yes/No</p> <p>Yes: Picking by Area is allowed. The user will be able to select an Area when creating a pick if the Customer Order Fulfillment Restriction is set to 'Transaction Controlled'. The system will narrow down the customer order to those items within an area when creating the pick.</p> <p>No: Picking by Area is not allowed, and the system will always look at all items on the customer order when creating a pick.</p>	Yes	Customer Order	Boolean

Table 9–2 (Cont.) Store Admin Parameters

Options	Description	Default Value	Topic	Type
Auto Pick Mixed Containers	<p>Values: Yes/No</p> <p>Yes: If a container has items in it that are for both customer orders and non-customer orders, the system will auto pick the container. It will mark those items that exist on the customer order as picked.</p> <p>No: If there is a mixed container of customer order and non-customer order items, it will not get auto picked and the picked quantities will not be updated.</p>	No	Customer Order	Boolean
Auto Pick On Receive - Direct Delivery	<p>Values: Yes/No</p> <p>Yes: The system will automatically fill in the pick quantities on the customer order when receiving. This can only happen if the customer order record has already come into the system. If there is no customer order, the auto picking will not happen at the time of receiving, rather it will occur when the customer order comes in.</p> <p>No: The system will not pick when receiving goods.</p>	No	Customer Order	Boolean
Auto Pick On Receive - Transfer Receiving	<p>Values: Yes/No</p> <p>Yes: The system will automatically fill in the pick quantities on the customer order when receiving. This can only happen if the customer order record has already come into the system. If there is no customer order, the auto picking will not happen at the time of receiving, rather it will occur when the customer order comes in.</p> <p>No: The system will not pick when receiving goods in transfer receiving.</p>	No	Customer Order	Boolean
Default Customer Order Picking Method	<p>Values: Bin / Store Customer Order</p> <p>This parameter is used to define the default picking method when creating a customer order pick, bin or store customer order.</p> <p>Note this is just a default and the user can still switch the picking method.</p>	Store Customer Order	Customer Order	Integer
Default Number of Bins	<p>Values: 1-999</p> <p>This parameter will determine the number of bins to default into the 'Bin Qty' field if the user selects 'Bin' as the pick type when creating the pick.</p>	1	Customer Order	Integer
Dispatch Validate	<p>Values: Ship Direct, Ship Submit</p> <p>Ship Direct: System will control all processes. The user will be able to go from create/edit directly to dispatch. There will not be a submit option.</p> <p>Ship Submit: This option will require the user to press the Submit option and require a specific press of the dispatch button.</p>	Ship Direct	Customer Order	Integer

Table 9-2 (Cont.) Store Admin Parameters

Options	Description	Default Value	Topic	Type
Generate Bins	<p>Values: System / Manual</p> <p>System: The system will automatically generate the bin IDs when the pick is created.</p> <p>Manual: The system will require the user to enter the bin IDs upon acting on the created pick. This option removes the need for printing out labels since the labels already exist on the bin. For both System and Manual, the user will still have the option to print labels for the bins.</p>	Manual	Customer Order	Integer
Item Substitution - Store Discretion	<p>Values: Yes/No</p> <p>This store parameter is used to determine if the user can use their own discretion when doing substitute items in the picking process.</p> <p>Yes: The user can choose any item to be used as a substitute item.</p> <p>No: Only those items that are defined as substitutes can be substituted.</p>	No	Customer Order	Boolean
Override Bin Quantity	<p>Values: Yes/No</p> <p>This store parameter determines whether the user is allowed to override the default bin quantity when creating a pick by bin. The Bin Quantity is defaulted based upon the store parameter for Default Number of Bins.</p>	No	Customer Order	Boolean
Picking Required for Customer Orders	<p>Values: Yes/No</p> <p>Yes: Requires that manual picking be performed on the customer order prior to being able to create a delivery for it.</p> <p>No: Picking is not necessary in order to create a delivery.</p>	Yes	Customer Order	Boolean
Pre-shipment Notification	<p>Values: Yes / No</p> <p>This parameter will drive the following functionality:</p> <p>Yes: The system will publish a pre-shipment message</p> <p>No: The system will not publish a pre-shipment message</p>	No	Customer Order	Boolean
Reserve Customer Order Inventory Upon Receiving	<p>Values: Yes/No</p> <p>This store parameter will dictate when inventory for a web order customer order should be reserved.</p> <p>Yes: Inventory will be reserved upon receiving a delivery in the store which contains the customer order (Store to store transfer, DSD, Warehouse to Store transfer). If the retailer wishes to fulfill the customer orders from deliveries, for example getting the goods from the warehouse, then this option would be set to Yes to reserve upon receiving.</p> <p>No: Inventory will be reserved upon getting the customer order into the store. If the retailer chooses to mainly fulfill customer orders from within the stock in the store, this parameter would be set to No, thus reserving inventory right away when the customer order is received.</p>	No	Customer Order	Boolean

Table 9–2 (Cont.) Store Admin Parameters

Options	Description	Default Value	Topic	Type
Allow Multiple Deliveries against PO with No ASN	<p>Values: Yes/No</p> <p>Yes: The user can create more than one delivery for the same PO when the PO does not have an associated ASN.</p> <p>No: The user can only create a single delivery against a PO when the PO does not have an associated ASN. The PO will be closed when the delivery is confirmed.</p>	Yes	DSD Receiving	Boolean
Auto close days after expected date	<p>Values: 0-999</p> <p>Number of days after the expected delivery date the ASN will be closed.</p>	5	DSD Receiving	Integer
Direct Delivery Auto Remove Over Received Quantity	<p>Values: Yes/No</p> <p>Yes: If set to Yes, the user is allowed to add any quantity for the DSD, but any quantity above the expected quantity will be removed from the transaction. After the user confirms the transaction, they are prompted that any over received quantities will be removed. The user can create more than one delivery for the same PO when the PO does not have an associated ASN.</p> <p>No: The over received quantities will stay in the delivery transaction.</p>	No	DSD Receiving	Boolean
Direct Delivery Default to ShopFloor Receiving	<p>Values: Yes/No</p> <p>This parameter determines whether the DSD receiving dialog will default to receive inventory into the shop floor instead of automatically receiving into the back room or delivery bay.</p> <p>Yes: The DSD Receiving Container workflow will default the option to receive inventory into the shop floor. The shop floor inventory bucket will be incremented instead of the backroom or delivery bay bucket. If a capacity is defined for the item and Direct Delivery Receive Item Capacity is set to yes, the maximum shop floor quantity will equal the capacity; otherwise, the shop floor will be updated to the entire receipt amount. If the capacity is used and if the receiving quantity is excess, the balance is incremented to delivery bay or back room depending on the Replenishment - Delivery Bay Inventory parameter.</p> <p>No: The option will be defaulted to back room or delivery bay depending on the Replenishment - Delivery Bay Inventory parameter. If this parameter is on, the system will increment the delivery bay bucket instead of back room.</p>	No	DSD Receiving	Boolean

Table 9-2 (Cont.) Store Admin Parameters

Options	Description	Default Value	Topic	Type
Direct Delivery Invoice Entry	<p>Values: Enabled/Disabled/Unique</p> <p>Enabled: This option allows the user to enter any value for the invoice number, including duplicates.</p> <p>Disabled: The Invoice Number and date fields are disabled. Unique: The Invoice Number field will allow entry; however, the user will not be able to enter a duplicate invoice number based upon the supplier.</p> <p>Upon entering an Invoice Number, the system will validate if the invoice already exists for the supplier defined on the DSD. If a duplicate exists, there will be an error. If no duplicate exists, the invoice number will be accepted.</p>	Enabled	DSD Receiving	Integer
Direct Delivery Receive Item Capacity	<p>Values: Yes/No</p> <p>This parameter determines whether the capacity will be considered while receiving the deliveries.</p> <p>Yes: While receiving, the capacity will be considered. For example: If capacity is 50, delivery is for 100, and Available SOH is 10 on the shop floor, if this parameter is on and receive in shop floor is checked, 40 (un-damaged) will be moved to shop floor and the rest to the backroom.</p> <p>No: While receiving, the capacity will not be considered. Damaged inventory will not move to the shop floor.</p>	No	DSD Receiving	Boolean
DSD Receiving Auto Remove Damaged Quantity	<p>Values: Yes/No</p> <p>Yes: All damaged items on the delivery are removed automatically when confirming the transaction.</p> <p>No: All damaged items remain on the delivery when confirming the transaction.</p>	No	DSD Receiving	Boolean
Days Before Item Basket Expiration	<p>Values: 0-999</p> <p>This parameter will be used to add to the system date when defaulting the expiration date on an item basket. A value of 0 would set the expiration date to today. A value of 1 will set the expiration date to tomorrow (today + 1).</p>	1	Item Basket	Integer
Auto Accept External Generated RTV Request	<p>Values: Yes/No</p> <p>This parameter determines whether system automatically approves the return request and defaults the requested quantity to the accepted quantity for externally generated RTV requests.</p>	No	RTV	Boolean
Not After Date Default days	<p>Values: 0-999</p> <p>This parameter would decide the number of days after which a RTV document can be closed After not after date is passed. All status documents would be marked cancelled once this criterion is met.</p>	30	RTV	Integer

Table 9–2 (Cont.) Store Admin Parameters

Options	Description	Default Value	Topic	Type
Dispatch Validate	<p>Values: Ship Direct, Ship Submit</p> <p>Ship Direct: SIOCS will control all processes. The user will be able to go from create/edit directly to dispatch.</p> <p>Ship Submit: This option will require the user to press the Submit button and require a specific press of the dispatch button. An additional option is that an external system will generate a dispatch message through a standard web service.</p>	Ship Direct	RTV Shipment	Integer
Pre-shipment Notification	<p>Values: Yes/No</p> <p>Yes: The system will publish a pre-shipment message.</p> <p>No: The system will not publish a pre-shipment message.</p>	No	RTV Shipment	Boolean
RTV Shipment Carrier Default	<p>Values: Sender / Receiver / Third Party</p> <p>When creating a return, the Carrier Type on the BOL will default initially based upon this parameter. The user can still change this value and if so, that will be the value used on the return.</p> <p>Sender: Sender will be selected for Carrier Type on BOL</p> <p>Receiver: Receiver will be selected for the Carrier type on BOL.</p> <p>Third Party: Third Party will be selected for the Carrier type on the BOL. The type (drop down) will be defaulted to "Other".</p>	Third Party	RTV Shipment	Integer
Display Sequence Fields	<p>Values: Yes/No</p> <p>Yes: Will display sequencing information throughout the application including guided stock count option, capacity, and an item's locations including primary location.</p> <p>No: Sequence information will not be displayed in the system.</p>	No	Sequencing	Boolean
Replenishment - At Case Level	<p>Yes: The standard UOM will default to Cases on the shelf replenishment screens.</p> <p>No: The standard UOM will default to Units on the shelf replenishment screens.</p> <p>Note: This parameter will determine whether to replenish shelves at the Case or standard unit of measure. This will override the 'Default UOM' system parameter.</p>	Yes	Shelf Replenishment	Boolean
Replenishment - Delivery Bay Inventory	<p>Values: Yes/No</p> <p>Yes: The delivery bay will be used for replenishment.</p> <p>No: The delivery bay will not be used.</p>	Yes	Shelf Replenishment	Boolean
Replenishment - End of Day max. fill %	This parameter will determine the percentage the stock can fall to before creating the end of day replenishment list.	100	Shelf Replenishment	Double

Table 9–2 (Cont.) Store Admin Parameters

Options	Description	Default Value	Topic	Type
Replenishment - Item Substitution Store Discretion	<p>Values: Yes/No</p> <p>Yes: The user is allowed to choose any item to substitute. An item lookup feature will allow the user to search for an item to select.</p> <p>No: The user is restricted to scanning/entering an item that exists on the list of approved substitute items defined by the merchandising system.</p> <p>Note: If there are no items defined for item substitution, the dialogue will be displayed with the original item in the header with no substitutes.</p>	No	Shelf Replenishment	Boolean
Replenishment - Within Day Max. fill %	This parameter will determine the percentage the stock can fall to before creating the within day replenishment list.	75	Shelf Replenishment	Double
Display Late Inventory Adjustment Message	<p>Values: Yes/No</p> <p>Yes: When the user is confirming a Stock Count in the Authorization phase and there are items on the stock count with In Progress Inventory Adjustments, the user may return to the stock count to complete the inventory adjustments or to continue and ignore the adjustments.</p> <p>When the user is approving an inventory adjustment with items on an open stock count, a message is displayed allowing the user to determine if further processing should be undertaken. Similar logic to how late sales is processed will be used for these adjustments.</p> <p>No: When the user is confirming a Stock Count in the Authorization phase and there are items on the stock count with In Progress Inventory Adjustments the system ignores the inventory adjustments and allows the user to complete the count.</p> <p>When the user is approving an inventory adjustment, there is no additional processing.</p> <p>Note: The system will process the inventory adjustment like how late sales are processed and determine if the stock count should be adjusted or not. The update to the stock count is not immediate but rather is at the time of authorization if there are reversing entries created.</p>	No	Stock Counts	Boolean

Table 9–2 (Cont.) Store Admin Parameters

Options	Description	Default Value	Topic	Type
Stock Count Default Timeframe	<p>Values: Before Store Open/ After Store Close</p> <p>This parameter defines when the stock count is performed in relation to the store opening hours for Daily Sales Processing. This value may be overridden at the time of the stock count, if the system is configured to allow the override. If an override is allowed, this setting will determine the default value displayed.</p> <p>Before Store Open: The stock count is performed before the opening of the store. All sales on the day of the stock count will only update SOH. It will not update any counted quantities.</p> <p>After Store Close: The stock count is performed after the closing of the store. All sales on the day of the stock count will update both SOH and any counted quantities. If using RMS, After Store Close must be selected.</p> <p>Note: Timestamp processing does not use this parameter.</p>	Before Store Open	Stock Counts	Integer
Display Delivery Timeslot	<p>Values: Yes/No</p> <p>Yes: The Delivery Timeslot fields will display throughout Store Orders as well as the Admin screen Delivery Timeslots.</p> <p>No: The Delivery Timeslot fields will NOT display throughout Store Orders as well as the Admin screen Delivery Timeslots.</p>	Yes	Store Order	Boolean
DSD Delivery Supplier for Store Order	<p>Values: Yes/No</p> <p>This indicator will check to see if the DSD allowed indicator needs to be yes when adding a supplier restriction when creating a store order.</p> <p>Yes: The system needs to check the DSD indicator (Indicator on Supplier table which determines whether a supplier can create a new Purchase Order) when creating a new Store Order. If the indicator is set to 'Yes' the supplier can be added. If it is set to 'No', the supplier cannot be added.</p> <p>No: The DSD indicator on the supplier does not need to be checked.</p>	Yes	Store Order	Integer
Enable Area for Store Order	<p>Values: Yes/No</p> <p>Yes: The Area will display throughout Store Orders.</p> <p>No: The Area field will NOT display throughout Store Orders.</p>	Yes	Store Order	Boolean
Supplier Restriction for Store Order	<p>Values: Enabled / Required / Disabled</p> <p>Enabled: Supplier will be available as a restriction when creating and searching for a store order.</p> <p>Required: Supplier will be available as a restriction when creating and searching for a store order. When creating it will also be required.</p> <p>Disabled: Supplier will not be available as a restriction when creating a store order.</p>	Enabled	Store Order	Integer

Table 9-2 (Cont.) Store Admin Parameters

Options	Description	Default Value	Topic	Type
Warehouse Restriction for Store Order	<p>Values: Enabled / Required / Disabled</p> <p>Enabled: Warehouse will be available as a restriction when creating and searching for a store order.</p> <p>Required: Warehouse will be available as a restriction when creating and searching for a store order. When creating it will also be required.</p> <p>Disabled: Warehouse will not be available as a restriction when creating a store order.</p>	Enabled	Store Order	Integer
AutoGenerate Item Tickets for Clearance Price Changes	<p>Values: Yes/No</p> <p>Yes: When a clearance price event comes from the pricing system, a new item ticket is sent to the ticketing dialogue.</p> <p>No: When a clearance pricing event comes from the pricing system, the system does not generate an item ticket.</p> <p>This determines whether the system must auto generate item tickets in the system when there is a clearance price event coming in from the pricing system.</p>	No	Ticketing	Boolean
AutoGenerate Item Tickets for Description Changes	<p>Values: Yes/No</p> <p>Yes: When a new description comes from the merchandising system, a new item ticket is sent to the ticketing dialogue.</p> <p>No: When a new description comes from the merchandising system, the system does not generate an item ticket.</p> <p>This configuration will be used to auto send item tickets to ticketing when an item description is updated and sent to EICS.</p>	No	Ticketing	Boolean
AutoGenerate Item Tickets for Promotion Price Changes	<p>Values: Yes/No</p> <p>Yes: When a promotion price event comes from the pricing system, a new item ticket is sent to the ticketing dialogue.</p> <p>No: When a promotion pricing event comes from the pricing system, the system does not generate an item ticket.</p> <p>This determines whether the system must auto generate item tickets in EICS when there is a promotion price event coming in from the pricing system.</p>	No	Ticketing	Boolean
AutoGenerate Item Tickets for Regular Price Changes	<p>Values: Yes/No</p> <p>Yes: When a regular price change comes from the pricing system, a new item ticket is sent to the ticketing dialogue.</p> <p>No: When a regular price change comes from the pricing system, the system does not generate an item ticket.</p> <p>This determines whether the system must auto generate item tickets in EICS when there is a regular price change event coming in from the pricing system.</p>	No	Ticketing	Boolean

Table 9–2 (Cont.) Store Admin Parameters

Options	Description	Default Value	Topic	Type
Auto Generate Shelf Edge Labels for Clearance Price Changes	<p>Values: Yes/No</p> <p>Yes: When a clearance price event comes from the pricing system, a shelf edge label is sent to the ticketing dialogue.</p> <p>No: When a clearance pricing event comes from the pricing system, the system does not generate a label.</p> <p>This determines whether the system must auto generate item tickets in the system when there is a clearance price event coming in from the pricing system.</p>	No	Ticketing	Boolean
Auto Generate Shelf Edge Labels for Description Changes	<p>Values: Yes/No</p> <p>Yes: When a new description comes from the merchandising system, a shelf edge label is sent to the ticketing dialogue.</p> <p>No: When a new description comes from the merchandising system, the system does not generate a label.</p> <p>This configuration will be used to auto generate labels when an item description is updated and to send to EICS.</p>	No	Ticketing	Boolean
Auto Generate Shelf Edge Labels for Promotion Price Changes	<p>Values: Yes/No</p> <p>Yes: When a promotion price event comes from the pricing system, a new shelf edge label is sent to the ticketing dialogue.</p> <p>No: When a promotion pricing event comes from the pricing system, the system does not generate a label.</p> <p>This determines whether the system must auto generate labels in EICS when there is a promotion price event coming in from the pricing system.</p>	No	Ticketing	Boolean
Auto Generate Shelf Edge Labels for Regular Price Changes	<p>Values: Yes/No</p> <p>Yes: When a regular price change comes from the pricing system, a new shelf edge label is sent to the ticketing dialogue.</p> <p>No: When a regular price change comes from the pricing system, the system does not generate a label.</p> <p>This determines whether the system must auto generate labels in EICS when there is a regular price change event coming in from the pricing system.</p>	No	Ticketing	Boolean

Table 9–2 (Cont.) Store Admin Parameters

Options	Description	Default Value	Topic	Type
Item Print Events	<p>This is to determine the default item price events for the ticket printing.</p> <p>Values: Always, Clearance, Promotion, Permanent, Clearance or Permanent and Any Price Event</p> <p>Always: This option will always print a ticket regardless of if there is a price change.</p> <p>Clearance: Only print a ticket if on the specific date any clearance event is effective. So, for Clearance 2, that means today's date + 2 days, if the item on that day has a clearance going on, print the clearance ticket.</p> <p>Promotion: Only print a ticket if on the specific date any promotion event is effective.</p> <p>Regular or Clearance: Only print a ticket if on the specific date any Regular or Clearance event is getting effective.</p> <p>Permanent: Only print a ticket if on the specific date any Regular even of getting effective.</p> <p>Any Price Event (Promotion, Clearance or Permanent (Regular)): Based on the date selected, if any price event goes into effect (clearance, promotion or regular price a ticket. If no price event goes into effect, print nothing).</p> <p>This is to determine the default item price events for the ticket printing.</p> <p>Values: Always, Clearance, Promotion, Permanent, Clearance or Permanent and Any Price Event</p> <p>Always: This option will always print a ticket regardless of if there is a price change.</p> <p>Clearance: Only print a ticket if on the specific date any clearance event is effective. So, for Clearance 2, that means today's date + 2 days, if the item on that day has a clearance going on, print the clearance ticket.</p> <p>Promotion: Only print a ticket if on the specific date any promotion event is effective.</p> <p>Regular or Clearance: Only print a ticket if on the specific date any Regular or Clearance event is getting effective.</p> <p>Permanent: Only print a ticket if on the specific date any Regular even of getting effective.</p> <p>Any Price Event (Promotion, Clearance or Permanent (Regular)): Based on the date selected, if any price event goes into effect (clearance, promotion or regular price a ticket. If no price event goes into effect, print nothing).</p>	Always	Ticketing	String
Maximum Ticket Quantity to Print	<p>This is to determine the maximum ticket size to print in one command. This is used in auto ticket printing batch and ticketing dialogue.</p>	500	Ticketing	Boolean

Table 9–2 (Cont.) Store Admin Parameters

Options	Description	Default Value	Topic	Type
Auto Close Receipt	<p>Values: 1-99</p> <p>0: close the receipt immediately</p> <p>1: close the receipt the end of day today</p> <p>2: close the receipt end of day tomorrow</p> <p>X: close end of day x days starting from today.</p> <p>The batch program will auto close any transfer receipts, and marks all non-received containers to missing. Partially received containers will be marked as damaged.</p>	1	Transfer Receiving	Integer
External Finisher Auto Receive	<p>Values: Not Allowed, External Message, Date Driven</p> <p>Not allowed will make the system work as today.</p> <p>External message will receive the full external finisher delivery with a Source Type of 'Finisher', the moment an ASN transaction arrives that indicates that the delivery needs to be auto received.</p> <p>Date Driven will look at a secondary store option (External Finisher Auto Receive number of Days) to determine how many days the transaction stays open before it is fully received. If it is set to 0, it will auto-receive on the ETA date.</p>	Not Allowed	Transfer Receiving	Integer
External Finisher Auto Receive Number of Days	<p>Values: 0-999</p> <p>A batch program will auto receive any external finisher deliveries with a Source Type of 'Finisher', that have not been closed x-days after the ETA date or the create date depending on if the ETA date is set or not and if the auto receive external delivery parameter is set 0 means immediate receiving 1 means today (EOD) 2 means EOD tomorrow x means EOD x days starting from today</p>	0	Transfer Receiving	Integer
Store Auto Receive	<p>Values: Not allowed / External message / Date Driven</p> <p>Not allowed: Auto receiving is not allowed for the store.</p> <p>External message: Receives the full store delivery the moment an ASN transaction arrives when the indicator on the ASN identifies this as an auto receive delivery and the Source Type is 'Store'. This parameter works with the Store Auto Receive screen.</p> <p>Date Driven: Receives the delivery automatically when the date is reached. A second options, 'Store Auto Receive Number of Days' is used to determine how many days the transaction stays open before it is fully received. If it is set to 0, it will receive immediately when the transfer is shipped. This parameter works with the Store Auto Receive screen.</p>	Not Allowed	Transfer Receiving	Integer

Table 9-2 (Cont.) Store Admin Parameters

Options	Description	Default Value	Topic	Type
Store Auto Receive Number of Days	<p>Values: 0-99</p> <p>0: immediate receiving</p> <p>1: end of day today</p> <p>2: end of day tomorrow</p> <p>X: end of day x days starting from today</p> <p>The batch program will auto receive any transfers with a Source Type of 'Store' not previously closed x-days after they have been shipped. This parameter is only used when the Store Auto Receive parameter is enabled.</p>	0	Transfer Receiving	Integer
Store Transfer Default to ShopFloor Receive	<p>Values: Yes/No</p> <p>This parameter determines whether the receiving will default to receive inventory into the shop floor instead of automatically receiving into the back room or delivery bay when the source type is 'Store'.</p> <p>Yes: The Transfer workflow will default to receive inventory into the shop floor when the Source Type is 'Store'. The shop floor inventory bucket will be incremented instead of the backroom or delivery bay bucket. If a capacity is defined for the item, the maximum shop floor quantity will equal the capacity; otherwise, the shop floor will be updated to the entire receipt amount.</p> <p>If the capacity is used and if the receiving quantity is excess, the balance is incremented to delivery bay or back room depending on the Replenishment.</p> <p>No: This will default to back room or delivery bay depending on the Replenishment -Delivery Bay Inventory parameter and all inventory will be automatically received into the back room or delivery bay when Source Type is 'Store'. Note: With the proper permissions, the user will still have the option to receive onto the shop floor while receiving the delivery by changing the default to Shop Floor.</p> <p>Damaged inventory will not move to shop floor.</p>	No	Transfer Receiving	Boolean
Store Transfer Receive Item Capacity	<p>Values: Yes/No</p> <p>This parameter will determine whether the capacity will be considered while receiving the deliveries.</p> <p>Yes: If the value is set to YES, then while receiving and Source Type of 'Store', the capacity will be considered. For example: If capacity is 50, receipt is for 100 and Available SOH is 10 on shopfloor, then if this parameter is on and receive in shop floor is checked then 40 (un-damaged) will be moved to shop floor and rest to back room.</p> <p>No: If the value is set to NO, then while receiving the capacity will not be considered. Damaged inventory will not move to shop floor.</p>	No	Transfer Receiving	Boolean

Table 9–2 (Cont.) Store Admin Parameters

Options	Description	Default Value	Topic	Type
Warehouse Auto Receive	<p>Values: Not Allowed, External Message, Date Driven</p> <p>This parameter will drive the following functionality.</p> <p>Not Allowed will make the system work as today.</p> <p>External message will receive the full warehouse delivery the moment an ASN transaction arrives that indicates that the delivery needs to be auto received and the Source Type is 'Warehouse'.</p> <p>Date Driven will look at a secondary store option (Warehouse Auto Receive number of Days) to determine how many days the transaction stays open before it is fully received. If it is set to 0, it will auto-receive on the ETA date.</p>	Not Allowed	Transfer Receiving	Integer
Warehouse Auto Receive Number of Days	<p>Values: 0-99</p> <p>0: immediate receiving</p> <p>1: end of day today</p> <p>2: end of day tomorrow</p> <p>X: end of day x days starting from today</p> <p>The batch program will auto receive any transfers with a Source Type of 'Warehouse' not previously closed x-days after they have been shipped. This parameter is only used when the Warehouse Auto Receive parameter is enabled.</p>	0	Transfer Receiving	Integer
Warehouse Default to ShopFloor Receive	<p>Values: Yes/No</p> <p>This parameter determines whether the receiving will default to receive inventory into the shop floor when source type is 'Warehouse' instead of automatically receiving into the back room or delivery bay when the source type is 'Warehouse'.</p> <p>Yes: The Transfer receiving workflow will default to receive inventory into the shop floor when the Source Type is 'Warehouse'. The shop floor inventory bucket will be incremented instead of the backroom or delivery bay bucket. If a capacity is defined for the item, the maximum shop floor quantity will equal the capacity; otherwise, the shop floor will be updated to the entire receipt amount.</p> <p>If the capacity is used and if the receiving quantity is excess, the balance is incremented to delivery bay or back room depending on the Replenishment - Delivery Bay Inventory parameter.</p> <p>No: This will default to back room or delivery bay depending on the Replenishment -Delivery Bay Inventory parameter and all inventory will be automatically received into the back room or delivery bay when Source Type is 'Warehouse'. Note: With the proper permissions, the user will still have the option to receive onto the shop floor while receiving the delivery by changing the default to Shop Floor.</p> <p>Damaged inventory will not move to shop floor.</p>	No	Transfer Receiving	Boolean

Table 9–2 (Cont.) Store Admin Parameters

Options	Description	Default Value	Topic	Type
Warehouse Receive Item Capacity	<p>Values: Yes/No</p> <p>This parameter will determine whether the capacity will be considered while receiving the deliveries.</p> <p>Yes: If the value is set to YES, then while receiving and Source Type of 'Warehouse', the capacity will be considered. For example: If capacity is 50, receipt is for 100 and Available SOH is 10 on shopfloor, then if this parameter is on and receive in shop floor is checked then 40 (un-damaged) will be moved to shop floor and rest to back room.</p> <p>No: If the value is set to NO, then while receiving the capacity will not be considered. Damaged inventory will not move to shop floor</p>	No	Transfer Receiving	Boolean
Dispatch Validate	<p>Values: Ship Direct, Ship Submit</p> <p>Ship Direct: SIOCS will control all processes. The user will be able to go from create/edit directly to dispatch.</p> <p>Ship Submit: This option will require the user to press the Submit button and require a specific press of the dispatch button. An additional option is that an external system will generate a dispatch message through a standard web service.</p>	Ship Direct	Transfer Receiving	Integer
Pre-shipment Notification	<p>Values: Yes/No</p> <p>This parameter will drive the following functionality:</p> <p>Yes: The system will publish a pre-shipment message.</p> <p>No: The system will not publish a pre-shipment message.</p>	No	Transfer Shipment	Boolean
Ship to Finisher Carrier Default	<p>Values: Sender / Receiver / Third Party</p> <p>Sender: Sender will be selected for Carrier Type on BOL</p> <p>Receiver: Receiver will be selected for the Carrier type on BOL.</p> <p>Third Party: Third Party will be selected for the Carrier type on the BOL. The type (drop down) will be defaulted to "Other".</p> <p>When creating a store to Finisher transfer the Carrier Type on the BOL will default initially based upon this parameter. The user can still change this value and if so, that will be the value used on the transfer.</p>	Third Party	Transfer Shipment	Integer
Ship to Store Carrier Default	<p>Values: Sender / Receiver / Third Party</p> <p>Sender: Sender will be selected for Carrier Type on BOL</p> <p>Receiver: Receiver will be selected for the Carrier type on BOL.</p> <p>Third Party: Third Party will be selected for the Carrier type on the BOL. The type (drop down) will be defaulted to "Other".</p> <p>When creating a store to store transfer the Carrier Type on the BOL will default initially based upon this parameter. The user can still change this value and if so, that will be the value used on the transfer.</p>	Third Party	Transfer Shipment	Integer

Table 9–2 (Cont.) Store Admin Parameters

Options	Description	Default Value	Topic	Type
Ship to Warehouse Carrier Default	<p>Values: Sender / Receiver / Third Party</p> <p>Sender: Sender will be selected for Carrier Type on BOL</p> <p>Receiver: Receiver will be selected for the Carrier type on BOL.</p> <p>Third Party: Third Party will be selected for the Carrier type on the BOL. The type (drop down) will be defaulted to "Other".</p> <p>When creating a store to WH transfer the Carrier Type on the BOL will default initially based upon this parameter. The user can still change this value and if so, that will be the value used on the transfer.</p>	Third Party	Transfer Shipment	Integer
Auto Accept External Generated Request	<p>Values: Yes/No</p> <p>This parameter automatically approves the requested transfer and defaults the requested quantity to the accepted quantity for externally generated requests.</p>	No	Transfers	Boolean
Auto Accept Store Transfer Request	<p>Values: Yes/No</p> <p>This parameter automatically approves the requested transfer and defaults the requested quantity to the accepted quantity for store to store requests.</p>	No	Transfers	Boolean
Not After Date Default Days	<p>Values: 0-999</p> <p>This parameter adds a value to the current date and uses the value to default the 'Not After Date' when creating a transfer or requesting a transfer. Documents will be closed via batch when this date is reached.</p>	30	Transfers	Integer
Manifest Customer Order Deliveries	<p>Values: Yes/No</p> <p>Yes: The Manifesting system will be called.</p> <p>No: The Manifesting system will not be called.</p>	No	Web Service Enablement	Boolean
Manifest RTV to Supplier	<p>Values: Yes/No</p> <p>Yes: The Manifesting system will be called for return to supplier.</p> <p>No: The Manifesting system will not be called.</p> <p>Note: The interface will still need to be implemented; this just is to determine if it will be called.</p>	No	Web Service Enablement	Boolean
Manifest Transfer to Finisher	<p>Values: Yes/No</p> <p>Yes: The Manifesting system will be called for transfer to Finisher.</p> <p>No: The Manifesting system will not be called.</p> <p>Note: The interface will still need to be implemented; this just is to determine if it will be called.</p>	No	Web Service Enablement	Boolean
Manifest Transfer to Store	<p>Values: Yes/No</p> <p>Yes: The Manifesting system will be called for transfer to store.</p> <p>No: The Manifesting system will not be called.</p> <p>Note: The interface will still need to be implemented; this just is to determine if it will be called.</p>	No	Web Service Enablement	Boolean

Table 9–2 (Cont.) Store Admin Parameters

Options	Description	Default Value	Topic	Type
Manifest Transfer to Warehouse	<p>Values: Yes/No</p> <p>Yes: The Manifesting system will be called for transfer to warehouse</p> <p>No: The Manifesting system will not be called.</p> <p>Note: The interface will still need to be implemented; this just is to determine if it will be called.</p>	No	Web Service Enablement	Boolean
OMS Customer Order Delivery Validation	<p>Values: Yes/No</p> <p>Yes: When confirming the delivery, the system will make a call out to an external system (such as an OMS) to validate the delivery status and delivery quantities before completing the dispatch.</p> <p>No: external system will not be called.</p>	No	Web Service Enablement	Boolean
OBCS Customer Order Delivery Validation	<p>Values: Yes/No</p> <p>Yes: SIOCS-OBCS Integration will be enabled</p> <p>No: SIOCS-OBCS Integration will not be enabled</p>	No	Web Service Enablement	Boolean
Sales Forecast Data	<p>Yes: The web service for Sales Forecast Data will be called.</p> <p>No: The web service for Sales Forecast Data will NOT be called.</p>	No	Web Service Enablement	Boolean
Send Event Alert External	<p>Values: Yes / No</p> <p>Yes: Notification event alerts (non ad hoc notifications) will be sent externally via web service.</p> <p>No: Notification event alerts (non ad hoc notifications) will not be sent externally. Web service is not called.</p>	No	Web Service Enablement	Boolean

Permissions

Table 9–3 Security Permissions

Permission	Topic	Usage
Access Ad Hoc Stock Count Tolerances	Admin	With this permission, the user will have access to the Ad hoc Stock Count Tolerance dialog.
Access Admin	Admin	With this permission, the user will have access to the Admin menu.
Access Auto-Receive Stores	Admin	With this permission, the user will have access to the Auto Receive Stores admin dialog.
Access Barcode Processor	Admin	With this permission, the user will have access to the Barcode Processor dialog.
Access Buddy Stores	Admin	With this permission, the user will have access to the Buddy Store dialog.
Access Carrier Services	Admin	With this permission, the user can access the Carrier Service dialog to add and edit the carrier service data.
Access Carriers	Admin	With this permission, the user can access the Carrier dialog to add or edit the carrier data.

Table 9–3 (Cont.) Security Permissions

Permission	Topic	Usage
Access Code Info	Admin	With this permission, the user can access the Code Info dialog to add, edit and delete code information.
Access Container Lookup	Admin	With this permission, the user will have access to the Container Lookups dialog.
Access Credential Administration	Admin	With this permission, the user will have access to the Credential Administration Screen. Without this permission, the user will not have access to the Credential Administration Screen.
Access Customer Order Picking Tolerances	Admin	With this permission, the user will have access to the Customer Order Picking Tolerance dialog.
Access Data Seed	Admin	With this permission the user will have the ability to start the data seeding job via the batch job admin.
Access Delivery Timeslot	Admin	User must have this permission for the Delivery Timeslot menu option to be available within the Data Setup menu. With this permission the user will be able to do all operations on this screen.
Access Extended Attribute	Admin	With this permission, the Extended Attributes Menu option is displayed under Admin/Configuration and the user gets the ability to setup and assign extended attributes.
Access Extended Attribute Dept Assign	Admin	With this permission, the Assign Extended Attributes Menu option is displayed under Admin/Configuration and the user gets the ability to assign new extended attributes and remove the existing assignments.
Access Extended Attribute Setup	Admin	With this permission, the Setup Extended Attributes Menu option is displayed under Admin/Configuration and the user gets the ability to view and edit extended attributes.
Access Finisher Lookup	Admin	With this permission, the user will have access to the Finisher Lookup functionality.
Access Flexible Attributes	Admin	With this permission, the user will have access to the Custom Flexible Attributes dialog and the ability to setup (Create) and maintain (Edit, Delete) flexible attributes.
Access Future Price Events	Admin	With this permission, the user will have access to Future Price Events.
Access Inventory Adjustment Reasons	Admin	With this permission, the user will have access to the Inventory Adjustment Reason admin dialog and the ability to setup and maintain inventory adjustment reason codes.
Access Inventory Management	Admin	With this permission, the user will have access to the Inventory Management.
Access ISN Types	Admin	With this permission, user will be able to access the ISN Types dialog in the desktop application.
Access Item CFAs	Admin	With this permission, the CFAs will be available on Item Detail in Item Lookup

Table 9–3 (Cont.) Security Permissions

Permission	Topic	Usage
Access Item Lookup	Admin	With this permission, the user will have access to the Item Lookup functionality.
Access Item Scan Number Lookup	Admin	With this permission, the user can access the Item Scan Number Lookup.
Access Job Admin	Admin	With this permission, the user can access the Job admin dialog.
Access Job Scheduler	Admin	With this permission, the user can access the Job scheduler dialog.
Access Lookup	Admin	With this permission, the user will have access to functionality within Lookups.
Access MPS Staged Messages	Admin	User must have this permission in order to access the MPS Staged Messages screen to view or edit the inbound and outbound messages.
Access MPS Work Types	Admin	User must have this permission in order to Access or Edit the Worker Type settings.
Access Operational Issues	Admin	With this permission, the user can access the Operational Issues dialog.
Access Operational Views menu	Admin	On EICS, with this permission, the operational views main menu is displayed, and user is allowed to view the different operational views.
Access Package Size	Admin	With this permission the user will have access to the Package Size admin dialog.
Access POS Transaction Resolution List	Admin	On desktop application, with this permission, the user can access the Transaction Resolution dialogue.
Access Price Events	Admin	With this permission, 'View Price Events' button will be available in the Item Detail screen hence the user will be able to access to the Price History screen.
Access Printer Setup	Admin	With this permission, the user can access the printer setup dialog.
Access Product Group Schedules	Admin	With this permission the user will have access to the Product Group Schedule dialog.
Access Product Groups	Admin	With this permission, the user will have access to the admin Product Group and Product Group Component functionality
Access Reports	Admin	With this permission, the user can access the Reports dialog.
Access RFID Locator	Admin	With this permission, the user can access the RFID Locator dialog in mobile.
Access Sequence Admin	Admin	With this permission the user will have the Sequence Admin menu option under Technical Maintenance menu.
Access Shipment Reasons	Admin	With this permission, the user will have access to the Shipment Reason admin dialog and the ability to setup and maintain shipment reason codes.
Access Shipping Receiving	Admin	With this permission, the user will have access to functionality within Shipping/Receiving.

Table 9–3 (Cont.) Security Permissions

Permission	Topic	Usage
Access SIOCS Managed Stores	Admin	With this permission, the user will have access to the SIOCS Managed Stores screen in EICS.
Access Store Administration	Admin	With this permission, the user will have access to Store Administration dialog.
Access Store Administration Default	Admin	With this permission, the user will have access to Store Administration default dialog.
Access Store Shipping Network	Admin	With this permission, the user will have access to the Store Shipping Network screen in the desktop application.
Access Sub Buckets	Admin	With this permission, the user can access the Sub bucket dialog.
Access Supplier CFAs	Admin	With this permission, the CFAs will be available on Supplier Detail in Supplier Lookup.
Access Supplier Lookup	Admin	With this permission the user will have access to Supplier Lookup and the Supplier Lookup menu option will appear in the drawer (main menu).
Access System Administration	Admin	With this permission, the user will have access to the 'System Administration' dialog.
Access Technical Maintenance	Admin	With this permission, the user will have access to Technical Maintenance dialog.
Access Transaction History	Admin	With this permission the user will have access to the Transaction History dialog.
Access Translation Setup	Admin	With this permission, the user can access the Translation Setup dialog.
Access Troubled Transaction	Admin	With this permission, the user can select the Troubled Transaction List from the Inventory Management menu.
Access UDA Print Setup	Admin	With this permission, the user can access the UDA Print Setup dialog in the desktop application.
Access UDAs	Admin	With this permission, in Item Lookup the user will be able to search for an item by a search type of UDA. Also, the UDAs will be available on Item Detail in Item Lookup.
Access UIN Label Setup	Admin	With this permission, the user can access the UIN Label Setup dialog in the desktop application.
Access Unit of Measure	Admin	User must have this permission for the Unit of Measure menu option to be available within the Configuration menu. With this permission the user will be able to do all operations on this screen. (Add ""+"" , Remove ""-"" and Edit).
All Stores Product Groups	Admin	With this permission, Product Groups for All Stores can be created as well as edited. Without this permission, Product Groups cannot be created for all stores and they can only be viewed for all stores.

Table 9–3 (Cont.) Security Permissions

Permission	Topic	Usage
Allow Bulk Scan	Admin	<p>With this permission, the user will have access to the Bulk Scan dialog.</p> <p>The Bulk Scan menu option will be in the footer menu of applicable transaction item list screens.</p> <p>The Bulk scan type will be available as a scan mode in the mode bar.</p>
Batch Execution Delete	Admin	With this permission, the user will be able to delete the issues in bulk Import, Transaction Execution and Data Purge tasks via Operational Issues Dialog.
Create Item Scan Number	Admin	With this permission, the user is allowed to create a new item scan number in the system.
Create Notes	Admin	With this permission, the user will be able to add notes within the notes dialog.
Create Product Group Schedules	Admin	With this permission, the user can create new Product Group Schedules.
Create Product Groups	Admin	With this permission, the user will be able to create a new Product Group.
Create Translations	Admin	With this permission, the user can create new translations.
Delete Item Scan Number	Admin	With this permission, the user is allowed to delete an existing Item Scan Number.
Delete MPS Staged Messages	Admin	User must have this permission in order to delete the inbound and outbound messages.
Delete Product Group Schedules	Admin	With this permission, the user can delete Product Group Schedules.
Delete Product Groups	Admin	With this permission, the user can delete a Product Group.
Display Stock Locator	Admin	With this permission, the user will have access to Stock Locator within Item Lookup.
Edit Item Scan Number	Admin	With this permission, the user is allowed to edit an existing Item Scan Number. Applicable for webservice operation.
Edit Item Scan Number CDA	Admin	This is required for web service action to edit the Item Scan number CDAs.
Edit Job Schedules	Admin	With this permission the user can edit Job Schedules.
Edit POS Transaction	Admin	On desktop application, with this permission, the user can edit the troubled pos transaction message.
Edit Product Group Schedules	Admin	With this permission, the Product Group Schedule will be editable.
Edit Product Groups	Admin	With this permission, the user can Edit an existing Product Group which also includes adding and removing Product Group Components.
Edit UDA Print Setup	Admin	With this permission, the user can edit the UDA Print Setup values in the desktop application.

Table 9–3 (Cont.) Security Permissions

Permission	Topic	Usage
Update Resolution Status	Admin	With this privilege the Resolve/Reset button on the Troubled Transactions List screen will be displayed and enabled.
Update UIN Status	Admin	With this permission, the user can update the status of the UIN from the history screen.
View UIN History	Admin	With this permission, the user will be able to access the UIN Lookup feature and view the history in EICS.
Warehouse Inventory Access	Admin	With this permission, the warehouse inventory details will be included in the Stock Locator Item Lookup section.
Access Area	Area	With this permission, the user will have access to the Area dialog.
Confirm Area	Area	With this permission, the user will be able to Confirm an Area.
Create Area	Area	With this permission, the user will be able to create Areas.
Delete Area	Area	With this permission, the user will be able to delete an Area.
Edit Area	Area	With this permission, the user will be able to edit active Areas.
Access Customer Details	Customer Order	With this permission the user will have access to the Customer Details (name, address, and so on) associated with the customer order.
Access Customer Order	Customer Order	With this permission, the user will have access to Customer Orders dialog.
Access Customer Order Delivery	Customer Order	With this permission, a user can access the Customer Order Delivery dialog.
Access Customer Order Delivery Attribute	Customer Order	With this permission, the user will have access to Customer Order Delivery Attributes.
Access Customer Order Management	Customer Order	With this permission, the user will have access to the Customer Order Management operations within the drawer/menu.
Access Customer Order Pick	Customer Order	With this permission, the user will have access to the Customer Order Picking dialog.
Access Customer Order Reverse Pick	Customer Order	With this permission, the user will have access to the Customer Order Reverse Picking dialog.
Cancel Submit Customer Order Delivery	Customer Order	With this permission, the user will be able to Cancel Submit a "Submitted" status Customer Order Delivery that is a "web order."
Confirm Customer Order Pick	Customer Order	With this permission, the user can Confirm a customer order pick.
Confirm Customer Order Reverse Pick	Customer Order	With this permission, the user will be able to Confirm a customer order reverse pick.

Table 9–3 (Cont.) Security Permissions

Permission	Topic	Usage
Create Customer Order Delivery	Customer Order	<p>With this permission, the user can create a new delivery for a Customer Order that is a “web order”.</p> <p>Used in conjunction with Create Customer Order Delivery for Shipment or Create Customer Order Delivery for Pickup permission.</p> <p>This permission must also exist in order to create a delivery that is not a web order from an external system.</p>
Create Customer Order Delivery for Pickup	Customer Order	<p>With this permission, the user will be able to create Customer Order Deliveries which are of type store pickup.</p> <p>Used in conjunction with the Create Customer Order Delivery permission.</p>
Create Customer Order Delivery for Shipment	Customer Order	<p>With this permission, the user will be able to create Customer Order Deliveries which are of type store shipment.</p> <p>Used in conjunction with the Create Customer Order Delivery permission.</p>
Create Customer Order Pick	Customer Order	<p>With this permission, the user will be able to create customer order picks.</p> <p>Picks can be created from within a Customer Order (for a single customer order pick).</p> <p>Picks can be created from within Customer Order Picking.</p>
Create Customer Order Reverse Pick	Customer Order	<p>With this permission, the user will be able to create customer order reverse picks.</p>
Delete Customer Order Delivery	Customer Order	<p>With this permission, the user will be able to delete a customer order delivery that is a “web order”.</p>
Delete Customer Order Pick	Customer Order	<p>With this permission, the user will be able to delete a customer order pick.</p>
Delete Customer Order Reverse Pick	Customer Order	<p>With this permission, the user will be able to delete a customer order reverse pick.</p>
Dispatch Customer Order Delivery	Customer Order	<p>With this permission, the user can Dispatch a Customer Order Delivery that is a “web order”.</p>
Dispatch Incomplete Customer Order Delivery	Customer Order	<p>When dispatching a delivery that requires full delivery (Allow Partial Delivery = ‘No’), the entire delivery must be delivered in full.</p> <p>With this permission, the user will get a warning message and will be able to continue the dispatch without full delivery.</p> <p>Without this permission the delivery must be in full.</p>
Edit Customer Order BOL	Customer Order	<p>With this permission, the user will be able to edit the details of the Bill of Lading associated with a customer order delivery. This is done in the Edit Delivery screen.</p> <p>User must also have Edit Customer Order Delivery permission.</p>

Table 9–3 (Cont.) Security Permissions

Permission	Topic	Usage
Edit Customer Order CFA	Customer Order	With this permission, the user will be able to capture CFAs for a customer order.
Edit Customer Order Delivery	Customer Order	With this permission, the user can edit an existing delivery for a Customer Order that is a “web order”.
Edit Customer Order Delivery Attribute	Customer Order	With this permission, the user can edit the Customer Order Delivery Attributes.
Edit Customer Order Delivery CFA	Customer Order	With this permission, the user will be able to capture CFAs for a Customer Order Delivery
Edit Customer Order Pick	Customer Order	With this permission, the user will be able to edit active customer order picks.
Edit Customer Order Pick CFA	Customer Order	With this permission, the user will be able to capture CFAs for a Customer Order Pick.
Edit Customer Order Reverse Pick	Customer Order	With this permission, the user will be able to edit active reverse picks
Edit Customer Order Reverse Pick CFA	Customer Order	With this permission, the user will be able to capture CFAs for a Customer Order Reverse Pick
Edit Quantity Delivery	Customer Order	<p>With this permission, the user will be able to tap on the item quantity and the quantity widget will open to edit the quantity.</p> <p>User must also have Edit Customer Order Delivery permission as well.</p> <p>Without this permission, the quantity is not editable via the manual dialog and only scanning is allowed.</p>
Edit Quantity Picking	Customer Order	<p>With this permission, the user will be able to tap on the item quantity and the quantity widget will open to edit the quantity.</p> <p>User must also have Edit Customer Order Pick permission.</p> <p>Without this permission, the quantity is not editable via the manual dialog and only scanning is allowed.</p>
Edit Quantity Reverse Picking	Customer Order	<p>With this permission, the user will be able to tap on the item quantity and the quantity widget will open to edit the quantity.</p> <p>User must also have Edit Customer Order Reverse Pick permission.</p> <p>Without this permission, the quantity is not editable via the manual dialog and only scanning is allowed.</p>
Item Substitution For Picking	Customer Order	With this permission, the user will have access to the Item Substitution dialog within Customer Order Picking.
Reject Customer Order	Customer Order	With this permission, the user will be able to Reject a Customer Order.

Table 9–3 (Cont.) Security Permissions

Permission	Topic	Usage
Submit Customer Order Delivery	Customer Order	With this permission, the user will be able to Submit a Customer Order Delivery that is a “web order”. Used in conjunction with Modify Customer Order Delivery permission.
View Customer Order BOL	Customer Order	With this permission, the user can access and view the details of the Bill of Lading associated with a customer order delivery.
Container Items Limited To	Data	With this permission, the user can access data criteria associated with adding items to a container. This is selected by each individual criterion.
Counting Method	Data	With this permission, the user can access specific counting methods. This is selected by each individual counting method.
Display List Diff Types	Data	With this permission, the user can access the display of diff types. This is selected by each individual diff type.
Inventory Adjustment Reason Code	Data	With this permission, the user can access specific inventory adjustment reason codes. This is selected by each individual reason code.
Item Basket Types	Data	With this permission, the user can access specific item basket types. This is selected by each individual basket types.
Location Types	Data	With this permission, the user can access specific location types. This is selected by each individual location type.
Print Format Type	Data	With this permission, the user can access specific print format types. This is selected by each individual format type.
Product Group Type	Data	With this permission, the user can access specific product group types. This is selected by each individual product group type.
Role Type	Data	With this permission, the user can access specific role types. This is selected by each individual role type.
RTV Reason Code	Data	With this permission, the user can access specific RTV reason codes. This is selected by each individual reason code.
RTV Shipment Reason Code	Data	With this permission, the user can access specific RTV shipment reason codes. This is selected by each individual reason code.
Scan List Type	Data	With this permission, the user can access specific scan list types. This is selected by each individual scan list type.
Shelf Adjustment Type	Data	With this permission, the user can access specific shelf adjustment types. This is selected by each individual adjustment type.
Shelf Replenishment Type	Data	With this permission, the user can access specific shelf replenishment types. This is selected by each individual type.

Table 9–3 (Cont.) Security Permissions

Permission	Topic	Usage
Store Order Delivery Timeslots	Data	With this permission, the user can access specific delivery timeslots. This is selected by each individual timeslot.
Transaction Type	Data	With this permission, the user can access specific transaction types. This is selected by each individual transaction type.
Transfer Destination Type	Data	With this permission, the user can access specific transfer destination types. This is selected by each individual transfer destination type.
Transfer Shipment Reason Code	Data	With this permission, the user can access specific transfer destination types. This is selected by each individual transfer destination type.
Access Adjust Container DSD Receiving	DSD Receiving	With this permission, the user will be able to adjust the container in a delivery.
Access Confirm Container DSD Receiving	DSD Receiving	With this permission, the user can confirm the container receipt from the supplier.
Access Confirm DSD Receipt	DSD Receiving	With this permission, the user will be able to confirm the Direct store delivery.
Access Create Container	DSD Receiving	With this permission, the user can create a new container in the DSD receipt.
Access Delete Container	DSD Receiving	With this permission, the user can delete a container.
Access Delete Receipt	DSD Receiving	With this permission, the user will be able to delete a direct store delivery.
Access Document DSD Receiving	DSD Receiving	With this permission, the user will be able to select the PO to apply items on the receipt. User must also have Edit container and Modify container permissions in order to do this operation.
Access DSD Receiving	DSD Receiving	With this permission, the user will have access to the DSD Receiving dialog.
Access DSD Receiving Ext. Attribute	DSD Receiving	With this permission, the user will be able to access the DSD Receiving Ext. Attributes.
Access Purchase Order	DSD Receiving	With this permission, the user will be able to access the Purchase Orders.
Access Reject Delivery	DSD Receiving	With this permission, the user will be able to reject a direct store delivery.
Activate Container Edits	DSD Receiving	User needs this permission combined with the other respective permission(s) to update any information on the container.
Add Unexpected Item	DSD Receiving	With this permission, the user will be able to add the unexpected items to the container.
Allow ASN Over Receiving	DSD Receiving	For PO's with an ASN: With this permission, when entering a received quantity, it is OK, to exceed the ASN quantity. Without this permission, the received quantity cannot exceed the ASN quantity.

Table 9–3 (Cont.) Security Permissions

Permission	Topic	Usage
Allow DSD Receiving With PO	DSD Receiving	With this permission, the user will be able to create a receipt against a PO but without ASN.
Allow DSD Receiving Without PO	DSD Receiving	With this permission, the user will be able to create a receipt without PO.
Allow PO Over Receiving	DSD Receiving	For PO's with and without an ASN: With this permission, when entering a received quantity, it is OK, to exceed the PO quantity. Without this permission, the received quantity cannot exceed the PO quantity.
Allow Receiving Damages	DSD Receiving	With this permission, the user will be able to receive damaged items and make all remaining quantity to be received as damaged. User must also have Edit container and Modify container permissions in order to do this operation.
Default Qty in All Containers	DSD Receiving	With this permission, the user will be able to default the received quantity for all the containers in the delivery.
Default Qty in Container	DSD Receiving	With this permission, the user will be able to default the received quantity with the remaining quantity in the container. User must also have permission to 'Modify container' in order to do this operation.
Display Expected Quantity	DSD Receiving	With this permission, the user will be able to view the expected quantity during the receipt.
Edit Container	DSD Receiving	With this permission, the user can edit the container line items, modify the line item quantities or delete the item. User must also have permission to 'Modify container' in order to do this operation.
Edit Container CFA	DSD Receiving	With this permission, the user will be able to capture CFAs for a Container in DSD Receiving.
Edit Container Info DSD Receiving	DSD Receiving	With this permission, the user will be able to edit the container information. User must also have permission to 'Modify container' in order to do this operation.
Edit Delivery CFA	DSD Receiving	With this permission, the user will be able to capture CFAs for a DSD.
Edit Delivery Info	DSD Receiving	With this permission, the user will be able to edit the delivery information.
Edit DSD Receiving Ext. Attribute	DSD Receiving	With this permission, the user will be able to edit the DSD Receiving Ext. Attributes.
Edit Quantity	DSD Receiving	With this permission, the user will be able to edit the quantity of the item in the delivery. User must also have Edit container and Modify container permissions in order to do this operation.

Table 9–3 (Cont.) Security Permissions

Permission	Topic	Usage
Override Not After Date Check	DSD Receiving	With this permission, the user can override the not after date check. This permission will allow the user to receive delivery where the receipt date passed the not after date in PO.
Override Supplier Discrepancies	DSD Receiving	With this permission, the user will be able to override the supplier discrepancies when quantity is validated.
Receive Direct Delivery on Shop Floor	DSD Receiving	With this permission, the user will be able to receive delivery on shop floor directly.
Access Inventory Adjustment	Inventory Adjustments	With this permission a user will have access to the Inventory Adjustment dialog.
Access Inventory Adjustment Attribute	Inventory Adjustments	With this permission a user will have access to the Inventory Adjustment Attributes.
Complete Inventory Adjustment	Inventory Adjustments	With this permission, the user can Confirm an inventory adjustment. User must also have data permissions for each adjustment reason on the adjustment.
Create Inventory Adjustment	Inventory Adjustments	With this permission, the user can create a new inventory adjustment. This permission must exist as well for a user to copy a “completed” inventory adjustment. User must also have data permissions for each adjustment reason on the adjustment.
Delete Inventory Adjustment	Inventory Adjustments	With this permission, the user will be able to delete an inventory adjustment. User must also have data permissions for each adjustment reason on the adjustment.
Edit Inventory Adjustment	Inventory Adjustments	With this permission, the user will be able to edit existing inventory adjustments. User must also have data permissions for each adjustment reason on the adjustment.
Edit Inventory Adjustment Attribute	Inventory Adjustments	With this permission, the user will be able to edit existing inventory adjustment attributes.
Edit Inventory Adjustment CFA	Inventory Adjustments	With this permission, the user will be able to capture CFAs for an inventory adjustment.
Edit Quantity	Inventory Adjustments	With this permission, the user will be able to tap on the item quantity and the quantity widget will open to edit the quantity. User must also have Edit Inventory Adjustment permission as well as data permissions for each adjustment reason on the adjustment.
Access Item Basket	Item Basket	With this permission, the user will have access to the Item Basket dialog.
All Stores Item Basket	Item Basket	With this permission, Item Baskets for All Stores can be created as well as edited. Without this permission, Item Baskets cannot be created for all stores and they can only be viewed for all stores.

Table 9–3 (Cont.) Security Permissions

Permission	Topic	Usage
Confirm Item Basket	Item Basket	With this permission, the user will be able to Confirm an Item Basket.
Create Item Basket	Item Basket	With this permission, the user will be able to create Item Baskets.
Delete Item Basket	Item Basket	With this permission, the user will be able to delete an Item Basket.
Edit Item Basket	Item Basket	With this permission, the user will be able to edit active Item Baskets.
Edit Item Basket CFA	Item Basket	With this permission, the user will be able to capture CFAs on an Item Basket.
Edit Quantity Item Basket	Item Basket	With this permission, the user will be able to tap on the item quantity and the quantity widget will open to edit the quantity. User must also have Edit Item Basket permission. Without this permission, the quantity is not editable via the manual dialog and only scanning is allowed.
Import Item Basket	Item Basket	With this permission, the user will have the Import Item Basket menu option within an Item Basket on mobile.
Investigate Item Basket	Item Basket	With this permission, the investigate menu option in item lookup will be available and the user will be able to add an item to an existing item basket or create a new item basket if one doesn't exist for investigation in item lookup. Without this permission, the investigate menu option in item lookup will not be available.
Access Notifications	Notifications	With this permission, the bell notification icon will be displayed in the drawer/menu as well as on the Open Transactions header. The view on the notification will also be displayed.
Customer Order Pick Reminder	Notifications	With this permission, the user will be notified, if the pick list has been created but not actioned.
Customer Order Reauthorization	Notifications	With this permission the user will receive a notification when the payment reauthorization for a customer order is successful.
Customer Order Receipt	Notifications	With this permission, the user will be notified when customer orders are received.
Customer Order Reminder	Notifications	With this permission, the user will be notified when the customer order has not been fulfilled.
Damaged Delivery	Notifications	With this permission, the user will be notified when the delivery includes damaged items.
Display External Scanner Notifications	Notifications	With this permission, the user will be notified with a popup that appears when a scanner is connected or disconnected or has a low battery for that event.
Display Notification Warning	Notifications	With this permission, the user will receive a notification warning when a new notification is created / inserted into the system.

Table 9–3 (Cont.) Security Permissions

Permission	Topic	Usage
Finisher Delivery Unable to Auto-Receive	Notifications	With this permission, the user will receive a notification warning when a finisher delivery is not auto received.
Finisher UIN Discrepancy	Notifications	With this permission, the user will be notified when a finisher return received quantity does not match the number of serial numbers on the return. Without this permission, the user will not be notified.
Misdirected Container	Notifications	With this permission, the user will be notified when a container has been received in another location.
New Customer Order	Notifications	With this permission, the user will be notified when customer orders are created.
New Customer Order Reverse Pick	Notifications	With this permission, the user will be notified when a new cross channel customer order reverse picks arrives.
Over Received Quantity	Notifications	With this permission, the user will be notified when the number of pre-populated serial numbers exceeds the received quantity. Without this permission, the user will not be notified.
Receiving UIN Discrepancy	Notifications	With this permission, the user will be notified when the number of pre-populated serial numbers does not match the received quantity. Without this permission, the user will not be notified.
RTV Request Expiration Approaching	Notifications	With this permission, the user will be notified if the supplier return request expiration date is approaching.
RTV Unavailable request quantity	Notifications	With this permission, the user will be notified if there is not enough inventory in the unavailable bucket to send back to supplier from a return request.
Shipped Delivery Overdue	Notifications	With this permission, the user will be notified when the shipped delivery has not been received and has passed the expected date.
Store Delivery Unable to Auto-Receive	Notifications	With this permission, the user will be notified when a store delivery has discrepancies and cannot be auto received.
Store Receiving Over/Under	Notifications	With this permission, the user will be notified when a store transfer has over/under received quantities.
Transfer Request	Notifications	With this permission, the user will be notified when a transfer request is created.
Transfer Request Approved	Notifications	With this permission, the user will be notified when a transfer request is approved.
Transfer Request Expiration Approaching	Notifications	With this permission, the user will be notified when a transfer request has not been approved and the request is about to expire. This is based on the not after date set.

Table 9–3 (Cont.) Security Permissions

Permission	Topic	Usage
Transfer Request Rejected	Notifications	With this permission, the user will be notified when a transfer request is rejected.
Transfer Unavailable Request Quantity	Notifications	With this permission, the user will be notified when the requested quantity is no longer available at the requested source location.
UIN Items on Incoming ASN Failed	Notifications	With this permission, the user will be notified if an Auto Generated SN item is on the ASN with pre-generated numbers when processing thru the RIB. Without this permission, the user will not be notified.
Unexpected UIN (Store Changed)	Notifications	With this permission, the user will be notified when UINs are discovered at a store where they should not be. Without this permission, the user will not be notified.
Warehouse Delivery Unable to Auto-Receive	Notifications	With this permission, the user will be notified when the delivery includes pre-populated serial numbers and cannot be automatically received.
Send Transaction Notification	Open Transactions	With this permission the user will be able to send a notification. This is done from within the Open Transactions dialog; the user will be able to swipe an open transaction and send a notification.
View Transactions	Open Transactions	With this permission the user will have the potential to view all the open transactions for the user's store (depending on data permissions). Without this permission, the Open Transactions dialog will still display (just without the transactions listed); however, the list of open transactions will be empty.
Access Out of Stock Lookup	Operational Views	On EICS, with this permission, the Out of Stock operational view menu is displayed and user is allowed to view the out of stock operational view.
Access New Received Items	Operational Views	On EICS, with this permission the user will be able to access the Access New Items view in Operational Views.
Access Expiring Items Lookup	Operational Views	On EICS, with this permission the user will be able to access the Expiring Items view in Operational Views.
Access Stock Counts - Ready to Authorize	Operational Views	On EICS, with this permission the user will be able to access the Stock Counts - Ready to Authorize view in Operational Views.
Access Shopfloor Out of Stock	Operational Views	On EICS, with this permission the user will be able to access the Access Shopfloor Out of Stock view in Operational Views.
Accept RTV	RTV	With this permission, the user will be able to approve a return request. User must also have data permissions for each return reason on the return.

Table 9–3 (Cont.) Security Permissions

Permission	Topic	Usage
Access RTV	RTV	With this permission, a user will have access to the RTV dialog and the RTV menu option will appear in the Drawer.
Activate RTV Edits	RTV	User is required to have Activate RTV Edits permission for Edit RTV or Edit RTV Info to activate. That is, the changes made on the RTV, because the user had Edit RTV and Edit RTV Info permissions, cannot be committed unless the user has Activate RTV Edits permission.
Add Items To RTV	RTV	With this permission, the user will be able to add items to a return. User must also have Modify RTV and Edit RTV permissions as well as data permissions for each return reason on the RTV
Close RTV	RTV	With this permission, the user will be able to close an RTV. User must also have data permissions for each return reason on the return.
Create RTV	RTV	With this permission, the user can create a new return. User must also have data permissions for each return reason on the return.
Delete RTV	RTV	With this permission, the user can delete a return. User must also have data permissions for each return reason on the return.
Edit Quantity	RTV	With this permission, the user will be able to tap on the item quantity and the quantity widget will open to edit the quantity. User must also have Modify RTV and Edit RTV permissions as well as data permissions for each return reason on the RTV. Without this permission, the quantity is not editable via the manual dialog and only scanning is allowed.
Edit RTV	RTV	With this permission, the user will be able to edit existing RTV like line item details, qty, and so on. User must also have data permissions for each Return reason on the RTV.
Edit RTV CFA	RTV	With this permission, the user will be able to capture CFAs for an RTV document.
Edit RTV Info	RTV	With this permission, the user will be able to edit the header information of an RTV.
Reject RTV	RTV	With this permission, the user will be able to reject a return request. User must also have data permissions for each return reason on the return.
Access RTV Shipment	RTV Shipment	With this permission, the user can access shipments from RTV requests. Without this permission, the user will not be able to access the shipments from RTV requests.

Table 9–3 (Cont.) Security Permissions

Permission	Topic	Usage
Access RTV Shipment Attribute	RTV Shipment	With this permission, the Attributes tab on the RTV Shipment Container - Item Detail screen is displayed and enabled.
Activate RTV Shipment Container Edits	RTV Shipment	With this permission, the user will be allowed to commit any changes made to the shipment.
Add Unexpected Items to RTV Shipment	RTV Shipment	With this permission, the user will be allowed to add items that are not present in the RTV Document, into the shipment. User must also have Modify Container and Edit Container permission as well as data permissions for each return reason on the container.
Adjust Carrier	RTV Shipment	With this permission, the user will be able to update the BOL details of a shipment even after at least one container has been confirmed.
Adjust Container RTV Shipment	RTV Shipment	With this permission, the user will be allowed to bring the container back to editable status. User must also have data permissions for each return reason on the container.
Allow over shipping RTV Shipment	RTV Shipment	With this permission, the user will be allowed to go over Approved quantity in the RTV document User must also have Modify Container and Edit Container permission as well as data permissions for each return reason on the container. Without this permission, the user will not be allowed to enter qty more than Approved qty.
Cancel Submit RTV Shipment	RTV Shipment	With this permission, the user can cancel submit RTV shipments.
Close RTV Shipment	RTV Shipment	With this permission, the user can close RTV shipments. Without this permission, the user will not be able to close RTV shipments.
Confirm RTV Shipment Container	RTV Shipment	With this permission, the user can confirm containers in the shipments. User must also have data permissions for each return reason on the container.
Create RTV Shipment	RTV Shipment	With this permission, the user can create shipments for RTV requests.
Create RTV Shipment Container	RTV Shipment	With this permission, the user will be allowed to create a container for the shipment.
Default Items to RTV Shipment	RTV Shipment	With this permission, the user will be allowed to add items from the RTV document into shipment. User must also have data permissions for each return reason on the shipment. Without this permission, the user will not be allowed to add items from the RTV document into shipment
Delete RTV Shipment	RTV Shipment	With this permission, the user can delete RTV shipments.

Table 9–3 (Cont.) Security Permissions

Permission	Topic	Usage
Delete RTV Shipment Container	RTV Shipment	With this permission, the user can delete containers in the shipments. User must also have data permissions for each return reason on the container.
Dispatch Shipment	RTV Shipment	With this permission, the user can dispatch RTV shipments.
Edit Container CFA	RTV Shipment	With this permission, the user will be able to capture CFAs for a container in RTV shipment.
Edit Container RTV Shipment	RTV Shipment	With this permission, the user will be allowed to edit the line item details, update qty, remove item, restore item, cancel the current edits, and so on, User must also have Modify Container permission as well as data permissions for each return reason on the container. Without this permission, the user will not be allowed to edit any line item details, update qty, remove item, restore item, cancel the current edits, and so on.
Edit Quantity	RTV Shipment	With this permission, the user will be able to tap on the item quantity and the quantity widget will open to edit the quantity. User must also have Modify Container and Edit Container permission as well as data permissions for each return reason on the container. Without this permission, the quantity is not editable via the manual dialog and only scanning is allowed.
Edit RTV Container Info	RTV Shipment	With this permission, the user will be allowed to edit the container header details. User must also have Activate Container Edits permission.
Edit RTV Shipment Attribute	RTV Shipment	With this permission, the user will be allowed to edit the RTV Shipment Attributes.
Edit RTV Shipment BOL	RTV Shipment	With this permission, the user will be allowed to edit the shipment BOL details.
Edit RTV Shipment Info	RTV Shipment	With this permission, the user will be allowed to edit the shipment header details.
Edit Shipment CFA	RTV Shipment	With this permission, the user will be able to capture CFAs on an RTV shipment.
Submit RTV Shipment	RTV Shipment	With this permission, the user can submit RTV shipments.
View RTV Shipment BOL	RTV Shipment	With this permission, the user will be allowed to view the shipment BOL details.
Access Role Maintenance	Security	User must have this permission for the Role Maintenance menu option to be available under Security in EICS.
Access Security	Security	With this permission the user will have access to the Security dialog in EICS.

Table 9–3 (Cont.) Security Permissions

Permission	Topic	Usage
Access User Maintenance	Security	User must have this permission for the User Assignment menu option to be available under Security in EICS.
Delete Role	Security	User must have this permission in order to delete roles.
Delete User	Security	User must have this permission in order to delete user profiles.
Edit User	Security	User must have this permission in order to assign roles and stores to a user.
Access Scan List	Shelf Replenishment	With this permission, the user will have access to Item Scan List dialog.
Access Shelf Adjustment	Shelf Replenishment	With this permission, the user will have access to Shelf Adjustment dialog.
Access Shelf Replenishment	Shelf Replenishment	With this permission, the user will have access to the in-store replenishment dialog.
Confirm Shelf Adjustment	Shelf Replenishment	With this permission, the user can confirm the shelf adjustment.
Confirm Shelf Replenishment	Shelf Replenishment	With this permission, the user can confirm the replenishment pick.
Create Scan List	Shelf Replenishment	With this permission, the user can create a new item scan list. User must also have data permissions for each scan list type to create a new scan list of that type.
Create Shelf Adjustment	Shelf Replenishment	With this permission, the user can create a new shelf adjustment.
Create Shelf Replenishment	Shelf Replenishment	With this permission, the user can create a new shelf replenishment pick. User must have the data permission for each shelf replenishment pick type to do this operation.
Default Shelf Replenishment Quantity	Shelf Replenishment	With this permission, the user can default the quantity on replenishment pick. The user must also have the Edit replenishment permission to do this operation.
Delete Scan List	Shelf Replenishment	With this permission, the user will be able to delete a scan list.
Delete Shelf Adjustment	Shelf Replenishment	With this permission, the user can delete the shelf adjustment.
Delete Shelf Replenishment	Shelf Replenishment	With this permission, the user can delete the shelf replenishment pick.
Edit Scan List	Shelf Replenishment	With this permission, the user will be able to edit and save the scan list.
Edit Scan List CFA	Shelf Replenishment	With this permission, the user will have the ability to capture CFAs for a Scan List.
Edit Scan List Quantity	Shelf Replenishment	With this permission, the user will be able to edit the quantity on the UI using the widget. User must also have the Edit Scan List permission to do this.

Table 9–3 (Cont.) Security Permissions

Permission	Topic	Usage
Edit Shelf Adjustment	Shelf Replenishment	With this permission, the user can edit and save the shelf adjustment.
Edit Shelf Adjustment CFA	Shelf Replenishment	With this permission, the user will have the ability to capture CFAs for a Shelf Adjustment.
Edit Shelf Adjustment Quantity	Shelf Replenishment	With this permission, the user can edit the quantity using the widget on the UI.
Edit Shelf Replenishment	Shelf Replenishment	With this permission, the user will be able to edit the existing shelf replenishment pick.
Edit Shelf Replenishment CFA	Shelf Replenishment	With this permission, the user will have the ability to capture CFAs for Replenishment Pick List.
Edit Shelf Replenishment Quantity	Shelf Replenishment	With this permission, the user can edit the quantity using the quantity widget on the UI. Without this permission, the quantity is not editable via the manual dialog and only scanning is allowed.
Replenishment Item Substitution	Shelf Replenishment	With this permission, the user can substitute the pick items. The user must also have the Edit replenishment permission to do this operation.
Access Stock Count	Stock Counts	With this permission, the user can access the Stock Counts dialog.
Access Stock Count Attribute	Stock Counts	With this permission, the Attributes tab on the Stock Counts - Item Detail screen is displayed and enabled.
Apply Late Sales	Stock Counts	With this permission, Apply Late Sales button will be available to the user in the Stock Count Authorization Detail screen.
Complete Child Stock Count	Stock Counts	With this permission, the user can complete the child stock count.
Confirm Authorization Stock Count	Stock Counts	With this permission, the user can confirm the authorization.
Create Ad Hoc Stock Count	Stock Counts	With this permission, the user can create a new adhoc stock count.
Delete Stock Count	Stock Counts	With this permission, the user can delete a stock count.
Edit Adhoc Stock Count	Stock Counts	With this permission, the user can edit the ad hoc stock count.
Edit Adhoc Stock Count Lock	Stock Counts	With this permission, the user will have the ability to enable and disable the Adhoc Stock count Lock for an adhoc stock count.
Edit Authorizaton Stock Count	Stock Counts	With this permission, the user can access the Stock count authorization dialog on the desktop. Ability to apply late sales.
Edit Stock Count Attribute	Stock Counts	With this permission, extended attributes can be added/removed: Add Attributes and Remove Attributes (Trash can) buttons will be available on the Attributes tab of the Stock Counts - Item Detail screen.

Table 9–3 (Cont.) Security Permissions

Permission	Topic	Usage
Edit Stock Count CFA	Stock Counts	With this permission, the user will have the ability to capture CFAs in Stock Count and Recount.
Edit Stock Count Quantity	Stock Counts	With this permission, the user can edit the quantity using the quantity widget.
Edit Unit Amount Stock Count	Stock Counts	With this permission, the user is allowed to do update for the stock counts that are of type unit and amount
Edit Unit Stock Count	Stock Counts	With this permission, the user can update the stock count of unit or problem line stock count types.
Rejected Item Stock Count	Stock Counts	With this permission, the user will have access to the Rejected Items dialog.
Snapshot Stock Count	Stock Counts	With this permission, the user is allowed to take a snapshot at the master stock count level.
Snapshot Stock Count Child	Stock Counts	With this permission, the user is allowed to take the snapshot at the child stock count level.
Stock Count Import Basket	Stock Counts	With this permission, the user will have the Import Item Basket footer menu option in the Bulk Scan screen within Stock Counts.
Update Authorization Quantity	Stock Counts	With this permission, the user can update the authorization quantity and default the last count quantity to authorized quantity while in the process of authorization.
View Variance	Stock Counts	With this permission, the user will be able to view the variance (difference) between the snapshot quantity and the total quantity counted during counting.
Access Store Orders	Store Order	With this permission, the user will have access to the Store Orders dialog.
Approve Store Orders	Store Order	With this permission, the user will be able to Approve a Store Order.
Create Store Orders	Store Order	With this permission, the user will be able to create Store Orders.
Delete Store Orders	Store Order	With this permission, the user will be able to delete a Store Order.
Display Sales Forecast	Store Order	With this permission, the Sales Forecast on the Sales Data screen will be displayed.
Display Sales History	Store Order	With this permission, the Sales History on the Sales Data screen will be displayed.
Display Store Order Cost	Store Order	With this permission the Total Estimated Cost will be displayed on the Info screen in store orders. The unit cost will be displayed on the Store Orders Item Detail. The Refresh Cost button will be displayed in the Store Order Items footer menu.

Table 9–3 (Cont.) Security Permissions

Permission	Topic	Usage
Edit Quantity	Store Order	With this permission, the user will be able to tap on the item quantity and the quantity widget will open to edit the quantity. User must also have Edit Store Orders permission. Without this permission, the quantity is not editable via the manual dialog and only scanning is allowed.
Edit Store Order CFA	Store Order	With this permission, the user will be able to edit CFAs on the store order. The Edit CFA menu option will be available in the footer menu.
Edit Store Orders	Store Order	With this permission, the user will be able to edit active Store Orders.
Access Format Assignment	Ticketing	With this permission, the user is allowed to access the format assignment dialog in the desktop application.
Access Print Format	Ticketing	With this permission, the user is allowed to access the ticket print format dialog.
Access Print Item	Ticketing	With this permission, the user is allowed to access the print item dialog.
Access Ticket List	Ticketing	With this permission, the user can access the Ticket List.
Access Ticket Template Upload	Ticketing	With this permission, the user can access the Upload Ticket Templates screen to upload the ticketing layout.
Allow Override Ticket Price	Ticketing	With this permission, the user can override the ticket price on the ticket detail screen.
Create Format Assignment	Ticketing	With this permission, the user is allowed to create a new item basket based format assignment.
Create Ticket	Ticketing	With this permission, the user is allowed to create a new ticket in the ticketing dialog.
Delete Format Assignment	Ticketing	With this permission, the user is allowed to delete a format assignment.
Delete Ticket	Ticketing	With this permission, the user is allowed to delete a ticket in the ticketing dialog.
Delete Ticket Template	Ticketing	With this permission, the user is allowed to delete a ticket template screen.
Edit Format Assignment	Ticketing	With this permission, the user is allowed to edit an existing format assignment.
Edit Ticket	Ticketing	With this permission, the user can edit an existing ticket.
Print Ticket	Ticketing	With this permission, the user can print the tickets in the ticketing dialog.
Print Tickets from Container Items	Ticketing	With this permission, the user is allowed to generate and print tickets from the container items screen both in transaction and lookup
Accept Transfer Request	Transfer	With this permission, the user will be able to accept a transfer request.

Table 9–3 (Cont.) Security Permissions

Permission	Topic	Usage
Access Transfer	Transfer	With this permission, a user will have access the transfers.
Access Transfer context	Transfer	With this permission, a user will be able to view the Context type details in a transfer.
Access Transfer Request	Transfer	With this permission, a user will have access to the Transfer dialog in the application
Approve Transfer	Transfer	With this permission, the user will be able to approve a transfer document.
Close Transfer	Transfer	With this permission, the user will be able to close a transfer.
Create Request	Transfer	With this permission, the user will be able to create a transfer request.
Create Transfer	Transfer	With this permission, the user will be able to create a transfer document.
Delete Request	Transfer	With this permission, the user will be able to delete a transfer request.
Delete Transfer	Transfer	With this permission, the user will be able to delete a transfer document.
Edit Quantity	Transfer	<p>With this permission, the user will be able to tap on the item quantity and the quantity widget will open to edit the quantity.</p> <p>Without this permission, the quantity is not editable via the manual dialog and only scanning is allowed.</p>
Edit Transfer	Transfer	With this permission, the user will be able to edit a transfer document.
Edit Transfer Request	Transfer	With this permission, the user will be able to edit a transfer request.
Edit Transfer Request CFA	Transfer	With this permission, the user will be able to capture CFAs in transfer request documents.
Reject Transfer Request	Transfer	With this permission, the user will be able to reject a transfer request.
Request Transfer	Transfer	With this permission, the user will be able to submit a transfer request.
Access Quick Receiving	Transfer Receiving	With this permission, a user will have access to Transfer Quick Receiving.
Access Transfer Receiving	Transfer Receiving	With this permission, a user will have access to Transfer Receiving.
Access Transfer Receiving Attribute	Transfer Receiving	With this permission, the Attributes tab on the Transfer Receiving Container - Item Detail screen is displayed and enabled.
Activate Container Edits	Transfer Receiving	With this permission, the user will be allowed to commit any changes made to the container. The user will be able to edit the details with the Edit permission however for the changes to be saved to the DB, the Activate Container Edits permission is needed.

Table 9–3 (Cont.) Security Permissions

Permission	Topic	Usage
Add Unexpected Item to Transfer Receiving	Transfer Receiving	<p>With this permission, the user will be allowed to receive items that are not present in the original delivery.</p> <p>User must also have Modify Container and Edit Container permission.</p> <p>Without this permission, the user will not be allowed to receive items that are not present in the original delivery.</p>
Adjust Container	Transfer Receiving	With this permission, the user will be able to bring back a confirmed container to editable status.
Allow Default Zero at Confirmation	Transfer Receiving	<p>With this permission, the user will be able to confirm a transfer receipt with the option to set all non received items to zero.</p> <p>Without this permission, if there are any non received items on the container, the user will get a hard stop and not be able to confirm the delivery.</p>
Confirm Container	Transfer Receiving	With this permission, the user will be able to confirm a container.
Confirm Receipt	Transfer Receiving	With this permission, the user will be able to confirm a transfer delivery.
Create Container	Transfer Receiving	With this permission, the user will be able to create a container.
Default Qty in All Containers	Transfer Receiving	With this permission, the user will be able to default the expected qty in received qty field in all the containers.
Default Quantity in Container	Transfer Receiving	<p>With this permission, the user will be able to default the expected qty in received qty field for the items in the container.</p> <p>User must also have Modify Container and Edit Container permission.</p>
Delete Container	Transfer Receiving	With this permission, the user will be able to delete a container.
Display Expected Qty	Transfer Receiving	With this permission, the user will be able to view Expected Qty of an item in the containers.
Edit Container	Transfer Receiving	<p>With this permission, the user will be allowed to edit the line item details, update qty, remove item, restore item, cancel the current edits, and so on.</p> <p>User must also have Modify Container permission for the changes to be committed to the DB.</p> <p>Without this permission, the user will not be allowed to edit any line item details, update qty, remove item, restore item, cancel the current edits, and so on.</p>
Edit Container CFA	Transfer Receiving	With this permission, the user will be allowed to capture CFAs in the containers of transfer deliveries.
Edit Container Info	Transfer Receiving	<p>With this permission, the user will be allowed to edit the container header details.</p> <p>User must also have Modify Container permission for the changes to be committed to the DB.</p>

Table 9–3 (Cont.) Security Permissions

Permission	Topic	Usage
Edit Delivery CFA	Transfer Receiving	With this permission, the user will be allowed to capture CFAs in the transfer deliveries.
Edit Quantity	Transfer Receiving	<p>With this permission, the user will be able to tap on the item quantity and the quantity widget will open to edit the quantity.</p> <p>User must also have Modify Container and Edit Container permission.</p> <p>Without this permission, the quantity is not editable via the manual dialog and only scanning is allowed.</p>
Edit Receiving Info	Transfer Receiving	With this permission, the user will be able to edit the header details of a transfer delivery
Edit Transfer Receiving Attribute	Transfer Receiving	With this permission, extended attributes can be added/removed: Add Attributes and Remove Attributes (Trash can) buttons will be available on the Attributes tab of the Transfer Receiving Container - Item Detail screen.
Misdirected Container	Transfer Receiving	With this permission, the user will be allowed to copy the items from a misdirected container.
Receive On Shop Floor	Transfer Receiving	<p>With this permission, the user will be able to receive the container on the shopfloor.</p> <p>User must also have Modify Container and Edit Container Info permission.</p> <p>Without this permission, user will not be able to receive the container on the shopfloor.</p>
Record Receipt Damages	Transfer Receiving	With this permission, the user will be able to receive damaged items in a transfer delivery.
Access Container Attribute	Transfer Shipment	With this permission, the Attributes tab on the Transfer Shipment Container - Item Detail screen is displayed and enabled.
Access Shipment	Transfer Shipment	With this permission, a user will have access to the Transfer Shipment dialog for the user in the application.
Activate Container Edits	Transfer Shipment	<p>With this permission, the user will be allowed to commit any changes made to the shipment. The user will be able to edit the details with the Edit Container permission however for the changes to be saved to the DB, the Activate Container Edits permission is needed.</p> <p>Without this permission, the user will not be allowed to commit any changes made to the shipment.</p>
Add Items with No Document	Transfer Shipment	<p>With this permission, the user will be allowed to create an adhoc document through Shipments and add items to it. This controls the visibility of 'No document' button on the Select Document screen.</p> <p>Without this permission, the user will not be allowed to create an adhoc document through shipments and add items to it.</p>

Table 9–3 (Cont.) Security Permissions

Permission	Topic	Usage
Add Unexpected Item to Transfer Shipment	Transfer Shipment	<p>With this permission, the user will be allowed to add items that are not present in the Transfer Document, into the shipment.</p> <p>User must also have Modify Container and Edit Container permissions.</p> <p>Without this permission, the user will not be allowed to add items that are not present in the Transfer document, into the shipment.</p>
Adjust Carrier	Transfer Shipment	<p>With this permission, the user will be able to update the BOL details of a shipment even after at least one container has been confirmed.</p> <p>Without this permission, the user will not be able to update the BOL details of a shipment after at least one container has been confirmed.</p>
Adjust Container	Transfer Shipment	With this permission, the user will be allowed to bring the container back to editable status.
Cancel Submit Shipment	Transfer Shipment	With this permission, the user can cancel submit Transfer shipments.
Confirm Container	Transfer Shipment	With this permission, the user can confirm containers in the shipments.
Create Shipment	Transfer Shipment	<p>With this permission, the user can create shipments for Transfer documents.</p> <p>Without this permission, the user will not be able to create shipments for Transfer documents.</p>
Delete Container	Transfer Shipment	With this permission, the user can delete containers in the shipments.
Delete Shipment	Transfer Shipment	With this permission, the user can delete transfer shipments.
Dispatch Shipment	Transfer Shipment	With this permission, the user can dispatch shipments.
Edit Container	Transfer Shipment	<p>With this permission, the user will be allowed to edit the line item details, update qty, remove item, restore item, cancel the current edits, and so on.,</p> <p>User must also have Modify Container permission.</p> <p>Without this permission, the user will not be allowed to edit any line item details, update qty, remove item, restore item, cancel the current edits, and so on.</p>
Edit Container Attribute	Transfer Shipment	With this permission, extended attributes can be added/removed: Add Attributes and Remove Attributes (Trash can) buttons will be available on the Attributes tab of the Transfer Shipment Container - Item Detail screen.
Edit Container CFA	Transfer Shipment	With this permission, the user will be able to capture CFAs in the containers of transfer shipments.

Table 9–3 (Cont.) Security Permissions

Permission	Topic	Usage
Edit Container Info	Transfer Shipment	<p>With this permission, the user will be allowed to edit the container header details.</p> <p>User must also have Modify Container permission.</p>
Edit Quantity	Transfer Shipment	<p>With this permission, the user will be able to tap on the item quantity and the quantity widget will open to edit the quantity.</p> <p>User must also have Modify Container and Edit Container permission.</p> <p>Without this permission, the quantity is not editable via the manual dialog and only scanning is allowed.</p>
Edit Shipment BOL	Transfer Shipment	<p>With this permission, the user will be allowed to edit the shipment BOL details.</p>
Edit Shipment CFA	Transfer Shipment	<p>With this permission, the user will be able to capture CFAs in transfer shipments.</p>
Edit Shipment Info	Transfer Shipment	<p>With this permission, the user will be allowed to edit the shipment header details.</p>
Override Exclude Shipping Network	Transfer Shipment	<p>With this permission, user will be able to override Shipping Network exclusion and will be able to dispatch to the stores that are not in the network.</p>
Select Container Document	Transfer Shipment	<p>With this permission, the user will be allowed to select transfer documents to be added to the shipment.</p> <p>User must also have Modify Container and Edit Container permission.</p>
Submit Shipment	Transfer Shipment	<p>With this permission, the user can submit shipments.</p>
Create UIN on the Fly	UIN	<p>With this permission, the user is allowed to create a UIN on the fly when creating an inventory adjustment using a reason code of Disposition Movement from Out (Dist) to Available to Sell (ATS) = UIN Status in Stock.</p> <p>User must also have Edit Inventory Adjustment permission as well as data permissions for each adjustment reason on the adjustment.</p>

Operational Issues Screens

This chapter describes administration screens which users with System-Operator role, can view for operational issues.

The operational issues are divided into four categories.

Note: **Date search** range has been defaulted to last 14 days. Users can change the date range.

- [Bulk Data Import](#)

Scheduled background work tasks that handle importing mass data from external systems (through file or BDI). The issue counts the number of work tasks that failed.

Primary Tables: BATCH_EXECUTION, BATCH_ACTIVITY

- [Data Purge](#)

Scheduled background work tasks that archive and remove data from the database. The issue counts the number of work tasks that failed.

Primary Tables: BATCH_EXECUTION, BATCH_ACTIVITY

- [Message Processing](#)

Scheduled background work tasks that process asynchronous messages in a queue. The issue counts the number of messages that failed.

Primary Tables: MPS_STAGED_MESSAGE

- [Transactional Execution](#)

Scheduled background work tasks that execution business processes on transactional data. The issue counts the number of work tasks that failed.

Primary Tables: BATCH_EXECUTION, BATCH_ACTIVITY

Operational Issues List Screen

This screen displays the summary of operational issues for each category.

Figure 10–1 Operational Issues List Screen

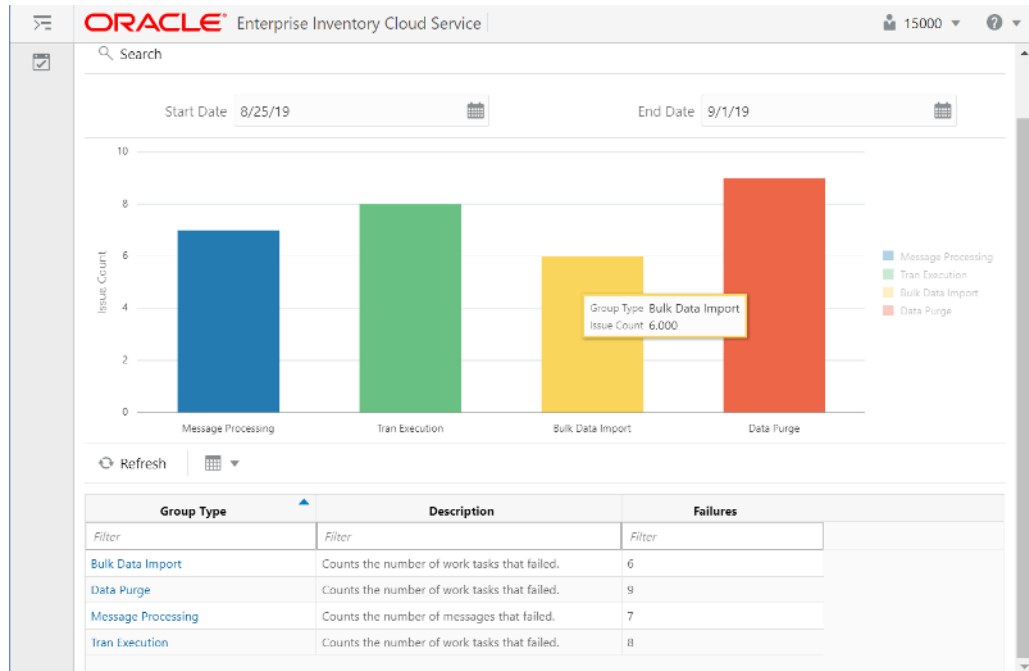

Note: On the bar graph, the **Issue Count** will be displayed when user moves the cursor to the bar graph

Operational Issues Review

This screen displays the operational issues for selected categories and date ranges. It provides following common actions in the operational issue review screens.

Operational Review Screen Actions

- **Search Filter**

Each Operational Review Screen has the Search filters.

The search filter fields would vary based on the operational groups.

The search filter fields are: search limit, date range.

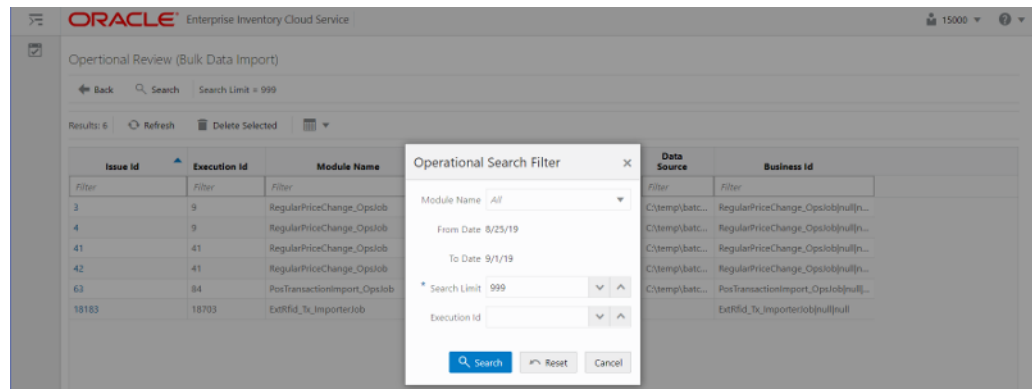
Figure 10–2 Search Filter

- **Issue Detail**

Click the Issue Link, the issue detail dialog will be displayed.

For example, the following screen shot displays the Bulk Data Import Issue Detail.

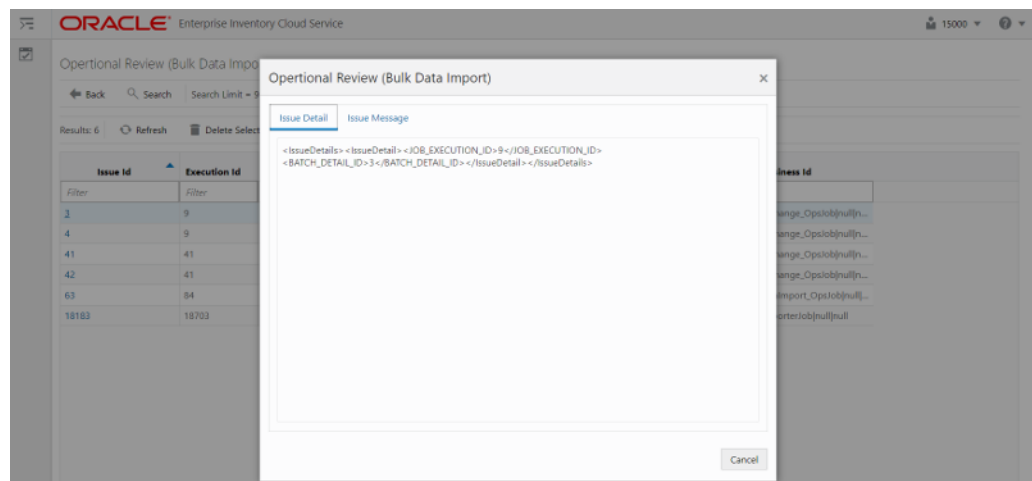
Figure 10–3 Issue Detail

- **Delete Button**

Mark the record as deleted, user needs to have **Batch Execution Delete** security permission to delete a record.

The following security permissions are required to perform delete actions.

Table 10–1 Security Permissions for Delete Actions

Operational Issue Category	Security Permissions
Bulk Data Import	Batch Execution Delete
Data Purge	Batch Execution Delete
Tran Execution	Batch Execution Delete
Message Processing	Delete MPS Staged Message

Bulk Data Import

This screen displays list of failed scheduled background work tasks that handle importing mass data from external system (through file or BDI).

Figure 10–4 Bulk Data Import Screen

Issue Id	Execution Id	Module Name	Create Date	Data Source	Business Id
3	9	RegularPriceChange_CpsJob	2019-08-26T17:32:37-05:00	C:\temp\batch\data\price-change\REG...	RegularPriceC...
4	9	RegularPriceChange_CpsJob	2019-08-26T17:32:37-05:00	C:\temp\batch\data\price-change\REG...	RegularPriceC...
41	41	RegularPriceChange_CpsJob	2019-08-26T17:32:37-05:00	C:\temp\batch\data\price-change\REG...	RegularPriceC...
42	41	RegularPriceChange_CpsJob	2019-08-26T17:32:37-05:00	C:\temp\batch\data\price-change\REG...	RegularPriceC...
63	64	PosTransactionImport_CpsJob	2019-08-26T17:32:37-05:00	C:\temp\batch\from-pos\SIMTLOG_052...	PosTransaction...
18183	18703	ExtRfd_Tx_ImporterJob	2019-08-26T17:32:37-05:00		ExtRfd_Tx_imp...

Data Purge

This screen displays a list of failed scheduled background work tasks that archive and remove data from the database.

Figure 10–5 Data Purge Screen

Issue Id	Execution Id	Module Name	Create Date	Data Source	Business Id
17787	18247	CompletedUln_PurgeJob	2019-08-26T17:32:37-05:00		CompletedUln_PurgeJob\null
17793	18253	TemporaryUln_PurgeJob	2019-08-26T17:32:37-05:00		TemporaryUln_PurgeJob\null
17794	18254	TemporaryUln_PurgeJob	2019-08-26T17:32:37-05:00		TemporaryUln_PurgeJob\null
17807	18267	TemporaryUln_PurgeJob	2019-08-26T17:32:37-05:00		TemporaryUln_PurgeJob\null
17808	18268	TemporaryUln_PurgeJob	2019-08-26T17:32:37-05:00		TemporaryUln_PurgeJob\null
17824	18284	TemporaryUln_PurgeJob	2019-08-26T17:32:37-05:00		TemporaryUln_PurgeJob\null
17825	18285	TemporaryUln_PurgeJob	2019-08-26T17:32:37-05:00		TemporaryUln_PurgeJob\null
17826	18286	TemporaryUln_PurgeJob	2019-08-26T17:32:37-05:00		TemporaryUln_PurgeJob\null
17827	18287	TemporaryUln_PurgeJob	2019-08-26T17:32:37-05:00		TemporaryUln_PurgeJob\null

Message Processing

This screen displays a list of failed background work tasks that process asynchronous messages in a queue.

Figure 10–6 Message Processing Screen

Issue Id	Execution Id	Module Name	Create Date	Data Source	Business Id
2	2	SlkCountSch	2019-08-18T06:12:35-05:00	SlkCountSch...	1
3	3	SlkCountSch	2019-08-18T06:12:35-05:00	SlkCountSch...	1
4	4	SlkCountSch	2019-08-18T06:12:35-05:00	SlkCountSch...	2
76772	76772	InvAdjust	2019-08-18T06:12:35-05:00	InvAdjustCre	SIM#76772
76773	76773	InvAdjust	2019-08-18T06:12:35-05:00	InvAdjustCre	SIM#76773

Transactional Execution

This screen displays a list scheduled background work tasks that execute business processes on transactional data.

Figure 10–7 Transactional Execution

Operational Review (Tran Execution)

Back Search Search Limit = 999

Results: 8 Refresh Delete Selected

Issue Id	Execution Id	Module Name	Create Date	Data Source	Business Id
Filter	Filter	Filter	Filter	Filter	Filter
17703	18123	GenerateUnitAmountStockCount_Opsl...	2019-08-26T17:32:37-05:00		GenerateUnitAmountStockCount...
17704	18123	GenerateUnitAmountStockCount_Opsl...	2019-08-26T17:32:37-05:00		GenerateUnitAmountStockCount...
17743	18183	GenerateUnitAmountStockCount_Opsl...	2019-08-26T17:32:37-05:00		GenerateUnitAmountStockCount...
18063	18543	GenerateUnitAmountStockCount_Opsl...	2019-08-26T17:32:37-05:00		GenerateUnitAmountStockCount...
18065	18546	GenerateUnitAmountStockCount_Opsl...	2019-08-26T17:32:37-05:00		GenerateUnitAmountStockCount...
18067	18549	GenerateUnitAmountStockCount_Opsl...	2019-08-26T17:32:37-05:00		GenerateUnitAmountStockCount...
18069	18552	GenerateUnitAmountStockCount_Opsl...	2019-08-26T17:32:37-05:00		GenerateUnitAmountStockCount...
18263	18783	GenerateUnitAmountStockCount_Opsl...	2019-08-26T17:32:37-05:00		GenerateUnitAmountStockCount...

Appendix: Run Importer Separately from SIOCS Job Admin

Run Data Seeding Importer Jobs

If you prefer import and load in separate processes, follow these steps:

1. EICS Disable Data Seed

Login Oracle Enterprise Inventory Cloud Service page as EICS System Ops user.

On Main Menu, Navigate to **Admin/Configuration/System Administration**.

Search for data seed on option field, change value and save the change.

Enabled Seed Foundation: set value to false

Enable Seed Store Data: set value to false

2. Start BDI Data Seeding Process Flow

Review process status.

3. Start EICS Data Seeding Importer Job

Once the BDI process flow is completed, you can load data from EICS inbound stage tables into the application tables.

To load stage data to application tables:

Login EICS as system ops user.

From Main Menu, navigate to **Admin/Technical Maintenance/Job Admin**.

Figure A–1 Job Admin

Execution ID	Job Name	Instance ID	Status	Start Time	End Time	User	Reviewed	Parameter
13045	Cleanup Shelf Replenishment Job	13045	Completed	10/15/18 1:03:51 AM	10/15/18 1:03:52 AM	<anonymous>	No	
13705	Cleanup Shelf Replenishment Job	13705	Completed	10/14/18 1:03:51 AM	10/14/18 1:03:52 AM	<anonymous>	No	
13581	Cleanup Shelf Replenishment Job	13581	Completed	10/13/18 1:03:51 AM	10/13/18 1:03:52 AM	<anonymous>	No	
13470	Cleanup Shelf Replenishment Job	13470	Completed	10/12/18 1:03:51 AM	10/12/18 1:03:52 AM	<anonymous>	No	
13355	Cleanup Shelf Replenishment Job	13355	Completed	10/11/18 1:03:51 AM	10/11/18 1:03:52 AM	<anonymous>	No	
13231	Cleanup Shelf Replenishment Job	13231	Completed	10/10/18 1:03:51 AM	10/10/18 1:03:52 AM	<anonymous>	No	
13105	Cleanup Shelf Replenishment Job	13105	Completed	10/9/18 1:03:51 AM	10/9/18 1:03:53 AM	<anonymous>	No	
13852	CleanupBatchDirectories_Opsjob	13852	Completed	10/15/18 1:03:52 AM	10/15/18 1:03:52 AM	<anonymous>	No	
13712	CleanupBatchDirectories_Opsjob	13712	Completed	10/14/18 1:03:53 AM	10/14/18 1:03:53 AM	<anonymous>	No	
13388	CleanupBatchDirectories_Opsjob	13388	Completed	10/13/18 1:03:52 AM	10/13/18 1:03:53 AM	<anonymous>	No	
13477	CleanupBatchDirectories_Opsjob	13477	Completed	10/12/18 1:03:53 AM	10/12/18 1:03:54 AM	<anonymous>	No	
13362	CleanupBatchDirectories_Opsjob	13362	Completed	10/11/18 1:03:53 AM	10/11/18 1:03:53 AM	<anonymous>	No	
13238	CleanupBatchDirectories_Opsjob	13238	Completed	10/10/18 1:03:53 AM	10/10/18 1:03:53 AM	<anonymous>	No	
13112	CleanupBatchDirectories_Opsjob	13112	Completed	10/9/18 1:03:52 AM	10/9/18 1:03:52 AM	<anonymous>	No	

On Job Admin Screen, click **Data Seed**. This will bring you to the Data Seed screen.

Figure A–2 Data Seed Screen

Select **Job Name** (for example Store). From Seed Option drop-down list, select **Seed**. Next, click **Start Job**.

Note: The store id input field is applicable to modules which contain store data.

To load all stores data, leave the store id as blank. To load data for a specific store, please enter the store id into the store Id field.

The Data Set Id is optional parameter for importer job to process the specified data set from bulk data interface table.

Review importer status in EICS Job Admin console.

Figure A–3 Importer Status

The screenshot shows the Oracle Enterprise Inventory Cloud Service Job Admin interface. The main content area displays a table of job execution records. The table has columns for Execution ID, Job Name, Instance ID, Status, Start Time, End Time, User, Reviewed, and Parameter. All jobs listed are in a 'Completed' status.

Execution ID	Job Name	Instance ID	Status	Start Time	End Time	User	Reviewed	Parameter
13845	Cleanup Shelf Replenishment Job	13845	Completed	10/15/18 1:03:51 AM	10/15/18 1:03:52 AM	<anonymous>	No	
13705	Cleanup Shelf Replenishment Job	13705	Completed	10/14/18 1:03:51 AM	10/14/18 1:03:52 AM	<anonymous>	No	
13581	Cleanup Shelf Replenishment Job	13581	Completed	10/13/18 1:03:51 AM	10/13/18 1:03:52 AM	<anonymous>	No	
13470	Cleanup Shelf Replenishment Job	13470	Completed	10/12/18 1:03:51 AM	10/12/18 1:03:52 AM	<anonymous>	No	
13355	Cleanup Shelf Replenishment Job	13355	Completed	10/11/18 1:03:51 AM	10/11/18 1:03:52 AM	<anonymous>	No	
13231	Cleanup Shelf Replenishment Job	13231	Completed	10/10/18 1:08:51 AM	10/10/18 1:08:52 AM	<anonymous>	No	
13105	Cleanup Shelf Replenishment Job	13105	Completed	10/9/18 1:03:51 AM	10/9/18 1:03:53 AM	<anonymous>	No	
13852	CleanupBatchDirectories_OpsJob	13852	Completed	10/15/18 1:03:52 AM	10/15/18 1:03:52 AM	<anonymous>	No	
13712	CleanupBatchDirectories_OpsJob	13712	Completed	10/14/18 1:03:53 AM	10/14/18 1:03:53 AM	<anonymous>	No	
13588	CleanupBatchDirectories_OpsJob	13588	Completed	10/13/18 1:03:52 AM	10/13/18 1:03:53 AM	<anonymous>	No	
13477	CleanupBatchDirectories_OpsJob	13477	Completed	10/12/18 1:03:53 AM	10/12/18 1:03:54 AM	<anonymous>	No	
13362	CleanupBatchDirectories_OpsJob	13362	Completed	10/11/18 1:03:53 AM	10/11/18 1:03:53 AM	<anonymous>	No	
13238	CleanupBatchDirectories_OpsJob	13238	Completed	10/10/18 1:08:53 AM	10/10/18 1:08:53 AM	<anonymous>	No	
13112	CleanupBatchDirectories_OpsJob	13112	Completed	10/9/18 1:03:52 AM	10/9/18 1:03:52 AM	<anonymous>	No	

BDI Transaction (TX) Importer Jobs

The following BDI Transaction Importer Jobs can be run as Ad hoc job if BDI process flowed failed on importer stage. The data set id is required. By default, the job schedules are setup in BDI job schedule admin console. The SIOCS/EICS job schedule for following importer jobs are disabled.

Table A–1 BDI Transaction (TX) Importer Jobs

Importer Job	Notes
Clearance Transaction Import	Clearance pricing data from producer system to receiver system. Run after initial data seed, recurring or as needed.
Price Change Transaction Import	Regular price change data from producer system to receiver system. Run after initial data seed, recurring or as needed.
Warehouse Avail Inventory Import	Current available inventory for items at warehouses from producer system to receiver system. Run after initial data seed, recurring or as needed.
Third Party Price Import	Item prices coming from an external pricing application to receiver system. Run after initial data seed, recurring or as needed.
Third Party RFID Import	RFID data coming from an external RFID application to receiver system. Run after initial data seed, recurring or as needed.

To Start an Adhoc Job, see [Batches](#) chapter [Start an Ad hoc Job](#) section for details.

Appendix: BDI Transmitter CLI Procedure - Load External Data File

Prerequisites

Following Server side installations must be installed by Oracle Retail Cloud Service Providers: EICS and BDI-SIM Edge App Job Admin.

Before you can load data files use BDI Transmitter CLI tool, you need install BDI Transmitter on Client machine. See following steps for installing BDI Transmitter CLI tools on Client side.

BDI Transmitter CLI Tool Setup

To prepare the tool for use, follow these steps.

- The bdi-cli-transmitter home directory (where the tool software package is extracted) contains 'conf' directory where the tool related configuration files will be present, and 'bin' directory where the executable to run the tool will be present.
- Configure conf/bdi-file-transmitter.properties. The following describes the properties to be configured. The properties file provides some sample values for reference to start with. The values specified in the properties file can be overridden using the command-line input options if required, when running the tool for file transmission.

Table B-1 *bdi-file-transmitter.properties*

Property	Description
source.system.name	The name of the source system or application that provides the source data to be transmitted. For example, <code>source.system.name=EXTERNAL</code>
<receiverAppName>.receiver.url	The Receiver REST service URL of the BDI Receiver application indicated by <receiverAppName> (should be in lower-case). When use BDI Transmitter CLI tool to integrate with EICS, need to set the <code>sim.receiver.url</code> . For example, if the BDI receiver application is SIM, then specify the property and value as: <code>sim.receiver.url=http://<bdi-sim-app-hostname>:<port>/sim-batch-job-admin/resources/receiver</code>

Table B-1 (Cont.) bdi-file-transmitter.properties

Property	Description
<receiverAppName>.receiver.url.useralias	Alias name for the credentials to be used to connect to the corresponding receiver service. The alias name with the credentials are stored in a wallet. <receiverAppName> should be in lowercase. Example: sim.receiver.url.useralias=simReceiverUrlUserAlias
<InterfaceModuleName>.receiver.appname	Name of the BDI receiver application for the interface module <InterfaceModuleName>. Specify the name in lowercase. Example: ExtPrice_Tx.receiver.appname=sim
<InterfaceModuleName>.dataset.type	The data set type of the data to be transmitted for the interface module identified by <InterfaceModuleName>. Valid value is FULL or PARTIAL. Example: ExtPrice_Tx.dataset.type=PARTIAL
<InterfaceModuleName>.interfaceShortNames	The interface name(s) for the corresponding interface module <InterfaceModuleName>. Multiple interface names can be specified (each separated by a comma) as multiple interfaces can be part of an interface module. The interface module name and interface names should be the same as expected by the BDI receiver application where the files are transmitted. Example: ExtPrice_Tx.interfaceShortNames=Ext_Price
<InterfaceModuleName>.<InterfaceShortName>.input.filepath	Specify the file location where the corresponding interface data files to be transmitted are present. Each interface in a interface module should have separate file locations. Example: ExtPrice_Tx.Ext_Price.input.filepath=/home/bdi/ext_price_tx/ext_price/files

Example B-1 bdi-file-transmitter.properties

```
source.system.name=ext-source

sim.receiver.url=https://<bdi-sim-app-hostname>:<port>/sim-batch-job-admin/resources/receiver

sim.receiver.url.useralias=simReceiverUrlUserAlias

interfaceModules=ExtPrice_Tx

ExtPrice_Tx.receiver.appname=sim

ExtPrice_Tx.dataset.type=PARTIAL

ExtPrice_Tx.interfaceShortNames=Ext_Price

ExtPrice_Tx.Ext_Price.input.filepath=/home/bdi/ext_price_tx/ext_price/files
```

- Run: `bdi-file-transmitter.sh -setup-credentials`.

Note: `bdi-file-transmitter.sh` will be in the 'bin' directory.

Run `-setup-credentials` to configure the BDI Receiver service user credentials. Running this command will prompt for the username and password for each of the `<receiverAppName>.receiver.url.useralias` specified in `bdi-file-transmitter.properties` file.

The credentials entered for each alias will be stored in a secure wallet and used to connect to the corresponding BDI Receiver service for transmission of files.

This is a prerequisite step to use the tool but usually a one-time setup before running `bdi-file-transmitter.sh` for transmission of files.

- Optionally, configure `conf/bdi-file-transmitter-runtime.properties` that contains parameters (described below) for performance tuning of the tool.

Start with default values as present in the properties file, analyze the performance and choose optimal values for the parameters for better performance if required. The tool will use default values for the parameters (mentioned below) when no values are specified in the properties file.

Property	Description
<code>multiple_files_process_limit</code>	The maximum number of files to process in parallel at any given time. Default value is 5.
<code>file_transmission_thread_limit</code>	The number of parallel threads to run to process a single file. Default value is 3.
<code>transmission_record_size</code>	The maximum number of records per block or chunk to transmit to the receiver service per service call. Default value is 20000.
<code>transmission_timeout</code>	The timeout in minutes for file transmission. The process will timeout and end when the file transmission is still not complete after the specified time. Default value is 300 minutes.

Tool Usage

The BDI CLI Transmitter tool is run using the shell script: `bdi-file-transmitter.sh` from the 'bin' directory.

The tool can be run in interactive and non-interactive modes.

- **Interactive Mode:** Run `bdi-file-transmitter.sh`

For user interactive mode where the program prompts for input, just run `bdi-file-transmitter.sh` with no options.

This will prompt for each input with descriptions which will be self-explanatory. The user can enter value as required or skip optional parameters. When no value is specified for optional parameters, the tool will try to use the default values as specified in the `bdi-file-transmitter.properties` file or stop executing when no default value is present.

- **Non-Interactive Mode:** Run `bdi-file-transmitter.sh [input]`

The tool can be run with the following inputs as described below.

Note: The only required input is interface module name, when the other input values are specified in bdi-file-transmitter.properties file.

Input	Description
-m or --interfacemodule <interfaceModuleName>	(Required) The interface module name. Should be the same as the interface module name expected by the BDI receiver application.

Some examples of running the transmitter tool command-line:

```
bdi-file-transmitter.sh -m ExtPrice_Tx
```

File Processing

The BDI Transmitter tool supports transmission of flat files, for example, .csv files, in UTF-8 format. The BDI Receiver application supports only csv files. Hence the interface data files to be transmitted need to contain records with comma-separated field values.

The order of the fields in the file should be as expected by the BDI Receiver application, so that each value is inserted in the right columns of the destination interface tables. No header line should be present in the file (each line is treated as data record). Each record should be in a new line.

The interface module name and interface names for the files to be transmitted should be same as expected by the BDI Receiver application.

The transmitter tool can process a single file or a directory containing multiple files. But the tool does not process files recursively in subdirectories.

Files are processed and transmitted per interface module. Each run of processing of files of the interface module will be considered a transaction and a Transaction Id will be generated and associated to the transmission of files (at the interface module level). Files of multiple interfaces in an interface module will be part of the same transaction.

Each file transmission within a transaction will have a Transmission Id associated to it. The same transaction Id and transmission Id are sent to the BDI Receiver application, so the corresponding transmission details can be seen in the Job Admin console of the BDI Receiver application.

After successful transmission, the file will be moved to the archive directory:

```
<inputFileDirectory>/archive/<interfaceModuleName>/<transactionId>
```

For example, if the input file location is '/home/bdi/interface/files' and the interface module of the files is 'ExtPrice_Tx', and the transaction Id of the file transmission is 'Tx#1475858081837', then after successful transmission the file will be moved to the directory:

```
/home/bdi/interface/files/archive/ExtPrice_Tx/Tx#1475858081837.
```

Output Logs

The transmitter tool outputs messages and logs to the terminal console where the command is run.

The tool also creates a log file that contains detailed logs about the processing of files. The log will show the Transaction Id and Transmission Id of each file transmission among other details.

The log file is created in the logs directory under the tool home directory (bdi-cli-transmitter/logs).

The name of the log file will be in the format: bdi-file-transmitter_YYYY-MM-DD_HH:MM:SS, for example bdi-file-transmitter_2016-07-04_10:38:59.

Error Reprocessing

In case of any error in file processing, error in transmission of file to the receiver service, timeout of file transmission, or any other failure, the file will be moved to the 'failed' directory: <inputFileDirectory>/failed/<interfaceModuleName>/<transactionId>

For example, if the input file location is '/home/bdi/interface/files' and the interface module of the files is 'ExtPrice_Tx', and the transaction Id of the file transmission is 'Tx#1475858081837', then if the transmission of file fails, the file will be moved to the directory: /home/bdi/interface/files/failed/ExtPrice_Tx/Tx#1475858081837.

A properties file containing the input details corresponding to the failed file will be created. For example, if the file named 'ExtPrice_1.csv' has failed, then a file named 'ExtPrice_Tx_1.csv.properties' will be created in the 'failed' directory. This acts as the input context that will be used when the file is reprocessed. The user should not delete or modify this properties file, if the data file has to be re-processed with the original input context.

Due to parallel processing of files by the transmitter, there may be a scenario where some records in the file may have been transmitted successfully, but part of the file transmission may have failed. Even in this case, the entire file will be treated as failed and moved to the 'failed' directory.

Reprocessing will be at the file level and not at the block level where the transmission may have failed. In the case of partial transmission of file, the BDI Receiver application also marks the whole transmission as failed and hence the entire file can be retransmitted to be processed again by the receiver application.

To retry failed files (that did not get transmitted successfully in previous transmission) use the below command:

```
bdi-file-transmitter.sh -retry-failed <inputFileDir or inputFilePath>
```

```
For example, bdi-file-transmitter.sh -retry-failed
/home/bdi/interface/files/failed/ExtPrice_Tx/Tx#1475858081837
```

```
bdi-file-transmitter.sh -retry-failed /home/bdi/interface/files/failed/ExtPrice_
Tx/Tx#1475858081837/ExtPrice_1.csv
```

Once a file is successfully reprocessed, it will be renamed as <filename>-retransmitted. For example, ExtPrice_1.csv-retransmitted. And the corresponding properties file will be deleted.

Schedule EICS Importer Jobs for Transmitter Loaded Data

1. Login in EICS and navigate to the Job Scheduler screen.
2. Select the desired job (for example, External Price TX Import or External RFID TX Import) from the list.
3. Edit the Job details on right panel.
4. Set required interval for execution and **Enabled** to **Yes**.
5. Click **Apply** to exit the edit mode.

6. For configuring multiple jobs on a go, repeat Step 2 for each job.
7. Click **Save** to save the current changes made on the screen.

View EICS Importer Jobs Execution Details

1. Launch EICS application, login EICS as System Ops user.
2. On Main Menu, select Admin/ Technical Maintenance/Job Admin.
3. To view detail record, select the record, then click hyperlink on the execution id. This will bring you to the Job Execution Detail screen.

Appendix: BDI Security Roles and Groups

[BDI Batch Admin Security](#)

[BDI Process Flow Security](#)

[BDI Scheduler Security](#)

BDI Batch Admin Security

The following list shows the available BDI Edge Job Security groups in IDCS or OCI IAM. The customer can create an IDCS or OCI IAM user and assign to the proper group based on job duties:

- BdiEdgeSimJobAdminGroup
- BdiEdgeSimJobMonitorGroup
- BdiEdgeSimJobOperatorGroup

Note: In stage environment, the preprod suffix is added to the groups.

Table C-1 BDI Batch Admin Role/Groups

Role Name	Admin Role	Operator Role	Monitor Role
Group Name	BdiJobAdminGroup	BdiJobOperatorGroup	BdiJobMonitorGroup
Edit configuration from UI	Yes	No	No
Create/update/delete system options	Yes	No	No
Create/update/delete system credentials	Yes	No	No
View credentials	Yes	No	No
Run Jobs	Yes	Yes	No
Monitor Jobs	Yes	Yes	Yes
HTTP GET method access to rest services	Yes	Yes	Yes
HTTP POST/PUT/DELETE method access to rest services	Yes	Restricted to few services.	No

BDI Process Flow Security

The following list shows the available BDI Process Flow Enterprise Security groups in IDCS or OCI IAM. The customer can create an IDCS or OCI IAM user and assign to the proper group based on job duties:

- BdiProcessAdminGroup
- BdiProcessOperatorGroup
- BdiProcessMonitorGroup

Note: In stage environment, the *_PREPROD suffix is added to the groups.

Table C-2 BDI Process Flow Security Roles/Groups

Role Name	Admin Role	Operator Role	Monitor Role
Group Name	BdiProcessAdminGroup	BdiProcessOperatorGroup	BdiProcessMonitorGroup
Update Process DSL	Yes	No	No
Start/Restart Process	Yes	Yes	No
All other services	Yes	Yes	No
Read only Access to Process Flow Live, Manage Process Flow, Historical Process Flow Executions, System Logs UI tabs.	Yes	Yes	Yes
HTTP GET method access to rest services	Yes	Yes	Yes
HTTP POST/PUT/DELETE method access to rest services	Yes	Restricted to few services.	No

BDI Scheduler Security

The following list shows the available BDI Scheduler Enterprise Security groups in IDCS or OCI IAM. The customer can create an IDCS or OCI IAM user and assign to the proper group based on job duties:

- BdiSchedulerAdminGroup
- BdiSchedulerOperatorGroup
- BdiSchedulerMonitorGroup

Note: In stage environment, the *_PREPROD suffix is added to the groups.

Table C-3 BDI Process Flow Security Roles/Groups

Role Name	Admin Role	Operator Role	Monitor Role
Group Name	BdiSchedulerAdminGroup	BdiSchedulerOperatorGroup	BdiSchedulerMonitorGroup
View and search	Yes	Yes	Yes
Create schedule	Yes	No	No
Edit schedule	Yes	No	No
Delete schedule	Yes	No	Yes
Manual run schedule	Yes	Yes	Yes
Disable schedule	Yes	Yes	No
Enable schedule	Yes	Yes	No
HTTP GET method access to rest services	Yes	Yes	Yes
HTTP POST/PUT/DELETE method access to rest services	Yes	Yes	No

Appendix: Report Formats

Reports

Table D-1 Reports

Report Name	Report Parameters
Customer Order Bin Label Report	bin_id, sim_customer_order_id, copies
Customer Order Delivery BOL Report	delivery_id, store_timezone, copies
Customer Order Delivery Report	delivery_id, store_timezone, copies
Customer Order Pick Discrepancy Report	store_timezone, pick_id, copies
Customer Order Pick Report	store_timezone, pick_id, copies
Customer Order Report	order_id, store_timezone, copies
Customer Order Reverse Pick Report	reverse_pick_id, store_timezone, copies
Direct Delivery Discrepant Items Report	receipt_id, store_timezone, copies
Direct Delivery Report	receipt_id, store_timezone, copies
Inventory Adjustment AGSN Report	Inv_Adjust_ID, copies
Inventory Adjustment Report	inv_adj_id, store_timezone, copies
Item Basket Report	Item_basket_id, store_timezone, copies
Item Detail Report	itemid, storeid, store_timezone, copies
Purchase Order Report	purchase_order_id, store_timezone, copies
Replenishment Gap Report	replenish_gap_id, copies, store_timezone, locale_id
RFID History Report	item_id, from_date, to_date, locale_id, copies
RTV Report	return_id, store_timezone, copies
Shelf Adjustment Report	shelf_adjust_id, copies, store_timezone
Shelf Replenishment Report	shelf_replenish_id, store_timezone, copies
Stock Count All Location Report	store_id, stock_count_id, copies
Stock Count Export Report [XML Format]	stock_count_id, copies
Stock Count Rejected Item Report	store_id, copies

Table D-1 (Cont.) Reports

Report Name	Report Parameters
Stock Count Report	stock_count_id, location_id, store_timezone, phase, copies
Store Order Report	store_order_id, store_timezone, locale_id
Transfer Delivery AGSN Report	carton_ID, copies
Transfer Delivery Exception Report	delivery_id
Transfer Delivery Label	carton_id
Transfer Delivery Report	delivery_id
Transfer Report	transfer_id, store_timezone, copies
Transfer Shipment BOL Report	shipment_id, store_timezone, copies
Transfer Shipment Carton Report	store_timezone, carton_id, copies
Transfer Shipment Report	shipment_id, copies, store_timezone
Transfer Shipping Label	carton_id
Vendor Delivery AGSN Report	carton_ID, copies
Vendor Delivery Label	carton_id, locale_id
Vendor Shipment BOL Report	store_timezone, ship_number, copies
Vendor Shipment Carton Report	store_timezone, carton_id, copies
Vendor Shipment Report	store_timezone, ship_number, copies
Vendor Shipment Label	carton_id, copies

Report Formats

The following section describes the report formats.

Figure D-1 Customer Order Bin Label Report

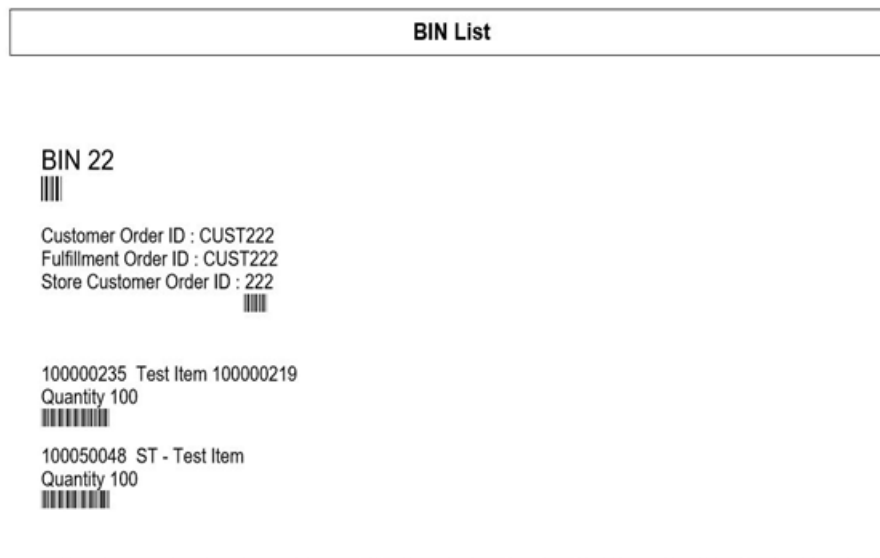

Figure D-2 Customer Order Delivery BOL Report

Customer Order Delivery BOL Report						
BOL ID:	1158	Create Date:	08/09/2017			
Delivery ID:	274					
Customer Order ID:	New					
Item	Description	Substitute	UOM	Qty	Price	Amount
SIM_107	SIM_107		EA	3	125	375
Delivery Charge					USD8.99	
Total Lines					1	
Legalsee Fine Print						
Comments						
CANCELLED						
Printed: 1/8/2018			Page Number: 1			

Figure D-3 Customer Order Delivery Report

Customer Order Delivery Report						
Customer Order Id:	New	Reservation Type:	Web Order	Release Date:	08/08/2017	
		Comments:	Testing the External Comments. Do they work?	Delivery Date:	08/09/2017	
Item	Description	UOM	Order Qty	Delivered Qty	Canceled Qty	Substitute
SIM_107	SIM_107	EA	3	3	0	
CANCELLED						
Printed: 1/4/2018			Page Number: 1			

Figure D-4 Customer Order Pick Discrepancy Report

Customer Order Pick Discrepancy Report

Store: 1511 - Phoenix Pick Create Date: 12/19/2017
 Pick ID: 1086 Pick Create User: QAADMIN
 Pick Status: In Progress

Item	Description	Store Customer Order ID	Bin ID	Fulfillment ID	UOM	Pack Size	Old Pick Qty	Adjusted Pick Qty
100005016	Signal booster	301	142	LG1	EA	1	2	0

Figure D-5 Customer Order Pick Report

Customer Order Pick Report

Store: 1111 - Charlotte * Pick Create Date: 12/19/2017
 Pick ID: 1087 Pick Create User: qaadmin
 Pick Status: New Pick Complete Date:
 Pick Complete User:

Item	Description	Store Customer Order ID	Bin ID	Fulfillment ID	UOM	Pack Size	Suggested Pick Qty	Actual Pick Qty	Substitute
100005016	Signal booster	1486		PERF_CUS_E XT1486	EA	1	10		

Figure D-6 Customer Order Report

Customer Order Report									
Store:	1111	Create Date:	2017-07-19T13:29:	Delivery Type:	Ship To Customer				
Store Customer Order Id:	404	Release Date:	22.000-07:00	Carrier:	Other				
Customer Order Id:	test1	Delivery Date:	2017-08-13T13:13:	Service:	Other				
Fulfillment Order Id:	test1		12.000-07:00						
			2017-08-13T13:13:						
			12.000-07:00	Allow Partial Delivery:	Yes				
Status:	Completed								
Reservation Type:	Web Order								
Comments:	Testing the External Comments. Do they work?								

Item	Description	UOM	Order Qty	Picked Qty	Delivered Qty	Canceled Qty	Last Update Date	Comments	Substitute
100005016	Signal booster	EA	20	20	20	0	2017-08-11T10:14:00.000-07:00	I'm testing the item comments.	

Printed: 1/4/2018 Page Number: 1

Figure D-7 Customer Order Reverse Pick Report

Customer Order Reverse Pick Report									
Store:	1511	Order Status:	In Progress						
Reverse Pick ID:	501	Reverse Pick Status:	Canceled						
Store Customer Order ID:	63	Reservation Type:	Web Order	Comments:	Testing the External Comments. Do they work?				
Customer Order ID:	CC2	Reverse Pick Create Date:	2017-06-29T11:16:48.000-07:00						
Fulfillment Order ID:	CC2								

Item	Description	UOM	Order Qty	Picked Qty	Delivered Qty	Canceled Qty	Sugg. Reverse Qty	Qty	Substitute
100005013	Induction Test Item	EA	1	1	0	0	0	0	

Printed: 1/4/2018 Page Number: 1

Figure D-8 Direct Delivery Discrepant Items Report

Direct Delivery Discrepant Items Report
--

Supplier: 6100 - Local Grocery Supplier #2
Store: 1141 - Nashville
Delivery/ASN: DQ3
PO Number: 23456 ;

Container ID: 220						
Status: Received						
Item	Description	UOM	Pack Size	Expected	Quantity	Disposition
100350059	ncg item	LB	1	7	2	Damaged
100350059	ncg item	LB	1	7	2	Damaged
Totals:				14.00	4.00	

Driver Signature:

Employee Signature:

Figure D-9 Direct Delivery Report

Direct Delivery Report

Receipt ID: 4285
Receipt Date: 05/07/2020
Supplier: 6100 - Local Grocery Supplier #2
Store: 1141 - Nashville
Delivery/ASN: ASN12
PO Number: PO12
Status: Received
Invoice: 56
Invoice Date: 05/07/2020
Notes:

Container ID: 3785							
Container Status: Received							
Item	Description	UOM	Pack Size	Expected	Received	Damaged	Unit Cost
100000059	Washing Machine	EA	10	2	8	0	10 USD
Totals				2.00	8.00	0.00	

Driver Signature:

Employee Signature:

Figure D-10 Inventory Adjustment AGSN Report

AGSN Label Report

SKU : 100000059
AGSN : 101
■■■

SKU : 100000059
AGSN : 102
■■■

SKU : 100000059
AGSN : 103
■■■

SKU : 100000059
AGSN : 104
■■■

SKU : 100000059
AGSN : 105
■■■

Figure D-11 Inventory Adjustment Report

Inventory Adjustment Report

Store: 1141
Adjustment Id: 1081
Create Date: 08/03/2017
Create User: QA_005
Approval Date:
Approval User:
Status: In Progress
Comment:

Item	Description	UOM	Pack Size	Qty	Reason	Sub-Bucket
100000008	Test Item 100000008	Cases	10	10	Stock Count In	

Printed: 1/4/2018

Page Number: 1

Figure D-12 Item Basket Report

Item Basket Report

Basket ID: 361
Alternate ID: 321
Basket Description: Basket
Basket Type: ^{AA}Gift Registry^{AA}

Figure D-13 Item Detail Report

Item Report			
Item	SIM_800	Item Description	SIM_800
Primary UPC		Primary Supplier Name	Fine Jewelry Supplier
VPN		Primary Supplier Number	1300
Item Status	Active	Ticket Type	
			Ranged Yes
			Merchandise Hierarchy
			Dept dept5600
			Class class5601
			Subclass subclass5602
			Differentiators:
Stock on Hand Units:		Ordering Attributes:	
Total Stock on Hand	0	Repl Method	
Pack Size		Reject Store Order	No
Available SOH	0	Next Delivery Date	null
Shop Floor			
Back Room	0		
Unavailable	0		
Transfer Reserved	0		
RTV Reserved	0		
Ordered Quantity	0		
Delivery Bay	0		
In Transit	0		
Received Today	0		
			Pricing:
			Current Retail USD100
			Pricing Status Permanent
			Promotional Type
Allocations:			
Sequencing:			

Figure D-14 Purchase Order Report

Purchase Order Report

PO Id: 5681
Not Before Date: 03/12/2021
Not After Date: 03/15/2021
Supplier: 6200 - Local Grocery Supplier #3
PO Number: PORE1
To Location: 1141 - Nashville
Status: Completed
Complete Date: 03/12/2021

Receipt Id	Delivery/ASN Id	Receipt Date	Receipt Status
5703	ASNre69	03/12/2021	Received
5704	ASNre70	03/12/2021	Received
5705	ASNre71	03/12/2021	Received
5706	ASNre72	03/12/2021	Received
5702	ASNre68	03/12/2021	Received

Item	Description	UOM	Pack Size	Expected	Received	Unit Cost
100000024	Mouse	Cases	1	2	2	10 USD
100000059	Washing Machine	Cases	1	2	2	10 USD
100000083	Test Item 100000067	Cases	1	2	2	10 USD
100000112	Test Item 100000091	Cases	1	2	2	10 USD
Totals:				8.00	8.00	

Figure D-15 Replenishment Gap Report**Scan List Report**

Store: 1511 - Phoenix
ID:
Type: Gap
Create Date/Time: 05/10/2017
Update Date/Time: 05/16/2017
User:
Status: Completed

SKU	Description	UOM	Pack Size	Qty
10000032	Test Item 10000032	Cases	10	1
100005016	Signal booster	Cases	1	1
100005017	Induction Test Item	Cases	1	1
SIM_125	SIM_125	Cases	1	1
SIM_400	SIM_400	Cases	1	3

Printed: 1/2/2018

Page Number: 1

Figure D-16 RFID History Report

RFID History Report

Item 100050056 - ST - Test Item

Date: 08/14/2019
EPC: EPC95278

Zone	Location	Transaction Type	Transaction ID	Observed
	Store 1311	POS Sale	1462	No

Date: 08/14/2019
EPC: 854126

Zone	Location	Transaction Type	Transaction ID	Observed
61	Store 1311	RFID	761	Yes

Date: 08/14/2019
EPC: 980403

Zone	Location	Transaction Type	Transaction ID	Observed
404	2	RFID	762	Yes

Figure D-17 RTV Report

RTV Report

RTV Number: 1584
 External ID: 1
 Authorization Number: RTVREG1
 Status: Canceled Request
 User: EXTERNAL
 Not After Date: 11/25/2017
 Approved Date: 11/23/2017
 Supplier: 1200
 Total SKUs: 2
 Return Type:

Item	Description	UOM	Pack Size	Reason Code	Req Qty	App Qty	Rem Qty	In-Ship Qty	Shipped Qty
SIM_125	SIM_125	Cases	1	Externally Initiated	2	2	2	0	
SIM_126	SIM_126 Short Desc	EA	1	Overstock	2				

Figure D-18 Shelf Adjustment Report

Shelf Adjustment List Report

Store: 1511 - Phoenix
ID: 623
Type: Move To Backroom
Create Date/Time: 2017-12-14T09:03:37.000-08:00
Update Date/Time: 2017-12-14T09:05:00.000-08:00
User: qa_004
Status: In Progress

SKU	Description	UOM	Pack Size	Qty
SIM_125	SIM_125	Cases	1	1
SIM_126	SIM_126 Short Desc	Cases	1	1

Printed: 1/2/2018

Page Number: 1

Figure D-19 Shelf Replenishment Report

Shelf Replenishment Report

Store: 1511 - Phoenix
ID: 1001
Shelf Replenishment Type: Capacity
Replenishment mode: End of Day
Product Group: SIM 125 126 140
Hierarchy:
Scan List:
Create Date/Time: 09/11/2017
User: qa_004
Status: Canceled
Quantity: 181

Item Id	Item Description	Pick From Area	Type	Selling Unit Of Measure	Pack Size	Qty	Actual Qty
SIM_125	Mobile Signal booster	Backroom	Capacity		1	100	
SIM_126	Wifi booster	Backroom	Capacity		1	81	
SIM_143	SIM_143	Backroom	Capacity		1	81	1
SIM_144	SIM_144	Backroom	Capacity		1	81	0

Figure D-20 Stock Count All Location Report

All Location Stock Count Report
--

Description: 125126 140
 Date: 10/22/2017
 Total Items: 1
 Stock Count User:
 Re-Count User:
 Authorization User:

Item	Item Description	Location	UOM	Count
SIM_140	SIM_140	No Location	EA	

Description: 125126 140
 Date: 10/22/2017
 Total Items: 2
 Stock Count User:
 Re-Count User:
 Authorization User:

Item	Item Description	Location	UOM	Count
SIM_125	SIM_125	Back Room1	LB	
SIM_126	SIM_126 Short Desc	Back Room1	EA	

Description: 125126 140
 Date: 10/22/2017
 Total Items: 2
 Stock Count User:
 Re-Count User:
 Authorization User:

Item	Item Description	Location	UOM	Count
SIM_125	SIM_125	Shop Floor1	LB	
SIM_126	SIM_126 Short Desc	Shop Floor1	EA	

Private and Confidential

Figure D–21 Stock Count Export Report [XML Format]

```

<STOCK_COUNT_EXPORT>
  <STOCK_COUNT>
    <COUNT_ID>662</COUNT_ID>
    <STORE_ID>1511</STORE_ID>
    <DESCRIPTION>125126 140</DESCRIPTION>
    <LIST_STOCK_COUNT_LINE_ITEM>

      <STOCK_COUNT_LINE_ITEM>
        <ITEM_ID>SIM_126</ITEM_ID>
        <ITEM_DESC>SIM_126 Short Desc</ITEM_DESC>
        <ITEM_SNAPSHOT></ITEM_SNAPSHOT>
        <LIST_UINS>
          <UINS>

            <UIN/>
          </UINS>
        </LIST_UINS>
      </STOCK_COUNT_LINE_ITEM>
      <STOCK_COUNT_LINE_ITEM>
        <ITEM_ID>SIM_125</ITEM_ID>
        <ITEM_DESC>SIM_125</ITEM_DESC>
        <ITEM_SNAPSHOT></ITEM_SNAPSHOT>
        <LIST_UINS>
          <UINS>

            <UIN/>
          </UINS>
        </LIST_UINS>
      </STOCK_COUNT_LINE_ITEM>
      <STOCK_COUNT_LINE_ITEM>
        <ITEM_ID>SIM_140</ITEM_ID>
        <ITEM_DESC>SIM_140</ITEM_DESC>
        <ITEM_SNAPSHOT></ITEM_SNAPSHOT>
        <LIST_UINS>
          <UINS>

            <UIN/>
          </UINS>
        </LIST_UINS>
      </STOCK_COUNT_LINE_ITEM>

    </LIST_STOCK_COUNT_LINE_ITEM>
  </STOCK_COUNT>
</STOCK_COUNT_EXPORT>

```

Figure D-22 Stock Count Rejected Item Report

Rejected Items Report

Stock Count Description: Nithin Stk Cnt
 Stock Count Group: 41
 Schedule Date: 1/8/14
 Total Rejected Items: 1

SIM Item Id	Item Description	Rejected Item ID	Rejected UIN	Count Quantity	Count Location	Status	Comments
		100177107		1		Item Rejected	

Stock Count Description: TEST Schedule
 Stock Count Group: 141
 Schedule Date: 11/1/13
 Total Rejected Items: 5

SIM Item Id	Item Description	Rejected Item ID	Rejected UIN	Count Quantity	Count Location	Status	Comments
		100000657		2		Item Not On Count	
		100006021		2		Item Not On Count	
		1000006021		1		Item Rejected	

Private and Confidential

Figure D–23 Stock Count Report

Stock Count Report

Stock Count ID: 221
Stock Count Child ID: 2768
Description: Ish_Unit_ORSIM-22925_s6_sch1 :
 Shellfish#1
Date: 9/17/2021
Total Items: 1
Stock Count User: sim_qa7
Re-Count User:
Notes:

Item	Description	UOM	Counted
890790890	Ish_RegItem_1	EA	10

Figure D–24 Store Order Report

Store Order Report

Store ID: 1411 - Seattle*	Requested Date: 11/22/2020	Restrictions:
ID: 1	Create Date: 06/23/2020	Supplier: -
Reference ID: 4	Approved Date:	Warehouse: -
External ID: EXT1	Auto Approval Date:	Department: -
		Class: -
Description: Report Testing	Created User: sim_qa1	Sub-Class: -
Status: In Progress	Approved User:	Area: -
Context: Customer Orders		Store Order Items: Yes
Origin: External	Total Quantity: 168	

Custom Flexible Attributes
 CFA Alpha : 2
 CFA Sue 10 : 2020-10-02T00:00:00.000-04:00
 Attr1 : 23
 Attr2 : 2020-09-10T12:41:32.000-04:00

Item	Description	UOM	External Quantity	Quantity
100000294	Test Item 100000278	Units	300	9
100000147	Toned milk	Units	3	150
100000083	Test Item 100000067	Units	3	9

Figure D-25 Transfer Delivery AGSN Report









AGSN Label Report		
SKU : 10000059 AGSN : 1906 		
SKU : 10000059 AGSN : 1907 		
SKU : 10000059 AGSN : 1908 		
SKU : 10000059 AGSN : 1909 		
SKU : 10000059 AGSN : 1910 		
SKU : 10000059 AGSN : 1911 		
SKU : 10000059 AGSN : 1912 		
SKU : 10000059 AGSN : 1913 		
SKU : 10000059 AGSN : 1914 		
<table border="1" style="width: 100%; border-collapse: collapse;"> <tr> <td style="width: 50%;">Printed: 10/3/2018</td> <td style="width: 50%;">Page Number: 1</td> </tr> </table>	Printed: 10/3/2018	Page Number: 1
Printed: 10/3/2018	Page Number: 1	

Figure D-26 Transfer Delivery Exception Report

Transfer Receiving Exception Report									
Source:		1311 - Chicago*							
Destination:		1321 - Indianapolis							
Source Type:		Store							
Delivery/ASN:		546							
Status:		New							
Expected Date:		06/28/2017							
Container ID : 000132132011									
Status: New									
Item	Description	UOM	Pack Size	Expected	Received	Damaged	Difference		
SIM_3	SIM_3	Cases	1	1	0	0	1		
<table border="1" style="width: 100%; border-collapse: collapse;"> <tr> <td style="width: 50%;">Printed: 1/3/2018</td> <td style="width: 50%;">Page Number: 1</td> </tr> </table>								Printed: 1/3/2018	Page Number: 1
Printed: 1/3/2018	Page Number: 1								

Figure D-27 Transfer Delivery Label

From Chicago* 123 Street Anytown Anycity MN 50250 US	To Indianapolis 123 Street Anytown Anycity MN 50250 US
(420) 50250 	Label Type TRNSFR
Label Reason : Reprint Reference Container Id : Number Of Items : 1	Dept #S 5555
Store (01) 1321 	Store 1321
SSCC -18  000132132011	

Figure D-28 Transfer Delivery Report

Transfer Receiving Report							
Transfer Receipt ID:	3766						
Source:	1151 - Dallas						
Destination:	1141 - Nashville						
Source Type:	Store						
Delivery/ASN:	7744						
Status:	Received						
Expected Date:	11/09/2020						
Received Date:	03/12/2021						
Notes:							
Container ID : 000000011410334061							
Status: Received							
Item	Description	UOM	Pack Size	Expected	Received	Damaged	Out of Stock
100000024	Mouse	EA	10	1	0	0	
45678912345601	Sue GS1 Item	Cases	1	1	2	0	Yes

Figure D-29 Transfer Report

Transfer Report								
Transfer ID:	8827							
External ID:	76							
No of Items:	4							
Not After Date:	26-DEC-21			Approved Date:	15-MAR-21			
Unavailable:	Yes			Partial Delivery:	Yes			
Customer Order Id:	AO20			Fulfillment Order Id:	AO20			
Context Type:	Promotion			Context Value:	124			
Source Type:	Store			Destination Type:	Store			
Source:	1151 - Dallas			Destination:	1141 - Nashville			
Transfer Receipt ID	ASN	Delivery Status	Expected Date	Received Date	Shipment ID	Ship Date	Shipment Status	
4006	8265	Received	03/15/2021	03/15/2021	8265	03/15/2021	Shipped	
4004	8263	Received	03/15/2021	03/18/2021	8263	03/15/2021	Shipped	
4005	8264	New	03/15/2021		8264	03/15/2021	Shipped	
Item	Description	UOM	Requested	Approved	In-Shipping	Shipped	Received	Damaged
100000083	Test Item 100000067	Cases	1	1	0	1	1	0
100000059	Washing Machine	Cases	1	1	0	1		
100000024	Mouse	Cases	1	1	0	1	1	0
100000112	Test Item 100000091	Cases	1	1	0	1		

Figure D-30 Transfer Shipment BOL Report

Transfer Shipment BOL Report			
ASN: 561		Barcode: ■■■■	
BOL ID: 723		Shipment ID: 561	Motive: Bill of Lading Transfer New
Create Date: 2017-06-29		Create User: qa_007	
Sender 3111 - Montreal* 123 Street Anytown Anycity MN 50250 US		Receiver 3112 - Quebec 123 Street Anytown Anycity MN 50250 US	
Ship From 123 Street Anytown Anycity , MN 50250 US		Ship To Quebec 123 Street Anytown Anycity, MN 50250 US 3122222473	
Carrier Requested Pick-Up Date: ◇ Sender ◇ Receiver ◇ Third Party Carrier Name: Parcel Test Carrier Signature: Dispatch Date: Carrier Address:			
Service: Parcel Test		Tax ID :	
<u>Container ID</u>	<u>Weight (LBS)</u>	<u>Package Type</u>	<u>Tracking ID</u>
11	11.00		
Notes			

Ship Container No: 11

Barcode: ■■■■

Item ID	EAN	Description	UOM	Quantity
100300166		100300166	Cases	1.00

Legalese fine print

Driver signature	Date	Receiver signature	Date
------------------	------	--------------------	------

Figure D-31 Transfer Shipment Carton Report

Transfer Shipment Container Report

Source: 1511 - Phoenix
Destination: 1411 - Seattle*
Destination Type: Store
Ship Date:
Shipment ID: 909
Authorization Number:
Status: In Progress
User:
Container: 950
Container Status: In Progress

Document: 1506					
Item	Description	UOM	Pack Size	Ship Qty	Reason Code
SIM_125	SIM_125	Cases	1	1	
SIM_1	SIM_1	Cases	1	1	

Printed: 1/3/2018 Page Number: 1

Figure D-32 Transfer Shipment Report

Transfer Shipment Report

Source: 1151 - Dallas
Destination: 1141 - Nashville
Destination Type: Store
Ship Date: 03/16/2021
Shipment ID: 8283
Authorization Number:
Status: Shipped
User: sim_qa5

Container ID : 7643						
Container Status: Shipped						
Item	Description	UOM	Document	Pack Size	Ship Quantity	Reason Code
100000024	Mouse	EA	8843	10	1	
100000059	Washing Machine	EA	8843	10	1	

Figure D-33 Transfer Shipping Label



From Phoenix 123 Street Anytown Anycity MN 50250 US	To Seattle*
(420) Ship To Postal Code (420)50250 	Label Type Bill of Lading Transfer
Customer Order: No Number Of Items: 2 Context Value:	Dept #S 5555
Store (01)1411 	Store 1411
SSCC -18 000141155106 	

Figure D-34 Vendor Delivery AGSN Report

AGSN Label Report	
SKU : 10000083 AGSN : 2353 ■■■■	
SKU : 10000083 AGSN : 2354 ■■■■	
SKU : 10000083 AGSN : 2355 ■■■■	
SKU : 10000083 AGSN : 2356 ■■■■	
SKU : 10000083 AGSN : 2357 ■■■■	
SKU : 10000083 AGSN : 2358 ■■■■	
SKU : 10000083 AGSN : 2359 ■■■■	
SKU : 10000083 AGSN : 2360 ■■■■	
SKU : 10000083 AGSN : 2361 ■■■■	
Printed: 10/3/2018	Page Number: 1

Figure D-35 Vendor Delivery Label

From Local Grocery Supplier #2 123 Main St Portland OR 83273 US	To Nashville 123 Street 123 Street Anycity MN 50250 US
(420) 50250 	Label Type DSD
Label Reason: Reprint Reference Container Id: REF123 Number Of Items: 3	Dept #S 1117
Store (01) 1141 	Store 1141
SSCC -18  DQ10	

Figure D-36 Vendor Shipment BOL Report



RTV Shipment BOL Report				
RTV: 1142		Barcode: 		
BOL ID: 1355		Shipment: 1130		Motive: RTV
Create Date: 08/24/2017		Create User: qa_004		
Sender 1511 - Phoenix 123 Street Anytown Anycity MN 50250 US		Receiver 1200 - Fashion Importer (Euro) gggg gggg ggg MN 89 US		
Ship From Phoenix 123 Street Anytown Anycity MN 50250 US		Ship To Fashion Importer (Euro) gggg gggg ggg MN 89 US Phone:		
Carrier ?Sender ?Receiver ?Third Party Carrier Name: Carrier Address:		Requested Pick-Up Date Carrier Signature: Dispatch Date:		
Service:		Tax ID:		
<u>Container ID</u>	<u>Weight (UOM)</u>	<u>Package Type</u>	<u>Tracking ID</u>	
000120054129				
Legalese fine print				
Notes				
Ship Container No: 000120054129		Barcode : 		
<u>EAN</u>	<u>Item</u>	<u>Description</u>	<u>UOM</u>	<u>Quantity</u>
	SIM_13	SIM_13	Cases	2
Driver signature		Date	Receiver Signature	

Figure D-37 Vendor Shipment Carton Report

RTV Shipment Container Report

Source: 1511 - Phoenix
Supplier: 1200 - Fashion Importer (Euro)
Ship Date:
Shipment Number: 1130
Authorization Number: 987878
Status: In Progress
User:
Not After Date: 08/23/2017
Container: 000120054129
Container Status: In Progress

Item	Description	UOM	Pack Size	Ship Qty	Reason Code
SIM_13	SIM_13	Cases	1	2	Overstock





Figure D-38 Vendor Shipment Report

RTV Shipment Report

Source: 1511 - Phoenix
Supplier: 1200 - Fashion Importer (Euro)
Ship Date:
Shipment Number: 1130
RTV Type:
Authorization Number: 987878
Status: In Progress
User:

Container ID: 000120054129		Status: In Progress			
Item	Description	UOM	Pack Size	Ship Qty	Reason Code
SIM_13	SIM_13	Cases	1	2	Overstock

Figure D-39 Vendor Shipment Label

From Phoenix 123 Street Anytown Anycity MN 50250 US	To Fashion Importer (Euro) gggg gggg MN 89 US
(420) Ship To Postal Code (420)89 	Label Type Return To Vendor
Return ID 8789 	
 (01)1200 	 1200
SSCC -18 000120058020 	

Appendix: Batch File Layout Specifications

This chapter describes the batch file layout specification.

Third Party Stock Count Parser Import File Layout Specification

Filename Format

<file prefix>_<date in YYYYMMDDHH24MISS format>_<loc id>.dat

Where file prefix value is STK and loc id is the store identifier. This allows file to be unique for every upload.

For each file, there need to be a .complete file present to job to process the file. The complete file can be any empty. This is to notify the job that uploading of data file is completed.

Example:

STK_20180129133250_1111.dat - Data File.

STK_20180129133250_1111.dat.complete - Complete File.

Zip Filename Format

<file prefix>_<date in YYYYMMDDHH24MISS format>.zip

Where file prefix value is STK. The zip file can contain one or more files from same or different stores. The complete file needs to be added for zip file for job to pick it for processing.

Example:

STK_20180129133250.zip - Zip File.

STK_20180129133250.zip.complete - Complete File.

Third Party Stock Count Import File Format

Pipe-delimited (|) file contains store count data for a store and stock count ID as shown in [Table E-1](#):

File Layout

Table E-1 Third Party Stock Count Import File

Record Name	Field Name	Field Type	Default Value	Description
FHEAD	Record Descriptor	Char(5)	FHEAD	File head marker
	Store Number	Char(10)		Store number file was uploaded for. It is assumed only one store is passed in per file. (Required)
	Stock Count ID	Number(12)		Unique identifier for item. Assumption is application will always take first stock count ID listed. (Required)
FDETL	Record Descriptor	Char(5)	FDETL	Detail record marker.
	Stock Count Date	Date(14)		Indicates date/time item was physically counted by the third party. (YYYYMMDDHH24MISS) For example, 20180129134600 (Required) Note: If not using timestamp, use 00 for time.
	Area Number	Char(10)		10-digit code indicating where in the store the item is located. (Optional)
	UPC or Item Number	Char(25)		25-digit universal product code. (Required)
	Count Quantity	Number(12,4)		Quantity counted for item, required. This field must allow for decimals when counting in UOM other than each. (Required)
	UIN(Item Serial Number)	Char(128)		Unique identification serial number for item, required if current item requires serial number.
FTAIL	Record Descriptor	Char(5)	FTAIL	File tail marker.

The following is a sample Third Party Stock Count Import File:

```
FHEAD|5000|1074|
FDETL|20180129235959|1|100665085|1|ItemSerialNum1234|
FDETL|20180129140000|1|100665085|1|ItemSerialNum9999|
FDETL|20180129000000|1|100665085|1||
FTAIL|
```

Clearance Price Change Import File Layout Specification

Filename Format

<event type>_<date in YYYYMMDDHH24MISS format>_<loc id>_<loc type>.dat

Where event type value is "CLRPC" (clearances), the loc type field would be either 'S' or 'W'.

For each file, there need to be a .complete file present to job to process the file. The complete file can be any empty. This is to notify the job that uploading of data file is completed.

Example:

CLRPC_20180129133250_1111_S.dat - Data File.

CLRPC_20180129133250_1111_S.dat.complete - Complete File.

Zip Filename Format

<event type>_<date in YYYYMMDDHH24MISS format>_<loc type>.zip

Where event type value is "CLRPC". The loc type field would be either 'S' or 'W'.

The zip file can contain one or more files from same or different stores. The complete file needs to be added for zip file for job to pick it for processing.

Example:

CLRPC_20180129133250_S.zip - Zip File.

CLRPC_20180129133250_S.zip.complete - Complete File.

File Record Types

- FHEAD (required): File identification, one line per file.
- FDETL (optional): Price Change Event (Create or Modify).
- FDELE (optional): Price Change Event (Delete).
- FTAIL (required): End of file marker, one line per file.

File Layout

Table E-2 Clearance Price Change File Layout

Record Name	Field Name	Field Type	Default Value	Description
FHEAD	Record Descriptor	Char(5)	FHEAD	File head marker
FHEAD	Line ID	Number(10)	1	Unique line ID
FHEAD	File Type	Char(5)	CLRPC	Clearance Price Changes
FHEAD	Export timestamp	Timestamp		System clock timestamp (YYYYMMDDHHMISS)
FHEAD	Location	Number(10)		Location identifier
FHEAD	Location Type	Char(1)		S = Store, W = Warehouse
FDETL	Record Descriptor	Char(5)	FDETL	File Detail Marker (one per clearance create or modify)
FDETL	Line ID	Number(10)		Unique line ID
FDETL	Event Type	Char(3)		CRE = Create MOD = Modify

Table E-2 (Cont.) Clearance Price Change File Layout

Record Name	Field Name	Field Type	Default Value	Description
FDETL	ID	Number(15)		Clearance identifier
FDETL	Item	Char(25)		Item identifier
FDETL	Effective Date	Date		Clearance Effective Date (YYMMDDHHMISS)
FDETL	Selling Retail	Number(20,4)		Selling retail with price change applied
FDETL	Selling Retail UOM	Char(4)		Selling retail unit of measure
FDETL	Selling Retail Currency	Char(3)		Selling retail currency
FDETL	Reset Clearance ID	Number(15)		ID of clearance reset
FDELE	Record Descriptor	Char(5)	FDELE	File Detail Delete Marker (one per clearance delete)
FDELE	Line ID	Number(10)		Unique line ID
FDELE	ID	Number(15)		Clearance identifier
FDELE	Item	Char(25)		Item identifier
FTAIL	Record Descriptor	Char(5)	FTAIL	File tail marker
FTAIL	Line ID	Number(10)		Unique line ID
FTAIL	Number of lines	Number(10)		Number of lines in file not counting FHEAD and FTAIL

Regular Price Change Import File Layout Specification

Filename Format

<event type>_<date in YYYYMMDDHH24MISS format>_<loc id>_<loc type>.dat

Where event type is "REGPC" (regular price changes). The loc type field would be either 'S' or 'W'.

For each file, there need to be a .complete file present to job to process the file. The complete file can be any empty. This is to notify the job that uploading of data file is completed.

Example:

REGPC_20180129133250_1111_S.dat - Data File.

REGPC_20180129133250_1111_S.dat.complete - Complete File.

Zip Filename Format

<event type>_<date in YYYYMMDDHH24MISS format>_<loc type>.zip

Where event type value is "REGPC". The loc type field would be either 'S' or 'W'.

The zip file can contain one or more files from same or different stores. The complete file needs to be added for zip file for job to pick it for processing.

Example:

REGPC_20180129133250_S.zip - Zip File.

REGPC_20180129133250_S.zip.complete - Complete File.

File Record Types

- FHEAD (required): File identification, one line per file.
- FDETL (optional): Price Change Event (Create or Modify).
- FDELE (optional): Price Change Event (Delete).
- FTAIL (required): End of file marker, one line per file.

File Layout

Table E-3 Regular Price Change File Layout

Record Name	Field Name	Field Type	Default Value	Description
FHEAD	Record Descriptor	Char(5)	FHEAD	File head marker
FHEAD	Line ID	Number(10)	1	Unique line ID
FHEAD	File Type	Char(5)	REGPC	Regular Price Changes
FHEAD	Export timestamp	Timestamp		System clock timestamp (YYYYMMDDHHMISS)
FHEAD	Location	Number(10)		Location identifier
FHEAD	Location Type	Char(1)		S = Store W = Warehouse
FDETL	Record Descriptor	Char(5)	FDETL	File Detail Marker (one per price change create or modify)
FDETL	Line ID	Number(10)		Unique line ID
FDETL	Event Type	Char(3)		CRE = Create MOD = Modify
FDETL	ID	Number(15)		Price Change identifier
FDETL	Item	Char(25)		Item identifier
FDETL	Effective Date	Date		Effective Date of price change (YYYYMMDDHHMISS)
FDETL	Selling Unit Change Ind	Number(1)		Did selling unit retail change with this price event (0 = no change, 1 = changed)
FDETL	Selling Retail	Number(20,4)		Selling retail with price change applied
FDETL	Selling Retail UOM	Char(4)		Selling retail unit of measure
FDETL	Selling Retail Currency	Char(3)		Selling retail currency

Table E-3 (Cont.) Regular Price Change File Layout

Record Name	Field Name	Field Type	Default Value	Description
FDETL	Multi-Unit Change Ind	Number(1)		Did multi unit retail change with this price event (0 = no change, 1 = changed)
FDETL	Multi-Units	Number(12,4)		Number Multi Units
FDETL	Multi-Unit Retail	Number(20,4)		Multi Unit Retail
FDETL	Multi-Unit UOM	Char(4)		Multi Unit Retail Unit Of Measure
FDETL	Multi-Unit Currency	Char(3)		Multi Unit Retail Currency
FDELE	Record Descriptor	Char(5)	FDELE	File Detail Delete Marker (one per price change delete)
FDELE	Line ID	Number(10)		Unique line ID
FDELE	ID	Number(15)		Price Change identifier
FDELE	Item	Char(25)		Item identifier
FTAIL	Record Descriptor	Char(5)	FTAIL	File tail marker
FTAIL	Line ID	Number(10)		Unique line ID
FTAIL	Number of lines	Number(10)		Number of lines in file not counting FHEAD and FTAIL

Promotion Price Change Import File Layout Specification

Filename Format

<event type>_<date in YYYYMMDDHH24MISS format>_<loc id>_<loc type>.dat

Where event type is "PRMPC" (promotional price change). The loc type field would be either 'S' or 'W'.

For each file, there need to be a .complete file present to job to process the file. The complete file can be any empty. This is to notify the job that uploading of data file is completed.

Example:

PRMPC_20180129133250_1111_S.dat - Data File.

PRMPC_20180129133250_1111_S.dat.complete - Complete File.

Zip Filename Format

<event type>_<date in YYYYMMDDHH24MISS format>_<loc type>.zip

Where event type value is "PRMPC". The loc type field would be either 'S' or 'W'.

The zip file can contain one or more files from same or different stores. The complete file needs to be added for zip file for job to pick it for processing.

Example:

PRMPC_20180129133250_S.zip - Zip File.

PRMPC_20180129133250_S.zip.complete - Complete File.

File Record Types

- FHEAD (required): File identification, one line per file.
- TMBPE (optional): Event Type.
- TPDTL (required): Promotion Component Detail.
- TPGRP (required): Promotion Group (one or more per TPDTL).
- TGLST (required): Promotion List (one or more per TPGRP).
- TLITM (required): Promotion Item (one or more per TGLST).
- TPDSC (required): Promotion Discount (one or more per TGLST).
- TPISR (optional): Promotion Item Selling retail (one or more per TPDTL).
- TPCDT (optional): Promotion Credit Detail (one or more per TPDTL).
- TTAIL (required): Transaction tail (one per promotion).
- TPCIL (optional): Promotion Cancel Item Location
- FPDEL (optional): Promotion Delete.
- FTAIL (required): End of file marker, one line per file.

File Layout

Table E-4 Promotion Price Change Output File Layout

Record Name	Field Name	Field Type	Default Value	Description
FHEAD	Record Descriptor	Char(5)	FHEAD	File head marker
FHEAD	Line ID	Number(10)	1	Unique line Identifier
FHEAD	File Type	Char(5)	PROMO	Promotions
FHEAD	Export timestamp	Timestamp		System clock timestamp (YYYYMMDDHHMISS)
FHEAD	Location	Number(10)		Location identifier
FHEAD	Location Type	Char(1)		S = Store, W = Warehouse
TMBPE	Record Descriptor	Char(5)	TMBPE	Promotion (transaction head)
TMBPE	Line ID	Number(10)		Unique line identifier
TMBPE	Event Type	Char(3)		CRE = Create MOD = Modify
TPDTL	Record Descriptor	Char(5)	TPDTL	Promotion Detail Component
TPDTL	Line ID	Number(10)		Unique line identifier
TPDTL	Promo ID	Number(10)		Promotion identifier
TPDTL	Promo Comp ID	Number(10)		Promotion Component ID

Table E-4 (Cont.) Promotion Price Change Output File Layout

Record Name	Field Name	Field Type	Default Value	Description
TPDTL	Promo Name	Char(160)		Promotion Header Name
TPDTL	Promo Desc	Char(640)		Promotion Header Description
TPDTL	Promo Comp Desc	Char(160)		Promotion Component Name
TPDTL	Promo Type	Number(2)		Valid values will be modified to be as follows: 0 - Multi-Buy Promotion; 1 - Simple Promotion; 2 - Threshold Promotion; 3 - Finance Promotion (formerly tied to a value of 6); 4 - Transaction Promotion
TPDTL	Promo Comp Detail ID	Number(10)		Promotion Component Detail identifier
TPDTL	Start Date	Date		Start Date of Promotion Component Detail (YYYYMMDDHH24MISS)
TPDTL	End Date	Date		End Date of Promotion Component Detail (YYYYMMDDHH24MISS)
TPDTL	Apply To Code	Number(1)		Holds the apply to code for the promotion detail. Determines if the promotion is applied to regular retail only (no clearances in effect), clearance retail only (only when a clearance is in effect) or both regular and clearance retail. Valid values are 0 - Regular Only; 1 - Clearance Only; 2 - Regular and Clearance.
TPDTL	Discount Limit	Number(3)		The number of times that the promotion that can be applied to a transaction.
TPDTL	Apply Order	Number(1)		Application Order of the Promotion
TPDTL	Threshold ID	Number(6)		Threshold identifier
TPDTL	Customer Type ID	Number(10)		Customer Type identifier
TPDTL	Threshold Qualification Type	Number(1)		The qualification type for the threshold. Will only be populated for threshold promotions. Valid values are 0 for item level and 1 for threshold level.
TPDTL	Exception Parent ID	Number(10)		The promotion component detail ID for the parent event that this event is a child to. Used only for transaction promotion detail exclusions to be able to connect the child exclusion to its parent promotion detail.
TPGRP	Record Descriptor	Char(5)	TPGRP	Promotion Detail Group
TPGRP	Line ID	Number(10)		Unique line identifier
TPGRP	Group ID	Number(10)		Group Number

Table E-4 (Cont.) Promotion Price Change Output File Layout

Record Name	Field Name	Field Type	Default Value	Description
TGLIST	Record Descriptor	Char(5)	TGLIST	Promotion Group List
TGLIST	Line ID	Number(10)		Unique line identifier
TGLIST	List ID	Number(10)		List identifier
TGLIST	Reward Application	Number(1)		How this reward is applied to the promotion detail.
TGLIST	Description	Char(120)		Description
TGLIST	Price Range Min	Number (20,4)		Contains price range promotion minimum valid retail value.
TGLIST	Price Range Max	Number (20,4)		Contains price range promotion maximum valid retail value.
TLITM	Record Descriptor	Char(5)	TLITM	Promotion Group List
TLITM	Line ID	Number(10)		Unique line identifier
TLITM	Item ID	Char(25)		Transaction Item Identifier
TPDSC	Record Descriptor	Char(5)	TPDSC	Discount Detail for List
TPDSC	Line ID	Number(10)		Unique line identifier
TPDSC	Change Type	Number(2)		Change Type
TPDSC	Change Amount	Number(20,4)		Change Amount
TPDSC	Change Currency	Char(3)		Change Currency
TPDSC	Change Percent	Number(20,4)		Change Percent
TPDSC	Change Selling UOM	Char(4)		Change Selling UOM
TPDSC	Qual Type	Number(2)		Qualification Type
TPDSC	Qual Value	Number(2)		Qualification Value
TPDSC	Change Duration	Number(20,4)		Change Duration
TPISR	Record Descriptor	Char(5)	TPISR	Items in Promotion
TPISR	Line ID	Number(10)		Unique line identifier
TPISR	Item ID	Char(25)	TTAIL	Transaction Item Identifier
TPISR	Selling Retail	Number(20,4)		Selling retail of the item
TPISR	Selling UOM	Char(4)		Selling UOM of the item
TPISR	Effective Date	Date		Effective Date of the selling retail - YYYYMMDDHH24MISS
TPISR	Selling Retail Currency	Char(3)		Selling retail currency
TPISR	Referenced Promo Detail ID	Number(15)		Referenced promotion detail ID. This is an optional field.
TPCDT	Record Descriptor	Char(5)	TPCDT	Credit Detail
TPCDT	Credit Detail ID	Number(10)		Credit Detail ID
TPCDT	Line ID	Number(10)		Unique line ID
TPCDT	Credit Type	Char(40)		Credit Type
TPCDT	BinNumberFrom	Number(10)		BinNumber From
TPCDT	BinNumberTo	Number(10)		Bin Number To
TPCDT	Commission Rate	Number(10)		Commission Rate

Table E-4 (Cont.) Promotion Price Change Output File Layout

Record Name	Field Name	Field Type	Default Value	Description
TPCDT	Comments	Char(160)		Comments
TTAIL	Record Descriptor	Char(5)	TTAIL	Transaction Tail
TTAIL	Line ID	Number(10)		Unique line identifier
TPCIL	Record Descriptor	Char(5)	TPCIL	Cancel Item Loc
TPCIL	Line ID	Number(10)		Unique line identifier
TPCIL	Promo ID	Number(10)		The ID of the promotion
TPCIL	Promo Comp ID	Number(10)		Promotion Component ID
TPCIL	Promo Comp Detail ID	Number(10)		Promotion Component Detail identifier
TPCIL	Item ID	Char(25)		Transaction Item Identifier for item
TPCIL	Cancellation Date	Date		Cancellation effective date - YYYYMMDDHH24MISS
FPDEL	Record Descriptor	Char(5)	FPDEL	Delete Promotion
FPDEL	Line ID	Number(10)		Unique line identifier
FPDEL	Promo ID	Number(10)		The ID of the promotion
FPDEL	Promo Comp ID	Number(10)		Promotion Component ID
FPDEL	Promo Comp Detail ID	Number(10)		Promotion Component Detail ID
FPDEL	Group ID	Number(10)		Group Number
FPDEL	List ID	Number(10)		List ID
FPDEL	Item ID	Char(25)		Transaction Item Identifier for item
FTAIL	Record Descriptor	Char(5)	FTAIL	File tail marker
FTAIL	Line ID	Number(10)		Unique line identifier
FTAIL	Number of lines	Number(10)		Number of lines in file not counting FHEAD and FTAIL

POS Sale Transaction Import File Specification

Filename Format

<file prefix>_<date in YYYYMMDDHH24MISS format>_<loc id>.dat

Where file prefix value is "SIMTLOG" and loc id is the store identifier. This allows file to be unique for every upload.

For each file, there need to be a .complete file present to job to process the file. The complete file can be any empty. This is to notify the job that uploading of data file is completed.

Example:

SIMTLOG_20180129133250_1111.dat - Data File.

SIMTLOG_20180129133250_1111.dat.complete - Complete File.

Zip Filename Format

<file prefix>_<date in YYYYMMDDHH24MISS format>.zip

Where file prefix value is "SIMTLOG". The zip file can contain one or more files from same or different stores. The complete file needs to be added for zip file for job to pick it for processing.

Example:

SIMTLOG_20180129133250.zip - Zip File.

SIMTLOG_20180129133250.zip.complete - Complete File.

POS Sale Transaction Import File Format

The input file would be in Pipe ('|') delimited format.

File Layout

Table E-5 T-LOG File

Record Name	Field Name	Field Type	Default Value	Description
FILE HEADER	FILE HEADERFile Type Record Descriptor	VARCHAR2(5)	FHEAD	Identifies the File Record Type
FILE HEADER	Location Number	NUMBER(10)		Store Number
FILE HEADER	Business Date	VARCHAR2(14)		Business Date of transactions in YYYYMMDDHHSS format
FILE HEADER	File Creation Date	VARCHAR2(14)	SYSDATE	File Create Date in YYYYMMDDHHMSS format
TRANSACTION HEADER	File Type Record Descriptor	VARCHAR2 (5)	THEAD	Identifies the File Record Type
TRANSACTION HEADER	Transaction Number	VARCHAR2(128)		The unique transaction reference number generated by ORXPOS/OMS.
TRANSACTION HEADER	Transaction Date and Time	VARCHAR2(14)		Date transactions were processed in ORXPOS/OMS
TRANSACTION HEADER	Customer Order ID	VARCHAR2(128)		External customer order ID, if transaction is a customer order
TRANSACTION HEADER	Customer Order Comments	VARCHAR(512)		Comments on the customer order
TRANSACTION DETAIL	File Type Record Descriptor	VARCHAR2(5)	TDETL	Identifies the File Record Type
TRANSACTION DETAIL	Item ID	VARCHAR2(25)		ID number of the item.
TRANSACTION DETAIL	UIN	VARCHAR2(128)		This is the UNIQUE_ID value from RTLOG
TRANSACTION DETAIL	Item Quantity	NUMBER(12,4)		Quantity of the item on this transaction
TRANSACTION DETAIL	Selling UOM	VARCHAR2(4)		UOM at which this item was sold
TRANSACTION DETAIL	Reason Code	NUMBER(4)		Reason entered by cashier for some transaction types. Required for voids, returns, for example.

Table E-5 (Cont.) T-LOG File

Record Name	Field Name	Field Type	Default Value	Description
TRANSACTION DETAIL	Comments	VARCHAR(512)		Comments for this line item
TRANSACTION DETAIL	Transaction Code	VARCHAR2(25)		The type of sale represented by this line item. Valid value are SALE,RETURN,VOID_SALE,VOID_RETURN,ORDER_NEW,ORDER_FULFILL,ORDER_CANCEL,ORDER_CANCEL_FULFILL
TRANSACTION DETAIL	Reservation Type	VARCHAR(25)		Reservation type if POS transaction is a customer order. Valid values are SPECIAL_ORDER, WEB_ORDER, PICKUP_AND DELIVERY,LAYAWAY
TRANSACTION DETAIL	Fulfillment Order Number	VARCHAR2(48)		Fulfillment Order Number from OMS
TRANSACTION DETAIL	Drop Ship Indicator	VARCHAR(1)		'P' if it is drop ship otherwise 'N'
TRANSACTION TAIL	File Record Type Descriptor	VARCHAR2(5)	TTAIL	Identifies the File Record Type
TRANSACTION TAIL	Transaction Record Counter	NUMBER(6)		Number of TDETL records in this transaction set.
FILE TAIL	File Record Type Descriptor	VARCHAR2(5)	FTAIL	Identifies the File Record Type
FILE TAIL	File Record Counter	NUMBER(10)		Number of records/transactions processed in current file (only records between head and tail)

Retail Sale Audit Import File Specification

Filename Format

<file prefix>_<date in YYYYMMDDHH24MISS format>_<loc id>.dat

Where file prefix value is "SIMT" and loc id is the store identifier. This allows file to be unique for every upload.

For each file, there need to be a .complete file present to job to process the file. The complete file can be any empty. This is to notify the job that uploading of data file is completed.

Example:

SIMT_20180129133250_1111.dat - Data File.

SIMT_20180129133250_1111.dat.complete - Complete File.

Zip Filename Format

<file prefix>_<date in YYYYMMDDHH24MISS format>.zip

Where file prefix value is "SIMT". The zip file can contain one or more files from same or different stores. The complete file needs to be added for zip file for job to pick it for processing.

Example:

SIMT_20180129133250.zip - Zip File.

SIMT_20180129133250.zip.complete - Complete File.

ReSA Transaction Import File Format

The input file would be in Pipe ('|') delimited format.

File Layout

Table E-6 ReSA File Layout

Record Name	Field Name	Field Type	Default Value	Description
FILE HEADER	FILE Type Record Descriptor	VARCHAR2(5)	FHEAD	Identifies the File Record Type
FILE HEADER	File Line ID	VARCHAR(10)		Sequential file line number
FILE HEADER	File Type Definition	VARCHAR2(4)	SIMT	Identifies the File Type
FILE HEADER	Location Number	NUMBER(10)		Store Number
FILE HEADER	Business Date	VARCHAR2(14)		Business Date of transactions in YYYYMMDDHHSS format
FILE HEADER	File Creation Date	VARCHAR2(14)	SYSDATE	File Create Date in YYYYMMDDHHMSS format
TRANSACTION HEADER	File Type Record Descriptor	VARCHAR2 (5)	THEAD	Identifies the File Record Type
TRANSACTION HEADER	File Line ID	VARCHAR(10)		Sequential file line number
TRANSACTION HEADER	Transaction Number	NUMBER(10)		The unique transaction reference number generated by ORXPOS/OMS
TRANSACTION HEADER	Register Number	NUMBER(10)		The register reference number generated by ORXPOS
TRANSACTION HEADER	Revision Number	NUMBER(3)		The version of the transaction being sent
TRANSACTION HEADER	Transaction Date and Time	VARCHAR2(14)		Date transactions were processed in ORXPOS/OMS
TRANSACTION HEADER	Transaction Type	VARCHAR2(14)		Transaction Type Code (for example, SALE, RETURN, SPLORD)
TRANSACTION HEADER	Pos created flag	VARCHAR2(1)		'Y' identifies that the transaction occurred at ORXPOS, 'N' identifies that the transaction was created in ReSA
TRANSACTION DETAIL	File Type Record Descriptor	VARCHAR2(5)	TDETL	Identifies the File Record Type
TRANSACTION DETAIL	File Line ID	VARCHAR(10)		Sequential file line number.
TRANSACTION DETAIL	Item Sequence Number	NUMBER(4)		The order in which items were entered during a transaction

Table E-6 (Cont.) ReSA File Layout

Record Name	Field Name	Field Type	Default Value	Description
TRANSACTION DETAIL	Item	VARCHAR2(25)		ID number of the item.
TRANSACTION DETAIL	Item Type	VARCHAR2(6)		Type of Item sold. Can be 'ITEM', 'REF', 'GCN', 'NMITEM'
TRANSACTION DETAIL	Reference Item	VARCHAR2(25)		Identified sub-transaction level merchandise item.
TRANSACTION DETAIL	Non-Merchandise Item	VARCHAR2(25)		Identifies non-merchandise item
TRANSACTION DETAIL	Item Status	VARCHAR2(6)		Status of the item within the transaction, V for item void, S for sold item, R for returned item, Layaway Initiate (LIN), Layaway Cancel, Layaway Complete (LCO), Order Initiate (ORI), Order Cancel (ORC) Order Complete (ORD)
TRANSACTION DETAIL	Serial Number	VARCHAR2(128)		This is the UNIQUE_ID value from RTLOG
TRANSACTION DETAIL	Pack Indicator	VARCHAR2(1)		Pack indicator of item sold or returned
TRANSACTION DETAIL	Catch Weight Indicator	VARCHAR2(1)		Indicates if item is a catchweight item
TRANSACTION DETAIL	Item Quantity Sign	VARCHAR2(1)		Determines if the Total Sale Quantity is positive or negative 'P' - Positive 'N' - Negative
TRANSACTION DETAIL	Item Quantity Value	NUMBER(20)		Total sales value of goods sold/returned (4 implied decimal places), for example, Total Quantity * 10000
TRANSACTION DETAIL	Standard UOM	VARCHAR2(4)		Standard UOM of the Item
TRANSACTION DETAIL	Selling UOM	VARCHAR2(4)		UOM at which this item was sold
TRANSACTION DETAIL	Wastage Type	VARCHAR2(6)		Wastage type of item sold or returned
TRANSACTION DETAIL	Wastage Percentage	NUMBER(12)		Wastage Percent*10000 (4 implied decimal places), wastage percent of item sold or returned
TRANSACTION DETAIL	Drop Ship Indicator	VARCHAR2(1)	N	This will always be N for Export
TRANSACTION DETAIL	Actual Weight Quantity	NUMBER(12)		Actual Weight Quantity*10000 (4 implied decimal places), the actual weight of the item, only populated if catchweight_ind = 'Y'
TRANSACTION DETAIL	Reason Code	VARCHAR2(6)		Reason entered by cashier for some transaction types
TRANSACTION DETAIL	Sale Value	NUMBER(20)		Total Sales Value * 10000 (4 implied decimal places), sales value, net sales value of goods sold

Table E-6 (Cont.) ReSA File Layout

Record Name	Field Name	Field Type	Default Value	Description
TRANSACTION DETAIL	Sales Sign	VARCHAR2(1)		Determines if the Total Sales Value is positive or negative 'P' - Positive 'N' - Negative
TRANSACTION DETAIL	Unit Retail	NUMBER(20,4)		Unit retail with 4 implied decimal places
TRANSACTION DETAIL	Sales Type	VARCHAR2(1)		Indicates if the line item is a Regular Sale, a CO serviced by OMS (External CO), or a CO serviced by Inventory management application (In-Store CO)
TRANSACTION DETAIL	Customer Order Number	VARCHAR2(50)		Customer Order Number
TRANSACTION DETAIL	Customer Order Type			Customer order type
TRANSACTION DETAIL	Fulfillment Order Number	VARCHAR2(50)		Fulfillment Order Number from OMS
TRANSACTION TAIL	File Record Type Descriptor	VARCHAR2(5)	TTAIL	Identifies the File Record Type
TRANSACTION TAIL	File Line ID	NUMBER(10)		Sequential file line number
TRANSACTION TAIL	Transaction Record Counter	NUMBER(6)		Number of TDETL records in this transaction set
FILE TAIL	File Record Type Descriptor	VARCHAR2(5)	FTAIL	Identifies the File Record Type
FILE TAIL	File Line ID	NUMBER(10)		Sequential file line number
FILE TAIL	File Record Counter	NUMBER(10)		Number of records/transactions processed in current file (only records between head and tail)

Stock Count Results Export File Specification

The stock count result export file is generated when unit amount stock count authorization completes. The stock count authorization process can be a manual authorization or invoked by third party stock count batch for an auto-authorized unit amount stock count. This export file can be uploaded to RMS by RMS file to update their inventory with the actual physical stock count.

Table E-7 Stock Count Export File

Record Name	Field Name	Field Type	Description
File Header	file type record descriptor	Char(5)	hardcode FHEAD
File Header	file line identifier	Number(10)	ID of current line being processed, hardcode 000000001
File Header	file type	Char(4)	hardcode STKU
File Header	file create date	Date(14)YYYYM MDDHHMISS	date written by convert program
File Header	stocktake_date	Date(14)YYYYM MDDHHMISS	take_head.stocktake_date

Table E-7 (Cont.) Stock Count Export File

Record Name	Field Name	Field Type	Description
File Header	cycle count	Number(8)	stake_head.cycle_count
File Header	loc_type	Char(1)	hardcode W or S
File Header	location	Number(10)	stake_location.wh or stake_location.store
Transaction record	file type record descriptor	Char(5)	hardcode FDETL
Transaction record	file line identifier	Number(10)	ID of current line being processed, internally incremented
Transaction record	item type	Char(3)	hardcode ITM
Transaction record	item value	Char(25)	item ID
Transaction record	inventory quantity	Number(12,4)	total units or total weight
Transaction record	location description	Char(30)	Where in the location the item exists. For example, Back Stockroom or Front Window Display
File trailer	file type record descriptor	Char(5)	hardcode FTAIL
File trailer	file line identifier	Number(10)	ID of current line being processed, internally incremented
File trailer	file record count	Number(10)	Number of detail records

Store Sequence Data Parser Import File Layout Specification

Sequencing functionality provides users the ability to know the relative location of an item in a store. Sequencing a store improves store processes and reduces the time that employees spend looking for items. The retailer can sequence all items in the store and create unique locations to hold the items.

Sequencing defines how many items can be stored in a particular location, and allows the definition of a capacity for that item location combination. The capacity is used for in-store replenishment when generating the shelf replenishment pick list. Sequencing is used within Stock Counts, Customer Order Picking, Transfer Request, and Shelf Replenishment to aid the user in proceeding to the next item during the transaction for efficiency. Lastly, the Sequencing Primary Location is displayed to the user on the Item Detail screen.

Filename Format

<file prefix>_<date in YYYYMMDDHH24MISS format>_<loc id>.dat

Where file prefix value is "SSEQ" and loc id is the store identifier. This allows file to be unique for every upload.

For each file, there need to be a .complete file present to job to process the file. The complete file can be any empty. This is to notify the job that uploading of data file is completed.

Example:

SSEQ_20180129133250_1111.dat - Data File.

SSEQ_20180129133250_1111.dat.complete - Complete File.

Zip Filename Format

<file prefix>_<date in YYYYMMDDHH24MISS format>.zip

Where file prefix value is "SSEQ". The zip file can contain one or more files from same or different stores. The complete file needs to be added for zip file for job to pick it for processing.

Example:

SSEQ_20180129133250.zip - Zip File.

SSEQ_20180129133250.zip.complete - Complete File.

Store Sequence Import File Format

The input file would be in pipe ('|') delimited format.

File Layout

Table E-8 Store Sequence Import File

Record Name	Field Name	FieldType	Description
File Header	file type record descriptor	Char(5)	hardcode FHEAD
	Store ID	Number(10)	Store identifier
Sequence record	file type record descriptor	Char(5)	hardcode SHEAD
Sequence record	Area type	Number(9)	The Store Sequence Area. 0 = None, 1 = Shopfloor, 2 = Backroom
Sequence record	Child sequenced	Varchar2(1)	'Y' if child is sequenced, 'N' if not
Sequence record	Department ID	Number(12)	Department ID
Sequence record	Class ID	Number(12)	Class ID
Sequence record	Description	Varchar2(255)	Description of Store Sequence
Sequence record	Not sequenced	Varchar2(1)	Y indicates a default sequence containing all items that have not been sequenced elsewhere
Sequence record	Sequence Order	Number(20)	The order the store sequence is in compared to other store sequences
Sequence detail	file type record descriptor	Char(5)	hardcode SDETL
Sequence detail	Item ID	Varchar2(25)	Item ID
Sequence detail	Primary location	Varchar2(1)	Indicator if the location specified is the primary location for the item, Y if is primary location for item, N otherwise
Sequence detail	Item sequence order	Number(20)	Order of item within store sequence
Sequence detail	Capacity	Number(11,2)	The size of the location appropriate to unit of measure
Sequence detail	Ticket quantity	Number(11,2)	The quantity of tickets that need to be printed or used for the item inventory location
Sequence detail	Ticket format ID	Number(10)	Item ticket format identifier

Table E-8 (Cont.) Store Sequence Import File

Record Name	Field Name	FieldType	Description
Sequence detail	Uom mode	Number(2)	The Unit Of Measure display mode: 1 = Units, 2 = Cases
Sequence detail	Width	Number(12)	Width value to indicate how many items can fit across the width of the shelf
Sequence trailer	File type record descriptor	Char(5)	hardcode STAIL
File trailer	File type record descriptor	Char(5)	hardcode FTAIL

Warehouse Stock Import File Layout Specification

Filename Format

<file prefix>_<date in YYYYMMDDHH24MISS format>.dat

Where file prefix value is "WHIMS". The prefix and date combination allows file to be unique for every upload.

For each file, there need to be a .complete file present to job to process the file. The complete file can be any empty. This is to notify the job that uploading of data file is completed.

Example:

WHIMS_20180129133250_1111.dat - Data File.

WHIMS_20180129133250_1111.dat.complete - Complete File.

Zip Filename Format

<file prefix>_<date in YYYYMMDDHH24MISS format>.zip

Where file prefix value is "WHIMS". The zip file can contain one or more files. The complete file needs to be added for zip file for job to pick it for processing.

Example:

WHIMS_20180129133250.zip - Zip File.

WHIMS_20180129133250.zip.complete - Complete File.

Warehouse Stock Import File Format

The input file would be in Pipe ('|') delimited format.

File Layout

Table E-9 Warehouse Stock Import File

Record Name	Field Name	Field Type	Default Value	Description
1	Warehouse ID	Number(10)	NA	ID of the Warehouse, for example, 7000
2	Item ID	Varchar2(25)	NA	Item Identifier.
3	Stock On Hand	Number(12)	NA	Stock on hand of the item in the warehouse.
4	Status	Varchar2(2)	NA	Status code of the item. Example A - Active, D - Deleted, I - Inactive, C - Discontinued.

Initial Inventory Import File Layout Specification

Filename Format

<file prefix>_<date in YYYYMMDDHH24MISS format>_<loc id>.dat

Where file prefix value is EXTSTK_ and loc id is the store identifier. This allows file to be unique for every upload.

Example: EXTSTK_20180129133250_1111.dat - Data File.

Initial Inventory Import File Format

Pipe-delimited (|) file contains store count data for a store as shown.

File Layout

Table E-10 Initial Inventory Import File

Record Name	Field Name	Field Type	Default Value	Description
FHEAD	Record Descriptor	Char(5)	FHEAD	File head marker
	Store Number	Char(10)		Store number file was uploaded for. It is assumed only one store is passed in per file. (Required)

Table E-10 (Cont.) Initial Inventory Import File

Record Name	Field Name	Field Type	Default Value	Description
FDETL	Record Descriptor	Char(5)	FDETL	Detail record marker
	Upload Date	Date(14)		Indicates date/time item was physically counted. (YYYYMMDDHH24MISS) For example, 20180129134600 (Required for UIN Records)
	Area Number	Char(10)		10-digit code indicating where in the store the item is located. (Optional)
	UPC or Item Number	Char(25)		25-digit universal product code. (Required)
	Count Quantity	Number(12,4)		Quantity counted for item, required. This field must allow for decimals when counting in UOM other than each. (Required)
	UIN(Item Serial Number)	Char(128)		Unique identification serial number for item, required if current item requires serial number.
FTAIL	Record Descriptor	Char(5)	FTAIL	File tail marker

The following is a sample Initial Inventory Import File:

```
FHEAD | 5000 |
FDETL | 20180129235959 | 1 | 100665085 | 1 | ItemSerialNum1234 |
FDETL | 201180129140000 | 1 | 100665085 | 1 | ItemSerialNum9999 |
FDETL | 20180129000000 | 1 | 100665085 | 1 | |
FTAIL |
```

Inventory Extract Export File Specification

The file generated Inventory extract contains current available stock on hand for all the item in a store. Single file will contain inventory for single store, when executed for all stores job will create single file per store and zip all the file to single zip archive.

Filename Format

<file prefix>_<store id>_<date in YYYYMMDDHH24MISS format>.txt

Where file prefix value is "PRODUCT_LOCATION_INV" and the store id is unique store identifier.

<file prefix>_<date in YYYYMMDDHH24MISS format>.zip

Where file prefix value is "PRODUCT_LOCATION_INV".

Inventory Extract File Format

The first row will contain the placeholder information of the data on the file separated by pipe ('|').

Example:

```
system_cd | location_cd | product_cd | available_qty | next_po_qty | next_po_
date | daily_sell_through_qty | sell_qty_multiple | minimum_sell_qty | shrink_
rate | sales_velocity
```

The input file would be in Pipe ('|') delimited format.

File Layout

Table E-11 Inventory Extract File

Record Name	Field Name	Field Type	Default Value	Description
1	System Code	Varchar2	INV	This field will always hold default value that is, INV
2	Location Code	Number	NA	This field holds the store identifier.
3	Product Code	Varchar2	NA	This field hold the item identifier.
4	Available Quantity	Number	NA	This field holds the current available stock on hand for the item in store.
5	Next PO Quantity	Number	0	This field will hold next purchase order quantity.
6	Next PO Date	Varchar2	NA	This field hold the next purchase order date. This field is currently unused and will be empty.
7	Daily Sell Through Quantity	Number	NA	This field is currently unused and will be empty.
8	Sell Qty Multiple	Number	NA	This field is currently unused and will be empty.
9	Minimum Sell Qty	Number	NA	This field is currently unused and will be empty.
10	Shrink Rate	Number	NA	This field is currently unused and will be empty.
11	Sales Velocity	Number	NA	This field is currently unused and will be empty.

The following is a sample Inventory Extract File:

system_cd | location_cd | product_cd | available_qty | next_po_qty | next_po_
date | daily_sell_through_qty | sell_qty_multiple | minimum_sell_qty | shrink_
rate | sales_velocity

INV | 5000 | 100665050 | 10 | 0 | | | | | |

INV | 5000 | 100665051 | 10 | 0 | | | | | |

INV | 5000 | 100665052 | 10 | 0 | | | | | |

Appendix: Auto-Authorized Third-Party Stock Count Process Overview

This section describe overview steps to setup and auto authorize a third party stock count:

1. In the **Operations/Product Group** dialog, create and save a new product group with the following attributes:

Type: Select Unit or Unit and Amount

Counting Method: Select Third Party

Auto Authorize: Select this check box

Note: If auto authorize is selected, the processing of the stock count will attempt to do many automated steps when loading the third party stock count information. If auto authorize is not selected, after loading the file information the authorization process is manual.

2. In the **Operations/Product Group Component** dialog, update the created product group with the desired items to count and save. To count all items in all departments, set **All Department** attribute to **Yes**.
3. In the **Operations/Product Group Schedule** dialog, create a product group schedule for the previous created product group.

Note: If creating a schedule for a unit count that is active on the current date, you will have the option of generating the stock count immediately.

4. In the **Admin/Technical Maintenance/Job Admin** dialog, create and start a new job.

Choose **Generate Unit Stock Count** to generate unit counts.

Choose **Generate Unit and Amount Stock Count** to generate unit and amount counts.

Note: After the generate stock count batch has completed, you can log onto the mobile application, and from the Main Menu, you can navigate to **Inventory Management / Stock Counts / Stock Count List** dialog. Select the generated stock count and you will notice stock count child records have been created for each department. The batch creates stock count groups for all items for all departments for the store, including items with SOH values of zero grouped by department. The stock count will be in new status, as will each of the child department records.

5. The next step of the process is to take a snapshot of the stock count. This is most often done manually but can also be done with an automated job. The snapshot must be taken before uploading the third-party flat file.

Manual. On the mobile application, you will need to use the application to take the appropriate snapshot.

Automated. For a unit and amount stock count, you can run the **Admin/Technical Maintenance/Job Admin** dialog previously used to generate the stock count, you can execute the **Stock Count Unit and Amount Snapshot** batch job.

Note: Selecting **Take Snapshot** in the mobile application or running the batch job takes a snapshot of the current SOH figure and assigns this to every item in the stock count records. The snapshot button is displayed only if there is an extracted **Third Party Stock Count** or **Unit and Amount stock count** on the **Stock Count List** screen. You must first select at least one record from the **Third Party Stock Count** for the snapshot to be taken. Status of the stock count will change to In Progress. This will indicate that the snapshot has occurred. The user will not be able to access the stock count records until the file has been uploaded. If the user double-clicks one of the department stock counts on the list screen, the application will prompt with the message "The stock count will not be accessible until the import process has completed". The user will not be able to drill into the detail screen if the third-party file has not yet been imported into the application.

6. Once the snapshot is taken and the workforce is done counting the items, the appropriate third-party stock count file should be loaded into the system.
7. Once the third-party count file is in place, you can access the **Admin/Technical Maintenance/Job Admin** dialog and execute the **Third Party Stock Count Import** batch job.

Note: When the batch is complete, each item within the count will be updated with the appropriate counted quantity and timestamps assigned. In addition, any item errors will be tracked and written to the database as rejected or unprocessed items. If auto authorize was not chosen, no further processing will take place. Authorization and rejected items management can then be dealt with.

Third Party Processing

1. When the third-party file import process starts, it will attempt to snapshot the stock count if the snapshot has not already taken place. A failure to snapshot will stop the job from processing.
2. Next, it updates all the counted quantity and dates on all the items from the file information. A failure in this step stops the job from processing.
3. It then attempts to perform the completion of each child count without the stock count. Completing the count does business processing on the counted information and moves the status of each completed child to the authorize phase. Any failures that occur are logged and the processing is halted.
4. If auto-authorize was not selected, the processing halts as the files are loaded and count phase completed.
5. If auto-authorize was selected, the processing releases all current user activity locks on the stock count, so it is not being used during further processing.
6. If the stock count was for all items, the automated processing will attempt to find and correct any errors within the rejected items, such as items found but not ranged at the store. This part of the processing will then attempt to range the items.
7. The stock count is then marked ready to approve and so that it can begin final authorization.
8. The process approves each stock count child individually. The batch error log keeps track of each authorization failure. If any authorization failed among the children record the process halts.
9. If the stock count is unit and amount and authorization succeeded, the process attempts to create an export file.

Third Party Recovery

1. Import Failure - If this occurs before or during loading the import file fails, you can begin the entire import process again.
2. Authorization Failure - If the import succeeds, but the authorization fails, you can run authorization recovery. Access the **Admin/Technical Maintenance/Job Admin** dialog and execute the **Stock Count Authorize Recovery** batch job.

Appendix: Unit and Amount Stock Counts Export

Unit and Amount Stock count authorization generates export file which can be uploaded to external inventory system. The stock count authorization process can be started by user through stock count authorization screen or be invoked by third party stock count batch for an auto-authorized unit amount stock count. The export files can be uploaded to merchandising system (for example, RMS) to update merchandising inventory with the actual physical stock count.

Export File Layout

See the [Stock Count Results Export File Specification](#) for file layout details. The generated file will be zipped into an archive with same file naming standard followed for the file generation. A complete file is added once the generated file has been zipped.

Export File Location

Export file directory is created by application installer. Integration admin will need to move the export data files from the application server export directory to a shared upload network location.

Export File Name

STK_<store id>_<schedule id>_<date in YYYYMMDDHH24MISS format>.dat

STK_<store id>_<schedule id>_<date in YYYYMMDDHH24MISS format>.zip

STK_<store id>_<schedule id>_<date in YYYYMMDDHH24MISS format>.zip.complete

Appendix: UPC Barcode

UPC-E items compress a normal 12-digit UPC-A item into six digits. The application can decompress UPC-E barcodes to UPC-A. A seventh digit acts as a check digit for the UPC-E number. When the user scans the UPC-E barcode, the application finds the UPC-A barcode and displays the item ID associated with it.

Differences between UPC-A and UPC-E

UPC-E is also called zero suppressed UPC because UPC-E compresses a normal twelve-digit UPC-A number into a six-digit code by suppressing the number system digit, trailing zeros in the manufacturers code and leading zeros in the product identification part of the bar code message. A seventh check digit is encoded into a parity pattern for the six main digits. UPC-E can thus be uncompressed back into a standard UPC-A twelve-digit number.

Note: Most bar code readers can be configured to automatically convert six-digit UPC-E numbers to twelve-digit UPC-A numbers before they are transmitted to a host computer.

The main difference between a UPC-A symbol and a UPC-E symbol is the size. The following image presents a UPC-A bar code (left) and the same data encoded as a UPC-E bar code (right):

Figure H-1 *UPC-A and UPC-E Differences*



To convert between UPC-A and UPC-E bar code numbers, you can use the following table or try online UPC-E converter program. In the following, the number 0 and each of the letters (a, b, c, d and e) represent individual digits in the bar code message. The letter X represents the UPC check digit.

Table H-1 UPC Conversion Table

UPC-A Number	Equivalent UPC-E	Notes
0ab00000cdeX	abcde0X	Manufacturer code must have two leading digits with three trailing zeros and the item number is limited to three digits (000 to 999).
0ab10000cdeX	abcde1X	Manufacturer code must have three leading digits ending with 1 and two trailing zeros. The item number is limited to three digits.
0ab20000cdeX	abcde2X	Manufacturer code must have three leading digits ending with 2 and two trailing zeros. The item number is limited to three digits.
0abc00000deX	abcde3X	Manufacturer code must have three leading digits and two trailing zeros. The item number is limited to two digits (00 to 99).
0abcd00000eX	abcde4X	Manufacturer code must have four leading digits with one trailing zero and the item number is limited to one digit (0 to 9).
0abcde00005X	abcde5X	Manufacturer code has all five digits. The item number is limited to a single digit consisting of either 5, 6, 7, 8 or 9.
0abcde00006X	abcde6X	
0abcde00007X	abcde7X	
0abcde00008X	abcde8X	
0abcde00009X	abcde9X	

Conversion between UPC-A and UPC-E

Not all UPC-A numbers can be compressed to UPC-E. These codes with a corresponding UPC-E code must have at least four zeros. The requirements are:

1. If the manufacturer code ends with 000, 100, or 200, the UPC-E code consists of the first two characters of the manufacturer code, the last three characters of the product code, followed by the third character of the manufacturer code. In this case, the product code must be 00000 and 00999.
2. If the manufacturer code ends with 00 but does not meet the first requirement, the UPC-E code consists of the first three characters of the manufacturer code, the last two characters of the product code, followed by digit 3. The product code can only contain two digits (00000 to 00099).
3. If the manufacturer code ends in 0 but none of the previous qualifies, the UPC-E consists of the first four digits of the manufacturer code and the last digit of the product code, followed by the digit 4. The product code in this case can only contain one digit (00000 to 00009).
4. If the manufacturer code ends with non-zero digit, the UPC-E code consists of the manufacturer code and the last digit of the product code. In this case the product case can only be one from 00005 to 00009 because 0 through 4 has been used for the previous four cases.

Appendix: EICS Provided URLs

EICS web-client URL

Table I-1 EICS Application URL

URL	
EICS web-client	<a href="https://<eics_external_load_balanced_address>/sim-web-client">https://<eics_external_load_balanced_address>/sim-web-client

SOCS (connections config) URL

Table I-2 SOCS Connections URL

URL	
SOCS (Connections Config)	<a href="https://<eics_external_load_balancer_address>/sim-mobile/oracle.retail.sim.mobile.client.SimMobile/connections.xml">https://<eics_external_load_balancer_address>/sim-mobile/oracle.retail.sim.mobile.client.SimMobile/connections.xml

EICS Web Service URLs

Table I-3 EICS Web Service URLs

SIM-WS	URL
	<a href="https://<eics_external_load_balancer_address>/ActivityLockBean/ActivityLockService?wsdl">https://<eics_external_load_balancer_address>/ActivityLockBean/ActivityLockService?wsdl
	<a href="https://<eics_external_load_balancer_address>/FulfillmentOrderDeliveryBean/FulfillmentOrderDeliveryService?wsdl">https://<eics_external_load_balancer_address>/FulfillmentOrderDeliveryBean/FulfillmentOrderDeliveryService?wsdl
	<a href="https://<eics_external_load_balancer_address>/FulfillmentOrderPickBean/FulfillmentOrderPickService?wsdl">https://<eics_external_load_balancer_address>/FulfillmentOrderPickBean/FulfillmentOrderPickService?wsdl
	<a href="https://<eics_external_load_balancer_address>/FulfillmentOrderReversePickBean/FulfillmentOrderReversePickService?wsdl">https://<eics_external_load_balancer_address>/FulfillmentOrderReversePickBean/FulfillmentOrderReversePickService?wsdl
	<a href="https://<eics_external_load_balancer_address>/InventoryAdjustmentBean/InventoryAdjustmentService?wsdl">https://<eics_external_load_balancer_address>/InventoryAdjustmentBean/InventoryAdjustmentService?wsdl
	<a href="https://<eics_external_load_balancer_address>/ItemBasketBean/ItemBasketService?wsdl">https://<eics_external_load_balancer_address>/ItemBasketBean/ItemBasketService?wsdl

Table I-3 (Cont.) EICS Web Service URLs

SIM-WS	URL
	<a href="https://<eics_external_load_balancer_address>/RfidInventoryBean/RfidInventoryService?wsdl">https://<eics_external_load_balancer_address>/RfidInventoryBean/RfidInventoryService?wsdl
	<a href="https://<eics_external_load_balancer_address>/POSTransactionBean/POSTransactionService?wsdl">https://<eics_external_load_balancer_address>/POSTransactionBean/POSTransactionService?wsdl
	<a href="https://<eics_external_load_balancer_address>/ProductGroupScheduleBean/ProductGroupScheduleService?wsdl">https://<eics_external_load_balancer_address>/ProductGroupScheduleBean/ProductGroupScheduleService?wsdl
	<a href="https://<eics_external_load_balancer_address>/ProductGroupBean/ProductGroupService?wsdl">https://<eics_external_load_balancer_address>/ProductGroupBean/ProductGroupService?wsdl
	<a href="https://<eics_external_load_balancer_address>/ShelfAdjustmentBean/ShelfAdjustmentService?wsdl">https://<eics_external_load_balancer_address>/ShelfAdjustmentBean/ShelfAdjustmentService?wsdl
	<a href="https://<eics_external_load_balancer_address>/ShelfReplenishmentBean/ShelfReplenishmentService?wsdl">https://<eics_external_load_balancer_address>/ShelfReplenishmentBean/ShelfReplenishmentService?wsdl
	<a href="https://<eics_external_load_balancer_address>/StockCountBean/StockCountService?wsdl">https://<eics_external_load_balancer_address>/StockCountBean/StockCountService?wsdl
	<a href="https://<eics_external_load_balancer_address>/StoreFulfillmentOrderBean/StoreFulfillmentOrderService?wsdl">https://<eics_external_load_balancer_address>/StoreFulfillmentOrderBean/StoreFulfillmentOrderService?wsdl
	<a href="https://<eics_external_load_balancer_address>/StoreInventoryBean/StoreInventoryService?wdl">https://<eics_external_load_balancer_address>/StoreInventoryBean/StoreInventoryService?wdl
	<a href="https://<eics_external_load_balancer_address>/StoreInventoryUinBean/StoreInventoryUinService?wsdl">https://<eics_external_load_balancer_address>/StoreInventoryUinBean/StoreInventoryUinService?wsdl
	<a href="https://<eics_external_load_balancer_address>/StoreItemPriceBean/StoreItemPriceService?wsdl">https://<eics_external_load_balancer_address>/StoreItemPriceBean/StoreItemPriceService?wsdl
	<a href="https://<eics_external_load_balancer_address>/StoreBean/StoreService?wsdl">https://<eics_external_load_balancer_address>/StoreBean/StoreService?wsdl
	<a href="https://<eics_external_load_balancer_address>/StoreShipmentManifestBean/StoreShipmentManifestService?wsdl">https://<eics_external_load_balancer_address>/StoreShipmentManifestBean/StoreShipmentManifestService?wsdl
	<a href="https://<eics_external_load_balancer_address>/StoreShipmentReasonBean/StoreShipmentReasonService?wsdl">https://<eics_external_load_balancer_address>/StoreShipmentReasonBean/StoreShipmentReasonService?wsdl
	<a href="https://<eics_external_load_balancer_address>/StoreTransferBean/StoreTransferService?wsdl">https://<eics_external_load_balancer_address>/StoreTransferBean/StoreTransferService?wsdl
	<a href="https://<eics_external_load_balancer_address>/TransferDeliveryBean/TransferDeliveryService?wsdl">https://<eics_external_load_balancer_address>/TransferDeliveryBean/TransferDeliveryService?wsdl
	<a href="https://<eics_external_load_balancer_address>/TransferShipmentBean/TransferShipmentService?wsdl">https://<eics_external_load_balancer_address>/TransferShipmentBean/TransferShipmentService?wsdl
	<a href="https://<eics_external_load_balancer_address>/VendorDeliveryBean/VendorDeliveryService?wsdl">https://<eics_external_load_balancer_address>/VendorDeliveryBean/VendorDeliveryService?wsdl
	<a href="https://<eics_external_load_balancer_address>/VendorReturnBean/VendorReturnService?wsdl">https://<eics_external_load_balancer_address>/VendorReturnBean/VendorReturnService?wsdl
	<a href="https://<eics_external_load_balancer_address>/VendorShipmentBean/VendorShipmentService?wsdl">https://<eics_external_load_balancer_address>/VendorShipmentBean/VendorShipmentService?wsdl

BDI Related URLs

Table I-4 BDI Related URLs

	URL
BDI SIM Job Admin	https://<eics_external_load_balanced_address>/bdi-sim-batch-job-admin
BDI Work Flow	https://<rics_external_load_balanced_address>/bdi-process-flow
BDI Scheduler	https://<rics_external_load_balanced_address>/bdi-scheduler

EICS-RICS Integration URLs

EICS-RICS Message Publishing

Publisher Web Service URL

The message publisher service (SIM -> RIB) is hosted by RIB-SIM. EICS installation takes in the message publisher service WSDL URLs and updates the DB system configuration table.

The WSDL URL can also be updated via EICS System Configuration UI post install.

Table I-5 RIB Message Publishing

Database CONFIG_SYSTEM	System Configuration UI
Name	Display Name
integration.rib.publisher.wsdl.url	Integration Publisher Web Service URL

Web Service User Management

Oracle RICS RIB manages the RIB publisher user.

The publisher user (for example ribadmin) is created as part of the RIB/RTG install.

EICS chef scripts takes the input to add to EICS credential stores.

EICS Install Properties

- input.sim.integration.rib.user.alias=rib-user
- This property is for SIM calling the ApplicationMessagePublishingService. The username and password for the alias should match the user which is created as part of RIB-SIM and belongs to ribAdminGroup.
- The alias name should be unique within the domain, and should not conflict with database data source user alias (for example, in some environment, the SIMRIBAlias is used for db user sim01_RIB, if that is case, choose a different alias for sim -> rib publishing user)

Setting Up RIB Message Injector

Injector Web Service URL

RIB Message Injector Service is hosted in EICS application server.

The WSDL URL is:

https://<sim_external_load_balanced_address>/
ApplicationMessageInjector-Bean/InjectorService?WSDL

Web Service User Management

The injector user (for example, sim_int) must belong to integration_users IDCS or OCI IAM Application Role, the injector user needs to be created as part of EICS provisioning process.

EICS Installation Properties

- input.sim.integration.rib.inject.user.alias
- This property is used for RIB-SIM -> SIM (RIB-SIM calling SIM's injector service), the user is hosted in SIM app and assign integration role (integration_users IDCS or OCI IAM Application Role), the user is created as part of SIM install (for example, sim_int user)

See Oracle® Retail Integration Bus Implementation Guide Provisioning InjectorService URL

BI Related URL

Table I-6 BI Related URL

URL	
xmlpserver	https://<eics_external_load_balanced_address>/xmlpserver

ORDS (Apex Data Viewer) URL

Table I-7 ORDS (Apex Data Viewer) URL

URL	
ORDS (Apex Data Viewer)	https://<eics_external_load_balanced_address>/ords

Appendix: Data Seeding Process Flows

- [Data Seeding Process Flows from Merchandising to EICS](#)
- [Data Seeding Mapping Tables between SIOCS and BDI](#)

Data Seeding Process Flows from Merchandising to EICS

The following list shows the Data Seeding Process Flows from Merchandising to EICS with Groups.

Table J-1 Data Seeding Process Flow Dependencies List

Group#	Process Flow	Notes
1	MerchHier_Fnd_ProcessFlow_From_RMS	Merchandise Hierarchy foundation data seed from Merchandising Foundation Data System. Run once for initial full data seed.
1	Supplier_Fnd_ProcessFlow_From_RMS	Supplier foundation data seed from Merchandising Foundation Data System. Run once for initial full data seed.
1	SupplierAddr_Fnd_ProcessFlow_From_RMS	Supplier address foundation data seed from Merchandising Foundation Data System.
1	Partner_Fnd_ProcessFlow_From_RMS	Partner foundation data seed from Merchandising Foundation Data System.
1	PartnerAddr_Fnd_ProcessFlow_From_RMS	Partner address foundation data seed from Merchandising Foundation Data System.
1	Wh_Fnd_ProcessFlow_From_RMS	Run once for initial full warehouse foundation data seed from Merchandising Foundation Data System.
1	WhAddr_ProcessFlow_From_RMS	Run once for initial full warehouse address foundation data seed from Merchandising Foundation Data System.
2	PartOrgUnit_Fnd_ProcessFlow_From_RMS	Run once for initial full partner Org Unit foundation data seed from Merchandising Foundation Data System.
2	ItemHdr_Fnd_ProcessFlow_From_RMS	Run once for initial full item foundation data seed from Merchandising Foundation Data System.

Table J-1 (Cont.) Data Seeding Process Flow Dependencies List

Group#	Process Flow	Notes
2	Uda_Fnd_ProcessFlow_From_RMS	Run once for initial full User Defined Attribute (UDA) foundation data seed from Merchandising Foundation Data System.
2	DiffGrp_Fnd_ProcessFlow_From_RMS	Run once for initial full foundation data seed from Merchandising Foundation Data System.
2	CodeHead_Fnd_ProcessFlow_From_RMS	Run once for initial full Code Head foundation data seed from Merchandising Foundation Data System.
3	PckitemBrkout_Fnd_ProcessFlow_From_RMS	Run once for initial full Pack Item Breakout foundation data seed from Merchandising Foundation Data System.
3	RelatedItem_Fnd_ProcessFlow_From_RMS	Run once for initial full Related Item foundation data seed from Merchandising Foundation Data System.
4	ItemSupplier_Fnd_ProcessFlow_From_RMS	Run once for initial full Item Supplier foundation data seed from Merchandising Foundation Data System.
4	ItSupCtryDim_Fnd_ProcessFlow_From_RMS	Run once for initial full Item Supplier Country Dimension foundation data seed from Merchandising Foundation Data System.
4	ItSupCtry_Fnd_ProcessFlow_From_RMS	Run once for initial full Item Supplier Country foundation data seed from Merchandising Foundation Data System.
4	ItSupCtryManCtry_Fnd_ProcessFlow_From_RMS	Run once for initial full Item Supplier Manufacturing Country foundation data seed from Merchandising Foundation Data System.
4	ItemSuppUom_Fnd_ProcessFlow_From_RMS	Run once for initial full Item Supplier Unit of Measure foundation data seed from Merchandising Foundation Data System.
5	Store_Fnd_ProcessFlow_From_RMS	Run once for initial full store foundation data seed from Merchandising Foundation Data System.
5	StoreAddr_Fnd_ProcessFlow_From_RMS	Run once for initial full store address foundation data seed from Merchandising Foundation Data System.
6	ItemLoc_Fnd_ProcessFlow_From_RMS	Run once for initial full item location foundation data seed from Merchandising Foundation Data System.
6	InvAvailStore_Tx_ProcessFlow_From_RMS	Run once for initial full store available inventory foundation data seed from Merchandising Foundation Data System.
7	ReplItemLoc_Fnd_ProcessFlow_From_RMS	Run once for initial full replenishment item location inventory foundation data seed from Merchandising Foundation Data System.

Table J-1 (Cont.) Data Seeding Process Flow Dependencies List

Group#	Process Flow	Notes
7	PriceHist_Fnd_ProcessFlow_From_RMS	Run once for initial full item pricing history foundation data seed from Merchandising Foundation Data System.
8	ItemImage_Fnd_ProcessFlow_From_RMS	Run once for initial full item image foundation data seed from Merchandising Foundation Data System.
8	UomClass_Fnd_ProcessFlow_From_RMS	Run once for initial full Unit Of Measure foundation data seed from Merchandising Foundation Data System.
8	UdaItemDate_Fnd_ProcessFlow_From_RMS	Run once for initial full UDA Item Date foundation data seed from Merchandising Foundation Data System.
8	UdaItemFF_Fnd_ProcessFlow_From_RMS	Run once for initial full UDA Item Free Form foundation data seed from Merchandising Foundation Data System.
8	UdaItemLov_Fnd_ProcessFlow_From_RMS	Run once for initial full UDA Item LOV foundation data seed from Merchandising Foundation Data System.
8	UdaValues_Fnd_ProcessFlow_From_RMS	Run once for initial full UDA Values foundation data seed from Merchandising Foundation Data System.
9	CodeDetail_Fnd_ProcessFlow_From_RMS	Run once for initial full Code Detail foundation data seed from Merchandising Foundation Data System.
9	DeliverySlot_Fnd_ProcessFlow_From_RMS	Run once for initial full Delivery Slot foundation data seed from Merchandising Foundation Data System.
9	Diff_Fnd_ProcessFlow_From_RMS	Run once for initial full Differentiators foundation data seed from Merchandising Foundation Data System.
9	UomConversion_Fnd_ProcessFlow_From_RMS	Run once for initial full UOM Conversion foundation data seed from Merchandising Foundation Data System.

Data Seeding Mapping Tables between SIOCS and BDI

The table below specifies the Data Seeding Mapping tables Between SIOCS and BDI.

Table J-2 Data Seeding Mapping Tables between SIOCS and BDI

SIOCS Table	BDI Interface Table
ADDRESS	STORE_ADDR_IN PARTNER_ADDR_IN WH_ADDR_IN SUPPLIER_ADDR_IN
DIFFERENTIATOR	DIFF_IN
DIFFERENTIATOR_TYPE	DIFF_IN
ITEM	ITEM_HDR_IN
ITEM_COMPONENT	PACKITEM_BREAKOUT_IN

Table J-2 (Cont.) Data Seeding Mapping Tables between SIOCS and BDI

SIOCS Table	BDI Interface Table
ITEM_HIERARCHY	MERCH_HIER_IN
ITEM_IMAGE	ITEM_IMAGE_IN
ITEM_PRICE	ITEM_LOC_IN (LOC_TYPE = 'S')
ITEM_PRICE_HISTORY	PRICE_HIST_IN
ITEM_UDA	UDA_ITEM_LOV_IN UDA_ITEM_FF_IN UDA_ITEM_DATE_IN
PARTNER	PARTNER_IN
PARTNER_ITEM	ITEM_LOC_IN (LOC_TYPE = 'E')
RELATED_ITEM	RELATED_ITEM_IN
RELATED_ITEM_TYPE	RELATED_ITEM_TYPE
STORE	STORE_IN
STORE_ITEM	ITEM_LOC_IN (LOC_TYPE = 'S') REPL_ITEM_LOC_IN
STORE_ITEM_STOCK	INV_AVAIL_STORE_IN
STORE_TRANSFER_ZONE	STORE_IN
SUPPLIER	SUPS_IN
SUPPLIER_ITEM	ITEM_SUPPLIER_IN
SUPPLIER_ITEM_COUNTRY	ITEM_SUPP_COUNTRY_IN
SUPPLIER_ITEM_COUNTRY_DIM	ITEM_SUP_CTY_DIM_IN
SUPPLIER_ITEM_MANUFACTURE	ITEM_SUP_MAN_CTY_IN
SUPPLIER_ITEM_UOM	ITEM_SUPP_UOM_IN
SUPPLIER_ORGANIZATION	PARTNER_ORG_UNIT_IN
UDA	UDA_IN
UDA_LOV	UDA_VALUES_IN
UOM_CLASS	UOM_CLASS_IN
UOM_CONVERSION	UOM_CONVERSION_IN
WAREHOUSE	WH_IN
WAREHOUSE_ITEM	ITEM_LOC_IN (LOC_TYPE = 'W')

Appendix: Pricing Import with On-premise RPM

This section is only applicable for EICS to integration with customer have on-premise RPM, RPM pricing files are placed on EICS SFTP incoming locations, and the file import job processes each file from incoming directory when a corresponding completer file presents. The completer is a zero-byte file which indicates file transfer is complete and ready for processing. The reject files will be pushed to outgoing for client review.

Note: Pricing file import from On-premise RPM will be phased out in future releases.

- [Clearance Price Change Import with On-premise RPM](#)
- [Promotion Price Change Import with On-premise RPM](#)
- [Regular Price Change Import with On-premise RPM](#)

Clearance Price Change Import with On-premise RPM

This batch imports the clearance price changes from flat file into item price table. Each file contains price change record for a single location. Files with location type of store (file name with suffix of "S") are relevant to EICS. The import process skips file with location type which are not store.

There are two phases involve in the batch process. The file load phase loads the file into price change worksheet table; the extract phase kicks off multiple threads to extract the approved worksheet records into item price table.

To optimize price change batch import process, admin user can change the system configuration parameter 'DAYS_TO_HOLD_PRICE_CHANGE_WORKSHEET' value to 0, the completed staged worksheet records will be deleted after price change records are extracted into item_price table.

File Specification

File Name Format: CLRPC_<date in YYYYMMDDHH24MISS format>_<loc type>

Where <loc type> can be S (store) or W (Warehouse), EICS only process files which have loc_type of S.

File Layout: See [Clearance Price Change Import File Layout Specification](#).

Batch Job Definition Name

ClearancePriceChange_OpsJob

Batch Job Parameters

<File name>

If not specified, then the data file in incoming directory are processed.

File Error Handling

The batch job will be marked as failed if the file staging fails. The staging process is all or none transaction so if an error occurs during the batch process, none of the transactions in the file will be staged. The user will need to rerun the same file again after resolving any errors.

Key Tables

Table K-1 Key Tables for Clearance Price Change with On-premise RPM

Tables	Select	Insert	Update	Delete
batch_execution	Yes	Yes	Yes	
price_change_worksheet	Yes	Yes	Yes	Yes
Item_price	Yes	Yes	Yes	

Promotion Price Change Import with On-premise RPM

This batch imports the promotion price changes from flat file into item price table.

There are two phases involve in the batch process. The file load phase loads the file into price change worksheet table; the extract phase kicks off multiple threads to extract the approved worksheet records into item price table.

To optimize price change batch import process, admin user can change the system configuration parameter 'DAYS_TO_HOLD_PRICE_CHANGE_WORKSHEET' value to 0, the completed staged worksheet records will be deleted after price change records are extracted into item_price table.

File Specification

File Name format: PRMPC_<date in YYYYMMDDHH24MISS format>_<loc id>_<loc type>

Where <loc type> can be S (store) or W (Warehouse), EICS only process files which have loc_type of S.

File Layout: See [Promotion Price Change Import File Layout Specification](#).

Batch Job Definition Name

PromotionPriceChange_OpsJob

Batch Job Parameters

<File name>

If not specified, then the data file in incoming directory are processed.

File Error Handling

The batch job will be marked as failed if the file staging fails. The staging process is all or none transaction so if an error occurs during the batch process, none of the transactions in the file will be staged. The user will need to rerun the same file again after resolving any errors.

Key Tables**Table K-2 Key Tables for Promotion Price Change with On-premise RPM**

Tables	Select	Insert	Update	Delete
price_change_worksheet	Yes		Yes	Yes
Item_price	Yes	Yes	Yes	
config_store	Yes			
item_uda	Yes			
print_format_type	Yes			

Regular Price Change Import with On-premise RPM

This batch imports the regular price changes from flat file into item price table.

There are two phases involve in the batch process. The file load phase loads the file into price change worksheet table; the extract phase kicks off multiple threads to extract the approved worksheet records into item price table.

To optimize price change batch import process, admin user can change the system configuration parameter 'DAYS_TO_HOLD_PRICE_CHANGE_WORKSHEET' value to 0, the completed staged worksheet records will be deleted after price change records are extracted into item_price table.

File Specification

File Name format: REGPC_<date in YYYYMMDDHH24MISS format>_<loc id>_<loc type>

Where <loc type> can be S (store) or W (Warehouse), EICS only process files which have loc_type of S.

File Layout: See [Regular Price Change Import File Layout Specification](#).

Batch Job Definition Name

RegularPriceChange_OpsJob

Batch Job Parameters

<File name>

If not specified, then the data file in incoming directory are processed.

File Error Handling

The batch job will be marked as failed if the file staging fails. The staging process is all or none transaction so if an error occurs during the batch process, none of the transactions in the file will be staged. The user will need to rerun the same file again after resolving any errors.

Key Tables**Table K-3 Key Tables for Regular Price Change with On-premise RPM**

Tables	Select	Insert	Update	Delete
price_change_worksheet	Yes	Yes	Yes	Yes
Item_price	Yes	Yes	Yes	
config_store	Yes			

Table K-4 Key Tables for Regular Price Change Batch

Tables	Select	Insert	Update	Delete
item_uda	Yes			
print_format_type	Yes			
batch_execution	Yes	Yes	Yes	

Appendix: Open Transaction Seeding via BDI

Overview

Merchandising Solution usually goes live prior to the SIOCS system. The integration layer supports the flow of foundation data via BDI (bulk data import) process or via RIB Messages. As the customer is currently in the transition phase that is, cutover from old system to Oracle Cloud Solution, the complete transaction freeze for the stores may not be achievable. There would be a few transactions which would be currently in In-Progress states which means they are either not fully received, closed or cancelled. This data needs to be imported into SIOCS as these are open transactions.

Third Party Open TX data imports open transaction data for three main areas.

1. Purchase Order
2. Direct Store Deliveries from Supplier
3. Transfer / Allocations

Third party transaction import is considered to be a one-time activity before go live and not a practice for transactional data flow. The system would allow creating new transactions and updating existing transactions only if the sanity of the transaction that is, the current state in SIOCS database is the same.

As the transaction import is from an external system, the identifier generated for the transactions on the external system will also be mapped to the external identifier of SIOCS transactional data.

The complete integration of data imports direct from Merchandising similar to foundation data import is currently not supported.

The implementation team would be responsible for sourcing this data via BDI External Interfaces.

The following Transaction Import batches are independent of each other and would be responsible for processing the transactions to SIOCS database.

BDI Implementation Considerations

To load third party data into EICS via BDI, external system needs to provide data sourcing implementations.

This section lists two approaches for data sourcing implementation.

Option A: BDI External Process Flow (via External Edge App)

With this approach, the BDI Ext Process Flow will move the data from sourcing system to destination system's application table. BDI process flow provides BDI job scheduling, end to end data transportation from sourcing system's database table into destination application's tables.

For additional details, see RICS documentations:

Oracle® Retail Bulk Data Integration Cloud Service Implementation Guide

Oracle® Retail Enterprise Integration Overview Guide

Option B: BDI CLI Transmitter

BDI CLI File Transmitter is a client command line tool, is applicable for smaller data file size which does not require concurrent processing.

BDI CLI file transmitter only transports data files from sourcing systems to destination system's interface tables. It does not provide end to end data transportation. If you choose BDI CLI File transmitter for loading third party data into EICS application tables, it will require three steps:

1. Download BDI CLI File Transmitter from RICS' and install on customer's system.
2. Run BDI CLI Transmitter batch to load data file from sourcing system into receiver system's interface table (*_IN tables).
3. Once the data is loaded into the receiver app's inbound interface tables, the user would need to provide the data set id and start EICS's importer job to move the data from the inbound interface table into the EICS app tables.

Open Transaction Data Processing

The following section details a few key points for the technical design of transaction data import:

1. Flattening the database tables

Flattened database architecture makes the query execution much faster than the normalized form. Each row on the table would denote a line item with complete information of the transaction it belongs to and what line item attribute values are.

This reduces the overhead cost of join and querying multiple tables to get the complete transaction detail identified by a particular identifier.

2. Data Validation

The first and foremost step of the transaction import is validating the data against the values available. The transaction import batch processes would validate the complete data as the data would then be processed to the SIOCS transaction tables. The basic validations which would be performed are as follows:

- a. Is the transaction for a valid store?
- b. Is the transaction from a valid source? (store, warehouse, finisher or supplier)

- c. Is the item identifier existing on the item master table of SIOCS database?
- d. Is the status / type specified on data denoting valid information as per the SIOCS technical design?

Please refer to [Data Import Exception Handling](#) section for more details.

3. Parallel Processing

The batch process will split the data into partitions by the transaction external identifiers to support the parallel processing of the transaction import. Each partition will contain the list of transaction identifiers which are to be processed. The number of partitions in which the data would be divided is defined by an existing system admin configuration parameter (Batch Maximum Threads). The default value for this parameter is set to 5. Each thread would be assigned a partition to be processed.

So, if there are 10000 transactions to be imported, 5 separate thread processes would be instantiated to process a workload of 2000 transactions per thread.

The partition feature used here is as per JSR 352 specification defined for Java EE 7 and Java SE 6 platforms.

4. Data Import

The partitioned transaction external identifier will be validated against the existing transactions on the SIOCS database (if any exists). If the no matching transactions are found, a new transaction would be added to the respective transaction table. If the transaction identifier matches to an existing record, then that transaction would be updated with the latest data from the flattened staging table. The data import process does not update the state of transaction.

The data import processes the data into chunks and a failover mechanism is added to process the correct data and mark the invalid data as failed. This also helps improving the server performance as not all transactions on a partition are imported at one go. The chunk process will further break the partition in sub-lists and process the data in group of records reducing the server overhead and memory consumption.

5. Inventory Correction

The inventory correction logic is not applicable for purchase order processing as there is no inventory bucket to be updated.

For the transfer transactions that are currently approved, the transfer reserved bucket of the item's inventory at source store needs to be corrected once the transaction is successfully imported into the system.

For the Direct Store Delivery transactions (if associated with customer order), the picking quantity would need to be updated when the received delivery is created depending on a system parameter.

Below is the configuration parameter to be considered while processing the direct store delivery which has a container in Received status.

Direct Delivery - Import Details

This batch imports the direct delivery transaction imported from Merchandising / Third Party System posted on SIOCS BDI table for example, EXT_DSD_IN. The job supports only creation of the deliveries of ASN types. Data validation is also part of processing and proper error mechanism will log the error against each batch execution. This job does not support the importing of UINs and Custom Attributes.

For the interface definition, please refer to the [DSD Interface Specification](#) section.

Table L-1 EXT_DSD_IN and SIOCS Transaction Table Mappings

BDI Interface Table	SIOCS Transactional Tables
EXT_DSD_IN	DSD
	DSD_CARTON
	DSD_LINE_ITEM
	DSD_ADJUSTMENT

For the detail column level mapping please refer to [Data Mapping](#) section.

Table L-2 Configuration Parameters for DSD Received Status

Parameter Name	Description
Reserve Customer Order Inventory Upon Receiving	Update the customer order reserved bucket while creating a new transaction.
Auto Pick On Receive - Direct Delivery	Will update the picked quantity on customer order (if exists).
Auto Pick Mixed Containers	Will update the picked quantity on customer order (if exist) for a container which contains both customer order related items and normal items.

Transfer - Import Details

This batch imports the transfer and allocation records from Merchandising / Third Party System posted on SIOCS BDI table that is, EXT_TSF_IN. The job support creates the transfer / allocation records in SIOCS database and makes them accessible on UI for users. The inventory in-transit calculation posts the importing of the transaction and will be taken care of by this batch job. Data validation is also part of processing and proper error mechanism will log the error against each batch execution.

For the interface definition, please refer to the [Transfer Interface Specification](#) section.

Table L-3 EXT_TSF_IN and SIOCS Transaction Table Mappings

BDI Interface Table	SIOCS Transactional Tables
EXT_TSF_IN	TSF
	TSF_LINE_ITEM
	TSF_ALLOCATION

Purchase Order - Import Details

This batch imports the purchase order records from Merchandising / Third Party System posted on SIOCS BDI table that is, EXT_PURCH_ORDER. This job creates the purchase order records in SIOCS database and makes them accessible on UI for users. Data validation is also part of processing and proper error mechanism will log the error against each batch execution.

For the interface definition, please refer to the [Purchase Order Interface Specification](#) section.

Table L-4 EXT_PURCH_ORDER_IN BDI And App Table Mappings

BDI Interface Table	SIOCS Transactional Tables
EXT_PURCH_ORDER_IN	PURCHASE_ORDER
	PURCHASE_ORDER_LINE_ITEM

For the detail column level mapping please refer to the [Data Mapping](#) section.

Data Mapping

The table below specifies the database column mapping for each functional area.

1. Direct Store Delivery from Supplier (DSD Receiving)

BDI Transaction Import Table: EXT_DSD_IN

BDI Column	Transaction Mapped Column	Transaction Mapped Table
DSD_ASN	ASN_ID	DSD
DSD_STORE	STORE_ID	DSD
DSD_SUPPLIER	SUPPLIER_ID	DSD
DSD_STATUS	STATUS	DSD
DSD_EXPECTED_DATE	EXPECTED_DATE	DSD
DSD_CREATE_DATE	CREATE_DATE	DSD
DSD_UPDATE_DATE	UPDATE_DATE	DSD
DSD_RECEIVED_DATE	RECEIVED_DATE	DSD
DSD_INVOICE	INVOICE_ID	DSD
DSD_INVOICE_DATE	INVOICE_DATE	DSD
DSD_CREATE_USER	CREATE_USER	DSD
DSD_CUST_ORD_ID	CUST_ORDER_ID	DSD
DSD_FUL_ORD_EXT_ID	FUL_ORD_EXTERNAL_ID	DSD
DSD_CARRIER_ENTITY	CARRIER_ENTITY	DSD
DSD_CARRIER_TYPE	CARRIER_TYPE	DSD
DSD_CARRIER_CODE	CARRIER_CODE	DSD
DSD_COUNTRY_CODE	COUNTRY_CODE	DSD
DSD_SOURCE_ADDRESS	SOURCE_ADDRESS	DSD
DSD_LICENSE_PLATE	LICENSE_PLATE	DSD
DSD_FREIGHT_ID	FREIGHT_ID	DSD
DSD_CURRENCY_CODE	CURRENCY_CODE	DSD
DSD_INVOICE_COST	INVOICE_COST_VALUE	DSD
DSD_RECEIVED_USER	RECEIVED_USER	DSD
DSD_UPDATE_USER	UPDATE_USER	DSD
DSD_BOL_EXT_ID	BOL_EXTERNAL_ID	DSD
DSD_ADJ_PO_EXT_ID	PURCHASE_ORDER_EXT_ID	DSD_ADJUSTMENT

BDI Column	Transaction Mapped Column	Transaction Mapped Table
DSD_ADJ_ITEM	ITEM_ID	DSD_ADJUSTMENT
DSD_ADJ_DATE	ADJUSTMENT_DATE	DSD_ADJUSTMENT
DSD_ADJ_QUANTITY	ADJUSTMENT_QUANTITY	DSD_ADJUSTMENT
DSD_CARTON_EXT_ID	EXTERNAL_ID	DSD_CARTON
DSD_CARTON_STATUS	STATUS	DSD_CARTON
DSD_CARTON_STORE	STORE_ID	DSD_CARTON
DSD_CARTON_REFERENCE_ID	REFERENCE_ID	DSD_CARTON
DSD_CARTON_DAMAGED_REASON	DAMAGED_REASON	DSD_CARTON
DSD_CARTON_SERIAL_CODE	SERIAL_CODE	DSD_CARTON
DSD_CARTON_TRACKING_NUMBER	TRACKING_NUMBER	DSD_CARTON
DSD_CARTON_DAMAGE_REMAINING	DAMAGE_REMAINING	DSD_CARTON
DSD_CARTON_CREATE_USER	CREATE_USER	DSD_CARTON
DSD_CARTON_UPDATE_USER	UPDATE_USER	DSD_CARTON
DSD_CARTON_RECEIVE_USER	RECEIVE_USER	DSD_CARTON
DSD_CARTON_CREATE_DATE	CREATE_DATE	DSD_CARTON
DSD_CARTON_UPDATE_DATE	UPDATE_DATE	DSD_CARTON
DSD_CARTON_RECEIVE_DATE	RECEIVE_DATE	DSD_CARTON
DSD_CARTON_UIN_REQUIRED	UIN_REQUIRED	DSD_CARTON
DSD_CARTON_RCV_AT_SHOP_FLOOR	RECEIVE_AT_SHOP_FLOOR	DSD_CARTON
DSD_CARTON_QUALITY_CONTROL	QUALITY_CONTROL	DSD_CARTON
DSD_CARTON_EXTERNAL_CREATE	EXTERNAL_CREATE	DSD_CARTON
DSD_CARTON_ADJUSTED	ADJUSTED	DSD_CARTON
DSD_CARTON_CUST_ORD_RELATED	CUSTOMER_ORDER_RELATED	DSD_CARTON
DSD_LINE_ITEM	ITEM_ID	DSD_LINE_ITEM
DSD_LINE_CASE_SIZE	CASE_SIZE	DSD_LINE_ITEM
DSD_LINE_EXPECTED	QUANTITY_EXPECTED	DSD_LINE_ITEM
DSD_LINE_RECEIVED	QUANTITY_RECEIVED	DSD_LINE_ITEM
DSD_LINE_DAMAGED	QUANTITY_DAMAGED	DSD_LINE_ITEM
DSD_LINE_UNIT_COST_CURR	UNIT_COST_CURRENCY	DSD_LINE_ITEM
DSD_LINE_UNIT_COST_VAL	UNIT_COST_VALUE	DSD_LINE_ITEM

BDI Column	Transaction Mapped Column	Transaction Mapped Table
DSD_LINE_OVRD_UNIT_COST_CURR	OVERRIDE_UNIT_COST_CURRENCY	DSD_LINE_ITEM
DSD_LINE_OVRD_UNIT_COST_VAL	OVERRIDE_UNIT_COST_VALUE	DSD_LINE_ITEM
DSD_LINE_STORE	STORE_ID	DSD_LINE_ITEM
DSD_LINE_PO_EXT_ID	PURCHASE_ORDER_EXT_ID	DSD_LINE_ITEM
DSD_LINE_CUST_ORD_ID	CUST_ORDER_ID	DSD_LINE_ITEM
DSD_LINE_FUL_ORD_EXT_ID	FUL_ORD_EXTERNAL_ID	DSD_LINE_ITEM
DSD_LINE_VPN	VENDOR_PRODUCT_NUMBER	DSD_LINE_ITEM
DSD_LINE_RECEIVED_OVER	QUANTITY_RECEIVED_OVER	DSD_LINE_ITEM
DSD_LINE_DAMAGED_OVER	QUANTITY_DAMAGED_OVER	DSD_LINE_ITEM
DSD_LINE_PREV_RECEIVED	PREVIOUS_RECEIVED	DSD_LINE_ITEM
DSD_LINE_PREV_DAMAGED	PREVIOUS_DAMAGED	DSD_LINE_ITEM

2. Transfers

BDI Transaction Import Table: EXT_TSF_IN

Column TSF_DOC_TYPE = T denotes the transaction is transfer.

BDI Column	Mapped Column	Mapped Column Table
TSF_EXT_ID	EXTERNAL_ID	TSF
TSF_SRC_TYPE	SOURCE_TYPE	TSF
TSF_SRC	SOURCE_ID	TSF
TSF_DEST_TYPE	DESTINATION_TYPE	TSF
TSF_DEST	DESTINATION_ID	TSF
TSF_STATUS	STATUS	TSF
TSF_CREATE_USER	CREATE_USER	TSF
TSF_UPDATE_USER	UPDATE_USER	TSF
TSF_APPROVAL_USER	APPROVAL_USER	TSF
TSF_CREATE_DATE	CREATE_DATE	TSF
TSF_UPDATE_DATE	UPDATE_DATE	TSF
TSF_APPROVAL_DATE	APPROVAL_DATE	TSF
TSF_CONTEXT_ID	CONTEXT_ID	TSF
TSF_CONTEXT_VALUE	CONTEXT_VALUE	TSF
TSF_CUST_ORD_ID	CUST_ORD_EXTERNAL_ID	TSF
TSF_FUL_ORD_EXT_ID	FUL_ORD_EXTERNAL_ID	TSF
TSF_PARTIAL_DELIVERY_IND	ALLOW_PARTIAL_DELIVERY	TSF

BDI Column	Mapped Column	Mapped Column Table
TSF_AUTH_CODE	AUTHORIZATION_CODE	TSF
TSF_NOT_AFTER_DATE	NOT_AFTER_DATE	TSF
TSF_REQUEST_DATE	REQUEST_DATE	TSF
TSF_REQUEST_USER	REQUEST_USER	TSF
TSF_USE_AVAILABLE	USE_AVAILABLE	TSF
TSF_LINE_ITEM	ITEM_ID	TSF_LINE_ITEM
TSF_LINE_CASE_SIZE	CASE_SIZE	TSF_LINE_ITEM
TSF_LINE_REQUESTED	QUANTITY_REQUESTED	TSF_LINE_ITEM
TSF_LINE_APPROVED	QUANTITY_APPROVED	TSF_LINE_ITEM
TSF_LINE SHIPPING	QUANTITY SHIPPING	TSF_LINE_ITEM
TSF_LINE SHIPPED	QUANTITY SHIPPED	TSF_LINE_ITEM
TSF_LINE RECEIVED	QUANTITY RECEIVED	TSF_LINE_ITEM
TSF_LINE DAMAGED	QUANTITY DAMAGED	TSF_LINE_ITEM
TSF_LINE_PREFERRED_UOM	PREFERRED_UOM	TSF_LINE_ITEM

3. Transfer Allocations

BDI Transaction Import Table: EXT_TSF_IN

Column TSF_DOC_TYPE = A denotes the transaction is transfer allocation.

BDI Column	Mapped Column	Mapped Column Table
TSF_EXT_ID	EXTERNAL_ID	TSF_ALLOCATION
TSF_DELIVERY_DATE	DELIVERY_DATE	TSF_ALLOCATION
TSF_LINE_ITEM	ITEM_ID	TSF_ALLOCATION
TSF_DEST	STORE_ID	TSF_ALLOCATION
TSF_DELV_SLOT_ID	DELIVERY_SLOT_ID	TSF_ALLOCATION
TSF_SRC	SOURCE_ID	TSF_ALLOCATION
TSF_SRC_TYPE	SOURCE_TYPE	TSF_ALLOCATION
TSF_CONTEXT_VALUE	CONTEXT_VALUE	TSF_ALLOCATION
TSF_LINE_DIST_PARENT_ID	DISTRIBUTION_PARENT_ID	TSF_ALLOCATION
TSF_STATUS	STATUS	TSF_ALLOCATION
TSF_LINE_EXPECTED	QUANTITY_EXPECTED	TSF_ALLOCATION
TSF_LINE RECEIVED	QUANTITY RECEIVED	TSF_ALLOCATION
TSF_LINE DAMAGED	QUANTITY DAMAGED	TSF_ALLOCATION
TSF_CONTEXT_ID	CONTEXT_ID	TSF_ALLOCATION

4. Purchase Order

BDI Transaction Import Table: EXT_PURCH_ORDER_IN

BDI Column	Mapped Column	Mapped Column Table
PO_EXT_ID	EXTERNAL_ID	PURCHASE_ORDER
PO_STORE	STORE_ID	PURCHASE_ORDER
PO_SUPPLIER	SUPPLIER_ID	PURCHASE_ORDER
PO_STATUS	STATUS	PURCHASE_ORDER
PO_NOT_BEFORE_DATE	NOT_BEFORE_DATE	PURCHASE_ORDER
PO_NOT_AFTER_DATE	NOT_AFTER_DATE	PURCHASE_ORDER
PO_CREATE_DATE	CREATE_DATE	PURCHASE_ORDER
PO_UPDATE_DATE	UPDATE_DATE	PURCHASE_ORDER
PO_COMPLETE_DATE	COMPLETE_DATE	PURCHASE_ORDER
PO_USER	USER_ID	PURCHASE_ORDER
PO_COMMENTS	COMMENTS	PURCHASE_ORDER
PO_CUST_ORD_ID	CUST_ORDER_ID	PURCHASE_ORDER
PO_FUL_ORD_EXT_ID	FUL_ORD_EXTERNAL_ID	PURCHASE_ORDER
PO_EXT_STATUS	EXTERNAL_STATUS	PURCHASE_ORDER
PO_LINE_ITEM	ITEM_ID	PURCHASE_ORDER_LINE_ITEM
PO_LINE_SUPP_COUNTRY	SUPPLIER_COUNTRY_ID	PURCHASE_ORDER_LINE_ITEM
PO_LINE_CASE_SIZE	CASE_SIZE	PURCHASE_ORDER_LINE_ITEM
PO_LINE_EXPECTED	QUANTITY_EXPECTED	PURCHASE_ORDER_LINE_ITEM
PO_LINE_RECEIVED	QUANTITY_RECEIVED	PURCHASE_ORDER_LINE_ITEM
PO_LINE_UNIT_COST_CURRENCY	UNIT_COST_CURRENCY	PURCHASE_ORDER_LINE_ITEM
PO_LINE_UNIT_COST_VALUE	UNIT_COST_VALUE	PURCHASE_ORDER_LINE_ITEM
PO_LINE_PREFERRED_UOM	PREFERRED_UOM	PURCHASE_ORDER_LINE_ITEM
PO_LINE_PUBLISHED	PUBLISHED	PURCHASE_ORDER_LINE_ITEM

Data Import Exception Handling

This section describes the error message with which batch would be marked as failed due to the invalid data on transaction import file.

Each error message will be prefixed with following text to denote the error recorded is for which row value in respective BDI transaction import table.

Prefix Text: Validation failed for Row Sequence: <BDI_SEQ_ID>

Table L-5 1. Purchase Order

Error	Cause	Data Column with Error
Purchase Order:<PO_EXT_ID> has invalid store information.	Store identifier is not a valid store for a new purchase order.	PO_STORE

Table L-5 (Cont.) 1. Purchase Order

Error	Cause	Data Column with Error
Purchase Order:<PO_EXT_ID> has invalid supplier information.	Supplier identifier is not a valid supplier for a new purchase order.	PO_SUPPLIER
Purchase Order:<PO_EXT_ID> has no status information.	Status is either null or not valid value for purchase order status for a new purchase order.	PO_STATUS
Purchase Order:<PO_EXT_ID> has no external status information.	External status is either null or not valid value for purchase order external status for a new purchase order.	PO_EXT_STATUS
Purchase Order:<PO_EXT_ID> has invalid store information that does not match to existing transaction.	Store identifier doesn't match to the existing purchase order.	PO_STORE
Purchase Order:<PO_EXT_ID> has invalid supplier information that does not match to existing transaction.	Supplier identifier doesn't match to the existing purchase order.	PO_SUPPLIER
Purchase Order:<PO_EXT_ID> has invalid status code.	Status is either null or not valid value for purchase order status for an existing purchase order.	PO_STATUS
Purchase Order:<PO_EXT_ID> has status which does not match the existing data.	Status is not same as that for the existing purchase order.	PO_STATUS
Purchase Order:<PO_EXT_ID> has external status information which is not valid for existing transaction.	External status is either null or not a valid value for an existing transaction.	PO_EXT_STATUS
Purchase Order:<PO_EXT_ID> Item:<ITEM_ID> is not ranged for store.	Item is not range to the store.	PO_LINE_ITEM PO_STORE
Purchase Order:<PO_EXT_ID> Item:<ITEM_ID> is not ranged for supplier.	Item is not ranged to the supplier.	PO_LINE_ITEM PO_SUPPLIER
Purchase Order:<PO_EXT_ID> Item:<ITEM_ID> has no supplier country information.	Item Supplier country information is not available on the SIOCS.	PO_LINE_ITEM PO_SUPPLIER PO_LINE_SUPP_COUNTRY

Table L-6 2. Transfer

Error	Cause	Data Column with Error
Transfer:<TSF_EXT_ID> has invalid source information.	Transfer source is not valid.	TSF_SRC
Transfer:<TSF_EXT_ID> has invalid destination information.	Transfer destination is not valid.	TSF_DEST
Transfer:<TSF_EXT_ID> is not a valid store transfer.	Transfer is not valid store transfer that is, both source and destination is not a store.	TSF_SRC_TYPE TSF_DEST_TYPE

Table L-6 (Cont.) 2. Transfer

Error	Cause	Data Column with Error
Transfer:<TSF_EXT_ID> has invalid status information.	Transfer Status is null or not valid value.	TSF_STATUS
Transfer:<TSF_EXT_ID> has source identifier which does not match the existing data.	Transfer source identifier does not match to the existing transfer transaction on SIOCS.	TSF_SRC
Transfer:<TSF_EXT_ID> has destination identifier which does not match the existing data.	Transfer destination identifier does not match to the existing transfer transaction on SIOCS.	TSF_DEST
Transfer:<TSF_EXT_ID> has status which does not match the existing data.	Transfer status does not match to the existing transaction state on SIOCS.	TSF_STATUS
Transfer:<TSF_EXT_ID> is already approved and use available flag value doesn't match existing data.	Use available flag is changed for the existing approved transfer transaction.	TSF_USE_AVAILABLE
Transfer:<TSF_EXT_ID> has no source type information.	Transfer source type is either null or an invalid value.	TSF_SRC_TYPE
Transfer:<TSF_EXT_ID> has no destination type information.	Transfer destination type is either null or an invalid value.	TSF_DEST_TYPE
Transfer:<TSF_EXT_ID> Item:<ITEM_ID> is not ranged for source.	Item is not ranged for the source.	TSF_LINE_ITEM TSF_SRC
Transfer:<TSF_EXT_ID> Item:<ITEM_ID> is not ranged for destination.	Item is not ranged for the destination.	TSF_LINE_ITEM TSF_DEST

Table L-7 3. Allocation

Error	Cause	Data Column with Error
Allocation:<TSF_ALLOCATION_ID> has source information which does not match existing data.	Allocation source is not valid for the existing transaction.	TSF_SRC
Allocation:<TSF_ALLOCATION_ID> has invalid source information.	Allocation source is either null or not a valid value.	TSF_SRC
Allocation:<TSF_ALLOCATION_ID> has invalid destination information.	Allocation destination is either null or not a valid value.	TSF_DEST
Allocation:<TSF_ALLOCATION_ID> Item:<ITEM_ID> is not ranged for source.	Item is not ranged to the allocation source.	TSF_LINE_ITEM TSF_SRC
Allocation:<TSF_ALLOCATION_ID> Item:<ITEM_ID> is not ranged for destination.	Item is not ranged to the allocation destination.	TSF_LINE_ITEM TSF_DEST

Table L-7 (Cont.) 3. Allocation

Error	Cause	Data Column with Error
Allocation:<TSF_ALLOCATION_ID> has invalid status code.	Allocation status is not valid.	TSF_STATUS
Allocation:<TSF_ALLOCATION_ID> has status which does not match the existing data.	Allocation status does not match to the existing transaction status.	TSF_STATUS
Allocation:<TSF_ALLOCATION_ID> has no expected quantity.	Allocation quantity is null.	TSF_LINE_EXPECTED

Table L-8 4. Direct Store Delivery (DSD)

Error	Cause	Data Column with Error
DSD ASN is null.	DSD ASN is null.	DSD_ASN
DSD:<ASN> has invalid store identifier.	Store identifier is either null or not a valid store.	DSD_STORE
DSD:<ASN> has invalid supplier identifier.	Supplier identifier is either null or not a valid supplier.	DSD_SUPPLIER
DSD:<ASN> has invalid status code.	Delivery status is either null or not a valid status value.	DSD_STATUS
DSD:<ASN> has invalid carrier type code.	Specified Carrier Type value is not valid.	DSD_CARRIER_TYPE
DSD:<ASN> has store identifier which doesn't matches to existing delivery.	Store identifier does not match to the existing delivery transaction.	DSD_STORE
DSD:<ASN> has supplier identifier which doesn't matches to existing delivery.	Supplier identifier does not match to the existing delivery transaction.	DSD_SUPPLIER
DSD:<ASN> has invalid status code for existing delivery.	Status code is either null or an invalid value for an existing delivery.	DSD_STATUS
DSD:<ASN> has status which does not match the existing data.	Status code does not match the current status of the existing delivery transaction.	DSD_STATUS
DSD:<ASN> is in <DELV_STATUS> status and has one or more container in open state.	Delivery is currently in received status however few container records are in open state on import data.	DSD_STATUS DSD_CARTON_STATUS
DSD:<ASN> is in <DELV_STATUS> status and has one or more container in open or completed state.	Delivery is in cancel/rejected status however few of the containers on delivery are either completed or open.	DSD_STATUS DSD_CARTON_STATUS
DSD:<ASN> Container Identifier is null or invalid.	Container identifier is either null or an invalid value.	DSD_CARTON_EXT_ID
DSD Container:<CARTON_EXT_ID> has invalid status code.	Container status is either null or invalid value for status.	DSD_CARTON_STATUS

Table L-8 (Cont.) 4. Direct Store Delivery (DSD)

Error	Cause	Data Column with Error
DSD Container:<CARTON_EXT_ID> has invalid store identifier.	Container store is either null or not a valid store.	DSD_CARTON_STORE
DSD Container:<CARTON_EXT_ID> has store identifier which doesn't match to delivery information.	Container store does not match the delivery store identifier.	DSD_CARTON_STORE DSD_STORE
DSD Container:<CARTON_EXT_ID> has store identifier which doesn't matches to existing carton.	Container store does not match to the store identifier for an existing container.	DSD_CARTON_STORE
DSD Container:<CARTON_EXT_ID> has invalid status code.	Container status value is either null or not a valid status value.	DSD_CARTON_STATUS
DSD Container:<CARTON_EXT_ID> has status which does not match the existing data.	Container status does not match the status of existing container.	DSD_CARTON_STATUS
DSD Container:<CARTON_EXT_ID> has invalid order related code.	Order Related flag has an invalid code.	DSD_CARTON_CUST_ORD_RELATED
DSD Line Item:<ITEM_ID> is not ranged for store.	Item is not ranged to the store.	DSD_LINE_ITEM DSD_LINE_STORE
DSD Line Item:<ITEM_ID> is not ranged for supplier.	Item is not ranged to the supplier.	DSD_LINE_ITEM DSD_SUPPLIER
DSD Line Item:<ITEM_ID> has invalid store identifier.	Store identifier for line item is either null or not a valid store.	DSD_LINE_ITEM DSD_LINE_STORE
DSD Line Item:<ITEM_ID> has store identifier which does not match to carton information.	Store identifier for line item does not match to the container store identifier.	DSD_LINE_STORE DSD_CARTON_STORE
DSD Line Item:<ITEM_ID> has invalid purchase order identifier.	Purchase Order external identifier for line item is not valid.	DSD_LINE_PO_EXT_ID
DSD Line Item:<ITEM_ID> has store identifier which does not match to existing line item information.	Store identifier for line item does not match the store identifier for an existing line item.	DSD_LINE_STORE
DSD Adjustment Item:<ITEM_ID> is not ranged for store.	Adjustment Item is not ranged to the store.	DSD_ADJ_ITEM DSD_STORE
DSD Adjustment Item:<ITEM_ID> is not ranged for supplier.	Adjustment Item is not ranged to the supplier.	DSD_ADJ_ITEM DSD_SUPPLIER
DSD Adjustment Item:<ITEM_ID> has invalid purchase order external identifier.	Adjustment Item has an invalid purchase order identifier.	DSD_ADJ_PO_EXT_ID
DSD Adjustment Item:<ITEM_ID> has invalid adjustment date.	Adjustment data is set to null.	DSD_ADJ_DATE

Table L-8 (Cont.) 4. Direct Store Delivery (DSD)

Error	Cause	Data Column with Error
DSD Adjustment Item:<ITEM_ID> has invalid adjustment quantity.	Adjustment quantity is not specified.	DSD_ADJ_QUANTITY

Additional Details for BDI CLI File Imports

This section is only applicable if you choose to use BDI CLI File Transmitter to transport the data file. You may skip this section if you choose BDI External Process Flow for data transportation.

Transaction Interface Specifications

DSD Interface Specification

Name	Type	Optional (Null?)	Description
BDI_DATASET_ACTION	VARCHAR2(20)	No	The required record action type, valid values are: REPLACE
DSD_ASN	VARCHAR2(128)	No	The advanced shipping notification identifier that is associated with the direct delivery.
DSD_STORE	NUMBER(10,0)	Yes	The unique identifier of the store that this direct delivery is for.
DSD_SUPPLIER	NUMBER(10,0)	Yes	The unique identifier of the supplier that shipped the items.
DSD_STATUS	NUMBER(4,0)	Yes	The current status of the direct delivery. The valid values: 0 - New, 1 - In Progress, 2 - Received, 3 - Canceled, 4 - Rejected, 9999 - Active.
DSD_EXPECTED_DATE	TIMESTAMP(6)	Yes	The expected date of the delivery.
DSD_CREATE_DATE	TIMESTAMP(6)	Yes	The date the direct delivery record was created.
DSD_UPDATE_DATE	TIMESTAMP(6)	Yes	The date the direct delivery was last updated.
DSD_RECEIVED_DATE	TIMESTAMP(6)	Yes	The received date of the Delivery.
DSD_INVOICE	VARCHAR2(128)	Yes	The unique identifier of the invoice that this direct delivery is associated to, as entered by the user.
DSD_INVOICE_DATE	TIMESTAMP(6)	Yes	The date of the invoice as entered by the user.
DSD_CREATE_USER	VARCHAR2(128)	Yes	The user who created the Delivery.
DSD_CUST_ORD_ID	VARCHAR2(128)	Yes	The customer order identifier.
DSD_FUL_ORD_EXT_ID	VARCHAR2(128)	Yes	The fulfillment order external identifier.
DSD_CARRIER_ENTITY	VARCHAR2(128)	Yes	The carrier name.
DSD_CARRIER_TYPE	NUMBER(2,0)	Yes	Indicate carrier type, 0 - Corporate, 1 - Third Party

Name	Type	Optional (Null?)	Description
DSD_CARRIER_CODE	VARCHAR2(4)	Yes	Unique code identifier for a carrier.
DSD_COUNTRY_CODE	VARCHAR2(3)	Yes	The Country code.
DSD_SOURCE_ADDRESS	VARCHAR2(1000)	Yes	The address of source sending delivery.
DSD_LICENSE_PLATE	VARCHAR2(128)	Yes	The license plate.
DSD_FREIGHT_ID	VARCHAR2(128)	Yes	The freight identifier.
DSD_CURRENCY_CODE	VARCHAR2(3)	Yes	The currency code.
DSD_INVOICE_COST	NUMBER(12,4)	Yes	The invoice cost value.
DSD_RECEIVED_USER	VARCHAR2(128)	Yes	The user who received the delivery.
DSD_UPDATE_USER	VARCHAR2(128)	Yes	The user who last updated the delivery.
DSD_BOL_EXT_ID	VARCHAR2(128)	Yes	The Delivery Bill Of Lading from external system or entered by SIM user.
DSD_ADJ_PO_EXT_ID	VARCHAR2(128)	Yes	The purchase order external identifier.
DSD_ADJ_ITEM	VARCHAR2(25)	Yes	The receiver unit adjustment item identifier.
DSD_ADJ_DATE	TIMESTAMP(6)	Yes	The receiver unit adjustment date.
DSD_ADJ_QUANTITY	NUMBER(20,4)	Yes	The receiver unit adjustment quantity.
DSD_CARTON_EXT_ID	VARCHAR2(128)	Yes	The unique external identifier of the container.
DSD_CARTON_STATUS	NUMBER(4,0)	Yes	Container status. valid values- 1 - New, 2 - In Progress, 3 - Submitted, 4 - Received, 5 - Damaged, 6 - Missing, 7 - Canceled
DSD_CARTON_STORE	NUMBER(10,0)	Yes	The unique store identifier to which container is associated to.
DSD_CARTON_REFERENCE_ID	VARCHAR2(128)	Yes	The reference identifier.
DSD_CARTON_DAMAGED_REASON	VARCHAR2(128)	Yes	The reason for container damage.
DSD_CARTON_SERIAL_CODE	NUMBER(18,0)	Yes	The serial code.
DSD_CARTON_TRACKING_NUMBER	VARCHAR2(128)	Yes	The Tracking number for the container.
DSD_CARTON_DAMAGE_REMAINING	VARCHAR2(1)	Yes	Indicates all remaining quantities should be damaged on final receipt.
DSD_CARTON_CREATE_USER	VARCHAR2(128)	Yes	The user who created the direct delivery container.
DSD_CARTON_UPDATE_USER	VARCHAR2(128)	Yes	The user who last updated the direct delivery container.
DSD_CARTON_RECEIVE_USER	VARCHAR2(128)	Yes	The user who received the direct delivery container.

Name	Type	Optional (Null?)	Description
DSD_CARTON_CREATE_DATE	TIMESTAMP(6)	Yes	The date when the direct delivery container was created.
DSD_CARTON_UPDATE_DATE	TIMESTAMP(6)	Yes	The date when the direct delivery container was updated.
DSD_CARTON_RECEIVE_DATE	TIMESTAMP(6)	Yes	The date when the direct delivery container was received.
DSD_CARTON_UIN_REQUIRED	VARCHAR2(1)	Yes	Indicates whether the container has uin items. Valid values: Y or N.
DSD_CARTON_RCV_AT_SHOP_FLOOR	VARCHAR2(1)	Yes	Indicates whether the inventory on container is to be received at shop floor. Valid values: Y or N.
DSD_CARTON_QUALITY_CONTROL	VARCHAR2(1)	Yes	Used to flag containers that require detailed receiving.
DSD_CARTON_EXTERNAL_CREATE	VARCHAR2(1)	Yes	Indicates whether the delivery is external created. Valid values: Y or N.
DSD_CARTON_ADJUSTED	VARCHAR2(1)	Yes	Indicates whether the delivery is adjusted. Valid values: Y or N.
DSD_CARTON_CUST_ORD_RELATED	VNUMBER(4,0)	Yes	Indicates if container contains customer order items. 1 - Yes, 2 - Mix, 3 - No
DSD_LINE_ITEM	VARCHAR2(25)	Yes	The unique identifier of the item that is contained in this container.
DSD_LINE_CASE_SIZE	NUMBER(10,2)	Yes	The number of units in the case that this item was shipped in.
DSD_LINE_EXPECTED	NUMBER(20,4)	Yes	The total number of units expected in this direct delivery.
DSD_LINE_RECEIVED	NUMBER(20,4)	Yes	The total number of units received in this direct delivery.
DSD_LINE_DAMAGED	NUMBER(20,4)	Yes	The total number of units that were damaged when the direct delivery was received.
DSD_LINE_UNIT_COST_CURR	VARCHAR2(3)	Yes	The unit cost currency code for the line item.
DSD_LINE_UNIT_COST_VAL	NUMBER(12,4)	Yes	The unit cost value for the line item.
DSD_LINE_OVRD_UNIT_COST_CURR	VARCHAR2(3)	Yes	The override unit cost currency.
DSD_LINE_OVRD_UNIT_COST_VAL	NUMBER(12,4)	Yes	The override unit cost value.
DSD_LINE_STORE	NUMBER(10,0)	Yes	The store identifier.
DSD_LINE_PO_EXT_ID	VARCHAR2(128)	Yes	The purchase order external identifier.
DSD_LINE_CUST_ORD_ID	VARCHAR2(128)	Yes	The customer order identifier.
DSD_LINE_FUL_ORD_EXT_ID	VARCHAR2(128)	Yes	The fulfillment order external identifier.
DSD_LINE_VPN	VARCHAR2(256)	Yes	The vendor product number.

Name	Type	Optional (Null?)	Description
DSD_LINE_RECEIVED_OVER	NUMBER(20,4)	Yes	Amount of received inventory over the expected quantities.
DSD_LINE_DAMAGED_OVER	NUMBER(20,4)	Yes	Amount of damaged inventory over the expected quantities.
DSD_LINE_PREV_RECEIVED	NUMBER(20,4)	Yes	Units previous received when container is reopened for adjustment.
DSD_LINE_PREV_DAMAGED	NUMBER(20,4)	Yes	Units previous received as damaged when container is reopened for adjustment.

DSD Sample Data File

Comma Delimited File with fields defined (see Interface Definitions)

```
"REPLACE", "ASN-EXT_PO_0", 4241, 770, 1, , 2022-04-15
11:00:00.000000000, 2022-04-15
11:00:00.000000000, , "SIM", "SIM", "US", "USD", ,
"SIM", "EXT_PO_0", "100050005", 2022-04-15
11:00:00.000000000, 20, "COO", "FOE0", 3, "100750010", "US", 1, 10, 0, "USD", 10, "EA", "N",
"COO", "FOE0", 3, "100750010", "US", 1, 10, 0, "USD", 10, "EA", "N",
```

Purchase Order Interface Specification

Purchase Order Sample File

Comma Delimited File with fields defined (see Interface Definitions)

```
"REPLACE", "EXT_PO_1", 4241, "55", 1, 2022-04-07 11:00:00.000000000, 2022-04-07
11:00:00.000000000, 2022-04-07 11:00:00.000000000, "TEST_
USER", "test1", "COO", "FOE0", 3, "100750010", "US", 1, 10, 0, "USD", 10, "EA", "N"
```

Transfer Interface Specification

Name	Type	Optional (Nullable)	Description
BDI_DATASET_ACTION	VARCHAR2(20)	No	The required record action type, valid values are: REPLACE.
TSF_DOC_TYPE	VARCHAR2(2 BYTE)	No	The type of the document type. valid values: T - Transfer, A - Transfer Allocation.
TSF_EXT_ID	VARCHAR2(128 BYTE)	No	The external identifier of transfer/transfer allocation.
TSF_SRC_TYPE	NUMBER(2,0)	Yes	Source location type for transfer/transfer allocation. 1- Store, 3 Warehouse, 4 - Finisher
TSF_SRC	NUMBER(10,0)	Yes	The identifier of the source that will send the items on the transfer / Transfer Allocation.
TSF_DEST_TYPE	NUMBER(2,0)	Yes	Destination location type for the transfer. 1- Store, 3 Warehouse, 4 - Finisher

Name	Type	Optional (Nullable)	Description
TSF_DEST	NUMBER(10,0)	Yes	The identifier of the destination that will receive the items on the transfer.
TSF_STATUS	NUMBER(2,0)	Yes	The status of transfer/transfer_allocation. Valid Transfer Allocation Status: 1 - Approved, 2 - Completed, 3 - Canceled. Transfer Status: 1 - New Request, 2 - Requested, 3 - Request In-Progress, 4 - Rejected Request, 5 - Canceled Request, 6-Transfer In-Progress, 7 - Approved, 8 - In-Shipping, 9 - Completed Transfer, 10 - Canceled Transfer.
TSF_CREATE_USER	VARCHAR2(128 BYTE)	Yes	A person who created a transfer.
TSF_UPDATE_USER	VARCHAR2(128 BYTE)	Yes	The last user to update the transfer.
TSF_APPROVAL_USER	VARCHAR2(128 BYTE)	Yes	The user that approved the transfer.
TSF_CREATE_DATE	TIMESTAMP(6)	Yes	The original or create date of a transfer.
TSF_UPDATE_DATE	TIMESTAMP(6)	Yes	The date the transfer was last updated.
TSF_APPROVAL_DATE	TIMESTAMP(6)	Yes	The date the transfer was approved.
TSF_CONTEXT_ID	NUMBER(18,0)	Yes	The context identifier for Transfer / Transfer Allocation.
TSF_CONTEXT_VALUE	VARCHAR2(25 BYTE)	Yes	This field holds value for Transfer / Transfer Allocation relating to the context type, for example promotion number.
TSF_CUST_ORD_ID	VARCHAR2(128 BYTE)	Yes	Customer order external identifier for transfer.
TSF_FUL_ORD_EXT_ID	VARCHAR2(128 BYTE)	Yes	Fulfillment order external identifier for transfer.
TSF_PARTIAL_DELIVERY_IND	VARCHAR2(1 BYTE)	Yes	Indicate if partial delivery is allowed in transfer.
TSF_AUTH_CODE	VARCHAR2(12 BYTE)	Yes	Authorization code for the transfer.
TSF_NOT_AFTER_DATE	TIMESTAMP(6)	Yes	Date after which the transfer is not valid.
TSF_REQUEST_DATE	TIMESTAMP(6)	Yes	Request date of the transfer.
TSF_REQUEST_USER	VARCHAR2(128 BYTE)	Yes	The user that requested the transfer.
TSF_USE_AVAILABLE	VARCHAR2(1 BYTE)	Yes	Indicates if the transfer is for unavailable stock.
TSF_DELV_SLOT_ID	VARCHAR2(15 BYTE)	Yes	Delivery time slot id for allocation.

Name	Type	Optional (Nullable)	Description
TSF_DELIVERY_DATE	TIMESTAMP(6)	Yes	The date that the allocation is expected to be delivered from the warehouse.
TSF_LINE_ITEM	VARCHAR2(25 BYTE)	Yes	The identifier of the item that this allocation/transfer is for.
TSF_LINE_DIST_PARENT_ID	VARCHAR2(25 BYTE)	Yes	A unique identifier of the parent transfer document that is associated to this allocation.
TSF_LINE_CASE_SIZE	NUMBER(10,2)	Yes	The size of the transfer item pack.
TSF_LINE_EXPECTED	NUMBER(20,4)	Yes	The total number of units expected for this allocation.
TSF_LINE_RECEIVED	NUMBER(20,4)	Yes	The total number of units received for this allocation/transfer.
TSF_LINE_DAMAGED	NUMBER(20,4)	Yes	The total number of units that were damaged for this allocation/transfer.
TSF_LINE_REQUESTED	NUMBER(20,4)	Yes	Requested quantity for the transfer.
TSF_LINE_APPROVED	NUMBER(20,4)	Yes	Approved quantity for the transfer.
TSF_LINE_SHIPPING	NUMBER(20,4)	Yes	Shipping quantity for the transfer.
TSF_LINE_SHIPPED	NUMBER(20,4)	Yes	Shipped quantity for the transfer.
TSF_LINE_PREFERRED_UOM	VARCHAR2(4 BYTE)	Yes	Preferred unit of measure of the transfer line item.

Transfer Sample File

Comma Delimited File with fields defined (see Interface Definitions)

```
"REPLACE", "T", "EXT_TSF_1", 1, 4241, 1, 5251, 1, "TEST_USER", "TEST_USER", "TEST_USER", 2022-04-07 11:00:00.000000000, 2022-04-07 11:00:00.000000000, 2022-04-07 11:00:00.000000000, 1, "PROM_TSF", "CO1", "FOE1", "Y", "AUTH_1234", 2022-04-07 11:00:00.000000000, 2022-04-07 11:00:00.000000000, "TEST_USER", "Y", "", "100050005", "", 1, 0, 0, 100, 100, 0, 0, "EA"
```

Setup BDI CLI File Transmitter Tool

This section describes steps to install the BDI Transmitter CLI for 64-bit Linux, using an archive binary file (.zip), the configurations include the Open Transaction Modules from external systems.

For additional BDI CLI Transmitter CLI overview and usages, see RICS documentation:

[Oracle® Retail Bulk Data Integration Cloud Service Implementation Guide](#)

1. Download CLI Transmitter

Download the BdiCliTransmitter<version>ForAll<version>Apps_eng_ga.zip.

The archive binary can be installed in any location that you can write to.

2. Set CLI tool installation directory

Change directory to the location where you would like transmitter to be installed.
Move the .zip archive binary to the current directory.

3. Unpack the transmitter

Unpack the zip and install the Transmitter.

```
unzip BdiCliTransmitter<version>ForAll<version>Apps_eng_ga.zip
```

You may delete the .zip file if you want to save disk space.

4. Modify bdi-file-transmitter.properties:

...

```
source.system.name=EXT
```

```
sim.receiver.url=https://<ext-lb>  
/sim-batch-job-admin/resources/receiver
```

```
sim.receiver.url.useralias=simReceiverUrlUserAlias
```

```
#list of interface modules
```

```
#interfaceModules=ExtPurchOrder_Tx, ExtDsd_Tx, ExtTsf_Tx
```

```
interfaceModules=ExtPurchOrder_Tx
```

```
#list of interface names
```

```
ExtPurchOrder_Tx.receiver.appname=sim
```

```
ExtPurchOrder_Tx.dataset.type=PARTIAL
```

```
ExtPurchOrder_Tx.interfaceShortNames=Ext_Purch_Order
```

```
ExtPurchOrder_Tx.Ext_Purch_Order.input.filepath=  
/data-files/po
```

```
#ExtDsd_Tx.receiver.appname=sim
```

```
#ExtDsd_Tx.dataset.type=PARTIAL
```

```
#ExtDsd_Tx.interfaceShortNames=Ext_Dsd
```

```
#ExtDsd_Tx.Ext_Dsd.input.filepath=/data-files/dsd
```

```
#ExtTsf_Tx.receiver.appname=sim
```

```
#ExtTsf_Tx.dataset.type=PARTIAL
```

```
#ExtTsf_Tx.interfaceShortNames=Ext_Tsf
```

```
#ExtTsf_Tx.Ext_Tsf.input.filepath=/data-files/tsf
```

(Notes: Based on your integration need, you can uncomment out the modules you want to seed into receiver app).

5. Set JAVA_HOME environment variable

For example,

```
export JAVA_HOME=/vol.rtk/java/oracle_linux/jdk1.8.0_66.64bit
```

6. Setup credential

```
$ ./bdi-file-transmitter.sh -setup-credentials
```

On prompt, enter receiver user

Where the receiver is assigned BdiEdgeSimJobOperatorGroup in IDCS), for example, simbdioperator

(Notes: if you add a new module or modify the transmitter properties, you need to run `./ bdi-file-transmitter.sh -setup-credentials`)

7. Get Interface Metadata

```
$ ./bdi-file-transmitter.sh -get-interface-metadata sim
```

(Notes: to verify the `Module>_metadata.json` generated correctly, please check the contents of the metadata json file contains the interface table definition, which is located at `<bdi-cli-transmitter>/conf/meta-data/sim`

If the metadata json contains empty columns for specific interfaces, inspect the interface names in the returned `<module>_metadata.json` file to see if there is an empty space. If there is an empty space, then you need to remove the empty space in `bdi-file-transmitter.properties`, and then bounce the sim-bdi server to remove the metadata cache, and then re-execute the get metadata step)

Run BDI CLI File Transmitter

1. Place the data file into the location listed in the `bdi-file-transmitter.properties`

2. Run transmitter as below:

```
$ ./bdi-file-transmitter.sh -m <interfaceModuleName>
```

For example:

```
$ ./bdi-file-transmitter.sh -m ExtPurchOrder_Tx
```

3. Review the Receiver log

Login to BDI `sim-batch-job-admin` console -> navigate to System Logs -> Find the Receiver Log (for example, `<sourceSystem>_ExtPurchaseOrder_Tx_ReceiverService-bdi-server-system.log`)

Note down the source data set id (you will need the data set id later in Importer Job step).

Figure L-1 Source Data Set

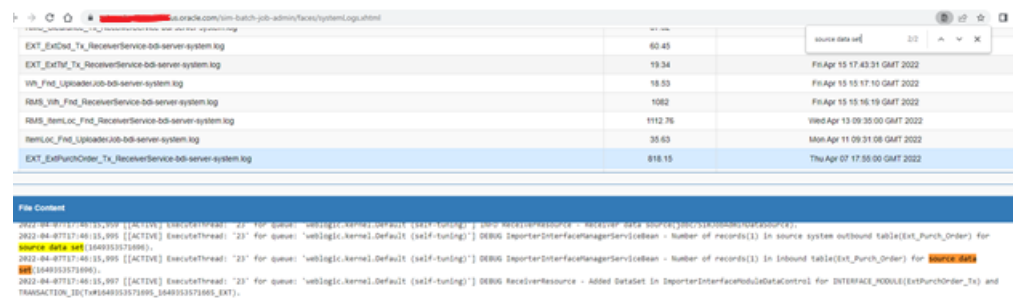

Run Importer Job

To run the importer job, follow these steps:

Once the BDI process is completed, you can load data from EICS inbound stage tables into the application tables.

To load stage data to application tables:

From Main Menu, navigate to **Admin/Technical Maintenance/Job Admin**.

The job would be available for the Admin user who is authorized to access/run the Data Seeding batch processes via EICS user interface. User will need to navigate to following screen to access and run these batch processes.

1. Login to EICS via browser
2. On **Navigation** menu select **Admin/ Technical Maintenance/Job Admin/Data Seed**.

User will be taken to **Data Seed** screen.

3. Select the desired **Importer** job from drop down list:

The supported BDI Open Transaction Imports are:

- Third Party Purchase Order Import
- Third Party Transfer Import
- Third Party Vendor Delivery Import

4. Enter the data set identifier.

Note: The data set id is required if importer data is not coming from BDI Process Flow. When importer data is coming from BDI CLI tool, user would need to find the dataset id for running the importer. The receiver source data set id can be identified via BDI SIM Job admin log.

5. Click on **Start Job**.
6. View **Importer Job Execution**:

Login SIOCS JET UI, navigate to **Job Admin** screen

By default, the job admin screen lists the failed job execution. To view the completed importer job, you may need to filter the job status by selecting the job status.

To view job execution details, user can click on the job execution link and navigate to the detail screen to see the exact reason of failure.

Appendix: Third Party Pricing Integration

Overview

By default, EICS integrate with RPCS clearance and regular price change via BDI process flow.

EICS does not integrate with Promotion Offer interface due to it does not provide pricing at item/date level, so there is nothing for SIOCS to consume.

As an alternative, SIOCS does have a generic pricing interface for the retailer to integrate promotion price into.

Third Party Pricing Import provides a generic pricing interface for retailer which can provide pricing data for EICS pricing imports from third party. This third-party pricing import provides an alternative for import promotion data into EICS.

BDI Implementation Considerations

To load third-party data into EICS via BDI, the external system needs to provide data sourcing implementations.

There are two approaches for data sourcing implementations, Integration Implementer may choose the data provider implementations based on their need.

Option A: Third Party Pricing Integration Via BDI External Process Flow Implementation

Figure M-1 BDI Process Flow Process



The BDI process:

- An Extractor extracts data from a data producing system into an outgoing intermediate integration interface table.
- A Downloader and transporter services data to receiver service.
- An Uploader uploads the data to an incoming intermediate integration interface table.

- An Importer imports the data from the interface stage tables into SIOCS application tables.

For more information about data seeding, see [Data Seeding](#).

With this approach, the BDI Ext Process Flow will move the data from sourcing system to destination system's application table. BDI process flow provides BDI job scheduling, end to end data transportation from sourcing system's database table into destination application's tables.

Customers need to implement the BDI Ext-EdgeApp to move data into the BDI outbound interface table.

BDI Process Flow: ExtPrice_Tx_ProcessFlow_From_EXTERNAL

See Oracle Retail Enterprise Integration Overview Guide: BDI Third Party Integrations.

Option B: Third Party Pricing Integration Via BDI CLI File Transmitter

BDI CLI File Transmitter is a client command line tool, is applicable for smaller data file size which does not require concurrent processing.

BDI CLI file transmitter only transport data files from sourcing systems to destination system's interface tables. It does not provide end to end data transportation. If you choose BDI CLI File transmitter for load third party data into EICS application table, it will require three steps:

Figure M-2 BDI CLI File Transmitter

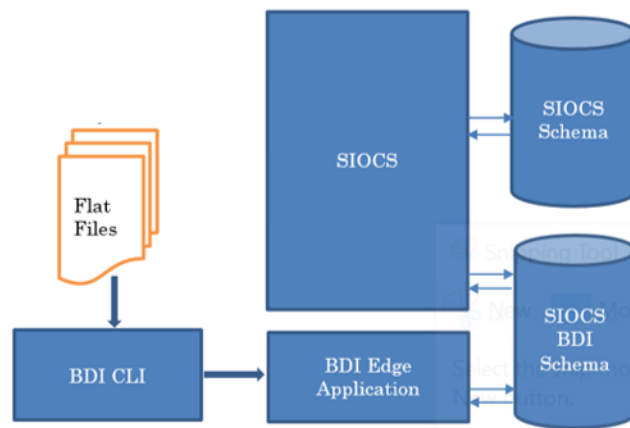

- Download BDI CLI File Transmitter and install on customer's system.
- Run BDI CLI Transmitter batch to load data file from sourcing system into destination system's interface table.
- Once the data are loaded into receiver app's inbound interface tables, EICS's importer job will move the data from inbound interface table into EICS app tables.

Note: By default, batch scheduler Third Party Price Import in EICS is disabled; this job should only be enabled if you choose to use BDI CLI File transmitter for data sourcing provider.

See [Integration](#).

This section provides BDI CLI File Transmitter as an implementation to describe how to import third party pricing into EICS via BDI CLI File Transmitter.

Third Party Pricing Import via BDI CLI File Transmitter

Each file contains price records for a single store, store/item/action date uniquely identify a pricing record.

1. BDI CLI File Transmitter Process

The BDI CLI Transmitter process load data files to an intermediate BDI inbound tables in SIOCS BDI Schema.

Once the records are created on the SIOCS BDI table, BDI process also create a control record for the module and interface for importer to process. The module interface along with the data set id will be used by importer to identify the records to be imported into the EICS in importer process.

See [Appendix: BDI Transmitter CLI Procedure - Load External Data File](#) for details on how to run BDI CLI File Transmitter.

Sample bdi-file-transmitter.properties for ExtPrice_Tx Module:

```
...
source.system.name=ext-source
sim.receiver.url=https://<bdi-sim-app-hostname>:<port>/sim-batch
-job-admin/resources/receiver
sim.receiver.url.useralias=simReceiverUrlUserAlias
interfaceModules=ExtPrice_Tx
ExtPrice_Tx.receiver.appname=sim
ExtPrice_Tx.dataset.type=PARTIAL
ExtPrice_Tx.interfaceShortNames=Ext_Price
ExtPrice_Tx.Ext_Price.input.filepath=/home/bdi/ext_price_tx/ext_
price/files
```

2. EICS Importer Process

Once the file data is loaded into the SIOCS BDI inbound interface table, the importer process will process the BDI interface tables into SIOCS application tables. You can setup SIOCS Batch job schedule to import data from inbound interface tables into EICS application tables. For importer details, see Third Party Pricing Import in batch chapter for details.

3. Job Scheduling

You can schedule EICS job scheduler to start the third-party price TX importer job automatically, or You can run importer as adhoc job.

By default, EICS batch scheduling for third party pricing TX import job is disabled, as for customers who choose BDI External Process Flow for third party pricing end to end integration, the BDI Job scheduler should be used.

4. Error Handling and Logging

When the job execution failed, only the failed record reference ids are stored in the BATCH_DATA_DETAIL table, the data which are successfully processed are removed from the BDI inbound table. Sys ops user can view the batch detail errors via EICS Job

admin console. The number of maximum errors (for example 10 errors) per partition are logged for each batch/partition run.

External Price File Layout

Field Name	Description	Required	Type
BDI_DATASET_ACTION	EICS only support REPLACE OR DELETE as dataset action for third party pricing. UPDATE type is not supported, use REPLACE for updating a record.	Yes	CHAR(20)
ITEM_ID	The unique alphanumeric value for the transaction level item.	Yes	CHAR(25)
STORE_ID	The number that uniquely identifies the store.	Yes	Number(10)
EFFECTIVE_DATE	The date on which the price change became effective. yyyy-mm-dd hh:mm:ss.ffffff for example, 2021-04-09 11:00:00.000000000	Yes	Timestamp
END_DATE	Promotion or clearance price end date. For price change with an end date, if the clearance indicator is 'Y', the end date is for clearance end date; otherwise, the end date is promotional ending date. yyyy-mm-dd hh:mm:ss.ffffff for example, 2021-04-09 11:00:00.000000000	No	Timestamp
PRICE_TYPE	The item price type. Valid values: 200- Clearance 201- Promotional 202- Regular	Yes	NUMBER(3)
PROMOTION_NAME	Promotion name.	No	CHAR(160)
SELLING_UNIT_RETAIL	Contains the current single unit retail in the selling unit of measure.	Yes	NUMBER(20,4)
SELLING_UOM	Contains the selling unit of measure for an items single-unit retail.	Yes	CHAR(4)
SELLING_UNIT_RETAIL_CURRENCY	Contains the selling unit retail currency.	Yes	CHAR(3)
MULTI_UNITS	Contains the current multi-units. If the record is being written as a result of a change in the multi-unit retail, then this field contains the new multi-units.	No	NUMBER(12,4)
MULTI_UNIT_RETAIL	Contains the current multi-unit retail in the selling unit of measure.	No	NUMBER(20,4)

Field Name	Description	Required	Type
MULTI_UNIT_RETAIL_CURRENCY	Contains the multi-unit retail currency.	No	CHAR(3)
MULTI_UNIT_SELLING_UOM	Contains the selling unit of measure for an items multi-unit retail.	No	CHAR(4)
CREATE_DATETIME	Contains the record creation date. yyyy-mm-dd hh:mm:ss.ffffff for example, 2021-04-09 11:00:00.000000000	No	Timestamp
REC_ID	The id of the record.	Yes	NUMBER(15)
RETAIL_CHANGE_IND	Indicates whether the retail changed with this price change. Valid values are: 0 - retail price not changed 1 - retail price changed	No	NUMBER(6)
MULTI_UNIT_IMPACT	Indicates if the Price Change has impact to Multi Unit retail. Valid values are: AU - Multi Unit information is added or updated R - Multi Unit information is removed N - Multi unit information is not changed.	Yes	CHAR(4)
PRICE_EVENT_ID	The id of the price event.	Yes	NUMBER(15)

Sample CSV File:

ext_price_<YYYYMMDDHHMMSS>.csv

```
"REPLACE", "100637113", 5000, 2021-04-09
11:00:00.000000000, , 202, "", 149.99, "USD", "EA", , , "", "", 2021-04-07
11:00:00.000000000, 1, 1, N, 9999

"REPLACE", "100637148", 5000, 2021-04-09
11:00:00.000000000, , 202, "", 145.99, "USD", "EA", , , "", "", 2021-04-07
11:00:00.000000000, 1, 1, N, 9999
```

File Contents Explanation

- Create CSV file: ext_price_<YYYYMMDDHHMMSS>.csv
- It is expected that the pricing provider to ensure the record uniqueness (A unique record is identified by store/item/effective date time), within a file, each record must be unique. The record action is denoted by action type, only a dataset action is allowed for unique store/item/date.

For example, for store 5000, item A, a price on date 2018 Dec 10 00:00:00 record in the file can be one of the (REPLACE, DELETE), the same record with more than one dataset action will be rejected. EICS only supports REPLACE OR DELETE as dataset action for third party pricing. UPDATE type is not supported, use REPLACE for updating a record.

- To end clearance price: To end a clearance price for a store/item, the pricing provider can either include the end date on the clearance item record; or sending a new price record (regular or promotional).
- The same file can't have two records with this combination store/item/effective with different price type, if clearance need to be on today, then this file should only have a single record for clearance type; to end the clearance (for example, tomorrow), the file need either mark the end date for that clearance or need to include a regular price record with a different effective date (for example, tomorrow).
- In EICS, there is no client UI which needed the prom id, clearance id or price change id. For data import integration backend processing, the record is uniquely identified by item/store/effective date time and price type external pricing change identifier has no meaning to our system. Promotion name is used in EICS as context type, therefore include in the integration interface.
- **Split the Data into Multiple Files**
EICS loads the data in parallel from multiple files. Loading files from multiple files in parallel provides performance advantage than loading from a single file. It is recommended to file provider to split the data into multiple files to load data efficiently in parallel loading, each file contains single store is recommended.

Appendix: Third-Party RFID Integration

Overview

EICS allows import of RFID information via a BDI process flow (ExtRfid_Tx) from a third-party system. The External RFID import is an operational batch which can run as often as needed. This batch is used for importing bulk amount of RFID information. For small handful of RFID tags, RFID Inventory Webservice can be used.

The RFID importer first sets all the present attribute to 'N' for all existing RFID tags at the location thereby removing them from inventory. It then inserts or replaces the RFID data from inbound interface table into RFID table in SIOCS, setting the present attribute to Y (yes) for each RFID tag in the import.

In this fashion, it operates much like a stock count and will generate inventory adjustments for external system to have their SOH updated for any discrepancies found.

BDI Implementation Considerations

To load third-party data into EICS via BDI, external system need to provide data sourcing implementations.

There are two approaches for data sourcing implementations, Integration Implementer may choose the data provider implementations based on their need.

Option A: Third-Party RFID Integration Via BDI External Process Flow Implementation

Figure N-1 BDI Process Flow Process



The BDI process:

- An Extractor extracts data from a data producing system into an outgoing intermediate integration interface table.

- A Downloader and transporter services data to receiver service.
- An Uploader uploads the data to an incoming intermediate integration interface tables.
- An Importer imports the data from the interface stage tables into SIOCS application tables.

For more information about data seeding, see [Data Seeding](#).

With this approach, the BDI Ext Process Flow will move the data from sourcing system to destination system's application table. BDI process flow provides BDI job scheduling, end to end data transportation from sourcing system's database table into destination application's tables.

Customer need to implement the BDI Ext-EdgeApp to move data into the BDI outbound interface table.

BDI Process Flow: ExtRfid_Tx_ProcessFlow_From_EXTERNAL

See *Oracle Retail Enterprise Integration Overview Guide: BDI Third-Party Integrations*.

Option B: Third-Party RFID Integration Via BDI CLI File Transmitter

BDI CLI File Transmitter is a client command line tool, is applicable for smaller data file size which does not require concurrent processing.

BDI CLI file transmitter only transport data files from sourcing systems to destination system's interface tables. It does not provide end to end data transportation. If you choose BDI CLI File transmitter for load third-party data into SIOCS application table, it would require three steps:

Figure N-2 BDI CLI File Transmitter

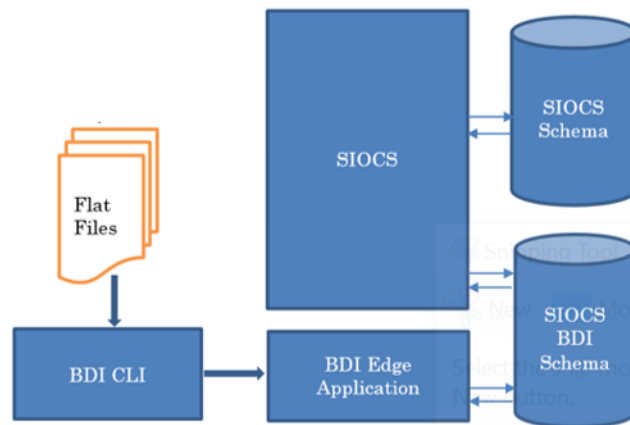

- Download BDI CLI File Transmitter and install on customer's system.
- Run BDI CLI Transmitter batch to load data file from sourcing system into destination system's interface table.
- Once the data are loaded into receiver app's inbound interface tables, EICS's importer job will move the data from inbound interface table into EICS app tables.

Note: By default, batch scheduler Third-Party RFID Import in EICS is disabled; this job should only be enabled if you choose to use BDI CLI File transmitter for data sourcing provider.

See [Integration](#).

This section provides BDI CLI File Transmitter as an implementation to describe how to import third-party RFID into SIOCS via BDI CLI File Transmitter.

Third-Party RFID Import via BDI CLI File Transmitter

Each file contains RFID information for a single store, store/item/action date uniquely identify a RFID record.

1. BDI CLI File Transmitter Process

The BDI CLI Transmitter process load data files to an intermediate BDI inbound tables in SIOCS BDI Schema.

Once the records are created on the SIOCS BDI table, BDI process also create a control record for the module and interface for importer to process. The module interface along with the data set id will be used by importer to identify the records to be imported into the EICS in importer process.

See [Appendix: BDI Transmitter CLI Procedure - Load External Data File](#) for details on how to run BDI CLI File Transmitter.

2. EICS Importer Process

Once the file data is loaded into the SIOCS BDI inbound interface table, the importer process will process the BDI interface tables into SIOCS application tables. You can setup SIOCS Batch job schedule to import data from inbound interface tables into SIOCS application tables. For importer details, see Third-Party RFID Import in batch chapter for details.

3. Job Scheduling

You can schedule EICS job scheduler to start the third-party RFID TX importer job automatically, or you can run importer as adhoc job.

By default, SIOCS batch scheduling for third-party RFID TX import job is disabled, as for customers who choose BDI External Process Flow for third-party RFID end to end integration, the BDI Job scheduler should be used.

4. Error Handling and Logging

When the job execution failed, only the failed record reference ids are stored in the BATCH_DATA_DETAIL table, the data which are successfully processed are removed from the BDI inbound table. Sys ops user can view the batch detail errors via EICS Job admin console. The number of maximum errors (for example 10 errors) per partition are logged for each batch/partition run.

EXT_RFID_IN

Field Name	Description	Required	Type
BDI_SEQ_ID	Bulk Data Integration data sequence.	Yes	NUMBER(19)
BDI_APP_NAME	Bulk Data Integration Application Name.	Yes	VARCHAR2(50)
BDI_DATASET_TYPE	Bulk Data Integration Data Set Type, valid values are FULL, or PARTIAL.	No	VARCHAR2(20)

Field Name	Description	Required	Type
BDI_DATASET_ACTION	EICS only support REPLACE and DELETE as dataset action for third-party RFID, UPDATE type is not supported, use replace for updating a record.	No	VARCHAR2(20)
EPC	Electronic product code (SGTIN-96).	Yes	VARCHAR(256)
ITEM_ID	Identifier of the item/sku.	Yes	VARCHAR2(25)
LOCATION_ID	Location identifier.	Yes	NUMBER(10)
LOCATION_TYPE	Location Type, 1 - store, 2 - warehouse.	Yes	NUMBER(2)
ZONE_ID	The zone within the location that the RFID is located.	No	NUMBER(15)
EVENT_DATE	The timestamp of the RFID read.	No	TIMESTAMP(6)

External RFID CSV File Fields

The CSV data fields matches the non-BDI heading columns in EXT_RFID_IN (four BDI heading columns are: BDI_SEQ_ID, BDI_APP_NAME, BDI_DATASET_TYPE, BDI_DATASET_ACTION).

For example, the first fields in the file would match the fourth column in EXT_RFID_IN table, the second field in the file matches the fifth column in the table.

Sample CSV File:

ext_rfid_<YYYYMMDDHHMMSS>.csv

```
"REPLACE" , "11111111111111111111111111111111" , "100637113" , 5000 , 1 , 1001 ,
"03-07-2021 0:00"
```

```
"REPLACE" , "11111111111111111111111111111112" , "100637148" , 5000 , 2 , 1022 ,
"05-10-2021 0:00"
```

File Contents Explanation

- Create CSV file: ext_rfid_<YYYYMMDDHHMMSS>.csv
- It is expected that the RFID provider to ensure the record uniqueness (A unique record is identified by store/item/effective date time), within a file, each record must be unique. The record action is denoted by action type, only one dataset action is allowed. EICS only support REPLACE OR DELETE as dataset action for third-party rfid, UPDATE type is not supported, use replace for updating a record.
- **Split the Data into Multiple Files**
EICS loads the data in parallel from multiple files. Loading files from multiple files in parallel provides performance advantage than loading from a single file. It is recommended to file provider to split the data into multiple files to load data efficiently in parallel loading, each file contains single store is recommended.
- **Compress the data files**
If data file contains large datasets, it is recommended that compress the load files individually, when load the data file. Use EICS System Configuration Console to specify the file suffix (for example, gzip, or zip).

Appendix: Item Ticket

EICS allows ticket generation and printing from web client as well as MAF client. The ticket created from MAF client can be printed directly to a Bluetooth printer. The set of ticket attributes when printed from a Bluetooth Printer differs from that sent to external web service. The list for each is given below.

Table O-1 Ticket Attributes - Print to Bluetooth Printer

Field Name	Description
item ID	Item Identifier.
shortDescription	Item short description.
longDescription	Item long description.
shortDescriptionLang	The short description in the language of the store.
longDescriptionLang	The long description in the language of the store.
departmentId	Merch hierarchy department Identifier.
departmentName	Merch hierarchy department name.
classId	Merch hierarchy class Identifier.
className	Merch hierarchy class name.
subclassId	Merch hierarchy sub-class Identifier.
subclassName	Merch hierarchy sub-class name.
differentiatorType1	The description of the type for differentiator 1.
differentiatorType2	The description of the type for differentiator 2.
differentiatorType3	The description of the type for differentiator 3.
differentiatorType4	The description of the type for differentiator 4.
differentiator1	The description of differentiator 1.
differentiator2	The description of differentiator 2.
differentiator3	The description of differentiator 3.
differentiator4	The description of differentiator 4.
printQuantity	The quantity to be printed on each ticket.
overridePrice	The override price given while creating the ticket.
printPrice	The ticket price.
printPriceType	The type of the ticket price.
printPriceActiveDate	The date the ticket price became active.

Table O-1 (Cont.) Ticket Attributes - Print to Bluetooth Printer

Field Name	Description
printPriceExpireDate	The date the ticket price expires.
printPriceUom	The unit of measure of the ticket price.
multiUnitPrice	Ticket multi-unit price.
multiUnitPriceUom	The unit of measure of the ticket multi-unit price.
multiUnitQuantity	The multi-unit quantity associated to the price.

Table O-2 Ticket Attributes - Print to Web-service

Field Name	Description
ticketId	Ticket Identifier.
item Id	Item Identifier.
primaryUpc	The Unique Product Code for the item.
originType	The origin type of the ticket. Valid values are: 1- External Batch 2- Price Change, 3- Foundation, 4- Manual
sequenceNumber	The sequence number of a ticket within its grouping.
ticketCount	The number of instances of this ticket to print.
shortDescription	Item short description.
longDescription	Item long description.
shortDescriptionLang	The short description in the language of the store.
longDescriptionLang	The long description in the language of the store.
departmentId	Merch hierarchy department Identifier.
departmentName	Merch hierarchy department name.
classId	Merch hierarchy class Identifier.
className	Merch hierarchy class name.
subclassId	Merch hierarchy sub-class Identifier.
subclassName	Merch hierarchy sub-class name.
differentiatorType1	The description of the type for differentiator 1.
differentiatorType2	The description of the type for differentiator 2.
differentiatorType3	The description of the type for differentiator 3.
differentiatorType4	The description of the type for differentiator 4.
differentiator1	The description of differentiator 1.
differentiator2	The description of differentiator 2.
differentiator3	The description of differentiator 3.
differentiator4	The description of differentiator 4.
printQuantity	The quantity to be printed on each ticket.

Table O-2 (Cont.) Ticket Attributes - Print to Web-service

Field Name	Description
overridePriceCurrency	The currency code of an override price.
overridePriceValue	The currency value of an override price.
priceCurrency	The currency code of the ticket price.
priceValue	The value of the ticket price.
printPriceType	The type of the ticket price.
printPriceActiveDate	The date the ticket price became active.
printPriceExpireDate	The date the ticket price expires.
printPriceUom	The unit of measure of the ticket price.
multiUnitPriceCurrency	The currency code of a ticket multi-unit price.
multiUnitValue	The value of the ticket multi-unit price.
multiUnitPriceUom	The unit of measure of the ticket multi-unit price.
multiUnitQuantity	The multi-unit quantity associated to the price.
countryOfManufacture	A two letter country code denoting the country of manufacture for the item.

Appendix: SFTP File Directory and Filename Format

This section lists the sFTP directories where user can upload and download batch files via sFTP server.

For additional details on sFTP account setup, see *Oracle® Retail Enterprise Inventory Cloud Service Security Guide* Nightly Batch File Uploads and Export File Downloads sections.

File Upload Directory and Filename Format

Table P-1 File Upload Directory and Filename Format

Import File Name	sFTP Directory	Filename Format
Clearance Price Change Import File	User logs into the SFTP server, and transfer data files to the directory: /{sftp user}/from_ thirdparty	<p>Zip Filename Format</p> <p><event type>_<date in YYYYMMDDHH24MISS format>_<loc type>.zip</p> <p>Where event type value is "CLRPC". The loc type field would be either 'S' or 'W'.</p> <p>The zip file can contain one or more files from same or different stores. The complete file needs to be added for zip file for job to pick it for processing.</p> <p>Example: CLRPC_20180129133250_S.zip CLRPC_20180129133250_S.zip.complete</p> <p>Filename Inside Zip</p> <p><event type>_<date in YYYYMMDDHH24MISS format>_<loc id>_<loc type>.dat</p> <p>Where event type value is "CLRPC" (clearances), the loc type field would be either 'S' or 'W'.</p> <p>Example: CLRPC_20180129133250_1111_S.dat</p>
Initial Inventory Import File	User logs into the SFTP server, and transfer data files to the directory: /{sftp user}/from_ thirdparty	<p>Zip Filename Format</p> <p><file prefix>_<date in YYYYMMDDHH24MISS format>.zip</p> <p>Where file prefix value is EXTSTK_. The zip file can contain one or more .date files.</p> <p>The complete file needs to be added for zip file for job to pick it for processing.</p> <p>Example: EXTSTK_20180129133250.zip EXTSTK_20180129133250.zip.complete</p> <p>Filename Inside Zip</p> <p><file prefix>_<date in YYYYMMDDHH24MISS format>_<loc id>.dat</p> <p>Where file prefix value is EXTSTK_ and loc id is the store identifier. This allows file to be unique for every upload.</p> <p>Example: EXTSTK_20180129133250_1111.dat</p>

Table P-1 (Cont.) File Upload Directory and Filename Format

Import File Name	sFTP Directory	Filename Format
POS Sale Transaction Import File	User logs into the SFTP server, and transfer data files to the directory: /{sftp user}/from_ thirdparty	<p>Zip Filename Format</p> <p><file prefix>_<date in YYYYMMDDHH24MISS format>.zip</p> <p>Where file prefix value is "SIMTLOG". The zip file can contain one or more files from same or different stores. The complete file needs to be added for zip file for job to pick it for processing.</p> <p>Example: SIMTLOG_20180129133250.zip SIMTLOG_20180129133250.zip.complete</p> <p>Filename Inside Zip</p> <p><file prefix>_<date in YYYYMMDDHH24MISS format>_<loc id>.dat</p> <p>Where file prefix value is "SIMTLOG" and loc id is the store identifier. This allows file to be unique for every upload.</p> <p>Example: SIMTLOG_20180129133250_1111.dat</p>
Promotion Price Change Import File	User logs into the SFTP server, and transfer data files to the directory: /{sftp user}/from_ thirdparty	<p>Zip Filename Format</p> <p><event type>_<date in YYYYMMDDHH24MISS format>_<loc type>.zip</p> <p>Where event type value is "PRMPC". The loc type field would be either 'S' or 'W'.</p> <p>The zip file can contain one or more files from same or different stores. The complete file needs to be added for zip file for job to pick it for processing.</p> <p>Example: PRMPC_20180129133250_S.zip PRMPC_20180129133250_S.zip.complete</p> <p>Filename Inside Zip</p> <p><event type>_<date in YYYYMMDDHH24MISS format>_<loc id>_<loc type>.dat</p> <p>Where event type is "PRMPC" (promotional price change). The loc type field would be either 'S' or 'W'.</p> <p>Example: PRMPC_20180129133250_1111_S.dat</p>

Table P-1 (Cont.) File Upload Directory and Filename Format

Import File Name	sFTP Directory	Filename Format
Regular Price Change Import File	User logs into the SFTP server, and transfer data files to the directory: /{sftp user}/from_ thirdparty	<p>Zip Filename Format</p> <p><event type>_<date in YYYYMMDDHH24MISS format>_<loc type>.zip</p> <p>Where event type value is "REGPC". The loc type field would be either 'S' or 'W'.</p> <p>The zip file can contain one or more files from same or different stores. The complete file needs to be added for zip file for job to pick it for processing.</p> <p>Example:</p> <p>REGPC_20180129133250_S.zip REGPC_20180129133250_S.zip.complete</p> <p>Filename Inside Zip</p> <p><event type>_<date in YYYYMMDDHH24MISS format>_<loc id>_<loc type>.dat</p> <p>Where event type is "REGPC" (regular price changes). The loc type field would be either 'S' or 'W'.</p> <p>Example:</p> <p>REGPC_20180129133250_1111_S.dat</p>
Retail Sale Audit Import File	Notes: When Retail Sale Audit Import File from MFCS will be auto-pushed to SIOCS sFTP server directory /{sftp user} For third-party provided ReSA file, user logs into the SFTP server, and transfer data files to the directory: /{sftp user}/from_ thirdparty	<p>Zip Filename Format</p> <p><file prefix>_<date in YYYYMMDDHH24MISS format>.zip</p> <p>Where file prefix value is "SIMT". The zip file can contain one or more files from same or different stores. The complete file needs to be added for zip file for job to pick it for processing.</p> <p>Example:</p> <p>SIMT_20180129133250.zip SIMT_20180129133250.zip.complete</p> <p>Filename Inside Zip</p> <p><file prefix>_<date in YYYYMMDDHH24MISS format>_<loc id>.dat</p> <p>Where file prefix value is "SIMT" and loc id is the store identifier. This allows file to be unique for every upload.</p> <p>Example:</p> <p>SIMT_20180129133250_1111.dat</p>

Table P-1 (Cont.) File Upload Directory and Filename Format

Import File Name	sFTP Directory	Filename Format
Store Sequence Data Parser Import File	User logs into the SFTP server, and transfer data files to the directory: /{sftp user}/from_ thirdparty	<p>Zip Filename Format</p> <p><file prefix>_<date in YYYYMMDDHH24MISS format>.zip</p> <p>Where file prefix value is "SSEQ". The zip file can contain one or more files from same or different stores. The complete file needs to be added for zip file for job to pick it for processing.</p> <p>Example: SSEQ_20180129133250.zip SSEQ_20180129133250.zip.complete</p> <p>Filename Inside Zip</p> <p><file prefix>_<date in YYYYMMDDHH24MISS format>_<loc id>.dat</p> <p>Where file prefix value is "SSEQ" and loc id is the store identifier. This allows file to be unique for every upload.</p> <p>Example: SSEQ_20180129133250_1111.dat</p>
Third Party Stock Count Parser Import File	User logs into the SFTP server, and transfer data files to the directory: /{sftp user}/from_ thirdparty	<p>Zip Filename Format</p> <p><file prefix>_<date in YYYYMMDDHH24MISS format>.zip</p> <p>Where file prefix value is STK. The zip file can contain one or more .date files (for example, STK_20180129133250_1111.dat).</p> <p>The complete file needs to be added for zip file for job to pick it for processing.</p> <p>Example: STK_20180129133250.zip STK_20180129133250.zip.complete</p> <p>Filename Inside Zip</p> <p><file prefix>_<date in YYYYMMDDHH24MISS format>_<loc id>.dat</p> <p>Where file prefix value is STK and loc id is the store identifier. This allows file to be unique for every upload.</p> <p>Example: STK_20180129133250_1111.dat</p>
Warehouse Stock Import File	User logs into the SFTP server, and transfer data files to the directory: /{sftp user}/from_ thirdparty	<p>Zip Filename Format</p> <p><file prefix>_<date in YYYYMMDDHH24MISS format>.zip</p> <p>Where file prefix value is "WHIMS". The zip file can contain one or more files. The complete file needs to be added for zip file for job to pick it for processing.</p> <p>Example: WHIMS_20180129133250.zip WHIMS_20180129133250.zip.complete</p> <p>Filename Inside Zip</p> <p><file prefix>_<date in YYYYMMDDHH24MISS format>.dat</p> <p>Where file prefix value is "WHIMS". The prefix and date combination allows file to be unique for every upload.</p> <p>Example: WHIMS_20180129133250_1111.dat</p>

File Download Directory and Filename Format

Table P-2 File Download Directory and Filename Format

Export File Name	sFTP Directory	Filename Format
Inventory Extract	User logs into the SFTP server, and download data files from directory: /{sftp user}/EXPORT/to_thirdparty	<file prefix>_<store Id>_<extract date in yyyyMMddHHmmss>.TXT Where file prefix value is PRODUCT_LOCATION_INV, store Id is the store identifier. Example: PRODUCT_LOCATION_INV_1111_20180129133250.TXT PRODUCT_LOCATION_INV_1111_20180129133250.TXT.complete
Stock Count Export File	When Stock count is unit and amount and authorization succeeded, the stock count authorize process attempts to create an export file. By default, SIOCS system stock count export file is sent to MFCS sFTP server when sftp push is enabled, and stock count export system configuration is as /<mfcsFtpUser> From where, MFCS batch will process the stock count file.	Zip Filename Format <file prefix>_<store id>_<stock count schedule date in yyyyMMddHHmmss>_<export date in yyyyMMddHHmmss>.zip Where file prefix value is STK_. The zip file can contain one or more .date files. The complete file is added for job to pick it for processing. Example: STK_1111_20180128133250_20180129133250.zip STK_1111_20180128133250_20180129133250.zip.complete Filename Inside Zip <file prefix>_<store id>_<stock count schedule date in yyyyMMddHHmmss>_<export date in yyyyMMddHHmmss>.DAT The complete file is added for job to pick it for processing. Example: STK_1111_20180128133250_20180129133250.dat