

Oracle® Retail Enterprise Inventory Cloud Service

User Guide

Release 19.5

F55426-01

April 2022

This software and related documentation are provided under a license agreement containing restrictions on use and disclosure and are protected by intellectual property laws. Except as expressly permitted in your license agreement or allowed by law, you may not use, copy, reproduce, translate, broadcast, modify, license, transmit, distribute, exhibit, perform, publish, or display any part, in any form, or by any means. Reverse engineering, disassembly, or decompilation of this software, unless required by law for interoperability, is prohibited.

The information contained herein is subject to change without notice and is not warranted to be error-free. If you find any errors, please report them to us in writing.

If this is software or related documentation that is delivered to the U.S. Government or anyone licensing it on behalf of the U.S. Government, then the following notice is applicable:

U.S. GOVERNMENT END USERS: Oracle programs, including any operating system, integrated software, any programs installed on the hardware, and/or documentation, delivered to U.S. Government end users are "commercial computer software" pursuant to the applicable Federal Acquisition Regulation and agency-specific supplemental regulations. As such, use, duplication, disclosure, modification, and adaptation of the programs, including any operating system, integrated software, any programs installed on the hardware, and/or documentation, shall be subject to license terms and license restrictions applicable to the programs. No other rights are granted to the U.S. Government.

This software or hardware is developed for general use in a variety of information management applications. It is not developed or intended for use in any inherently dangerous applications, including applications that may create a risk of personal injury. If you use this software or hardware in dangerous applications, then you shall be responsible to take all appropriate fail-safe, backup, redundancy, and other measures to ensure its safe use. Oracle Corporation and its affiliates disclaim any liability for any damages caused by use of this software or hardware in dangerous applications.

Oracle and Java are registered trademarks of Oracle and/or its affiliates. Other names may be trademarks of their respective owners.

Intel and Intel Xeon are trademarks or registered trademarks of Intel Corporation. All SPARC trademarks are used under license and are trademarks or registered trademarks of SPARC International, Inc. AMD, Opteron, the AMD logo, and the AMD Opteron logo are trademarks or registered trademarks of Advanced Micro Devices. UNIX is a registered trademark of The Open Group.

This software or hardware and documentation may provide access to or information about content, products, and services from third parties. Oracle Corporation and its affiliates are not responsible for and expressly disclaim all warranties of any kind with respect to third-party content, products, and services unless otherwise set forth in an applicable agreement between you and Oracle. Oracle Corporation and its affiliates will not be responsible for any loss, costs, or damages incurred due to your access to or use of third-party content, products, or services, except as set forth in an applicable agreement between you and Oracle.

Value-Added Reseller (VAR) Language

Oracle Retail VAR Applications

The following restrictions and provisions only apply to the programs referred to in this section and licensed to you. You acknowledge that the programs may contain third-party software (VAR applications) licensed to Oracle. Depending upon your product and its version number, the VAR applications may include:

- (i) the **MicroStrategy** Components developed and licensed by MicroStrategy Services Corporation (MicroStrategy) of McLean, Virginia to Oracle and imbedded in the MicroStrategy for Oracle Retail Data Warehouse and MicroStrategy for Oracle Retail Planning & Optimization applications.
- (ii) the **Wavelink** component developed and licensed by Wavelink Corporation (Wavelink) of Kirkland, Washington, to Oracle and imbedded in Oracle Retail Mobile Store Inventory Management.
- (iii) the software component known as **Access Via**[™] licensed by Access Via of Seattle, Washington, and imbedded in Oracle Retail Signs and Oracle Retail Labels and Tags.
- (iv) the software component known as **Adobe Flex**[™] licensed by Adobe Systems Incorporated of San Jose, California, and imbedded in Oracle Retail Promotion Planning & Optimization application.

You acknowledge and confirm that Oracle grants you use of only the object code of the VAR Applications. Oracle will not deliver source code to the VAR Applications to you. Notwithstanding any other term or condition of the agreement and this ordering document, you shall not cause or permit alteration of any VAR

Applications. For purposes of this section, "alteration" refers to all alterations, translations, upgrades, enhancements, customizations or modifications of all or any portion of the VAR Applications including all reconfigurations, reassembly or reverse assembly, re-engineering or reverse engineering and recompilations or reverse compilations of the VAR Applications or any derivatives of the VAR Applications. You acknowledge that it shall be a breach of the agreement to utilize the relationship, and/or confidential information of the VAR Applications for purposes of competitive discovery.

The VAR Applications contain trade secrets of Oracle and Oracle's licensors and Customer shall not attempt, cause, or permit the alteration, decompilation, reverse engineering, disassembly or other reduction of the VAR Applications to a human perceivable form. Oracle reserves the right to replace, with functional equivalent software, any of the VAR Applications in future releases of the applicable program.

Contents

Send Us Your Comments	xv
Preface	xvii
Audience	xvii
Documentation Accessibility	xvii
Related Documents	xvii
Improved Process for Oracle Retail Documentation Corrections	xviii
Oracle Retail Documentation at the Oracle Help Center	xviii
Conventions	xviii
1 Introduction	
Overview	1-1
Business Value	1-2
Improved Customer Satisfaction	1-2
Real-Time Inventory	1-3
Dedicated Inventory Lookups	1-3
Streamlined Inventory Processes	1-3
Shrinkage Reduction	1-4
Technical Architecture	1-4
2 Common Usability and Navigation	
Welcome / Login	2-2
Tasks (Menu)	2-2
Favorites	2-3
Adding /Removing Favorite	2-4
Pinning Favorites	2-5
Edit Favorites	2-5
Change Store	2-6
Language	2-7
Preferences	2-8
Grid View Configuration	2-9
Filter	2-10
Row Selector	2-10
Export to CSV	2-11
Refresh	2-11

Detail (Apply) Block.....	2-12
---------------------------	------

3 Configuration

Overview.....	3-1
System Administration.....	3-2
Store Administration.....	3-2
Store Administration Defaults.....	3-4
Ad Hoc Stock Count Tolerance.....	3-4
Customer Order Picking Tolerance.....	3-5
Barcode Processor.....	3-6
Buddy Stores.....	3-7
Auto Receive Stores.....	3-8
SIOCS Managed Stores.....	3-9
Store Shipping Network.....	3-10
Carrier.....	3-11
Carrier Service.....	3-11
Package Size.....	3-12
Extended Attributes.....	3-12
Setup Extended Attributes.....	3-13
Assign Extended Attributes.....	3-13

4 Data Setup

Code Information.....	4-1
Delivery Timeslot.....	4-4
Inventory Adjustment Reasons.....	4-5
Item Scan Number (ISN) Types.....	4-9
Shipment Reasons.....	4-9
Sub-Buckets.....	4-11
Custom Flexible Attribute.....	4-11
Unit of Measure.....	4-12
UDA Print Setup.....	4-13
Specify Whether Tickets or Labels Are Printed Automatically.....	4-13
UIN Label Setup.....	4-13

5 Operations

Product Group.....	5-2
Product Group (List).....	5-2
Product Group Detail (Common).....	5-3
Product Group Detail (Stock Counts).....	5-4
Product Group Detail (Problem Line).....	5-6
Product Group Detail (Shelf Replenishment).....	5-7
Product Group Detail (Auto Ticket Print).....	5-8
Auto Generated Tickets.....	5-8
Auto Ticket Print Batch.....	5-9
Product Group Detail (Store Order).....	5-9
Product Group Components.....	5-10

Product Group Scheduler	5-11
Product Group Schedules (List)	5-12
Product Group Schedule Detail	5-12
Area	5-13
Format Assignment	5-15
Printer Setup	5-17
Import Ticket Template	5-18
Ticket Print Format	5-19
Reports	5-19
Operational Views	5-21
Out of Stock	5-21
New Items	5-22
Expiring Items	5-22
Stock Counts - Ready to Authorize	5-23
Shop Floor Out of Stock	5-24
6 Translations	
Export / Import File	6-3
7 Security	
Role Based Security	7-1
Role Maintenance Screen	7-3
Role Detail Screen	7-3
User Assignment Screen	7-3
Filter	7-4
User Detail Screen	7-5
User	7-5
Stores	7-5
Roles	7-6
New Role Assignment	7-6
Groups	7-7
8 Item	
Item Type Support	8-1
Vendor Product Number	8-2
Type 2 (VPLU)	8-2
GS1 Data Bar	8-3
GS1 DataBar - Quantity and Price	8-4
Store Pack Inventory	8-4
Business Cases	8-5
Store Pack Inventory - Other Functional Areas	8-8
UOM/Scanning	8-9
Unit of Measure (UOM)	8-9
Transaction (Preferred) UOM	8-10
Pack Size	8-10
Editing Pack Size	8-11

Changing the Quantity and Pack Size	8-11
Consistent Scanning (UOM)	8-12
Item Status	8-13
Configurations	8-13
Restrictions	8-13
Non-Inventory Indicator	8-14
RFID	8-15
UIN Tracking	8-15
Item Description	8-15

9 Inventory Management

Item Basket	9-1
Item Basket List	9-3
Item Basket Search Criteria	9-4
Create Item Basket	9-4
Item Basket Detail	9-5
Item Basket Info	9-6
Item Basket Edit Info	9-7
Authorizing a Stock Count	9-7
Unit and Amount Rules	9-13
Unit, Ad Hoc, Problem Line Counts Rules	9-13
Transaction History	9-14
Transaction History Search	9-14
Transaction History	9-15
Troubled Transactions	9-16
Troubled Transactions List Search Criteria	9-16
Troubled Transactions List	9-16
Troubled Transactions List Navigation	9-17
Ticketing	9-17
Ticket Search Criteria	9-18
Ticket List	9-18
Update Tickets	9-19
Ticket Detail	9-19

10 Lookups

Item Lookup	10-1
Item Description	10-4
Brand	10-4
Dept	10-4
Class	10-4
Sub-Class	10-4
Item Status	10-4
Searching by Item	10-5
Item	10-5
Searching by Supplier	10-5
Supplier	10-5
Primary Supplier (Switch)	10-5

Searching by Style	10-6
Style (Item ID).....	10-6
Searching by Warehouse.....	10-6
Warehouse	10-6
Searching by UDA	10-7
UDA	10-7
Text.....	10-7
Value	10-7
Date Range.....	10-7
Searching by Inventory Status.....	10-7
Inventory Status	10-7
Sub-Bucket	10-8
Item Detail.....	10-8
Inventory	10-9
Stock On Hand Info	10-9
View UINs.....	10-9
Item Attributes.....	10-10
Item Attributes	10-10
Pack Items	10-11
Component Items.....	10-11
Stock Locator.....	10-12
Related Items	10-12
UDAs.....	10-13
Deliveries.....	10-13
RFID Locations	10-14
Item Locations	10-14
Additional Suppliers.....	10-15
Pricing Info.....	10-15
Transaction History	10-16
UIN Management	10-17
UIN Lookup	10-17
Item UIN List	10-18
UIN History	10-19
UIN Lookup Navigation	10-19
Supplier Lookup	10-20
Container Lookup	10-22
Finisher Lookup	10-24
Item Scan Number Lookup	10-26

11 Sales

Overview	11-1
POS and Sales Audit Process Flow	11-2
Sales and Return Processing.....	11-3
Customer Order Processing.....	11-3
Item Disposition	11-3
Wastage.....	11-3
Drop Ship	11-4

Item Types.....	11-4
RFID Support.....	11-4
Additional Impacts.....	11-5
Integration Options.....	11-5
ReSA - EICS Integration	11-6

List of Figures

1-1	EICS Platform	1-2
1-2	EICS Inventory Processes	1-3
2-1	Welcome Screen	2-2
2-2	Tasks	2-2
2-3	Favorites	2-3
2-4	Adding /Removing Favorite	2-4
2-5	Pinning Favorites	2-5
2-6	Edit Favorites	2-5
2-7	Change Store	2-6
2-8	Change Language	2-7
2-9	Preferences	2-8
2-10	Configure View	2-9
2-11	Reset View	2-9
2-12	Filter	2-10
2-13	Row Selector	2-10
2-14	Export to CSV	2-11
2-15	Refresh	2-11
2-16	Detail (Apply) Block	2-12
3-1	System Administration Screen	3-2
3-2	Store Administration Screen	3-2
3-3	Store Administration Screen - Select Stores	3-3
3-4	Store Administration Defaults Screen	3-4
3-5	Ad Hoc Stock Count Tolerances Screen	3-4
3-6	Customer Order Picking Tolerances Screen	3-5
3-7	Barcode Processor	3-6
3-8	Buddy Stores Screen	3-7
3-9	Auto Receive Stores Screen	3-8
3-10	SIOCS Managed Stores Screen	3-9
3-11	Store Shipping Network	3-10
3-12	Select Store Popup	3-10
3-13	Carriers Screen	3-11
3-14	Carrier Services Screen	3-11
3-15	Package Size Screen	3-12
3-16	Setup Extended Attributes Screen	3-13
3-17	Assign Extended Attributes Screen	3-13
3-18	Assign Extended Attributes Popup	3-14
4-1	Code Information	4-1
4-2	Delivery Timeslots	4-4
4-3	Inventory Adjust Reasons	4-5
4-4	ISN Types	4-9
4-5	Shipment Reasons	4-9
4-6	Sub-buckets	4-11
4-7	Custom Flexible Attribute	4-11
4-8	Unit of Measure	4-12
4-9	UDA Print Setup	4-13
4-10	UDA Label Setup	4-14
5-1	Product Groups (List)	5-2
5-2	Product Groups Detail - New	5-3
5-3	Product Groups Detail - Unit	5-4
5-4	Product Groups Detail - Problem Line	5-6
5-5	Product Groups Detail - Shelf Replenishment	5-7
5-6	Product Groups Detail - Auto Ticket Print	5-8

5-7	Product Groups Detail - Store Order	5-9
5-8	Product Group Components Screen	5-10
5-9	Product Group Schedules	5-12
5-10	Product Group Schedule Detail Screen	5-12
5-11	Area List	5-14
5-12	Area Search	5-14
5-13	Area Detail	5-15
5-14	Format Assignment List.....	5-16
5-15	Format Assignment Search Criteria	5-16
5-16	Format Assignment Detail.....	5-17
5-17	Printer Setup Screen	5-17
5-18	Import Ticket Template.....	5-18
5-19	Import Template File.....	5-18
5-20	Ticket Print Format.....	5-19
5-21	Reports.....	5-19
5-22	Out of Stock - Hierarchy (Operational View)	5-21
5-23	Out of Stock - Supplier (Operational View).....	5-22
5-24	New Items (Operational View).....	5-22
5-25	Expiring Items (Operational View)	5-23
5-26	Stock Counts -Ready to Authorize (Operational View).....	5-23
5-27	Shop Floor Out of Stock (Operational View)	5-24
6-1	Locale Selection	6-3
6-2	Translation Setup Screen.....	6-3
6-3	Import Translation File Popup.....	6-4
7-1	Security Management Workflow	7-2
7-2	Role Maintenance Screen	7-3
7-3	Role Detail Screen	7-3
7-4	User Assignment Screen	7-4
7-5	User Filter Screen	7-4
7-6	User Detail Screen.....	7-5
7-7	User Detail (Stores) Screen	7-5
7-8	User Detail (Roles) Screen.....	7-6
7-9	User Detail (Roles - New Role Assignment) Screen	7-7
7-10	User Detail (Groups) Screen.....	7-7
8-1	GS1 Data Bar Example	8-3
8-2	Store Pack Inventory Setup Flow	8-5
9-1	Item Basket Desktop Screen Flow	9-2
9-2	Item Basket List Screen.....	9-3
9-3	Item Basket Search Criteria Popup.....	9-4
9-4	Create Item Basket Popup	9-4
9-5	Item Basket Detail Screen.....	9-5
9-6	Item Basket Info Popup.....	9-6
9-7	Item Basket Edit Info Popup	9-7
9-8	Stock Count Authorization Screen	9-8
9-9	Stock Count Authorization Detail Screen	9-9
9-10	Authorization Detail - UIN.....	9-10
9-11	Authorization Detail - Multi Locations.....	9-11
9-12	Rejected Items Screen	9-11
9-13	Transaction History Search Criteria	9-14
9-14	Transaction History List.....	9-15
9-15	Troubled Transactions List Search Criteria.....	9-16
9-16	Troubled Transactions List	9-16
9-17	Ticket Search Criteria	9-18
9-18	Ticket List	9-18
9-19	Update Tickets.....	9-19

9-20	Ticket Detail	9-19
10-1	Item Lookup Screen Flow	10-2
10-2	Item Lookup Screen	10-3
10-3	Search Mode: Item	10-5
10-4	Search Mode: Supplier	10-5
10-5	Search Mode: Style.....	10-6
10-6	Search Mode: Warehouse	10-6
10-7	Search Mode: UDA	10-7
10-8	Search Mode: Inventory Status	10-7
10-9	Search Mode: Inventory Status - Unavailable	10-8
10-10	Item Detail Screen	10-8
10-11	Inventory	10-9
10-12	Item Attributes Section.....	10-10
10-13	Pack Items Section	10-11
10-14	Component Items Section	10-11
10-15	Stock Locator Section.....	10-12
10-16	Related Items Section	10-12
10-17	UDAs Section.....	10-13
10-18	Deliveries Section.....	10-13
10-19	RFID Locations Section	10-14
10-20	Item Locations Section.....	10-14
10-21	Additional Suppliers Section.....	10-15
10-22	Pricing Info Section.....	10-15
10-23	Pricing Events Screen	10-15
10-24	Transaction History	10-16
10-25	UIN Lookup	10-17
10-26	Item UIN List.....	10-18
10-27	UIN History	10-19
10-28	Supplier Lookup Workflow	10-20
10-29	Supplier Lookup Screen.....	10-20
10-30	Supplier Lookup Search Criteria	10-21
10-31	Supplier Detail Screen	10-21
10-32	Container Lookup Screen	10-22
10-33	Container Lookup Search Criteria.....	10-22
10-34	Container Detail Screen.....	10-23
10-35	Print Tickets	10-24
10-36	Finisher Lookup Screen.....	10-24
10-37	Finisher Lookup Search Criteria	10-25
10-38	Finisher Detail Screen	10-25
10-39	Item Scan Number Lookup Screen.....	10-26
10-40	Item Scan Number Lookup Search Criteria	10-27
10-41	Create Item Scan Number.....	10-27
11-1	POS and Sales Audit Integration	11-1
11-2	POS and Sales Audit Process Flow.....	11-2

Send Us Your Comments

Oracle Retail Enterprise Inventory Cloud Service User Guide, Release 19.5

Oracle welcomes customers' comments and suggestions on the quality and usefulness of this document.

Your feedback is important, and helps us to best meet your needs as a user of our products. For example:

- Are the implementation steps correct and complete?
- Did you understand the context of the procedures?
- Did you find any errors in the information?
- Does the structure of the information help you with your tasks?
- Do you need different information or graphics? If so, where, and in what format?
- Are the examples correct? Do you need more examples?

If you find any errors or have any other suggestions for improvement, then please tell us your name, the name of the company who has licensed our products, the title and part number of the documentation and the chapter, section, and page number (if available).

Note: Before sending us your comments, you might like to check that you have the latest version of the document and if any concerns are already addressed. To do this, access the Online Documentation available on the Oracle Help Center (OHC) website. It contains the most current Documentation Library plus all documents revised or released recently.

Send your comments to us using the electronic mail address: retail-doc_us@oracle.com

Please give your name, address, electronic mail address, and telephone number (optional).

If you need assistance with Oracle software, then please contact your support representative or Oracle Support Services.

If you require training or instruction in using Oracle software, then please contact your Oracle local office and inquire about our Oracle University offerings. A list of Oracle offices is available on our Web site at <http://www.oracle.com>.

Preface

This guide describes the Oracle Retail Enterprise Inventory Cloud Service user interface. It provides step-by-step instructions to complete most tasks that can be performed through you interface.

Audience

This User Guide is for users and administrators of Oracle Retail Enterprise Inventory Cloud Service. This includes merchandisers, buyers, business analysts, and administrative personnel.

Documentation Accessibility

For information about Oracle's commitment to accessibility, visit the Oracle Accessibility Program website at <http://www.oracle.com/pls/topic/lookup?ctx=acc&id=docacc>.

Access to Oracle Support

Oracle customers that have purchased support have access to electronic support through My Oracle Support. For information, visit <http://www.oracle.com/pls/topic/lookup?ctx=acc&id=info> or visit <http://www.oracle.com/pls/topic/lookup?ctx=acc&id=trs> if you are hearing impaired.

Related Documents

For more information, see the following documents in the Oracle Retail Store Inventory Operations Cloud Services Release 19.5 documentation set:

- *Oracle Retail Store Inventory Operations Cloud Services Release Notes*
- *Oracle Retail Store Inventory Operations Cloud Services Implementation Guide*
- *Oracle Retail Store Inventory Operations Cloud Services Data Model*
- *Oracle Retail Enterprise Inventory Cloud Service Administration Guide*
- *Oracle Retail Enterprise Inventory Cloud Service Security Guide*
- *Oracle Retail Store Operations Cloud Service User Guide*
- *Oracle Retail Store Operations Cloud Service Mobile Guide*

Improved Process for Oracle Retail Documentation Corrections

To more quickly address critical corrections to Oracle Retail documentation content, Oracle Retail documentation may be republished whenever a critical correction is needed. For critical corrections, the republication of an Oracle Retail document may at times not be attached to a numbered software release; instead, the Oracle Retail document will simply be replaced at the Oracle Help Center (OHC) website, or, in the case of Data Models, to the applicable My Oracle Support Documentation container where they reside.

This process will prevent delays in making critical corrections available to customers. For the customer, it means that before you begin installation, you must verify that you have the most recent version of the Oracle Retail documentation set. Oracle Retail documentation is available at the Oracle Help Center at the following URL:

<https://docs.oracle.com/en/industries/retail/index.html>

An updated version of the applicable Oracle Retail document is indicated by Oracle part number, as well as print date (month and year). An updated version uses the same part number, with a higher-numbered suffix. For example, part number F123456-02 is an updated version of a document with part number F123456-01.

If a more recent version of a document is available, that version supersedes all previous versions.

Oracle Retail Documentation at the Oracle Help Center

Oracle Retail product documentation is available on the following website:

<https://docs.oracle.com/en/industries/retail/index.html>

(Data Model documents are not available through Oracle Help Center. You can obtain them through My Oracle Support.)

Conventions

The following text conventions are used in this document:

Convention	Meaning
boldface	Boldface type indicates graphical user interface elements associated with an action, or terms defined in text or the glossary.
<i>italic</i>	Italic type indicates book titles, emphasis, or placeholder variables for which you supply particular values.
monospace	Monospace type indicates commands within a paragraph, URLs, code in examples, text that appears on the screen, or text that you enter.

Introduction

This chapter provides a functional and technical introduction to the Enterprise Inventory Cloud Service (EICS).

Overview

EICS is a cloud service platform helping retailers track discrete store and warehouse inventory across the enterprise. In return this information can be provided to downstream systems for Omni-Channel purposes or even general merchandising.

The platform comes with a desktop-based administration layer, functional oversight and operational components, using browser technology (Oracle JET).

The administration layer allows:

- System and store business process configuration
- Setup of core data elements like reason codes, context values and tolerances for picking
- Configuration of printers
- Prioritizing the barcode parser
- Scheduling the batches and managing polling timers for the integration layer
- Management and scheduling of Product Groups to automate processes like stock counts
- Notification setup
- Setup of server based translation values
- Report Printing
- Creation of roles and role user assignments
- Translation maintenance

The oversight management UI functions:

- Management of UIN discrepancies
- Stock Count Authorization
- Transaction history lookup
- Views on items out of stock, expiring items, new in store, stock counts requiring authorization and shelf out of stock positions.
- Item, supplier and container Lookup

The operational components include:

- Role user assignment
- Batch scheduling and tracking
- MPS management
- Error log tracking

EICS leverages a host of APIs to allow a retailer to import and export data. The application it leverages is the Retail Integration Cloud Service (RICS), which consists of three integration methods:

- Retailer Integration Bus (RIB) for payload integration and continuous streaming between applications
- Retail Backbone Service (RSB) for web service integration to import, export and execute inventory business transactions
- Bulk Data Integration (BDI) is used to import start-up data

In addition to these integration tools, several batch processes also exist for operational bulk data processing.

Figure 1–1 EICS Platform

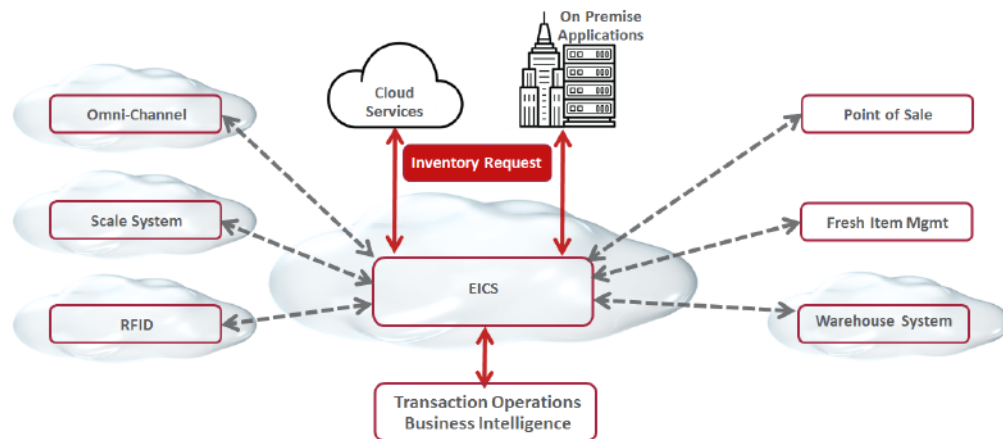

EICS does not have an operational transaction execution layer, and counts on the optional mobile UI of the Store Operations Cloud Services (SOCS) to execute store inventory transactions. Some retailers may not want to deploy the SOCS UI because they will be leveraging their own applications.

Business Value

This section describes the business values of using EICS.

Improved Customer Satisfaction

EICS provides an improved customer experience, with accurate, up-to-date inventory positions, customer order execution, and real time accurate stock positions for all stores.

Real-Time Inventory

Providing a centralized real-time inventory view is a major challenge for most retailers. EICS supports all store business processes to ensure back-end ordering systems, and customer-facing applications can provide accurate inventory positions. This visibility is delivered through a flexible web service enabled architecture optimized for high-volume querying from order management systems or in-store personal. Real-time inventory has also increased in importance to help with customer order fulfillment and online inventory promise.

A warehouse inventory API allows EICS to also track warehouse inventory to be that one stop shop for enterprise inventory. This API is specifically built in case a merchandise system is not deployed that could provide refined information like channel or future to promise or does not have the ability to expose correct APIs.

Dedicated Inventory Lookups

EICS allows for cross-location inventory lookup. In the case of an out of stock position. This information can be leveraged by third party systems to more efficiently route customers in a store, or web orders to the correct locations.

The web service architecture and centralized nature of EICS allow for instant up-to-date inventory for all stores. EICS also tracks a variety of different inventory buckets to provide better information and give a better understanding on what is available for sale versus reserved for other purposes.

As part of EICS a retailer also receives JET UI functionality to look up item inventory and attribute information.

Streamlined Inventory Processes

EICS is a fully integrated solution with warehouses, stores, and corporate offices. EICS' store processes are considered best in the industry using real time and near real-time integration infrastructure between warehouses, suppliers, stores, corporate, and other third-party applications.

Figure 1-2 EICS Inventory Processes

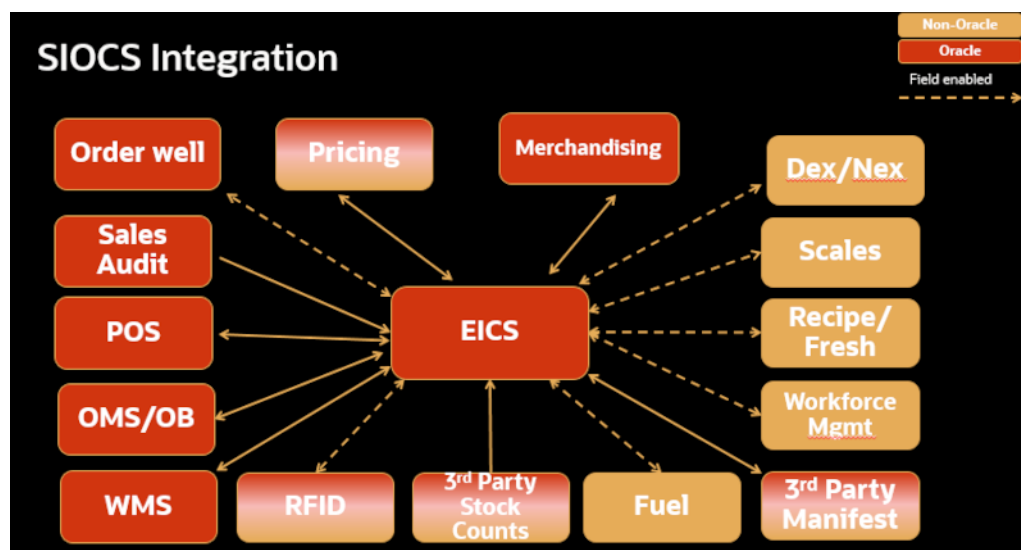

This communication model allows for accurate up-to-date information on transfers, store and warehouse shipments and deliveries, and sales processing for accurate inventory position. Inventory adjustments and results from stock counts are immediately communicated to corporate. Additional integration to support the enterprise is provided to a manifest system for printing labels.

All this information generates better replenishment results since all information at corporate will be up to date.

In addition, EICS is highly configurable with over 100 configuration options and an additional 200 permissions with the optional use of SOCS. This makes it possible to deploy one instance of EICS across multiple time zones, geographies and different footprint stores reducing the cost to maintain multiple servers and environments..

EICS uses some of the best in the industry in store processes, such as the automatic generation of stock counts. It can integrate Plan-o-gram information and track inventory through the backroom and shop floor.

Shrinkage Reduction

Detailed receiving from supplier, store, and warehouse and shipping allows retailers to monitor where inventory discrepancies happen with the ability to investigate any issues.

To improve store compliancy, it is possible to schedule standard inventory control transactions like stock counts.

Every inventory change can be tracked down to a specific user and transaction for the change.

Finally, inventory adjustments require a reason that can be specifically assigned to a single user allowing, for example, a sales associate to only move inventory to an unavailable status, while store managers can write off missing inventory.

Technical Architecture

For technical architecture and technology stack, please refer to the *Oracle Retail Enterprise Inventory Cloud Service Administration Guide*.

Common Usability and Navigation

This chapter describes the method by which you log in, and log out, and the menu and how to navigate. It also describes the common User Interface (UI) controls that are used throughout the desktop application.

Features:

- [Welcome / Login](#)
- [Tasks \(Menu\)](#)
- [Favorites](#)
- [Change Store](#)
- [Language](#)
- [Preferences](#)
- [Grid View Configuration](#)
- [Filter](#)
- [Row Selector](#)
- [Export to CSV](#)
- [Refresh](#)
- [Detail \(Apply\) Block](#)

Welcome / Login

Figure 2–1 Welcome Screen

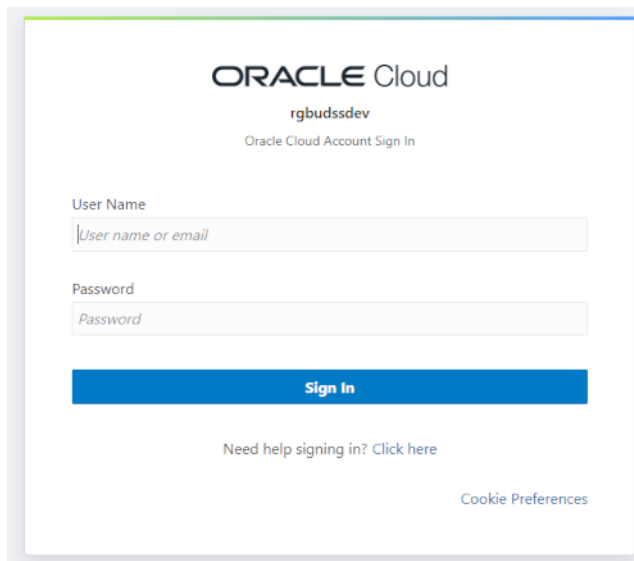

Upon launching the application, the welcome screen is displayed. The first time you log into the system, if the logon is successful, the system will log in to your first assigned store. The system will remember the store you last logged into and log in to that store automatically until you change the store. Upon successful login, the system navigates to the main page with the menu displayed.

Tasks (Menu)

Figure 2–2 Tasks



The menu panel on the left side of the screen is displayed upon tapping the drawer (hamburger stack which looks like three horizontal lines in the upper left-hand corner of the application). The tasks/menu options are displayed. From the menu there are sub-menus which give you access to various functionality of the application. Tasks can also be searched and the user will be taken into the dialog that was searched.

Favorites

Figure 2–3 Favorites

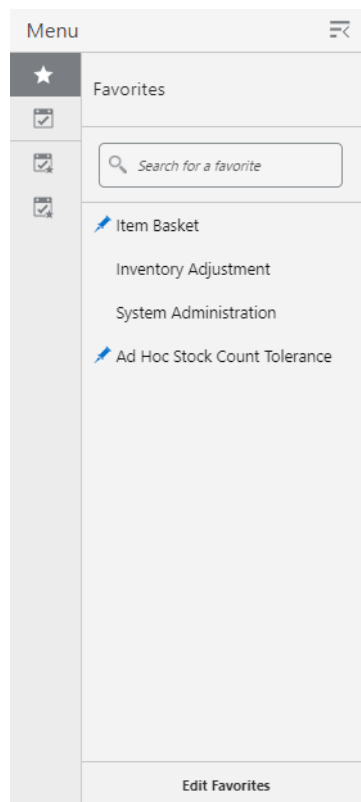

A favorite is a way of creating a shortcut for a task/menu that the user frequents often. A user's favorites are accessed by selecting the **Favorites** (star) option. The system will list all the favorites. Selecting a favorite will navigate into that dialog. The user can also search for a favorite and select the searched favorite and navigate into the dialog.

Adding /Removing Favorite

Figure 2–4 Adding /Removing Favorite

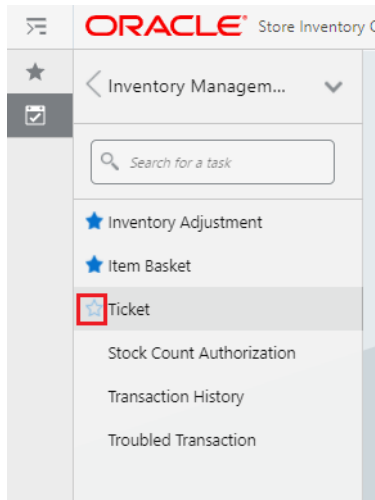

A favorite can be added by hovering over the task menu option. The unselected star will appear. Selecting the star will mark that task as a favorite and it will appear in the favorites list. Unselecting the star will remove the task from the favorites list. In the screenshot above you can see that **Inventory Adjustment** and **Item Basket** are already favorites. The user has hovered over **Ticket** and can select that star to add **Ticket** to the favorites.

Pinning Favorites

Figure 2–5 Pinning Favorites

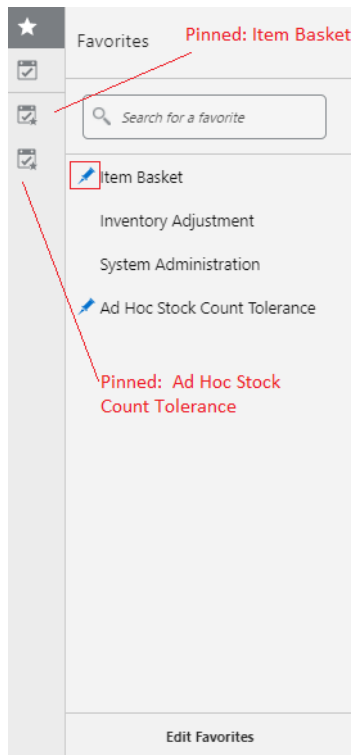

A favorite can be pinned, as you can see by the 'pin' icon (**Item Basket** and **Ad Hoc Stock Count Tolerance** have pins). A favorite that is pinned will appear as its own menu option below the tasks. To pin a favorite you hover over the favorite and the pin icon will appear and it can be selected. To unpin a favorite you unselect the pin.

Edit Favorites

Figure 2–6 Edit Favorites

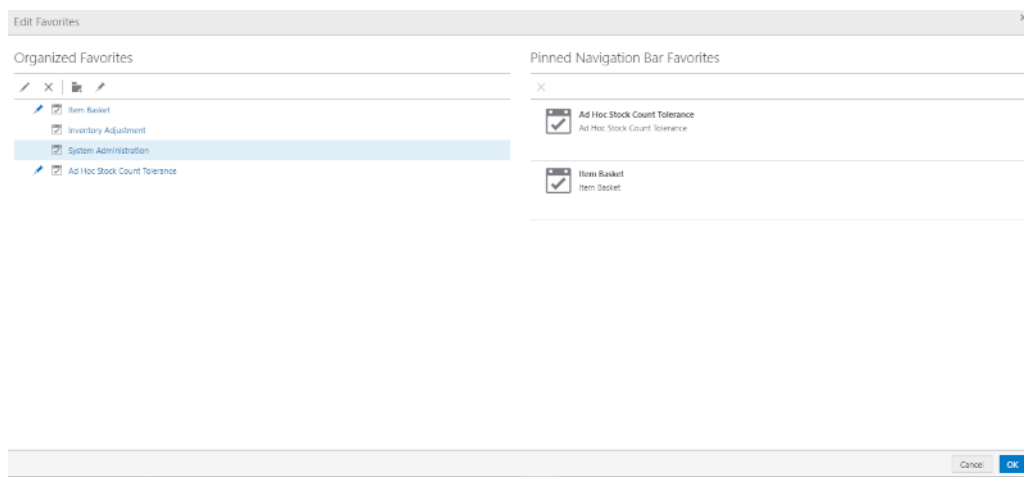

The Edit Favorites screen is accessed by selecting the Edit Favorites option from the bottom of the favorites list.

On the screen the user can:

1. Rename a Favorite - it will only rename the item in the favorites list not in the task list.
2. Reorder the Favorites
3. Remove a Favorite
4. Pin and Unpin Favorites
5. Create folders to group Favorites
6. Reorder Pins

Change Store

Figure 2–7 *Change Store*

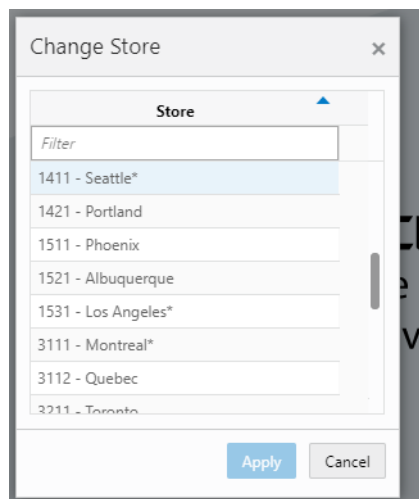

The **Change Store** dialog is available two ways. One, it is accessed by selecting the store in the upper right-hand corner. Secondly, it is accessed by selecting **Change Store** from the menu found in the upper right-hand corner labeled with your name.

Change Store displays all the stores that you are authorized for. If needed, filter down the list by entering any characters from the store ID or store name. Selecting a store and choosing **Apply** will display the new store in the store field in the upper right-hand corner of the application. You are then officially logged in to the new store. All data and transactions will be for the newly selected store. Every time you log in to the system, it will be for the store selected until a new store is selected. The system remembers/saves the store for you.

Language

Figure 2–8 Change Language

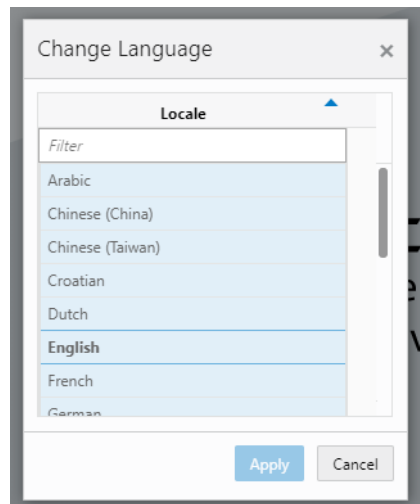

The **Change Language** screen is displayed by selecting the **Change Language** menu option within the menu found in the upper right-hand corner labeled with your name. The screen will display with a list of the available languages supported in the system. Select a language and the language will change in the application to the language selected and you will navigate back to the main screen. That language will remain until you change language. The locale of the device (date format, currency format, and so on) will remain that of the browser.

Preferences

Figure 2–9 Preferences

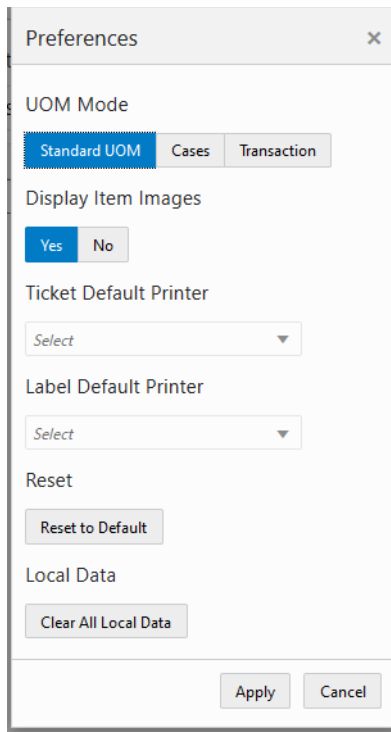

The **Preferences** menu option is located within the menu found in the upper right-hand corner labeled with your name. The **Preferences** menu contains option such as the UOM mode, display item images, Ticket default printer and Label default printer.

The ticket and label printer set as default here for the respective type is used in the application and shown as default printer.

When changing preferences, the selection will be applicable immediately after applying. The current preference settings will remain until you choose a new setting, **Clear All Local Data**, or **Reset to Default**. It does not reset automatically upon re-logging in.

UOM Mode enables you to set the UOM that would be used across the application for that session. The UOM will not be editable on the line item level. When you log in, the default UOM setting would be the UOM that is defined in the **Default UOM** system configuration, and you can change it subsequently.

Display Item Images will enable you to switch on and off item image display in the entire application. This preference setting works in addition to the system configurations which control image display within each functional dialog, **Display Item Image for <functional area> -Operations**. So, for example, if the system setting **Display Item Image for <functional area> -Operations** is set to 'Yes', this means that Inventory Adjustments have images enabled at a system level. If you choose you can turn on or off the images via the display item image preference. If the system setting for the functional area is set to 'No', then the preference would not allow for images to be displayed in that functional area.

Grid View Configuration

Figure 2–10 Configure View

Description	Use in UI	Disposition	To Sub-bucket	From Sub-bucket	Publish	System
Sort Ascending	Filter	Filter	Filter	Filter	Filter	Filter
Sort Descending	No	- Stock On Hand			Yes	Yes
Columns		Stock On Hand			Yes	No
Wastage - updated		Unavailable	Trouble		Yes	Yes
Theft		Stock On Hand			Yes	No
Store Use		Stock On Hand			Yes	No
Repair - Out		Unavailable	Trouble		Yes	No
Repair - In		Unavailable		Trouble	Yes	No
Charity		Stock On Hand			Yes	No
Stock Count In		Stock On Hand			Yes	Yes
Stock Count Out		Stock On Hand			Yes	Yes
Dispose from on Hold		Stock On Hand & - Unavail...		Trouble	Yes	No
Dispose from SOH	Yes	- Stock On Hand			Yes	No

Grid View can be configured by right clicking on the menu header of any grid / table. Sorting can be done in ascending or descending order for that column by selecting the option from the menu. Sorting can also take place just by clicking on the menu header. You can configure what columns to display or hide from within the menu. In addition, columns can be made smaller / larger as well as moved by dragging them. These configurations are per user and device and are remembered forever.

Figure 2–11 Reset View

Code	Description	Disposition	To Sub-bucket	From S
Filter	Filter		Filter	Filter
1	Wastage - updated	Stock On Hand		
2	Shrinkage	Stock On Hand		
3	Repair - In	Yes - Unavailable		Trouble
4	Untranslated: invAdjReason.4	Yes - Unavailable		Trouble
5	Untranslated: invAdjReason.5	Yes + Unavailable	Trouble	
10	Untranslated: invAdjReason.10	No + Unavailable	Trouble	
26	regression	No + Customer Order Reserve		

Grid View can be reset back to the default by selecting the **Reset View** option from the **Grid View** menu on the header menu.

Filter

Figure 2–12 Filter

Inventory Adjustment Reasons

Code	Description	Disposition	To Sub-bucket	From Sub-bucket
Filter	Filter		Filter	Filter
1	Wastage - updated	- Stock On Hand		
2	Shrinkage	- Stock On Hand		
3	Repair - In	Yes - Unavailable		Trouble
4	Untranslated: invAdjReason.4	Yes - Unavailable		Trouble
5	Untranslated: invAdjReason.5	Yes + Unavailable	Trouble	
10	Untranslated: invAdjReason.10	No + Unavailable	Trouble	
26	recession	No + Customer Order Reserve		

The filter option is represented by a funnel icon located in the **Grid View** menu in the header of buttons. The filter is at the top of all lists. When the funnel is selected there will be a row below the column headers in the list that will allow for entry to filter/narrow down the list. When the funnel is unselected then the row below the header for filtering will not be present. The default when viewing a list is for the funnel to be active.

Row Selector

Figure 2–13 Row Selector

Inventory Adjustment Reasons

Code	Description	Disposition	To Sub-bucket	From
Filter	Filter	Filter	Filter	Filter
1	Wastage - updated	- Stock On Hand		
2	Shrinkage	- Stock On Hand		
3	Repair - In	Yes - Unavailable		Trouble
4	Untranslated: invAdjReason.4	Yes - Unavailable		Trouble
5	Untranslated: invAdjReason.5	Yes + Unavailable	Trouble	

Most lists have a **Row Selector** menu option in the grid view menu on the header of buttons. By selecting the **Row Selector** option icon, the system will display/enable the check box next to each record in the list allowing you to select multiple records. Being able to multi-select allows you to perform a function to more than one record at a time, such as deleting more than one record at the time. Not all lists will have a check box option, because doing a multi-select is not applicable in all areas of the application. The default for list screens is to have the check box not displayed.

Export to CSV

Figure 2–14 Export to CSV

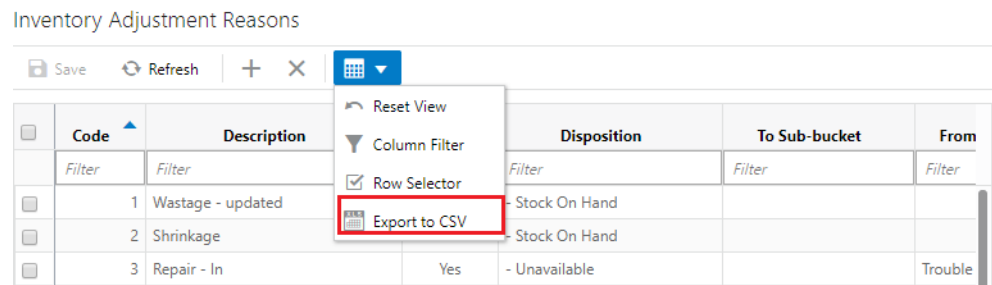

Export to CSV is in the **Grid View** menu. Selecting this option will export the results from the grid to a CSV file (spreadsheet).

Refresh

Figure 2–15 Refresh

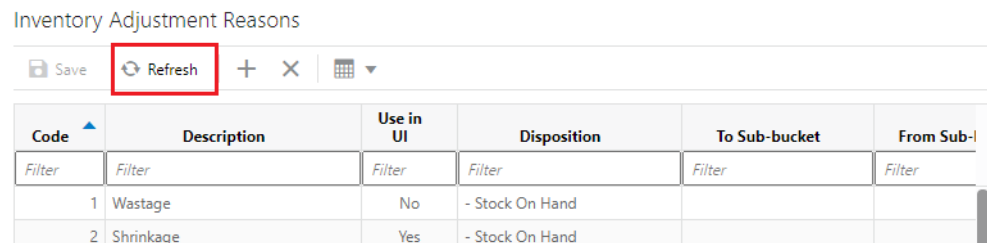

The **Refresh** button is found throughout the application mainly in the header of list screens. This button simulates what happens when you first navigate to the screen by refreshing the screen to how it was prior to making any changes. If there are pending changes, a confirmation message to discard the changes is shown before the data is reloaded with a fresh copy.

Detail (Apply) Block

Figure 2–16 *Detail (Apply) Block*

The screenshot shows a table titled "Inventory Adjustment Reasons" with columns: Code, Description, Use in UI, Disposition, To Sub-bucket, and From Sub-bucket. The table contains 17 rows of data. To the right of the table is a "Detail" block with a red border, containing fields for Code, Description, Use in UI (No), Disposition (dropdown), To Sub-bucket (dropdown), From Sub-bucket (dropdown), Publish (No), and System (No). The table data is as follows:

Code	Description	Use in UI	Disposition	To Sub-bucket	From Sub-bucket
1	Wastage	No	- Stock On Hand		
2	Shrinkage	Yes	- Stock On Hand		
3	Repair - In	Yes	- Unavailable		Trouble
75	Stock Count Unavailable To Missing	No	- Unavailable		Trouble
76	Unit Late Sales Increase SOH	No	+ Stock On Hand		
77	Unit Late Sales Decrease SOH	No	- Stock On Hand		
78	Unit and Amount Late Sales Incre...	No	+ Stock On Hand		
79	Unit and Amount Late Sales Decr...	No	- Stock On Hand		
81	Damaged - Out	Yes	- Stock On Hand		
82	Damaged - Hold	Yes	+ Unavailable	Trouble	
83	Theft	Yes	- Stock On Hand		
84	Store Use	Yes	- Stock On Hand		
85	Repair - Out	Yes	+ Unavailable	Trouble	
86	Charity	Yes	- Stock On Hand		
87	Stock Count In	No	+ Stock On Hand		

For the most part, lists cannot be updated directly in the table (list). All updates to values in a list must be done via the **Detail (Apply)** block. Where applicable, new records can be created, and existing records can be updated via the detail block. Once applied the data is updated into the table. Stock Count Authorization is an exception to this allowing for updating directly in the list (table) itself.

Overview

The configuration chapter covers functionality found within the configuration menu of the desktop application.

Features include:

- [System Administration](#)
- [Store Administration](#)
- [Store Administration Defaults](#)
- [Ad Hoc Stock Count Tolerance](#)
- [Customer Order Picking Tolerance](#)
- [Barcode Processor](#)
- [Buddy Stores](#)
- [Auto Receive Stores](#)
- [SIOCS Managed Stores](#)
- [Store Shipping Network](#)
- [Carrier](#)
- [Carrier Service](#)
- [Package Size](#)
- [Extended Attributes](#)

System Administration

Figure 3–1 System Administration Screen

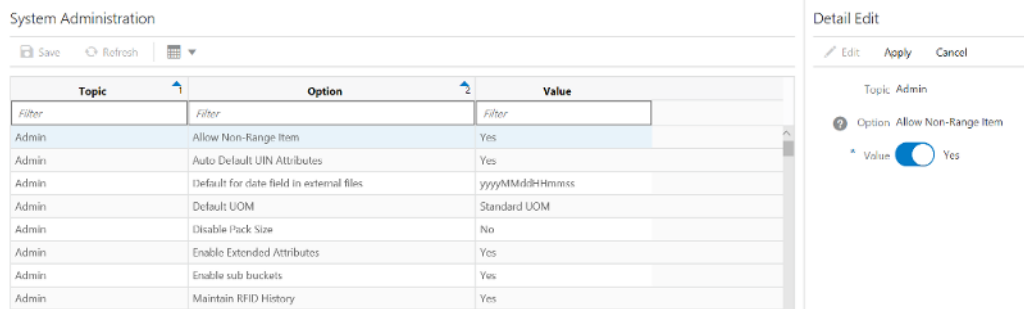

The System Administration in the desktop application is an admin screen used to setup the system configurations for both the desktop application and the mobile application. You can access this screen by selecting **System Administration** from the **Configuration** menu within the **Admin** menu.

You need to have proper permissions to access this screen.

Some of the system configurations cannot be changed to protect the data integrity of the system.

Select the parameter and edit the settings on the detail portion and apply the changes. The details of the individual configuration settings are described in a separate section.

Store Administration

Figure 3–2 Store Administration Screen

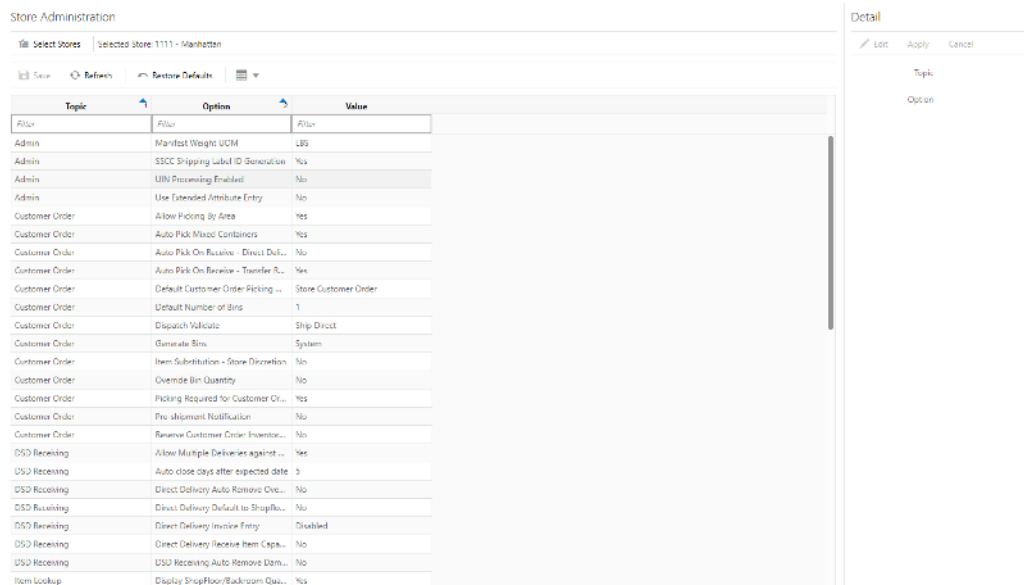

Store Administration in the desktop application is an admin screen used to setup the store level configurations. Access this screen by selecting the **Store Administration** from the **Configuration** menu within the **Admin** menu.

You need to have proper permissions to access this screen.

Select the parameter and edit the settings on the detail portion and apply the changes. The details of the individual configuration settings are described in a separate section.

The **Restore Defaults** option can be used to restore the default parameters for the store. The system will update all the store parameters of the current store to the default store parameters.

Figure 3–3 Store Administration Screen - Select Stores

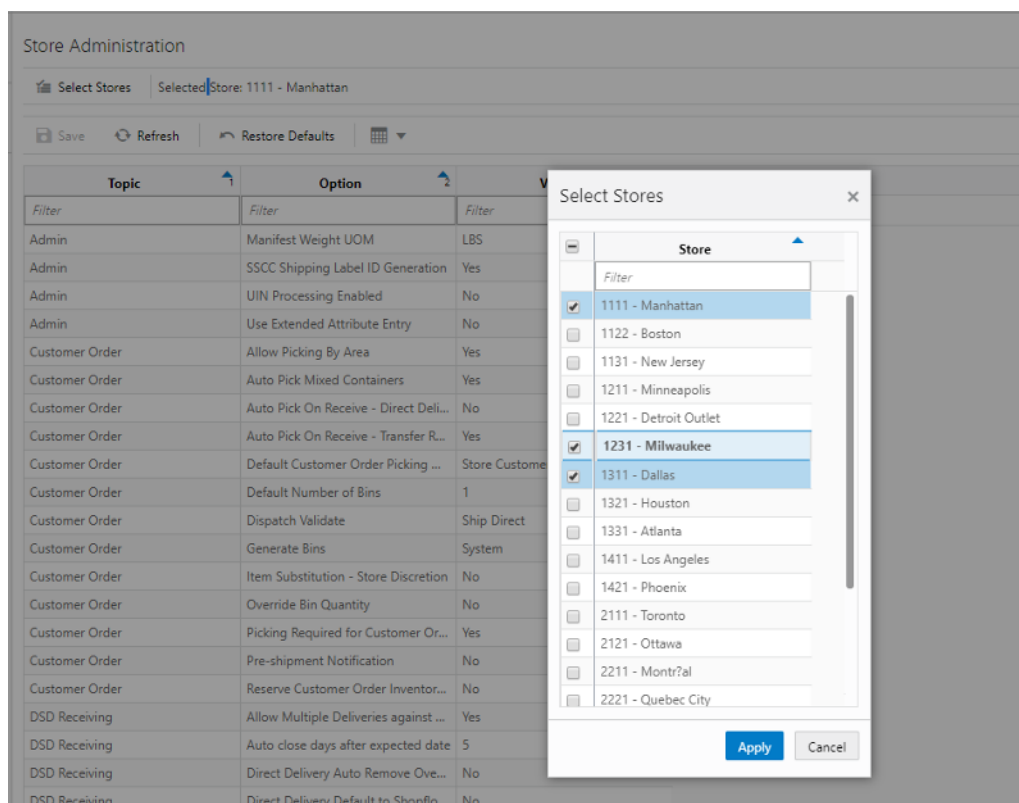

Select Stores popup is accessed by selecting the **Select Stores** option on the **Store Administration** screen. It is used to define which stores the store admin configurations should be applied to. The list of stores will be those in which the user has security permissions. The user can select one or more stores from the list. Once saving and exiting the **Store Administration** screen, all the selected stores will have their store admin configurations updated.

Store Administration Defaults

Figure 3–4 Store Administration Defaults Screen

The screenshot shows the 'Store Administration Defaults' screen. At the top, there are buttons for 'Save', 'Refresh', and 'Reset Stores'. Below is a table with columns 'Topic', 'Option', and 'Value'. The 'Admin' topic is selected, and the 'Manifest Weight UOM' option is highlighted, showing a value of 'LBS'. A 'Detail' panel on the right shows the selected option and its value.

Topic	Option	Value
Admin	Manifest Weight UOM	LBS
Admin	SSCC Shipping Label ID Generation	Yes
Admin	UIN Processing Enabled	No
Customer Order	Auto Pick Mixed Containers	No
Customer Order	Auto Pick On Receive - Direct Del...	No
Customer Order	Auto Pick On Receive - Transfer R...	No
Customer Order	Default Customer Order Picking...	Store Customer Order
Customer Order	Default Number of Bins	1

Detail panel for 'Manifest Weight UOM':
 Topic: Admin
 Option: Manifest Weight UOM
 Value: LBS

The Store Administration Defaults in the desktop application is an admin screen used to set default values for store level configurations that control a variety of behavior in the desktop application and the mobile application. Access this screen by selecting **Store Administration Default** from the **Configuration** menu within the **Admin** menu.

You need to have proper permissions to access this screen.

Use the **Reset Stores** option to change the current value of a parameter to all the stores.

The changes done in this screen, except for **Reset Stores** option, will not default automatically to the store parameters; it will only be considered to default the store parameters when a new store is data seeded.

Note: Making changes to this screen does not impact already existing store administration values.

Ad Hoc Stock Count Tolerance

Figure 3–5 Ad Hoc Stock Count Tolerances Screen

The screenshot shows the 'Carriers' screen. At the top, there are buttons for 'Save', 'Refresh', and a '+' icon. Below is a table with columns 'Code', 'Description', 'Manifest Type', and 'System'. The 'Y' carrier is selected, showing a 'Home Fleet' manifest type and 'No' system. A 'Detail' panel on the right shows the selected carrier's details.

Code	Description	Manifest Type	System
HIF	Carrier Home Fleet	Home Fleet	No
O	Other	Other	Yes
Q	Q Carrier	Parcel	No
REST	Carrier Service Road Pvt	Parcel	No
Y	Carrier Y	Home Fleet	No

Detail panel for 'Carrier Y':
 Manifest Type: Home Fleet
 Code: Y
 Description: Carrier Y
 System: No

The Ad Hoc Stock Count Tolerances screen is an admin screen used to maintain tolerances which are used to determine discrepant items within Ad Hock stock counts. These tolerances are maintained on a per store basis. The screen is accessed from the **Configuration** menu within the **Admin** menu.

Note: Ad Hoc stock counts can only be executed with the mobile application.

Tolerances are set up at the class hierarchy level and can be defined for variance percentages as well as variance standard unit of measures. There is a record for each class in the system, and initially upon install both variances will be set to zero. Variances must be whole numbers. At least one of the tolerances must be set up for each class, both cannot be left blank.

When counting an ad hoc stock count the system will look at the variances defined for the class that the item belongs too. If the difference between the counted quantity and the stock on hand exceeds the variance, the item will be considered discrepant. you must be within the lowest defined variance. A variance of zero for either field means that the count must be exact and cannot be discrepant.

Example: Item TV has SOH of 10 Units. Tolerance defined for 2 Variance SUOM and 10% Variance Percent. If you count 8 that exceeds the variance and it would be considered discrepant.

Customer Order Picking Tolerance

Figure 3–6 Customer Order Picking Tolerances Screen

Dept. ID	Dept. Name	Class ID	Class Name	Variance %	Variance Standard UOM
1100	Soft Drinks*	1	Carbonatd Sft Drink*	1	2
1100	Soft Drinks*	2	Diet Card Sft Drink*	0	0
1100	Soft Drinks*	3	New Age Beverages	0	0
1100	Soft Drinks*	4	Recycleable Bottles*	0	0
1102	Detergents*	1	All Purpose*	0	0
1102	Detergents*	2	Laundry*	0	0
1103	Cereal -Ready to Eat	1	Cold	0	0

Detail

Dept. ID 1100

Dept. Name Soft Drinks*

Class ID 1

Class Name Carbonatd Sft Drink*

Variance % 1

Variance 2

Standard UOM

The Customer Order Picking Tolerances screen is an admin screen used to maintain tolerances which are used within Customer Order Picking. These tolerances are maintained on a per store basis. Because variable unit of measure items can be difficult to pick exactly, tolerance can be needed. Tolerances define if and how much variable UOM items can be over picked. The screen is accessed the **Configuration** menu within the **Admin** menu.

Tolerances are set up at the class hierarchy level and can be defined for variance percentages as well as variance standard unit of measures. There is a record for each class in the system, and initially upon install both variances will be set to zero. Variances must be whole numbers. At least one of the tolerances must be set up for each class, both cannot be left blank.

When performing a pick, the pick quantity cannot exceed the suggested pick quantity by more than the variances defined for the item's class. You must be within the lowest defined variance. This is applicable only to items that are not unit/each item, for example pounds. A variance of zero for either field means that the suggested pick quantity cannot be exceeded.

Example: Ordered 2 KG bananas. Tolerance defined for 1 Variance SUOM and 10% Variance Percent. User is not able to pick exactly 2 KG and picks 2.1 KG. This is acceptable as the .1 KG does not exceed the defined variances.

Barcode Processor

Figure 3–7 Barcode Processor

Processor Name	Sequence	Active
SKU	10	Yes
GS1	20	Yes
Type 2 A	30	Yes
Type 2 B	40	Yes
Type 2 C	50	Yes
Type 2 D	60	Yes
Type 2 E	70	Yes
Type 2 F	80	Yes
Type 2 G	90	Yes
Type 2 H	100	Yes
Type 2 I	110	Yes
Type 2 J	120	Yes
Type 2 K	130	Yes
Type 2 L	140	Yes
VPLU_E	150	Yes
VPLU_G	160	Yes
VPLU_H	170	Yes

The Barcode Processor screen is an admin screen used to manage which barcode processors execute and the sequence in which they should be called. You can mark a barcode processor inactive or active. The **Barcode Processor** screen is accessed via the menu: Admin / Configuration / Barcode Processor. You must have **Access Barcode Processor** permission for the Barcode Processor menu option to display. The screen will display a set of barcode processors that were created via the data setup script.

List of Barcode Processors:

These barcode processors are inserted via the data setup script.

Name	Description	Active	Process Sequence
SKU	SKU	Y	10
GS1	GS1	Y	20
GS1 12	GS1 12	Y	23
GS1 13	GS1 13	Y	26
VPLU_A	Type 2 A	Y	30
VPLU_B	Type 2 B	Y	40
VPLU_C	Type 2 C	Y	50
VPLU_D	Type 2 D	Y	60
VPLU_E	Type 2 E	Y	70
VPLU_F	Type 2 F	Y	80
VPLU_G	Type 2 G	Y	90
VPLU_H	Type 2 H	Y	100

Name	Description	Active	Process Sequence
VPLU_I	Type 2 I	Y	110
VPLU_J	Type 2 J	Y	120
VPLU_K	Type 2 K	Y	130
VPLU_L	Type 2 L	Y	140
UPC_E	UPC E	Y	150
UIN	UIN	Y	160
VPN	VPN	Y	170
RFID	RFID	Y	180
RFID GTIN 12	RFID 12	Y	183
RFID GTIN 13	RFID 13	Y	186

Buddy Stores

Figure 3–8 Buddy Stores Screen

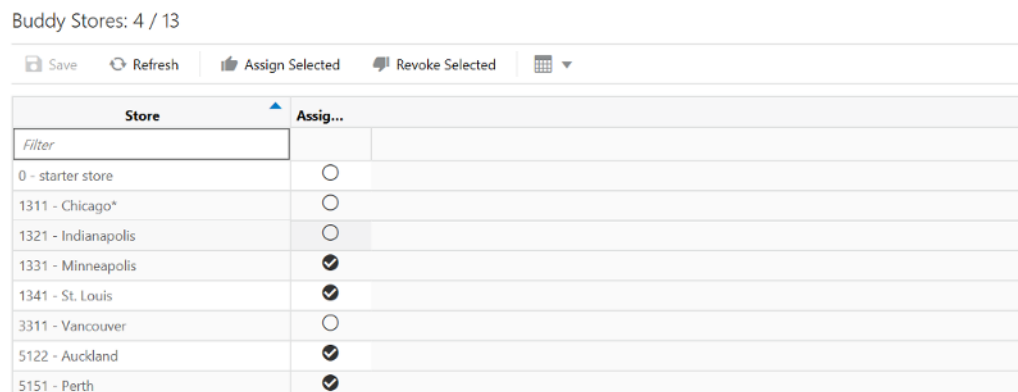

The Buddy Stores screen allows the store user to define stores that they normally transfer items to, in other words the store's "buddy". Each store can define their own list of buddy stores. Buddy stores presents a shortened list of stores to select from when creating a transfer/transfer shipment. You can still transfer items to stores that are not buddies; a buddy is simply a short list for ease of use.

The Buddy Stores screen is accessed by selecting Admin / Configuration / Buddy Store.

The list of stores to select from will be all stores for the same transfer zone as your store or no transfer zone. If your store does not have a transfer zone, then all stores will be displayed. Select the desired stores to move over to the buddy stores block to become buddy stores. It is not necessary to set up buddy stores.

Auto Receive Stores

Figure 3–9 Auto Receive Stores Screen

Auto-Receive Stores: 2 / 24

Save Refresh Assign Selected Revoke Selected

Store	Assign...
<i>Filter</i>	
1111 - Charlotte *	<input type="radio"/>
1131 - Jacksonville	<input type="radio"/>
1141 - Nashville	<input type="radio"/>
1151 - Dallas	<input type="radio"/>
1211 - Boston	<input checked="" type="radio"/>
1221 - New York	<input type="radio"/>
1231 - Philadelphia*	<input type="radio"/>
1241 - Cleveland	<input type="radio"/>
1321 - Indianapolis	<input checked="" type="radio"/>
1331 - Minneapolis	<input type="radio"/>
1341 - St. Louis	<input type="radio"/>
1411 - Seattle	<input type="radio"/>

The Auto Receive Stores screen allows you to select those stores to Auto-Receive transfer shipments from. Each store can define their own list of auto receive stores. If a store is defined as an auto receive store, the stock on hand of the receiving store is automatically adjusted as soon as the defined auto receive store dispatches the transfer. The receiving store will not be able to receive exceptions, or record damages to the transfer.

The Auto Receive Stores screen is accessed by selecting Admin / Configuration / Auto Receive Store.

Note: In addition to this selection, the auto receive admin setting needs to be setup.

The list of stores to select from will be all stores for the same transfer zone as your store or no transfer zone. If your store does not have a transfer zone, then all stores will be displayed. Select the desired stores to move over to the auto receive stores block to become an auto receive store.

SIOCS Managed Stores

Figure 3–10 SIOCS Managed Stores Screen

Store	Assign...
Filter	
1151 - 1151 Dallas	<input checked="" type="radio"/>
1211 - 1211 Boston	<input checked="" type="radio"/>
1221 - 1221 New York	<input checked="" type="radio"/>
1231 - 1231 Philadelphia*	<input checked="" type="radio"/>
1341 - 1341 St. Louis	<input checked="" type="radio"/>
1421 - 1421 Portland	<input type="radio"/>
1511 - 1511 Phoenix	<input checked="" type="radio"/>
1521 - 1521 Albuquerque	<input checked="" type="radio"/>
5141 - 5141 IshMelbourne	<input checked="" type="radio"/>
5151 - 5151 IshPerth	<input checked="" type="radio"/>
2100 - 2100 Xstore-Dallas*	<input checked="" type="radio"/>
5142 - 5142 IshLeamington Spa	<input checked="" type="radio"/>

The SIOCS Managed Stores screen allows you to select those stores that are using SIOCS for inventory management. The screen is accessed by selecting Admin ' Configuration/ SIOCS Managed Stores.

Upon initial install all stores will be defaulted to Assigned (selected) which means that they are SIOCS Managed. When a new store comes into SIOCS it too will default to assigned / SIOCS Managed. If a store is not using SIOCS, then it would need to be unassigned (un-selected).

The following areas are impacted for NON SIOCS Managed stores:

1. Users for NON SIOCS Managed stores will only have access to Admin screens in EICS, look ups, and view only access to transactions.
2. Messages will not be published out of SIOCS for NON SIOCS Managed stores.
3. Item Lookup Stock Locator will display stock only for SIOCS Managed Stores.
4. Product Group Schedules can only be scheduled for SIOCS Managed Stores.
 - a. In the SIOCS Managed Stores UI of the desktop (above), if a store goes from SIOCS Managed to NON SIOCS Managed, and there are open product group schedules for this store, the user will be prompted upon saving to delete the store(s) from the Product Group Schedule.

Store Shipping Network

Figure 3–11 Store Shipping Network

Store Shipping Network

Select Stores | Selected Store: 1311 - Chicago* | Override Existing Configuration: No

Save Refresh

Excluded Stores: 0 / 51

Assign Selected Remove Selected

Store	Exclude
Filter	
1151 - Dallas	<input type="radio"/>
1211 - Boston	<input type="radio"/>
1221 - New York	<input type="radio"/>
1231 - Philadelphia*	<input type="radio"/>
1241 - Cleveland	<input type="radio"/>
1311 - Chicago*	<input type="radio"/>
1321 - Indianapolis	<input type="radio"/>

The Store Shipping Network screen is an admin screen that enables the user to set up a shipping network for a store(s). That is, the list of stores that a store can ship to and the list of stores that a store cannot ship to. For example, if a list of stores gets excluded from the shipping network for Store A, those stores cannot be a destination store for Transfer documents and Transfers shipments originating from Store A, except for the transfers initiated by the Merchandising system.

The screen can be accessed through Admin/Configuration/Store Shipping Network. The user must have Access Store Shipping Network permission to access this screen.

Figure 3–12 Select Store Popup

Select Stores

Override Existing Configuration Yes

Store
Filter
<input type="checkbox"/> 1151 - Dallas
<input type="checkbox"/> 1211 - Boston
<input type="checkbox"/> 1221 - New York
<input type="checkbox"/> 1231 - Philadelphia*
<input type="checkbox"/> 1241 - Cleveland

Apply Cancel

With the Select Stores popup, user can set up excluded stores for more than one store at a time. User can also override the existing excluded stores setup if needed.

Carrier

Figure 3–13 Carriers Screen

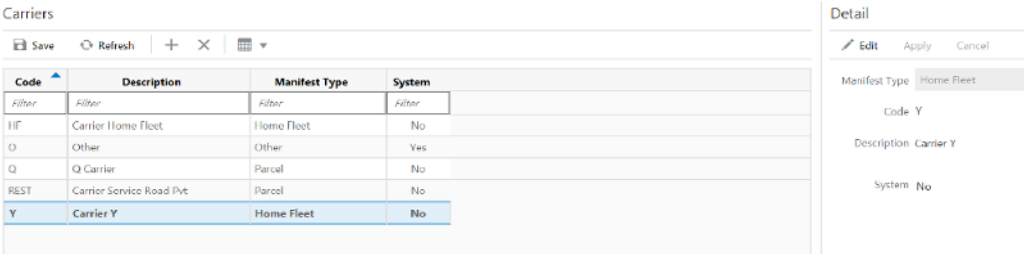

Code	Description	Manifest Type	System
<i>Filter</i>	<i>Filter</i>	<i>Filter</i>	<i>Filter</i>
HIF	Carrier Home Fleet	Home Fleet	No
O	Other	Other	Yes
Q	Q Carrier	Parcel	No
REST	Carrier Service Road Pvt	Parcel	No
Y	Carrier Y	Home Fleet	No

Detail	
Manifest Type	Home Fleet
Code	Y
Description	Carrier Y
System	No

The Carriers screen is an admin screen in the desktop application for you to setup and maintain the Carrier data. This screen is accessed by selecting the **Carrier** option from the Admin/ Configuration menu.

The system has a default Carrier record 'Other' under the manifest type 'Other'.

Carrier codes that are marked as system cannot be deleted.

The data created is available on the BOL screens when the Carrier Type of Third Party is selected.

This information should be coordinated with the Order Management System and / or manifest system.

Carrier Service

Figure 3–14 Carrier Services Screen

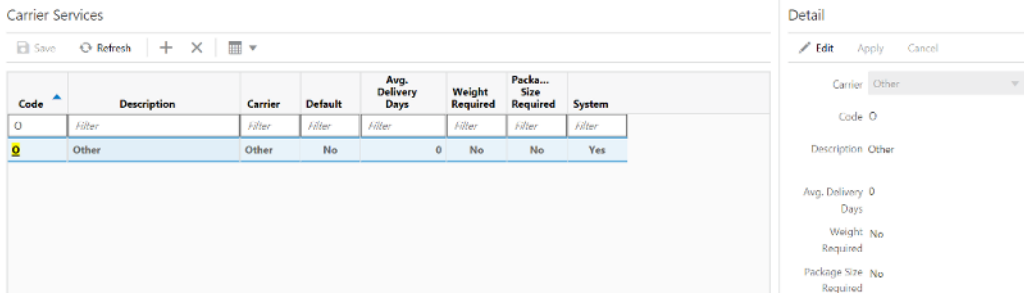

Code	Description	Carrier	Default	Avg. Delivery Days	Weight Required	Package Size Required	System
<i>Filter</i>	<i>Filter</i>	<i>Filter</i>	<i>Filter</i>	<i>Filter</i>	<i>Filter</i>	<i>Filter</i>	<i>Filter</i>
O	Other	Other	No	0	No	No	Yes

Detail	
Carrier	Other
Code	O
Description	Other
Avg. Delivery Days	0
Weight Required	No
Package Size Required	No

The Carrier Services screen is an admin screen in the desktop application to setup and maintain the Carrier Services data. This screen is accessed by selecting the **Carrier Services** option from the Admin/Configuration menu.

The system has a default Carrier Service record 'Other' under the 'Other' carrier.

Carrier Service codes that are marked as system cannot be deleted.

Capture the Average delivery days the carrier takes to deliver, indicate whether weight is required, whether container size is required, and indicate a carrier service as a default service when creating a carrier service record in the system.

This information should be coordinated with the Order Management System and / or manifest system.

Package Size

Figure 3–15 Package Size Screen

The screenshot shows the 'Package Size' screen with a table and a 'Detail' panel. The table has columns for Description, Height, Width, Length, and UOM. The 'Detail' panel shows the selected package size 'Extra Large' with its dimensions and UOM.

Description	Height	Width	Length	UOM
Filter	Filter	Filter	Filter	Filter
Med	4	4	4	IN
Large	5	5	5	IN
Extra Large	10	10	10	OZ

Detail panel for 'Extra Large':
 Description: Extra Large
 Height: 10
 Width: 10
 Length: 10
 UOM: OZ

The Package Sizes screen is used to setup and maintain Package dimensions for all shipments to supplier, finisher, warehouse and store for the entire system.

Package Size is used within:

- RTV Shipment and Transfer Shipment
 - Container Info and Edit Container
- Customer Order Deliveries
 - BOL Info and Edit Delivery

The Package Size dialog is accessed via the menu: Admin / Configuration / Package Size. Since package sizes are very specific to the retailer, there will not be an initial default of package sizes on install. Package Sizes can be created, edited and deleted. Values include description, height, widths, length, and Unit of Measure.

Extended Attributes

GS1 extended attributes allow users to capture manually or automatically through the use of a GS1 data bar values at the item transaction level. This for example allows the capture of an expiration date during delivery. Only physical item dialogues allow this manual or automatic capture:

- Inventory adjustments
- Stock counts
- Shipping / receiving (DSD, RTV, transfers customer orders)

Retailers have the ability to change the standard name of the GS1 attribute and define up to 10 attributes by subclass that should be captured.

Setup Extended Attributes

Figure 3–16 Setup Extended Attributes Screen

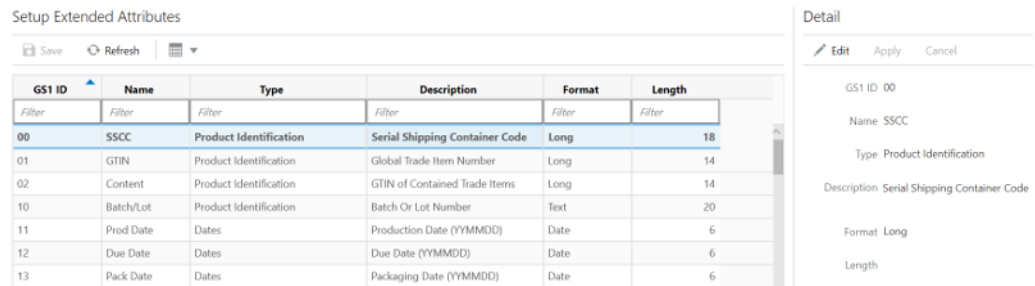

The Setup Extended Attributes screen will be pre-populated with all the current GS1 Application Identifiers and enables the user to view and edit Name, Type and Description of the extended attributes, depending on the business needs for the entire system. The user must have appropriate permission to access the screen and edit extended attributes.

Assign Extended Attributes

Figure 3–17 Assign Extended Attributes Screen

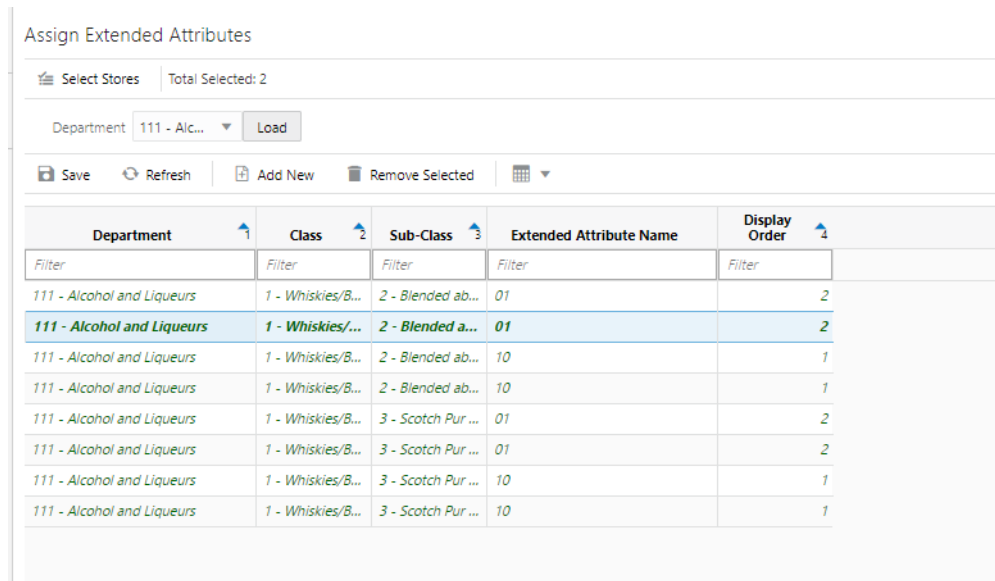

This screen lists the assignments made for the various sub-classes and their display order in the transactions. The assignment made here will be applicable to the stores selected in the select store list. All extended attributes for the current store will replace those of the selected stores. The user must have appropriate permissions to access the screen.

Figure 3–18 Assign Extended Attributes Popup

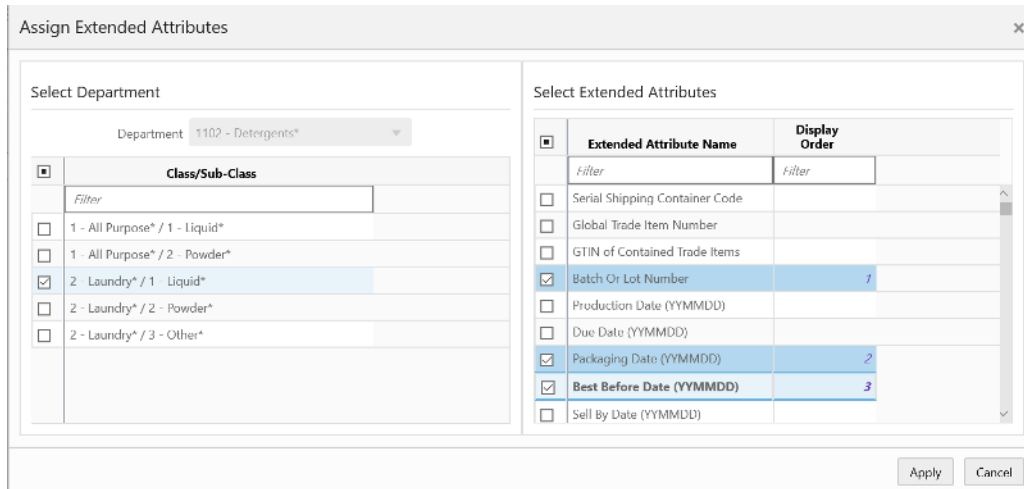

The Assign Extended Attributes popup enables the user to assign the extended attributes to a department/class/sub-class hierarchy and identify the order in which they will be displayed in the data entry screens in the transactions.

Data Setup

The Data Setup chapter covers functionality found within the Data Setup menu of the inventory desktop application.

Feature include:

- [Code Information](#)
- [Delivery Timeslot](#)
- [Inventory Adjustment Reasons](#)
- [Item Scan Number \(ISN\) Types](#)
- [Shipment Reasons](#)
- [Sub-Buckets](#)
- [Custom Flexible Attribute](#)
- [Unit of Measure](#)
- [UDA Print Setup](#)
- [UIN Label Setup](#)

Code Information

Figure 4–1 Code Information

The screenshot shows the 'Code Info' administrative screen. It features a table with columns for Code Type, Code, Description, Sequence, and System. The table contains several rows of data, including codes like B2B, COF, RTV, CHY, TSF, ADM, RAL, PROM, and REPAIR. To the right of the table is a 'Detail' panel with fields for Code Type, Code, Description, System (set to No), and Sequence.

Code Type	Code	Description	Sequence	System
Filter	Filter	Filter	Filter	Filter
Bill of Lading - Fulfillme...	B2B	B2B	2	Yes
Bill of Lading - Fulfillme...	COF	Customer Order Delivery	3	Yes
Bill of Lading - Vendor	RTV	Return To Vendor	1	Yes
Bill of Lading - Vendor	CHY	Charity	2	Yes
Bill of Lading - Transfer	TSF	Transfer	1	Yes
Bill of Lading - Transfer	ADM	Administrative	2	Yes
Bill of Lading - Transfer	RAL	Re-Allocation	3	Yes
Transfer Context Type	PROM	Promotion	1	No
Transfer Context Type	REPAIR	Repair	2	No

The Code Info is an administrative screen for maintaining the code information in the system. You can access this screen by selecting **Code Info** menu from the Admin / Data Setup menu after logging into the desktop application. You need proper permissions to access this screen.

You can create or edit the code information for the below code types in the system. The values setup here should correspond to the same values set up in the external merchandising system to ensure integration.

Table 4–1 Code Types

Code Type	Code Type Description	Usage in the System
RTV	Label RTV	Not used.
RTVR	Return to Vendor Reasons	Not used.
RM	Replenishment	This value is displayed on the Item Lookup under the Replenishment method. Retailers can integrate different display values for replenishment. These values should align with the values received from the merchandising system.
RTW	Label RTW	Not used.
RTWR	Return to Warehouse Reasons	Not used.
CNTX	Transfer Context Type	<p>Context Types drop down selected while creating the new transfer request and creating a new transfer.</p> <p>Example values are PROMOTION, REPAIR.</p> <p>If promotion is selected, you can enter the context value.</p> <p>Context value is enabled if the Context Type is set to 'promotion' (Database value of PROM).</p> <p>If the field is enabled, you can optionally enter a valid or invalid promotion ID.</p> <p>The system will display the promotion ID and the promotion description.</p> <p>Valid promotions are of promotion type and exist in the database.</p> <p>In case the promotion does not exist in the database, the promotion ID will still display, but the promotion description will be unknown.</p>
RTF	Label RTF	Not used.
RTFR	Return to Finisher	Not used.
BOLT	Bill of Lading - Transfer	<p>The motive for the shipment for the Transfer functional area.</p> <p>These values will be listed on the drop down on the Motive field on the BOL detail screen on the transfer shipment.</p>
BOLR	Bill of Lading - Vendor	<p>The motive for the shipment for the Return to vendor functional area.</p> <p>These values will be listed on the drop down on the Motive field on the BOL detail screen on the RTV shipment.</p>
BOLF	Bill of Lading - Fulfillment Order	<p>The motive for the shipment for the Customer Order Delivery functional area.</p> <p>These values will be listed on the drop down on the Motive field on the BOL detail screen on the customer order delivery shipment.</p>

Table 4-1 (Cont.) Code Types

Code Type	Code Type Description	Usage in the System
RCNX	Return Context Type	Context Types drop down selected while doing the return.

The following are the list of codes that are predefined and available after the deployment in the system for you.

You are not allowed to edit or delete the codes that are marked as **System**.

Table 4–2 Predefined Code Types

Code Type	Code	Description	Sequence	System
Item Basket Type	INV	Investigation	1	Yes
Item Basket Type	GR	Gift Registry	2	No
Item Basket Type	LB	Line Bust	3	No
Transfer Context Type	PROM	Promotion	1	Yes
Transfer Context Type	REPAIR	Repair	2	No
Replenishment	C	Constant	5	Yes
Replenishment	D	Dynamic	3	Yes
Replenishment	F	Floating Point	2	Yes
Replenishment	M	Min/Max	6	Yes
Replenishment	T	Time Supply	4	Yes
Replenishment	SO	Store Order	1	Yes
Bill of Lading - Vendor	RTV	Return to Vendor	2	Yes
Bill of Lading - Vendor	CHY	Charity	1	Yes
Bill of Lading - Transfer	TSF	Transfer	1	Yes
Bill of Lading - Transfer	ADM	Administrative	2	Yes
Bill of Lading - Transfer	RAL	Re-Allocation	3	Yes
Bill of Lading - Fulfillment Order	COF	Customer Order Delivery	1	Yes
Bill of Lading - Fulfillment Order	B2B	B2B	2	Yes

Delivery Timeslot

Figure 4–2 Delivery Timeslots

The screenshot shows the 'Delivery Timeslots' administrative interface. It features a table with the following data:

Code	Description	Sequence	Publish
7PM	7pm delivery	80	No
8:00PM	8:00PM Delivery	85	Yes
Noon	Afternoon	20	Yes
Evn	Evening	30	Yes
Late	Late in the Day Delivery	60	Yes
Mid	Midnight 12:00-AM	50	Yes
Morn	Morning	10	Yes
PM	PM Delivery	70	Yes

The 'Detail' panel on the right shows the following information for the selected 'Mid' timeslot:

- Code: Mid
- Description: Midnight 12:00-AM
- Sequence: 50
- Publish: Yes

The Delivery Timeslot screen is an administrative screen for the creating, editing and deleting of delivery timeslots to be used within the system. The timeslots are used within store orders. The screen is accessed from the Admin/ Data Setup menu, the user must have proper permission. Upon initial install, a list of default delivery

timeslots will be available. The delivery timeslots defined here need to match that of the merchandising system, they are not integrated between the two systems.

Each delivery timeslot will require the user to give it a unique alphanumeric code. A description is also required to describe the delivery timeslot. A sequence needs to be assigned, which will be used to give an order to the delivery timeslots when populated on the store orders UI. Lastly, there is a publish indicator that will define if the delivery timeslot on the actual store order is published.

Once a delivery timeslot is created it is saved and it can be edited except for the code, which is not editable. Delivery Timeslots can also be deleted, as long as it is not attached to a store order.

Inventory Adjustment Reasons

Figure 4–3 Inventory Adjust Reasons

Code	Description	Use in UI	Disposition	To Sub-bucket	From Sub-bucket	Publish
11	Stock_on_hand	Yes	+ Stock On Hand			Yes
13	Test_qa6	Yes	+ Customer Order Reserve			Yes
14	Stock on Hand	Yes	+ Stock On Hand			Yes
45	InventoryCustomerReserve	Yes	+ Customer Order Reserve			Yes
75	Stock Count Unavailable To Missing	No	- Unavailable		Trouble	Yes
76	Unit Late Sales Increase SOH	No	+ Stock On Hand			Yes
77	Unit Late Sales Decrease SOH	No	- Stock On Hand			Yes
78	Unit and Amount Late Sales Incre...	No	+ Stock On Hand			Yes
79	Unit and Amount Late Sales Decr...	No	- Stock On Hand			Yes
81	Damaged - Out	Yes	- Stock On Hand			Yes
82	Damaged - Hold	Yes	+ Unavailable	Trouble		Yes

The Inventory Adjustment Reason screen is an administrative screen for the creation and maintenance of inventory adjustment reason codes to be used within the system. The reason codes are used within inventory adjustments. Upon initial install, a list of default inventory adjustment reason codes is available. The reason codes defined here need to match that of the merchandising system.

The following table provides the list of Inventory Adjustment reason codes:

Table 4–3 Inventory Adjustment Reason Codes

Code	Reason	Disposition	To Sub-bucket	From Sub-bucket	UI	System	Transaction	Published Ind
1	Wastage	-Stock on Hand			No	Yes	Wastage	Yes
2	Shrinkage	-Stock on Hand			Yes	No		Yes
3	Repair - In	-Unavailable		Trouble	Yes	No		Yes
75	Stock Count Unavailable to Missing	-Unavailable		Trouble	No	Yes	Stock Count for UIN	Yes, all types except Unit and Amount
76	Unit Late Sales Increase SOH	+Stock on Hand			No	Yes	Late Sales	Yes

Table 4–3 (Cont.) Inventory Adjustment Reason Codes

Code	Reason	Disposition	To Sub-bucket	From Sub-bucket	UI	System	Transaction	Published Ind
77	Unit Late Sales Decrease Sales	-Stock on Hand			No	Yes	Late Sales	Yes
78	Unit and Amount Late Sales Increase SOH	+Stock on Hand			No	Yes	Late Sales	Yes
79	Unit and Amount Late Sales Decrease SOH	-Stock on Hand			No	Yes	Late Sales	Yes
81	Damaged - Out	-Stock on Hand			Yes	No		Yes
82	Damaged - Hold	+Unavailable	Trouble		Yes	Yes	Receiving of Damages	Yes
83	Theft	-Stock on Hand			Yes	No		Yes
84	Store Use	-Stock on Hand			Yes	No		Yes
85	Repair - Out	+Unavailable	Trouble		Yes	No		Yes
86	Charity	-Stock on Hand			Yes	No		Yes
87	Stock Count In	+Stock on Hand			No	Yes	Stock Count	Yes, all types except Unit and Amount
88	Stock Count In	-Stock on Hand			No	Yes	Stock Count	Yes, all types except Unit and Amount
89	Dispose from on Hold	-Stock on Hand and -Unavailable		Trouble	Yes	No		Yes
90	Dispose from SOH	-Stock on Hand			Yes	No		Yes
91	Stock - Hold	+Unavailable	trouble		Yes	No		Yes
92	Admin	-Stock on Hand			Yes	No		Yes
93	Store Customer Return	+Stock on Hand			Yes	No		Yes
94	Product Transformation In	+Stock on Hand			Yes	No		Yes
95	Consignment	-Stock on Hand			Yes	No		Yes
96	Ready to Sell	-Unavailable		Trouble	Yes	Yes	RUA Decrease Receiving.	Yes

Table 4–3 (Cont.) Inventory Adjustment Reason Codes

Code	Reason	Disposition	To Sub-bucket	From Sub-bucket	UI	System	Transaction	Published Ind
98	Product Transformation Out	-Stock on Hand			Yes	No		Yes
180	Customer Order Reservations - In	+Customer Order			No	Yes	Reserve Customer Order In POS	Yes
181	Customer Order Reservations - Out	-Customer Order			No	Yes	Cancel Fulfill Customer Order in POS	Yes
182	Stock In	+Stock on Hand			Yes	Yes	Moving UIN from another store in Inventory Adjustments	Yes
183	Stock Out	-Stock on Hand			Yes	Yes		Yes
184	Unit Late Sales Inventory Adjustment Increase SOH	+Stock on Hand			No	Yes	Inventory Adjustment Late Sales Unit	Yes
185	Unit Late Sales Inventory Adjustment Decrease SOH	-Stock on Hand			No	Yes	Inventory Adjustment Late Sales Unit	Yes
186	Unit and Amount Late Sales Inventory Adjustment Increase SOH	+Stock on Hand			No	Yes	Inventory Adjustment Late Sales UA	Yes
187	Unit and Amount Late Sales Inventory Adjustment Decrease SOH	-Stock on Hand			No	Yes	Inventory Adjustment Late Sales UA	Yes
188	Receipt Hold	-Unavailable	Trouble		No	Yes	Receiving Unavailable	Yes

All reason codes have a disposition associated with them. The disposition is used to define the direction of stock movement for the adjustment. The following table lists the available dispositions:

Table 4–4 Available Dispositions

Display Value	Stock Movement
- Stock On Hand	Decrease Total SOH Decrease Available SOH
+ Unavailable	Decrease Available SOH Increase Unavailable SOH

Table 4–4 (Cont.) Available Dispositions

Display Value	Stock Movement
+ Stock On Hand	Increase Total SOH Decrease Available SOH
- Unavailable	Increase Available SOH Decrease Unavailable SOH
+ Customer Order Reserve	Decrease Available SOH Increase Customer Order Reserve
- Customer Order Reserve	Increase Available SOH Decrease Customer Order Reserve
- Stock On Hand and - Unavailable	Decrease Total SOH Decrease Unavailable SOH
-Unavailable and + Unavailable	Decrease Unavailable SOH Increase Unavailable

Those reason codes that have the **Use in UI** indicator set to 'Yes' appear as reason codes in the Inventory Adjustment dialog.

System reason codes cannot be removed and can only have the description edited. System reason codes are those used within the system for making stock on hand updates, for example, **Stock Count-In** which is used within stock counts.

Note: These are not considered inventory adjustments as the stock count itself represents the transaction of the change.

If the system is configured to use sub-buckets, then the sub-buckets are enabled. Sub-buckets are linked with the inventory adjustment reason codes to make it easy for users to move inventory to, from, and between sub-buckets when adjusting unavailable stock. An example is stock reserved for display or demonstration purposes versus stock that is unavailable because it needs to be repaired. A sub-bucket is a pre-populated list which is defined in the database.

If using sub-buckets, all reason codes that have a disposition which is "to unavailable" stock require a "to sub-bucket" to be selected. Those reason codes that have a disposition which are from unavailable stock require a "from sub-bucket" to be selected.

Note that the -Unavailable and + Unavailable is a disposition used for those retailers that are configured to use sub-buckets. It allows movement of inventory from one sub-bucket to another only within the inventory system. The inventory stays within the unavailable bucket. These adjustments are not published.

The Publish indicator is used for integration purposes. If this check box is checked, the adjustments associated with that reason code are published upon completion of the adjustment. This indicator can only be modified for those reason codes which are normally editable (non-system reason codes). All reason codes installed on setup have this indicator checked, meaning they are published.

Note: A common use of the Publish indicator is the support of initial inventory position seeding from the merchandise system during implementation. Inventory adjustments may come to the inventory system (through a web service) and then updates the inventory per the adjustment; the adjustments do not get published out to the external system per the Publish indicator. Also, the Publish indicator can be used to update inventory positions, from the inventory system, in a custom RMFCS or third-party implementation to synchronize both inventory positions with the corporate system.

Item Scan Number (ISN) Types

Figure 4-4 ISN Types

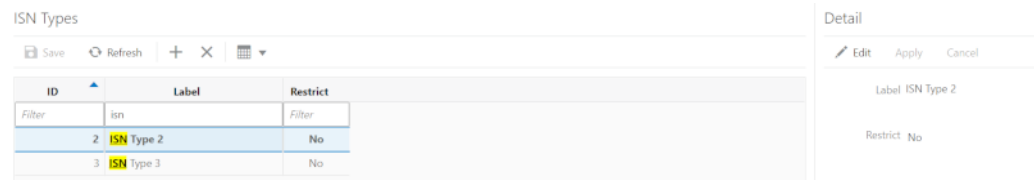

The purpose of the ISN Type screen is to create and maintain user defined ISN types in the system and ISNs those are created via external system or using the ISN Lookup screen can be associated to the types created here. Examples: Serial Number, Part Number, IMEI, Key Number, and so on.

This screen can be accessed from Admin\Data Setup menu on the desktop application. The user must have appropriate security permission to access this screen.

The ISN Types created here will be used while creating item scan number for an item in the Item Scan Number Lookup

Upon initial install, a list of default ISN types is available in the screen. The user can create more ISN types.

The user will be able to provide a label for the ISN Types and set the ISN Type restricted or not, which indicates whether the ISN belonging to this type is PII type. On the ISN lookup screen, ISN data will get filtered based on the restrict flag of the ISN type associated with the ISN record.

Shipment Reasons

Figure 4-5 Shipment Reasons

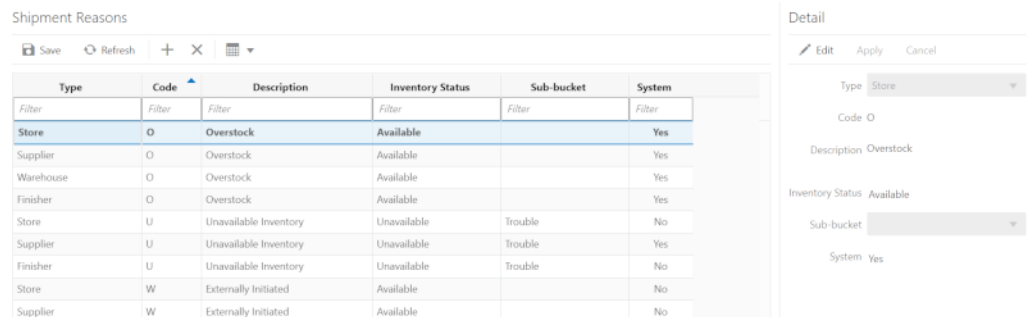

The Shipment Reasons screen is an administrative screen for the creation and maintenance of shipment reason codes to be used within the system. The reason codes are used within Transfer Documents, RTV Documents, Transfer Shipments, and RTV Shipments. Upon initial install, a list of default shipment reason codes will be available. The reason codes defined here need to match that of the merchandising system.

The following table provides the list of shipment reason codes:

Table 4-5 Shipment Reason Codes

Type	Type ID	Code	Description	Use Available	Nonsellable	System
Finisher	4	F	Externally Initiated	Yes		Yes
Store	1	O	Overstock	Yes		No
Warehouse	3	O	Overstock	Yes		No
Finisher	4	O	Overstock	Yes		No
Supplier	2	O	Overstock	Yes		No
Finisher	4	U	Unavailable Inventory	No	Trouble	Yes
Store	1	U	Unavailable Inventory	No	Trouble	Yes
Warehouse	3	U	Unavailable Inventory	No	Trouble	Yes
Supplier	2	U	Unavailable Inventory	No	Trouble	Yes
Store	1	W	Externally Initiated	Yes		Yes
Supplier	2	W	Externally Initiated	Yes		Yes
Warehouse	3	W	Externally Initiated	Yes		Yes

All reason codes have an inventory status associated to them. The inventory status is used to define the inventory bucket which will be relieved when the shipment is dispatched.

Those reason codes that are for the type of Store, Warehouse, or Finisher appear as reason codes in the Transfer dialog. The reason codes that are for the type of Supplier appear as reason codes in the RTV dialog.

System Reason codes cannot be edited or removed. System reason codes are required to be available for use in the system. These values are populated upon install and the system check box is only checked during that process. For those non-system reason codes, once the reason code is saved, only the description can be edited.

If the system is configured to use sub-buckets, then the sub-buckets field will be enabled. Sub-buckets are linked with the shipment reason codes to make it easy for users to move inventory to, from, and between sub-buckets when adjusting unavailable stock. Some examples of these are stock reserved for display or demo purposes versus stock that is unavailable because it needs to be repaired. Sub-buckets can be setup and maintained within the Sub-buckets dialog.

If using sub-buckets, all reason codes that have an inventory status of unavailable will require a sub-bucket to be selected.

Note: Before a reason can be accessed, it is important to associate that reason code to a role that you have the privileges to use in that store.

Sub-Buckets

Figure 4–6 Sub-buckets

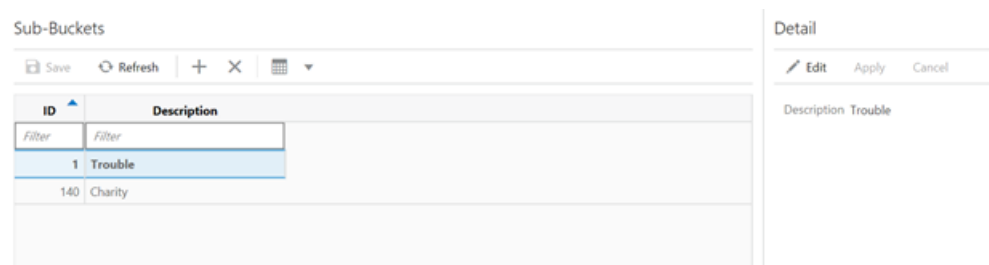

The Sub-buckets screen is an administrative screen for the creation and maintenance of sub-buckets to be used within the system. They allow for breaking down the unavailable (non-sellable) inventory bucket further into smaller buckets or what we call sub-buckets.

The system is configurable to use sub-buckets. If the system is configured to use sub-buckets, they will be available within Inventory Adjustments, RTVs, and Transfers. Sub-buckets are attached to reason codes that update unavailable inventory. The reason codes would be either inventory adjustment reasons or shipment reasons. When you use the reason code on a transaction, the system updates the proper sub-bucket associated with the reason code.

Sub-buckets can be added, deleted and edited via this dialog. Sub-buckets will have a system generated ID along with a user defined sub-bucket description.

Sub bucket id for 'Trouble' is predefined in the system when the system is deployed.

Custom Flexible Attribute

Figure 4–7 Custom Flexible Attribute

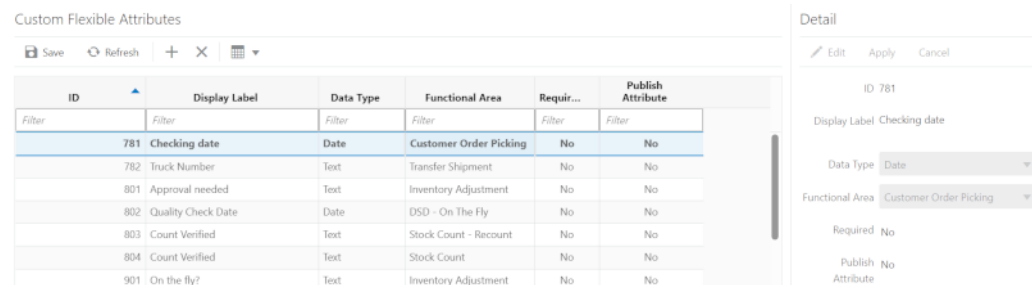

The Custom Flexible Attributes screen is an admin screen used to setup and maintain transaction level flexible attributes for transactions including:

- Customer Orders
- Customer Order Picking
- Customer Order Reverse Picking
- Customer Order Delivery
- Inventory Adjustment
- Transfer Document

- Transfer Shipment
- Transfer Shipment Container
- Transfer Receive
- Transfer Receive Container
- RTV Request Approve
- RTV Shipment
- RTV Shipment Container
- Stock Count
- Stock Count - Recount
- DSD - PO, DSD - PO & ASN, DSD - On the fly
- DSD Container
- Replenishment Pick List, Scan List, Shelf Adjustment
- Item Basket
- Item ISN
- Store Order

The flexible attributes set up here will be available in mobile in the respective transactions and you can capture values for these attributes. Appropriate permissions are needed to access, edit and delete flexible attributes.

The flexible attributes can be set up to have values in any of the following data types: Text, Date, Decimal and Long. You can also set minimum and maximum range for values that you can enter for these flexible attributes in the transactions in mobile. The retailer also has the flexibility to set up certain flexible attributes as mandatory. This requires the user to specify values for them before confirming the transaction in mobile. The retailer can also set up to publish certain flexible attributes to external systems.

Unit of Measure

Figure 4–8 Unit of Measure

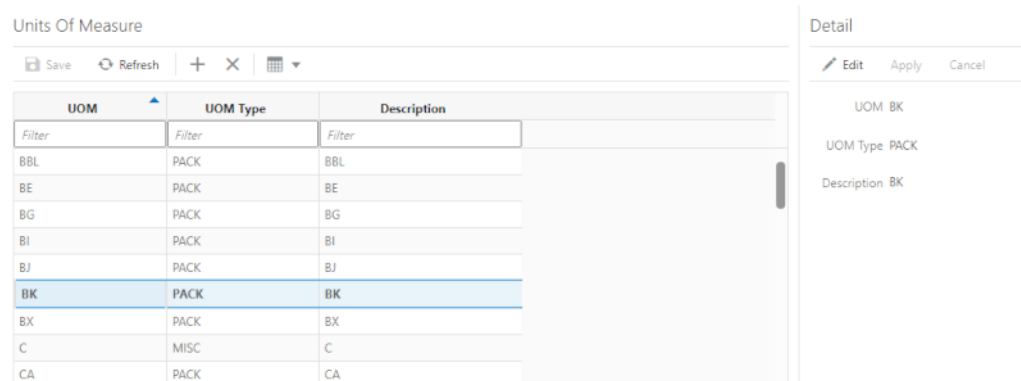

The Units of Measure screen is an administrative screen for the creating, editing and deleting of Units of Measure to be used within the system. The screen is accessed from

the Admin / Data Setup menu, the user must have proper permission. Upon initial install, a list of units of measure will be available.

Each Unit of Measure record will require a UOM, which is the alphanumeric code to identify the unit of measure. The code is what is displayed on the UI. It does not need to be unique. Next a UOM type is assigned to the Unit of Measure, this is selected from a list which is hard coded in the system, that is, 'VOL' or 'MASS'. Lastly, the unit of measure needs to have a description to describe the UOM.

Once a unit of measure is created it is saved and can be edited except for the UOM code, which is not editable. Unit of Measures can also be deleted, if it is not being used by an item or a transaction in the system.

UOM codes need to match those in external systems to ensure correct processing.

UDA Print Setup

The system can automatically generate tickets and labels for items when user-defined attribute (UDA) values change. The UDA Print Setup function allows you to define whether new tickets or labels, or both, should be printed automatically when particular UDA values change.

User can access the dialog from the desktop application by selecting the menu Admin/Data Setup/UDA Print Setup.

These print settings affect all stores because user-defined attributes are not specific to stores. This function is only available to users with the required permissions.

Figure 4–9 UDA Print Setup

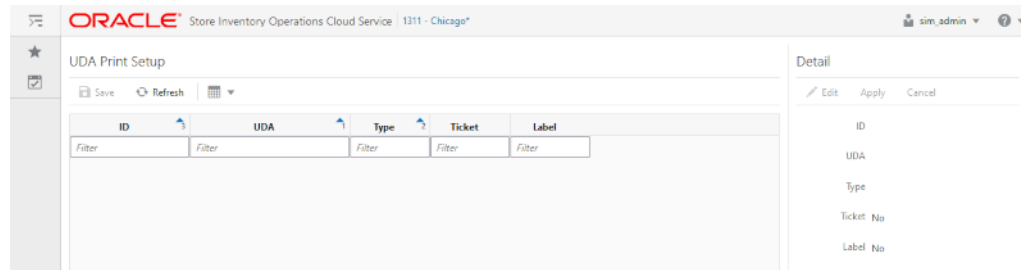

Specify Whether Tickets or Labels Are Printed Automatically

To control whether tickets or labels are printed automatically when a UDA changes, select the UDA and edit to switch on/off the printing Tickets and Labels.

When an item has a changed UDA, the system will generate ticket or label or both for that item based upon the setup on this screen.

UIN Label Setup

The UIN Label Setup screen allows the user to set customized name for the UIN. The UIN Label is used for displaying on various screens and report in the application, this may include Serial Number, IMEI, SIN, License Number, Part Number, and so on.

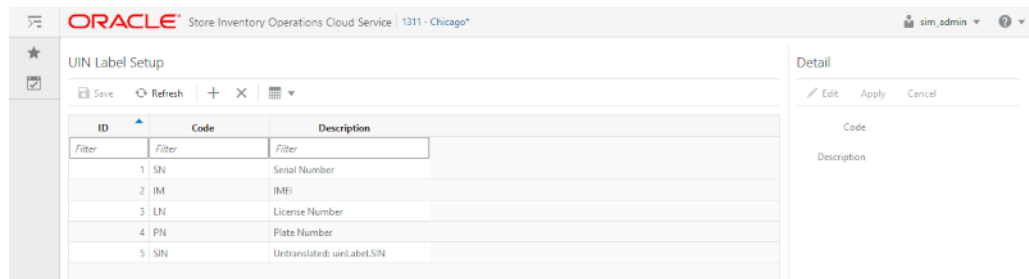
Figure 4–10 UDA Label Setup

The screenshot shows the Oracle UIN Label Setup interface. The main area displays a table with the following data:

ID	Code	Description
Filter	Filter	Filter
1	SIN	Serial Number
2	IMEI	IMEI
3	LN	License Number
4	PN	Plate Number
5	SIN	Untranslated: uinLabel.SIN

To the right of the table is a 'Detail' panel with the following controls:

- Buttons: Edit, Apply, Cancel
- Input fields: Code, Description

On this screen, the user can add the new Labels for the UIN and provide the description.

The code entered here must match the one that is coming from the external system for correct processing.

Once the new UIN label is created and saved, the system identifies the label based on the code and uses it in the application.

The Operations chapter covers functionality found within the Operations menu of the desktop.

Features include:

- Product Group
 - Product Group (List)
 - Product Group Detail (Common)
 - Product Group Detail (Stock Counts)
 - Product Group Detail (Problem Line)
 - Product Group Detail (Shelf Replenishment)
 - Product Group Detail (Auto Ticket Print)
 - Product Group Detail (Store Order)
- Product Group Components
- Product Group Scheduler
 - Product Group Schedules (List)
 - Product Group Schedule Detail
- Area
- Format Assignment
- Printer Setup
- Import Ticket Template
- Ticket Print Format
- Reports
- Operational Views
 - Out of Stock
 - New Items
 - Expiring Items
 - Stock Counts - Ready to Authorize
 - Shop Floor Out of Stock

Product Group

Within the system, product groups are used to group items in order to perform various actions on them. Merchandising system are constantly adding, editing, and removing items to be sold. Creating groups of products based on attributes of an item is an efficient way of automatically including or excluding changed items when repeatable transaction is created. Product groups can be comprised of entire areas of the merchandise hierarchy (for example, an entire subclass) or can be simply a group of individual and unrelated items. A scheduling tool can then be used to extract the items for further processing at set intervals. Product groups are used by various functional areas.

Product Group (List)

Figure 5–1 Product Groups (List)

Product Groups

Refresh Create Delete

ID	Description	Type	Store
Filter	Filter	Filter	Filter
1681	UA-M-5-04	Unit and Amount	1311 Chicago*
1541	UA-2/27-All items	Unit and Amount	1311 Chicago*
1482	UA-Auto-2/19-2	Unit and Amount	1311 Chicago*
1481	UA-Auto-2/19-1	Unit and Amount	1311 Chicago*
1465	UA-2d-M-2/15-2	Unit and Amount	1311 Chicago*

Detail:

Edit Save Cancel

Type *Select*

This is the **Product Groups** screen which is accessed by selecting **Product Group** from within the **Operations** menu. It lists all types of product groups that are created in the system, fields include ID (system generated), description, type and store. From this screen you can filter down the list.

Selecting a product group displays the details in the detail portion of the screen (see below). From there the details can be viewed or edited. Unit and Amount product groups that are attached to schedules can only be edited if the [(start date - today) >= stock count lockout days].

New product groups can be created by clicking on **Create**. Product groups can be created and maintained for Unit, Unit and Amount, Problem Line, Store Orders, Auto Ticket Print, and Shelf Replenishment types. Each type has unique attributes and functionality. Deleting of a product group is also possible (assuming proper permissions) by selecting the group and clicking on **Delete**. Product groups which are attached to schedules cannot be deleted.

Product Group Detail (Common)

Figure 5–2 Product Groups Detail - New

Detail New

Edit Save Cancel

* Type Unit

* Description BB Dept Unit Apparels

1311 - Chicago* All Stores

Variance

Variance SUOM

Variance %

Counting Method

* Counting Method Unguided

Hierarchy Breakdown None

Re-Count Discrepancies

Auto Authorize

Item Status

Active

Inactive

Discontinued

Deleted

Stock On Hand

SOH = 0

SOH > 0

SOH < 0

This is the **Product Groups** screen with focus on the **Detail** section. New product groups can be created by selecting the **New** menu option. Each type has unique attributes that are required which will drive different functionality. Once all the appropriate attributes have been added for the product group, the product group can be saved, and it will be available in the **Product Group Component** dialog to assign components.



Common fields for all product group types include:

- **Type:** Type of product group. Defined at time of creation.
 - Unit, Unit and Amount, Problem Line, Store Orders, Auto Ticket Print, and Shelf Replenishment
 - Types dependent upon data permissions
- **Description:** Entry field to describe the product group.
- **Store:** User's Store (single store) or All Stores. All Stores is only displayed if All Stores permission exists.
 - User's store (single store) - Product Group is only available to that store
 - All Stores - Product Group is available for all users that have the All Stores permission at all/any store

Product Group Detail (Stock Counts)

Figure 5–3 Product Groups Detail - Unit

Detail: 82

 Edit  Save  Cancel

Type

Description unit 100000112

Variance

Variance SUOM

Variance % 0

Counting Method

Counting Method

Hierarchy Breakdown

Re-Count Discrepancies

Auto Authorize

Item Status

Active

Inactive

Discontinued

Deleted

Stock On Hand

SOH = 0

SOH > 0

SOH < 0

This is the **Product Groups** screen with focus on the **Detail** section for a **Unit** type product group. Specific fields pertaining to Unit, Unit and Amount, and Problem Line Stock Counts include:

- Variance SUOM
 - Variance is defined in terms of SUOM (standard unit of measure). It is used to determine if an item is discrepant on the stock count. The system compares the total SOH inventory level with the quantity entered on the count by you.
 - An item is discrepant if it deviates + or - over or equal to the Variance SUOM unless the variance SUOM is 0. If the variance is 0 and the count equals the SOH, then the item is not discrepant.
 - Used for Unit, Unit and Amount and Problem Line stock counts.
 - A blank value means that it will not be used to determine discrepancies. Can only be blank if the variance % or variance value has a value.
 - A value of 0 means that the item cannot be discrepant at all, and the exact quantity must be counted.
- Variance %
 - Variance is defined in terms of percentage. An item is discrepant if it deviates + or - over or equal to the Variance % unless the variance % is 0. If the variance is 0 and the count equals the SOH, then the item is not discrepant.
 - Used for Unit, Unit and Amount and Problem Line stock counts.
 - A blank value means that it will not be used to determine discrepancies. Can only be blank if the variance SUOM or variance value have a value.
 - A value of 0 means that the item cannot be discrepant at all, and the exact quantity must be counted.
- Variance Value

- This will be a cash amount that will be compared to the number of discrepant units x current retail price of the item. If the calculated value exceeds the Variance Value, then the item would be considered discrepant.
- Only Unit and Amount types.
- A blank value means that it will not be used to determine discrepancies. Can only be blank if the variance % or variance SUOM have a value.
- A value of 0 means that the item cannot be discrepant at all, and the exact quantity must be counted.
- Counting Method - method of counting
 - Guided - system will guide you through the items on the stock count when counting.
 - * If the store does not sequence items (Display Sequence fields store parameter), the Guided option will not be available
 - Unguided - system does not guide you through the items on the stock count.
 - Third Party
 - * Must have Third Party data permission
- Hierarchy Breakdown - used to determine if the system should break down the stock count into multiple child stock counts.
 - None - stock count will not be broken down.
 - Location - master count with child counts grouped by location.
 - Department - master count with child counts grouped by department.
 - Class - master count with child counts grouped by class.
 - Sub-class - master count with child counts grouped by sub-class.
- Re-count Discrepancies - defines whether a recount should be done for discrepant items.
 - Unchecked and disabled when the counting method is Third Party.
- Auto Authorize - if checked the stock count will be automatically authorized and there will not be a manual authorization stage.
- Item Status - status of items to include on the product group.
 - Only enabled for Unit types
 - * Must have at least one status checked
 - Statuses
 - * Active
 - * Inactive
 - * Discontinued
 - * Deleted
 - Unit - Active, Inactive and Discontinued checked
 - * All statuses enabled
 - Unit and Amount - Active, Inactive, Discontinued, and Deleted checked
 - * All statuses disabled

- Problem Line - Active, Inactive and Discontinued checked
 - * All statuses disabled
- Stock on Hand - used to determine what inventory state of items will be put on the stock count.
 - Values
 - * SOH = 0
 - * SOH > 0
 - * SOH < 0
 - Unit
 - * SOH = 0, SOH > 0, SOH < 0 checked and all enabled
 - Unit and Amount
 - * SOH = 0, SOH > 0, SOH < 0 checked and all disabled
 - Problem Line
 - * SOH = 0 and SOH > 0 checked and disabled
 - * SOH < 0 checked and enabled

This value must be checked if none of the Problem Line criteria are checked

Product Group Detail (Problem Line)

Figure 5-4 Product Groups Detail - Problem Line

Detail New

Edit Save Cancel

* Type Problem Line

* Description Problem Line- Dept Apparels

1311 - Chicago* All Stores

Variance

Variance SUOM 1

Variance % 1

Counting Method

* Counting Method Unguided

Hierarchy Breakdown None

Re-Count Discrepancies

Auto Authorize

Item Status

Active

Inactive

Discontinued

Deleted

Stock On Hand

SOH = 0

SOH > 0

SOH < 0

Problem Line

Actual Shelf Repl Amount less than Suggested

Actual Customer Order Pick Amount less than Suggested

Negative Available Inventory

This is the **Product Groups** screen with focus on the **Detail** section for a **Problem Line** type product group. Note that problem line product groups have additional attributes that are noted in the section above, however these three fields are specific only to Problem Line product groups.

- Actual Shelf Repl Amount less than Suggested - If checked, the item will be added to the problem line count if the actual amount on the shelf replenishment pick list is less than that of what was suggested.
- Actual Customer Order Pick Amount less than Suggested - If checked, the item will be added to the problem line count if the actual pick amount for customer order entered for the item on the pick list was less than the suggested system pick amount.
- Negative Available Inventory - If checked, the item will be added to the problem line stock count if the item has negative available inventory.
- UIN Discrepancies - If checked, the item will be added to the problem line stock count if the item has UIN discrepancies.

Product Group Detail (Shelf Replenishment)

Figure 5-5 Product Groups Detail - Shelf Replenishment

Detail: 121

Edit Save Cancel

Type Shelf Replenishment

Description Shelf 100000112

1311 - Chicago* All Stores

Replenishment

Auto - Replenishment

Diff Type Select

This is the **Product Groups** screen with focus on the **Detail** section for a **Shelf Replenishment** type product group. The attributes specific to Shelf Replenishment includes:

- Auto-Replenishment - indicates whether the product group items will be adjusted during the nightly batch.
 - Once the product group is scheduled (if this is checked), complete the shop floor function of the end of the day batch will run nightly and adjust for the product groups which have been scheduled for that time.
 - If unchecked, no auto replenishment will run.
 - Diff Type - indicates the diff that will be used for the Display shelf replenishment method.
 - * Values: Diff1, Diff2, Diff3, Diff4

Product Group Detail (Auto Ticket Print)

Figure 5–6 Product Groups Detail - Auto Ticket Print

This is the **Product Groups** screen with focus on the Detail section for an **Auto Ticket Print** type product group.

This option allows the user to indicate if they want a stock on hand refresh of the tickets before printing.

The print quantity is updated with the Stock on hand based on the refresh quantity indicator in the product group.

1. For the format type=Item Ticket, the system populates the print quantity of the item tickets with current SOH.
2. For an item with the format type=Shelf Label, the system populates the print quantity of the shelf label quantity with the shelf capacity quantity defined in the sequence table.
3. For an item with format type = Item, ticket, if the SOH > 0 then the ticket qty = SOH. If SOH <=0 then ticket qty = 0.
4. For an item with format type = shelf label, if the label quantity > 0 then the ticket qty = label quantity. If label<=0 then the ticket qty = 0.
 - If the ticket contains the print date, the system sends the tickets to the printer based on the print date. (PRINT DATE <=CURRENT DATE)
 - For the manually created tickets, the system checks the auto print flag which indicates whether the system must consider the ticket for the auto printing.
 - If the qty = 0 to print, the system prints nothing.

Auto Generated Tickets

The system auto generates tickets and shelf edge labels for the price changes, clearance events, promotions and description changes depending on the below store parameters.

If the parameter is on, the system generates the ticket when the respective price change event or description change data comes into the system from the merchandising system.

The auto ticket printing batch further submits the generated tickets to the printing service based on the product group schedule.

- Auto Generate Item Tickets for Clearance Price Changes
- Auto Generate Item Tickets for Description Changes
- Auto Generate Item Tickets for Promotion Price Changes

- Auto Generate Item Tickets for Regular Price Changes
- Auto Generate Shelf Edge Labels for Clearance Price Changes
- Auto Generate Shelf Edge Labels for Description Changes
- Auto Generate Shelf Edge Labels for Promotion Price Changes
- Auto Generate Shelf Edge Labels for Regular Price Changes

Auto Ticket Print Batch

The purpose of this is to send tickets that match the product group items setup in the store for printing. First it finds pending Item Tickets within the store that matches the **Auto Ticket Print** product group for the day. Then it updates the quantity of the tickets if the refresh flag was enabled for that product group.

It further sorts the tickets and will also consolidate tickets and update across all batches within a batch generation method (Product Group, External or Manual generated) those item tickets matching all the following:

- Item number
- Print date
- Format type
- Format

The system breaks it in to blocks as configured in **Maximum Ticket Quantity to Print** store parameter and sends the request to the 3rd party service for the print.

Product Group Detail (Store Order)

Figure 5–7 Product Groups Detail - Store Order

The screenshot shows a web-based form titled "Detail New" for creating a "Store Order" product group. The form is divided into several sections:

- Form Header:** Includes "Edit", "Save", and "Cancel" buttons.
- Main Fields:**
 - * Type: Store Order (dropdown)
 - * Description: 1311 - Chicago* (text input with a blue highlight and "All Stores" link)
 - Days Before Delivery: (dropdown)
 - Add Items: (checkbox)
- Right Column (Attributes):**
 - Supplier: (dropdown)
 - Warehouse: None (dropdown)
 - Department: None (dropdown)
 - Class: None (dropdown)
 - Sub-Class: None (dropdown)
 - Area: None (dropdown)
 - Store Order Items: (checkbox)
- Restrictions:** A section at the bottom of the form.

This is the **Product Groups** screen with focus on the **Detail** section for a **Store Order** type product group. Creating and scheduling a product group for store orders, allows for the generation of a system generated store order. The store order will be generated online for schedules for today's date, otherwise the store order will be generated via the nightly batch schedule. The store order will be editable and allow for items to be added, edited and removed.

The product group attributes specific to Store Orders includes:

- Days Before Delivery - The date the user wants the Store Order to be delivered by. Will be used to set the Request Date on the Store Order.
 - Store Order Create Date + Days Before Delivery = Request Date

- Add Items
 - Checked - the user will be able to add additional items manually to the store order once it is generated by the system.
 - Unchecked - the user cannot add any other items to the store order, only the items that were added by the system can be ordered.

Restrictions - restrictions can be assigned to the store order product group. The assigned restrictions will be used to restrict the items that get added to the system generated store order on the mobile. These are the same restrictions that are available when creating a manual store order on the mobile. See the *Oracle Retail Store Operations Cloud Service User Guide - Store Order* chapter for details around these restrictions. The restrictions will not be validated/enforced when adding components to the product group.

- Supplier
- Warehouse
- Department
- Class
- Sub-Class
- Area
- Store Order Items

Product Group Components

Figure 5–8 Product Group Components Screen

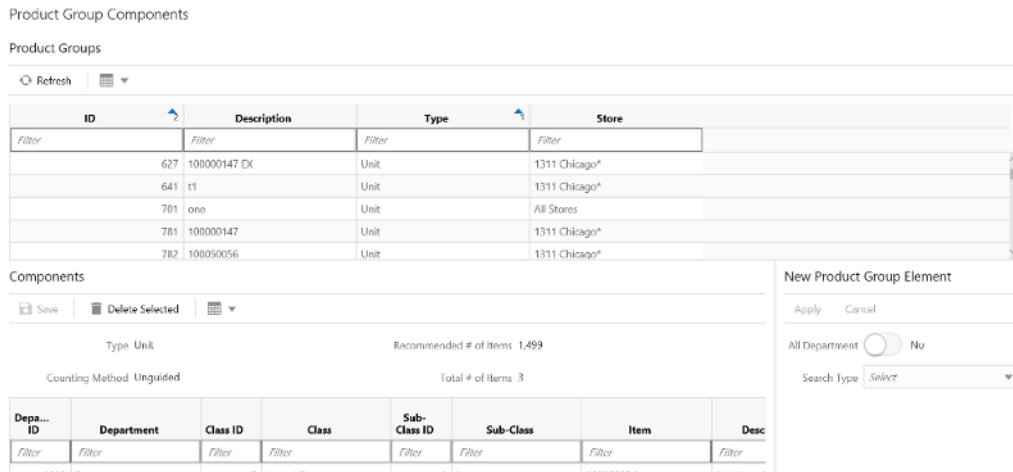

This figure shows the **Product Group Components** screen. It is accessed by selecting **Product Group Component** under the **Operations** menu. The screen consists of two parts. The top part lists of all product groups in the system. The bottom part displays the component details for the selected product group in the top part. Product Groups are created in the Product Groups dialog, see above. Initially after a product group is first created there are no components assigned and the bottom part will be blank, until components get added.

The **Recommended # of Items** field will display the maximum number of items allowed for the type of product group selected. This field always displays and is

pre-populated based on the system option associated with the product group. Note that the items on the product group may still exceed this value, it is just a recommendation and will also be used at the time of generation/extraction when doing the UI break down.

The **Total # of Items in Group** field will display the estimated number of items in the group based on the criteria selected. This estimate includes the number of ranged transaction level items added. It does not take into account other factors such as status, stock on hand, pack breakdown, and so on. When the actual extraction happens, these factors will be taken into account.

You can select components on the screen using various selection criteria. You can create a combination of items and/or hierarchies for a group.

- All Departments - Unit, Unit and Amount, Problem Line
 - All Departments get added to the product group
 - Cannot be used in conjunction with any other component type
- Item - Unit, Problem Line and Shelf Replenishment
- Hierarchy (Department / Class /Sub-class) - Unit, Unit and Amount, Problem Line, Auto Ticket Print, Store Order, and Shelf Replenishment
- Supplier - Unit, Problem Line, Auto Ticket Print, Store Order, and Shelf Replenishment
 - Items for the supplier will be added to the product group including non-ranged and 'Q' status items.
- Style - Unit, Problem Line, Auto Ticket Print, Store Order, and Shelf Replenishment
 - All child level items (transaction level = item level) for the entered item are added. Non-ranged and 'Q' status items included.
- Item Basket - Unit, Problem Line, Auto Ticket Print, Store Order, and Shelf Replenishment
 - User can select an Item Basket and all the items present in the item basket get added to product group. The item baskets that are 'completed' and 'static' will be in the list.

Product Group Scheduler

[Product Group Schedules \(List\)](#)

[Product Group Schedule Detail](#)

Product Group Schedules (List)

Figure 5–9 Product Group Schedules

Product Group Schedules

Refresh Create Delete

ID	Description	Group	Next Date	Final Date	Status	Store
<i>Filter</i>	<i>Filter</i>	<i>Filter</i>	<i>Filter</i>	<i>Filter</i>	<i>Filter</i>	<i>Filter</i>
1630	Unit-5/4-2	1682 - Unit-5/4-1		4/5/19	Open	Chicago*
1631	unit-5/4-33	1682 - Unit-5/4-1		4/5/19	Open	Chicago*
1632	unit-5/4-56	1682 - Unit-5/4-1		4/5/19	Open	Chicago*
1641	Unit-4/16-1	1761 - Unit-4/16-1		4/17/19	Open	Chicago*

The **Product Group Schedules** (list) screen displays a list of product groups which have been scheduled. It is accessed by selecting **Product Group Scheduler** from the **Operation** menu. All product groups appear in the list, and you can filter the list down further if necessary. Fields include a system generated ID, description, (product) group, next date the schedule is supposed to take place, final date of the schedule, status and store which will display the store it was created for or 'multiple' if for more than one store.

Product group schedules can be deleted (assuming proper permissions). If a schedule is deleted that has a stock count created which is in 'new' status, the stock count will also be deleted. If a stock count exists, but it is not in 'new' status, the stock count will remain and only delete the schedule.

Selecting a schedule will navigate into the details for the schedule on the **Product Group Schedule Detail** screen. By choosing the create icon, you navigate to the **Product Group Schedule Detail** screen to create a new product group schedule.

Product Group Schedule Detail

Figure 5–10 Product Group Schedule Detail Screen

Product Group Schedule Detail

Back Save

Schedule ID: 1630

Product Group Type: Unit

Product Group: 1682 - Unit-5/4-1

Description: Unit-5/4-2

Start Date: 4/5/19

End Date: 4/5/19

Schedule

Daily Weekly Monthly Yearly

Days Between Occurrences: 1

Repeat Every Weekday

Locations: 2 / 37

Assign Selected Revoke Selected

Store: 0 - starter store

This is the **Product Group Schedule Detail** screen which is accessed by either creating a new product group schedule or selecting an existing product group schedule from the **Product Group Schedules** screen. The product group schedule will be editable for all **open** status product groups with one exception for unit and amount types. Unit

and Amount Schedules can be edited if they are 'open' and the [(Start Date - Today) >= Stock Count Lockout Days].

This screen allows you to schedule specific types of product groups. The type of product groups that can be scheduled are Unit, Unit and Amount, Problem Line, Auto Ticket Print, Store Order, and Shelf Replenishment. Once a type is selected different fields for the schedule will be applicable.

The product group can be scheduled for a date range. For Unit, Problem Line, Auto Ticket Print, Store Order, and Shelf Replenishment the start date must be > = today and the end date must be > = start date. For Unit and Amount the start date must be > = today + Stock Count Lockout Days and the end date is set to that of the start date and is not editable.

The schedule portion of the screen allows to setup when the schedule should occur. It can be scheduled daily, weekly, monthly, and yearly as applicable. This portion is only allowed for Unit, Auto Ticket Print, Store Order, and Shelf Replenishment types. Note that caution needs to be taken when creating schedules as there may be situations where a schedule may not be always applicable. For example, a schedule that starts Jan 1 through Dec 31 that is to occur every month on the 31st of the month is not applicable in all months, February has 28 days, April has 30 days, and so on. In this case those months will not have anything generated by the batch.

Lastly, a store or stores needs to be assigned to the schedule. If the Product Group was created for a single store, the available locations list is restricted to the single store the product group was created for. If the product group was created for **All Stores**, the available locations list all available locations that you have privileges for. The stores that will be listed will be only those in which the user has permissions for, and they must be defined as SIOCS Managed stores.

Once a product group schedule has been saved the system may execute the processing to generate the transaction if it was scheduled for today. For stock counts (Problem Line and Unit) if there is an existing 'New' status stock count, the system will update that stock count, otherwise it will generate a new one. For Store Orders, the system will always create a new store order.

Area

An area consists of one or more item baskets that are grouped together to make up an area. The area can be associated with a physical location/area of a store, or it may just be a logical grouping from a merchandise hierarchy. Area examples could be Men's Department, third floor, or aisle 27.

Areas are used within:

- Customer order picking. When doing a pick, if the store is configured, the user may choose an area to pick.
- Store Orders Restrictions - Both when creating a manual store order on mobile as well as a system generated via a product group.

Figure 5–11 Area List

The screenshot shows the 'Area List' interface. At the top, there is a search bar with a magnifying glass icon, a search button, and the text 'Status = In Progress | Search Limit = 50'. Below this is a toolbar with 'Results: 1', a 'Refresh' button, a 'Create' button, a 'Delete' button, and a calendar icon. The main content is a table with the following columns: Area ID, Description, Status, Date, and User. The first row of data shows Area ID '461', Status 'In Progress', and Date '11/4/19'. The user is 'sim_admin'. The other columns in the first row are labeled 'Filter'.

Area ID	Description	Status	Date	User
Filter	Filter	Filter	Filter	Filter
461		In Progress	11/4/19	sim_admin

The Area List screen is accessed by selecting **Area** from the **Operations** menu. The screen lists existing areas that have been created for the user's store, the default is for **In Progress** areas. The search option directs the user to the **Search Criteria** screen to search for other areas, search criteria are displayed. The create option will go to the **Area Detail** screen to create a new area. **Delete** will allow for deletion of an **In Progress** or **Completed** area in which it will get marked to **Canceled** status. Lastly, a user can select an area to navigate into the details of that area to view or edit.

Figure 5–12 Area Search

The screenshot shows the 'Area Search Criteria' dialog box. It contains several input fields and a search button. The fields are: Area ID (empty), Description (empty), Status (dropdown menu set to 'In Progress'), From Create Date (calendar icon), To Create Date (calendar icon), From Last Update Date (calendar icon), To Last Update Date (calendar icon), User (empty), and Search Limit (50). At the bottom, there are three buttons: 'Search', 'Reset', and 'Cancel'.

The **Area Search Criteria** screen is accessed by selecting the **Search** option from the **Area List** screen. This screen allows a user to enter in various criteria to search for

additional areas. Once criteria has been entered, when search is selected, the user returns to the **Area List** with the list of area results being displayed based upon the entered criteria. The search criteria entered will remain until the user exits the dialog. There is a search limit default which is defaulted based upon a system configuration.

Figure 5–13 Area Detail

The **Area Detail** is accessed from the **Area List** by either selecting an existing area record or selecting the create option. To create a new area, the system generates a unique Area ID, and the user would enter a description for the area. The user selects an item basket ('static' or 'dynamic') from a list of item baskets that are **Completed** status for the user's store or All Stores, which are 'hierarchy' or 'All Department' (created on the desktop). The last step is to select a store or stores for the area. If the item basket selected was for the user's store, the stores list will include only the user's store. If the item basket was for 'All Stores' the store list will include a list of all stores in which the user has privileges. After all fields have been entered, the user can either save or confirm the area. Save will update the area as **In Progress** which will allow for editing and it will not be available for use on a customer order pick. Confirm will mark the area to **Completed** status and it will no longer be editable, and the area will be available for use on a customer order pick.

Format Assignment

The **Format Assignment** screen is used to auto assign the formats when generating a ticket event based on a **Format** type and price event. This allows the retailer to override the default ticket format for specific categories of items and/or events. For example, if the retailer has both clothing and electronics, they could print a hangtag and a ticket with a sticky back label. Since it is by price event, they could for the hangtag create a clearance ticket that has a sticky back.

Formats can be assigned at the selected item basket level for all stores or selected stores. It could be done for price type wise such as Permanent, Clearance and Regular.

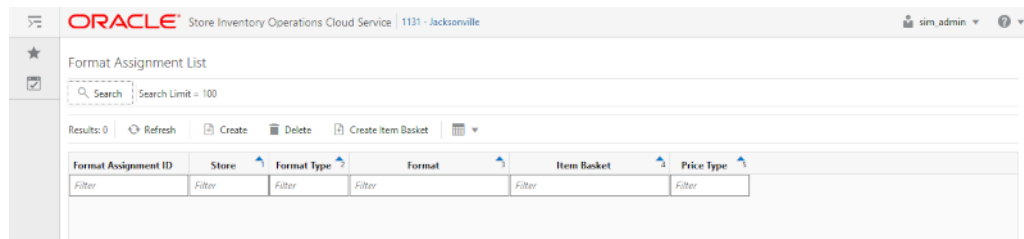
Figure 5–14 Format Assignment List

This screen can be accessed from Operations / Format Assignment. When this screen is accessed, the system displays the **Format Assignment Search Criteria** and allows the user to refine the search for the system to show the results.

To create a new assignment, the user can select the create option and go to the detail screen and save the assignments.

From this screen, the user has an option to create new item baskets. When the user selects the **Create Item Basket**, the system takes the user to the **Item Basket** dialog and use the item basket to assign the format.

Figure 5–15 Format Assignment Search Criteria

The **Format Assignment Search Criteria** appears automatically when the user selects the Format Assignment. The user can also select the search option to access this screen and enter the search criteria to refine the search.

The format assignment list displays the results based on the criteria given here.

There is a search limit default which is defaulted based upon a system configuration.

Figure 5–16 Format Assignment Detail

The format assignment detail screen is accessed when the create option or an existing format assignment id is selected from the **Format Assignment List**.

Format can be assigned based on the Item Basket and assigned store wise.

- If the Item Basket was NOT created for 'All Stores' (single store), the Available locations list will be restricted to the single store the Item Basket was created for.
- If the Item Basket was created for 'All Stores', the Available locations will list of all available locations that the user has privileges for.

Printer Setup

Figure 5–17 Printer Setup Screen

Name	Description	Type	Address	Manifest Default	Pre-Shipment Default
Filter	Filter	Filter	Filter	Filter	Filter
ITPrinter1	ITPrinter1	Item Ticket	ITPrinter1	No	No
SLPrinter1	SLPrinter1	Shelf Label	SLPrinter1	No	No

On this screen, the user can create printers for the **Item Ticket**, **Shelf label** and **Postscript** types.

When tickets are generated and submitted to printers for printing, the system sets the printer to which it must be printed. The printers created in this dialog for ticket and labels are used in the ticketing dialog when user submits to print the tickets.

Printer details are sent as part of Manifesting or the pre-shipment notification. The **Printer Setup** screen is an admin screen to create new printers and assign the address of the printers. Printers can be added, modified and deleted using this screen. The printers that are setup in this screen are specific to the store. You will also be able to specify the default printer for manifesting and pre-shipment notifications.

On this screen, the user can also create printers for the **Item Ticket** and **Shelf Label** types.

The screen is accessed via the menu: Operations / Printer Setup.

You must have **Access Printer** permission in order to access this screen.

Import Ticket Template

Figure 5–18 Import Ticket Template

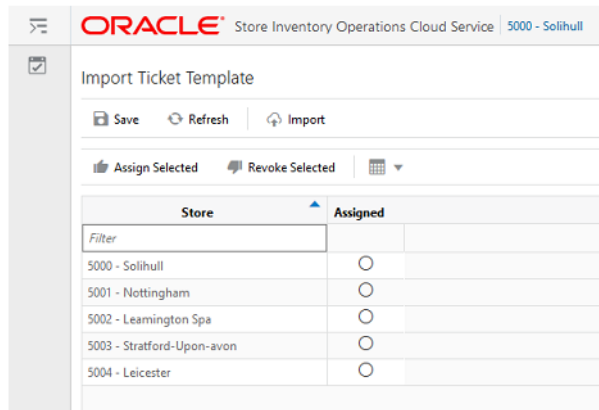
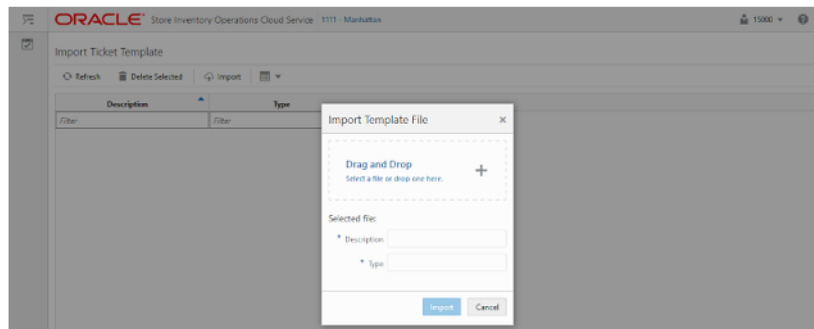

Figure 5–19 Import Template File



This screen can be accessed in the desktop application from Operations/Import Ticket Template menu.

This screen is for the user to import the 3rd party file templates such as ZPL for ticket printing.

The imported files contain the format/layout design for the ticket. It will be used in the application when sending the print jobs to the printer based on the format to which the file is assigned.

The files are created using the external application and uploaded for the system to understand the design layout of the ticket.

On this screen, the user can import multiple template files and assign it to the ticket format on the **Ticket Print Format** screen.

The user when selects the Import button, the system allows to drag and drop or select a file, provide the description and the type in free text and import of the file.

These files are listed on the **Ticket Print Format** screen.

The delete option allows the user to delete a file which is not used.

Note: The system does not validate the content of the file whether it is as per the standard of the printer. It just validates to make sure the non-ASCII file is not allowed to import.

Ticket Print Format

Figure 5–20 Ticket Print Format

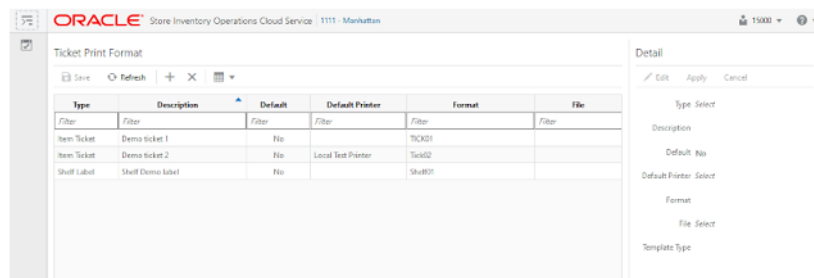

The **Ticket Print Format** screen is accessed from the **Operations** menu.

The **Ticket Print Format** screen is an administrative screen used to set up item tickets and shelf label formats to support ticket printing.

The purpose of this screen is to create a new ticket format by specifying a format name, associate to **Item Ticket** or **Shelf Label**, and optionally associate a 3rd party template file for example, ZPL file, to it. File layout which contains the layout of the tickets is to support the specific 3rd party printer. The screen also allows a user to select a default format and default printer for each type of format. The template files uploaded using the **Import Ticket Template** option will be listed here.

The system allows only one default format/printer to be set up for a specific format type. An error message will display if the user has selected more than one format as the default format. This is set up by store location. A user should select a default printer. If a default printer is not selected.

Reports

Figure 5–21 Reports

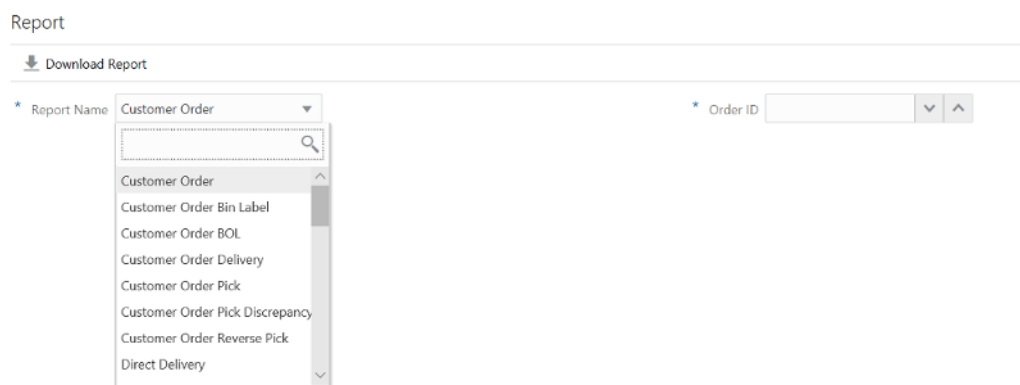

The **Report** screen is used to generate a pdf report for a specific transaction ID that can be printed from a pdf viewer (not supplied by Oracle). The list of reports that you can download depends on the data permission (Report Type) assigned. You can select a report type and enter the transaction ID for the report to be downloaded. A report request is sent to the server and the report gets downloaded to the default 'Downloads' folder set up by you.

The **Report** screen will be accessed via the menu: Operations-Report. You must have **Access Reports** security permission to access this screen.

List of Reports and Data Permissions:

The following table lists the report names and the data permission that is required to be able to download the report.

Table 5–1 Report Data Permissions

Report Name	Data Permission
Customer Order	Customer Order
Customer Order Bin Label	Customer Order Bin Label
Customer Order Delivery	Customer Order Delivery
Customer Order BOL	Customer Order BOL
Customer Order Pick	Customer Order Pick
Customer Order Pick Discrepancy	Customer Order Pick Discrepancy
Customer Order Reverse Pick	Customer Order Reverse Pick
Direct Delivery AGSN	Direct Delivery AGSN
Direct Delivery Label	Direct Delivery Label
Direct Delivery	Direct Delivery
Direct Delivery Discrepant Item	Direct Delivery Discrepant Item
Inventory Adjustment	Inventory Adjustment
Inventory Adjustment AGSN	Inventory Adjustment AGSN
Item Basket	Item Basket
Item Detail	Item Detail
Purchase Order	Purchase Order
RFID History	RFID History
RTV	RTV
RTV Shipment	RTV Shipment
RTV Shipment BOL	RTV Shipment BOL
RTV Shipment Container	RTV Shipment Container
RTV Shipping Label	RTV Shipping Label
Scan List	Scan List
Shelf Adjustment	Shelf Adjustment
Shelf Replenishment	Shelf Replenishment
Stock Count Allocation	Stock Count Allocation
Stock Count Detail	Stock Count Detail
Stock Count Export	Stock Count Export
Stock Count Rejected Item	Stock Count Rejected Item
Store Order	Store Order
Transfer	Transfer
Transfer Receiving	Transfer Receiving

Table 5–1 (Cont.) Report Data Permissions

Report Name	Data Permission
Transfer Receiving AGSN	Transfer Receiving AGSN
Transfer Receiving Exception	Transfer Receiving Exception
Transfer Receiving Label	Transfer Receiving Label
Transfer Shipment	Transfer Shipment
Transfer Shipment BOL	Transfer Shipment BOL
Transfer Shipment Container	Transfer Shipment Container
Transfer Shipping Label	Transfer Shipping Label

Operational Views

The Operational Views are accessed by selecting the **Operational Views** menu option under the **Operations** menu.

- [Out of Stock](#)
- [New Items](#)
- [Expiring Items](#)
- [Stock Counts - Ready to Authorize](#)
- [Shop Floor Out of Stock](#)

Out of Stock

Figure 5–22 Out of Stock - Hierarchy (Operational View)

Out of Stock

Search Reset

Search Mode: Hierarchy Class: All * Search Limit: 90

Department: All Sub-Class: All

Records Found: 4

Item	Description	Department	Class	Sub-Class	Inbound	Ordered
100000024	Test Item 100000024	1118 - Beer	2 - Import Beer	1 - Economy	0	0
100000112	Test Item 100000112	2401 - Fashion Jewelry	1 - Watches	1 - Men's Watches	1	0
100000171	Test Item 100000171	1117 - Cigarettes,Tobacco*	1 - Cigarettes*	3 - Generic	0	0
12345678912301	Happy Bubbles Fun in the tub	1102 - Detergents*	1 - All Purpose*	1 - Liquid*	0	0

The **Out of Stock** operational view displayed above is for a search mode of 'hierarchy'. The view will display the 'Active' items that are out of stock based upon the selected 'hierarchy'. A search limit is defaulted based upon the system admin. The results for the view are displayed in the grid. Selecting the item link will navigate to the **Item Details** for that item.

Figure 5–23 Out of Stock - Supplier (Operational View)

Item	Description	Department	Class	Sub-Class	Inbound	Ordered
100000024	Test Item 100000024	1118 - Beer	2 - Import Beer	1 - Economy	0	0
100000112	Test Item 100000112	2401 - Fashion Jewelry	1 - Watches	1 - Men's Watches	1	0
100000171	Test Item 100000171	1117 - Cigarettes,Tobacco*	1 - Cigarettes*	3 - Generic	0	0
12345678912301	Happy Bubbles Fun in the tub	1102 - Detergents*	1 - All Purpose*	1 - Liquid*	0	0

The **Out of Stock** operational view is displayed above for a search mode of 'supplier'. The view is the same as that above for 'hierarchy' except for being able to search for out of stock items by supplier or primary supplier.

New Items

With the **New Items** operational view, the user will be able to find out the list of items that are newly received on a delivery for the first time for the user's store. The user will be required to enter a date range for the search and hierarchy is optional. The system will return the list of items that meet the criteria. An item can be selected, and the user will navigate to **Item Detail** for that item.

Figure 5–24 New Items (Operational View)

Item	Description	Department	Class	Sub-Class	Primary Location
100050048	ST - Test Item	1102 - Detergents*	1 - All Purpose*	1 - Liquid*	

Expiring Items

Using this operational view, the user will be able to find out the list of items expiring on a particular day, in the user's store. This will allow for a single date to be passed in, which will initially default to today's date, and it will return the list of items which have a **Sell By** or **Use By** date is equal to the date being passed in. An item can be selected, and the user will navigate to **Item Detail** for that item.

Figure 5–25 Expiring Items (Operational View)

Expiring Items

Search Reset

Date: 3/4/20 Class: All Search Limit: 50

Department: All Sub-Class: All

Records Found: 2

Item	Description	Available SOH
<i>Filter</i>	<i>Filter</i>	<i>Filter</i>
10000024	Soy milk	11
100000147	Toned milk	114

Stock Counts - Ready to Authorize

The **Stock Counts - Ready to Authorize** operational view will display those stock counts that are still open. The store grid will display all stores in which the user has permissions. Once selecting a store, the grid at the bottom will display all stock counts that are **New** or **In Progress** in the authorized stage based upon the selected store. The graph displays all authorized stock counts for all stores the user has permissions for that are **New**, **In Progress** or **Completed** today.

Figure 5–26 Stock Counts -Ready to Authorize (Operational View)

Stock Counts - Ready To Authorize

Stores: 6 Child Stock Counts

Store	Child Stock Counts
<i>Filter</i>	<i>Filter</i>
1311 - Chicago*	5
1521 - Albuquerque	1

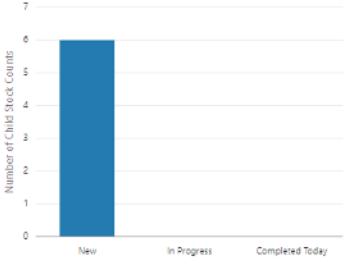

Child Stock Counts

Store: 1311 - Chicago*

Stock Count ID	Stock Count Description	Child ID	Child Description	Status	Total SKUs
<i>Filter</i>	<i>Filter</i>	<i>Filter</i>	<i>Filter</i>	<i>Filter</i>	<i>Filter</i>
2142	sim_qa6	2282	sim_qa6	New	0
2181	Problem line test	2321	Problem line test	New	2
2241	TP-Unit	2381	TP-Unit	New	26
2341	Unit test	2481	Unit test	New	26
2626	sim_qa6	2766	sim_qa6	New	0

Shop Floor Out of Stock

Figure 5–27 Shop Floor Out of Stock (Operational View)

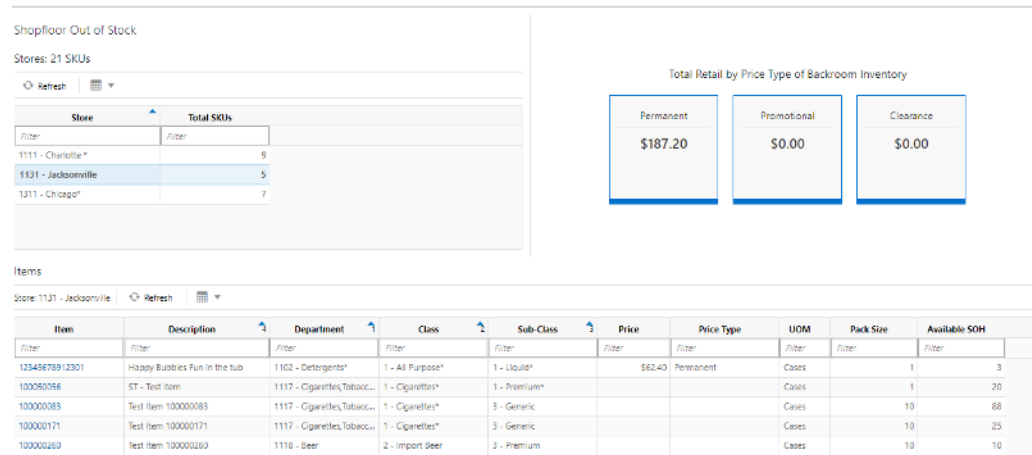

The **Shop Floor Out of Stock** operational view allows a user to see what items do not have any shop floor inventory but have **Available** inventory. There is a list of stores that the user has permissions too with the total SKUs that do not have shop floor inventory. The user selects a store to inquire about. The grid at the bottom populates based upon the selected store with the items that do not have shop floor inventory but have available inventory. Fields will include item, description, hierarchy, current price type and price, and available inventory. Selecting an item from the grid will navigate to **Item Detail** for that item. The operational view also has a three-block price section. It displays the total retail of the available inventory for the selected store for each price type: permanent, clearance, and promotional.

Translations

The Translations Setup screen present in the desktop application enables you to maintain translations for Operations UI (desktop UI) client-side keys such as UI labels and error messages as well as Server side translations like Context Type, Carrier, Reason codes, Notifications, server side error messages and so on, for all the supported locales.

The system supports the following locales:

- Arabic
- Chinese (Simplified)
- Chinese (Traditional)
- Croatian
- Dutch
- English (American)
- French (Parisian)
- German
- Greek
- Hungarian
- Italian
- Japanese
- Korean
- Polish
- Portuguese (Brazilian)
- Russian
- Spanish (Standard)
- Swedish
- Turkish

Apart from these, extension hooks are added for following new locales in the system:

- Albanian
- Armenian
- Azerbaijani

Belarusian
Bengali
Bosnian
Bulgarian
Burmese
Czech
Danish
Estonian
Filipino
Finnish
Georgian
Hebrew
Hindi
Indonesian
Kazakh
Khmer
Lao
Latvian
Lithuanian
Malay
Norwegian
Romanian
Serbian
Slovak
Slovene
Thai
Ukrainian
Urdu
Uzbek
Vietnamese

For these additional languages, the retailer should add translations for the keys. If there are no translations available in a particular language, the keys will be displayed in English. For server-side keys, new translation records can only be added via Data setup screens like Inventory Adjustment Reason, Shipment Reason, Carrier, Carrier Service and so on. Addition of records is not allowed on the Translation Setup screen. If a new record gets added via Data setup screens, the translation record for it gets displayed in the Translation setup screen automatically. These translation records will have a translated value for the locale that data record was created in. You need to provide values for other locales for which you can use the translation setup screen.

You can look up the translation record and update it with the translation. The translation setup screen does not support deletion of translation records.

Figure 6–1 Locale Selection

If the user selects **Bundle Type** as **Operations UI**, the list of client-side keys will be listed for the locale selected and the user will be able to maintain them.

If the user selects **Bundle Type** as **Server**, the list of server-side keys will be listed for the locale selected and the user will be able to maintain them.

Figure 6–2 Translation Setup Screen

Topic	Key	Translation	Description
Batch	dataseed.partneraddr.fnd	Partner Address	
Batch	dataseed.storeaddr.fnd	Store Address	
Batch	dataseed.supplieraddr.fnd	Supplier Address	
Batch	dataseed.whaddr.fnd	Warehouse Address	

The screen is accessed via the menu: Admin / Translations / Translation Setup. The user must have **Access Translations** permission for the Translations and Translations setup menu option to display. The screen displays an empty table by default. Choose a locale for the table to be populated with the translation records for that locale.

You can select a record to edit. You can update both the translation and description. Any changes made to the translation records from this screen will reflect both in the mobile application and the desktop application. The changes made will reflect in the applications immediately.

Export / Import File

The user will also be able to update translations in bulk using the **Export/ Import** feature provided in this screen. This is achieved by importing a file which has the updated translations for a particular language.

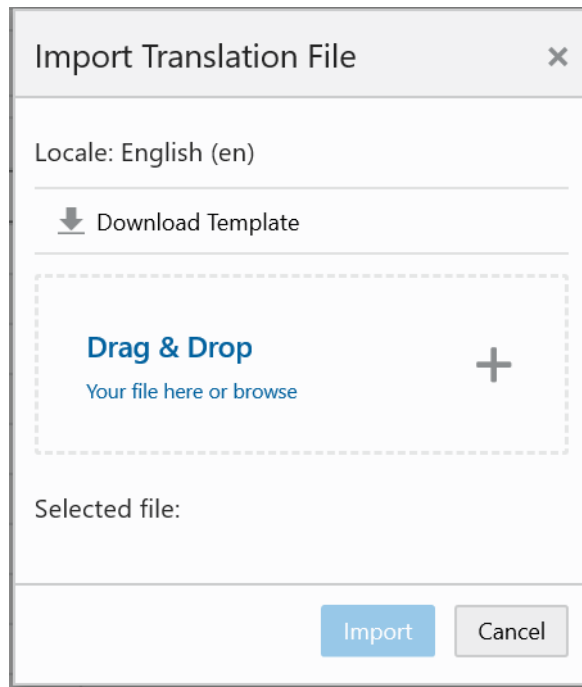
Figure 6–3 Import Translation File Popup

To help the user with preparing the file with the translations, there is an option to download the existing translations for the language. The file downloaded will be for the locale selected. The translation records downloaded in the file will be for both the Bundle Types that is, Server and Operations UI, irrespective of the **Bundle Type** selected.

Only the translation keys will be updated into the system. Descriptions are common for all languages and will not be updated if any changes are made.

If there are any errors encountered during the import processing of the file, an error file is generated which lists the errors along with the records that caused the error.

The following topics are described in this section:

- [Role Based Security](#)
- [Role Maintenance Screen](#)
- [Role Detail Screen](#)
- [User Assignment Screen](#)
- [User Detail Screen](#)

Role Based Security

The desktop application provides role-based user access control in order to manage application functionality and data available to users. This role-based user access control allows security to be managed in a way that corresponds closely to the organization's structure. This model provides improved support for customization, maintenance, and management of security in the system, simplifying customer implementations while maintaining a high degree of control and flexibility.

Role Based Security is handled by assigning privileges (permissions) to a role in the system. These roles are then assigned to users for stores. If you do not have permission for that store for a feature, the feature will not be available for you. The application secures buttons, drop down values and menu options on the mobile application.

An external system controls security (LDAP). User details like User name, First name and Last name, Password and Security groups are administered in the external system and displayed in the desktop application. Managing the user's profile (assigning stores, roles, and so on) is done in the desktop application. Authentication is performed in LDAP.

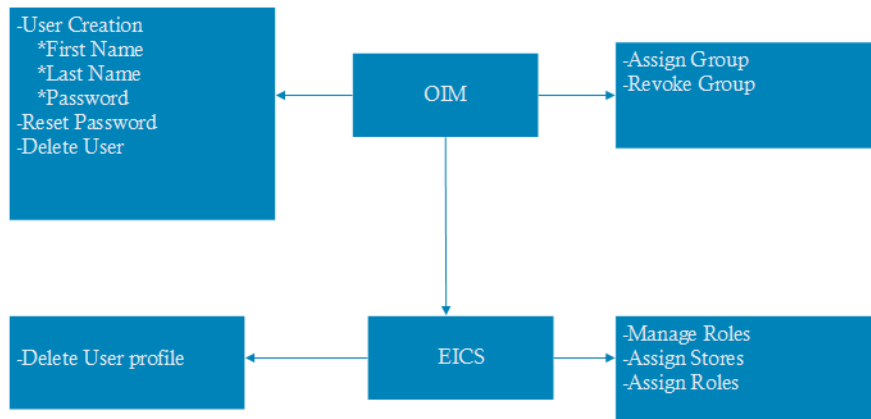
Figure 7-1 Security Management Workflow

During install, the cloud engineering team sets up the initial admin user for the customer to access OIM. After that, users can be setup by the customers and necessary groups can be assigned based on the role these users are going to play. For example, a user accessing web services will need to have *integration_users* group assigned, a user executing batches will need *batch_users* assigned. Roles that are needed for a user are assigned in the desktop application.

This chapter covers the following:

Role Maintenance

- Create new roles
- Update, view and delete roles
- Assigning and revoking permissions for a role

User Maintenance

- Viewing user details
- Assigning and revoking stores for a user
- Assigning and revoking roles for a user
- Viewing the groups assigned to a user

Note: The group *security_users* is required for accessing security management tasks in the desktop application, such as role maintenance and user role/store assignments.

Role Maintenance Screen

The **Role Maintenance** screen is an admin screen used to create new roles and assign permissions to it, modify and delete roles. A role that has been currently assigned to a user cannot be deleted. The screen will be accessed via the menu: Security/ Role Maintenance. User must have **Access Role Maintenance** permission for the **Role Maintenance** screen to be accessed. The screen displays the list of roles that have been added. User can edit or view the details of the roles by clicking on the **Role Name**. User will be taken to the **Role Detail** screen in order to edit or view the role.

Figure 7-2 Role Maintenance Screen

Role Maintenance

Refresh Create New Delete Selected

Role Name	Description	Role Type	End Date Required
Filter	Filter	Filter	Filter
ADMINISTRATOR	Administrator	Corporate	No
MANAGER	Manager	Store	No

Role Detail Screen

Figure 7-3 Role Detail Screen

Role Detail

Back Save

Role Name: ADMINISTRATOR Role Type: Corporate

Description: Administrator End Date Required: No

Permission Assignments: 440 / 440

Assign Selected Revoke Selected

Topic	Permission	Data Value	Assigned
Filter	Filter	Filter	
Admin	Access Carriers		☑
Admin	Access Code Info		☑
Admin	Access Container Lookup		☑
Admin	Access Customer Order Picking Tolerances		☑
Admin	Access Data Seed		☑

User Assignment Screen

The screen displays the list of users who has access to the store that the security user has logged in.

It is an admin screen used by a security user to view a user's details, assign roles and stores and view groups assigned to you. You will also be able to mass assign roles and stores to users. This can be done by importing the file which contains the details about assignments.

You can reset a user's profile through this screen. The screen is accessed via the menu: Security/ User Assignment. You must have **Access User Maintenance** permission for the Assignment menu option to be available under Security in the desktop application.

Figure 7-4 User Assignment Screen

User Assignment

Search Search Limit = 2000

Refresh Delete Profile Import

Username	First Name	Last Name	Create Date	Login Date
<i>Filter</i>	<i>Filter</i>	<i>Filter</i>	<i>Filter</i>	<i>Filter</i>
bdixtadmin	EXT	BDI		
bdijobadmin	bdijobadmin	bdijobadmin		
bdijoboperator	bdijoboperator	bdijoboperator		
bdiprocessadmin	PROCESS	BDI		
bdirmsjobadmin	bdirmsjobadmin	bdirmsjobadmin		
bdirxmjobadmin	bdirxmjobadmin	bdirxmjobadmin		

The details of the user, roles, stores and groups assigned can be viewed by clicking on the respective Username.

You can use 'Filter' in order to narrow down the list of users displayed in the screen.

Filter

Figure 7-5 User Filter Screen

User Search Criteria ✕

Username

First Name

Last Name

Group *All* ▼

Store *All* ▼

Role *All* ▼

No role assignments No

* Search Limit ▼ ▲

You can narrow down the list of users displayed by using the number of filter criteria provided in the screen.

User Detail Screen

The screen can be reached by clicking on the user name in the Assignment screen. This screen has been divided into four tabs: [User](#), [Stores](#), [Roles](#), and [Groups](#).

User

This is the section that is displayed by default when the security user enters the screen by clicking on a Username from you Assignment screen.

This section displays basic details of a user such as First name, Last name, Create date of the user’s profile in the application, Login date (most recent login date), Last Store (the last logged in store) and the primary language of you. This is a read only screen.

Figure 7-6 User Detail Screen

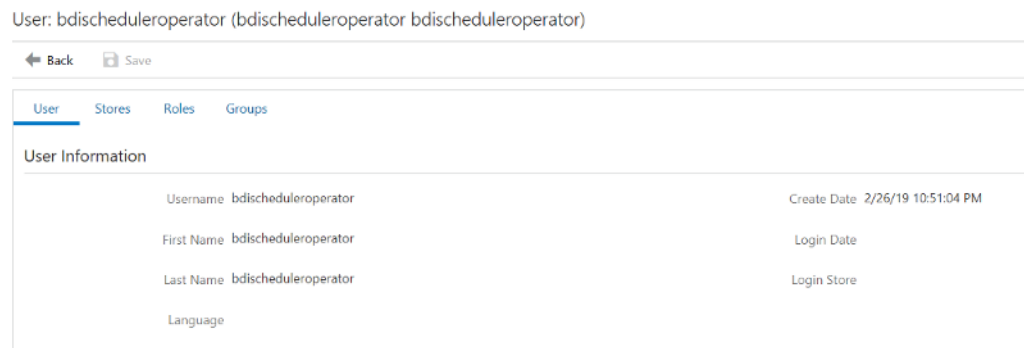

Stores

This section enables the security user to assign or revoke stores for a user. The list of stores that the security user has access to are displayed in the screen and he can assign stores from this list to a user or revoke already assigned stores. If the security user has *global_store_users* group assigned to him, then all stores should be displayed in the list. User needs **Assign User Store** security permission for this section to be accessed.

Figure 7-7 User Detail (Stores) Screen

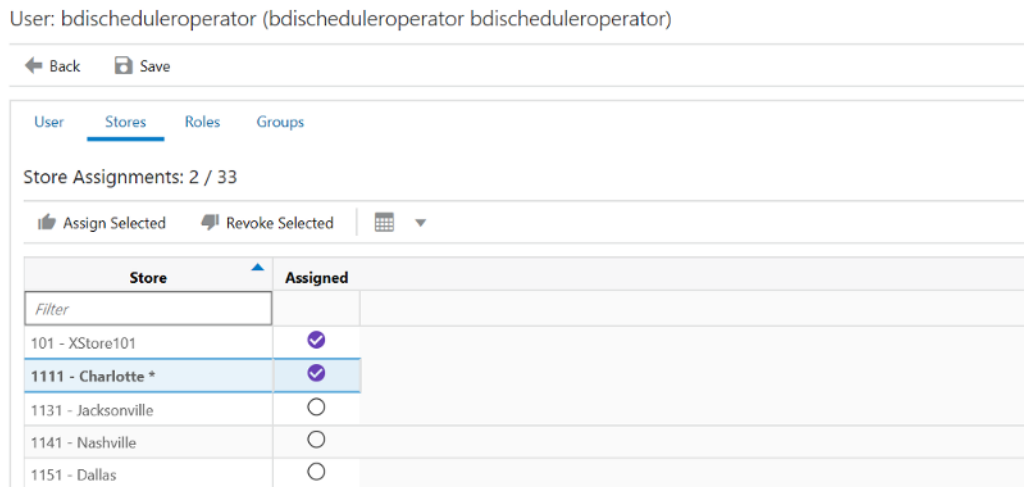

Roles

This section displays the set of roles currently assigned to a user and it also enables assigning new roles or revoke already assigned roles for the user, set Start Date and End Date for the role assignments. The user changing this data needs **Assign User Role** security permission for this section to be accessed.

Figure 7–8 User Detail (Roles) Screen

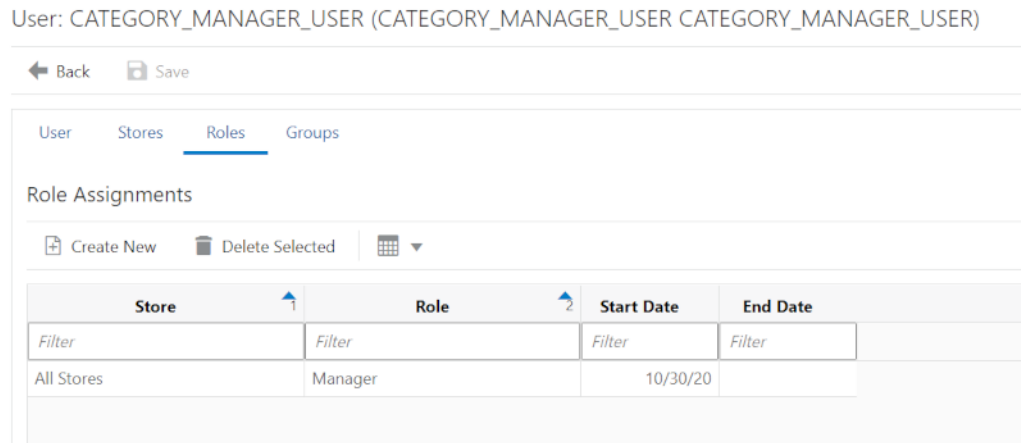

New Role Assignment

A security user would need the ability to assign roles to a user (single role or multiple roles) and to assign stores. This screen enables him to perform this activity. In the desktop application, roles are assigned to the stores that a user has access to. The system allows a user to have different permissions for each store that they are allowed to log into the system with. This section displays all roles that the security user has access to assign. The security users will only be able to assign a role to a user if they have the Data Permission for the Role Type assigned to the Role. It is possible select a store(s) and select role(s) to be assigned for the store(s).

The screen provides a list of options that controls the list of stores that are displayed for the security user to assign a role to.

Select from assigned stores: List the stores that you have been assigned to that the security user also has access to. The security user can select one or more stores from this list to assign roles.

Select from available stores: List all the stores that the security user has access to.

All assigned stores: List the stores that you have been assigned to that the security user also has access to. As the name suggests, this enables the security user to assign roles to ALL the stores assigned to a user at once.

Figure 7–9 User Detail (Roles - New Role Assignment) Screen

Groups

This is a read only section which lists the groups available in the system and indicates ones that are assigned to you. The groups are assigned through the external system (OIM).

Figure 7–10 User Detail (Groups) Screen

User: CATEGORY_MANAGER_USER (CATEGORY_MANAGER_USER CATEGORY_MANAGER_USER)

← Back Save

User Stores Roles Groups

Group Assignments

Group	Assign...
<i>Filter</i>	<i>Filter</i>
admin_users - Group for administrator operation users.	No
batch_users - Group for batch operation users.	No
full_permission_users - Untranslated: security.group.full.pe...	No
global_store_users - Group for Global Store users	No
mps_users - Group for MPS operation users.	No
retail_home_users - Group for Retail Home operation users.	No
security_users - Group for security operation users.	No
sysop_users - Group for system operation users.	No
users - Group for authenticated users.	No

List of Security Groups

The desktop application comes with seven groups used for special purpose access, which are managed through OIM as roles.

Users accessing application UI features that are restricted by group access must also be granted the relevant permissions through role and store assignments.

A regular store user should not require any security group assignments for accessing the application UI.

Admin: The group *admin_users* is required for access to administration tasks, such as managing configuration settings or translations. This group should only be assigned to system operators and administrators.

Batch: The group *batch_users* is required for access to batch related tasks, such as job management or scheduling. This group should only be assigned to system operators and batch administrators.

Global Store User: The group *global_store_users* grants you access to all store locations. This group should only be assigned to system operators, and administrators or special users requiring access to all store locations.

Integration: The group *integration_users* is required for accessing integration resources, such as web services. This group should only be assigned to users designated for application integration, not those requiring access to the application UI. Users that are only integrating with the inventory desktop application are considered integration users, for example, the RIB injection user is a typical case of an integration user. These users do not require access to the inventory system client applications, and therefore do not require store assignments or role assignments (permissions).

MPS: The group *mpps_users* is required for access to MPS (message processing system) related tasks, such as staged message maintenance or work type management. This group should only be assigned to system operators and MPS administrators.

Security: The group *security_users* is required for access to security management tasks, such as role maintenance and user role/store assignments. This group should only be assigned to system operators and security administrators.

System Operator: The group *sysop_users* is required for access to restricted areas and only assigned to system operators, which is typically the cloud operator.

Full Permission: The group *full_permission_users* grants the user all permissions without a role assignment however it does not grant all data permissions. It is enough for a cloud operator or customer admin to create a user with only Oracle Identity Cloud Service (IDCS) or Oracle Cloud Infrastructure Identity and Access Management (OCI IAM) app roles and not needing to setup anything in the Inventory system database in order to login and perform usual administrative tasks.

Retail Home: The group *retail_home_users* is required for users that want to access Inventory system features in the Retail Home application

Users: The group *users* is required for all Inventory system client user access, that is, desktop or mobile client, not integration users.

Within the system, several features apply through the application across multiple functional areas. These features include the ways items are scanned and processed as well as how the feature worked based on the type of item and status of the item.

This chapter covers all aspects of item. The following topics are covered:

- [Item Type Support](#)
- [Store Pack Inventory](#)
- [UOM/Scanning](#)
- [Item Status](#)
- [Non-Inventory Indicator](#)
- [RFID](#)
- [UIN Tracking](#)
- [Item Description](#)

Item Type Support

The system supports a variety of items, ranging from items for which no inventory is tracked (from non-inventory items and consignment and concession items) to items for which special calculations are needed, such as variable weight or UPC-E items. These items are, most of the time, used in a grocery environment.

The following are supported item barcode types:

- VPN
- SKU
- GS1
- Type 2/VPLU (A, B, C, D, E, F, G, H, I, J, K, L)
- UPC #

The system also has the concept of the GS1 databar. This is an industry standard databar based on the old EAN128 format. It can contain a variety of data such as serial numbers, price, weight, and much more. Oracle has incorporated logic into the barcode tool to allow the scan of these databars and use of the embedded data for quantity, and price.

The system provides a benefit that any of these item types can be entered in any field in the dialogue and it will find the master item information.

Vendor Product Number

Sometimes the vendor product number is the easiest way to look up an item. The system will return an item or list of items based on the VPN. This functionality is available in all areas of the application where users can enter or scan an item in the mobile application.

If a VPN is scanned in the DSD dialogue and two suppliers use the same VPN, SIOCS will select the item number associated to the supplier on the transaction.

Type 2 (VPLU)

Barcodes of fresh items in grocers often contain different elements beyond just the UPC.

Type - 2 supported formats contain a prefix, UPC, price, and check digit. Based on these elements, the system will extract the UPC and price, and calculate the weight based on the price.

This calculated weight will be used to increase the scanned quantity. The standard process in the system for stock counts, receiving, or shipping is to increase the quantity by one. With this functionality, the quantity will be updated with the weight of the item:

- The Mobile application recognizes Type 2 items and de-construct it in price/item.
- Quantity is calculated by using the embedded price.
- Update the quantity entry field with the calculated quantity from the barcode.

The following table lists the supported Type 2 formats:

Table 8-1 Supported Type 2 Formats

Format	Description	Prefix Length	Begin Item Digit	Begin Price Digit	Check Digit	Length
A	1-4-6-1	1	2	6	0	12
B	1-5-5-1	1	2	7	0	12
C	1-4-6-1	1	2	7	6	12
D	1-5-5-1	1	2	8	7	12
E	2-4-5-1	2	2	8	7	12
F	2-4-5-1	2	3	7	0	12
G	2-5-4-1	2	3	8	0	12
H	2-5-4-1	2	3	8	0	13
I	2-4-6-1	2	3	7	0	13
J	2-4-6-1	2	3	8	0	13
K	2-5-5-1	2	3	9	8	13
L	1-6-5-1	1	2	8	7	13

- Each type has a hard-coded algorithm.
- Each column in the table is the start of the position in the string (0 means there is no position for it). The description explains the length of the value.
- For example, format C 1-4-6-1 for item number 123456789012:

- Prefix, position 1: 1
- Item number, position 4: 2345
- Check digit, position 6: 6
- Price: 789012, or 7890.12
- The weight is calculated by using the price from the label and dividing it by the current active price on file:
 - Two decimals are implied in the retrieved value from the barcode.
 - The currency for the price on the barcode is the currency of the store.
 - This price can be regular, promotion, or clearance.
 - The item's SUOM of the weight is implied.
 - Standard rounding is applied up to a maximum of three decimals
- Example:
 - Item: 250010001500 is defined as format A; this means that the price is 000150 = \$1.50.
 - The price on file for this item is \$3.
 - The quantity is calculated as follows: $1.5/3 = 0.5$.

GS1 Data Bar

Figure 8–1 GS1 Data Bar Example



The GS1 DataBar is a barcode symbol with embedded information. This information can be used in the store for sale and supply chain purposes. Information may include item, price, quantity, unique identification number, Country of Origin, Lot, Expiration, as well as many other fields.

The Retail Market is seeing an increase in the use of the GS1 DataBar. The system has several features to assist in the support of the GS1 DataBar.

The example, in the above figure, shows a 2D GS1 Databar.

The system can accommodate the GS1 DataBar. Throughout the mobile application, where there is an item entry field, the entry or scan is allowed where applicable of a GS1 DataBar. The item will be parsed from the DataBar and used on the transaction.

When entering or scanning a GS1 DataBar in the Scan bar of the mobile application, the system will parse out the item id, quantity and price and apply those to the transaction. The price is used to calculate the quantity of the item. Any other information other than Item ID, quantity and price, if present in the GS1 Databar, will be ignored.

GS1 DataBar - Quantity and Price

The quantity will be parsed and applied to the transaction.

Example: 30 lbs. is in the GS1 DataBar, then 30 lbs. will be applied to the transaction.

The price will be used to calculate the quantity, if the quantity is not provided.

The same calculation will be used that is used for Type 2 items. The price from the barcode will be divided by the current price in the system to get the quantity.

Example: An apple is scanned which has a UOM of kg. The price in the barcode is \$1.50. The price in the system is \$3.00. The quantity will be derived by \$1.50 divided by \$3.0 to get .5 kg.

Store Pack Inventory

The system can provide additional visibility into the items that can be sold individually or as part of a simple or complex pack.

Features include the following:

- SOH visibility to items sold individually or as part of a pack
- Two indicators used to control the behavior:
 - Store Pack Inventory Indicator
 - SOH Inquiry at Pack Level Indicator
- Indicators set in the Item Master application (Merchandising)
- Item type in the system has been broken out and used to identify:
 - Simple Pack
 - Complex Pack
 - Simple Breakable Pack
 - Complex Breakable Pack

The system can provide an estimated quantity for the simple or complex pack when it is sold as both an individual component as well as in a pack.

To enable this feature for pack item, there are two indicators used to control the behavior. The Store Pack Inventory indicator tells the system when an item will only be sold and tracked as a pack. When this indicator is not checked, the item can be sold and tracked at the component level with a calculated option at the pack level.

The SOH Inquiry at Pack Level indicator is used to determine if an estimated stock on hand should be calculated for the pack when the item is sold at both component and pack level.

It is critical that the item master have these two indicators set up properly in order for the information to flow into the system properly.

The system can categorize the item by identifying whether the pack is breakable or not based on the indicators in merchandising. Breakable packs can be transacted like non-breakable packs, but inventory for a breakable pack will always be stored at the component level.

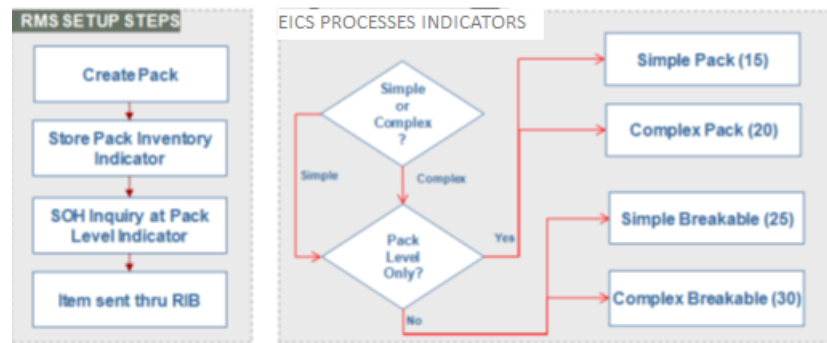
Figure 8–2 Store Pack Inventory Setup Flow

Business Cases

When a pack item is created in the external foundation system, a user can identify whether the pack is breakable or not by checking the Store Pack Inventory Indicator if the item is tracked and sold as a pack item only. The user will not need to check the indicator if the item is tracked and sold at both the pack and component level.

Next, determine if an estimated stock on hand should be calculated for a breakable pack. The SOH Inventory at Pack Level indicator is checked when an estimate should be calculated.

When the item flows into the system, additional processing will take place to correctly classify how the item will behave. Basically, there are four groupings of the pack that the system will identify as the information flows in. The system uses the type field of 15, 20, 25, and 30 to identify how the item needs to handle other types of processing, such as what displays on a stock count, and so on.

The following examples help illustrate how the calculations take place.

A company is called RKA Coffee House. The company sells various types of coffee and packages the coffee into different configurations as well as providing various gift packs.

Example 1: Simple Pack

Pack Item 500 Medium Roast Coffee 3pk contains:

Item	Qty	UOM	SOL
5001 Medium Roast Coffee	3	8oz pkg	1200

1. Identify the component SOH.
1200
2. Identify the number of components for the pack.
3
3. Divide the component SOH by the number needed for the pack.
 $1200/3 = 400$
4. Display the pack item estimated SOH.
Pack Item 500 Medium Roast Coffee 3pk: SOH ~400

When you look up the component item, the SOH will display 1200 units. When the pack item is displayed, the SOH will display the number of packs that could potentially be sold to the customer. Since the component item could potentially be part of another pack configuration, this number is only an estimate. Therefore, the tilde ~ will be placed in front of the calculated SOH.

The next example is more complicated example. The coffee house wants to offer a sampler package for a customer to try different types of coffee. The coffee house will put one of each of their types of light and dark roast and two of medium roast coffee. Each of these coffee packages can also be sold individually. Additionally, there will be two of the coffee mugs with the RKA logo on the mug, added to the coffee sampler package.

Example 2: Complex Pack

Pack Item 700 Coffee Sampler contains:

Item	Qty	UOM	SOL
4001 Light Roast Coffee	1	8oz pkg	600
5001 Medium Roast Coffee	2	8oz pkg	1200
6001 Dark Roast Coffee	1	8oz pkg	500
7001 Medium Roast Coffee	2	each	1200

1. Identify the component SOH.

Item 4001: 600

Item 5001: 1200

Item 6001: 500

Item 7001: 1200

2. Identify the number of components for the pack.

Item 4001: 1

Item 5001: 2

Item 6001: 1

Item 7001: 1

3. Divide the component SOH by the number needed for the pack.

Item 4001: $600/1 = 600$

Item 5001: $1200/2 = 600$

Item 6001: $500/1 = 500$

Item 7001: $1200/2 = 600$

In order to make the Coffee Sampler, all the components and the correct quantity of components are needed. Therefore, take the lowest number calculated in this step.

4. Display the pack item estimated SOH.

Pack Item 700 Coffee Sampler SOH ~500

In the following example, there can be another pack item as part of the new gift pack.

Example 3: Complex Pack (Simple Pack, Complex Pack, and Individual Items)

Pack Item 750 Coffee Explorer Set contains:

Item	Qty	UOM	SOL
5001 Medium Roast Coffee	2	8oz pkg	1200
6001 Dark Roast Coffee	1	8oz pkg	500
Pack Item 900 Passport/Slate/Woodbox Combo contains:	1	Pack	
9001 Coffee Passport	1	Each	1200
9002 Slate Serving Tray w/Chalk	1	Each	600
9003 Wood Box with Stainless Steel Lid	1	Each	800
Pack Item 800 Set of 4 Ceramic Tasting Cups contains:	1	4ct	
8001 Ceramic Tasting Cups	4	3oz cup	1000

1. Identify the component SOH.

Item 5001: 1200

Item 6001: 500

Pack Item 900:

Item 9001: 1200

Item 9002: 600

Item 9003: 800

Pack Item 800:

Item 8001: 1000

2. Identify the number of components for the pack.

Item 5001: 2

Item 6001: 1

Pack Item 900 (1):

Item 9001: 1

Item 9002: 1

Item 9003: 1

Pack Item 800 (1):

Item 8001: 4

3. Divide the component SOH by the number needed for the pack.Item 5001: $1200/2 = 600$ Item 6001: $500/1 = 500$

Pack Item 900 (~600):

Item 9001: $1200/1 = 1200$

Item 9002: $600/1 = 600$

Item 9003: $800/1 = 800$

Pack Item 800 (~250):

Item 8001: $1000/4 = 250$

In order to make the Coffee Explorer Set, all the components and the correct quantity of components are needed. Therefore, take the lowest number calculated in this step.

4. Display the pack item estimated SOH.

Pack Item 750 Coffee Explorer Set SOH ~250

The item lookup feature provides users with more visibility into the stock on hand for the packs and components of a pack through the Store Pack Inventory Indicator. If the indicator is checked, inventory will be held at the pack level and not broken down.

If the indicator is not checked, the system will break down the item to the components on the backend and all inventories will be held at the component level.

Additional information on the pack and components is available by pressing the **Pack Info** button and **Component Info** button depending on what level is being viewed.

Anywhere there is a SOH value on a screen, it may be estimated (~) if the SOH Inquiry Indicator is checked in merchandising. If the indicator is not checked, a Null value will display.

Store Pack Inventory - Other Functional Areas

When using the shipping and receiving functions in the system, the backend processing of breaking down to the component item will be applied and the component items stock on hand will be updated for any breakable pack items.

When performing an inventory adjustment, the system will need to look to the component items' unavailable stock on hand to determine the available quantity that can be used for the adjustment.

You can sequence both simple and complex breakable packs and the components of those packs through flat file processing.

The transaction history contains the component or the pack item depending on where inventory was updated.

UOM/Scanning

Features:

- Unit of Measure (UOM)
- Transaction (Preferred) UOM
- Pack Size
- Consistent Scanning (UOM)

Unit of Measure (UOM)

The Default UOM parameter is the UOM which is used until it is changed by you. This is done in the Mode Bar on the mobile application or within preferences on the desktop application. You can select between Standard UOM, Cases, and Transaction UOM. Changing the UOM will convert the quantity on the screen based upon the UOM. One exception is Stock Count Authorization, which is always in the standard UOM.

- Standard UOM of Eaches: 'Each' items will be those items with UOMs that may include units, ream, jar, pair, dozen, and so on. These cannot be broken apart into partials. Example: an each such as a shirt must remain a whole and would have a UOM of units. You can only enter a quantity in positive whole numbers for the SUOM of Each item.

Cases: you can enter a decimal quantity for the case quantity, if the calculated quantity results in a whole number (cannot have a partial unit).

Example: Pack Size 12, Qty 1.5 Cases = 18 Units. This is acceptable as 18 is a whole number.

- If the standard UOM is different than Eaches, you should have that unit of measure along with Cases as UOM options in the UOM drop down. Example: Kg and Cases:
 - Standard UOM other than Eaches: depending on the UOM you can enter a decimal value for the SUOM quantity.
 - The quantity will be restricted to a total of 4 digits and three decimal places if it is allowed to enter decimals for that specific unit of measure.
 - Cases: you can enter a decimal quantity for the case quantity.

Example: Pack Size 3, Qty 1.5 Cases = 4.5 LBS. This is acceptable as 4.5 LBS is feasible.

Note: Inventory can hold decimal values for those items that have a standard UOM other than units that allow for decimals.

Transaction (Preferred) UOM

The following UOM rules are applied throughout the customer order, transfer shipping and transfer receiving dialogs wherever it refers to the UOM:

- Customer Orders
- Customer Order Deliveries
- Customer Order Picks
- Customer Order Reverse Picks
- Transfer Shipments
- Transfer Receipts

Transaction Unit of Measure will only be applicable in Customer Orders and Shipping and Receiving (of a customer order) where a transaction unit of measure exists. It will most likely be the Selling UOM.

In all areas where a transaction UOM is not applicable, the system uses the standard unit of measure, even though the Unit of Measure mode may be set to transaction UOM.

You can select between the Transaction UOM (that is, Lbs, Units, and so on), Standard UOM (that is, Lbs, Units, and so on) and Cases.

In the event that the Transaction UOM on the Customer Order /Fulfillment order is not recognized or cannot be converted in the system, then it will not be used, and only the Standard UOM and Cases will be used with the system defaulting to the Standard UOM.

When switching the UOM for the quantities on the screen, it will convert from Transaction UOM to Standard UOM and vice versa as well as from Standard UOM to then cases.

Stock on hand updates to the database are always made in the standard unit of measure, as that is what is held in the database.

All communication with external systems will have the quantity in the standard UOM with exception of the interface with the POS and Customer Order management systems. The POS can communicate in Sales UOM, and a customer order system could communicate in addition a transaction UOM. The Inventory system converts these UOM as needed.

Pack Size

The Pack Size represents the quantity of that item within a Case. The Pack Size is set up in merchandising when adding the supplier to the item. Merchandising terminology is Case Size (that is, Case Size in merchandising = Pack Size in the system). Within the system, the Pack Size for the primary supplier is used (if the supplier is unknown), otherwise it uses the pack size for the supplier that is being used (Returns /).

When referring to the Default Case Size, this is the Case size defined on the item master which is the item's primary supplier Pack size.

The Pack Size is not the number of component items within a Pack Item, rather the number of items within a case (box). Pack Size is used for all types of Items and Packs. If enabled in the Inventory system, users can override the pack size for all items and packs.

Many screens within the mobile application allow a user to enter an item quantity in both units and cases. When entering an item quantity in cases, the user can change the Pack Size of the case. The Pack Size is displayed only when the UOM is set to 'Cases'.

Editing Pack Size

- The pack size cannot be changed from 1 if the UOM is set to the Standard UOM.
- When selecting cases, the Pack Size can be displayed or changed to a decimal value and allows decimals for any Standard UOM other than Eaches.

Example:

Item is kg and has a case size of 15.

- If the UOM is set to kg, the quantity can have a decimal (15.5 kg), but the pack size can only be 1 (1 kg).
- If the UOM is set to case, but the SUOM = kg, the pack size can be set to a decimal value. Example: case of 15.5kg.

Changing the Quantity and Pack Size

How the Quantity field changes when the Pack Size changes depends on when the 'quantity' and 'pack size' fields are changed. Changing the pack size only will not change the quantity of standard unit of measure. Changing the quantity of Cases will change the quantity of standard unit of measure if the pack size is greater than 1.

Example 1:

UOM system parameter set to 'Cases':

1. Access a 'saved' return with a return quantity of 10 for Item A with Standard UOM as 'Units' and a pack size of 1. Note that UOM is Cases. If you set the UOM to 'Standard UOM', the return quantity will also be 10.
2. Set the UOM to 'Cases' and change pack size to 2. Note that the quantity field has changed to 5. The system calculates the new quantity for Cases based on the new pack size of 2.
3. Set the UOM to 'Standard UOM' and the quantity will still be 10 when displayed in units. The total quantity for units does not change since only the pack size was changed.
4. Set the UOM to 'Cases' and change the quantity of Cases from 5 to 10 (pack size still = 2). Now set the UOM to 'Standard UOM' and the quantity will be 20. Unit quantity was recalculated based on the new 'Cases' quantity with pack size = 2.

The pack size will be stored on the transaction.

You may have entered various pack sizes and the system will store the last pack size entered on the transaction.

Example 2:

Receive Item A, 10 Cases, Pack Size 10 (100 Units), then receive Item A 10 Cases Pack Size 5 (50 units). This equates to receiving 150 Units with a Pack Size of 5 (30 Cases).

Note: Warehouse deliveries are an exception and the Pack Size is not editable for items that exist on the ASN, as it is the Pack Size from the ASN. Unexpected items the Pack Size will be editable per the configuration.

Note: Pack size is displayed on the count/recount detail screen but is not editable.

Consistent Scanning (UOM)

Consistent Scanning also addresses applying quantities from scans based upon the UOM.

For Each or Unit items, the barcode quantity will be added to the quantity on the screen in the mode of the unit of measure on the UI. In other words, the system will take the quantity from the barcode and just add that to the quantity in whatever UOM is displayed on the screen.

- For Standard UOM, the quantity from the barcode is added to the quantity on the screen in the standard UOM.

Example: 3 units on the UI. The barcode is scanned for 1 unit; therefore, the quantity on the UI is incremented to 4 units.

- For Cases, the quantity from the barcode is added to the quantity on the screen in cases.

Example: 10 cases on the screen. Barcode is scanned for 4, now the quantity on the UI increments to 14 cases.

For items that are not Each type items, such as pounds, kilograms, meters, and so on, the barcode quantity will be added to the quantity on the screen in the Standard Unit of Measure Mode. So, it assumes the quantity is in the standard UOM.

- For Standard UOM, the quantity from the barcode is added to the quantity on the screen in the standard UOM.

This is the same as the preceding example for Each item.

- For Cases, the quantity is added to the Standard UOM mode and then converted back to cases.

Example: 1.8 cases on the UI; this is equivalent to 18 pounds, as 10 pounds equal one case for this item. The barcode scan is for 4 pounds. The new quantity will equal 22 pounds, which will be converted back to 2.2 cases for the UI.

Item Status

There are five different statuses for an item: Active, Inactive, Temporary/Auto-Stockable (Q-Status), Discontinued, and Deleted. Depending on the status of an item, certain functions may not be allowed. When an item is currently not ranged to a store, the item may be assigned a temporary active status if the system is configured to allow you to range an item. The system will treat the item as though it were in an active status with no functional restrictions.

Configurations

System Parameters

Allow Non-Ranged Items

- Values: Yes/No
- Default: Yes
- Topic: Admin
- Editable: Yes
- Yes: The store is allowed to add a non-ranged item to a transaction
- No: The store is not allowed to add a non-ranged item to a transaction

Restrictions

Temporary/Auto-Stockable (Q-Status)

Before an item can be used by a store in the system, the item needs to be ranged. Ranging an item depends on two factors, the item host system (for example, Merchandising) and whether the system allows the ranging of items. If the system parameter 'Allow Non-Ranged Items' is enabled, the system allows the store to add non-ranged items to transactions.

When the system temporarily ranges an item, the item is assigned the status of 'Q.' This status is treated as though it is an active item. The item is ranged and set to Active status when Merchandising sends the item/location relationship. This will happen after the transaction that ranges the item in the system is completed. There can be a delay, or it could never happen if the transaction is never approved.

Discontinued

When an item is discontinued, the item cannot be ordered from a supplier, but it can be transferred from a warehouse or store. Discontinued items can appear on stock counts, and it is possible to ship to a finisher.

Inactive

When an item is inactive, the item cannot be transferred in from a warehouse or store if the receiving location is inactive or deleted for the item. All other transfers are acceptable.

Inactive items are not allowed for Finishers.

If the item in an inactive status is on a delivery (DSD/Warehouse Delivery), the item may be received or the item may be added to the delivery. An inactive item may be received on a transfer but cannot be transferred to another store when it is inactive at the destination store.

Deleted

When an item is deleted, the item cannot be ordered from a supplier. Deleted items cannot be transferred out from a warehouse or store if the item status in the receiving location is deleted. All other transfers are acceptable.

Deleted items are not allowed for Finishers.

If the item in a deleted status is on a delivery (DSD/Warehouse Delivery), the item may be received or the item may be added to the delivery. A deleted item may be received on a transfer but cannot be transferred to another store when it is deleted at the destination store.

Non-Inventory Indicator

An item can be set up as inventory or non-inventory holding.

If an item's non-inventory indicator is set as 'No', then the item's inventory is tracked in the store. At the completion time of the transaction, the inventory of the item is updated depending on what has happened in the transaction for the item. In some cases, for example with notional packs, the components will be updated.

If the non-inventory indicator is set as 'Yes' for an item, then the item's inventory is not tracked in the store. However, the item is allowed to be added to most transactions (except in Inventory adjustments and Stock Counts). You will be able to enter/update quantity on inventory related transactions like shipping and receiving, just like an inventory enabled item. All the processing rules and validations that apply to inventoried items would apply for non-inventoried items except that the validations done on quantity against stock on hand will be ignored. The transactions can be completed and at the end of the transaction, no update will be made to the inventory of the item. The stock on hand will always be null for these items.

The Store Inventory system can be configured to prevent non-inventory items from being published. This can help in cases where the consuming system does not have appropriate functionality to manage such items.

An example of a non-inventory item managed by the store could be shopping bags. In most cases the retailer will want to order them, have them shipped to the store, but no inventory tracked for them.

Consignment and concession items can be interfaced as inventory or non-inventory holding items to the Store Inventory system at the location level. In essence a consignment or concession item can function now as a regular item that hold inventory or not.

Shipping consignment or concession items to another store should only be done if the supplier at the other store is the same supplier. This particular check is not performed in the Store Inventory system and any discrepancies are handled by RMFCS. If the consignment or concession item is not inventory, the Store Inventory system does allow the shipping of this item to another location as well, however RMFCS is not setup to manage this type of a transaction, and as such the recommendation is to not publish non-inventory item transaction or leverage business process to exclude these items from shipping transactions.

RFID

The Store Inventory system supports tracking RFID items. An item can have an RFID indicator that tells item lookup that this item could have RFID zone setup. When RFID information is integrated into the Store Inventory system, the retailer has the option to also integrate zone information. This allows a user to lookup an item and know exactly where that item is located.

In addition to tracking RFID items, and updating the stock on hand quantity, the Store Inventory system also allows for stock counts and sales updates.

Stock counts will overlay the stock on hand position with the counted RFID value.

Sales updates will decrement stock on hand.

UIN Tracking

The system provides the capability to track items by unique identification numbers (UIN). If you use unique identification numbers, these numbers are displayed and tracked in several functional areas in the application, including deliveries, transfers, returns, and stock counts. You can also look up items by UIN.

To ensure accuracy and keep track of the UIN items, UIN items have states that can shift when they are added to different transactions. A full audit trail by user allows for close tracking on what has transpired with those items.

Features

UINs can be of two types:

- **Serial Number**

Serial numbers are unique identifiers for individual instances of an item, typically attached to items by the manufacturer. During receiving, the serial numbers must be scanned and associated with items.
- **Auto-Generate SN (AGSN)**

AGSNs are serial numbers generated by the system that you can use to identify each instance of an item.

Item Description

When an item is set up in the Merchandising system, you enter a description for the item. The long description of the item is displayed in the desktop application. In mobile, either short or long description is displayed based on the parameter setting.

Oracle's merchandising system now publishes Item descriptions independently of item and the Store Inventory system subscribes to that message. The Item description message may contain translated information for the descriptions associated to an item as well as secondary descriptions. If configured, the Item description displayed in the desktop and mobile application can be in the user's preferred language independent from the store location language, provided translation is available for that language.

Inventory Management

The Inventory Management section of the desktop application focuses on managing and reviewing inventory events. It focuses on these areas:

- [Item Basket](#)
- [Authorizing a Stock Count](#)
- [Transaction History](#)
- [Troubled Transactions](#)
- [Ticketing](#)

Item Basket

Item Basket on the desktop allows a user to create a basket of items and hierarchies.

Note: An item basket that has only items on it is considered 'static' meaning that the number of items does not change.

An item basket that has only hierarchies or hierarchies and items is considered 'dynamic' meaning that the items on the basket can change based upon the items associated to the hierarchy.

The desktop allows for item baskets that are 'dynamic' or 'static' to be created, viewed and edited. Whereas, on the mobile application only static item baskets (ones with items) can be created, viewed, and edited.

Features:

- Create a new item basket
- View or edit an existing item basket
- Delete an In-Progress Item Basket
- Copy a Completed Item Basket

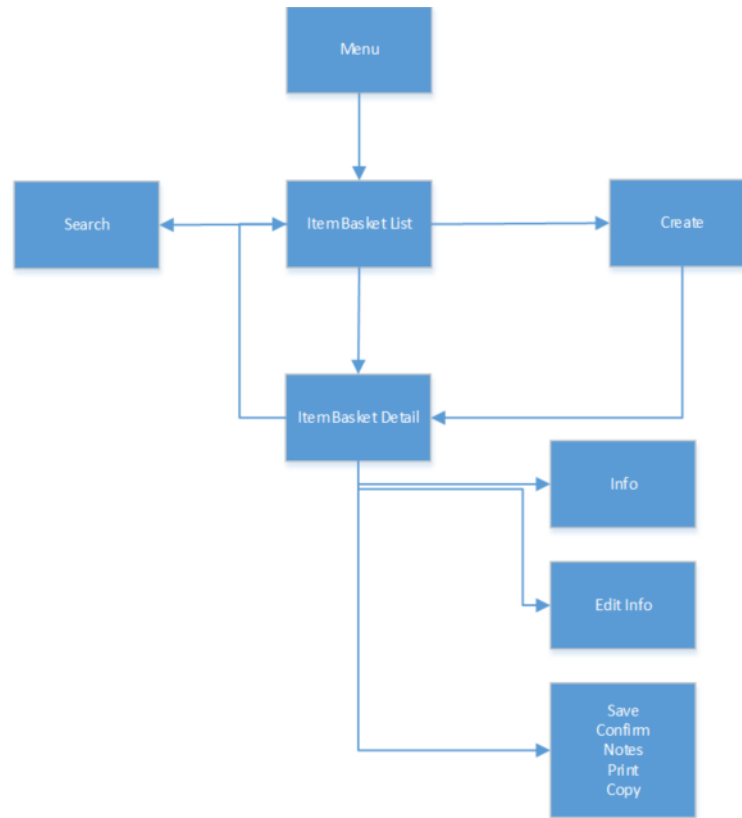
Figure 9–1 Item Basket Desktop Screen Flow

Item Basket is accessed under the **Inventory Management** menu. Selecting the menu option takes the user to the **Item Basket List** screen. From here the user can go the **Item Basket Search Criteria** screen to search for other item baskets. Selecting an item basket from the list will navigate to the **Item Basket Detail** screen to view or edit the details of the item basket. A user can create a new item basket by selecting **Create** from the **Item Basket List** screen. On the **Item Basket Detail** screen, the user will have access to view or edit header level information (including CFAs if setup), or create or view notes about the basket. The item basket can be printed, saved for later, or confirmed. Lastly, a **Completed** status item basket can be copied.

Item Basket List

Figure 9–2 Item Basket List Screen

Item Basket List

Search | Status = In Progress | Search Limit = 100

Results: 6 | Refresh | Create | Delete | [Grid Icon]

Item Basket ID	Description	Status	Type	Date	User
<i>Filter</i>	<i>Filter</i>	<i>Filter</i>	<i>Filter</i>	<i>Filter</i>	<i>Filter</i>
2072	ItemBasket- test	In Progress	Investigation	11/6/19	sim_admin
2176	kl	In Progress	Gift Registry	11/19/19	sim_qa3
2293	IB-Update-2533	In Progress	Gift Registry	1/1/20	sim_admin
2297	IB-Update-493	In Progress	Gift Registry	1/2/20	sim_admin
2301	IB-Update-7043	In Progress	Gift Registry	1/2/20	sim_admin
2305	IB-Update-1867	In Progress	Gift Registry	1/2/20	sim_admin

When navigating to [Item Basket](#), the **Item Basket List** screen displays the **In Progress** item baskets that are for the user's store or All Stores as the default list. These may be 'static' or 'dynamic' baskets'. The user can select the search options to navigate to the [Item Basket Search Criteria](#) screen to enter search criteria for item baskets.

Creating a new item basket navigates to the [Create Item Basket](#) popup to capture header level information for the [Item Basket](#) and then moving to the [Item Basket Detail](#) screen with no details (items) to build a new item basket. Selecting an item basket from the list directs the user to the details for that item basket.

Item Basket Search Criteria

Figure 9–3 *Item Basket Search Criteria Popup*

The screenshot shows a 'Item Basket Search Criteria' popup window with the following fields and controls:

- Item Basket ID:
- Description:
- Alternate ID:
- Type:
- Status:
- From Create Date:
- To Create Date:
- From Last Update Date:
- To Last Update Date:
- From Expiration Date:
- To Expiration Date:
- User:
- Item:
- Department:
- Class:
- Sub-Class:
- * Search Limit:

Buttons at the bottom:

The **Item Basket Search Criteria** screen is accessed by the **Search** button on the **Item Basket List** screen. After applying the search criteria, the results are listed on the **Item Basket List** screen and the criteria applied is shown.

Create Item Basket

Figure 9–4 *Create Item Basket Popup*

The screenshot shows a 'Create Item Basket' popup window with the following fields and controls:

- * Type:
- * Description:
- Alternate ID:
- Expiration Date:
- * Store:

Buttons at the bottom:

The **Create Item Basket** screen is used when creating a new item basket and it is accessed when selecting **Create** from the **Item Basket List** screen. A user must have create permissions to create a new item basket.

The type of item basket is required to be selected from the list. The type is populated from the list of item basket types defined in Code Info dialog within the desktop application.

Description is an optional text field to describe the item basket.

Alternate ID is also an optional field to hold an alternate ID given to the item basket by the user, different from that of the system generated item basket ID.

Expiration Date is a field to hold an optional expiration date used to update item baskets to **Canceled** status when the expiration date has passed.

Lastly, the **Store** field is required, and the options will include the user's store or 'All Stores'. 'All Stores' is only available to users that have the proper permission, and this option will allow for the creation of item baskets in which all stores would have access to use.

Item Basket Detail

Figure 9-5 Item Basket Detail Screen

The screenshot shows the 'Item Basket Detail' screen. At the top, there are navigation buttons: Back, Save, Confirm, Delete, Info, Edit Info, and Download Report. Below these, the 'Item Basket ID' is 3023, the 'Description' is 'TOSTRUG', and the 'Type' is 'Investigation'. There is a 'Notes' field with a text area. On the right, there is a 'Detail' panel with 'Add', 'Apply', and 'Cancel' buttons, and a 'Component Type' dropdown menu with options: Hierarchy, Item, Supplier, and Style. Below the header information is a 'Components' section with a table:

Department	Class	Sub Class	Item	Description	UOM	Pack Size	Quantity
Filter	Filter	Filter	Filter	Filter	Filter	Filter	Filter
3337-Cigarettes/ToBac	1-Cigarettes	1-Premium	24529209	ALB 512Z FROML20mg/12 tch	Case	7	7
2427-Nonion/Invshy	1-Walcher	1-Non's Walcher	20000500	SoftemLongNecknon	Case	100	7
3337-Cigarettes/ToBac	1-Cigarettes	1-Premium	20707036	ALB 500ZL50mg/12 con	Case	7	7
3338-Beer	2-Uproot Beer	2-Standard	33330147	Brnd ml	Case	7	7
2427-Nonion/Invshy	1-Walcher	1-Non's Walcher	33330112	Soft em 33330112	Case	7	7
3338-Beer	2-Uproot Beer	2-Standard	33330309	Overage! Reader - Blasting Mac	Case	10	7
3337-Cigarettes/ToBac	1-Cigarettes	1-Premium	33330304	ALB 507Z FROML20mg/12 tch	Case	7	7
3338-Beer	2-Uproot Beer	2-Crosspr	33330304	Spy ml	Case	10	7
3337-Cigarettes/ToBac	1-Cigarettes	1-Premium	333	7751 5142 551514	Case	7	7
333-Approved/ToBac	1-Smokes/ToBac						0

The **Item Basket Detail** screen displays the details of the **Item Basket**. When creating a new basket, there will not be any details/hierarchies. Header information about the basket is displayed along with the notes feature. Additional header information is available under **Info** and editable header information is under the **Edit Info** button.

Item Baskets can be created by Hierarchy, Item, Supplier, or Style. If it is for 'Hierarchy', the detail panel will allow for hierarchies to be added. Just the hierarchy itself is added, not the items, therefore no quantity is captured. The items for the hierarchy will get added at the time the item basket will be used (that is, in Area dialog). If 'item' is selected, the user will be able to add individual items to the item basket along with a quantity. The 'supplier' option allows a user to add all the items for a specific supplier. The quantity will default to one for these items but can be edited. Lastly, style allows a user to add all the child items that belong to a style. Again, the quantity will default to one for these items, but can be edited. In all cases that allow for quantity, the quantity must be greater than or equal to zero. A combination of any of the above component types can be added to an item basket (that is, hierarchy and style). The system restricts adding duplicate or overlapping hierarchies and items. Any item basket that contains a hierarchy will be marked as 'dynamic' whereas if there is no hierarchy on the basket it will be marked as 'static'.

Item ID is a hyperlink. Clicking on the link opens the Item Detail screen for that item in a new tab in the browser.

The [Item Basket](#) can be saved for later in **In Progress** status or confirmed which will mark it to **Completed** status and it will no longer be editable. **Completed** status item baskets can be used in various areas of the application. **Completed** status item baskets can be copied. A copy of the basket is created in **In Progress** state and it can be edited and updated as needed. The copied item basket will be referenced as the reference ID in the newly created item basket. **In Progress** item baskets can be deleted, which will set the basket to a **Canceled** state. Lastly, the item basket report can be downloaded [here](#).

Item Basket Info

Figure 9–6 *Item Basket Info Popup*

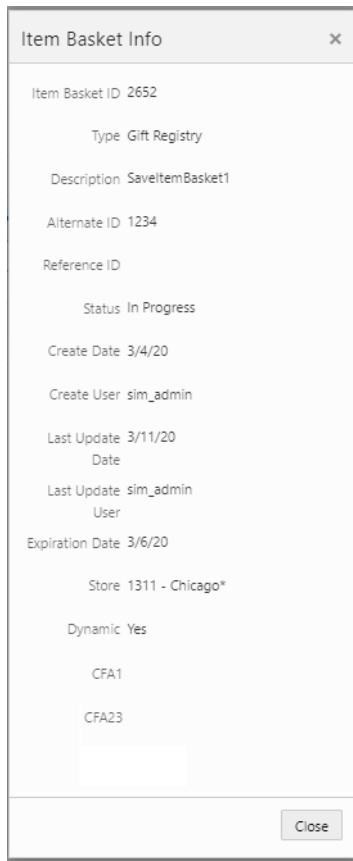

The **Info** popup is used for informational purposes and contains read-only information about the header level of the item basket. Info is accessed by selecting **Info** from [Item Basket Detail](#). Details include Item Basket ID, type, description, alternate ID, reference ID (of copied Item Basket), status, create date/user, last update date/user, expiration date, store, dynamic/static, and the CFAs that have a value.

Item Basket Edit Info

Figure 9–7 *Item Basket Edit Info Popup*

The **Edit Item Basket** screen is used to edit header level information about the item basket. **Edit Item Basket** is accessed by selecting **Edit Info** from the [Item Basket Detail](#) screen, and a user must have proper permissions to edit an Item Basket. The fields are the same as those on the [Create Item Basket](#) screen and include type, description, alternate ID, expiration date, store, and custom flexible attributes.

Edit Info also displays the list of CFAs (flexible attributes) that have been set up for Item Baskets in the system and lets the user enter values for them. The CFAs that are set up as being required must have a value entered for it before confirming the item basket. The value can be one of the following: Date, Text, Decimal, Long depending on the 'data type' set up for the CFAs defined during setup in the system. Appropriate security permission is needed for entering CFA values.

Authorizing a Stock Count

The desktop application provides the ability to authorize stock counts.

Portions of the stock count functionality, such as the setup of product groups, schedules, and authorizations, are performed in the desktop application only. You can configure and execute different types of stock counts such as cycle or annual counts, ad hoc counts, or counts that are based on inventory position or problems like negative stock on hand. Merchandising and individual level counting require setup and scheduling utilizing product groups, except for Ad Hoc counts. The Ad Hoc count allows you to decide which items to count by scanning from the shelf immediately.

Most of these counts can be scheduled to be executed repetitively on certain dates reducing the need for daily or weekly count management.

Because a variance percentage can be set, items within tolerance can, but do not have to be authorized individually.

After the stock count/recount process has taken place, or the third-party results file has been imported, the next step in the process is to authorize the stock count. This is the final step that allows you to make any last-minute corrections.

Figure 9–8 Stock Count Authorization Screen

Stock Count Authorization

Refresh Rejected Items Delete Confirm Authorization

ID	Description	Count Group	Date	Status	Total Items
6002	Ad hoc	Ishreg7	10/20/20	New	1
6022	Ad hoc	Ishreg21	10/21/20	New	1
6130	Ish_pl1	Ish_pl1_sch1	11/2/20	New	1
5982	Ad hoc	ishreg2	10/19/20	In Progress	1
5983	Ad hoc	ishreg3	10/19/20	In Progress	1

Child List: 6002

Refresh Update Auth Qty

ID	Description	Count Snapshot	Status	User	Items Left To Count
6522	sim_qa7	10/20/20	New		

You can access the **Stock Count Authorization** screen in the desktop application by selecting **Stock Count Authorization** located within the **Inventory Management** option.

This screen contains two portions. The first portion shows the list of master stock counts in 'Stock count' or 'Re-count' types and that are in New, In Progress, and Completed status.

You can select the stock count from the master stock count list and confirm the authorization by selecting the **Confirm Authorization** option. Note that proper permission is required to access the **Confirm Authorization** button.

Upon selecting the **Rejected Items** button, the system takes you to the **Rejected Items** screen if any rejected items are available for the stock count.

If there are no records with a type of 'Authorize' and a status of New or In Progress, the **Confirm Authorization** button is disabled.

When confirmed, the system confirms the stock count for all child stock counts in the master count and defaults to the last counted quantity to the authorized quantity field.

Upon selecting **Confirm Authorization**, all records with a type of 'Authorize' and a status of New or In Progress will be authorized.

Once it is authorized, the stock count becomes view only and no quantities can be changed.

On the master stock counts portion, the system displays the list with the Id, Description, Count Group, Stock Count Date, Status and the Total Items.

When you select a particular master stock count, the system displays the child list of the selected master stock count on the second portion and allows you to select the child stock count to go to the **Stock Count Authorization Detail** screen (Figure 9–9).

Select the **Update Auth Qty** button both in this screen and the **Stock Count Authorization Detail** screen to auto-fill all Authorized Qty with the last count quantity:

- These records only display the primary location of the item and have rolled up all pack quantities to the primary item if the packs are notional.
- The Auth quantity will default from the "counted" / re-counted quantity.
- The variance columns will be based on the rolled-up quantity.

Figure 9–9 Stock Count Authorization Detail Screen

Stock Count Authorization Detail

[← Back](#) [Save](#) [Confirm Child](#) [Update Auth Qty](#) [Apply Late Sales](#)

Stock Count ID 566 Group Unit: s-1 ung Child Unit: ung 1 Date 11/12/21 Authorization User
 Stock Count Unit: ung 1 Description Description Total Items 5
 Description Child ID 3106 Child Count: New Status Discrepant Items 2
 Type Unit

[Refresh](#)

Item	Description	Discrepant	UOM	SOH	Count Qty	Cnt Var	Cnt Var %	Price Variance	Auth. Qty	UIN	Price	Price Type
Filter	Filter	Filter	Filter	Filter	Filter	Filter	Filter	Filter	Filter	Filter	Filter	Filter
100000112	100000112_LONG_DESCRIPTION	Yes	Units	0	56	56	5600%	\$5,600.00			\$100.00	Permanent
100000147	100000147_LONG_DESCRIPTION	Yes	Units	500	600	100	20%	\$10,000.00			\$100.00	Permanent
100050056	100050056_LONG_DESCRIPTION	No	Units	500	502	2	0.4%	\$200.00			\$100.00	Permanent

You can access this screen by selecting a child stock count from the child list on the **Stock Count Authorization** screen.

On the header portion of this screen, the system displays the Master Stock count Id, Description, Date, Type, Group Description, Child Id, Child Description, Total Items, Discrepant Items and you.

On the **Stock Count Authorization Detail** screen, you can enter authorized quantities for both discrepant and non-discrepant items for any type of Stock Count (Unit and Amount, Unit, Problem Line, Ad hoc).

The system displays line items in a child if that location is the primary location for it. The item may be present in multiple locations, but only the child which is its primary location will show it on the authorization detail screen. Clicking on the Item ID hyperlink opens the Item Detail screen for that item in a new tab in the browser.

1. Select the **Update Auth Qty** button in this screen to auto-fill all Authorized Qty with the last count quantity:
2. You can update the auth qty until it gets confirmed. Once it is confirmed it cannot be changed.
3. You can enter an authorized quantity that represents the quantity for the item in all its locations that will be compared against the snapshot. Note this means there will only be one authorization quantity per item regardless of how many locations the item exists in.
4. The Auth Qty field will not be editable for RFID items. The auth quantity will be based on the number of tags scanned during the counting phase. The Auth qty will be defaulted by the Counted Qty. Upon authorization of the stock count, the quantity of an item will be updated to the number of tags scanned/counted.
5. The UIN field will indicate whether the item is a UIN required item.
6. User will be able to see the current Price of the item, Price Type and the Price Variance. Price Variance for an item is calculated as follows:
 - Price * (SOH - Count qty), if the stock count was not re-counted
 - Price * (SOH - Re-count qty), if the stock count was re-counted

Clicking on **Apply Late Sales** button refreshes the snapshot to incorporate the late sales happened for the items in the stock count. This button is visible only when the child count is in 'New' or 'In-Progress' state. User must have **Apply Late Sales** permission for this button to appear in the screen.

On this screen, you can confirm the child count by selecting the **Confirm Child** button. This button is visible only when the child count is in 'New' or 'In-Progress' state. Upon selecting this button all authorized quantity is saved and the child count is confirmed. When you confirm the child count the system moves the status of Unit/Problem/Ad

hoc child count to Completed. If any authorized quantity fields are blank for Unit/Problem Line, the item is left as 'not counted', UNLESS Stock count null quantity=0 parameter is set to Yes.

If any of the authorization qty fields are blank for any type of Unit and Amount a message is displayed.

Figure 9–10 Authorization Detail - UIN

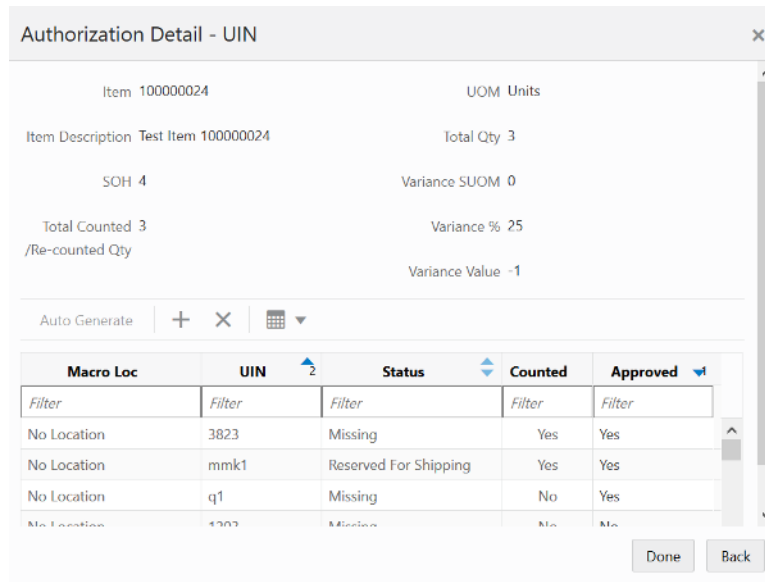

If the item is a UIN item, clicking on the icon in the UIN column displays the **Authorization - UIN** popup.

The purpose of this dialog is to allow you to review/amend what has been counted/re-counted and make any necessary changes in case of UINs while authorizing the stock count.

This screen will display all UINs that were counted during the count or re-count and will also display UINs that exist in the system and should have been counted based on their status when the snapshot was taken.

UINs with the following UIN states will be displayed regardless of whether they were counted or not.

1. In Stock
2. Customer Order Reserved
3. Reserved for Shipping
4. Unavailable

You will be able to auto generate UINs during the authorization process by selecting the Auto Generate button from this screen.

You can cancel out of the screen without saving changes.

The records will be sorted on below:

1. Approved in descending order
2. UIN in ascending
3. Location description in ascending

Figure 9–11 Authorization Detail - Multi Locations

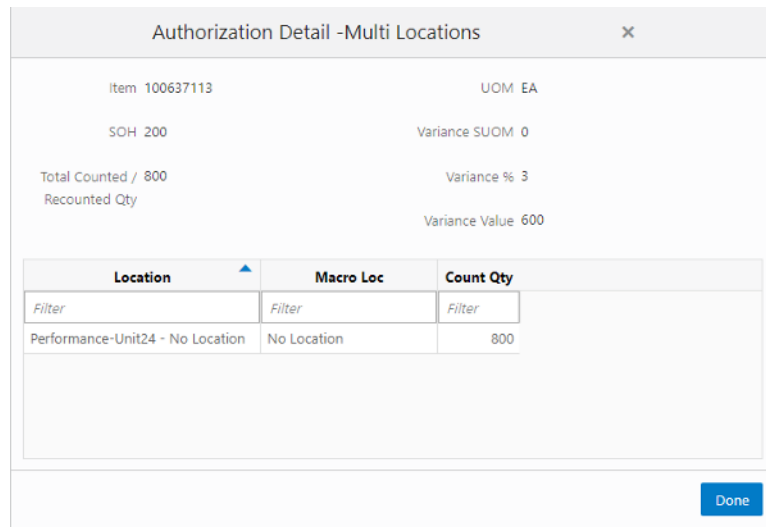

- If the item has **Multi-Loc** column set to **Yes**, then it will be a hyperlink. The system displays the **Authorization Detail Multi Locations** popup if the user clicks on **Yes** hyperlink.
- The dialog will appear for all types of stock counts.
- The popup will display all the locations that the item belongs in, including the current primary location of the stock count authorization screen.

Figure 9–12 Rejected Items Screen

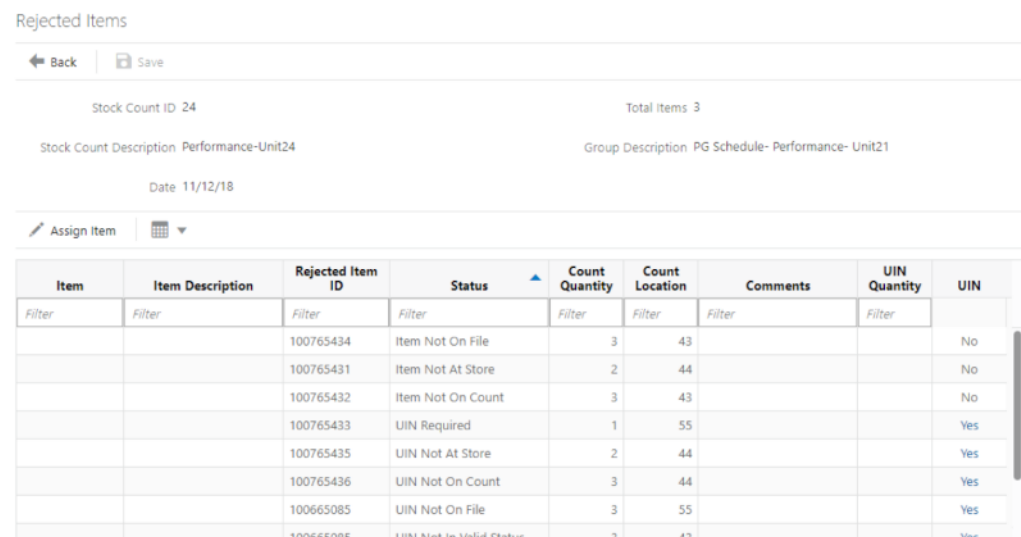

- The **Rejected Items** screen is to show you the items rejected during the 3rd Party Child Stock Count upload and the invalid scans.
- Items can also be added if the auditing is turned on and the scanning is invalid or wrong or duplicate UINs.
- The **Rejected Items** screen will contain a list of all items in the Rejected Items Table for the selected master Stock Count.

- When performing a Unit and Amount, Third Party Count, if items are counted that should be on the stock count, but were not extracted, they are added to the stock count line item table when the third party results file is processed if they meet the following criteria. If they do not meet the criteria, the items are added to the stock count rejected items table:
 1. Unit and Amount Stock Count
 2. Product Group setup to include All items
 3. Product Group setup to Auto Authorize
- Any items not recognized by the system during the import of the third-party stock count file will be stored in a Rejected Items table. The Rejected Items screen will allow you to assign a valid Item ID that is present in the system to the count information for items not on file and items not on the count. Once a valid item ID is assigned to the not on file items, the system will update the appropriate stock count record with the count Quantity.
- Rejected items may include 'Item Not at Store', 'Item Not on File' or 'Item not on Count' or 'Invalid Decimal for UOM'.
 1. Unknown items (Item not on file) - items that are not known to the enterprise. These will not be added to the export file. They will be displayed on the 'Rejected Items' screen in SIOCS and will be flagged as 'Item not on file.' You will be able to assign a valid item id that exists in SIOCS item database to these items.
 2. Non-ranged items (item not at store)- items are known to the enterprise, but not ranged to the store. These will be added to the **Rejected Items** screen in SIOCS and can be assigned to the count. These items will be flagged as 'Item not at store.' You will be able to assign a valid item id that exists in SIOCS item database to these items.
 3. Items 'not on count' will include items that fall outside the specified hierarchy as well as items that are non-inventory maintained in SIOCS. You will not be able to assign items to it.
 4. Invalid Decimal for UOM items that are pertaining to invalid decimal. You will be able to assign a valid item id that exists in SIOCS item database to these items.
- Once the count is in Authorize Complete status, the **Rejected Items** screen will be view only.

Unit and Amount Rules

- Upon selecting **Confirm Authorization**, all records with a type of 'Authorize' and a status of New or In Progress will be confirmed and exported to merchandising system in one file.
- Once a record has been confirmed, the 'Auth User:' field on the **Stock Count Detail, Re-count** and **Stock Count Authorization** screens will display with you that selected the **Confirm** button. Any child count that has been confirmed will no longer be editable.
- The Store Inventory system automatically triggers the exporting results function, so the results are exported to merchandising system.
- Once the last child count is confirmed, a flat file is sent to the merchandising system. You are prompted that confirming this last child moves the entire count to **Authorize Completed** and no further action can be taken.

You will be able to view the authorized quantities when entering the authorization screen. After **Confirm Authorization** is selected, the **Stock Count Authorization Detail** screen (Figure 9-9) is view only. Once exported, the system will complete the stock count process by writing inventory adjustments in the system and send all Authorized Quantities for the entire stock count record (discrepant and non-discrepant items) back to merchandising system. The stock count status is set to **Completed** and no further changes will be allowed in the application.

On this screen you can select the **Update Auth Qty** button to auto-fill all Authorized Qty with the last count quantity:

- The Authorized Qty field will update with the rolled-up quantity of the packs and components.
- The variance columns will be based on the rolled-up quantity.

Unit, Ad Hoc, Problem Line Counts Rules

When you re-enter a stock count in authorize that has or has not been completed the SOH should remain constant and that of the last snapshot.

Upon selecting **Confirm Authorization**, the system will adjust the SOH to the Authorization Quantity entered for the Item.

If the **Updating Stock on Hand** parameter is set to **Discrepant Items**, the system will only update the SOH for discrepant items that were counted.

If the **Updating Stock on Hand** parameter is set to **All Items**, the system will adjust the SOH for both discrepant and non-discrepant items that were counted.

An Inventory Adjustment record will automatically be created to adjust the inventory to the Quantity entered for the item.

You are prompted if some items are not assigned an Authorized Quantity when the **Confirm Authorization** button is clicked.

If you select **OK** and the Stock Count Null = 0 parameter is set to **No**, all items without an Authorization Quantity will have their SOH left as it is, with no adjustments made. The item will be considered 'not counted' in this case.

If you select **OK** and the Stock Count Null = 0 parameter is set to **Yes**, all items without an Authorization Quantity will have their SOH set to the last counted quantity. This would be 0 if no physical count quantity was entered.

If you select **Cancel**, you will be returned to the Authorization screen without confirming the count. Any quantities that were entered by you will remain on the screen.

When the **Confirm** button is pressed for the last child count needing authorization, the status for the Stock Count will change to Completed. At this point, the Stock Count will be read-only.

You can enter data into the Authorized Quantity field for both discrepant and non-discrepant items.

You can auto-fill the authorized qty field by selecting the **Update Auth Qty** button.

Transaction History

The **Transaction History Lookup** functionality provides users with the ability to view information about existing transactions which have an impact to an items stock on hand. Transaction History is a lookup screen that is accessed under the **Inventory Management** menu option of the application.

- [Transaction History Search](#)
- [Transaction History](#)

Transaction History Search

Figure 9–13 Transaction History Search Criteria

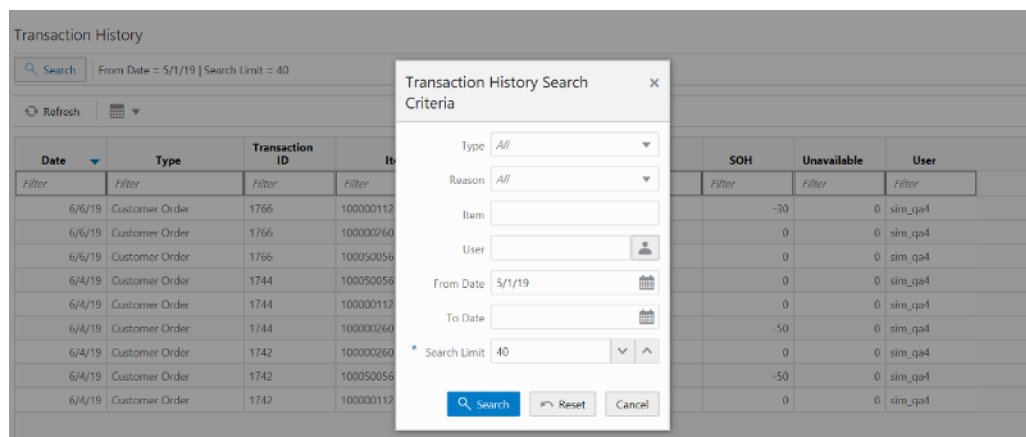

The **Transaction History** dialog initially directs you to a search criteria screen to select filter criteria for the records to be displayed before presenting the list of transactions. The default for the search is all transactions for today for your store. Additional search criteria include From and To Date, Type of Transaction (that is, Customer Order Delivery, Inventory Adjustment, and so on), Reason, Item, and User.

'From Date' will be defaulted with a date based on the value of system configuration parameter 'Search Date Range Default for Transaction History'. For example, if the system config parameter value is set to '90', the From Date will be defaulted with <today's date> - 90.

Transaction History

Figure 9–14 Transaction History List

Transaction History

Search From Date = 10/19/21 | To Date = 10/27/21 | Search Limit = 50

Refresh

Date	Type	Transaction ID	Item	Description	Reason	SOH	Unavailable	User
10/21/21 1:10:43 AM	DSD Receiving	420	10000059	100000059_LO...	Receipt	5	0	sim_qa3

The **Transaction History** is a read-only screen which displays all transactions, per the selected search criteria, in the system for your store that have an impact on the stock on hand. Each time a transaction is created which updates inventory to a final state, it gets written to the transaction history. It does not include the saved transactions (reserved inventory), rather it includes the transactions which are completed.

The following fields are listed for each record:

- **Date:** The date and time when the transaction was completed.
- **Transaction Type:** The type of the original transaction such as Direct Delivery, Stock Count, and so on.
- **Transaction ID:** The Transaction ID that is associated with the original transaction. It will be a link for those transactions that can be navigated to. Clicking on this link will navigate the user to the transaction the record was created from.

For Inventory Adjustments and Stock Count Authorization, the user will be navigated to the original transaction since they are available in the desktop application.

For transactions which do not have their original transaction in the desktop application such as DSD Receiving, Transfer Shipment, Transfer Receiving and Return to Vendor, clicking on this link will navigate to Container Lookup where the list of containers associated with the transactions will be listed. This enables the user to view the details regarding the transaction. The user can open a container to view the items and other details. If the transaction has only one container, the user will be taken to Container Detail screen directly.

There will be a back button in the transaction screens which will navigate the user back to Transaction History. The user must have security access to the transaction for the system to navigate there. The same security permissions should exist as if the user accessed the dialogue via the functional area normally. Also, the mobile application must be licensed by the retailer in order to view the transaction details.

- **Item:** The Item ID. This is a hyperlink which when clicked, takes the user to the Item Detail screen for that item. User can return to the Transaction History List screen by clicking on the Back button in Item Detail screen.
- **Description:** The description associated with the Item ID.
- **Reason:** Reasons associated with history record.
The reason is either a hard-coded description or an actual Inventory Adjustment reason code.
- **Stock on Hand and Unavailable:** show the stock movement of up or down for the transaction.
- **User:** you that created the original transaction.

Troubled Transactions

The **Troubled Transactions List** screen is an admin screen for the supervisor or the store user to reconcile the transactions with UIN and that are in trouble. The [Troubled Transactions List](#) dialog screen is accessed under the **Inventory Management** menu option of the application.

- [Troubled Transactions List Search Criteria](#)
- [Troubled Transactions List](#)
- [Troubled Transactions List Navigation](#)

Troubled Transactions List Search Criteria

Figure 9–15 Troubled Transactions List Search Criteria

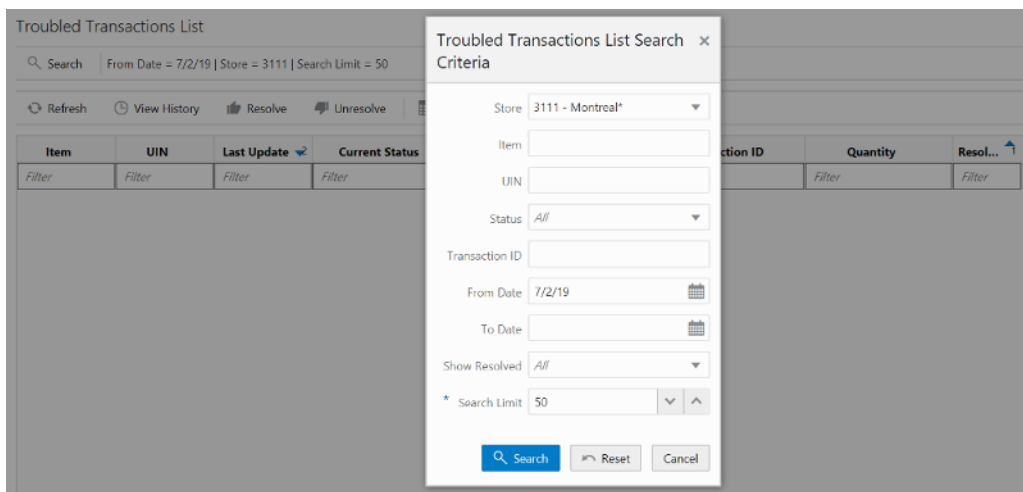

The **Troubled Transactions List** dialog initially takes you to a search criteria screen to select filter criteria for the records to be displayed before presenting the list of troubled transactions. The default for the search is all the troubled transactions for today for your store. Additional search criteria include From and To Date, Transaction Id, Item, UIN, Status, Resolution status (Resolved, Unresolved).

Troubled Transactions List

Figure 9–16 Troubled Transactions List

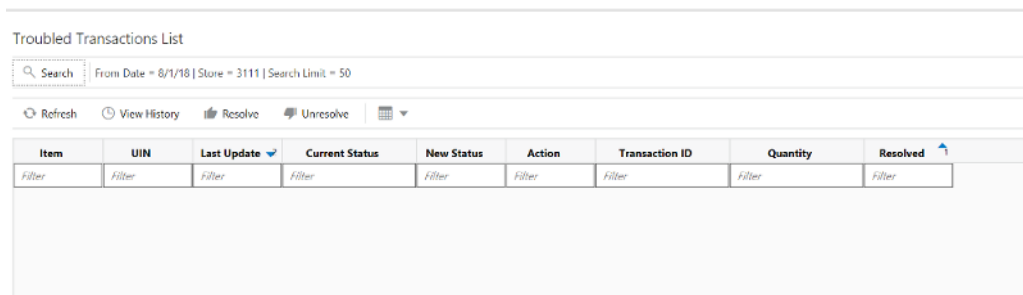

The **Troubled Transactions List** is a screen which lists all the UIN and Received Unit Adjustment troubled transactions that exist in the system.

Upon selecting the menu, the system initiates the search criteria screen automatically and the list screen displays the transactions per the given search criteria.

You can also manually mark a record as resolved if no update needs to occur.

The screen allows multi selection of records to move to the resolution status.

You can view the history of the UIN by selecting the **View History** button which takes you to the [UIN History](#) screen.

From this screen with the proper privilege, you can view the [UIN History](#) for an item.

With the proper privilege, you can update the status of the UIN resolution record to Resolve or Unresolved if it is already in resolved status.

The following fields are listed for each record:

- **Item:** The Item ID present in the troubled transaction.
- **UIN:** Displays the UIN of the item that was sold or returned.
- **Last Update:** The last updated date of the exception record.
- **Current Status:** The status of the UIN at the time the exception was raised. This could be different than the current status in the system, that is, was In Receiving when the Update process tried to process, but the receipt has been completed so now the UIN is in In Stock status.
- **New Status:** The proposed new status the system tried to update the UIN to.
- **Action:** The action within the UIN Update Status Web Service. This could also be RUA for those exceptions generated from Receiver Unit Adjustments.
- **Transaction ID:** Displays the unique identifier of the transaction that will tie back to the external system.
- **Quantity:** For adjustments this will hold the adjustment quantity. The value will be prefaced with - to indicate the negative numbers and no prefix in case of positive numbers.
- **Resolved:** Displays a Yes/No value for those records that have been resolved/not resolved within the system.

Troubled Transactions List Navigation

You can select a record from the list and move it to 'Resolved' or 'Unresolved' status by selecting the **Resolve/Unresolve** buttons.

If you select a record and the **View History** button, the system goes to the [UIN History](#) screen.

Ticketing

Ticketing provides the ability to print shelf edge labels and item tickets for stock at the store and use an external application to print and manage the format details. Shelf edge labels (label formats) and Item tickets (ticket formats) can be created and submitted to print in the system. Tickets or labels can be printed for individual items on the desktop application and quick item print of tickets can be managed using the **Quick Item Print** functionality in the mobile application.

Ticket Search Criteria

Figure 9–17 Ticket Search Criteria

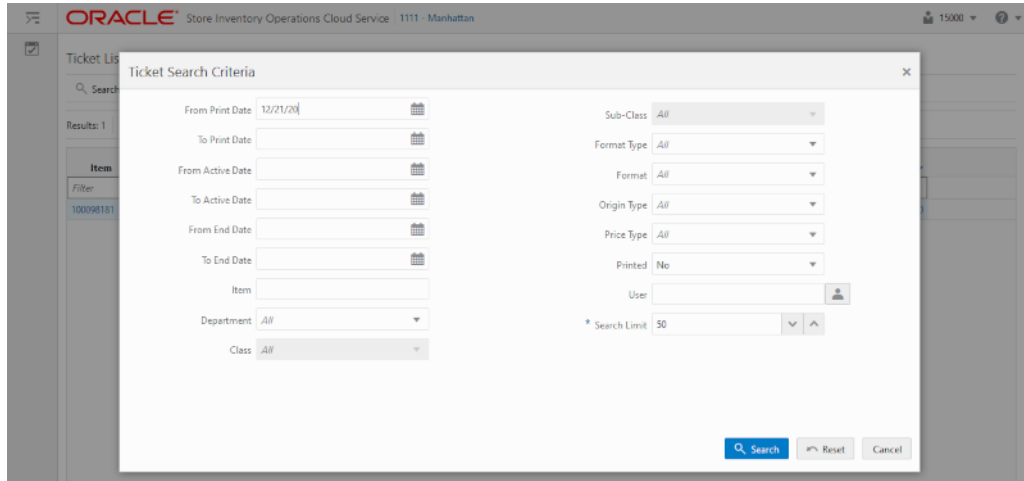

The **Ticket List** dialog initially directs the user to a search criteria screen to select filter criteria for the records to be displayed before presenting the list of tickets. The default for the search is all tickets for the current store and current date.

The user can search the tickets based on several criteria such as Print Date range, Active Date range, item, merchandise hierarchy, format type, format, print status and so on.

The system displays the tickets on the list screen based on the criteria provided by the user here.

Ticket List

Figure 9–18 Ticket List

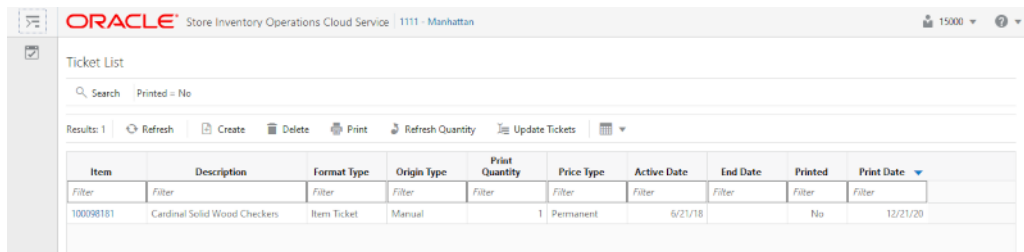

The **Ticket List** screen is accessed from the Inventory Management-Ticket menu.

From the Ticket List screen, the user has the potential to perform numerous tasks. The user can create, edit, delete, refresh the quantity, and print a ticket. Search Criteria will automatically display when the user enters the screen. Once the user has entered the screen, the filter option is available to further filter on the item tickets displayed.

The **Refresh Quantity** button can refresh the ticket quantity based on the current SOH. The status of the item ticket may be identified using the Printed field which indicates whether Printed Yes or No.

The **Update Tickets** button takes the user to a dialog to update various ticket components as described below.

When the user selects to print the tickets, the system displays a popup for the user to select the printer to which the print must be submitted and to indicate whether the quantity must be refreshed before submitting. The system will display the user preferred printer set by default and allow to change.

The detail fields on this screen includes, Item, Description of item, Format Type, Origin Type, Print Quantity, Price Type, Active Date, End Date, Printed Status and Print Date.

Update Tickets

Figure 9–19 Update Tickets

The Update Tickets screen is accessed when the user selects one or more tickets and then select the **Update Tickets** button on the Ticket List screen.

On this screen, the user can **Assign Format**, select the **Print Date**, and **Refresh** the quantity based on the current SOH for the selected tickets.

The **Auto Print** field is for future use.

Ticket Detail

Figure 9–20 Ticket Detail

The Ticket Detail screen is accessed when the user selects to Create a new ticket or select an existing ticket to view and edit.

The **Item Ticket Detail** screen allows the user to manually create tickets/labels and edit the existing tickets if it is not printed. The system also allows the user to reprint the already printed tickets.

The user can select the printer and refresh the quantity when selected to print.

The lookup features provides a robust system for searching information. You are able to search for items and UINs.

- [Item Lookup](#)
- [UIN Lookup](#)
- [Supplier Lookup](#)
- [Container Lookup](#)
- [Finisher Lookup](#)
- [Item Scan Number Lookup](#)

Item Lookup

The Item Lookup functionality in the desktop application provides the business user with the ability to view information related to an item. The system provides real-time information on inventory positions and other item detail information.

The following information about an item is available:

- Merchandise Hierarchy
- Status
- Primary Supplier
- Item Attributes, Ordering Attributes, CFAs
- Price Information
- Stock on Hand and Non-sellable Inventory
- Pack / Component Details
- Deliveries
- Related Items
- Stock Locator
- UDA
- RFID Locations
- Item Locations

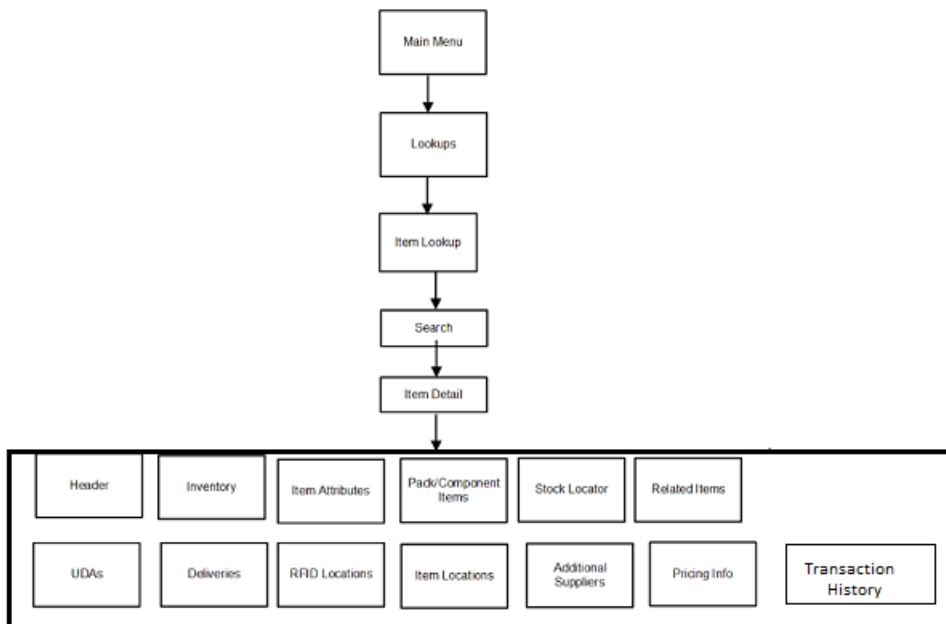
Figure 10–1 Item Lookup Screen Flow

This is a screen flow for the Item Lookup functionality. Selecting **Item Lookup** from the Main Menu \ Lookups directs to the **Item Lookup** screen. From **Item Lookup**, you can search for items and view different details about the item, via the **Item Detail** screen. An item's information is presented in the **Item Detail** screen as different sections. The list of sections that are available in the Item Detail screen are as follows:

- Header
- Inventory
- Item Attributes
- Pack Items
- Component Items
- Stock Locator
- Related Items
- UDAs
- Deliveries
- Item Locations or RFID Locations
- Additional Suppliers
- Pricing Info
- Transaction History

Figure 10–2 Item Lookup Screen

Item Lookup

Search Reset

Search Mode: Department: Brand Description:

Item: Class: Item Status:

Item Description: Sub-Class: * Search Limit:

Records Found: 2 | Total Available SOH: 70

Item	Description	Primary Supplier	Department	Class	Sub-Class	Available SOH	Price	Price Type	UOM	Status
<i>Filter</i>	<i>Filter</i>	<i>Filter</i>	<i>Filter</i>	<i>Filter</i>	<i>Filter</i>	<i>Filter</i>	<i>Filter</i>	<i>Filter</i>	<i>Filter</i>	<i>Filter</i>
100000260	Milk Powder	6200 - Local Grocer...	1118 - Grocery	2 - Dairy	3 - Premium	4	\$36.25	Clearance	EA	Temporary
100000147	Toned milk	6200 - Local Grocer...	1118 - Grocery	2 - Dairy	2 - Standard	66	\$34.25	Clearance	EA	Active

When navigating to **Item Lookup**, you are taken to a blank list screen where no item results are displayed. You are presented with various search criteria to lookup for the item. You can enter the search criteria to find the items. After applying the search criteria, the results are listed on the screen. The screen displays the search criteria depending on the Search Mode. You can choose to find items by item number, supplier, warehouse, UDA, Inventory Status, or style. Depending on which search mode is selected, the search criteria fields change. All search modes, except for searching by style, have common search criteria consisting of item description, brand, item status, search limit, department, class, and sub-class. If item Id is used to lookup the item, the system ignores all other search criteria entered and searches for the item entered. When the user enters the screen, the cursor will be on Item field by default which enables the user to scan/enter Item ID and hit enter to initiate the search.

If the search results in a single item, the system takes you automatically to the **Item Detail** screen of the item. If more than one item is found, the list of items is displayed and you can click on an item to view the details of the item in the Item Detail screen.

The number of items returned by the search is displayed in 'Records Found' field just above the grid. The Total Available SOH field displayed next will show the summation of the Available SOH for all items that are listed on Item Lookup based upon the entered search criteria. There will be different UOMs added together because items returned by the search may have different UOMs hence there will be no UOM listed for the Total Available SOH field.

The details of the item such as Item ID, Item Description, Primary supplier, Department, Class, Sub-class, Available SOH, Price, Price Type and UOM are displayed in this screen in order to provide basic information about the items. The pricing related information (Price and Price Type) are displayed only when the system configuration parameter 'Display Price in Search Result - Operations' is set to 'Yes'. The Reset button displayed in the screen resets the values in the Search criteria fields and clears the search results currently displayed.

Item Description

This field holds an item description, which you enter to search. You can search on partial description as well, meaning that as long as the Item Description contains what is entered in this field, results are returned. This search criterion can be used for any other search type except when searching by Style.

Brand

This field holds the brand, where you enter to search. Enter in a brand for the item. The system returns all items for the brand specified. This search criterion can be used for any other search type except when searching by Style.

Dept

This field allows you to select from a list of available Departments for the selected group. This search criterion can be used for any other search type except when searching by Style.

Class

This field allows you to select from a list of available classes for the selected department. This field is only enabled if a department has been selected. This search criterion can be used for any other search type except when searching by Style.

Sub-Class

This field allows you to select from a list of available sub-classes for the selected department/class. This field is only enabled if a department and class has been selected. This search criterion can be used for any other search type except when searching by Style.

Item Status

This field is a drop down listing all the various statuses of an item and enables you to lookup for items in a particular status. List of values include 'Ranged', 'Active', 'Discontinued', 'Deleted', 'Inactive', 'Temporary' (Ranged in the Inventory system and not yet approved in the Merchandising system), 'All Items'.

Selecting **Ranged**, the system will return items in the 'store' in statuses Active, Discontinued, Deleted, Inactive, Temporary.

Selecting **Active**, the system will return items in the store in status 'Active'. Same case with Discontinued, Deleted, Inactive, Temporary statuses as well.

Selecting **All Items**, it returns items in all statuses from Item master table. This can be used if you want to include 'non-ranged' items.

Searching by Item

Figure 10–3 Search Mode: Item

The screenshot shows the 'Item Lookup' search interface. At the top, there are 'Search' and 'Reset' buttons. Below, the 'Search Mode' is set to 'Item'. Other search criteria include 'Department' (All), 'Brand Description' (empty), 'Item' (empty), 'Class' (All), 'Item Status' (Ranged), 'Item Description' (empty), 'Sub-Class' (All), and 'Search Limit' (50).

Item

This field holds an item number, which you enter to search. Partial searches are not permitted on the item number. You can enter an item number, UPC/EAN, Type 2, GS1 Databar, VPN, or RFID into this field. The system can locate the specified item. This is the default search mode.

Searching by Supplier

Figure 10–4 Search Mode: Supplier

The screenshot shows the 'Item Lookup' search interface with 'Search Mode' set to 'Supplier'. The 'Supplier' field is active. Other search criteria include 'Department' (All), 'Item Status' (Ranged), 'Supplier' (empty), 'Class' (All), '* Search Limit' (50), 'Primary Supplier' (switched to 'Yes'), 'Item Description' (empty), 'Sub-Class' (All), and 'Brand Description' (empty).

Supplier

This field holds a supplier number, which you enter to search. You can search for items by primary and non-primary suppliers.

Primary Supplier (Switch)

- The Primary Supplier switch determines whether to display all items supplied by the entered supplier (based on the Supplier or Supplier Name search fields) or only display items where the entered supplier is the primary supplier for that item: If the indicator is on, the system only displays items where the entered supplier is the primary supplier of the item. This is the default.
- If the indicator is off, it displays all items supplied by the supplier ID that was entered in the search criteria field, regardless of whether the entered supplier is the primary supplier. In this case, you may see items in the search results that have a different supplier ID and name than what was entered in the search criteria. This means the item is supplied by the entered supplier but has a different primary supplier.

Searching by Style

Figure 10–5 Search Mode: Style

The screenshot shows the 'Item Lookup' search interface. At the top, there is a search bar with a magnifying glass icon and a 'Reset' button. Below the search bar, there are several input fields and dropdown menus. The 'Search Mode' dropdown is set to 'Style'. The 'Item Status' dropdown is set to 'Ranged'. The 'Style' text input field is empty. The 'Search Limit' dropdown is set to '50'.

Style (Item ID)

You can search on a style item ID. The Item Description, Brand, Department, Class, and Sub-Class search options do not display when the Style Search option is selected. Enter a style item (style is where the item level is above the transaction level), and the system returns all the transaction level children that are related to the style parent/grandparent.

Example:

Enter Style ID

10001001 Shirt Item level 1, tran level 2

Search Returns

10001011 Shirt 1, green shirt item level 2, tran level 2

10001012 Shirt 2, blue shirt item level 2, tran level 2

10001013 Shirt 3, red shirt item level 2, tran level 2

Searching by Warehouse

Figure 10–6 Search Mode: Warehouse

The screenshot shows the 'Item Lookup' search interface with 'Search Mode' set to 'Warehouse'. The 'Warehouse' dropdown is set to 'All'. The 'Department' dropdown is set to 'All'. The 'Brand Description' text input field is empty. The 'Class' dropdown is set to 'All'. The 'Item Status' dropdown is set to 'Ranged'. The 'Sub-Class' dropdown is set to 'All'. The 'Search Limit' dropdown is set to '50'.

Warehouse

This field is a drop down listing all the warehouses by number and name in numerical order. You are able to select a specific warehouse and the system returns all items for the selected warehouse.

Searching by UDA

Figure 10–7 Search Mode: UDA

UDA

This field allows you to pick a specific User Defined Attribute (UDA) and enter the corresponding search criteria. For an item to be returned, it must match all criteria entered.

Text

This field allows you to enter any part of the UDA text. Wild card searches are also allowed.

Value

This field allows you to select from a list of pre-defined values for the UDA.

Date Range

This field allows you to enter a range of dates. Any item falling within that range is returned, providing any other criteria also matches.

Searching by Inventory Status

Figure 10–8 Search Mode: Inventory Status

Inventory Status

This field allows you to search by available or unavailable inventory status. The system returns all items that match the status selected by you. If **Available** is selected, the system returns the items that have available inventory. If **Unavailable** is selected, the system returns the items that have non-sellable unavailable inventory. This search feature gives you a way to search for items that have unavailable inventory which might need further action. It can be especially useful when looking up items when creating inventory adjustments.

Sub-Bucket

Figure 10–9 Search Mode: Inventory Status - Unavailable

Item Lookup

Search ↔ Reset

Search Mode: Inventory	Department: All	Item Status: Ranged
Inventory Status: Unavailable	Class: All	Search Limit: 50
Sub-Bucket: All	Sub-Class: All	
Item Description: <input type="text"/>	Brand Description: <input type="text"/>	

This field allows you to continue to filter down by sub-bucket. Sub-buckets are only an option if the system is configured to use sub-buckets. The Inventory Status must be selected as **Unavailable** for the Sub-bucket filter to be enabled. The system returns all items that match the selected Inventory Status and Sub-bucket.

Item Detail

Figure 10–10 Item Detail Screen

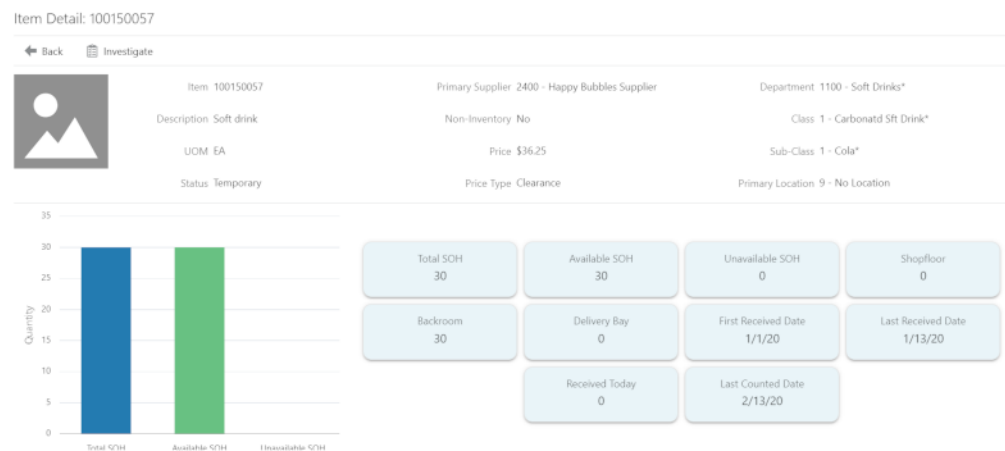

Selecting an item from the search results on the [Item Lookup](#) screen brings you to the [Item Detail](#) screen. The header shows the Item Number, Description, Unit of Measure, and item image if configured to show images. Additional header information includes the item Status, Primary Supplier, Non-Inventory item or not, Price and Price Type, Department, Class, Sub-class and Primary Location of the item. A bar graph is also displayed to show the inventory status of the item. The header also gives information about the Total SOH, Available SOH, Unavailable SOH, Shopfloor and Delivery Bay quantity, First Received Date, Last Received Date, Last Counted Date and the units received today.

This section also has an option to add the item to an **Investigate Item Basket**. If one or more item baskets exist in 'In Progress' status with a type of 'Investigate' for the user's store, the item will be added to the newest item basket. Otherwise, a new 'Investigate' item basket will be created. The item basket will be 'static' and available in the **Item Basket** dialogs of both the desktop and mobile.

Below the header, various sections are listed which display the details of an item such as inventory, item attributes, stock locator, and so on.

Inventory

Figure 10–11 Inventory

Inventory		
Total SOH 5	Unavailable SOH 2	Nonsellable 2
Available SOH 3	Transfer Reserved 0	Sub-Bucket
Delivery Bay 0	RTV Reserved 0	Trouble 2
Received Today 0	Customer Order Reserved 0	

This is the Stock on Hand Details for an item. It was accessed by clicking on the **Inventory** section from the [Item Detail](#) screen within [Item Lookup](#). This screen shows all the various stock on hand buckets including total SOH, available SOH, shopfloor, backroom, delivery bay, unavailable SOH, transfer reserved, RTV reserved, customer order reserved, nonsellable and the list of sub-buckets with the respective inventory.

Note: The shopfloor and backroom buckets are only displayed when the parameter `Display Shopfloor/Backroom quantity= Yes`.

The delivery bay bucket is only displayed when the parameter called `Replenishment - Delivery bay inventory` is set to **Yes**.

Sub-bucket details will only display when the system is configured for sub-buckets.

Stock On Hand Info

Total Stock on Hand = Available + Unavailable

Unavailable = Transfer Reserved + RTV Reserved + Non-sellable + Customer Order

Note: SOH and any reference to inventory will not be available for non-inventoried consignment or concession items.

Available = Shopfloor + Backroom + Delivery Bay

View UINs

If the item is a serialized item, you will have an option called **View UINs** under the **Inventory** section. By clicking on this, you will be taken to the **Item UIN List** screen where you can see the list of UINs available for the item.

Item Attributes

Figure 10–12 Item Attributes Section

Item Attributes		
Primary UPC: 100000235	Pack Item: No	Ticket Type: 345
VPN: 12345	Pack Type: Item	Replenishment Method
Brand: Levi's	Pack Size: 10	Next Delivery Date
Brand Description	Orderable: Yes	Diff 1: Flavor - Banana
Type: Owned Item	Sellable: Yes	Diff 2: Size - Extra Large
RFID Item: No	Customer Order Ship Alone: No	Diff 3: Inseams - Long
UIN Item: No	Reject Store Order	Diff 4: Color - Tobacco
UIN Type	Store Pack Inventory: No	

Item Attributes is accessed by selecting the **Item Attributes** menu option from [Item Detail](#). It displays the item attributes for the item at your store.

Item Attributes

Additional information may also be helpful to view about an item. The following are some additional item attributes available on this screen.

Status: Item status as the location.

VPN: Vendor product number for the primary supplier of the item.

UPC: UPC for the item.

Brand: Brand of the item.

Type: Indicates the type of item whether it is Owned/Consignment/Concession.

- Owned - If the item is company owned
- Consignment - If the item is a consignment item (purchase type indicator in RMS is set to 's' for this item)
- Concession - If the item is a concession item (purchase type indicator in RMS is set to 'c' for this item)

Pack Item: Yes/No; indicates if the item is a pack item.

Pack Type: indicates the pack type of the item.

Pack Size: This field holds the pack size (number of items in a supplier case) of this item:

The pack size is populated from the item/supplier/country record for the primary supplier.

For non-ranged items, this value is pulled from the master item data, for the default supplier.

Ticket Type: Merchandising suggested ticket type code/format.

Orderable: Yes/No; indicates if the item can be ordered.

Sellable: Yes/No; indicates if the item is sellable.

UIN Item: Yes/No; indicates if the item is a serialized item.

UIN Type: Indicates whether it is a serial number item or auto generated serial number item. Displayed only for a UIN item.

Reject Store Order: Reject the item request if the item is a store order replenishment item and it does not fall within the replenishment dates. Reject Store Orders should display Yes/No if the store orders replenishment method is store orders. In all other cases it should display NULL.

Replenishment Method: The replenishment method setup for this item in the merchandising system

Store Pack Inventory: Yes/No; indicates tells the system when an item will only be sold and tracked as a pack.

Customer Order Ship Alone: Yes/No; tells the system if an item needs to be shipped alone in customer order deliveries or not.

Next Delivery Date

Differentiators

Custom Flexible Attributes

Non-inventory: Yes/No; indicates if the item is flagged as non-inventory.

Pack Items

Figure 10–13 Pack Items Section

Pack Item	Description	Pack Type	Quantity in Pack	Available SOH
100000260	Test Item 100000260		8	

Clicking the **Pack Items** section on [Item Detail](#) displays the packs that exist for the item. The Pack option is available even if the item is not part of a pack. If it is not part of a pack, no content is displayed for the item. All quantities are in the SUOM.

Clicking on a pack item ID navigates you to the item detail for that item. You can return to the original item.

Component Items

Figure 10–14 Component Items Section

Item	Description	UPC	Available SOH	Quantity in Pack
100000024	Wheat Cookies - Elaichi	100000235	-13	5
100000083	Wheat Cookies - Vanilla		14	8
3655	Wheat Cookies - Choco		10	4

Clicking on the **Components** section on [Item Detail](#) displays the components that exist for the pack item. The section is only available for those items which are a Pack item. All quantities are in the SUOM.

Clicking on a component item ID navigates you to the item detail for that item. You can return to the original item.

Stock Locator

Figure 10–15 Stock Locator Section

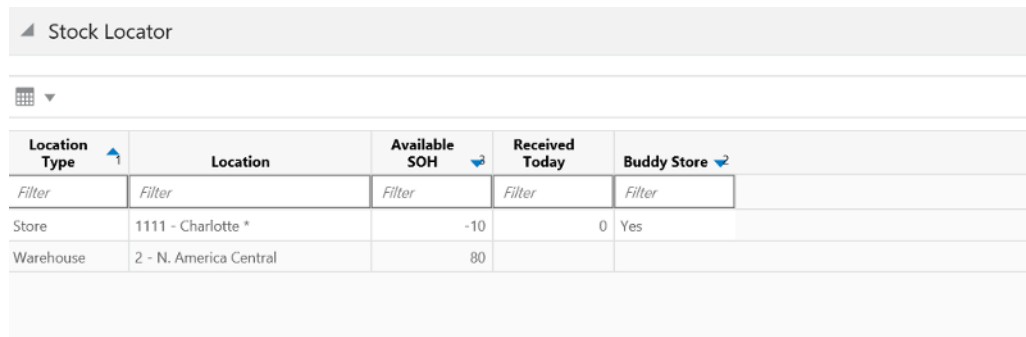

Location Type	Location	Available SOH	Received Today	Buddy Store
Filter	Filter	Filter	Filter	Filter
Store	1111 - Charlotte *	-10	0	Yes
Warehouse	2 - N. America Central	80		

The Stock Locator details are accessed by clicking on **Stock Locator** from [Item Detail](#). This section shows stock on hand for the item at other locations, which could be stores and warehouses.

Stores will only be those that are SIOCS Managed stores. If transfer zones are used, only the stores within the transfer zone and the stores in null transfer zone should appear. If no transfer zone is associated, all the stores will be listed. The stores listed must have the logged in store present in its shipping network in order to be listed in this screen.

Warehouses will only display the available SOH. Access Warehouse Inventory permission is needed to view the warehouse inventory.

The locations are ordered first by buddy stores (Yes) at the top and second by available SOH (greatest at the top).

Related Items

Figure 10–16 Related Items Section

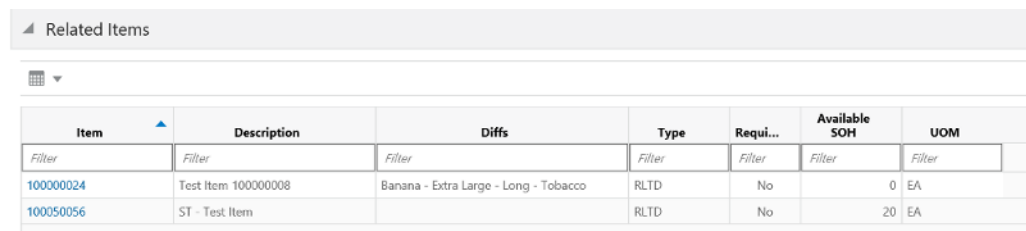

Item	Description	Diffs	Type	Requi...	Available SOH	UOM
Filter	Filter	Filter	Filter	Filter	Filter	Filter
100000024	Test Item 100000008	Banana - Extra Large - Long - Tobacco	RLTD	No	0	EA
100050056	ST - Test Item		RLTD	No	20	EA

The Related Items section is accessed by selecting the **Related Items** menu option on the [Item Detail](#) screen. The Related Items screen displays the related items for the item at your store. All quantities are in the SUOM. The related item types of cross sale, up sale, substitute, and style are listed. There is a type filter at the top of the screen

allowing you to filter by the type of related item. All items display, even if they are not ranged to the store.

Only Active related items are listed, where today's date is within the effective date and end date for the related item. If there is no effective date, the item is assumed to be active.

If you select a related item record in the list, you navigate to the [Item Detail](#) screen for that item. You are then in the details for that item. There is not a way to navigate back to the original item.

Note: The Substitute item types are used within the Customer Order Picking and Shelf Replenishment Picking dialogues when a substitute item is allowed.

UDAs

Figure 10–17 UDAs Section

UDAs	
In Store Date	06/28/18
Publisher's Notes	Handle with care
Ornamentation*	Beaded
Theme*	Tiki Time

Clicking on the **UDAs** section displays the UDA information for the item at your store. The list is ordered by UDA.

Deliveries

Figure 10–18 Deliveries Section

Deliveries						
Ordered 100		Inbound 3		Received Today		
Type	ID	External ID	Source	Expected Date	Ordered	Inbound
Allocation	198	198	2 - N. America Central	26/7/20	100	0
Transfer	8944	JK101	1776 - Attach Tag	25/10/21	0	3

The Deliveries screen is accessed by selecting **Deliveries** from [Item Detail](#). All quantities are in the SUOM.

The header contains:

Ordered: Displays the total quantity remaining on the order. (Transfers + Purchase Orders)

Inbound: Is the total shipped quantity from transfers, allocations, and POs on an ASN that have not been received yet.

Received Today: Is the total received quantity for the current date.

RFID Locations

Figure 10–19 RFID Locations Section

RFID Locations		
Zone	RFID Location	Available SOH
<i>Filter</i>	<i>Filter</i>	<i>Filter</i>
Shopfloor	RFID Location #1	10

Selecting the **RFID Locations** from the [Item Detail](#) screen displays the RFID Location wise inventory. This menu is available only if the item is RFID tag enabled item.

RFID Locations are defined in the RFID solution and uploaded into system.

The inventory positions shown here are the accumulated numbers of the tags present in the location.

Item Locations

Figure 10–20 Item Locations Section

Item Locations	
Type	Location
<i>Filter</i>	<i>Filter</i>
Shopfloor	Shelf#1
Shopfloor	Shelf#18
Shopfloor	Shelf#12
Backroom	Shelf#10★

Clicking on the **Item Locations** section on [Item Detail](#) displays the sequenced locations that exist for the item. The Item Locations section is only displayed when the system is configured for Display Sequence Fields = Yes.

The macro locations with the area are displayed. If the location is a primary location, it is indicated with a star.

Note: If an item is RFID, this information will not be displayed.

Additional Suppliers

Figure 10–21 Additional Suppliers Section

Supplier ID	Name
Filter	Filter
2400	Happy Bubbles Supplier
6200	Local Grocery Supplier #3

The Additional Suppliers section is accessed by selecting the **Additional Suppliers** menu option on the [Item Detail](#) screen. This section displays the additional suppliers for the item at your store.

Pricing Info

Figure 10–22 Pricing Info Section

Current Retail \$23.10	Selling UOM FA	Multi Unit UOM
Price Type Permanent	Multi Unit Price	
MSRP	Multi Unit Quantity	

The Pricing Info section is accessed by selecting the **Pricing Info** menu option on the [Item Detail](#) screen. This section displays the price related information for the item. Clicking on the **Pricing Events** button takes you to the screen which displays the list of Pricing Events for the item.

Depending on configuration, it can show future and historical or historical only prices.

Figure 10–23 Pricing Events Screen

Price	Price Type	Effective Date	End Date	Multi Unit Price	Multi Unit Price	Multi Unit Quantity	Multi Unit UOM	Last Update	Past/Activ...
Filter	Filter	Filter	Filter	Filter	Filter	Filter	Filter	Filter	Filter
\$23.10	Permanent	12/21/17		No				3/21/18	Active

Transaction History

Figure 10–24 Transaction History

Date	Type	Transaction ID	Item	Description	Reason	SOH	Unavailable	User
10/21/21 1:10:43 AM	DSD Receiving	420	100000059	100000059_L...	Receipt	5	0	sim_qa3

The Transaction History section can be accessed by clicking on the **Transaction History** collapsible panel. When clicked, it would display the transaction history records for the item as it is currently displayed in the Transaction History screen. The number of transaction history records displayed will be based on the system configuration **Search Date Range Default for Transaction History**. The user must have **Access Transaction History** permission for this collapsible panel to be visible.

UIN Management

- [UIN Lookup](#)
- [Item UIN List](#)
- [UIN History](#)
- [UIN Lookup Navigation](#)

UIN Lookup

The UIN Lookup dialog is used to perform a UIN inquiry from the system. This can be accessed under the Inventory Management menu option of the application. You can search the UINs based on the several criteria for the current store, other stores or all the stores.

Figure 10–25 UIN Lookup

The UIN Lookup screen allows you to give the search criteria such as Store, Item, UIN, Status, User and date range to find the UINs.

The current store is the default selection, and you can change the store or select 'All' for inquiring all the stores.

Entry of item number or UIN is required. Either input the item number and search for the UINs associated to that item or enter the UIN.

If the item number and the UIN is entered, the system checks for the UIN details corresponding to the entered item number and if found the system goes to the [UIN History](#) screen directly.

If only the UIN is entered and if the system has found only one item containing that UIN, the system goes directly to the [UIN History](#) screen.

If the system finds more than one item containing the same entered UIN, the system displays a select item popup to select the item.

If only the item number is entered and the UIN is left blank, the system checks for all the UINs associated to the entered item number.

If the system finds multiple UIN records for the given criteria, the system goes to the [Item UIN List](#).

Item UIN List

Figure 10–26 Item UIN List

Item UIN List

← Back



Item: 10000059
Item Description: Lamb Chops

UIN Type: Auto Generated SN
SOH: 13

Refresh 

Store	UIN	Status	Transaction ID	Functional Area	User	Last Update	Open
Filter	Filter	Filter	Filter	Filter	Filter	Filter	Filter
1311	101	Reserved For Shipping	2182	Create Transfer	sim_ga2	4/11/19	Yes
1311	102	Customer Order Fulfilled	1407	Customer Order	sim_admin	4/16/19	No
1311	104	Customer Order Fulfilled	1408	Customer Order	sim_admin	4/16/19	No

If the system finds more than one UIN records based on the given input on the UIN Lookup, the [Item UIN List](#) with the list of UINs is displayed.

The item information is shown on the header portion and in the list, the system displays the Store, UIN, Status of the UIN, Recent Transaction information, user, last update date and the current status whether it is in Open or Closed with a Yes/No indicators.

Open UINs should consist of UINs that are in the following statuses:

- In Stock
- In Receiving
- Reserved for Shipping
- Unavailable
- Customer Order Reserved

Closed UINs should consist of UINs that are in the following statuses:

- Sold
- Customer Order Fulfilled
- Shipped to Store
- Shipped to Warehouse
- Shipped to Finisher
- Shipped to Vendor
- Removed from Inventory
- Missing

The UIN on this screen is a link to the [UIN History](#) screen to view the history of the UIN.

UIN History

Figure 10–27 UIN History

UIN History

← Back Save ↺ Reset

Item 10000059 Serial Number 101

Item Description Status

Refresh

Store	Date	Status	Functional Area	Transaction ID	User
<i>Filter</i>	<i>Filter</i>	<i>Filter</i>	<i>Filter</i>	<i>Filter</i>	<i>Filter</i>
1311	4/17/19	Reserved For Shipping	Create Transfer	2782	sim_cpq2
1311	8/27/18	Sold	Manual	Manual	sim_admin

You can access the UIN history screen either via the [Item UIN List](#) upon selecting an UIN or by selecting the View History option on the Troubled Transactions List.

This screen displays the Item and UIN information on the header.

The list on this screen contains the Store, Date on which the status change occurred in the system, updated status on the occurrence, corresponding functional area for which the transaction occurred, transaction id and user.

You can change the status of the UIN by selecting the correct status from the Status drop down on the header and select **Save**.

UIN Lookup Navigation

Select **UIN Lookup** and provide the search criteria to go to the [Item UIN List](#) or [UIN History](#) screens.

If there are multiple records, the system displays the [Item UIN List](#) and, upon selecting the UIN link, takes you to the [UIN History](#) screen.

You can get to the [UIN History](#) screen from the Troubled Transactions List by selecting **View History**.

Supplier Lookup

The Supplier Lookup functionality in the desktop application provides the business user with the ability to view information related to a supplier.

Figure 10–28 Supplier Lookup Workflow

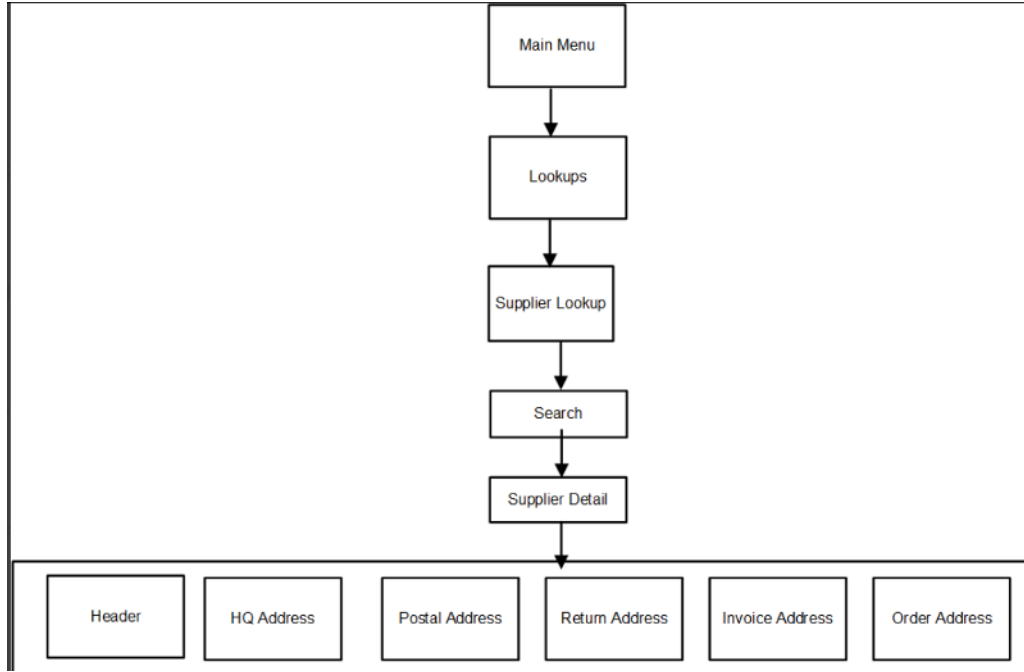

This is the screen flow for the Supplier Lookup functionality. Selecting **Supplier Lookup** from the Main Menu/Lookups directs you to the **Supplier Lookup** screen. From Supplier Lookup screen, you can search for suppliers and view different details about the supplier, via the **Supplier Detail** screen.

Figure 10–29 Supplier Lookup Screen

Supplier Lookup

Search | Supplier ID = 2400 | Search Limit = 50

Records Found: 1 | Refresh | [Grid Icon]

Supplier ID	Supplier Name	Status
<i>Filter</i>	<i>Filter</i>	<i>Filter</i>
2400	Happy Bubbles Supplier	Active

When navigating to **Supplier Lookup**, you are taken to a screen where all the active suppliers are displayed by default. You are also presented with various search criteria to lookup for a supplier. You can enter the search criteria to find the suppliers.

Figure 10–30 Supplier Lookup Search Criteria

You will get this dialogue by clicking on **Search** from the Supplier Lookup screen. This dialogue displays a few search criteria which helps you to lookup a supplier.

After applying the search criteria, the results are listed on the **Supplier Lookup** screen.

If the search results in a single supplier, the system takes you automatically to the **Supplier Detail** screen of the supplier. If more than one supplier is found, the list of suppliers is displayed in the **Supplier Lookup** screen and you can click on a supplier to view the details of the supplier.

Figure 10–31 Supplier Detail Screen

A Supplier's information is presented in the **Supplier Detail** screen as different sections.

- Header
 - The header details include details of the supplier such as ID, Name, Status, Returns allowed or not, Authorization required or not and the Delivery Discrepancy Type.
- Various Address types including Business Address, Return Address, Invoice Address and so on.

Container Lookup

The Container Lookup functionality in the desktop application provides the business user with the ability to view information related to a container. Some of the information that can be accessed from the screen includes the associated Shipment ID, ASN, Source Type/Source ID, Destination Type/Destination ID, Expected Date, Receive Date, Update Date/User, details of the items present in the container, and so on.

Figure 10–32 Container Lookup Screen

Container Lookup

Search Store = 1111 | Search Limit = 50

Records Found: 1

ID	Container ID	Status	Direction	Source Type	Source	Destination Type	Destination	Receive/Dispatch Date	SKUs
Filter	Filter	Filter	Filter	Filter	Filter	Filter	Filter	Filter	Filter
5366	00000011310...	New	Outgoing	Store	1111 Charlotte *	Store	1131 Jacksonville		0

When navigating to Container Lookup, you are taken to a screen where all the containers for the store are displayed by default. You are also presented with various search criteria to lookup for a container.

Figure 10–33 Container Lookup Search Criteria

Container Lookup Search Criteria

ID

Container ID

ASN

Status

Item

Type

* Store

* Search Limit

You will get this dialogue by clicking on **Search** from the Container Lookup screen. This dialogue displays a few search criteria which helps you to lookup for a container.

After applying the search criteria, the results are listed on the **Container Lookup** screen.

If the search results in a single container, the system takes you automatically to the **Container Detail** screen of the container. If more than one container is found, the list of containers is displayed in the **Container Lookup** screen and you can click on a ID link to view the details of it.

This dialogue allows the user to also find and view containers not specific shipped to their store.

Figure 10–34 Container Detail Screen

Item	Item Description	UOM	Received	Damaged	Expected	Variance
Filter	Filter	Filter	Filter	Filter	Filter	Filter
100000112	Test Item 100000091	Units	5	5	10	-5

A Container's information is presented in the **Container Detail** screen as header and detail sections. The header section contains the primary details of the container, and the detail section consists of the items added to the container.

- **Header Section**

The header details include details of the container such as associated Shipment ID, ASN, Source Type/Source ID, Destination Type/Destination ID, Expected Date, Receive Date, Update Date/User, Adjusted container or not, Receive on Shopfloor (Yes/No), Damage Reason, SSCC, Tracking ID and so on.

- **Detail Section**

The Detail section displays the list of items in the container and the details of the item which includes the Received/Damaged/Expected Quantity and Variance. By selecting an item and clicking on UIN icon, the user can view the list of UINs added if the item is a Serial number item. Also, the Extended attributes of the item can also be viewed by clicking on the **Extended Attributes** icon.

From the container detail screen, the user can print the tickets by selecting the Print Tickets option.

Upon selecting the print tickets button, the user is taken to the **Print Tickets** popup for the user to provide the ticketing attributes to print the tickets for the current container items.

Figure 10–35 Print Tickets

The screenshot shows a 'Print Tickets' dialog box with the following elements:

- Title: Print Tickets (with a close 'x' button)
- * Format Type: Item Ticket (dropdown menu)
- * Format: Select (dropdown menu)
- Quantity Received: (text field)
- * Printer: Select (dropdown menu)
- Print Date: 7/9/21
- Buttons: Print (blue), Cancel (grey)

When the user selects to print the tickets from the container detail screen, the system pops up this screen to provide the ticketing details.

On this screen, the user can select the ticketing attributes such as format type, what format to be applied and to which printer the tickets to be submitted to print.

Also, on this screen, the system displays the quantity field to indicate how the total quantity is derived and the print date for the user to know when it will be printed.

Upon selecting the print button, the system submits the print request to the printer service for the printing of tickets.

Finisher Lookup

The Finisher Lookup functionality in the desktop application provides the business user with the ability to view information related to a finisher. The user can access the Finisher Lookup screen through Main Menu - Lookups - Finisher Lookup. The user must have proper security permission (**Access Finisher Lookup**) for this option to exist.

Figure 10–36 Finisher Lookup Screen

The screenshot shows the 'Finisher Lookup' screen with the following components:

- Search bar: Search | Search Limit = 40
- Records Found: 3 | Refresh | Calendar icon
- Table with columns: Finisher ID, Finisher Name, Status

Finisher ID	Finisher Name	Status
<i>Filter</i>	<i>Filter</i>	<i>Filter</i>
1776	Attach Tag	Active
1777	Bib Print	Active
1779	Wash and Pack	Active

When the user first enters the screen, active finishers will be displayed by default. After performing a search, the list of finishers per the search criteria entered will be displayed in this screen. User can click on a finisher, and it will take the user to the detail screen for the selected finisher.

Figure 10-37 Finisher Lookup Search Criteria

Finisher Lookup Search Criteria

Finisher ID: 1776

Finisher Name: |

Item:

Include Inactive: No

* Search Limit: 40

Search, Reset, Cancel

The user can access the Finisher Lookup Filter dialogue by clicking on **Search** button from the Finisher Lookup screen. This dialogue enables the user to enter various search criteria to lookup for the finisher(s) that he needs. After performing the search, the list of finishers per the search criteria entered will be displayed in the Finisher Lookup screen. If one result is found, the user is taken to the **Finisher Detail** for that finisher. The result returned should adhere to MSOB rules.

Figure 10-38 Finisher Detail Screen

Finisher Detail

Back

Finisher ID: 1776	Language: English	Telephone: 555-555-1776
Finisher Name: Attach Tag	Payment Terms: 1	Fax: 555-555-1876
Status: Active	Vat Region:	Telex:
Principal Country: US	Transfer Entity: 7346849553	Email: manager@attachtag.com
Currency: USD	Contact Person: Attach Tag Manager	

- Business Address
- Postal Address
- Return Address
- Order Address
- Invoice Address

The user will be taken to the Finisher Detail screen upon selecting a finisher from the search results on the Finisher Lookup screen. The Finisher Detail screen will consist of primary details of the finisher in the header and other details such as Addresses as sections below the header. A section will exist for every address type for the finisher being looked up. Expanding a section will display respective details right below. Types of addresses and the number of types of addresses may vary per finisher. Everything within the screen is view only.

Item Scan Number Lookup

Item Scan Number Lookup dialog in the desktop application helps the retailers particularly the telecom retailers to maintain the multiple identification numbers of an equipment or item.

Many mobile phone manufacturers produce phones that supports more than one SIM slot, and one unit is associated with multiple unique identification numbers. In the Retail world, this leads to allow the users at different point solution to scan any of these unique identification numbers on the unit to identify the product.

The system will support to identify the item or equipment by scanning any of the unique identification numbers associated to the product and tracking of the status of the unit is done by the primary identification number that is present in the system.

The system also has the capability to capture any additional information or attributes of the unit.

The creation and update of ISN data can be done via web services or using the desktop application UI.

ISN Lookup can be accessed from the Lookups menu on the desktop application. When accessing the ISN Lookup screen, the system displays the search criteria screen initially to do provide the criteria to search.

Figure 10–39 Item Scan Number Lookup Screen

Item	UIN	ISN	ISN Type	Attribute Name	Attribute Value
100000059		231538	ISN Type 2		
100000059		555	ISN Type 2		

The ISN Lookup screen allows the user to search the Item Scan Number data for an item or do an inquiry for the known ISN. On this screen, the user can only view or manage ISN data for one item at a time. This screen allows the user to create new or delete the ISN data of an item.

On this screen the user can also create a new ISN by selecting the **Create** option.

The system displays the following fields:

Item: Item Id of the ISN data user looking for. The user can select the link on the item to go to the Item Detail screen.

UIN: This holds the Unique Identification number/Serial number of the item. The system maintains the inventory status of the unit based on the primary UIN only. All other unique identification numbers are in reference to the UIN.

ISN: This field holds the other reference unique identification number that is, ISN.

ISN Type: This field displays the type of ISN.

Attribute Name and Attribute Value: -These are value pair where the value is corresponding to the name. Attribute details are captured from the external system and read only on this dialog.

Figure 10–40 Item Scan Number Lookup Search Criteria

The screenshot shows a dialog box titled "Item Scan Number Lookup Search Criteria". It has a close button (X) in the top right corner. The dialog contains the following fields and controls:

- An input field labeled "Item" with a vertical cursor.
- An input field labeled "UIN".
- An input field labeled "ISN".
- A field labeled "* Search Limit" with the value "500" and up/down arrow buttons.
- Three buttons at the bottom: "Search" (with a magnifying glass icon), "Reset", and "Cancel".

This search criteria screen is loaded automatically when the Item Scan Number Lookup is accessed. It can also be accessed by clicking the Search button on the Lookup screen. The user can filter on various search criteria. After applying the criteria, the user will be returned to the ISN Lookup screen with the ISN data.

The user must enter at least one valid search criteria to continue the search.

If the system finds more than one item based on the ISN search, it prompts the user to refine the search by entering the actual item number to search for.

Figure 10–41 Create Item Scan Number

The screenshot shows a dialog box titled "Create Item Scan Number" with a close button (X) in the top right corner. The dialog contains the following fields and controls:

- A dropdown menu labeled "* ISN Type" with the text "Select" and a downward arrow.
- An input field labeled "* Item" with the value "123".
- An input field labeled "UIN".
- An input field labeled "* ISN".
- Two buttons at the bottom: "Create" and "Cancel".

The user can create new ISN for the inquired item by selecting the **Create** button on the ISN Lookup screen.

If the user has provided the item in the search, the item number is defaulted otherwise it allows the user to enter the item.

On this screen, the user can select the ISN type, enter the UIN and the ISN to create a new ISN record for the item.

The ISN Type drop-down displays the list of ISN Types available in the system. The list is populated from the ISN Type screen where the user creates/manages various ISN types. The system has three pre-defined ISN types 1 to 3 for the retailer to fit to represent the unique identifiers based on the industry. For example, the telecom retailer could use the ISN type 1 and ISN type 2 for any unique identification number of the mobile devices. The user can also create more ISN Types through the ISN Type screen.

The system saves the record upon selecting the **Create** button.

This chapter describes the sales integration. The following topics are covered:

- Overview: Description of how EICS, Point of Sale (POS) systems, and Sales Audit systems are integrated. Also, how the sales wastages process is handled in EICS.
- Processing: Information on how the sales integration is processed.

Overview

EICS integrates with POS systems and Sales Audit systems to ensure that the inventory positions are accurate. This is especially important for Commerce Anywhere where accurate up-to-date inventory positions are required to reduce customer disappointment when trying to locate items that appear in inventory or delays in filling customer orders.

POS is the primary source of sales, returns, void, and some customer order transaction information to EICS. ReSA sends only modified or new POS transaction records to EICS.

POS systems integrated with EICS can do the transaction updates using a web service. Sales Audit systems can only communicate through a file import process.

Figure 11-1 POS and Sales Audit Integration

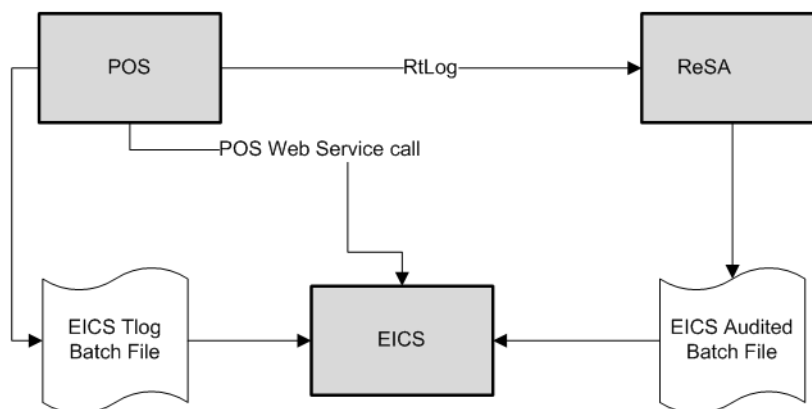

Following are the features of the integration:

- Real-time web service and batch integration

- POS transaction and audited sales data integration
- Automatic disposition processing for returns
- Wastage processing for grocery

POS and Sales Audit Process Flow

The following figure shows how a POS, such as Xstore Point of Service, Retail Sales Audit, and EICS are integrated. A POS generates an RTLog containing all the POS transactions and sends it to the Oracle Retail Sales Audit system (ReSA). ReSA sends the audited modified or new transactions to EICS. ReSA also sends the POS transaction upload file to merchandising to update inventory. Xstore is interfaced with EICS to update the inventory transactions near real time through a web service. Other POS systems can also use a batch to import transactions directly into EICS. EICS also processes the POS transactions that have been changed or entered into the sales audit system and updates the inventory based on the delta.

Figure 11–2 POS and Sales Audit Process Flow

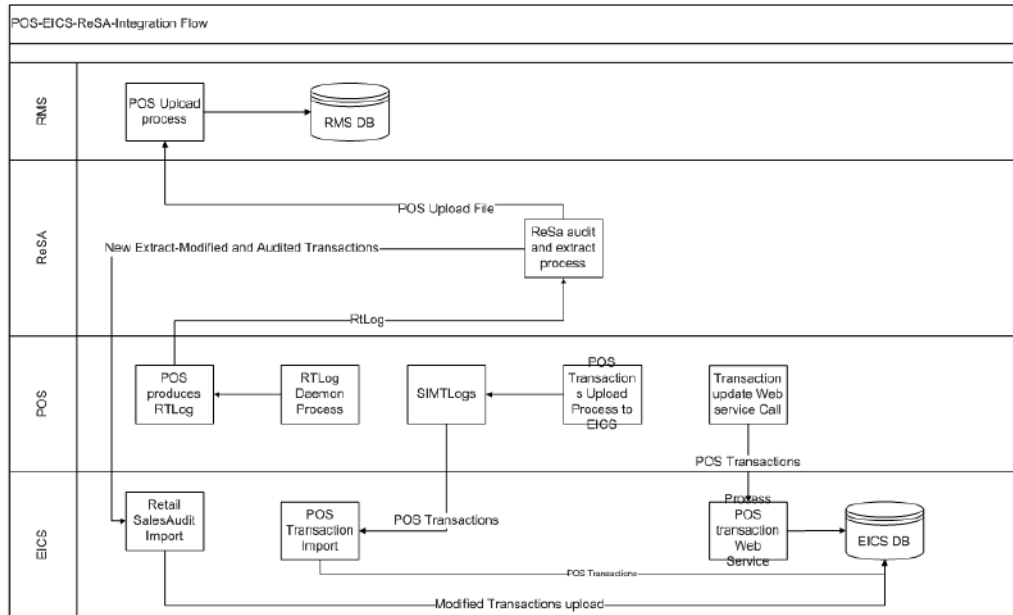

There are two reasons for POS to send sales data directly to EICS and not to the auditing system:

- Real-time inventory updates to support Commerce Anywhere are critical. A possible round trip from POS to ReSA to EICS takes too long in the dynamic inventory environment of today.
- POS is the application that owns sales data and ReSA owns audited data. Architecturally, it makes more sense to have data supplied by the owner of that data. POS sends sales data and ReSA sends audit changes to EICS.

Sales and Return Processing

As part of the sales processing, EICS updates the inventory depending on the nature of the transaction. The following are the supported transaction types for the sales processing: Sale, Return, and Post Void of these transactions. The audit system should not modify the post void transactions. A change to a void is not supported by EICS.

Customer Order Processing

In EICS, the Retail Sales Audit import process, POS Transaction import process, and POS Transaction web service process support the following types of customer orders.

- For layaway and on hold, EICS supports create, update, cancel, and pickup/delivery. For external web order type, only pickup transactions performed in POS are sent to EICS.
- Pickup transactions, both in-store and external, cannot be voided or modified by sales audit and if these transactions are modified by sales audit system, EICS just drops the transaction and does not process.

Note: Current Xstore functionality is limited to only layaway and on hold orders. Web order processing is not supported in this release.

Item Disposition

POS can move inventory for return and post void transactions to 'unavailable' or 'out of stock'. This is especially useful in some environments where items returned must be disposed of or have to be reprocessed.

The external sale transaction coming into EICS may include a reason code that is mapped to the inventory adjustment reason codes in EICS. Point of Service maps the EICS reason codes, and the reason codes are sent to EICS in the web service or file extract for the return and post void transactions. EICS first processes the return or post void and updates stock on hand. Next, if the reason code exists, EICS checks this reason code with the one in inventory adjustment reason code table. If a valid match is found, EICS generates an inventory adjustment to notify external systems and execute the disposition instructions tied to the inventory adjustment reason code. Based on the disposition mapped to the reason code, EICS moves the returned inventory to not for sale or out of stock and updates the history trail. If sub-buckets are used, they are also updated if the movement is to not for sale.

If the reason code received is invalid/not present/mapped incorrectly, the system writes an error log and continues to process the stock on hand part of the transaction.

Wastage

Wastage is the process through which inventory is lost over time (for example, bananas turning black) or when processing the item for sale (trimming off fat for sale of a ham).

In order to maintain more accurate inventory values, EICS uses two methods to control wastage:

- The first method provides users in stores the ability to create wastage product groups.
- The second method is controlled through the sales process. The sales transaction information can contain a wastage percentage for variable unit of measure items. If

that is not present on the sales transaction coming in, EICS looks up the wastage percentage and uses that for inventory reduction beyond the sale.

Each of these methods has a specific use and can be used in combination with each other. In the sales method, items such as cheese or ham, are only reduced when the outside layers are cut off to sell the item.

Drop Ship

When the sales records indicate the record is a drop ship, EICS does not perform any processing of this record since the drop ship process implies the inventory is shipped from a third-party location and not from the store.

Item Types

EICS only processes SKU or UPC numbers. GS1 databars, or any other smart barcodes such as VPLUs or Type-E barcodes, should have been extracted to their SKU or UPC number by the POS system.

In addition, EICS only updates inventory for stock holding items. Concession, non-inventory items, and consignment items do not update any stock on hand and are not processed.

Items with the store pack inventory indicator turned off are automatically broken down and the inventory of the component items is updated.

RFID Support

The POS Transactions can contain the RFID Tags and the system while processing the transactions updates the status of the tag.

SIOCS maintains the tag status as below.

- Present - This means the tag is physically present in the store. An item tag can be in this status when a new item is created/added or when the existing tag that was in 'Not Present' is moved to 'Present' because of some transaction event.
- Not Present -This means the tag is not present in the store. The system will move it to this status when there are out bound inventory transactions.

The transaction processing supports the RFID tag updates as below.

Table 11-1 Supported RFID Tag Updates

SI.Number	Transaction Type	Update	Remarks
1	Sale	Not Present	Transaction will be processed, and the Stock on Hand will be decreased and RFID tag will be updated to Not Present.
2	Void of Sale	System will not update anything	Transaction will be processed for Stock on hand update, but RFID tag updates will not happen via sales processing. The RFID tag status update is expected via RFID solution.
3	Return	System will not update anything	Transaction will be processed for Stock on hand update, but RFID tag updates will not happen via sales processing. The RFID tag status update is expected via RFID solution.

Table 11-1 (Cont.) Supported RFID Tag Updates

SI.Number	Transaction Type	Update	Remarks
4	Void of Return	Not Present	Transaction will be processed, and the Stock on Hand will be decreased and RFID tag will be updated to Not Present.
5	New Order	System will not update anything	No Inventory movement.
6	Order Cancel	System will not update anything	No Inventory movement.
7	Order Fulfill	Not Present	Transaction will be processed, and the Stock on Hand will be decreased and RFID tag will be updated to Not Present.

RFID tag integration for sales should only be enabled if an RFID solution is also integrated into SIOCS, be it manual through stock counts or automatic with scanners.

The external RFID solution will manage which tags are present or not. The reason why increase of inventory does not update the tag status is that time delays can happen between scanning the tags and recognizing the return of the item. Since the return of an item may generate a new RFID tag, or locate the tag again, the RFID tag update will happen through the external RFID system. In reverse, a removal of a tag is something EICS can handle as the only response from the external system would be the removal of the same tag resulting in a no-change scenario.

EICS maintains the history of the RFID tags which can be viewed in the reports.

Additional Impacts

Outside of updating inventory buckets directly, sales data also has impacts on three other areas. For more information, see their relevant sections:

- In-Store replenishment
- Stock Counts - late sales
- History Trail

Integration Options

POS to EICS: Option A (Web Service)

POS may integrate its transactions to EICS using a web-service: POSTransaction. The published WSDL has only one operation: ProcessPOSTransactions. ProcessPOSTransactions processes point-of-sale transactions through an asynchronous process.

This service only allows 5,000 overall PosTrnItms, though they may be distributed between any number of actual PosTrn transactions. Exceeding this limit causes a web service fault to occur. These transactions may belong to multiple store IDs. This operation validates the input, parses the payload information, creates a POSTransaction object, and stages these records to be processed later.

POS to EICS: Option B (Flat File Upload)

POS may integrate its transactions to EICS using a bulk-load flat file. The POS Transaction Import Batch loads all the data within the file, saving the records in the POS_TRANSACTION table and then grouping the records into requests to write into the STAGED_MESSAGE table to be processed shortly.

ReSA - EICS Integration

As previously described, an actual sales transaction extract is given by POS directly to EICS. All the transactions in a file must belong to a single store. After parsing the records from the file, the process stages them into the POS_TRANSACTION and MPS_STAGED_MESSAGE tables as previously described. Following are the key technical Java classes:

- RetailSaleAuditImportHandler which prepares a list of POSTransaction from the import file.
- RetailSaleAuditDataParser, which contains the actual file parsing logic.
- StageResaTransactionCommand, which contains the actual staging logic.