

Oracle® Database Appliance

X6-2-HA Deployment and User's Guide



Release 12.2.1.3.0 for Linux x86-64

E93449-01

April 2018

The Oracle logo, consisting of a solid red square with the word "ORACLE" in white, uppercase, sans-serif font centered within it.

ORACLE®

Oracle Database Appliance X6-2-HA Deployment and User's Guide, Release 12.2.1.3.0 for Linux x86-64
E93449-01

Copyright © 2016, 2018, Oracle and/or its affiliates. All rights reserved.

Primary Author: Laura Hartman

This software and related documentation are provided under a license agreement containing restrictions on use and disclosure and are protected by intellectual property laws. Except as expressly permitted in your license agreement or allowed by law, you may not use, copy, reproduce, translate, broadcast, modify, license, transmit, distribute, exhibit, perform, publish, or display any part, in any form, or by any means. Reverse engineering, disassembly, or decompilation of this software, unless required by law for interoperability, is prohibited.

The information contained herein is subject to change without notice and is not warranted to be error-free. If you find any errors, please report them to us in writing.

If this is software or related documentation that is delivered to the U.S. Government or anyone licensing it on behalf of the U.S. Government, then the following notice is applicable:

U.S. GOVERNMENT END USERS: Oracle programs, including any operating system, integrated software, any programs installed on the hardware, and/or documentation, delivered to U.S. Government end users are "commercial computer software" pursuant to the applicable Federal Acquisition Regulation and agency-specific supplemental regulations. As such, use, duplication, disclosure, modification, and adaptation of the programs, including any operating system, integrated software, any programs installed on the hardware, and/or documentation, shall be subject to license terms and license restrictions applicable to the programs. No other rights are granted to the U.S. Government.

This software or hardware is developed for general use in a variety of information management applications. It is not developed or intended for use in any inherently dangerous applications, including applications that may create a risk of personal injury. If you use this software or hardware in dangerous applications, then you shall be responsible to take all appropriate fail-safe, backup, redundancy, and other measures to ensure its safe use. Oracle Corporation and its affiliates disclaim any liability for any damages caused by use of this software or hardware in dangerous applications.

Oracle and Java are registered trademarks of Oracle and/or its affiliates. Other names may be trademarks of their respective owners.

Intel and Intel Xeon are trademarks or registered trademarks of Intel Corporation. All SPARC trademarks are used under license and are trademarks or registered trademarks of SPARC International, Inc. AMD, Opteron, the AMD logo, and the AMD Opteron logo are trademarks or registered trademarks of Advanced Micro Devices. UNIX is a registered trademark of The Open Group.

This software or hardware and documentation may provide access to or information about content, products, and services from third parties. Oracle Corporation and its affiliates are not responsible for and expressly disclaim all warranties of any kind with respect to third-party content, products, and services unless otherwise set forth in an applicable agreement between you and Oracle. Oracle Corporation and its affiliates will not be responsible for any loss, costs, or damages incurred due to your access to or use of third-party content, products, or services, except as set forth in an applicable agreement between you and Oracle.

Contents

Preface

Audience	xvii
Documentation Accessibility	xvii
Related Documents	xviii
Conventions	xix

1 About Oracle Database Appliance X6-2-HA

1.1 Oracle Database Appliance Software	1-1
1.2 Overview of Oracle Database Appliance Deployment	1-2

2 Preparing for Oracle Database Appliance Installation and Deployment

2.1 Registering Your Support Identifier on My Oracle Support	2-1
2.2 Planning Oracle Database Appliance Configuration Options	2-1
2.2.1 Selecting Oracle Database Appliance Bare Metal Options	2-2
2.2.2 Selecting Oracle Database Appliance Virtualized Platform Options	2-2
2.2.3 Selecting Database Configuration Options	2-3
2.2.3.1 Selecting Database Deployment Options for Oracle Database Appliance	2-4
2.2.3.2 Selecting Database Templates for Oracle Database Appliance	2-5
2.2.3.3 Calculating Required Cores	2-6
2.3 Gathering System Requirement Information	2-6
2.3.1 List of Information You Need Before Deployment	2-7
2.3.2 Checklist for System Details	2-8
2.3.3 Checklist for Custom Node Network Address Configuration	2-10
2.4 Creating an Oracle Appliance Manager Deployment Plan	2-11
2.4.1 About the Standalone Oracle Database Appliance Configurator	2-12
2.4.2 Running the Standalone Oracle Database Appliance Configurator	2-12

3 **Readying Oracle Database Appliance for Deployment**

3.1	About Interconnect Cabling	3-1
3.2	Attaching Supplied Cables for Oracle Database Appliance	3-2
3.2.1	Attaching Cables for Oracle Database Appliance X6-2-HA	3-2
3.2.2	Cabling Oracle Database Appliance to Connect to Fiber Public Networks (Optional)	3-3
3.3	Attaching a Storage Expansion Shelf to Oracle Database Appliance	3-4
3.3.1	About Attaching and Cabling Storage Shelves	3-5
3.3.2	Installing and Cabling a Storage Expansion Shelf	3-7
3.4	Attaching Peripheral Devices	3-7
3.5	First Startup of Oracle Database Appliance	3-8
3.5.1	Attaching Power Cords and Initializing Components	3-8
3.5.2	Powering On Oracle Database Appliance the First Time	3-9
3.6	Configuring Oracle Integrated Lights Out Manager	3-10
3.7	Configuring an Initial Network Connection	3-11

4 **Deploying Oracle Software on Oracle Database Appliance**

4.1	About Deploying Oracle Database Appliance Software Using OAKCLI	4-1
4.2	Deploying Bare Metal Platforms on Oracle Database Appliance	4-2
4.3	Deploying Virtualized Platform Software	4-7
4.3.1	About Deploying an Oracle Database Appliance Virtualized Platform	4-8
4.3.2	Determining if the System is Configured with a Virtual Machine	4-10
4.3.3	Downloading Images for a Virtualized Platform	4-10
4.3.4	Installing a Virtualized OS ISO Image	4-11
4.3.5	Installing the Virtualized Platform Template	4-14

5 **Oracle Database Appliance Postinstallation Tasks**

5.1	Changing the Oracle Installation Owner Passwords	5-1
5.2	Changing the IPMI User Name and Password	5-1
5.3	Configuring Oracle Auto Service Request	5-2
5.4	Shutdown the VNC Server	5-3

6 **Updating Oracle Database Appliance Software**

6.1	About the Oracle Database Appliance Patch Bundle	6-1
6.2	About Installing an Oracle Database Appliance Patch Bundle	6-3
6.3	Installing the Oracle Database Appliance Patch Bundle	6-6
6.3.1	Preparing to Install Oracle Database Appliance Patch Set Bundles	6-7

6.3.2	Step 1: Download the Oracle Database Appliance Patch Bundle from My Oracle Support	6-8
6.3.3	Step 2: Copy and Unpack the Patch Bundle	6-9
6.3.4	Step 3: Validate Readiness and Verify Components that Require Patching	6-10
6.3.5	Step 4: Patch the Server	6-12
6.3.6	Step 5: Patch the Shared Storage (Optional)	6-14
6.3.7	Step 6: Patch Oracle Database	6-14
6.3.8	Step 7: Validate the Patch Update	6-15
6.4	Performing a Bare Metal Restore	6-16
6.4.1	About Performing a Bare Metal Restore	6-16
6.4.2	Downloading an ISO Image for Bare Metal Restore	6-17
6.4.3	Re-imaging Oracle Database Appliance	6-17

7 Managing Oracle Database on Oracle Database Appliance

7.1	About the Oracle Database Appliance OAKCLI Utility	7-1
7.2	Oracle Database Features and Oracle Database Appliance	7-2
7.2.1	Data Migration and Management and Oracle Database Appliance	7-2
7.2.2	Oracle Clusterware and Oracle Database Appliance	7-3
7.2.3	Oracle RAC One Node and Oracle Database Appliance	7-3
7.2.4	Oracle Real Application Clusters and Oracle Database Appliance	7-3
7.2.5	Administrative Groups and Users on Oracle Database Appliance	7-4
7.3	Creating and Converting Databases with OAKCLI	7-5
7.3.1	About Creating Databases with OAKCLI Commands	7-5
7.3.2	Creating, Using, and Removing Database Configuration Files with OAKCLI	7-6
7.3.3	Creating Snapshot Databases With OAKCLI	7-7
7.3.4	About Converting Single-Instance Databases to Oracle RAC or Oracle RAC One Node	7-8
7.4	About Managing Multiple Databases on Oracle Database Appliance	7-8
7.4.1	Downloading an End-User RDBMS Clone File	7-9
7.5	About Managing Multiple Database Instances Using Instance Caging	7-10
7.6	How to Upgrade and Update the Oracle Database on Oracle Database Appliance	7-11
7.6.1	About Oracle Database Upgrades and Updates on Oracle Database Appliance	7-12
7.6.2	Updating to Oracle Database 12.1.0.2.161018 from Previous Oracle Database 12.1.0.2.x Releases	7-12
7.6.3	Upgrading to Oracle Database 12.1.x from Oracle Database 11.2.0.4.x Releases	7-13

7.6.4	Upgrading to Oracle Database 11.2.0.4.161018 from Oracle Database 11.2.0.4.x Releases	7-16
-------	---	------

8 Managing Storage

8.1	About Managing Storage	8-1
8.2	Preparing for a Storage Upgrade	8-2
8.3	Adding the 10-Pack of SSDs	8-4
8.4	Adding the Storage Expansion Shelf	8-6

9 Managing an Oracle Database Appliance Virtualized Platform

9.1	About Oracle Database Appliance Virtualized Platform	9-2
9.2	Oracle Database Appliance Virtualized Platform Architecture	9-3
9.2.1	About Oracle Database Appliance Virtualized Platform Architecture	9-3
9.2.2	About Virtual Machines and Oracle Database Appliance Virtualized Platforms	9-4
9.3	How to Create and Manage Shared Repositories	9-7
9.3.1	Creating a Shared Repository	9-7
9.3.2	Showing the Status of Shared Repositories	9-8
9.3.3	Starting a Shared Repository	9-8
9.3.4	Stopping a Shared Repository	9-9
9.3.5	Deleting a Shared Repository	9-9
9.3.6	Increasing the Size of a Shared Repository	9-10
9.4	How to Manage Virtual Disks in Shared Repositories	9-10
9.4.1	Creating a Virtual Disk for Use in a Shared Repository	9-10
9.4.2	Viewing Information About Virtual Disks	9-11
9.4.3	Cloning Virtual Disks	9-11
9.4.4	Attaching a Virtual Disk to a Virtual Machine	9-12
9.4.5	Deleting a Virtual Disk	9-12
9.5	How to Manage Virtual Machine Templates	9-13
9.5.1	About Managing Virtual Machine Templates	9-13
9.5.2	Listing Virtual Machine Templates	9-14
9.5.3	Importing Virtual Machine Templates	9-15
9.5.4	Configuring a Virtual Machine Template	9-16
9.5.5	Showing Configured Values for a Virtual Machine Template	9-17
9.5.6	Modifying a Virtual Machine Template Configuration	9-17
9.5.7	Removing a Virtual Machine Template	9-18
9.6	How to Create Clones and Snap Clones of a Template	9-18
9.6.1	About Creating Clones and Snap Clones of a Template	9-18
9.6.2	Cloning a Template With OAKCLI	9-19
9.6.3	Creating a Snap Clone from a Template With OAKCLI	9-19

9.6.4	Creating a Snap Clone of an Existing Virtual Machine With OAKCLI	9-20
9.7	How to Manage Virtual Machines on Oracle Database Appliance Virtualized Platform	9-20
9.7.1	About Managing Virtual Machines on Oracle Database Appliance Virtualized Platform	9-21
9.7.2	Listing the Virtual Machines in Your Repositories	9-22
9.7.3	Creating a Virtual Machine	9-23
9.7.4	Configuring a Virtual Machine	9-23
9.7.5	Starting and Stopping a Virtual Machine	9-25
9.7.6	Externally Configuring a Virtual Machine	9-25
9.7.7	Opening a Virtual Machine Console for a Virtual Machine	9-25
9.7.8	Creating an Image for a New Virtual Machine	9-26
9.7.9	Setting Up a Virtual Machine for Access from eth0 Using an IP Address	9-26
9.7.10	Adding or Removing a Virtual Disk to or from a Virtual Machine	9-26
9.7.11	Removing a Virtual Machine from a Shared Repository	9-27
9.7.12	Performing a Live Migration for an Oracle Database Appliance Virtual Machine	9-27
9.8	How to Create Driver Domain Virtual Machines	9-28
9.8.1	About Driver Domain Virtual Machines	9-28
9.8.2	Creating a Driver Domain Virtual Machine from a Template	9-29
9.8.3	Converting a Virtual Machine to a Driver Domain Virtual Machine	9-30
9.8.4	Converting a Root Disk to a Driver Domain Disk	9-31
9.9	How to Manage High Availability on Oracle Database Appliance Virtualized Platform	9-38
9.10	How to Manage CPU Pools on Oracle Database Appliance Virtualized Platform	9-39
9.10.1	About Managing CPU Pools for Resource Allocation	9-39
9.10.2	About Over-Subscribed CPU Pools	9-40
9.10.3	Creating a New CPU Pool on Oracle Database Appliance Virtualized Platform Nodes	9-41
9.10.4	Showing the CPU Pools Configured on Oracle Database Appliance Virtualized Platform Nodes	9-41
9.10.5	Changing the Number of CPUs Assigned to a CPU Pool on Oracle Database Appliance Virtualized Platform Nodes	9-41
9.10.6	Assigning a Virtual Machine to a CPU Pool on Oracle Database Appliance Virtualized Platform	9-42
9.11	About Network Infrastructure and Virtual Local Area Networks on Oracle Database Appliance Virtualized Platform	9-42
9.12	Managing Virtual Local Area Networks on User Domains and on ODA_BASE	9-44
9.13	How to Resize ODA_BASE	9-47
9.13.1	About Resizing ODA_BASE	9-47
9.13.2	Changing the ODA_BASE Core Count	9-47

10 Oracle Appliance Manager Command Line Interface

10.1	About the Oracle Appliance Manager Command-line Interface (OAKCLI)	10-3
10.2	Managing OAKCLI Privileges and Security with SUDO	10-4
10.3	oakcli add disk -local	10-6
10.4	oakcli apply	10-7
10.5	oakcli clone commands	10-8
10.5.1	oakcli clone vdisk	10-8
10.5.2	oakcli clone vm	10-9
10.6	oakcli configure commands	10-11
10.6.1	oakcli configure additionalnet	10-12
10.6.2	oakcli configure asr	10-12
10.6.3	oakcli configure cpupool	10-13
10.6.4	oakcli configure firstnet	10-14
10.6.5	oakcli configure ib2fiber	10-14
10.6.6	oakcli configure network	10-15
10.6.7	oakcli configure oda_base	10-15
10.6.8	oakcli configure repo	10-16
10.6.9	oakcli configure vm	10-17
10.6.10	oakcli configure vmtemplate	10-19
10.7	oakcli copy	10-21
10.8	oakcli create commands	10-21
10.8.1	oakcli create cpupool	10-22
10.8.2	oakcli create database	10-23
10.8.3	oakcli create dbhome	10-26
10.8.4	oakcli create dbstorage	10-27
10.8.5	oakcli create db_config_params	10-28
10.8.6	oakcli create repo	10-29
10.8.7	oakcli create snapshotdb	10-30
10.8.8	oakcli create vdisk	10-30
10.8.9	oakcli create vlan	10-31
10.9	oakcli delete commands	10-32
10.9.1	oakcli delete cpupool	10-33
10.9.2	oakcli delete database	10-33
10.9.3	oakcli delete db_config_params	10-33
10.9.4	oakcli delete dbhome	10-34
10.9.5	oakcli delete dbstorage	10-34
10.9.6	oakcli delete repo	10-35
10.9.7	oakcli delete vdisk	10-35
10.9.8	oakcli delete vlan	10-36
10.9.9	oakcli delete vm	10-36

10.9.10	oakcli delete vmtemplate	10-36
10.10	oakcli deploy	10-37
10.11	oakcli describe-cpucore	10-38
10.12	oakcli expand storage	10-39
10.13	oakcli diskwritecache	10-40
10.14	oakcli import vmtemplate	10-40
10.15	oakcli locate disk	10-42
10.16	oakcli manage diagcollect	10-42
10.17	oakcli migrate vm	10-43
10.18	oakcli modify commands	10-44
10.18.1	oakcli modify database	10-44
10.18.2	oakcli modify vm	10-45
10.18.3	oakcli modify vmtemplate	10-46
10.19	oakcli orachk	10-46
10.20	oakcli reconfigure osparams	10-48
10.21	oakcli resize dbstorage	10-49
10.22	oakcli restart oda_base	10-49
10.23	oakcli show commands	10-50
10.23.1	oakcli show asr	10-53
10.23.2	oakcli show cooling	10-53
10.23.3	oakcli show controller	10-53
10.23.4	oakcli show core_config_key	10-54
10.23.5	oakcli show cpupool	10-54
10.23.6	oakcli show databases	10-55
10.23.7	oakcli show db_config_params	10-56
10.23.8	oakcli show dbhomes	10-56
10.23.9	oakcli show dbstorage	10-57
10.23.10	oakcli show disk	10-58
10.23.11	oakcli show diskgroup	10-59
10.23.12	oakcli show enclosure	10-59
10.23.13	oakcli show env_hw	10-60
10.23.14	oakcli show expander	10-60
10.23.15	oakcli show ib	10-60
10.23.16	oakcli show ismaster	10-61
10.23.17	oakcli show fs	10-61
10.23.18	oakcli show iraid	10-61
10.23.19	oakcli show memory	10-62
10.23.20	oakcli show network	10-62
10.23.21	oakcli show power	10-62
10.23.22	oakcli show processor	10-63
10.23.23	oakcli show raidsyncstatus	10-63

10.23.24	oakcli show repo	10-63
10.23.25	oakcli show server	10-64
10.23.26	oakcli show storage	10-65
10.23.27	oakcli show validation storage	10-65
10.23.28	oakcli show validation storage errors	10-65
10.23.29	oakcli show validation storage failures	10-66
10.23.30	oakcli show vdisk	10-66
10.23.31	oakcli show version	10-67
10.23.32	oakcli show vlan	10-68
10.23.33	oakcli show vm	10-69
10.23.34	oakcli show vmconsole	10-70
10.23.35	oakcli show vmtemplate	10-70
10.24	oakcli start commands	10-71
10.24.1	oakcli start oda_base	10-71
10.24.2	oakcli start repo	10-72
10.24.3	oakcli start vm	10-72
10.25	oakcli stop command	10-73
10.26	oakcli stordiag	10-74
10.27	oakcli test asr	10-75
10.28	oakcli unpack	10-75
10.29	oakcli update	10-75
10.30	oakcli update-cpucore	10-77
10.31	oakcli upgrade	10-78
10.32	oakcli validate	10-79

11 Validating and Troubleshooting Oracle Database Appliance

11.1	Oracle Database Appliance Diagnostics and Validation	11-1
11.1.1	Oracle Database Appliance Validation Command Overview	11-2
11.1.2	Examples of OAKCLI Validate Command Checks	11-3
11.2	Oracle Database Appliance Configuration Error Messages	11-5
11.3	Preparing Log Files for Oracle Support Services	11-7
11.4	Additional Troubleshooting Tools and Commands	11-7
11.4.1	Oracle Appliance Manager Tools for Configuration Auditing and Disk Diagnosis	11-8
11.4.2	Trace File Analyzer Collector	11-8
11.5	Oracle Database Appliance Hardware Monitoring Tool	11-9

A Oracle Database Appliance Software Configuration Defaults

A.1	Directory Paths for Oracle Database Appliance	A-1
A.2	Oracle Groups and Users Configuration for Oracle Database Appliance	A-2

A.3	System Configuration for Oracle Database Appliance	A-2
A.4	Tuning IOps Values for Improved Performance with Expanded Memory	A-3
A.5	Changing the Password	A-5

B Storage on Oracle Database Appliance

B.1	About Oracle Database Appliance Storage	B-1
B.1.1	Oracle ACFS Mount Points and Storage Space	B-2
B.1.2	Displaying Mounted Disk Details	B-3
B.2	Determining Usable Storage for Oracle Database Appliance X6-2-HA	B-4
B.3	Oracle ACFS Space Management	B-6

C Database Templates for Oracle Database Appliance

C.1	About Database Templates for Oracle Database Appliance	C-1
C.2	Types of Database Templates for Oracle Database Appliance X6-2-HA	C-3

Index

List of Examples

9-1	Example of Showing the Status of All Shared Repositories	9-8
9-2	Example of Showing the Status of a Selected Shared Repository	9-8
9-3	Example of Starting a Shared Repository	9-9
9-4	Example of Stopping a Shared Repository	9-9
9-5	Example of Deleting a Shared Repository	9-9
9-6	Example of Increasing the Size of a Shared Repository	9-10
9-7	Example of Creating a Shared Virtual Disk	9-11
9-8	Example of Displaying the Information for All Vdisks	9-11
9-9	Example of Displaying Information for a Single Vdisk	9-11
9-10	Example of Cloning a Virtual Disk	9-12
9-11	Example of Attaching a Virtual Disk To a Virtual Machine	9-12
9-12	Example of Deleting a Virtual Disk from a Shared Repository	9-12
9-13	Example of Importing Virtual Machine Templates from an External Repository Assembly File	9-15
9-14	Example of Importing a Virtual Machine Template from Dom0	9-15
9-15	Example of Importing a Virtual Machine Template Using an External Repository URL	9-16
9-16	Example of Creating a Virtual Machine Clone from a Virtual Machine Template	9-19
9-17	Example of Creating a Snap Clone From a Virtual Machine Template	9-19
9-18	Example of Creating a Snap Clone From an Existing Virtual Machine	9-20
9-19	Example of Configuring a Virtual Machine	9-24
9-20	Example of Migrating a Virtual Machine from the Currently Running Node to Another Node	9-28
9-21	Example of Showing CPU Pools on a Node	9-40
9-22	Example of Creating a New CPU Pool on Oracle Database Appliance Virtualized Platform Nodes	9-41
9-23	Example of Showing CPUs Assigned to Defined CPU Pools on Oracle Database Appliance Virtualized Platform Nodes	9-41
9-24	Example of Changing the Number of CPUs Assigned to a CPU Pool on Oracle Database Appliance Virtualized Platform Nodes	9-41
9-25	Example of Assigning a Virtual Machine to a CPU Pool on Oracle Database Appliance Virtualized Platform	9-42
9-26	Example of Creating a Virtual Local Area Network	9-44
9-27	Example of Assigning and Removing a Virtual Local Area Network for a User Domain	9-45
9-28	Example of Assigning and Removing a Virtual Local Area Network for ODA_BASE	9-45
9-29	Example of Viewing Virtual Local Area Networks	9-46

9-30	Example of Deleting Virtual Local Area Networks	9-46
10-1	Reconfiguring Oracle Database Appliance with a New Core Count	10-7
10-2	Cloning a Virtual Disk	10-8
10-3	Creating a Virtual Machine Image	10-10
10-4	Creating a Virtual Machine Image in Driver Domain Mode	10-10
10-5	Preparing a Copy of the Configuration File	10-21
10-6	Creating a New Database Showing Prompts	10-24
10-7	Creating a New Database in an Existing Oracle Home	10-25
10-8	Creating a New Database from a Template	10-25
10-9	Creating a New Database as a Container Database	10-25
10-10	Creating a Database in Oracle ACFS	10-25
10-11	Creating an Enterprise Edition Database	10-25
10-12	Deploying the Complete Oracle Database Appliance	10-37
10-13	Running the Configurator	10-38
10-14	Running the Offline Configurator with Advance Mode	10-38
10-15	Preloading an Existing Configuration File	10-38
10-16	Changing a User Group Name or ID	10-38
10-17	Viewing the Log File	10-38
10-18	Enabling 10 CPU Cores for Oracle Database Appliance X6-2-HA	10-39
10-19	Expanding Storage	10-39
10-20	Displaying the Write Cache Status of Disks	10-40
10-21	Importing a Virtual Machine Template from Dom0	10-41
10-22	Importing a Virtual Machine Template from a Remote Server	10-41
10-23	Importing Virtual Machine Templates from an Assembly on a Remote Server	10-41
10-24	Importing Virtual Machine Templates Into a Shared Repository From an Assembly on a Remote Server	10-42
10-25	Locating an Oracle ASM Disk by Turning on the Disk's LED	10-42
10-26	Modifying the Database Type	10-45
10-27	Modifying the Database Size	10-45
10-28	Sending a Message to a Running Virtual Machine	10-46
10-29	Modifying the Network Defined in a Virtual Machine Template	10-46
10-30	Viewing the Current and Suggested Kernel Parameters	10-48
10-31	Reconfiguring the Kernel Based on Available RAM	10-48
10-32	Increasing the Size of the DATA Volume	10-49
10-33	Displaying Database Details	10-55
10-34	Displaying Database Details for Four Databases	10-55
10-35	Displaying DB Home Details	10-57

10-36	Displaying DB Home Details	10-57
10-37	Displaying Information About the Local Disks	10-59
10-38	Displaying Information About the Shared Disks	10-59
10-39	Displaying Information About a Specific Shared Disk	10-59
10-40	Determining Which Node is the Master Node	10-61
10-41	Displaying Power Supply Information	10-62
10-42	Displaying the Available Virtual Machine Repositories	10-64
10-43	Displaying Details About a Specific Shared Repository	10-64
10-44	Determining if Storage Validation is Enabled	10-65
10-45	Displaying Information for All Virtual Disks	10-66
10-46	Displaying Information for a Single Virtual Disk	10-66
10-47	Displaying Details of Available Virtual Area Networks (VLANs)	10-68
10-48	Displaying Details for All Virtual Machines	10-69
10-49	Displaying Information for a Single Virtual Machine	10-69
10-50	Opening a Virtual Machine Console	10-70
10-51	Display Information About a Virtual Template	10-71
10-52	Starting ODA_BASE on the Local Node	10-72
10-53	Starting a Shared Repository on Node 0	10-72
10-54	Starting a Virtual Machine on Node 0	10-73
10-55	Forcing a Virtual Machine to Stop	10-73
10-56	Stopping a Shared Repository	10-73
10-57	Stopping the Local ODA_Base	10-73
10-58	Running Diagnostic Tests on a Disk in the Expansion Storage Shelf	10-74
10-59	Unpacking Packages into the Oracle Appliance Manager Repository	10-75
10-60	Verify the Contents of a Patch Bundle	10-76
10-61	Enabling 12 CPU Cores for Oracle Database Appliance	10-78
10-62	Enabling All CPU Cores for Oracle Database Appliance	10-78
B-1	Oracle ACFS Storage Space	B-3
B-2	Determining Storage on the DATA Disk Group	B-4

List of Figures

9-1	Oracle Database Appliance Virtualized Platform Architecture	9-4
9-2	Architecture Overview of Oracle Database Appliance Virtualized Platform Shared Repositories	9-6
9-3	Basic Virtual Machine Local Area Network	9-43
9-4	Oracle Database Appliance Virtualized Platform with Virtual Local Area Networks	9-44

List of Tables

1-1	Software for Oracle Database Appliance	1-1
2-1	Checklist for System Configuration Information for Oracle Database Appliance	2-9
2-2	Minimum IP Address Requirements for Oracle Database Appliance Bare Metal Deployment	2-10
2-3	Minimum IP Address Requirements for Oracle Database Appliance Virtualized Platform Deployment	2-11
3-1	Description of Callouts for Cabling Oracle Database Appliance X6-2-HA with a Single Storage Shelf	3-3
3-2	Description of Callouts for Cabling Oracle Database Appliance Storage Expansion Shelf	3-6
3-3	Peripheral Device Connections for Oracle Database Appliance	3-8
3-4	Description of Callouts for Powering On Oracle Database Appliance	3-9
6-1	Patch Components and Purposes	6-2
7-1	Operating System Groups and Users on Oracle Database Appliance	7-4
9-1	Parameters Available for Configuring a Virtual Machine	9-23
A-1	Directory Paths for Oracle Database Appliance	A-1
A-2	Oracle Groups and Users Configuration for Oracle Database Appliance	A-2
A-3	System Configuration for Oracle Database Appliance	A-2
A-4	Oracle Database Appliance IOps Configuration Settings	A-4
B-1	Oracle ACFS Mount Points and Related Oracle ASM Disk Groups and Volume Information	B-2
B-2	Usable Disk Capacity on Oracle Database Appliance X6-2-HA	B-4
B-3	Oracle ASM Calculations	B-5
B-4	Definition of Terminology	B-6
C-1	Oracle Database Appliance OLTP Database Template Sizes	C-3
C-2	Oracle Database Appliance DSS Database Template Sizes	C-3
C-3	Oracle Database Appliance In-Memory Database Template Size	C-4

Preface

Oracle Database Appliance is an optimized, prebuilt database system that is easy to deploy, operate, and manage. By integrating hardware and software, Oracle Database Appliance eliminates the complexities of nonintegrated, manually assembled solutions. Oracle Database Appliance reduces the installation and software deployment times from weeks or months to just a few hours while preventing configuration and setup errors that often result in suboptimal, hard-to-manage database environments.

- [Audience](#) (page xvii)
- [Documentation Accessibility](#) (page xvii)
- [Related Documents](#) (page xviii)
- [Conventions](#) (page xix)

Audience

This guide is intended for anyone who configures, maintains, or uses Oracle Database Appliance:

- System administrators
- Network administrators
- Database administrators
- Application administrators and users

This book does not include information about Oracle Database architecture, tools, management, or application development that is covered in the main body of Oracle Documentation, unless the information provided is specific to Oracle Database Appliance. Users of Oracle Database Appliance software are expected to have the same skills as users of any other Linux-based Oracle Database installations.

Documentation Accessibility

For information about Oracle's commitment to accessibility, visit the Oracle Accessibility Program website at <http://www.oracle.com/pls/topic/lookup?ctx=acc&id=docacc>.

Access to Oracle Support

Oracle customers that have purchased support have access to electronic support through My Oracle Support. For information, visit <http://www.oracle.com/pls/topic/lookup?ctx=acc&id=info> or visit <http://www.oracle.com/pls/topic/lookup?ctx=acc&id=trs> if you are hearing impaired.

Related Documents

For more information about Oracle Database Appliance, go to <http://www.oracle.com/goto/oda/docs> and click the appropriate release. The following documents are published in the Oracle Database Appliance online documentation library:

- *Oracle Database Appliance Release Notes*
- *Oracle Database Appliance Licensing Information User Manual*
- *Oracle Database Appliance Security Guide*
- *Oracle Database Appliance Accessibility Guide*
- *Oracle Database Appliance X7-2 Deployment and User's Guide*
- *Oracle Database Appliance X6-2-HA Deployment and User's Guide*
- *Oracle Database Appliance X6-2S/M/L Deployment and User's Guide*
- *Oracle Database Appliance Getting Started Guide*
- *Oracle Database Appliance Administration and Reference Guide*
- Oracle Database Appliance Setup Posters and Booklets (a full-size printed copy ships with Oracle Database Appliance)
- *Oracle Database Appliance Owner's Guide*
- *Oracle Database Appliance Service Manual*
- *Oracle Database Appliance Series Safety and Compliance Guide*

The following My Oracle Support Notes contain additional information:

- <https://support.oracle.com/CSP/main/article?cmd=show&type=NOT&id=888888.1>
- <https://support.oracle.com/CSP/main/article?cmd=show&type=NOT&id=2144642.1>

The following documents are published in the Oracle Database Appliance Plug-ins for Oracle Enterprise Manager online documentation library at http://docs.oracle.com/cd/E70264_01/index.htm:

- *Oracle Database Appliance Plug-in for Oracle Enterprise Manager 13c User's Guide*
- *Oracle Database Appliance Plug-in for Oracle Enterprise Manager 12c User's Guide*

For more information about using Oracle Database, go to <http://docs.oracle.com/en/database/> and select the database release from the menu. See the following documents in the Oracle Database online documentation library:

- *Oracle Database Security Guide*
- *Oracle Database Administrator's Guide*
- *Oracle Database SQL Language Quick Reference*
- *Oracle Database Backup and Recovery User's Guide*
- *Oracle Database Backup and Recovery Reference*
- *Oracle Database Utilities*

- *Oracle Automatic Storage Management Administrator's Guide*

For more information about Oracle Integrated Lights Out Manager 3.2, see https://docs.oracle.com/cd/E37444_01/.

For more details about other Oracle products that are mentioned in Oracle Database Appliance documentation, see the Oracle Documentation home page at <http://docs.oracle.com>.

Conventions

The following text conventions are used in this document:

Convention	Meaning
boldface	Boldface type indicates graphical user interface elements associated with an action or terms defined in the text.
<i>italic</i>	Italic type indicates book titles, emphasis, or placeholder variables for which you supply particular values.
monospace	Monospace type indicates commands within a paragraph, URLs, code in examples, text that appears on the screen, or text that you enter.
# prompt	The pound (#) prompt indicates a command that is run as the root user.

1

About Oracle Database Appliance X6-2-HA

This documentation only applies to Oracle Database Appliance X6-2-HA hardware.

Oracle Database Appliance enables you to take advantage of Oracle Database in an easy-to-deploy and manage system. The complete package of software, server, storage, and networking saves time and money by simplifying deployment, maintenance, and support of database and application workloads.

Topics:

- [Oracle Database Appliance Software](#) (page 1-1)
Review this topic to see Oracle software that is installed with or available for download for Oracle Database Appliance.
- [Overview of Oracle Database Appliance Deployment](#) (page 1-2)
Review this overview to understand the order of steps you must complete to deploy Oracle Database Appliance.

1.1 Oracle Database Appliance Software

Review this topic to see Oracle software that is installed with or available for download for Oracle Database Appliance.

Oracle Database Appliance components can include the software listed in the following table.

 **Note:**

Some releases may not contain all the items for one or more components listed in the table.

Table 1-1 Software for Oracle Database Appliance

Component	Component Contents	Component Required On	Installed or Downloaded
Oracle Database Appliance Operating System Image	Oracle Appliance Manager command-line interface Oracle Appliance Manager Configurator (graphical user interface) Oracle Linux Hardware drivers	All deployments	Installed

Table 1-1 (Cont.) Software for Oracle Database Appliance

Component	Component Contents	Component Required On	Installed or Downloaded
Oracle Database Appliance Patch Bundle	Basic input/output system (BIOS) Hardware drivers and management pack and firmware drivers for various components Oracle Appliance Manager Oracle Linux Oracle VM Java Development Kit (JDK) Oracle Integrated Lights Out Manager (Oracle ILOM) Oracle Database Patch Set Update (PSU) Oracle Database Bundle Patch (BP) Oracle Automated Service Request (ASR) Oracle Grid Infrastructure Oracle Intelligent Platform Management Interface (IPMI) Java Development Kit (JDK)	All deployments	Downloaded
Oracle Database Appliance End-User Bundle	Oracle Database clone binaries Oracle Database templates, customized for Oracle Database Appliance deployments Oracle Grid Infrastructure clone binaries	Bare Metal deployments	Downloaded
ODA_BASE template	Oracle Database clone binaries Oracle Database templates, customized for Oracle Database Appliance deployments Oracle Grid Infrastructure clone binaries	Virtualized Platform deployments	Downloaded

Components listed as **Installed** are typically available on Oracle Database Appliance when you receive it, and components listed as **Downloaded** are components that you can download and deploy yourself.

1.2 Overview of Oracle Database Appliance Deployment

Review this overview to understand the order of steps you must complete to deploy Oracle Database Appliance.

1. Prepare for Oracle Database Appliance.
 - a. Register your Support Identifier (SI) for Oracle Database Appliance with My Oracle Support to obtain software and support from Oracle.
 - b. Plan your configuration options and gather network and related information.
 - c. Set up the server site.
 - d. Configure network names and addresses on your Domain Name System (DNS) server.

Use the Oracle Appliance Manager Configurator to generate the network names and addresses, or to validate your existing network names and addresses. The standalone Configurator is available for download from Oracle Technology Network. You can create a configuration file on a local machine before delivery of your Oracle Database Appliance.

2. Prepare Oracle Database Appliance for deployment.
 - a. Mount Oracle Database Appliance hardware into a rack at the server site.
 - b. Connect power and required cables to Oracle Database Appliance.
 - c. Create an initial network configuration to load external files.
3. Install and deploy software on Oracle Database Appliance.
 - a. Download and copy the Oracle Database Appliance end-user bundle to Oracle Database Appliance.
 - b. Run the Oracle Appliance Manager Configurator and select or enter the required information.

During deployment, you configure a two-node Oracle Grid Infrastructure installation (Oracle Clusterware and Oracle Automatic Storage Management). You also can configure Oracle Database Enterprise Edition, Oracle RAC, or Oracle RAC One Node. After the initial deployment, you can add databases, configure core counts, add instance caging, or add virtual domains.
4. Complete postinstallation tasks.
 - a. Download patches to apply after deployment.
 - b. Reset default passwords.

Related Topics

- <http://www.oracle.com/technetwork/database/database-appliance/downloads/index.html>

2

Preparing for Oracle Database Appliance Installation and Deployment

Complete these setup tasks before Oracle Database Appliance is delivered.

Tasks:

- [Registering Your Support Identifier on My Oracle Support](#) (page 2-1)
Add your hardware Support Identifier (SI) to your My Oracle Support account profile.
- [Planning Oracle Database Appliance Configuration Options](#) (page 2-1)
You can deploy Oracle Database Appliance with either Bare Metal or Virtualized Platform deployment configurations.
- [Gathering System Requirement Information](#) (page 2-6)
Use these checklists to collect information before deploying Oracle Database Appliance.
- [Creating an Oracle Appliance Manager Deployment Plan](#) (page 2-11)
Use the standalone Oracle Database Appliance Configurator to create an offline deployment plan and validate your network settings before the actual deployment.

2.1 Registering Your Support Identifier on My Oracle Support

Add your hardware Support Identifier (SI) to your My Oracle Support account profile.

Your hardware SI is supplied when you purchase Oracle Database Appliance. If you acquire new software licenses, then you must also register your new software SIs. The SI registration process can take up to 24 hours to complete.

 **Note:**

You cannot obtain support or software from Oracle without registered SIs.

2.2 Planning Oracle Database Appliance Configuration Options

You can deploy Oracle Database Appliance with either Bare Metal or Virtualized Platform deployment configurations.

For Bare Metal configurations, you must decide how many CPU cores you want to enable, and decide what database configuration options you need, if any. For Oracle

Database Appliance Virtualized Platform installations, review these sections to consider additional configuration options.

Topics:

- [Selecting Oracle Database Appliance Bare Metal Options](#) (page 2-2)
Oracle Database Appliance is shipped from the factory to deploy as bare metal.
- [Selecting Oracle Database Appliance Virtualized Platform Options](#) (page 2-2)
Review Virtualized Platform options, and requirements for these options, such as shared disks and virtual local area networks.
- [Selecting Database Configuration Options](#) (page 2-3)
Select the database templates and configuration options to properly size and configure your initial database.

2.2.1 Selecting Oracle Database Appliance Bare Metal Options

Oracle Database Appliance is shipped from the factory to deploy as bare metal.

Review the systems requirements, database configuration, and software downloads to continue with a bare metal deployment.

2.2.2 Selecting Oracle Database Appliance Virtualized Platform Options

Review Virtualized Platform options, and requirements for these options, such as shared disks and virtual local area networks.

Before you implement virtual machines, you must decide how and where you want them to run. Based on your requirements, you can select High Availability options, or you can select options to reduce interference between competing virtual machines for CPU and network access. You can also select options to provide more storage space, or enable automatic startup for virtual machines. Some of these options require additional network configuration beyond the configuration required for the Oracle Database Appliance servers.

By default, Oracle Database Appliance includes one local repository on each node. The maximum size of that repository depends on your Oracle Database Appliance hardware. The maximum size is 350 GB for Oracle Database Appliance X6-2-HA Virtualized Platform.

When you create virtual machines in the default repositories, the virtual machines can run only on the node where they are located. Because they run on only one node, they have no failover capability.

To obtain the most flexible shared machine environment, use a shared repository with Virtual Local Area Networks (VLANs). Shared repositories provide High Availability options, more storage capacity, and reduced local storage use. VLANs help you partition network traffic for your virtual machines.

When you use a shared repository hosted on shared disks, the virtual machines consume space in Oracle Automatic Storage Management (Oracle ASM) disk groups, DATA and RECO. When you use shared disks, you can convert virtual machines to do the following:

- Start automatically whenever the repository becomes available

- Run on a preferred node
- Start or fail over to the other node, if the preferred node is unavailable

Oracle Database Appliance Virtualized Platform deployments support multiple VLANs on the same network interface card (NIC) port. Each VLAN is essentially an independent logical network that operates with other VLANs over the same physical connection.

Use VLANs to minimize the number of required physical connections and NICs while concurrently separating traffic. Each VLAN is assigned a distinct VLAN identification (ID). The network switch uses VLAN IDs to segregate traffic among the different VLANs operating on the same link. When a VLAN is configured, the VLAN functions exactly like a separate physical connection.

 **Note:**

You must configure virtual LANs on the physical switches before you use them.

2.2.3 Selecting Database Configuration Options

Select the database templates and configuration options to properly size and configure your initial database.

Review the database configuration options and select the templates for Oracle Real Application Clusters (Oracle RAC), and Oracle RAC One Node databases needed to configure your initial database. This information is relevant to you if you plan to configure an initial database during Bare Metal or Virtualized Platform deployments.

Record your decisions and the information that you require for your database templates before you proceed to complete system configuration checklists.

 **Caution:**

Do not use Oracle Database Configuration Assistant (DBCA) to create databases on Oracle Database Appliance. Only use Oracle Appliance Manager for database configuration. Deploying Oracle Database instances using Oracle Appliance Manager ensures that these databases are properly configured, optimized, and supported on Oracle Database Appliance.

Topics:

- [Selecting Database Deployment Options for Oracle Database Appliance](#) (page 2-4)
If you plan to create an initial database during deployment, then use these lists to select an Oracle Database deployment option, and prepare for the deployment.
- [Selecting Database Templates for Oracle Database Appliance](#) (page 2-5)
Oracle Database Appliance software includes preconfigured templates that incorporate Oracle best practices with optimization for different classes of databases.

- [Calculating Required Cores](#) (page 2-6)
After you select templates for your planned Oracle Database, identify your workload type, and determine the total number of CPUs that you require to support the templates.

2.2.3.1 Selecting Database Deployment Options for Oracle Database Appliance

If you plan to create an initial database during deployment, then use these lists to select an Oracle Database deployment option, and prepare for the deployment.

Oracle Appliance Manager installs Oracle Database software on mirrored disks that are internal to Oracle Database Appliance. During the initial deployment with the Oracle Appliance Manager Configurator, you can either create a database or you can defer database creation to a later time.

Options:

- **Enterprise Edition:** Oracle Database 12c release 1 Enterprise Edition (no automated failover), with the following characteristics:
 - Single-instance Oracle Database Enterprise Edition home
 - Oracle Database software installation on both nodes
- **Oracle Real Application Clusters (Oracle RAC) One Node:** Oracle RAC One Node 12c release 1, with the following characteristics:
 - Oracle RAC One Node has a designated Oracle Database Appliance home node
 - Oracle RAC One Node software is installed on both servers
 - Automated failover is configured
 - Enterprise Edition license is required
 - Oracle RAC One Node license on each server is required

Exception: If you designate one server as a backup server, then you can use that server without a license, in accordance with the 10-day rule.
- **Oracle RAC:** Oracle Real Application Clusters 12c release 1, with the following characteristics:
 - Oracle RAC home
 - Oracle RAC software is installed on both servers
 - Enterprise Edition license is required
 - Oracle RAC license on each server is required (not eligible for the 10-day rule)



Note:

For information about the 10-day rule, see the *Oracle Software Investment Guide* at <http://www.oracle.com/us/corporate/pricing/sig-070616.pdf>.

2.2.3.2 Selecting Database Templates for Oracle Database Appliance

Oracle Database Appliance software includes preconfigured templates that incorporate Oracle best practices with optimization for different classes of databases.

Because of differences in CPU counts, memory size, and other resources available with different Oracle Database Appliance models, some templates are not supported on all models.

Each Oracle Database template has different workload profile and performance characteristics:

- Memory requirements, which are calculated from the System Global Area (SGA), and Program Global Area (PGA) sizes
 - Processing requirements, which are calculated from the number of processes
 - Logging requirements, which are based on log buffer size, and online redo log size
1. Review the types of database templates for guidelines and sizing information.
 2. Determine the template that you want to use. The following templates are available for Oracle Database Appliance X6-2-HA:
 - Odb-01s
 - Odb-01
 - Odb-02
 - Odb-04
 - Odb-06
 - Odb-12
 - Odb-16
 - Odb-20

 **Note:**

Oracle strongly recommends that you use the Oracle Database Appliance templates. These templates implement best practices, and are configured specifically for Oracle Database Appliance.

On Oracle Database Appliance Virtualized Platform, if you only plan to deploy one Oracle Database, then Oracle recommends that you use a template for your ODA_BASE that has the same name as the template that you choose for your Oracle Database.

You do not have to select database templates with the same size category as the ODA_BASE template. For example, you can use a small ODA_BASE template to host two very small databases, and you can use a large ODA_BASE template to host either one large with one small database, or host one medium database with one small and two very small databases.

▲ Caution:

The total requirements for your selected database templates must not exceed the capacity of your ODA_BASE template. You can adjust the size of ODA_BASE after the initial deployment, so can expand ODA_BASE to accommodate more databases in ODA_BASE.

Related Topics

- [Types of Database Templates for Oracle Database Appliance X6-2HA](#) (page C-3)

2.2.3.3 Calculating Required Cores

After you select templates for your planned Oracle Database, identify your workload type, and determine the total number of CPUs that you require to support the templates.

Oracle Database Appliance templates are configured and tuned for specific types of Oracle Database workloads:

- Generic templates
- Online analytic transaction templates (OLTP)
- Decision support services templates (DSS)
- In-Memory database templates

These templates are designed to run on a specific number of cores. Caging ensures that each database workload is restricted to the set of cores allocated by the template, enabling multiple databases to run concurrently with no performance degradation, up to the capacity of Oracle Database Appliance. You can select database template sizes larger than your current needs to provide for planned growth, which you accommodate later by adjusting System Global Area (SGA) and Program Global Area (PGA) sizes, as well as the number of cores.

Related Topics

- [Types of Database Templates for Oracle Database Appliance X6-2-HA](#) (page C-3)
Use one of the database templates defined for Oracle Database Appliance X6-2-HA.

2.3 Gathering System Requirement Information

Use these checklists to collect information before deploying Oracle Database Appliance.

- [List of Information You Need Before Deployment](#) (page 2-7)
Collect security, storage, and network information required to prepare for deploying Oracle Database Appliance.
- [Checklist for System Details](#) (page 2-8)
Use the checklist to gather system information that you need to obtain for Oracle Database Appliance. Record the values for your system.

- [Checklist for Custom Node Network Address Configuration](#) (page 2-10)
Use the checklists in this topic to identify the IP addresses required for Oracle Database Appliance.

2.3.1 List of Information You Need Before Deployment

Collect security, storage, and network information required to prepare for deploying Oracle Database Appliance.

Review your security requirements for `root` passwords, determine your storage requirements and network administration requirements, and complete any required configuration before your Oracle Database Appliance hardware is delivered.

Security Requirements

- What root password should you use for Oracle Database Appliance? Root passwords should comply with your system security requirements.
- Secure operating systems are an important basis for general system security. Ensure that your operating system deployment is in compliance with common security practices.

Storage Administration Requirements

Storage administration is integrated into Oracle Database Appliance. No additional storage configuration is required.

Oracle Database Appliance includes integrated storage for operational files (operating system, Oracle Grid Infrastructure home, Oracle Database homes, tools), user data (database files), and log files (database redo logs). Operational files are stored on mirrored internal system disks in each server. Data and database redo log files are stored on shared disks in the storage shelf.

The Oracle Database Appliance X6-2-HA storage shelf contains ten 1.6 TB SSDs (partitioned to 1.2 TB to improve performance) for data, which are configured as a DATA ASM disk group. Four 200 GB SSDs are used for the database redo logs, which are configured as a REDO ASM disk group.

Note:

Disk hardware capacity is measured using the formula that 1 KB equals 1,000 bytes; software storage requirements are based on 1 KB equals 1,024 bytes.

Network Administration Requirements

Ensure that the names and addresses that you provide for network configuration are configured in your Domain Name System (DNS) servers. The addresses that you provide are configured in the `/etc/hosts` file to provide IP name and address resolution, even if a DNS server is not available.

You have the option to connect either to a copper, or to a fiber public network. To connect to a fiber network you must purchase the configuration with 10 GbE SFP+ fiber cards. The InfiniBand interconnect is not supported if you purchase the

configuration with 10 GbE SFP+ fiber cards. Ensure that your network planning is based on the correct type of public network.

Oracle recommends that you resolve addresses using a DNS server, so that you can use Single Client Access Names (SCANs). Having a single name to access the cluster enables the client to use the EZConnect client and the simple JDBC thin URL to access any Oracle Database running in the cluster, independent of the active servers in the cluster. The SCAN provides load-balancing and failover for client connections to these databases. The SCAN works as a cluster alias for Oracle Databases in the cluster.

If you deploy without using a DNS server, then you can add a DNS server later, and add SCANs. If you add SCANs, then you must specify additional VIP addresses for those SCANs.

A correctly configured Oracle Database Appliance requires at least six public addresses on the same subnet for the nodes:

- A public IP name and address for each node
- A virtual IP name and address for each node
- Two addresses that resolve to the SCAN for the cluster.

All names must conform to the RFC 952 standard, which permits alphanumeric characters and hyphens ("-"), but does not allow underscores ("_").

Provide an IP address for the public interface for each node. This interface is `bond0`, or `Eth1` on Oracle Database Appliance Virtualized Platform, (a bond of `Eth2` and `Eth3`), which is used for the host IP address for the node.

Use `bond1` and `bond2` for management, backup, disaster recovery, or other options where you require a network interface. Be prepared to provide a netmask and a gateway for each interface, as both are required when you configure network connections for Oracle Database Appliance. If you select a Custom installation, then provide names and addresses for the `bond1` optional interface.

Also determine answers to the following questions:

- Do you have a Network Time Protocol (NTP) service configured for each server, so that the local system time for each server is synchronized?

If you have NTP servers, and you want to synchronize time between Oracle Database Appliance nodes using NTP, then be prepared to provide the addresses for the servers. If you do not provide addresses for NTP servers, then Oracle Grid Infrastructure software configures time synchronization between nodes using Cluster Time Synchronization Service (CTSS).
- Do you want to plug in the public IP address cables to redundant switches, so that you can avoid a single point of failure for Oracle Database Appliance? Oracle recommends that you use redundant switches for High Availability.

2.3.2 Checklist for System Details

Use the checklist to gather system information that you need to obtain for Oracle Database Appliance. Record the values for your system.

Table 2-1 Checklist for System Configuration Information for Oracle Database Appliance

System Information	Description
Oracle Database Appliance System Name	<p>Provide the name for the cluster running on Oracle Database Appliance. This name is also used as the default root word for Oracle Database Appliance network addresses. The name must be unique across your enterprise, must be at least one character long and no more than 13 characters in length, must be alpha-numeric, cannot begin with a numeral, and may contain hyphens (-). Underscore characters (<code>_</code>) are not allowed.</p> <p>The name you choose will become the default first part of the names for the following items. The default (generated names) can be changed.</p> <ul style="list-style-type: none"> • Oracle ILOM host names for Nodes 1 and 2 (<i>systemname1-ilom</i> and <i>systemname2-ilom</i> respectively) • SCAN host name (<i>systemname-scan</i>) • Node 0 and Node 1 Public IP addresses (<i>systemname1</i> and <i>systemname2</i> respectively) • Node 0 and Node 1 Virtual IP addresses (<i>systemname1-vip</i> and <i>systemname2-vip</i> respectively) <p>The name should comply with the host name specifications described in the RFC 952 standard.</p>
Type of Configuration	<p>Typical, which has the most default values.</p> <p>Custom (recommended by Oracle), which allows you to override default values for any or all of the following:</p> <ul style="list-style-type: none"> • Database block size, language, territory, backup file location, or disk redundancy level for the DATA and RECO disk groups • Oracle Integrated Lights Out Manager (Oracle ILOM) server • Oracle Auto Service Request (Oracle ASR) configuration • Oracle Cloud File System mount point and file system size • Network Time Protocol (NTP) service server
Mode	Bare metal or virtualized platform
Region	Select the region where you plan to operate the Oracle Database Appliance system.
Timezone	Select the time zone where you plan to operate the Oracle Database Appliance system.
Initial Database Details (if you want to create one during deployment)	<ul style="list-style-type: none"> • Database name • Normal or container database • Class (database template) • Database language • Database deployment (Oracle Enterprise Edition single instance, Oracle RAC One Node, or Oracle RAC) • (Container databases only) Data file size, in gigabytes (GB)
Root password	You are prompted to provide a root password for the system. Ensure that the root password you provide is in compliance with common security practices.

 **Note:**

Oracle recommends that you use all lowercase characters for the host name. The names are generated from the system name. For example, if you use `mysystem` as the name of your system, then the derived host names are `mysystem0` and `mysystem1`; the derived host virtual IP names are `mysystem0-vip` and `mysystem1-vip`; and the ILOM names are `mysystem0-ilom` and `mysystem1-ilom`.

2.3.3 Checklist for Custom Node Network Address Configuration

Use the checklists in this topic to identify the IP addresses required for Oracle Database Appliance.

By default, names for network interfaces are derived from the Oracle Database Appliance system name, which you provide during installation. Also, when you use Oracle Appliance Manager Configurator, the addresses for the public IP addresses can be automatically assigned in a sequence starting with the address you provide for the public IP address for Node 0. The other IP addresses generated are, in order, the public address for Node 1; the virtual IP address for Node 0; the virtual IP address for Node 1; and the SCAN addresses.

You can retain the default values, or you can use addresses provided by your system administrator to perform a custom configuration. Ensure that all addresses listed as "Yes" in the "Same Subnet" column are on the same subnet as each other.

Minimum IP Address Requirements for Oracle Database Appliance Bare Metal Deployment

Table 2-2 Minimum IP Address Requirements for Oracle Database Appliance Bare Metal Deployment

Type of IP	Minimum IP Address Counts	IP Address Default Values	Your Values As Applicable	Same Subnet
Host Public Addresses	2	No default	No default	Yes
Host Private Addresses	4	192.168.16.2 4 192.168.16.2 5 192.168.17.2 4 192.168.17.2 5	Not applicable: the private addresses are defined before deployment and should not be changed. If you are using InfiniBand, IP addresses 192.168.17.24 and 192.168.17.25 are not used	Yes
Oracle RAC VIP	2	No default	No default	Yes
Single Client Access Name (SCAN)	2	No default	No default	Yes
Oracle Integrated Lights Out Manager (ILOM)	2	No default	No default	No
User Virtual Machine	Not Applicable	No default	No default	No

Minimum IP Address Requirements for Oracle Database Appliance Virtualized Platform Deployment**Table 2-3 Minimum IP Address Requirements for Oracle Database Appliance Virtualized Platform Deployment**

Type of IP	Minimum IP Address Counts	IP Address Default Values	Your Values As Applicable	Same Subnet
Host Public Addresses	2 (for ODA_BASE) 2 (for Dom0) (Total of 4)	No default	No default If you are using InfiniBand, IP addresses 192.168.17.24 and 192.168.17.25 are not used	Yes
Host Private Addresses	2	192.168.16.24 (for Dom0) 192.168.16.25 (for Dom0) 192.168.16.27 (for ODA_BASE) 192.168.16.28 (for ODA_BASE)	Not applicable: the private addresses are defined before deployment and should not be changed.	Yes
Oracle RAC VIP	2	No default	No default	Yes
Single Client Access Name (SCAN)	2	No default	No default	Yes
Oracle Integrated Lights Out Manager (ILOM)	2	No default	No default	No
User Virtual Machine	At least 1 for each Virtual Machine	No default	No default	No

2.4 Creating an Oracle Appliance Manager Deployment Plan

Use the standalone Oracle Database Appliance Configurator to create an offline deployment plan and validate your network settings before the actual deployment.

If you prefer to configure your system at the time you deploy it, you can wait and use the online Configurator that is part of the base Oracle Database Appliance software. If you want to use the Configurator to create a configuration file before your appliance is delivered, then review these topics.

Topics:

- [About the Standalone Oracle Database Appliance Configurator](#) (page 2-12)
Decide if you want to download the standalone Oracle Database Appliance Manager Configurator to create a configuration file for Oracle Database Appliance.

- [Running the Standalone Oracle Database Appliance Configurator](#) (page 2-12)
Download and run the standalone Configurator to create a configuration file for Oracle Database Appliance X6-2-HA.

2.4.1 About the Standalone Oracle Database Appliance Configurator

Decide if you want to download the standalone Oracle Database Appliance Manager Configurator to create a configuration file for Oracle Database Appliance.

The standalone Oracle Appliance Manager Configurator is a Java-based tool that enables you to generate your deployment plan, and validate your network settings before the actual deployment.

If you want to use this tool before deployment, then you must download and run the Configurator on a local client system. The local client can be a Linux, UNIX, MAC, or Windows system.

At the end of an offline Configurator session, you can save your deployment plan in a configuration file. When you are ready to deploy Oracle Database Appliance, copy this configuration file to the appliance, and run the online Oracle Appliance Manager Configurator to import and deploy your saved plan. You can also print the file's content and use the printout as a checklist for setting up your external network configuration.

Before you save your configuration file, Oracle recommends that you test your network settings. To test the network settings, the client where you run the Configurator must be connected to same network that you intend to use for Oracle Database Appliance.

2.4.2 Running the Standalone Oracle Database Appliance Configurator

Download and run the standalone Configurator to create a configuration file for Oracle Database Appliance X6-2-HA.

To obtain the standalone Oracle Appliance Manager Configurator that matches your version of Oracle Database Appliance software, download it from the following URL:

<http://www.oracle.com/technetwork/database/database-appliance/overview/index.html>

All versions of the Configurator are available from the Overview page by clicking the **Oracle Database Appliance Manager Configurator** link.

After you download the Configurator to a client, run it by using the following procedure:

1. Start the Configurator using the command `config.bat` on a Windows client, or the command `./config.sh` on a Linux or UNIX client.

The Oracle Appliance Manager Welcome page appears.



2. Click **Next**.
3. On the Configuration Type page, select the options for configuration type, environment, and hardware model. If you have an existing configuration file that you want to load and edit, then click **Browse** and locate the file on your client.

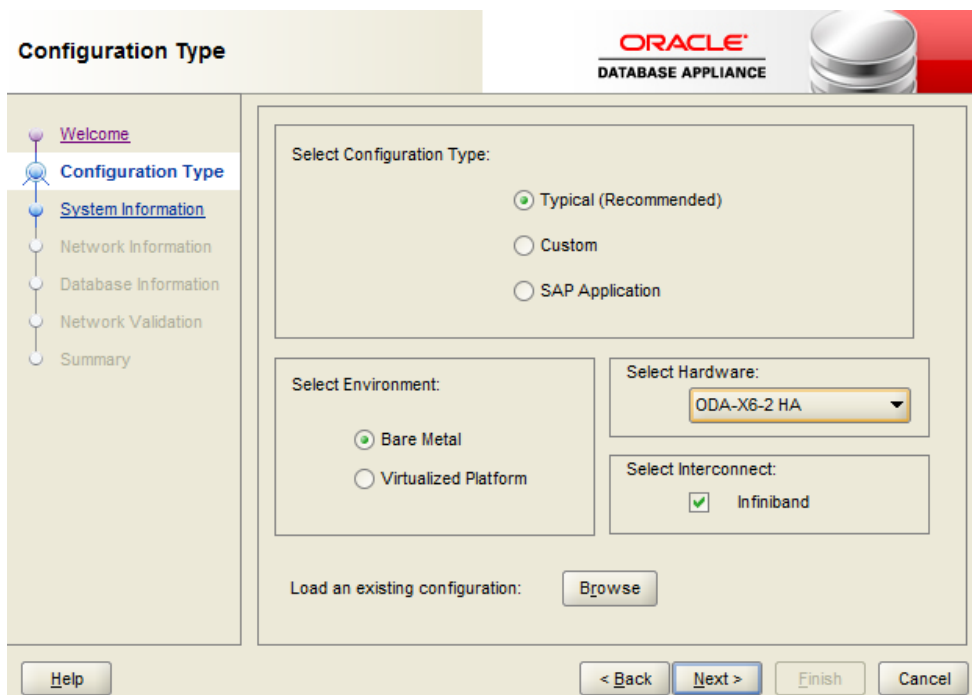

Oracle recommends in most cases that you select the typical configuration. If you intend to deploy SAP applications, then select **SAP Application**. Choose the

Custom option if you want to configure additional or alternate network interfaces, or if you want to override the default values for one or more of the following:

- Database block size, language, territory, backup file location, or disk redundancy level for the DATA and RECO disk groups
- Oracle Integrated Lights Out Manager (Oracle ILOM) server
- Oracle Auto Service Request (Oracle ASR) configuration
- Oracle Cloud File System mount point and file system size
- Network Time Protocol service server

To see the default values for your version of Oracle Database Appliance software before choosing the **Typical** or **Custom** option, run the Configurator using the **Custom** option.

If you are installing Oracle Database Appliance Virtualized Platform, then select **Virtualized Platform**. Otherwise, leave the default value, **Bare Metal**, as the environment option. Select **ODA-X6-2 HA** as the hardware option for Oracle Database Appliance X6-2-HA.

If you are using InfiniBand as the interconnect between the two Oracle Database Appliance servers, then select the **InfiniBand** check box.

The **Browse** option is not useful during the initial run, because there are no configuration files to load.

In this example, **Typical**, **Bare Metal**, and **ODA-X6-2 HA** are the selected options.

 **Note:**

The **SAP Application** option is only valid with the Bare Metal option.

Make your selections, then click **Next**.

4. On the System Information page, provide the system name, and select the correct value from the lists for your region and time zone.

In the **New Root Password** and **New Root Password (confirm)** fields, enter a new password for the `root` user. This password is encrypted in the configuration file. It is temporarily decrypted to reset the password during deployment.

System Information

ORACLE
 DATABASE APPLIANCE

Welcome
 Configuration Type
 System Information
 Network Information
 Database Information
 Network Validation
 Summary

System Name:

Region:

Timezone:

New Root Password:

New Root Password(confirm):

Accelerator Disk Group:

5. Click **Next**.
6. On the Network Information page, provide your domain name, DNS server addresses, public and VIP addresses for your two nodes, SCAN name and addresses, and netmask and Gateway addresses.

Network Information

ORACLE
 DATABASE APPLIANCE

Welcome
 Configuration Type
 System Information
 Network Information
 Database Information
 Network Validation
 Summary

Domain Name:

DNS Servers:

	Node0-Name	Node0-IP	Node1-Name	Node1-IP
Public	<input type="text" value="MySystem0"/>	<input type="text" value="192.0.2.18"/>	<input type="text" value="MySystem1"/>	<input type="text" value="192.0.2.19"/>
VIP	<input type="text" value="System0-vip"/>	<input type="text" value="192.0.2.20"/>	<input type="text" value="System1-vip"/>	<input type="text" value="192.0.2.21"/>
SCAN	<input type="text" value="ySystem-scan"/>	Addresses	<input type="text" value="192.0.2.22"/>	<input type="text" value="192.0.2.23"/>
Netmask	<input type="text" value="255.255.252.0"/>	Gateway	<input type="text" value="192.0.0.1 "/>	

As you enter data on this page, some fields are automatically filled with values derived from earlier entries. For example, if the address that you provide for the

Node 0 public IP address is 192.0.2.18, then the default node addresses generate as follows:

- Node 0 public IP address: 192.0.2.18
- Node 1 public IP address: 192.0.2.19
- Node 0 virtual IP (VIP) address: 192.0.2.20
- Node 1 virtual IP (VIP) address: 192.0.2.21
- SCAN addresses (two addresses resolving to the SCAN VIP name): 192.0.2.22, 192.0.2.23

7. Click **Next**.

8. On the Database Information page, select if you want to create an initial database. If you check the box to create a database, then you can also provide your database details. These details include the database name, which you must enter, and the following options, selected from the available list values:

- **Is Container Database** The default is **false**. If you leave the default value, then the Configurator builds a non-container database
- **Database Type** The default type is **OLTP**. You can also select **DSS**, or select **In-Memory**.
- **Database Class** Select the database class that you want to deploy. Not all options are available for all models of Oracle Database Appliance; the default class is **odb-06**
- **Database Language** The default language is **AMERICAN**
- **Database Deployment** Select one of the following, where **RAC** is the default:
 - Oracle RAC
 - Oracle RAC One Node
 - Oracle Database Enterprise Edition (no Oracle RAC)
- **Data File Size (GB)** If you indicate that you want to build a container database, then provide a database data file size in the final field on this page. (This field does not accept input unless the **Is Container Database selection** is **True**.) If you do not want to create an initial database, then do not select the check box for **Create Initial Database**.
- **Data Files on Flash Storage** Select **false**.

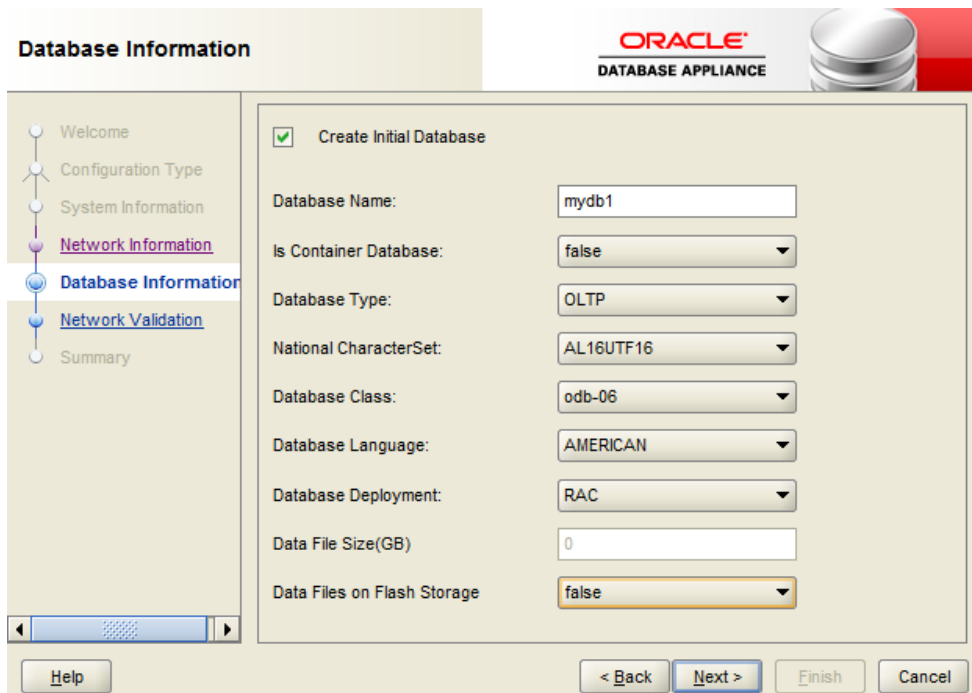

Click **Next**.

9. On the Network Validation page, either validate the network settings and save the validation output in a file, or bypass the validation step by selecting **Skip Network Validations**.

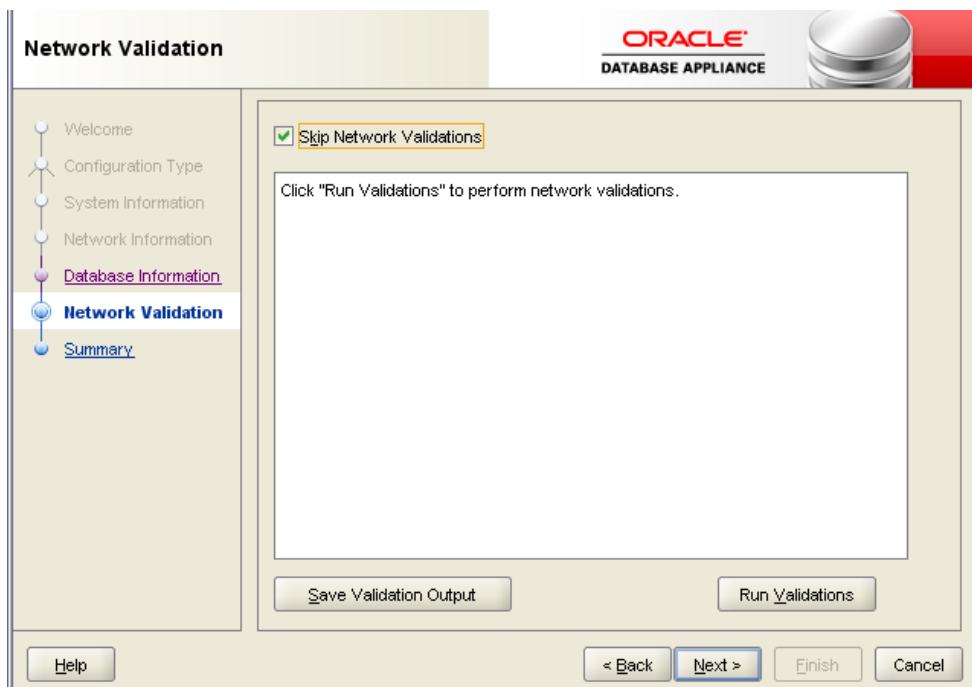

Oracle recommends that you validate your network before you use the configuration file to configure an appliance. However, you must run Oracle

Appliance Manager Configurator on a server attached to the network subnet that is configured for your appliance. If you do not do this, then the validation fails, regardless of whether or not you have completed required configuration.

If the network validation fails, and you want to continue with the configuration, then select **Skip Network Validations**, and then click **Next**. After you review the results, if you are ready to proceed, then click **Next**. If the validation fails, then save the validation output to review these results with your network administrator. To save the configuration information that you have entered and correct the network addresses later, select **Skip Network Validations** and click **Next** to continue to the next page.

10. On the Summary page, review the configuration options that you have selected. Click **Save** to save the configuration file, or click **Back** to modify your selections.

You can print the contents of the configuration file and use the printout to review your configuration entries for deployment planning purposes. You can also load the configuration file later when you run the Configurator again.

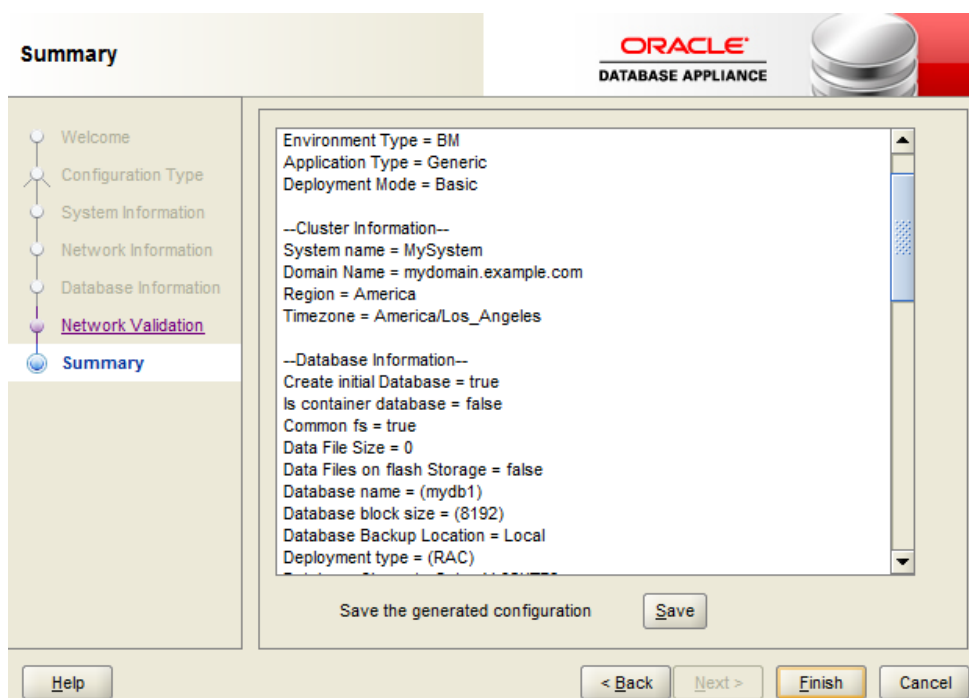

If you are running the Configurator on Oracle Database Appliance, and you have completed the preliminary steps to configure your initial network and install the End-User Bundle or deploy ODA_BASE, then you can click **Install** to deploy the configuration. If you are not ready to complete the deployment, then first click **Save**, and then click **Finish**. Note the name and location of the configuration file. You can copy this configuration file to your Oracle Database Appliance for deployment. If you need to make corrections before deployment, then rerun the standalone Oracle Appliance Manager Configurator, load your configuration file, make the changes, and save the file again.

3

Readying Oracle Database Appliance for Deployment

Complete these tasks to prepare to deploy Oracle Database Appliance.

Topics:

- [About Interconnect Cabling](#) (page 3-1)
Interconnect is reserved for Oracle Grid Infrastructure (GI) and Oracle Relational Database Management System (RDBMS).
- [Attaching Supplied Cables for Oracle Database Appliance](#) (page 3-2)
If you are using Oracle Database Appliance with a single storage shelf, attach the interconnect cables.
- [Attaching a Storage Expansion Shelf to Oracle Database Appliance](#) (page 3-4)
Review these topics to install and cable a storage expansion shelf for Oracle Database Appliance.
- [Attaching Peripheral Devices](#) (page 3-7)
Complete this task if you have direct access to Oracle Database Appliance and you intend to use a locally connected monitor, keyboard and mouse.
- [First Startup of Oracle Database Appliance](#) (page 3-8)
Use this procedure to start up either a newly-installed Oracle Database Appliance, or to start up the appliance after you power it down.
- [Configuring Oracle Integrated Lights Out Manager](#) (page 3-10)
Configure Oracle Integrated Lights Out Manager (Oracle ILOM) to manage Oracle Database Appliance independent of the operating system.
- [Configuring an Initial Network Connection](#) (page 3-11)
Configure a temporary network configuration framework to build your network information during deployment.

3.1 About Interconnect Cabling

Interconnect is reserved for Oracle Grid Infrastructure (GI) and Oracle Relational Database Management System (RDBMS).

Oracle GI includes Oracle Clusterware, Oracle Automatic Storage Management (Oracle ASM), and Oracle Restart. Even if you do not use Oracle Real Application Clusters (RAC), Oracle Database Appliance uses the interconnect for RAC ASM and Oracle GI.

 **Note:**

Do not use interconnect for other applications.

When you power on Oracle Database Appliance for the first time, the system automatically defines your public network interface based on the interconnect. If you use the InfiniBand cards, then the InfiniBand network is used for the interconnect. If you ordered the configuration that contains the 10GbE SFP+ (fiber) cards instead of InfiniBand cards, then the onboard 10GBase-T (Copper) ports are used for the interconnect.

3.2 Attaching Supplied Cables for Oracle Database Appliance

If you are using Oracle Database Appliance with a single storage shelf, attach the interconnect cables.

Topics:

- [Attaching Cables for Oracle Database Appliance X6-2-HA](#) (page 3-2)
Use the diagram in this topic to understand how to attach cable connections between ports on Oracle Database Appliance X6-2-HA.
- [Cabling Oracle Database Appliance to Connect to Fiber Public Networks \(Optional\)](#) (page 3-3)
You can configure Oracle Database Appliance X6-2-HA to use 10GbE SFP+ (fiber) connections for the public network if you ordered the configuration that contains 10GbE SFP+ (fiber) cards instead of InfiniBand cards.

3.2.1 Attaching Cables for Oracle Database Appliance X6-2-HA

Use the diagram in this topic to understand how to attach cable connections between ports on Oracle Database Appliance X6-2-HA.

Single Shelf

The back panel of each node contains three PCIe generation 3 terminal slots, with two sockets in each slot. The PCIe slots are labeled **X PCIe3**, where **X** is the PCIe slot number.

The following figure illustrates the cable connections between ports on Oracle Database Appliance X6-2-HA in a single storage shelf. The cables are color-coded. Match the colors of the labels at the ends of each cable with the colored line shown in the following illustration. Also match the cable colors to the background colors of the socket identification labels.

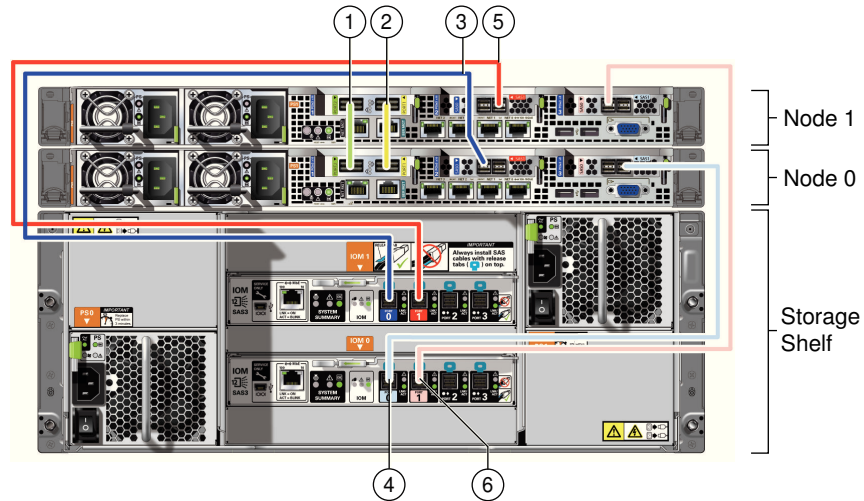

Table 3-1 Description of Callouts for Cabling Oracle Database Appliance X6-2-HA with a Single Storage Shelf

Callout Number	Description
1	Green InfiniBand Cable <ul style="list-style-type: none"> From: Node 0, PCIe slot 1, PORT2 To: Node 1, PCIe slot 1, PORT2
2	Yellow InfiniBand Cable <ul style="list-style-type: none"> From: Node 0, PCIe slot 1, PORT1 To: Node 1, PCIe slot 1, PORT1
3	Dark blue SAS cable: <ul style="list-style-type: none"> From: Node 0, PCIe slot 2, SAS0 To: Storage shelf, top I/O port 0
4	Light blue SAS cable: <ul style="list-style-type: none"> From: Node 0, PCIe slot 3, SAS1 To: Storage shelf, bottom I/O port 0
5	Dark red SAS cable: <ul style="list-style-type: none"> From: Node 1, PCIe slot 2, SAS1 To: Storage shelf, top I/O port 1
6	Light red SAS cable: <ul style="list-style-type: none"> From: Node 1, PCIe slot 3, SAS0 To: Storage shelf, bottom I/O port 1

3.2.2 Cabling Oracle Database Appliance to Connect to Fiber Public Networks (Optional)

You can configure Oracle Database Appliance X6-2-HA to use 10GbE SFP+ (fiber) connections for the public network if you ordered the configuration that contains 10GbE SFP+ (fiber) cards instead of InfiniBand cards.

To use fiber connections between Oracle Database Appliance and your public network, you must cable the interconnect by using the green and yellow copper ports

(onboard ports `net0` and `net1`). The green and yellow Category 6 (Cat 6) interconnect cables for these ports ship with the base system.

The following describes how to connect the ports:

- Plug the green Cat 6 cable into the onboard NET 1 port on each node, as shown in callout 1 in the figure.
- Plug the yellow Cat 6 cable into the onboard NET 0 port on each node, as shown in callout 2 in the figure.

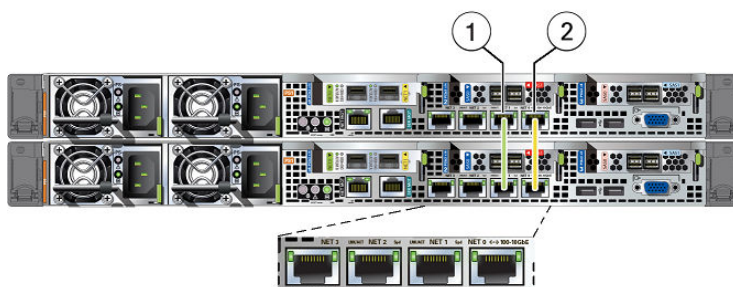

The following sections show the cabling options for 10 GbE SFP+ PCI cards.

Fiber Cables

For optical cables, you must purchase either Short Range (SR) or Long Range (LR) SFP+ transceivers for each of the network ports, and then plug in the appropriate optical cable. Currently, Oracle sells both the SR and LR SFP+ transceivers. In addition to these transceivers, you must purchase the appropriate LC-LC terminated fiber optic cables from a third-party vendor.

Name	Part Number
10 GbE Transceiver SR (SFP+)	X2129A-N
10 GbE Transceiver LR (SFP+)	X5562A-Z

Copper Cables

You can purchase the following copper cables from Oracle. These cables have built-in SFP+ connectors:

Name	Length	Part Number
TwinAx 1m	1m	X2130-1M-N
TwinAx 3m	3m	X2130-3M-N
TwinAx 5m	5m	X2130-3M-N

3.3 Attaching a Storage Expansion Shelf to Oracle Database Appliance

Review these topics to install and cable a storage expansion shelf for Oracle Database Appliance.

Topics:

- [About Attaching and Cabling Storage Shelves](#) (page 3-5)
Review these options and best practices for adding storage shelves for Oracle Database Appliance X6-2-HA.
- [Installing and Cabling a Storage Expansion Shelf](#) (page 3-7)
Use this procedure to install and cable a storage expansion shelf for Oracle Database Appliance

3.3.1 About Attaching and Cabling Storage Shelves

Review these options and best practices for adding storage shelves for Oracle Database Appliance X6-2-HA.

Storage Shelf Options for Oracle Database Appliance X6-2-HA

Oracle Database Appliance X6-2-HA can be shipped with one or two storage shelves. You can obtain the second shelf at a later time to double your storage capacity.

If you originally deployed Oracle Database Appliance with one storage shelf, then you can add a storage expansion shelf at any time without having to shut down your databases or applications.

Best Practice Guidelines for Adding Storage Expansion Shelves

Oracle recommends that you add a storage expansion shelf when you have relatively little activity on your databases. When the system discovers the new storage, Oracle ASM automatically rebalances the disk groups. The rebalance operation may degrade database performance until the operation completes.

▲ Caution:

Review cabling instructions to ensure that you have carried out cabling correctly. Incorrect connections can cause data loss when adding a storage expansion shelf to Oracle Database Appliance with existing databases.

Do not attach cables to Ethernet ports in the I/O modules labeled "SERVICE ONLY" when cabling the system. These ports are intended for use by service engineers only.

How to Cable a Storage Expansion Shelf

The following figure shows you how to insert the required cables into the storage expansion shelf of Oracle Database Appliance. The cables for the two nodes and the original storage shelf are included in the illustration for reference.

The cables are color-coded. Match the colors of the labels at the ends of each cable with the colored line shown in the illustration. Also match the cable colors to the background colors of the socket identification labels. You can also use the callouts in the diagram to identify the cables and ports. Because all cables with the same terminations are interchangeable, you can ignore the color coding. The back panel of each node contains three PCIe generation 3 terminal slots, with two sockets in each slot. The PCIe slots are labeled **X PCIe3**, where **X** is the PCIe slot number. Review the callout table that follows the figure for more information.

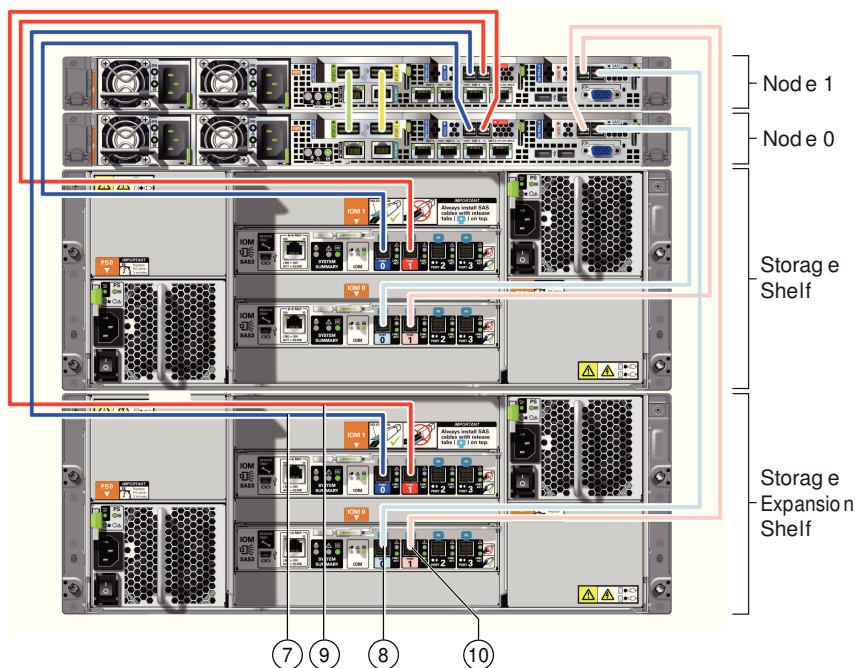

The cables identified with callout numbers in the preceding figures are included with each shipped Oracle Database Appliance storage expansion shelf. These cables are all black, but have colored labels at each end that match the references to cable colors in the text and the label colors on the back panels.

Table 3-2 Description of Callouts for Cabling Oracle Database Appliance Storage Expansion Shelf

Callout Number	Description
7	Dark blue SAS cable: <ul style="list-style-type: none"> From: Node 1, PCIe slot 2, SAS0 To: Storage expansion shelf, top I/O port 0
8	Light blue SAS cable: <ul style="list-style-type: none"> From: Node 1, PCIe slot 3, SAS1 To: Storage expansion shelf, bottom I/O port 0
9	Dark red SAS cable: <ul style="list-style-type: none"> From: Node 0, PCIe slot 2, SAS1 To: Storage expansion shelf, top I/O port 1
10	Light red SAS cable: <ul style="list-style-type: none"> From: Node 0, PCIe slot 3, SAS0 To: Storage expansion shelf, bottom I/O port 1

▲ Caution:

Do not attach cables to Ethernet ports in the I/O modules labeled "SERVICE ONLY" when cabling the system. These ports are intended for use by service engineers only.

3.3.2 Installing and Cabling a Storage Expansion Shelf

Use this procedure to install and cable a storage expansion shelf for Oracle Database Appliance

1. Place the storage expansion shelf below your Oracle Database Appliance, if possible, or else close enough to connect the provided cables.

The storage expansion shelf normally sits at the bottom of Oracle Database Appliance, beneath the storage shelf. However, because racks should always be provisioned from the bottom up, that space may be unavailable. In that case, to avoid re-rack mounting the entire system, you can position the storage expansion shelf above the server nodes, or in a different, but adjacent, rack.

2. Install the extension storage shelf in exactly the same manner as the original storage shelf. To review information about installing optional components for Oracle Database Appliance, see the section "Optional Component Installation" in Chapter 4 of *Oracle Database Appliance Owner's Guide*.
3. Use the figures in this topic to assist you to cable the storage expansion shelf for your Oracle Database Appliance model.

▲ Caution:

Incorrect connections can cause data loss when adding a storage expansion shelf to Oracle Database Appliance with existing databases.

4. Attach the supplied power cords. Refer to the section "Attaching Power Cords and Initializing Components" to obtain information and see figures showing how to attach power cords.

3.4 Attaching Peripheral Devices

Complete this task if you have direct access to Oracle Database Appliance and you intend to use a locally connected monitor, keyboard and mouse.

Oracle Database Appliance is not equipped with human-computer interface devices, such as a monitor or keyboard. If you want to log in locally, instead of through a network, then you must attach interface devices.

Attach a monitor to the graphics card port, and attach a keyboard and a mouse to the USB ports. Refer to the figure and table to identify the ports.

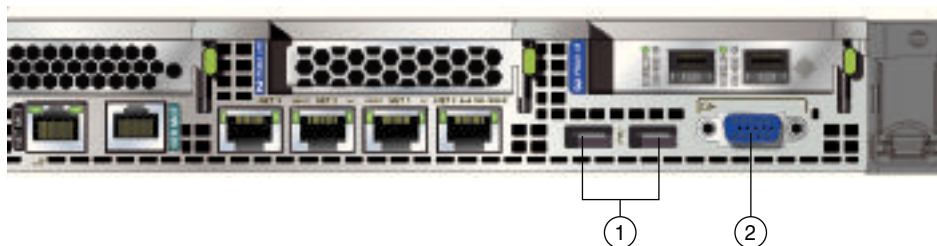

In the figure, callout 1 identifies the ports for the keyboard and mouse. Callout 2 identifies the monitor port.

Table 3-3 Peripheral Device Connections for Oracle Database Appliance

Callout Number	Description
1	USB ports for the keyboard and mouse
2	Graphics card port for the monitor

3.5 First Startup of Oracle Database Appliance

Use this procedure to start up either a newly-installed Oracle Database Appliance, or to start up the appliance after you power it down.

To ready Oracle Database Appliance for the powering on the first time, you need to attach all of the required power cords and confirm that initialization completes successfully. You can then start up the system by pushing the power button once.

- [Attaching Power Cords and Initializing Components](#) (page 3-8)
Attach power cords for Oracle Database Appliance.
- [Powering On Oracle Database Appliance the First Time](#) (page 3-9)
Use this procedure the first time you power on Oracle Database Appliance.

3.5.1 Attaching Power Cords and Initializing Components

Attach power cords for Oracle Database Appliance.

▲ Caution:

Before plugging in the power cords, ensure that the electrical outlets providing the power are grounded.

If you use only a single AC circuit, then connect both power cords for each component to that circuit. If you want to maintain N+1 power supply redundancy, then use two separate AC circuits. Connect one power cord from each AC circuit into each component.

For more information about cabling with the supplied Cable Management Arm, refer to *Oracle Database Appliance Owner's Guide*.

3.5.2 Powering On Oracle Database Appliance the First Time

Use this procedure the first time you power on Oracle Database Appliance.

 **Note:**

After you connect power cords, the green SP OK light-emitting diode (LED) lights blink for a few minutes, and then turn to steady ON. The cooling fans also may turn on. However, these events do not indicate that the system is started. You must complete all of the steps in this section to turn on the appliance properly. Read through the entire section to understand the sequence required for initial system startup. (Optional) Enter task prerequisites here.

1. Turn on the attached storage shelf, or shelves, before powering on the server nodes.
2. After turning on the storage in the rear of each storage shelf, push the recessed power button to turn on the server nodes.

 **Note:**

The fully-initialized state is indicated by the green SP OK LEDs staying steadily lit. If any of the green LED lights on the server are still blinking, then wait for them to complete their initialization steps.

The figure is an image of the front of the power panel, see the following callout table to identify the power button and the system initialization status indicator lights.

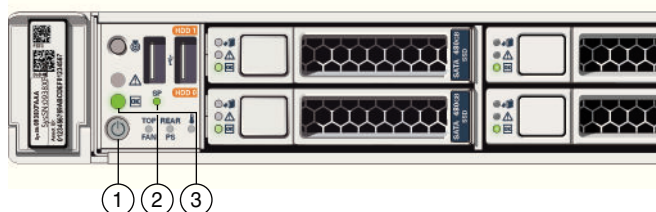

Table 3-4 Description of Callouts for Powering On Oracle Database Appliance

Callout	Function
1	Recessed On/Off power button, which is located on the front panel of the appliance. Push this button only once. Do not repeatedly push the power button.
2	SP OK LED light, located on the front panel of the appliance.

Table 3-4 (Cont.) Description of Callouts for Powering On Oracle Database Appliance

Callout	Function
3	Green Power OK LED, located on the front panel. These lights must be in the steady ON position (Green light does not blink) before you log on to the system.

- Wait for Oracle Database Appliance to complete startup.

 **Note:**

Do not repeatedly push the power buttons. Startup can take several minutes to complete.

Oracle Database Appliance is ready for use when the green Power OK LEDs (callout 3) on the front of the system remains steadily on.

3.6 Configuring Oracle Integrated Lights Out Manager

Configure Oracle Integrated Lights Out Manager (Oracle ILOM) to manage Oracle Database Appliance independent of the operating system.

Oracle ILOM provides alternate ways to restart and troubleshoot Oracle Database Appliance.

You must set up the following items first to configure Oracle ILOM:

- A name and IP address
- A password to replace the default Oracle ILOM password
- Access to a management network, using an assigned netmask
- An Ethernet cable connected from the NET MGT port to the management network

In the default configuration, Dynamic Host Configuration Protocol (DHCP) is enabled in Oracle ILOM and the DHCP server automatically assigns network settings. To determine the IP address or host name assigned by the DHCP server, use the network tools provided with the DHCP server.

If you do not use DHCP, then use the custom option in Oracle Database Appliance Manager Configurator to assign IP addresses and host names to Oracle ILOM when you deploy your database.

 **Note:**

If you have not enabled DHCP, then you must complete Oracle Database Appliance configuration to access Oracle ILOM.

To connect to the Oracle ILOM, use one of the following two methods:

- Log in using a web interface by completing these steps:

- a. Using a client system's browser, enter the IP address or host name assigned by DHCP into the browser address field and press **Enter**.
- b. At the login page, enter the default user name, `root` and the default password, `changeme`.

The Oracle ILOM web interface appears.

2. Log in using a command-line interface (CLI) by completing these steps:

- a. Using a client system, establish a secure shell (SSH) connection by entering the following on the command line:

```
ssh -l root sp_ip_address
```

where `sp_ip_address` is the IP address assigned by DHCP.

- b. Enter the default user name, `root`, and the default password, `changeme`.

The Oracle ILOM CLI prompt appears.

Troubleshooting the ILOM Configuration

If the ILOM is not working, then ensure that the ILOM NIC is enabled and that `ipv4` is enabled.

You can configure the ILOM with the IPMI tool or through the BIOS. The following describes how to use the IPMI tool:

1. Open the IPMI tool.

```
# ipmitool -I open sunoem cli
```

2. Go to `SP/network` and verify that the port is enabled:

```
cd /SP/network
```

3. If the port is not enabled, then enable the port.

```
set state=enabled
```

4. In `SP/network`, verify that `ipv4` is enabled.

5. If `ipv6` is enabled, then disable `ipv6` and enable `ipv4`

```
# ipmitool -I open sunoem cli "set /SP/network/ipv6 state=disabled"  
# ipmitool -I open sunoem cli "set /SP/network/ipv4 state=enabled"
```

3.7 Configuring an Initial Network Connection

Configure a temporary network configuration framework to build your network information during deployment.

To manage your Oracle Database Appliance deployment across a network, you must configure an initial network connection. Use this network to transfer deployment software to Oracle Database Appliance. When you power on Oracle Database Appliance X6-2-HA for the first time, the system automatically defines your public network interface based on the interconnect. The InfiniBand network is used for the interconnect if InfiniBand cards are used. If InfiniBand cards are replaced with 10 GbE SFP+ (fiber) cards, then the onboard 10GBase-T (Copper) ports are used for the interconnect.

If you have physical access to your Oracle Database Appliance, then you can use a USB storage device to transfer deployment software to the appliance. In that case, you do not need to set up an initial network configuration.



Note:

The initial network configuration is temporary. It is replaced during the final image deployment.

1. Log in to Oracle Database Appliance as `root`.
On Bare Metal installations, log in to a console.
On Oracle Database Appliance Virtualized Platforms, log in to Dom0.
2. On Bare Metal installations, if you have one or more storage shelves, then run the command `oakcli validate` with the `storageTopology` option to perform a validity check of cabling.

For example:

```
oakcli validate -c storageTopology
```

On Virtualized Platform installations, you perform this check as part of the Oracle Software deployment process.

3. Run the command `oakcli configure firstnet` to configure the initial network.

As needed, refer to the network configuration information that you previously collected in preparation for deployment.

To use the global option, accept the default value in the first prompt, and then provide the required data for the remaining prompts. You do not need to enter anything to accept the default values that are shown in square brackets at the end of prompts.

Use the following example to help you to respond to prompts. In this example, default values are always selected. Values that you need to provide are shown in *italic font*, with the exception of the `net1` gateway address; the program obtains the gateway IP.

In the preceding example, the prompt for the `net1` gateway address includes a default value, shown as `gateway-IP-address`. The program derives this gateway address using the network information you provided for the other IP addresses. Accept this value, unless your network administrator provides an alternative gateway address that is different from the default that the appliance command-line interface detects:

```
oakcli configure firstnet
Configure the network for the node(s)(local, global) [global]:
The network configuration for both nodes:
Domain Name: my-organization-domain-name
DNS Server(s): Primary Dns Server: my-primary-DNS-server
                Secondary Dns Server: my-secondary-DNS-server
                Tertiary Dns Server: my-tertiary-DNS-server
Node Name      Host Name
0              my-Node-0-host-name
1              my-Node-1-host-name
Choose the network interface to configure (net1, net2, net3, net4) [net1]:
```

```
Configure DHCP on net1 (yes/no) [no]:
You have chosen static configuration on net1
Enter the IP address for net1 on Node 0: my-Node-0-IP-address
Enter the IP address for net1 on Node 1: my-Node-1-IP-address
Netmask for net1: your-netmask
Gateway Address for net1 [gateway-IP-address]:
Plumbing the IPs now on Node 0 ...
::::::::::::::::::::::::::::::::::::::::::::::::::
Plumbing the IPs now on Node 1 ...
::::::::::::::::::::::::::::::::::::::::::::::::::
```

4. Repeat these steps on Node 1.

 **Caution:**

On multi-node systems, you must run the command `configure-firstnet` on both nodes.

Oracle recommends using the `oakcli configure firstnet` command only one time on Oracle Database Appliance. Subsequent use after configuring the initial network can cause unpredictable changes to your network settings.

4

Deploying Oracle Software on Oracle Database Appliance

Complete these tasks to deploy the Oracle Database Appliance software.

- [About Deploying Oracle Database Appliance Software Using OAKCLI](#) (page 4-1)
Review this information to understand the steps required for different deployments, where log files are placed, and how to change deployment types.
- [Deploying Bare Metal Platforms on Oracle Database Appliance](#) (page 4-2)
Complete this procedure to deploy Oracle software directly on the appliance, also known as a Bare Metal configuration of Oracle Database Appliance.
- [Deploying Virtualized Platform Software](#) (page 4-7)
Complete these tasks to deploy a Virtualized Platform configuration on Oracle Database Appliance X7-2-HA. You must complete the deployment tasks in the order that they are listed.

4.1 About Deploying Oracle Database Appliance Software Using OAKCLI

Review this information to understand the steps required for different deployments, where log files are placed, and how to change deployment types.

Tasks in this chapter are marked to indicate if they apply to Bare Metal deployments, Virtualized Platform deployments, or both. Perform only the tasks designated for a deployment on your platform.

Note:

If you are planning to convert from Oracle Database Appliance Virtualized Platform to a bare metal deployment, first check with My Oracle Support to confirm that you have a compatible image installed.

Recovering from Failed Deployments, Or Changing Deployments

You can use the cleanup script `cleanupDeploy.sh` described in this chapter to reset your system or to repeat a failed deployment.

About OAKCLI Deploy Command Log Files

The `oakcli deploy` command creates log files in the following filepath:

```
/opt/oracle/oak/onecmd/tmp/
```

Log files are prefaced with the string `STEP`. For example:

```
/opt/oracle/oak/onecmd/tmp/STEP-6-20160226103534.log
```

4.2 Deploying Bare Metal Platforms on Oracle Database Appliance

Complete this procedure to deploy Oracle software directly on the appliance, also known as a Bare Metal configuration of Oracle Database Appliance.

The procedure to deploy software in a bare-metal configuration consists of the following steps:

1. Install the end-user bundle for Bare Metal platform deployments
2. Prepare the appliance to run Oracle Appliance Manager Configurator
3. Deploy your configuration using Oracle Appliance Manager.

The End-User GI/RDBMS Clone files contain specific Grid Infrastructure (GI) and RDBMS software components, for deployment on an Oracle Database Appliance in the "shipped from factory" state, or an Oracle Database Appliance that has been re-imaged using the OS ISO Image.

You must install the end-user bundle on Oracle Database Appliance before you deploy any other software. To install the end-user bundle, download the appropriate patch file to an external client. Copy the patch from your client to Oracle Database Appliance, and install the patch.

Note:

Oracle Database Appliance is ready when the green Power OK LED lights on the front of the system remain steadily on. If any of the green LED lights on the server are still blinking, then wait for them to complete their initialization steps.

1. Run the following command on the appliance to determine if your Oracle Appliance Manager software version is current: `/opt/oracle/oak/bin/oakcli show version -detail`

If your version is earlier than 12.2.1.3.0, then download the patches and update your base image.

2. Download the Oracle Database Appliance 12.2.1.3.0 End-User Bundle (GI/RDBMS Clone) to a location on Node 0.
 - a. Sign in to MyOracle Support, then locate patch 12978712 for the Oracle Database Appliance End-User Bundle.
<https://support.oracle.com>
 - b. Select the patch version for release 12.2.1.3.0.
 - c. Click **Download** to download the zip file.

```
p12978712_122130_Linux-x86-64_1of2.zip  
p12978712_122130_Linux-x86-64_2of2.zip
```

You can copy the file either by using a USB storage device or by using Secure Copy command (`scp`).

- To use a USB drive to transfer the file, you must format it first as FAT32, ext3, or ext4. NTFS file formats are not supported.
- To use secure copy, you must first set up a static IP address (for example, `oda_host`) and configure Oracle Database Appliance with that address by using the `oakcli configure firstnet` command.

For example, if you use the `scp` command, then enter a command similar to the following, where the temporary host address is `oda_host`, and you are copying the bundle to `/tmp` on Node 0:

```
scp p12978712_122130_Linux-x86-64_1of2.zip root@odahost:/tmp
```

```
scp p12978712_122130_Linux-x86-64_2of2.zip root @odahost:/tmp
```

3. Use the command syntax `oakcli unpack -package /directory_path/package_name` to unpack the Oracle Database Appliance software, where `directory_path` is the path where the end-user bundle patch file is located, and `package_name` is the name of the package.

For example, if the end-user bundle patch files are in `/tmp`, and the patch names are `p12978712_122130_Linux-x86-64_1of2.zip` and `p12978712_122130_Linux-x86-64_2of2.zip`, then enter the following commands:

```
# oakcli unpack -package /tmp/p12978712_122130_Linux-x86-64_1of2.zip
# oakcli unpack -package /tmp/p12978712_122130_Linux-x86-64_2of2.zip
```

The command `oakcli unpack` unpacks the bundle patch, and places the extracted files in the directory locations required for deployment.

4. Startup VNC server on Node 0. Then use VNC to log in to Node 0 and port 5901 of Oracle Database Appliance as the `root` user using the default password.
5. Enter the following command to launch the Oracle Appliance Manager Configurator: `# /opt/oracle/oak/bin/oakcli deploy`

The Oracle Appliance Manager Welcome screen appears.

Note:

If the Welcome window in Oracle Appliance Manager Configurator fails to open, then set the user `DISPLAY` variable to display to your terminal window.

6. Click **Next**.
7. On the Configuration Type page, select the options for configuration type: Typical, Custom, or SAP Application. If you have an existing configuration file that you want to load and edit, then click **Browse** and locate the file on your client.

Note:

Do not use a configuration file created for an earlier version of Oracle Appliance Manager Configurator. If you do not have a current configuration file, then complete a real-time configuration and deployment.

Oracle recommends in most cases that you select the typical configuration. If you intend to deploy SAP applications, then select **SAP Application**. Choose the **Custom** option if you want to configure additional or alternate network interfaces, or if you want to override the default values for one or more of the following:

- Database block size, language, territory, backup file location, or disk redundancy level for the DATA and RECO disk groups
- Oracle Integrated Lights Out Manager (Oracle ILOM) server
- Oracle Auto Service Request (Oracle ASR) configuration
- Oracle Cloud File System mount point and file system size
- Network Time Protocol service server

To see the default values for your version of Oracle Database Appliance software before choosing the **Typical** or **Custom** option, run the Configurator using the **Custom** option.

 **Note:**

The **SAP Application** option is only valid with the Bare Metal option.

Make your selection, then click **Next**.

8. On the System Information page, provide the system name, and select the correct value from the lists for your region and time zone.

In the **New Root Password** and **New Root Password (confirm)** fields, enter a new password for the `root` user. This password is encrypted in the configuration file. It is temporarily decrypted to reset the password during deployment.

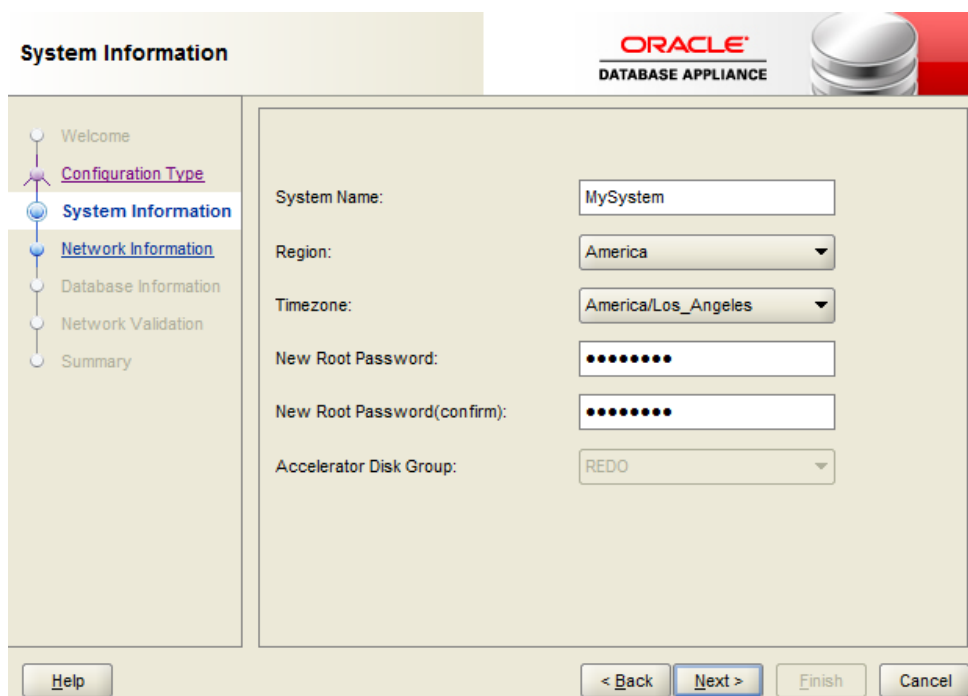

System Information

ORACLE
DATABASE APPLIANCE

System Name:

Region:

Timezone:

New Root Password:

New Root Password(confirm):

Accelerator Disk Group:

9. Click **Next**.
10. On the Network Information page, provide your domain name, DNS server addresses, public and VIP addresses for your two nodes, SCAN name and addresses, and netmask and Gateway addresses.

	Node0-Name	Node0-IP	Node1-Name	Node1-IP
Public	MySystem0	192.0.2.18	MySystem1	192.0.2.19
VIP	System0-vip	192.0.2.20	System1-vip	192.0.2.21
SCAN	ySystem-scan	Addresses	192.0.2.22	192.0.2.23
Netmask	255.255.252.0	Gateway	192.0.0.1	

As you enter data on this page, some fields are automatically filled with values derived from earlier entries. For example, if the address that you provide for the Node 0 public IP address is 192.0.2.18, then the default node addresses generate as follows:

- Node 0 public IP address: 192.0.2.18
 - Node 1 public IP address: 192.0.2.19
 - Node 0 virtual IP (VIP) address: 192.0.2.20
 - Node 1 virtual IP (VIP) address: 192.0.2.21
 - SCAN addresses (two addresses resolving to the SCAN VIP name): 192.0.2.22, 192.0.2.23
11. Click **Next**.
 12. On the Database Information page, select if you want to create an initial database. If you check the box to create a database, then you can also provide your database details. These details include the database name, which you must enter, and the following options, selected from the available list values:
 - **Is Container Database** The default is **false**. If you leave the default value, then the Configurator builds a non-container database
 - **Database Type** The default type is **OLTP**. You can also select **DSS**, or select **In-Memory**.

- **Database Class** Select the database class that you want to deploy. Not all options are available for all models of Oracle Database Appliance; the default class is **odb-06**
- **Database Language** The default language is **AMERICAN**
- **Database Deployment** Select one of the following, where **RAC** is the default:
 - Oracle RAC
 - Oracle RAC One Node
 - Oracle Database Enterprise Edition (no Oracle RAC)
- **Data File Size (GB)** If you indicate that you want to build a container database, then provide a database data file size in the final field on this page. (This field does not accept input unless the **Is Container Database selection** is **True**.) If you do not want to create an initial database, then do not select the check box for **Create Initial Database**.
- **Data Files on Flash Storage** Select **false**. For Oracle Database Appliance X6-2-HA, the database is always stored in flash storage.

The screenshot shows the 'Database Information' configuration page in the Oracle Database Appliance wizard. The 'Create Initial Database' checkbox is checked. The configuration parameters are as follows:

Parameter	Value
Database Name	mydb1
Is Container Database	false
Database Type	OLTP
National CharacterSet	AL16UTF16
Database Class	odb-06
Database Language	AMERICAN
Database Deployment	RAC
Data File Size(GB)	0
Data Files on Flash Storage	false

Navigation buttons at the bottom include: Help, < Back, Next >, Finish, and Cancel.

Click **Next**.

13. On the Summary page, review the configuration options that you have selected. Click **Save** to save the configuration file, or click **Back** to modify your selections.

You can print the contents of the configuration file and use the printout to review your configuration entries for deployment planning purposes. You can also load the configuration file later when you run the Configurator again.

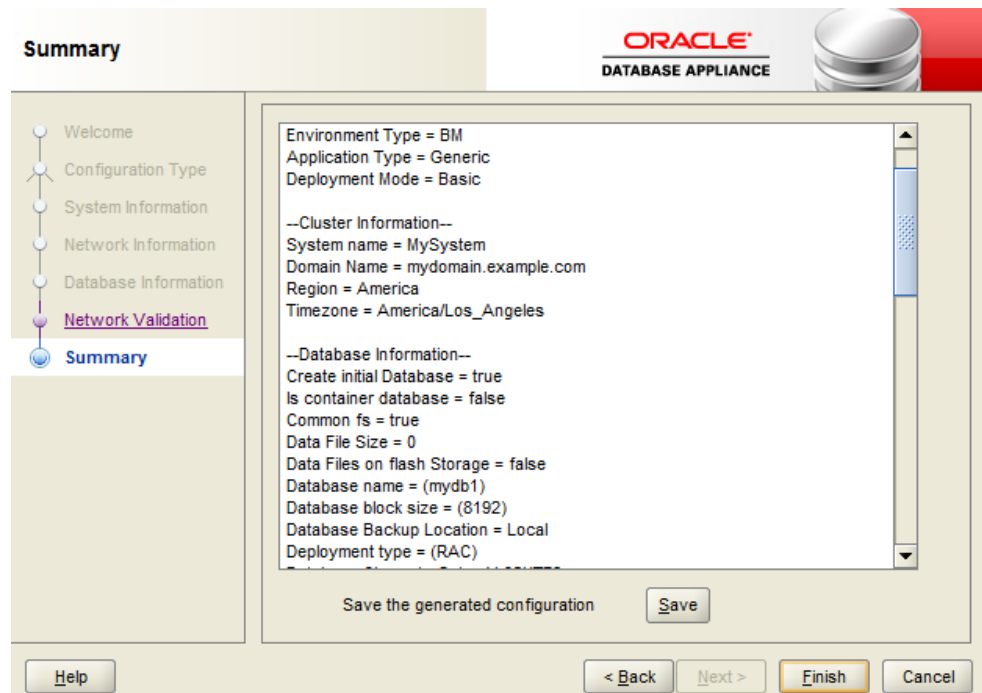

If you are running the Configurator on Oracle Database Appliance, and you have completed the preliminary steps to configure your initial network and install the End-User Bundle or deploy ODA_BASE, then you can click **Install** to deploy the configuration.

If you are not ready to complete the deployment, then first click **Save**, and then click **Finish**. Note the name and location of the configuration file. You can copy this configuration file to your Oracle Database Appliance for deployment. If you need to make corrections before deployment, then rerun the standalone Oracle Appliance Manager Configurator, load your configuration file, make the changes, and save the file again.

4.3 Deploying Virtualized Platform Software

Complete these tasks to deploy a Virtualized Platform configuration on Oracle Database Appliance X7-2-HA. You must complete the deployment tasks in the order that they are listed.

Topics:

- [About Deploying an Oracle Database Appliance Virtualized Platform](#) (page 4-8)
To use the virtualization features, you must reimage the system and configure the appliance as a virtualized platform.
- [Determining if the System is Configured with a Virtual Machine](#) (page 4-10)
Before deploying a Virtualized Platform on Oracle Database Appliance, determine if the system has the Virtualized OS ISO image.
- [Downloading Images for a Virtualized Platform](#) (page 4-10)
Download the Oracle Database Appliance Virtualized OS ISO Image and the VM Template on your local machine.

- [Installing a Virtualized OS ISO Image](#) (page 4-11)
Reimage Oracle Database Appliance with a virtualized operating system image on both nodes and configure the initial public network.
- [Installing the Virtualized Platform Template](#) (page 4-14)
Use the Virtualized Platform Template to deploy ODA_BASE for a virtualized platform. The template includes the Oracle Grid Infrastructure and Oracle Database clone files

4.3.1 About Deploying an Oracle Database Appliance Virtualized Platform

To use the virtualization features, you must reimage the system and configure the appliance as a virtualized platform.

Oracle Database Appliance ships from the factory with a bare metal ISO image installed. To enable virtualization, you must deploy the Virtualized OS ISO image on both nodes, configure your public network, and then deploy the Oracle Database Appliance Virtualization Platform. Oracle Database Appliance ships with various components, including Oracle Integrated Lights Out Manager (ILOM) to help manage the system remotely. The Oracle Integrated Lights Out Manager (ILOM) client must be on at least version `jre-7-linux-i586.rpm` to be able to launch the remote console.

Domain Deployment Configuration

Use the Oracle Appliance Kit Command-Line Interface, also known as OAKCLI, to deploy and configure the Oracle Database Appliance Virtualized Platform.

When you deploy Oracle Database Appliance Virtualized Platform, your system is configured with two domains on each server node: `Dom0` and `ODA_BASE` (also known as `Dom1`). You can use the CPU cores not assigned to Oracle Database (`ODA_BASE`) for virtual machines, each of which is referred to as a Domain `U`.

The virtual disk and `vm.cfg` files are stored in the following directories:

- `Dom0: /Repositories/vm_repo_name/.ACFS/snaps/vm_name/VirtualMachines/vm_name`
- `ODA_BASE: /app/sharedrepo/vm_repo_name/.ACFS/snaps/vm_name/VirtualMachines/vm_name`

Once deployed, you can create and manage shared repositories and create guest virtual machines and Oracle Linux driver domain guests.

Overview of Deploying a Virtualized Platform

The following is an overview of the steps to deploy a virtualized platform:

1. (Optional) Run the standalone Configurator to validate the network and create a configuration file. See “Running the Standalone Oracle Database Appliance Configurator”

While not required, using the standalone Configurator enables you to define your configuration details and validate the network on a separate system. You can save the settings in a configuration file and use the file to quickly pre-populate the configuration fields when you deploy the platform in Step 5.

2. Connect the power and public network cables and start up the systems.

3. Deploy the Virtualized OS ISO image to reimage the appliance operating system on both nodes and create an initial network.
4. Install the Virtualized Platform Template, then configure and deploy the appliance.

The template deploys ODA_BASE on your system, which includes the Oracle Database clone binaries, Oracle Database templates, customized for Oracle Database Appliance deployments, and Oracle Grid Infrastructure clone binaries. After you install the template, you will use the Configurator to define your configuration and network settings and install the appliance. After you successfully deploy the appliance, you can begin creating a virtual environment and virtual machines.

Overview of Deploying a Guest Virtual Machine

Deploying a Guest virtual machine requires the following steps:

1. Create a new repository, if necessary. See "How to Create and Manage Shared Repositories".
2. Import the required template or assembly. See "How to Manage Virtual Machine Templates".
3. Configure the template or assembly. See "Configuring a Virtual Machine Template".
4. Clone the template or assembly. See "How to Create Clones and Snap Clones of a Template".
5. Update the virtual machine as required. See "Modifying a Virtual Machine Template Configuration".
6. Start the virtual machine. See the `oakcli start` commands.
7. Manage the virtual machine using the virtual machine console. See the `oakcli show vmconsole` command.

A driver domain is a user domain with special privileges. The Driver Domain functionality allows guest virtual machines to use ODA_BASE as the driver domain for access to virtual disks. By default, the driver domain functionality applies to non-system disks. Once a virtual machine is created in driver domain mode, any new vDisks are added in driver domain mode.

When a user domain is configured in driver domain mode, the storage in the `vm.cfg` file at DomU might be similar to the following:

```
vm.cfg: disk = [u'file:/OVS/Repositories/myreposeh1/.ACFS/snaps/v1_shared/
VirtualMachines/v1_shared/System.img,xvda,w', u'file:/u01/app/sharedrepo/
Repositories/myreposeh1/.ACFS/snaps/v1_shared/VirtualMachines/v1_shared/
u01.img,xvdb,w,oakDom1' ]
```

Note:

The second virtual disk is specified as a file on shared storage (in the shared repository) and it uses the ODA_BASE domain (`oakDom1`) as the driver domain.

4.3.2 Determining if the System is Configured with a Virtual Machine

Before deploying a Virtualized Platform on Oracle Database Appliance, determine if the system has the Virtualized OS ISO image.

Oracle Database Appliance ships from the factory with a bare metal ISO image installed. To use the virtualization features, the Virtualized OS ISO image must be on the system.

Perform the following steps if you need to re-image Oracle Database Appliance and install the Virtualization Platform ISO image:

1. Log in as `root`.
2. Enter the command `oakcli show env_hw`

```
[root@oda3 ~]# oakcli show env_hw
```

- If the output of the command is prefixed with the string `VM-ODA_BASE`, then the system is configured with a virtual machine (`dom0/oda_base`) and you do not need to install the virtualized image (ISO). For example, the output of the following command shows that the platform is configured with a virtual machine environment (`VM-ODA_BASE`) and identifies the hardware platform (`ODA X6-2-HA`):

```
[root@oda3n1 ~]# oakcli show env_hw VM-ODA_BASE ODA X6-2-HA
```

- If the output of the command is not prefixed with the string `VM-ODA_BASE`, then you must download the Virtualized OS ISO image.

```
[root@oda3n1 ~]# oakcli show env_hw ODA X6-2-HA
```

Related Topics

- [Installing a Virtualized Image](#) (page 4-11)
Reimage Oracle Database Appliance with a virtualized operating system image on both nodes and configure the initial public network.

4.3.3 Downloading Images for a Virtualized Platform

Download the Oracle Database Appliance Virtualized OS ISO Image and the VM Template on your local machine.

Oracle Database Appliance ships from the factory with a default OS image. Use the Oracle Database Appliance Virtualized OS ISO Image to re-image the Oracle Database Appliance for Virtualized Machine Restore.

1. From an external client machine, log on to My Oracle Support.
2. Download the Oracle Database Appliance 12.2.1.3.0 Virtualized OS ISO Image (Patch) and extract the files.
 - a. Locate patch 16186163 for the Oracle Database Appliance Virtualized OS ISO Image.
<https://updates.oracle.com/download/16186163.html>
 - b. Select the patch version for release 12.2.1.3.0.
 - c. Click **Download** to download the zip file onto your external client.

```
p16186163_122130_Linux-x86-64.zip
```

- d. Use either a Secure Copy (scp) command or a USB storage device to copy the ODA_BASE template from the external client to dom0 on Node 0. Use the /OVS directory as the target location.

 **Note:**

If you use a USB drive to transfer the file, then format it first as FAT32, ext3, or ext4. NTFS file formats are not supported.

- e. Extract the files.

```
# oakcli unpack -package /tmp/ p12999313_122130_Linux-x86-64.zip
```

3. Download the Oracle Database Appliance 12.2.1.3.0 (GI/RDBMS Clone) Template Download for a Virtualized Platform (Patch) and extract the files.

- a. Locate patch 16186172 for the Oracle Database Appliance Virtualized OS ISO Image.

<https://updates.oracle.com/download/16186172.html>

- b. Select the patch version for release 12.2.1.3.0.
- c. Click **View Read Me** and review the Readme file.
- d. Click **Download** to download the zip file.

```
p16186172_122130_Linux-x86-64.zip
```

Related Topics

- <https://updates.oracle.com/download/16186163.html>
- <https://updates.oracle.com/download/16186172.html>

4.3.4 Installing a Virtualized OS ISO Image

Reimage Oracle Database Appliance with a virtualized operating system image on both nodes and configure the initial public network.

Oracle Database Appliance ships from the factory with a default OS image. Use the Oracle Database Appliance Virtualized OS ISO Image to reimage the Oracle Database Appliance for Virtualized Machine Restore before deploying the Oracle Database Appliance Virtualized Platform Template.

 **WARNING:**

Oracle Database Appliance Virtualized OS image formats the local disks, which will result in loss of data that was previously stored on the Local and Shared storage. After re-install and deployment steps are completed, it might be necessary to restore data from backup.

Oracle Database Appliance ships with various components, including Oracle Integrated Lights Out Manager (ILOM) to help manage the system remotely. This procedure describes how to use ILOM to reimage the operating system; however, you

can choose to use Preboot Execution Environment (PXE) or other methods instead of ILOM.

When you reimage a new Oracle Database Appliance with the Virtualized OS ISO image, you must set up the initial network. The command `oakcli configure firstnet` runs an interactive script to create an initial network, which enables you to download the deployment software. Be prepared to provide IP addresses for Node0 and Node1 to configure the network interface. While not required, you also have the option to configure DHCP.

 **Note:**

Reimaging is node-specific. You must reimage both nodes. You can reimage both nodes at the same time.

Before reimaging the system, verify that the system is not already configured with a virtual machine.

Perform the following steps to reimage Oracle Database Appliance and install the Virtualized OS ISO image on both nodes and configure the initial network:

1. Download patch 16186163 for the Oracle Database Appliance 12.2.1.3.0 Virtualized OS ISO Image.
 - a. From an external client machine, log on to My Oracle Support.
 - b. Locate patch 16186163 for the Oracle Database Appliance Virtualized OS ISO Image.
<https://updates.oracle.com/download/16186163.html>
 - c. Select the patch version for release 12.2.1.3.0.
 - d. Click **Download** to download the zip file onto your external client.

```
p16186163_122130_Linux-x86-64.zip
```

- e. Use either a Secure Copy (`scp`) command or a USB storage device to copy the ODA_BASE template from the external client to `dom0` on Node0. Use the `/OVS` directory as the target location.

 **Note:**

If you use a USB drive to transfer the file, then format it first as FAT32, ext3, or ext4. NTFS file formats are not supported.

- f. Extract the files.

```
# oakcli unpack -package /tmp/ p12999313_122130_Linux-x86-64.zip
```

2. Open a browser and connect to Oracle Integrated Lights Out Manager (ILOM) on Node0 as root.

The Summary home page appears.

3. Launch the Remote Console.
 - a. Expand **Remote Control** in the left navigation.

- b. Click the **Redirection** tab.
- c. Click **Launch Remote Console**.

The state of the system determines what appears on the Console page.

4. Add the Virtualized OS ISO Image.
 - a. Click the **Devices** tab, then select **CD-ROM**.
A file browser on the local client opens.
 - b. Browse to the Oracle Database Appliance Virtualized OS ISO Image, highlight the image, then click **Open**.
5. Configure the CD-ROM as the next boot device.
 - a. Expand **Host Management** in the left menu of the ILOM Remote Console tab.
 - b. Click **Host Control**.
 - c. Select **CDROM** from the Next Boot Device menu, then click **Save**.
6. Power cycle the system.
 - a. Click **Power Control** in the **Host Management** menu.
 - b. Select **Power Cycle**.

When the node comes back after the power cycle, reimaging starts automatically.

It can take a couple of hours to reimage. The Running Post-Install scripts page is a static page and might give the impression that the reimaging process is not progressing. The post-install process during reimaging will wait until the synchronization between the partitions of the two mirrored local hard disks is complete, which can take 15 to 20 minutes to complete.

To check the progress of resynchronization, press the ALT-F2 key combination to open a second console and enter the following command:

```
# cat /proc/mdstat
```

When the resynchronization is complete, reimaging is completed and the machine restarts.

7. Repeat Steps 1 through 6 for Node1.
Reimaging is node-specific. You must reimage both nodes.
8. Verify that the host name in the Console is `oak1` for Node0 and `oak2` for Node1.
If the host name is something other than `oak1` or `oak2`, then reboot the node. You might need to reboot more than once.
Once the image is completed on **both** nodes, you will see the screen with `oak1` for Node0 (sc0).
9. Use the command `oakcli configure firstnet` to configure a global network using `bond0`.

The global configuration sets the initial public network for both the nodes on Oracle Database Appliance, enabling you to download the deployment software onto the appliance.

```
# oakcli configure firstnet
Configure the network for the node(s)(local, global) [global]:global
Select the interface to configure network on [bond0 bond1 bond2 xbond0]:bond0
Configure DHCP on bond0?(yes/no):no
INFO: Static configuration selected
```

- c. From the `/OVS` directory, use the `unzip` command to extract the files to create two files.

```
unzip p16186172_12.2.1.3.0_Linux-x86-64_1of2.zip
unzip p16186172_12.2.1.3.0_Linux-x86-64_2of2.zip
```

When extracted, you will have two files: `oda_base_template.tar.gz00` and `oda_base_template.tar.gz01`.

- d. Use the `cat` command to concatenate the files into a single file. The file name changes, depending on the version. Use the file name that is documented in the readme. For the purposes of this document, the file name is `myconfig-vm.gz`.

Make note of the file name. You will enter this file name and location in the next step.

 **Note:**

The file name changes between versions, ensure that you use the correct file name from the download. Do not change the file name.

3. Change to the `/opt/oracle/oak/bin/` directory and execute the command `oakcli deploy oda_base`. When prompted, provide the template location, core licensing options, and select the base domain memory allocation.

Select the core licensing that you need. If you select number six (6) in the Core Licensing Option, then 12 CPU cores are licensed on each node for a total of 24 cores.

When selecting the memory needed for the ODA_BASE, ensure that you select a sufficient amount of memory. The memory is used for the database.

The `deploy oda_base` option automatically deploys ODA_BASE on both nodes. If your ODA_BASE template is in the `/OVS` directory, then your deployment dialog should look similar to the following example (values, such as the number of available CPU cores, differ between Oracle Database Appliance Virtualized Platform hardware platforms):

```
# /opt/oracle/oak/bin/oakcli create vlan vl200 -vlanid 200 -if bond0
Created vlan vl200
```

```
# /opt/oracle/oak/bin/oakcli deploy oda_base
INFO: Validating LSI HBA PCI Cards on node 0
INFO: Validating LSI HBA PCI Cards on node 1
Enter the template location: /OVS/oda_base_12.2.1.3.0.tar.gz
Core Licensing Options:
  1. 2 CPU Cores
  2. 4 CPU Cores
  3. 6 CPU Cores
  4. 8 CPU Cores
  5. 10 CPU Cores
  6. 12 CPU Cores
  7. 14 CPU Cores
  8. 16 CPU Cores
  9. 18 CPU Cores
 10. 20 CPU Cores
Selection[1 .. 10](default 20 CPU Cores)          : 10
ODA base domain memory in GB(min 16, max 244)[default 244] :
```

```

INFO: Using default memory size i.e. 244 GB
Additional vlan networks to be assigned to oda_base ? (y/n) [n]:
INFO: Deployment in non local mode
INFO: Verifying active cores on local node
INFO: Verified active cores on local node
INFO: Verifying active cores on remote node
INFO: Verified active cores on remote node
INFO: Running the command to copy the template /OVS/ oda_base_12.2.1.3.0.tar.gz
to remote node 1
oda_base_12.2.1.3.0.tar.gz    100% 7475MB 62.8MB/s   01:59
INFO: Spawned the process 17728 in the deployment node 0
INFO: Spawned the process 17729 in the node 1
INFO: Validating LSI HBA PCI Cards on node 0
INFO: Validating LSI HBA PCI Cards on node 0
INFO: Validating LSI HBA PCI Cards on node 1
INFO: Validating LSI HBA PCI Cards on node 1
INFO: Deployment in local mode
INFO: Deployment in local mode
templateBuild-2017-02-14-23-51/swap.img
templateBuild-2017-02-14-23-51/swap.img
templateBuild-2017-02-14-23-51/System.img
templateBuild-2017-02-14-23-51/System.img
templateBuild-2017-02-14-23-51/u01.img
templateBuild-2017-02-14-23-51/u01.img
INFO: Extracted the image files on node 1
INFO: The VM Configuration data is written to /OVS/Repositories/odabaseRepo/
VirtualMachines/oakDom1/vm.cfg file
INFO: Running /sbin/losetup /dev/loop0 /OVS/Repositories/odabaseRepo/
VirtualMachines/oakDom1/System.img command to mount the image file
INFO: Mount is successfully completed on /dev/loop0
INFO: Extracted the image files on node 0
INFO: Validated dom0 and odabase version
INFO: Making change to the /OVS/Repositories/odabaseRepo/VirtualMachines/oakDom1
/tmpmnt/boot/grub/grub.conf file
INFO: Assigning IP to the second node...
INFO: The VM Configuration data is written to /OVS/Repositories/odabaseRepo/
VirtualMachines/oakDom1/vm.cfg file
INFO: Running /sbin/losetup /dev/loop0 /OVS/Repositories/odabaseRepo/
VirtualMachines/oakDom1/System.img command to mount the image file
INFO: Mount is successfully completed on /dev/loop0
INFO: Created oda base pool
INFO: Validated dom0 and odabase version
INFO: Making change to the /OVS/Repositories/odabaseRepo/VirtualMachines/oakDom1
/tmpmnt/boot/grub/grub.conf file
INFO: Assigning IP to the first node...
INFO: Created oda base pool
INFO: Starting ODA Base...
INFO: Starting ODA Base...
Using config file "/OVS/Repositories/odabaseRepo/VirtualMachines/oakDom1/vm.cfg"
.
Started domain oakDom1 (id=1)
INFO: Storing the odabase configuration information
Using config file "/OVS/Repositories/odabaseRepo/VirtualMachines/oakDom1/vm.cfg"
Started domain oakDom1 (id=1)
INFO: Storing the odabase configuration information
#

```

Continue configuration choices in the next step.

4. Assign additional virtual local area networks (VLANs) to your ODA_BASE.

To assign VLANs, respond with `y` when you are prompted for VLAN networks. Respond with `n` if you do not want to deploy another VLAN, or if you have completed assigning additional VLANs.

```
Additional vlan networks to be assigned to oda_base ? (y/n) : y
Select the network to assign [Test00,Test01,Test02,Test03]: Test00
Additional vlan networks to be assigned to oda_base ? (y/n) : y
Select the network to assign [Test00,Test01,Test02,Test03]: Test01
Additional vlan networks to be assigned to oda_base ? (y/n) : n
```

The ODA_BASE setup is complete.

5. Confirm that ODA_BASE is configured.

Verify that your deployment of ODA_BASE is valid by running the `oakcli show oda_base` command.

```
# /opt/oracle/oak/bin/oakcli show oda_base
ODA base domain
ODA base CPU cores      :2
ODA base domain memory :32
ODA base template       :/OVS/oda_base_12.2.1.3.0.tar.gz
ODA base vlans           :[ 'priv1', 'net1', 'net2' ]
ODA base current status :Running
```

Alternatively, you can run the `xm list` command to confirm that ODA_BASE is configured. When properly deployed, `oakDom1` appears in the output with your configured memory and vcpus.

```
# xm list
Name                               ID   Mem VCPUs   State   Time(s)
Domain-0                           0  4096   40    r----- 482672.4
oakDom1                             2 32768    4    -b---- 132134.6
```

Note:

If you encounter problems, then clean up the existing deployment before starting a new ODA_BASE deployment. Run the following command from `dom0` on Node 0 to remove ODA_BASE:

```
/opt/oracle/oak/tools/cleanOdabase.py
```

6. Validate that the cabling is connected correctly.

```
# oakcli validate -c storagetopology
```

The command displays errors if the cables between the two nodes and the storage shelf or shelves are not in the correct sockets.

Caution:

Do not ignore any errors or warnings in the output. If the cabling validation fails, connect the cables correctly and rerun the command until the command runs without any errors or warnings. Do not deploy Oracle Database Appliance until the cabling is correct.

If the output includes a warning for jbod nickname, then run the command from the first node `/opt/oracle/oak/bin/stordiag/Topology_Validation.sh -deploy` to correct the warning. Rerun the command again to verify that the command runs without the warning.

```
SUCCESS : Overall Cable Validation on Node1
WARNING : JBOD0 Nickname is incorrectly set to : Oracle Database Appliance - E1
WARNING : JBOD1 Nickname is incorrectly set to : Oracle Database Appliance - E0
INFO      : Above details can also be found in log
file=/tmp/StorageTopology-2015-05-13-15:03:36_29149_8856.log
```

7. Log in to ODA_BASE. Connect to ODA_BASE using vncviewer or vncsession using the `dom0` host name and port 5900.
 - a. Use a vnc viewer to connect to ODA_BASE using the `dom0` host name and port 5900.
 - b. Log in with the `root` user name and password.
8. Use the `oakcli configure firstnet` to configure an initial public network on the first node (Node 0) to complete the ODA_BASE deployment.
 - a. `ssh` to 192.168.16.27 from oak1-dom0
 - b. Log in as `root` user.
 - c. Run the `oakcli configure firstnet` command from the `/opt/oracle/oak/oakcli` directory.

```
# /opt/oracle/oak/oakcli configure firstnet
```

 **Note:**

Use the command `oakcli configure firstnetonly` once, to configure the initial network on Oracle Database Appliance. Using the command after configuring the initial network can cause unpredictable changes to your network settings.

- d. Enter the ODA_BASE (Node 0) network information.

The command uses an interactive script and prompts you for the information needed to configure the network. Enter values based on your environment requirements.

When prompted to configure the network nodes as `global` or `local`, select `global`. The default is `global`, which configures the network on both nodes. The `local` option only configures the network on the logged-on node.

Configure `net1` as the network interface.

```
# /opt/oracle/oak/bin/oakcli configure firstnet
Configure the network for the node(s)(local, global) [global]: global
The network configuration for both nodes:Domain Name: example.com
DNS Server(s): Primary Dns Server: <enter your primary DNS server>
                Secondary Dns Server: <enter your secondary DNS
server>
                Tertiary Dns Server: <enter your tertiary DNS server>
Node Name      Host Name
0              host1-dom0 <- odahostname1
1              host2-dom0 <- odahostname2
Choose the network interface to configure (net1, net2) [net1]: net1
```

```

Configure DHCP on net1 (yes/no) [no]:
You have chosen static configuration on net1
Enter the IP address for net1 on Node 0: 192.0.2.1
Enter the IP address for net1 on Node 1: 198.51.100.1
Netmask for net1: 255.255.252.0
Gateway Address for net1 [<Gateway IP>]: 192.0.0.1
Plumbing the IPs now on Node 0 ... INFO: Restarting the network now on Node 0 ...
.....
dom0.xml 100% 860 0.8KB/s 00:00
.....

```

The IP address is plumbed and the network is restarted on each node.

9. Deploy the Oracle Grid Infrastructure and Oracle Database software on the appliance.
 - a. Connect to ODA_BASE (Node 0) in the vncsession.
 - b. Navigate to the `/opt/oracle/oak/bin` directory and execute the `oakcli deploy` command.

```
# /opt/oracle/oak/bin/oakcli deploy
```

10. Validate the deployment by executing the `oakcli show version -detail` command on ODA_BASE (Node 0).

```
# /opt/oracle/oak/bin/oakcli show version -detail
```

Related Topics

- [Determining if the System is Configured with a Virtual Machine](#) (page 4-10)
Before deploying a Virtualized Platform on Oracle Database Appliance, determine if the system has the Virtualized OS ISO image.
- <https://updates.oracle.com/download/16186172.html>
- [oakcli deploy](#) (page 10-37)
Use the command `oakcli deploy` to deploy Oracle Grid Infrastructure for a cluster on Oracle Database Appliance.

5

Oracle Database Appliance Postinstallation Tasks

Complete these administrative tasks after you have deployed software, but before the system is operational.

- [Changing the Oracle Installation Owner Passwords](#) (page 5-1)
You must change the default administrative account passwords after installation to secure your system.
- [Changing the IPMI User Name and Password](#) (page 5-1)
If you completed a custom deployment and configured IPMI, then change the default user name and password.
- [Configuring Oracle Auto Service Request](#) (page 5-2)
Oracle Auto Service Request (Oracle ASR) is a secure support feature that automatically generates a service request for specific hardware faults.
- [Shutdown the VNC Server](#) (page 5-3)
After successfully deploying Oracle Database Appliance, shutdown your VNC server.

5.1 Changing the Oracle Installation Owner Passwords

You must change the default administrative account passwords after installation to secure your system.

During deployment, the `root` and database users `SYS`, `SYSTEM` and `PDBADMIN` are set to the master password. After deployment, the `oracle` and `grid` passwords are also set to the master password. Change the passwords to comply with your enterprise user security protocols.

Refer to the *Oracle Database Appliance Security Guide* and *Oracle Database Security Guide* for information about the required configuration and best practices to secure database systems.

5.2 Changing the IPMI User Name and Password

If you completed a custom deployment and configured IPMI, then change the default user name and password.

Oracle Clusterware supports the Intelligent Platform Management Interface (IPMI), an industry-standard protocol that can isolate a failed node from the rest of the cluster. IPMI can restart a problematic node without cooperation from either Oracle Clusterware or from the operating system.

Configuring IPMI is an option when performing a custom deployment of Oracle Database Appliance. Change the default user name and password using the following procedure:

1. Log in as the user `grid`.
2. Enter the command `crsctl set css ipmiadmin username`, where `username` is the new name for the IPMI administrator account. Provide a new password when prompted. You must enable IPMI version 1.5 first. For example:

```
$ ipmitool -I open sunoem cli "set /SP/services/ipmi v1_5_sessions=enabled"
$ /u01/app/12.1.0.2/grid/bin/crsctl set css ipmiadmin racadm
$ IPMI BMC password:CRS-4229: The IPMI information change was successful $
ipmitool -I open sunoem cli "set /SP/services/ipmi v1_5_sessions=disabled"
$ IPMI BMC password:
CRS-4229: The IPMI information change was successful
```

 **Caution:**

Do not change the default passwords until after you deploy software on Oracle Database Appliance. If you change the passwords before deployment completes, then you may encounter configuration errors.

5.3 Configuring Oracle Auto Service Request

Oracle Auto Service Request (Oracle ASR) is a secure support feature that automatically generates a service request for specific hardware faults.

Oracle ASR can improve system availability through expedited diagnostics and priority service request handling.

You can configure Oracle ASR on Oracle Database Appliance to use its own Oracle ASR Manager (**internal Oracle ASR**) or use Oracle ASR Manager configured on another server in the same network as your appliance (**external Oracle ASR**). If you already have Oracle ASR Manager configured in your environment, you can register Oracle Database Appliance with your existing Oracle ASR Manager.

 **Note:**

With an internal Oracle ASR Manager, an alert is not sent when the server goes down. An external Oracle ASR Manager is recommended because if a critical event occurs on Oracle Database Appliance with an external Oracle ASR Manager, an alert can still be sent to Oracle.

ASR uses ILOM telemetry sources to detect fault events on Oracle Database Appliance hardware. ILOM provides fault information, power and environmental, and CPU and memory fault information from the service processor.

To support Oracle ASR, your Oracle Database Appliance hardware must be associated with a Support Identifier (SI) in My Oracle Support.

You can configure Oracle ASR during initial deployment by choosing the Custom configuration option. You can also configure Oracle ASR after deployment (either Typical or Custom) using the `oakcli configure asr` command. The command prompts for input and, after you provide all of the required information, completes the Oracle ASR configuration.

An Oracle ASR configuration requires you to enter your My Oracle Support account user name and password. If a proxy server is required for Internet access to Oracle, then you must also provide the name of the proxy server. You can optionally configure Oracle ASR to use Simple Network Management Protocol (SNMP) Version 2 or SNMP Version 3.

To confirm that you have a working Oracle ASR configured, run the command `oakcli test asr`. Review your Oracle ASR configuration with the command `oakcli show asr`.

 **Note:**

For fault coverage details, see the Oracle ASR Fault Coverage for Engineered Systems: Oracle Database Appliance (ODA) document: http://docs.oracle.com/cd/E37710_01/doc.41/e55818/toc.htm

5.4 Shutdown the VNC Server

After successfully deploying Oracle Database Appliance, shutdown your VNC server.

As part of deploying Oracle Database Appliance, you used VNC.

- Shutdown the VNC server on the port on Node 0.

```
# vncserver -kill: 5901
```

6

Updating Oracle Database Appliance Software

To keep Oracle Database Appliance running with the latest software, check for and apply Oracle Database Appliance patch bundles when they are released.

- [About the Oracle Database Appliance Patch Bundle](#) (page 6-1)
All patching of Oracle Database Appliance is done using the quarterly Oracle Database Appliance Patch Bundle.
- [About Installing an Oracle Database Appliance Patch Bundle](#) (page 6-3)
Review local patching rules and an overview of how to patch an existing Oracle Database Appliance to the latest version.
- [Installing the Oracle Database Appliance Patch Bundle](#) (page 6-6)
Review these topics to prepare for and install the Oracle Database Appliance Patch Bundle.
- [Performing a Bare Metal Restore](#) (page 6-16)
Reimage Oracle Database Appliance to perform a bare metal restore of Oracle Database Appliance.

6.1 About the Oracle Database Appliance Patch Bundle

All patching of Oracle Database Appliance is done using the quarterly Oracle Database Appliance Patch Bundle.

The patch bundle provides all relevant patches for the entire system (bare metal or virtualized platform), including the following:

- BIOS
- Hardware drivers, Hardware Management Pack (HWM), and firmware drivers for various components
- Oracle Appliance Manager
- Oracle Linux
- Oracle VM
- Java Development Kit (JDK)
- Oracle Integrated Lights Out Manager (Oracle ILOM)
- Oracle Database Patch Set Update (PSU)
- Oracle Auto Service Request (Oracle ASR)
- Oracle Grid Infrastructure
 - Oracle Automatic Storage Management (Oracle ASM)
 - Oracle Automatic Storage Management Cluster File System (Oracle ACFS)
 - Oracle Trace File Analyzer

- Intelligent Platform Management Interface (IPMI)
- The patch bundle consists of three logical groups of patches.

Table 6-1 Patch Components and Purposes

Patch Component	Objects Patched
SERVER (<i>server</i>)	The SERVER component patch is mandatory. Updates the Oracle Linux operating system, Oracle ILOM, BIOS, Hardware Management Pack, IPMI, OAK, Oracle ASR, and local disks. For virtualized environment, the patch includes the Dom0 updates. The Server patch also includes Oracle Grid Infrastructure (GI) stack, including Oracle ASM, Oracle ACFS, and Oracle Trace File Analyzer.
STORAGE (<i>storage</i>)	The STORAGE component patch is recommended. Updates the shared storage disk firmware and Controller firmware for HDD, SSD, Controller, and Expander.
DATABASE (<i>database</i>)	The DATABASE component patch is optional. Updates the Oracle Database RDBMS stack.



Note:

Apply patch bundle components in this order:

1. SERVER (*server*)
2. STORAGE (*storage*)
3. DATABASE (*database*)

The SERVER component is required. The STORAGE component is recommended, and the DATABASE component is optional.

Oracle Database Appliance Patch Bundle Guidelines

You can carry out rolling upgrades with both the *server* and *DB* patches.

You must patch the *server* component before patching the *storage* and *DB* components. You can defer patching the *DB* component. You must schedule downtime and restart the system for the *storage* patch. However, you can usually defer running the storage patch until a scheduled maintenance window. Patching the *DB* component does not require system downtime.



Caution:

Apply the *server* patch before you apply the *storage* patch. Apply the *server* patch to each node before you apply any other patches. You must restart each server node after it is patched. The *server* patch restarts a server node. The *storage* patch restarts both nodes.

If you have Oracle Database running using High Availability options such as Oracle Real Application Clusters (RAC), then there is no downtime required while the patches are being installed. Oracle Appliance Manager verifies that the host meets all prerequisites to prevent you from installing patches in the wrong order. For example, you cannot install the `database` patch before you install the `server` patch. When applied, the output displayed by the patch process advises you if the patch is being installed on one or both nodes. For older patches that only install on a single node, you must run the command `oakcli update -patch` on the second node.

Supported and Recommended Versions

The *Oracle Database Appliance Release Notes* include information about the latest Oracle Database Appliance patch bundle and the supported versions for the components.

The minimum supported software version for Oracle Database Appliance X6-2-HA is 12.1.2.8.1. However, the recommended minimum version is 12.1.2.12.0 and Oracle Database 12.1.0.2.170814.

Caution:

If you have Oracle Database 11.2 or 12.1 that is using Oracle Automatic Storage Management (Oracle ASM) and you want to upgrade to a higher release of Oracle Database, then you must be on at least Oracle Database Appliance 12.1.2.12.0 and Database Home 12.1.0.2.170814. Known issues with Oracle Automatic Storage Management (Oracle ASM) on earlier versions are preventing the REDO diskgroup from mounting for databases.

Oracle recommends updating the appliance with the latest Oracle Database Appliance software version to take advantage of new features, fixes, and the latest supported component versions.

6.2 About Installing an Oracle Database Appliance Patch Bundle

Review local patching rules and an overview of how to patch an existing Oracle Database Appliance to the latest version.

To keep Oracle Database Appliance running with the latest software, check for and apply Oracle Database Appliance Patch Bundles when they are released. As well as offering new features, patches may improve the functionality of existing features.

Oracle Database Appliance Patch Bundles are released on a quarterly schedule.

▲ Caution:

Do not patch Oracle Database Appliance using individual patches for Oracle Grid Infrastructure, Oracle Database, or Oracle Linux. Also do not use individual infrastructure patches, such as firmware patches. You must only use Oracle Database Appliance patches.

If you use patches that are not intended for Oracle Database Appliance, or if you use Opatch, or a similar patching tool, then Oracle Database Appliance inventory is not updated, and you cannot complete future patch updates.

Local Patching Rules

Beginning with Oracle Database Appliance 12.1.2.7.0, you have the option to patch each server node independently. Use the `--local` flag during patching to patch the local node while the other node is up and running.

You must still apply the patch bundle in order, with the server being patched first. The following is the syntax with the `--local` flag for each component:

1. **Server (Infra + GI):** `oakcli update -patch version --server -local`
2. **Storage:** `oakcli update -patch version --storage`
3. **Database:** `oakcli update -patch version --database --local`

The `-local` parameter enables you to execute the patching commands from either node, in no particular order, unless otherwise noted. If the `--local` flag is not specified, then the patching is performed in a rolling manner.

The following are the rules for using the `--local` flag:

- **Server:** you can execute patching from Node 0 or Node 1, in any order.
- **Storage:** you **must** execute patching from Node 0.
- **Database:** you can execute patching from Node 0 or Node 1, in any order.

Overview of the Steps to Apply a Patch Upgrade

Before updating Oracle Database Appliance, verify that a database is successfully deployed on Oracle Database Appliance. Run the `oakcli orachk` command to confirm that the initial deployment completed successfully.

▲ Caution:

If you have Oracle Database 11.2 or 12.1 that is using Oracle Automatic Storage Management (Oracle ASM) and you want to upgrade to a higher release of Oracle Database, then you must be on at least Oracle Database Appliance 12.1.2.12.0 and Database Home 12.1.0.2.170814. Known issues with Oracle Automatic Storage Management (Oracle ASM) on earlier versions are preventing the REDO diskgroup from mounting for databases.

The upgrade path for Oracle Database 11.2 or 12.1 Oracle ASM is as follows:

- If you are on Oracle Database Appliance version 12.1.2.6.0 or later, then upgrade to 12.1.2.12 or higher before upgrading your database.
- If you are on Oracle Database Appliance version 12.1.2.5 or earlier, then upgrade to 12.1.2.6.0, and then upgrade again to 12.1.2.12 or higher before upgrading your database.

For all database versions and storage, if you are using Oracle Database Appliance version 12.1.2.5.0 or earlier, you must upgrade to 12.1.2.6.0 before upgrading to a higher version of Oracle Database Appliance. Changes introduced in the earlier release re-group the components and control the rolling of Oracle Database Appliance patching from one node to another.

All patching commands are executed as root user. At a high level, the patching process consists of the following steps:

1. Step 1: Download the Oracle Database Appliance Patch Bundle from My Oracle Support

```
https://updates.oracle.com/Orion/PatchDetails/process_form?
patch_num=27119652
```

2. Step 2: Copy and Unpack the Patch Bundle

On a bare metal environment, copy the patch bundle to Oracle Database Appliance (Node 0). On a virtualized environment, copy the patch bundle to ODA_Base (Dom1).

Unpack the bundle with the `oakcli unpack -package patch bundle name` command.

```
# oakcli unpack -package /tmp/p27119652_122130_Linux-x86-64_1of3.zip
# oakcli unpack -package /tmp/p27119652_122130_Linux-x86-64_2of3.zip
# oakcli unpack -package /tmp/p27119652_122130_Linux-x86-64_3of3.zip
```

3. Step 3: Validate Readiness for Patching and Verify Components that Require Patching

Use the `validate` command to validate your system before you start the patch upgrade.

```
# oakcli validate -c ospatch -ver 12.2.1.3.0
```

4. Step 4: Patch the Server

Use the `oakcli update` command to upgrade the server to the latest version. You can patch manually (`--local`) or automatically.

```
#!/opt/oracle/oak/bin/oakcli update -patch 12.2.1.3.0 --server --local
```

5. Step 5: (Recommended) Patch the Shared Storage now, or during a maintenance window.

Start the storage patching command on Node 0. The command patches storage for both nodes at the same time.

```
#!/opt/oracle/oak/bin/oakcli update -patch 12.2.1.3.0 --storage
```

6. Step 6: (Optional) Patch Oracle Database

Apply the Oracle Database Appliance Patch Bundle to update Oracle Database on Node 0 and Node 1.

```
# oakcli update -patch 12.2.1.3.0 --database
```

7. Step 7: Validate the Patch Update

Run the `oakcli show version -detail` command to verify that all components of the Oracle Database Appliance patch installation are updated.

```
# /opt/oracle/oak/bin/oakcli show version -detail
```

Related Topics

- [oakcli orachk](#) (page 10-46)
Use the `oakcli orachk` command to audit configuration settings with the ORAchk utility.

6.3 Installing the Oracle Database Appliance Patch Bundle

Review these topics to prepare for and install the Oracle Database Appliance Patch Bundle.

Topics:

- [Preparing to Install Oracle Database Appliance Patch Set Bundles](#) (page 6-7)
Decide how you want to patch Oracle Database Appliance.
- [Step 1: Download the Oracle Database Appliance Patch Bundle from My Oracle Support](#) (page 6-8)
Use this procedure to download the Oracle Database Appliance Patch Bundle.
- [Step 2: Copy and Unpack the Patch Bundle](#) (page 6-9)
Copy the patch to your server, and use `oakcli unpack -package` to unpack the patch bundle.
- [Step 3: Validate Readiness and Verify Components that Require Patching](#) (page 6-10)
Use command-line interface commands to check for any problems before you start the patch upgrade and to verify the components that require patching.
- [Step 4: Patch the Server](#) (page 6-12)
Use Oracle Appliance Manager (`oakcli update -patch`) to patch the server. You can use automatic (rolling) or manual patching.
- [Step 5: Patch the Shared Storage \(Optional\)](#) (page 6-14)
Use this procedure to patch the shared storage now, or during a maintenance window.

- [Step 6: Patch Oracle Database](#) (page 6-14)
Apply the Oracle Database Appliance Patch Bundle to update Oracle Database on Node 0 and Node 1.
- [Step 7: Validate the Patch Update](#) (page 6-15)
Run the command `oakcli show version -detail` to verify that all components of the Oracle Database Appliance patch installation are updated.

6.3.1 Preparing to Install Oracle Database Appliance Patch Set Bundles

Decide how you want to patch Oracle Database Appliance.

You can patch Oracle Database Appliance using either automatic rolling patching, or manual rolling patching. Review the steps for each procedure, and decide which option you want to use. For each option, the steps are the same, except for the server patch (Step 4).

For both options, the storage patch requires a system restart of Oracle Database Appliance after completing the storage patch update. However, you can defer the update to a maintenance window.

 **Note:**

You must patch the server before you patch the storage.

Automatic Rolling Patching Option

The advantage of automatic rolling patching is that it is simple to do, in that you start the patch, and the patch process completes automatically. However, services and clients may experience delays during node restarts.

Automatic rolling patching consists of the following steps:

1. Download the Oracle Database Appliance Patch Bundle from My Oracle Support.
2. Copy and unpack the patch bundle to Oracle Database Appliance.
3. Verify the components that require patching.
4. Patch the server.
5. (Optional) Patch the shared storage components. This patch requires a system restart, but you can usually defer the restart.
6. Patch Oracle Databases. No restart is required.
7. Validate the Oracle Database and Oracle Grid Infrastructure patch installation.

Manual Rolling Patching Option

The advantage of manual rolling patching is that you can first migrate the services and clients from one node to another before the node restarts, and then manually patch the second node. This migration can be more graceful than a failover, so it can minimize interruptions to ongoing transactions.

Manual rolling patching consists of the following steps:

1. Download the Oracle Database Appliance Patch Bundle from My Oracle Support.
2. Copy and unpack the patch bundle to both Oracle Database Appliance nodes.
3. Verify the components that require patching.
4. Patch the server. Complete the patch manually in a two-step process.
 - a. Log in to Node 0, and patch the server on Node 0 by running the `oakcli patch` command using the `--local` option.
 - b. Wait until the patch operation completes, and Node 0 is available.
 - c. Log in to Node 1, and patch the server on Node 1 by running the `oakcli patch` command using the `--local` option.
5. (Optional) Patch the shared storage. This patch requires a system restart, but you can usually defer the restart.
6. Patch Oracle Databases. No restart is required.
7. Validate the Oracle Database and Oracle Grid Infrastructure patch installation.

6.3.2 Step 1: Download the Oracle Database Appliance Patch Bundle from My Oracle Support

Use this procedure to download the Oracle Database Appliance Patch Bundle.

Caution:

If you have Oracle Database 11.2 or 12.1 that is using Oracle Automatic Storage Management (Oracle ASM) and you want to upgrade to a higher release of Oracle Database, then you must be on at least Oracle Database Appliance 12.1.2.12.0 and Database Home 12.1.0.2.170814. Known issues with Oracle Automatic Storage Management (Oracle ASM) on earlier versions are preventing the REDO diskgroup from mounting for databases.

The upgrade path for Oracle Database 11.2 or 12.1 Oracle ASM is as follows:

- If you are on Oracle Database Appliance version 12.1.2.6.0 or later, then upgrade to 12.1.2.12 or higher before upgrading your database.
- If you are on Oracle Database Appliance version 12.1.2.5 or earlier, then upgrade to 12.1.2.6.0, and then upgrade again to 12.1.2.12 or higher before upgrading your database.

For all database versions and storage, if you are using Oracle Database Appliance version 12.1.2.5.0 or earlier, you must upgrade to 12.1.2.6.0 before upgrading to a higher version of Oracle Database Appliance. Changes introduced in the earlier release re-group the components and control the rolling of Oracle Database Appliance patching from one node to another.

1. From an external client machine, log into My Oracle Support and locate patch 27648022 for the Oracle Database Appliance Patch Bundle for 12.2.1.3.0.

<https://support.oracle.com/>

2. Review the *Oracle Database Appliance Release Notes* for the available patches and for known issues.
3. Click **Download** for all files to obtain the complete Oracle Database Appliance Patch Bundle.

Either download it directly, or download it to a thumb drive, and copy the file to the server nodes using the thumb drive.

 **Caution:**

Only use either an Oracle Database Appliance Patch Bundle, or if you are an SAP customer, an SAP patch bundle downloaded from the SAP Service Marketplace. Do not patch Oracle Database Appliance using individual patches for Oracle Grid Infrastructure, Oracle Database, or Oracle Linux. Also do not use individual infrastructure patches, such as firmware patches. You must only use Oracle Database Appliance patches.

If you use patches that are not intended for Oracle Database Appliance, or if you use Opatch, or a similar patching tool, then Oracle Database Appliance inventory is not updated, and you cannot complete future patch updates.

6.3.3 Step 2: Copy and Unpack the Patch Bundle

Copy the patch to your server, and use `oakcli unpack -package` to unpack the patch bundle.

On Oracle Database Appliance systems, all patching commands are executed as `root` user.

After you copy the patch to the required location, run the command `oakcli unpack -package`. This command extracts (unzips) the patch bundle, and copies the patch bundle contents into the patch repository. Use the following syntax to specify the complete path to the patch bundle file, where *path* is the absolute path to the patch file:

```
# oakcli unpack -package absolute_package_name
```

 **Note:**

Before patching Oracle Database Appliance, verify that a database is successfully deployed on Oracle Database Appliance. Run the command `oakcli orachk` to confirm that the initial deployment completed successfully.

1. Log in as `root`.
2. Copy the patch files into a temporary directory (such as `/tmp`) on Oracle Database Appliance.
3. Unpack the patch bundle by executing the command `oakcli unpack -package patch bundle name`.

This command unzips and extracts the patch bundle and copies the contents into the patch repository. While unpacking, specify the complete path to the patch bundle file.

```
# oakcli unpack -package /tmp/p27119652_122130_Linux-x86-64_1of3.zip
# oakcli unpack -package /tmp/p27119652_122130_Linux-x86-64_2of3.zip
# oakcli unpack -package /tmp/p27119652_122130_Linux-x86-64_3of3.zip
```

6.3.4 Step 3: Validate Readiness and Verify Components that Require Patching

Use command-line interface commands to check for any problems before you start the patch upgrade and to verify the components that require patching.

Before installing the patch, run commands to verify that Oracle Database Appliance is ready to patch.

Use the `oakcli validate` command on Node 0 to identify any possible problems in your environment, such as missing dependencies or other conflicts that can cause issues with patch installation. Conflicts can be introduced if you customize the standard configuration. Several validation parameters are available.

To review the components that require patching, run the `oakcli update -patch release --verify` command. The output lists the components that require patching. If a component is listed as `Up-to-date` for the supported version that you indicate with the `-ver` flag, then that component does not require patching.

1. Run the `oakcli orachk` command to confirm that the initial deployment completed successfully.
2. Verify that a database is successfully deployed on Oracle Database Appliance.
3. Validate system readiness for patching.

Run the `oakcli validate` command on both nodes using the following syntax to validate your system.

```
# oakcli validate -c ospatch -ver 12.2.1.3.0
```

The output informs you if the patch can be installed on your environment. If the output from the command indicates that there is a problem (for example, if there are missing RPM dependencies on the server), then address the issue, and run `oakcli validate` again.

 **Note:**

These commands run only on the local node. Run the commands on both nodes to check both Oracle Database Appliance nodes.

4. (Optional) Run the `oakcli update -patch release --verify` command on Node 0 and Node 1 to view the proposed changes included in the patch.

When the Supported Version of a component is `Up-to-date` on the report, the existing version on the system is current and that component is not patched. For example, the patch upgrades the OAK component from Installed Version

12.1.2.9.0 to Proposed Version 12.1.2.10.0. For Component OL, the Installed Version is 6.8 and is Up-to-date.

```
# oakcli update -patch 12.1.2.10 --verify
```

```
INFO: 2017-02-13 14:20:37: Reading the metadata file now...
```

Patch Version	Component Name	Installed Version	Proposed
	Controller_INT	4.230.40-3739	Up-to-date
	Controller_EXT	09.00.00.00	10.00.00.00
	Expander	0291	Up-to-date
	SSD_SHARED {		
	[c2d20,c2d21,c2d22,c2d23]	A29A	Up-to-date
	[c2d0,c2d1,c2d2,c2d3,c2d4, c2d5,c2d6,c2d3,c2d4,c2d5, c2d6,c2d7,c2d8,c2d9,c2d10, c2d11,c2d12,c2d13,c2d14, c2d15,c2d16,c2d17,c2d18, c2d19]	A29A	Up-to-date
	}		
	SSD_LOCAL	0R3Q	Up-to-date
	ILOM	3.2.7.26.a r112632	3.2.8.24 r114611
	BIOS	38050100	38070000
	IPMI	1.8.12.4	Up-to-date
	HMP	2.3.5.2.5	2.3.5.2.8
	OAK	12.1.2.9.0	12.1.2.10.0
	OL	6.8	Up-to-date
	GI_HOME	12.1.0.2.161018(2400 6101,23854735)	12.1.0.2.170117(2473 2082,24828633)
	DB_HOME	12.1.0.2.160719(2305 4246,23054327)	12.1.0.2.170117(2473 2082,24828633)
	ASR	5.5.1	Up-to-date

Related Topics

- [oakcli orachk](#) (page 10-46)
Use the `oakcli orachk` command to audit configuration settings with the ORAchk utility.
- [oakcli validate](#) (page 10-79)
Validates the state of an Oracle Database Appliance or the viability of an operating system patch.
- [oakcli update](#) (page 10-75)
Use the `oakcli update` command to apply Oracle Database Appliance patches.

6.3.5 Step 4: Patch the Server

Use Oracle Appliance Manager (`oakcli update -patch`) to patch the server. You can use automatic (rolling) or manual patching.

Caution:

If you have Oracle Database 11.2 or 12.1 that is using Oracle Automatic Storage Management (Oracle ASM) and you want to upgrade to a higher release of Oracle Database, then you must be on at least Oracle Database Appliance 12.1.2.12.0 and Database Home 12.1.0.2.170814. Known issues with Oracle Automatic Storage Management (Oracle ASM) on earlier versions are preventing the REDO diskgroup from mounting for databases.

The upgrade path for Oracle Database 11.2 or 12.1 Oracle ASM is as follows:

- If you are on Oracle Database Appliance version 12.1.2.6.0 or later, then upgrade to 12.1.2.12 or higher before upgrading your database.
- If you are on Oracle Database Appliance version 12.1.2.5 or earlier, then upgrade to 12.1.2.6.0, and then upgrade again to 12.1.2.12 or higher before upgrading your database.

For all database versions and storage, if you are using Oracle Database Appliance version 12.1.2.5.0 or earlier, you must upgrade to 12.1.2.6.0 before upgrading to a higher version of Oracle Database Appliance. Changes introduced in the earlier release re-group the components and control the rolling of Oracle Database Appliance patching from one node to another.

Before patching, download the Oracle Database Appliance Patch Bundle from My Oracle Support, copy the patch to both nodes and unpack the bundles. Oracle recommends running commands to validate readiness for patching.

Note:

Before patching Oracle Database Appliance, verify that a database is successfully deployed on Oracle Database Appliance. Run the `oakcli orachk` command to confirm that the initial deployment completed successfully.

Automatic Server Patch Procedure

The automatic server patching process is a rolling upgrade that automatically patches Node 0 after patching Node 1. This automatic procedure enables Oracle Grid Infrastructure to continue to be up and running on one of the nodes during patching.

1. Download the Oracle Database Appliance server patch bundle from My Oracle Support to Node 0.
2. Log in to Node 0 as the root user.

3. Run the command `oakcli update -patch version --server`, where *version* is the Patch Bundle version. Either patch automatically or locally.

```
#!/opt/oracle/oak/bin/oakcli update -patch 12.2.1.3.0 --server
```

This command patches the server on Node 1. After that patch update is complete, it then automatically patches Node 0

4. Observe the patch status reports.

As the patch runs, it displays output that advises you of the installation progress. Part of the server patch update requires node 1 to be restarted, then node 0 to be restarted. Wait until Node 0 shuts down and completes restarting before proceeding to the next step.

Manual Server Patch Procedure

You can manually control patching the nodes. The manual server patching process requires you to log in to a node and run Oracle Appliance Manager (oakcli) using a local node server patch update. After you complete the patch procedure on the first node, log into the second node, and patch the second node.

1. Download the Oracle Database Appliance server patch bundle from My Oracle Support to Node 0.
2. Log in to Node 0 as the root user.
3. Run the Oracle Appliance Manager command `oakcli update -patch version --server --local`, where *version* is the Patch Bundle version.

```
#!/opt/oracle/oak/bin/oakcli update -patch 12.2.1.3.0 --server --local
```

The Oracle Appliance Manager command carries out the patch on Node 0. As the patch runs, it displays output that advises you of the installation progress.

4. Oracle Appliance Manager prompts you to restart the node. Restart the node, and wait until Node 0 shuts down and completes restarting before proceeding to the next step.
5. Log out of Node 0, and log in to Node 1 as the root user.
6. Run Oracle Appliance Manager on Node 1 using the `--local` flag to patch the server.

For example:

```
#!/opt/oracle/oak/bin/oakcli update -patch 12.2.1.3.0 --server --local
```

7. Oracle Appliance Manager prompts you to restart the node. Restart the node, and wait until Node 0 shuts down and completes restarting.

When both servers are patched and restarted, proceed to the next step.

Related Topics

- [oakcli orachk](#) (page 10-46)
Use the `oakcli orachk` command to audit configuration settings with the ORAchk utility.
- [oakcli update](#) (page 10-75)
Use the `oakcli update` command to apply Oracle Database Appliance patches.

6.3.6 Step 5: Patch the Shared Storage (Optional)

Use this procedure to patch the shared storage now, or during a maintenance window.

Patching the storage requires downtime when shared components are being patched and might require rebooting the nodes.

The storage patch updates shared storage, including the Controller (`Control_EXT`), SSD (`SSD_SHARE`), HDD (`HDD_SHARE`), and Expander. While not required, Oracle recommends patching storage.

Do not apply the storage patch until the server is successfully patched on both nodes.

Before patching, run the command `oakcli update -patch release --verify`, where `release` is the Patch Bundle version, and review the output:

- If "Up-to-date" appears in the Proposed Patch Version for the `Control_EXT`, `SSD_SHARE`, and `HDD_SHARE` storage components, then you do not need to apply the storage patch.
- If any of the storage components require updating, then stop the Oracle stack on both nodes before patching.

Start the storage patching command only on the first node (Node 0). The command patches storage for both nodes at the same time.

1. Log into Node 0 as the root user.
2. Stop the shared repository on both nodes by running the command `oakcli stop repo repo_name`, where `repo_name` is the name of the shared repository being patched.

```
#!/opt/oracle/oak/bin/oakcli stop repo shared_repol
```
3. Run the command `oakcli update -patch version --storage`, where `version` is the Patch Bundle version.

For example, run the following command to patch storage to release 12.1.2.12.0.

```
#!/opt/oracle/oak/bin/oakcli update -patch 12.1.2.12.0 --storage
```

The storage patch runs, and automatically installs itself on both nodes. The output displayed by the patch process advises you of the installation progress. If you are running this step in sequence, then wait for the patch to complete before proceeding to the next step.

If a failure occurs, then you can restart the patching process by reissuing the same command.

4. Start the shared repository on both nodes by running the command `oakcli start repo repo_name`, where `repo_name` is the name of the shared repository being patched.

```
#!/opt/oracle/oak/bin/oakcli start repo shared_repol
```

6.3.7 Step 6: Patch Oracle Database

Apply the Oracle Database Appliance Patch Bundle to update Oracle Database on Node 0 and Node 1.

1. Run the command `oakcli show databases` on Node 0.

For example:

```
#oakcli show databases
```

Name	Type	Storage	HomeName	HomeLocation	Version
db1	RAC	ASM	OraDb12102_home1	/u01/app/oracle/product/12.1.0.2/dbhome_1	12.1.0.5.0(20831110,20831110)
db2	SINGLE	ASM	OraDb12102_home2	/u01/app/oracle/product/12.1.0.2/dbhome_2	12.1.0.2.160119(21948354,21948344)
db3	RACOneNode	ASM	OraDb12102_home3	/u01/app/oracle/product/12.1.0.2/dbhome_3	12.1.0.5.0(20831110,20831110)
db4	RAC	ASM	OraDb12102_home4	/u01/app/oracle/product/12.1.0.2/dbhome_4	12.1.0.2.160119(21948354,21948344)

 **Note:**

You cannot perform individual database updates for databases running in the same home. All databases running in the homes that you update are patched to the Oracle Database 12c release 1 patch for Oracle Database Appliance (12.1.0.2.180116). For Oracle Database 11.2, the database is patched to 11.2.0.4.180116.

2. Run the `oakcli update -patch version --database` command, on Node 0 only. The command automatically patches both nodes. If you have more than one database home that can be patched, then the software provides a selection list. You can select, one, a set, or all of the Oracle Database homes to upgrade.

```
# oakcli update -patch 12.2.1.3.0 --database
```

3. After the update command completes on both nodes, run the command `oakcli show databases` on Node 0 to verify that the database version is updated.

```
#oakcli show databases
```

6.3.8 Step 7: Validate the Patch Update

Run the command `oakcli show version -detail` to verify that all components of the Oracle Database Appliance patch installation are updated.

When you apply the patch and then run the command `oakcli show version -detail`, the output shows the installed version and that the supported versions are Up-to-date. If you unpack the patch bundle (`oakcli unpack -pack`) and then run the command `oakcli show version -detail` before applying the patch, the output shows that the supported versions are No-update.

To confirm that your Oracle Grid Infrastructure and Oracle Database software components are updated, run the following command:

```
# /opt/oracle/oak/bin/oakcli show version -detail
```

```
Mon May 23 03:31:48 PST 2017
Reading the metadata. It takes a while...
System Version  Component Name  Installed Version  Supported Version
-----
12.2.1.3.0
Controller_INT  4.650.00-7176  Up-to-date
Controller_EXT  13.00.00.00  Up-to-date
Expander        0291  Up-to-date
SSD_SHARED {
```

```

[ c2d20,c2d21,c2d22,      A29A      Up-to-date
c2d23 ]
[ c2d0,c2d1,c2d2,c2d     A29A      Up-to-date
3,c2d4,c2d5,c2d6,c2d
7,c2d8,c2d9,c2d10,c2
d11,c2d12,c2d13,c2d1
4,c2d15,c2d16,c2d17,
c2d18,c2d19 ]
}

SSD_LOCAL      A29A      Up-to-date
ILOM            3.2.9.23 r116695  Up-to-date
BIOS            38070200      Up-to-date
IPMI            1.8.12.4      Up-to-date
HMP             2.4.1.0.9    Up-to-date
OAK             12.2.1.3.0  Up-to-date
OL              6.9      Up-to-date
GI_HOME        12.1.0.2.170418(2400  Up-to-date
6101,23854735)
DB_HOME        12.1.0.2.170418(2305  Up-to-date
4246,23054327)

```

6.4 Performing a Bare Metal Restore

Reimage Oracle Database Appliance to perform a bare metal restore of Oracle Database Appliance.

- [About Performing a Bare Metal Restore](#) (page 6-16)
Bare metal operating system (OS) re-imaging installs Oracle Database Appliance operating system software on the local (boot) drive.
- [Downloading an ISO Image for Bare Metal Restore](#) (page 6-17)
Download the Oracle Database Appliance Bare Metal ISO image on your local machine.
- [Re-imaging Oracle Database Appliance](#) (page 6-17)
Re-image Oracle Database Appliance to perform a bare metal restore of Oracle Database Appliance.

6.4.1 About Performing a Bare Metal Restore

Bare metal operating system (OS) re-imaging installs Oracle Database Appliance operating system software on the local (boot) drive.

Bare Metal is a non-virtualized Oracle Database Appliance configuration. Oracle Database Appliance ships from the factory with a bare metal configuration, default ISO image and Appliance Manager installed.

Use the OS ISO Image to restore the OS to the "shipped from factory" state. Use only when necessary. Reimaging does not patch the firmware or update the component

versions, it only re-images the local system disk from an OS perspective. After imaging is completed, redeploy the End User image, then restore from backup, as needed.

The following are some of the reasons that you might want to reimage to perform a bare metal restore:

- Deploy Bare Metal with latest Oracle Database Appliance software.
In some cases, the Oracle Database Appliance machine is shipped from the factory with an earlier release of Oracle Database Appliance software. To deploy the machine with the latest software, you can perform an update or you can reimage the machine.
- Roll back to an earlier version of Oracle Database Appliance software.
Re-imaging with older release of Oracle Database Appliance software does not rollback the firmware version.

Use the Oracle Integrated Lights Out Manager (ILOM) interface to reimage the Oracle Database Appliance node.

6.4.2 Downloading an ISO Image for Bare Metal Restore

Download the Oracle Database Appliance Bare Metal ISO image on your local machine.

Download patch 12999313 for the Oracle Database Appliance Bare Metal ISO Image to prepare for a bare metal restore for Oracle Database Appliance.

1. Log into My Oracle Support.
2. Download the Oracle Database Appliance 12.2.1.3.0 Bare Metal ISO Image and extract the files.
 - a. Locate patch 12999313 for the Oracle Database Appliance Bare Metal ISO Image.

<https://updates.oracle.com/download/12999313.html>

- b. Select the patch version for release 12.2.1.3.0.

- c. Click **Download** to download the zip file.

p12999313_122130_Linux-x86-64.zip

- d. Extract the files.

```
#unzip p12999313_122130_Linux-x86-64.zip
```

Related Topics

- <https://updates.oracle.com/download/12999313.html>

6.4.3 Re-imaging Oracle Database Appliance

Re-image Oracle Database Appliance to perform a bare metal restore of Oracle Database Appliance.

Bare metal restore uses Oracle Integrated Lights Out Manager (ILOM) to reimage the Oracle Database Appliance node. For Oracle Database Appliance models earlier than X5-2, go to My Oracle Support and locate MOS Note 1373599.1.

 **Note:**

Bare metal OS re-imaging is specific to the node on which the procedure is executed and overwrites the local storage (operating system) on that node. You must reimage both nodes.

 **Note:**

To use Oracle Database Appliance Virtualized Platform, you must reimage Oracle Database Appliance with the virtualized VM ISO image and the VM Template instead of the OS ISO image.

Newer ILOM versions require that the Java client be on `jre-7-linux-i586.rpm` or higher to be able to launch the remote console.

Download the Oracle Database Appliance Bare Metal ISO image to your local machine before you launch the ILOM console.

1. Open a browser and connect to Oracle Integrated Lights Out Manager (ILOM) on Node 0 as root.
2. Launch the Remote Console.
 - a. Expand **Remote Control** in the left navigation.
 - b. Click the **Redirection** tab.
 - c. Click **Launch** for the Remote Console in the Actions menu.

The state of the system determines what appears on the Console page.
3. Add the image.
 - a. Click the **KVMS** tab, then select **Storage**.
 - b. Click **Add**.
 - c. Browse to the Oracle Database Appliance Bare Metal ISO Image, highlight the image, then click **Select**.
 - d. Click **Connect**.

The mounting of the ISO image is successful when the **Connect** button changes to a **Disconnect** button.
 - e. Click **OK**

The CD-ROM icon in the top right corner is highlighted.
4. Configure the CD-ROM as the next boot device.
 - a. Expand **Host Management** in the left menu of the ILOM Remote Console tab.
 - b. Click **Host Control**.
 - c. Select **CDROM** from the Next Boot Device menu, then click **Save**.
5. Power cycle the node.
 - a. Click **Power Control** in the **Host Management** menu.
 - b. Select **Power Cycle** , then click **Save**.

When the node comes back after the power cycle, re-imaging starts automatically. The Oracle Linux page appears, followed by the Running Post-Install scripts page.

The Running Post-Install scripts page is a static page and might give the impression that the reimaging process is not progressing. The post-install process during reimaging will wait until the synchronization between the partitions of the two mirrored local hard disks is complete, which can take 15 to 20 minutes to complete.

To check the progress of resynchronization, press the ALT-F2 key combination to open a second console and enter the following command:

```
# cat /proc/mdstat
```

When the resynchronization is complete, re-imaging is completed and the machine restarts.

6. Repeat the procedure for Node 1.

Reimaging is node specific. You must reimage both nodes.

7. After re-imaging both nodes, verify that the installed version and supported version are up-to-date for each component on Oracle Database Appliance.

```
# /opt/oracle/oak/bin/oakcli show version -detail
```

8. If components are not up-to-date, update the components to the latest version.

Related Topics

- [Downloading an ISO Image for Bare Metal Restore](#) (page 6-17)
Download the Oracle Database Appliance Bare Metal ISO image on your local machine.
- [Installing a Virtualized OS ISO Image](#) (page 4-11)
Reimage Oracle Database Appliance with a virtualized operating system image on both nodes and configure the initial public network.

7

Managing Oracle Database on Oracle Database Appliance

This chapter describes how to create and manage databases on Oracle Database Appliance. It also covers how to use Oracle Database Appliance solid-state drives (SSDs) and how to update and upgrade Oracle Database on Oracle Database Appliance.

Topics:

- [About the Oracle Database Appliance OAKCLI Utility](#) (page 7-1)
Manage and maintain Oracle Database Appliance components using the Oracle Appliance Manager Command-Line Utility (OAKCLI).
- [Oracle Database Features and Oracle Database Appliance](#) (page 7-2)
Review the Oracle Database features that are available with Oracle Database Appliance.
- [Creating and Converting Databases with OAKCLI](#) (page 7-5)
Use the Oracle Appliance Manager Command Line Interface (OAKCLI) to create and manage databases on Oracle Database Appliance.
- [About Managing Multiple Databases on Oracle Database Appliance](#) (page 7-8)
Review this topic to understand Oracle requirements for multiple Oracle home support.
- [About Managing Multiple Database Instances Using Instance Caging](#) (page 7-10)
Use instance caging to manage your system resources on Oracle Database Appliance.
- [How to Upgrade and Update the Oracle Database on Oracle Database Appliance](#) (page 7-11)
Review the information in these topics to select the procedure for upgrading and updating your Oracle Database release.

7.1 About the Oracle Database Appliance OAKCLI Utility

Manage and maintain Oracle Database Appliance components using the Oracle Appliance Manager Command-Line Utility (OAKCLI).

Oracle Database Appliance provides its own command-line tool, OAKCLI, to manage all components on the system. Use OAKCLI commands for the following tasks:

- Create, upgrade, and patch databases
- Create and upgrade Oracle homes
- Create and modify database creation parameter files

Many tasks related to managing Oracle Databases are also required with databases on Oracle Database Appliance. Tasks common to Oracle Database generally are described in the Oracle Database documentation library. However, to simplify database creation and related tasks, use the OAKCLI utility. The OAKCLI utility

combines the capabilities of the SYS database administrator role and the operating system Superuser (`root` user). Always perform administrative tasks using the OAKCLI utility.

▲ Caution:

Do not use Oracle Database Configuration Assistant (DBCA) to create databases on Oracle Database Appliance. Only use Oracle Appliance Manager for database configuration. Deploying Oracle Database instances using Oracle Appliance Manager ensures that these databases are properly configured, optimized, and supported on Oracle Database Appliance.

7.2 Oracle Database Features and Oracle Database Appliance

Review the Oracle Database features that are available with Oracle Database Appliance.

Topics:

- [Data Migration and Management and Oracle Database Appliance](#) (page 7-2)
Oracle Database Appliance supports the use of standard Oracle Database loading and migration tools.
- [Oracle Clusterware and Oracle Database Appliance](#) (page 7-3)
Oracle Clusterware provides the clustering infrastructure for Oracle Database Appliance.
- [Oracle RAC One Node and Oracle Database Appliance](#) (page 7-3)
Oracle RAC One Node is available with Oracle Database Appliance.
- [Oracle Real Application Clusters and Oracle Database Appliance](#) (page 7-3)
Oracle Database Appliance supports administrator-managed Oracle RAC Databases.
- [Administrative Groups and Users on Oracle Database Appliance](#) (page 7-4)
Oracle Database Appliance configuration creates operating system groups and users whose members are granted system administration privileges on the appliance.

7.2.1 Data Migration and Management and Oracle Database Appliance

Oracle Database Appliance supports the use of standard Oracle Database loading and migration tools.

If you are loading data or migrating data from an existing database to Oracle Database Appliance, then you can use the standard Oracle Database loading and migration tools. These tools include the following:

- Oracle GoldenGate
- SQL*Loader

- Oracle Data Pump
- transportable tablespaces
- RMAN

You can also use the RMAN utility to back up and recover databases on Oracle Database Appliance.

7.2.2 Oracle Clusterware and Oracle Database Appliance

Oracle Clusterware provides the clustering infrastructure for Oracle Database Appliance.

Oracle Clusterware provides the cluster technology required for Oracle Real Application Clusters (Oracle RAC). In addition, Oracle Clusterware manages applications and processes as resources that you register with Oracle Clusterware, to provide high availability services. The number of resources that you register with Oracle Clusterware to manage an application depends on the application. Applications that consist of only one process are usually represented by only one resource. More complex applications that use multiple processes or components can require multiple resources to maintain high availability.

Related Topics

- [Making Applications Highly Available Using Oracle Clusterware](#)

7.2.3 Oracle RAC One Node and Oracle Database Appliance

Oracle RAC One Node is available with Oracle Database Appliance.

Oracle Real Application Clusters One Node (Oracle RAC One Node) is a single instance of an Oracle RAC database that runs on one node in a cluster. Instead of stopping and starting instances, you can use the Oracle RAC One Node online database relocation feature to relocate an Oracle RAC One Node instance to another server.

Administration of Oracle RAC One Node databases on Oracle Database Appliance is different from administering Oracle RAC or single-instance Oracle Databases. For Oracle RAC One Node databases, one node is the primary node, and the other node is a candidate node, which is available to accommodate services if the primary node fails, or is shut down for maintenance. The nodes, Oracle Databases, and database services reside in the generic server pool.

Related Topics

- [Administering Oracle RAC One Node](#)

7.2.4 Oracle Real Application Clusters and Oracle Database Appliance

Oracle Database Appliance supports administrator-managed Oracle RAC Databases.

Oracle Real Application Clusters (Oracle RAC) provides technology that links two or more individual computers so that they function as one system. Oracle RAC deployed on Oracle Database Appliance enables each node to share access to a database. If one node fails or is taken offline, then the other node continues operating and the entire Oracle RAC database remains available.

Oracle Database Appliance currently supports only administrator-managed databases, where the database administrator allocates each instance of the database to a specific node in the cluster. Oracle Database Appliance does not support Policy-managed databases, where the database administrator defines the number of database instances required, but not the nodes where they run.

When you review the database resource for an administrator-managed database, you see a server pool defined with the same name as the Oracle Database. This server pool is part of a special Oracle-defined server pool, called the Generic server pool. The Generic server pool stores any server that is not in a top-level server pool and is not policy managed. Servers that host administrator-managed databases are statically assigned to the Generic server pool. Oracle RAC manages the Generic server pool to support administrator-managed databases. You cannot use SRVCTL or Oracle Clusterware Control (CRSCTL) utility commands to modify the Generic server pool.

7.2.5 Administrative Groups and Users on Oracle Database Appliance

Oracle Database Appliance configuration creates operating system groups and users whose members are granted system administration privileges on the appliance.

During configuration, two administrative accounts are created for Oracle Database Appliance: the user `grid`, with a user ID (UID) of 1000, and the user `oracle`, with a UID of 1001. The user `grid` is the Oracle Grid Infrastructure installation owner. The user `oracle` is the Oracle Database installation owner, and the owner of all Oracle Database homes (Oracle homes). By default, these users are members of operating system groups whose members are granted privileges to start up and administer Oracle Database and Oracle Automatic Storage Management.

The following table describes the Oracle system privileges groups, and information about the operating system authentication groups:

Table 7-1 Operating System Groups and Users on Oracle Database Appliance

Oracle System Privileges	Group Name	Group ID (GID)	<i>grid</i> is a member	<i>oracle</i> is a member
Oracle Inventory group (OINSTALL)	<code>oinstall</code>	1001	yes (primary group)	yes (primary group)
OSDBA group	<code>dba</code>	1002	no	yes
OSOPER for Oracle RAC group	<code>racoper</code>	1003	yes	yes
OSDBA for ASM group	<code>asmdba</code>	1004	yes	yes
OSOPER for ASM group	<code>asmoper</code>	1005	yes	no
OSASM Group for Oracle ASM	<code>asmadmin</code>	1006	yes	no

If you create an initial database during deployment, then the password for the `sys` and `SYSTEM` users is the same. Change this password for both users as soon as possible after configuration to prevent unauthorized access to your database using these privileged accounts.

7.3 Creating and Converting Databases with OAKCLI

Use the Oracle Appliance Manager Command Line Interface (OAKCLI) to create and manage databases on Oracle Database Appliance.

Topics:

- [About Creating Databases with OAKCLI Commands](#) (page 7-5)
Create additional Oracle Databases using the Oracle Appliance Manager Command-Line Utility (OAKCLI) to ensure that your database is configured optimally for Oracle Database Appliance.
- [Creating, Using, and Removing Database Configuration Files with OAKCLI](#) (page 7-6)
You can use OAKCLI to create and use configuration files to deploy databases on Oracle Database Appliance. Also use OAKCLI to remove unwanted configuration files.
- [Creating Snapshot Databases With OAKCLI](#) (page 7-7)
You can use OAKCLI to create snapshot databases.
- [About Converting Single-Instance Databases to Oracle RAC or Oracle RAC One Node](#) (page 7-8)
Oracle provides utilities to enable you to convert your existing single-instance databases to Oracle Real Application Clusters or Oracle RAC One Node databases.

7.3.1 About Creating Databases with OAKCLI Commands

Create additional Oracle Databases using the Oracle Appliance Manager Command-Line Utility (OAKCLI) to ensure that your database is configured optimally for Oracle Database Appliance.

OAKCLI assists you to deploy Oracle Databases that follow Optimal Flexible Architecture guidelines. The Optimal Flexible Architecture standard provides best practices configurations to help to ensure database deployments that are easier to support and maintain. Optimal Flexible Architecture includes the following

- Structured organization of directories and files, and consistent naming for critical database files, such as control files, redo log files, and other critical files, which simplifies database administration.
- Separation of tablespace contents to minimize tablespace free space fragmentation, and maximize administrative flexibility
- Stripe and Mirror Everything (SAME) deployment, which safeguards against database failures

Refer to "Optimal Flexible Architecture" in *Oracle Database Installation Guide for Linux* for more information about Optimal Flexible Architecture.

Start the OAKCLI utility by using the command `oakcli create database` to create additional databases on Oracle Database Appliance.

When you run this command, respond to each prompt by entering the number that corresponds with the option you want to apply to your database. When a default is supplied, and the default is the value you want to use (typically shown as option 1),

click Enter to accept that value. When there are many options, and the value you want is not displayed, press 0 to show all of the options.

Related Topics

- [Optimal Flexible Architecture](#)

7.3.2 Creating, Using, and Removing Database Configuration Files with OAKCLI

You can use OAKCLI to create and use configuration files to deploy databases on Oracle Database Appliance. Also use OAKCLI to remove unwanted configuration files.

Use the Oracle Appliance Manager Command-Line Utility (OAKCLI) `ommand` option `oakcli create db_config_params` to create a configuration file that you can use to configure multiple Oracle Database deployments. The command uses the following syntax, where `params_file` is the name of the configuration file that you want to create:

```
oakcli create db_config_params params_file
```

When you run `oakcli create db_config_params`, you are prompted to select one of a set of available parameter setting options to use in the configuration file. Respond to each prompt by entering the number that corresponds to the configuration that you want to use to set up your databases. If there is a default value, and you want to use this value (typically option **1**), then press **Enter** to accept that value. If there are many options, then you may need to select option **0** to show all of the available parameter options.

To see your existing database configuration files, use the command `oakcli show db_config_params` command. For example

```
# oakcli show db_config_params
Available DB configuration files are:
default
eurodbs
4kblockdbs
mytest.params
```

Configuration files using the default extension `.dbconf` do not show the extension in this command output. Oracle recommends that you use this default file extension to simplify file management. If you create a configuration file that does not use the `.dbconf` default extension, then the nondefault extension is shown as part of the output of `oakcli show db_config_params`.

To use a database configuration file to create a single Oracle Database, or to use the command to create many Oracle Database instances with the identical profile, use the following command syntax, where `db_name` is the name of the database that you want to create, and `params_file` is the name of the parameter configuration file that you want to use to configure the database:

```
oakcli create database -db db_name -params params_file
```

For example, this command creates the database named `myxldb`, using the parameter configuration file `myxldb.dbconf`:

```
oakcli create database -db myxldb -params myxldb.dbconf
```

After you have completed using configuration files, you can delete files that you do not plan to use again.

Remove unwanted database configuration files using the following command syntax, where *params_file* is the name of the parameter configuration file that you want to delete:

```
oakcli delete db_config_params params_file
```

As with other Oracle Database Appliance Manager commands related to database configuration files, you do not need to include the parameter configuration filename extension if your file has the default extension value, which is `.dbconf`.

7.3.3 Creating Snapshot Databases With OAKCLI

You can use OAKCLI to create snapshot databases.

An Oracle snapshot database is created by taking a snapshot of the Oracle ASM Cluster File System (Oracle ACFS) where the source data files reside. The source database can be a single instance, Oracle RAC, or Oracle RAC One Node. Compared to other methods of creating copies of databases, snapshot databases require less time and storage space and involve no downtime of the source database. Additionally, you can create any database type and class from any other type and class. For example, you can create an Oracle RAC database from an Oracle RAC One Node database. Similarly, you can create a database that is different in size than the source database.

On Oracle Database Appliance, you can create snapshot databases from any Oracle Database instance stored on Oracle ACFS. You can create snapshot databases with Oracle Database 11g release 2 (11.2.0.4) or later databases created or upgraded on the system.

Snapshot database candidates must meet the following requirements:

- They must not be a standby or container database
- They must not be running in read-only mode, or in restricted mode, or in online backup mode
- They must be in ARCHIVELOG mode
- They must have all defined data files available and online
- They must not use centralized wallets with Transparent Data Encryption.
- They must be deployed in ACFS storage

Also, ensure that the system clocks on the two Oracle Database Appliance nodes are synchronized before you create a snapshot database. If the clocks are significantly different, then the command can fail.

To create a snapshot database, use the command `oakcli create snapshotdb`. The following example creates a snapshot database named `snapprod` from the database named `prod`.

```
oakcli create snapshotdb -db snapprod -from prod
```

 **Caution:**

Oracle Database Appliance does not support centralized wallets with Transparent Data Encryption. Recovery of encrypted data may fail in the snapshot database if the source database relies on an external, centralized wallet.

7.3.4 About Converting Single-Instance Databases to Oracle RAC or Oracle RAC One Node

Oracle provides utilities to enable you to convert your existing single-instance databases to Oracle Real Application Clusters or Oracle RAC One Node databases.

Use the procedures for converting your single-instance database as described in *Oracle Real Application Clusters Administration and Deployment Guide*. You can convert a single-instance database either to Oracle Real Application Clusters (Oracle RAC), or to Oracle RAC One Node.

For example, you can use RCONFIG to convert your single instance Oracle Database.

Open the template file `ConvertToRAC_AdminManaged.xml`, and modify it as required for your migration, in accordance with the instructions in the file. Then save the file with a new filename. The information you provide determines how your converted database is configured. The template file is located in the following path:

```
$ORACLE_HOME/sampleXMLs/ConvertToRAC_AdminManaged.xml
```

Refer to the section "Converting Single-Instance Oracle Databases to Oracle RAC and Oracle RAC One Node" in *Oracle Real Application Clusters Installation and Configuration Guide* for more information.

7.4 About Managing Multiple Databases on Oracle Database Appliance

Review this topic to understand Oracle requirements for multiple Oracle home support.

The Oracle home is the directory in which you install Oracle Database binaries, and from which Oracle Database runs. Use Oracle Appliance Manager OAKCLI commands to create and manage multiple Oracle homes and databases on Oracle Database Appliance. Oracle Database Appliance Manager automatically creates an Oracle Database Oracle home that is compliant with Oracle's Optimal Flexible Architecture (OFA) standards.

Oracle Database Appliance supports multiple Oracle homes, including support of different release Oracle Database homes. Check the related `readme` files or the Release Notes to obtain information about the specific Oracle software releases supported for your Oracle Database Appliance platform.

When you use OAKCLI commands to create multiple homes on Oracle Database Appliance, the commands start the Oracle Grid Infrastructure cloning process. In Oracle Database Appliance deployments, the user `oracle` is the software installation owner account that owns the Oracle homes.

 **Note:**

If you are not upgrading from an earlier release, then download the Oracle Database Appliance End-User Bundle for the Oracle Database version that you want to install.

Use OAKCLI commands to create, manage, patch, and upgrade multiple databases on Oracle Database Appliance. The command `oakcli create database` enables you to create a database with minimal user input. When you run this command without any additional options, the command creates a new database home. You can also create a database in an existing home by running the command `oakcli create database -oh oracle_home`, where `oracle_home` is the Oracle home in which you want to create the Oracle Database.

 **Caution:**

Do not apply Oracle Database patches directly to Oracle Databases on Oracle Database Appliance. Only use Oracle Database Appliance patch bundles, which are tested to work across the whole software stack.

Only use `oakcli` commands to create new databases in either existing Oracle homes, or in new Oracle homes.

- [Downloading an End-User RDBMS Clone File](#) (page 7-9)
Download an Oracle Database Appliance End-User RDBMS Clone file onto your local machine to create a new database home.

Related Topics

- [Downloading an ISO Image for Bare Metal Restore](#) (page 6-17)
Download the Oracle Database Appliance Bare Metal ISO image on your local machine.
- [Installing a Virtualized OS ISO Image](#) (page 4-11)
Reimage Oracle Database Appliance with a virtualized operating system image on both nodes and configure the initial public network.

7.4.1 Downloading an End-User RDBMS Clone File

Download an Oracle Database Appliance End-User RDBMS Clone file onto your local machine to create a new database home.

This software clone file contains the Oracle Database software images for Oracle Database Appliance X6-2-HA.

There are no base clone files for 12.1.0.2.170117 or 11.2.0.4.161018. In an environment patched to at least Oracle Database Appliance 12.1.2.10.0, you can update the existing database to 12.1.0.2.170117, or 11.2.0.4.161018.

Perform the following steps to create new dbhomes for these releases:

1. Download 12.1.0.2.170117, or 11.2.0.4.161018 clone file.
2. Unpack the clone file with the command `oakcli unpack -package`.

3. Create a new dbhome for 12.1.0.2.170117 or 11.2.0.4.161018.

```
# oakcli create dbhome -version <version_number>
```

4. Create the databases for the new dbhome.

Before you transfer these files to Oracle Database Appliance, complete the hardware setup and configure the public network interface on Oracle Database Appliance.

1. From an external client machine, log on to My Oracle Support.
2. Select the Oracle Database Appliance End-User RDBMS Clone file (Patch) for the supported Oracle Database version.
 - 12.1.0.2.170117: Patch 19520042. Select **12.1.2.10.0** from the Release drop down box.
 - 11.2.0.4.161018: Patch 17770873. Select **12.1.2.9.0** from the Release drop down box.
3. Click **Download** to download the zip file onto your external client.
4. Use either a Secure Copy (scp) command or a USB storage device to copy the file from the external client to `dom0` on Node 0. Use the `/OVS` directory as the target location.

 **Note:**

If you use a USB drive to transfer the file, then format it first as FAT32, ext3, or ext4. NTFS file formats are not supported.

5. When you extract the files, use the command `oakcli unpack -package`.

Related Topics

- <https://updates.oracle.com/download/19520042.html>
- <https://updates.oracle.com/download/17770873.html>

7.5 About Managing Multiple Database Instances Using Instance Caging

Use instance caging to manage your system resources on Oracle Database Appliance.

Oracle Database provides a method for managing CPU allocations on a multi-CPU server that runs multiple database instances. This method is called instance caging. Instance caging uses an initialization parameter to limit the number of CPUs that an instance can use simultaneously.

Instance caging and Oracle Database Resource Manager (the Resource Manager) work together to support your desired service levels across multiple instances. Consolidation can minimize idle resources, maximize efficiency, and lower costs.

Oracle Database Appliance templates are already tuned for the size of each database instance workload. They are designed to run on a specific number of cores. Instance caging ensures that each database workload is restricted to the set of cores allocated by the template, enabling multiple databases to run concurrently with no performance

degradation, up to the capacity of Oracle Database Appliance. You can select database template sizes larger than your current needs to provide for planned growth.

 **Note:**

Oracle strongly recommends that you use the Oracle Database Appliance templates, because they implement best practices and are configured specifically for Oracle Database Appliance.

The Oracle Database Appliance Manager interface refers to the database sizing templates as database classes.

By default, instance caging is not enabled on Oracle Database Appliance. To enable instance caging, set the initialization parameter, `RESOURCE_MANAGER_PLAN`, for each database on Oracle Database Appliance. The parameter specifies the plan to be used by the Resource Manager for the current instance. Setting this parameter directs the Resource Manager to allocate core resources among databases. If a plan is not specified with this parameter, then the Resource Manager and instance caging are not enabled.

Instance caging allocation of core resources is enabled in accordance with the Oracle Database Appliance database template size that you select for each database. The `CPU_COUNT` initialization parameter is set in the template. Use the `CPU_COUNT` setting that matches the size of each database to consolidate, and follow the standard instructions for configuring instance caging.

7.6 How to Upgrade and Update the Oracle Database on Oracle Database Appliance

Review the information in these topics to select the procedure for upgrading and updating your Oracle Database release.

Topics:

- [About Oracle Database Upgrades and Updates on Oracle Database Appliance](#) (page 7-12)
Use Oracle Database Appliance bundles to upgrade or update Oracle Database instances, as well as other components and features of Oracle Database Appliance.
- [Updating to Oracle Database 12.1.0.2.161018 from Previous Oracle Database 12.1.0.2.x Releases](#) (page 7-12)
Use this example to understand steps required to update Oracle Database 12c release 1 (12.1) releases on Oracle Database Appliance.
- [Upgrading to Oracle Database 12.1.x from Oracle Database 11.2.0.4.x Releases](#) (page 7-13)
Use this example to understand steps required to update Oracle Database 12c release 1 (12.1) releases on Oracle Database Appliance.

- [Upgrading to Oracle Database 11.2.0.4.161018 from Oracle Database 11.2.0.4.x Releases](#) (page 7-16)
Use this example to understand steps required to upgrade Oracle Database 11g release 2 (11.2) releases on Oracle Database Appliance.

7.6.1 About Oracle Database Upgrades and Updates on Oracle Database Appliance

Use Oracle Database Appliance bundles to upgrade or update Oracle Database instances, as well as other components and features of Oracle Database Appliance.

Oracle Database Appliance upgrades and updates use specially developed Oracle Database Appliance patch bundles. Only use these patch bundles to perform upgrades and updates on Oracle Database Appliance.

Use the appropriate Oracle Database Appliance patch bundle for your appliance. Typically, Oracle recommends that you use the latest Oracle Database Appliance patch bundle.

Oracle Database Appliance patch bundles can include updates and upgrades to Oracle Database software, and updates and upgrades to other components of Oracle Database Appliance, including updates to Infrastructure (*infra*) and Grid Infrastructure (*gi*) components.

For information about Oracle Database Appliance Patch Bundles, known issues, and workarounds, see the *Oracle Database Appliance Release Notes*.

Related Topics

- [Oracle Database Appliance X6-2-HA Patches](#)

7.6.2 Updating to Oracle Database 12.1.0.2.161018 from Previous Oracle Database 12.1.0.2.x Releases

Use this example to understand steps required to update Oracle Database 12c release 1 (12.1) releases on Oracle Database Appliance.

You use Oracle Appliance Manager (OAKCLI) to update Oracle Database installations. In this scenario, you have updated two databases to Oracle Database 12c release 1 12.1.0.2.161018 when you ran the Oracle Database Appliance 12.1.2.6 Patch Bundle, but you have not updated two other Oracle Database instances that are patched at Oracle Database 12c release 1 (12.1.0.2.4). This procedure describes how to update databases manually after the patch bundle.

The Oracle Database Appliance Patch Bundle for Oracle Database uses a new numbering sequence. The Oracle Database update for Oracle Database Appliance Patch Bundle 12.1.2.6 is 12.1.0.2.161018.

1. Run the command `oakcli show databases` on Node 0 only. Review the output of this command to confirm that you have databases with the appropriate release number for this update.

The following example shows that there are four databases, db1, db2, db3, and db4:

```
# oakcli show databases
```

Name	Type	Storage	HomeName	HomeLocation	Version
db1	RAC	ACFS	OraDb12102_home1	/u01/app/oracle/product/12.1.0.2/dbhome_1	12.1.0.2.4(20831110,20831110)

```
db2 SINGLE ACFS OraDb12102_home2 /u01/app/oracle/product/12.1.0.2/dbhome_2 12.1.0.2.4(20831110,20831110)
db3 RACOneNode ACFS OraDb12102_home3 /u01/app/oracle/product/12.1.0.2/dbhome_3 12.1.0.2.160119(21948354,21948344)
db4 RAC ACFS OraDb12102_home4 /u01/app/oracle/product/12.1.0.2/dbhome_4 12.1.0.2.160119(21948354,21948344)
```

Note:

In this example, the databases are in separate Oracle home locations. This option provides the ability to update individual databases, but requires more administration and storage allocation. Databases in separate homes must be updated individually.

Databases in the same database home require less storage allocation, and can be updated as a group. However, you cannot update individual databases in a shared Oracle database home location.

2. Run the command `oakcli update -patch 12.1.2.9.0 --database` on Node 0 only. When you run this command without specifying a database or a database home, the command automatically patches both nodes.

If you have more than one database home that is a candidate for patching, then the command displays a selection list from which you can pick one, some, or all of the candidate database homes that you want to update.

3. After the update command completes running, run the command `oakcli show databases` on Node 0 again.

The command and output should now look similar to the following example:

```
# oakcli show databases

Name Type      Storage HomeName      HomeLocation      Version
-----
db1 RAC          ACFS  OraDb12102_home1 /u01/app/oracle/product/12.1.0.2/dbhome_1 12.1.0.2.161018(24927502,24340679)
db2 SINGLE      ACFS  OraDb12102_home2 /u01/app/oracle/product/12.1.0.2/dbhome_2 12.1.0.2.161018(24927502,24340679)
db3 RACOneNode ACFS  OraDb12102_home3 /u01/app/oracle/product/12.1.0.2/dbhome_3 12.1.0.2.161018(24927502,24340679)
db4 RAC          ACFS  OraDb12102_home4 /u01/app/oracle/product/12.1.0.2/dbhome_4 12.1.0.2.161018(24927502,24340679)
```

The Oracle Database instances `db1` and `db2` are now updated to 12.1.0.2.161018.

7.6.3 Upgrading to Oracle Database 12.1.x from Oracle Database 11.2.0.4.x Releases

Use this example to understand steps required to update Oracle Database 12c release 1 (12.1) releases on Oracle Database Appliance.

You use Oracle Appliance Manager (OAKCLI) to update Oracle Database installations. In this scenario, you are upgrading Oracle Database to a higher version, from 11g release 1 (11.2.0.4.170418) to 12c release 1 (12.1.0.2.170418).

While the target home in this example does show an existing database, having a database in the target home is not required. However, for debugging purposes it is recommended to create the target home with a sample RAC database to confirm the target binaries and home on both nodes work as expected. You can remove the RAC database after confirming the database functions as expected on each node. This example includes the steps for collecting diagnostics to review after a successful or failed upgrade.

 **Note:**

Do not use manual database creation scripts, DBCA, or DBUA to upgrade your databases in Oracle Database Appliance. Instead, use the patches provided by Oracle Database Appliance to create and update your databases.

The existing database and database home, and the target database home must all be created using the Oracle Appliance Manager (oakcli) create commands and you must be a root user to upgrade the database.

1. Run the command `oakcli show dbhomes -detail` on Node 0 only.

Review the output of this command to confirm that you have databases with the appropriate release number for this update. The following example shows that there are two databases, db1 and db2

```
[root@oda-n0 ~] # oakcli show dbhomes -detail
Oracle Home Name          Oracle Home Version      Oracle Home
Location                  Database Name           Database Type
-----
OraDb11204_home1         11.2.0.4.170418(24732075,23054319)  /u01/app/oracle/product/11.2.0.4/
dbhome_1                db1                      RAC
OraDb12102_home1         12.1.0.2.170418(25171037,25942196)  /u01/app/oracle/product/12.1.0.2/
dbhome_1                db2                      RAC
```

2. Set the ENV for the database home to be upgraded from *source_home*.
 - a. Open the environment for the database home to be upgraded. This example is updating the database named db1 in Oracle Home OraDb11204_home1.

```
# # . oraenv
```

- b. Choose the Oracle SID = *database to be upgraded*

```
ORACLE_SID = [root] ? db1
```

You are now in the source home for the database to be upgraded.

```
...The Oracle base has been set to /u01/app/oracle...
[root@oda-n0 ~]#
```

3. Use the `oakcli upgrade database` command to upgrade the database from the current database home to the target database home.

In this example, we are upgrading db1 from OraDb11204_home1 to OraDb12102_home1.

```
[root@oda-n0 ~]# oakcli upgrade database -db db1 -from OraDb11204_home1 -to
OraDb12102_home1
```

4. Review the output of the log file created by the `oakcli upgrade database` command.

```
INFO: 2017...07:23: Look at the log file '/opt/oracle/oak/log/oda0/tools/
12.1.2.11.0/dbupgrade_16203.log' for more details
```

```
Please enter the 'SYS' password :
Please re-enter the 'SYS' password:
INFO: 2017...07:52: Upgrading the database 11204. It will take few minutes.
Please wait...
...
```

```
...
SUCCESS: 2017...22:21: Successfully upgraded the database db1
```

Time to completion varies, depending on a number of factors, including the differences between the source version and target version.

When the log file shows that the database is successfully upgraded, you can run a couple of checks to confirm the database upgrade.

5. (Optional) Confirm the database upgrade.

- a. Run the command `oakcli show databases` on Node 0 and confirm that the database appears in the new home.

In this example, we are upgrading `db1` from `OraDb11204_home1` to `OraDb12102_home1`.

```
[root@oda-n0 ~]# oakcli upgrade database -db db1 -from OraDb11204_home1 -to OraDb12102_home1
```

- b. Log into `SQLPLUS>` as user `ORACLE` on the upgraded database to confirm that the upgrade scripts have been executed.

```
# su - oracle
[oracle@oda-n0 bin]$ export ORACLE_HOME=/u01/app/oracle/product/12.1.0.2/dbhome_1/
[oracle@oda-n0 bin]$ sqlplus
```

```
SQL*Plus: Release 12.1.0.2.0 Production on Mon ... 2017
Copyright (c) 1982, 2014, Oracle. All rights reserved.
```

```
Enter user-name: / as sysdba
Connected to: Oracle Database 12c Enterprise Edition Release 12.1.0.2.0 -
64bit Production
With the Partitioning, Real Application Clusters, OLAP, Advanced Analytics
and Real Application Testing options
```

```
SQL> col comp_name format a34
SQL> col status format a7
```

```
SQL> select comp_name,status, version from dba_registry;
COMP_NAME                                STATUS    VERSION
-----
Oracle XML Database                      VALID    12.1.0.2.0
Oracle Workspace Manager                 VALID    12.1.0.2.0
Oracle Database Catalog Views            VALID    12.1.0.2.0
Oracle Database Packages and Types       VALID    12.1.0.2.0
Oracle Real Application Clusters          VALID    12.1.0.2.0
```

```
SQL> select count(*) from dba_objects where status = 'INVALID';    -- Check
for invalids and compile as needed
```

If this is an Oracle RAC database, repeat this step on the second node (Node 1). If the checks are valid, the database is upgraded.

If the checks are not valid or if there are any problems or failures during a database upgrade, submit a Service Request ticket and include the following information:

- Log file created by the `oakcli upgrade database` command in Step 4.
- All commands in clear text from setting the database home and `. oraenv` through the upgrade steps.

- Oracle Trace File Analyzer (TFA) or `oakcli manage diagcollect` output from before the upgrade through the upgrade to completion or failure.

7.6.4 Upgrading to Oracle Database 11.2.0.4.161018 from Oracle Database 11.2.0.4.x Releases

Use this example to understand steps required to upgrade Oracle Database 11g release 2 (11.2) releases on Oracle Database Appliance.

You use Oracle Appliance Manager (OAKCLI) to upgrade Oracle Database installations. In this scenario, you have upgraded the Oracle Database Appliance infrastructure and Oracle Grid Infrastructure to Oracle Database Appliance Patch Bundle 12.1.2.6, but you have not upgraded Oracle Database installations. This procedure describes how to upgrade Oracle Database 11g release 2 (11.2) databases.

The Oracle Database Appliance Patch Bundle upgrade for Oracle Database uses a new numbering sequence. The Oracle Database upgrade for Oracle Database Appliance Patch Bundle 11.1.2.9 is 11.2.0.4.161018.

Before you start this procedure, you must complete the following tasks:

- Completed running the Oracle Database Appliance 12.1.2.6 Patch Bundle for infrastructure and Oracle Grid Infrastructure.
- Configured at least one Oracle Database Appliance database home for release 11.2.0.4.161018.

You configure an Oracle Database home using Oracle Appliance Manager, either as part of your patch bundle update initially, or as a manual procedure using the command `oakcli create dbhome`. You can run multiple Oracle Database instances on one Oracle Database home, to save storage space and obtain greater ease of management, or you can run Oracle Database instances in individual Oracle Database homes, for greater flexibility.

You must always have an Oracle Database Appliance database home for the database release to which you want to upgrade. In a new 12.1.2.9 deployment, a new 11.2.0.4.161018 Oracle Database home is set up for you automatically. If you are updating from an earlier release, then you must create at least one 11.2.0.4.161018 Oracle Database home manually using `oakcli create dbhome`.

1. If necessary, download the 11.2.0.4.161018 RDBMS Clone Patch from My Oracle Support, and create an Oracle Database home on Node 0 for Oracle Database release 11.2.0.4.161018.

For example:

```
# /opt/oracle/oak/bin/oakcli create dbhome -version 11.2.0.4.161018
```

2. Run the command `oakcli show dbhomes`.

The output appears similar to the following example:

Oracle HomeName Type	Oracle Home Version	Oracle HomeLocation	Database Name	Database
-----	-----	-----	-----	
Oradb11204_home1	11.2.0.4.7(20760997,17592127)	/u01/app/oracle/product/11.2.0.4/dbhome_1 db1		RAC

3. Run the command `oakcli show databases` on Node 0 only. Review the output of this command to confirm that you have databases with the appropriate release number for this upgrade.

The following example shows that there is one database, `db1`, which is a database that is not an upgraded from release 11.2.0.4, and that is patched to a level from which you can upgrade (11.2.0.4.7):

```
# oakcli show databases
```

Name	Type	Storage	HomeName	HomeLocation	Version
db1	RAC	ACFS	OraDb11204_home1	/u01/app/oracle/product/11.2.0.4/dbhome_1	11.2.0.4.7(20760997,17592127)

4. Upgrade databases by running the command `oakcli upgrade database` on Node 0.

Run the command on Node 0 only. Provide names of databases that you want to upgrade, and provide names of database homes where you want the upgraded databases placed. Run the command with the following options, where *database* is the name of the database that you want to upgrade, and *dbhome* is the name of the Oracle home where you want the upgraded database to be placed:

```
oakcli upgrade database -db database -to dbhome
```

The following example shows how to upgrade the database `db1` identified in step 3 as an upgrade candidate, and how to place the upgraded database in the new database home, `OraDb12102_home2`, which is also identified in step 3:

```
# oakcli upgrade database -db db1 -to dbhome12102_home2.
```

5. After the upgrade command completes running, run the command `oakcli show databases` on Node 0 again.

The command and output should now look similar to the following example:

```
# oakcli show databases
```

Name	Type	Storage	HomeName	HomeLocation	Version
db1	RAC	ACFS	OraDb12102_home2	/u01/app/oracle/product/12.1.0.2/dbhome_1	11.2.0.4.161018(24927502,24340679)

The database `db1` is now in release 11.2.0.4, and the database home name is now `OraDB12102_home2`, which is in the path `/u01/app/oracle/product/11.2.0.4/OraDb12102_home2`.

8

Managing Storage

You can add storage to fully populate the base storage shelf and add a storage expansion shelf to your Oracle Database Appliance.

Topics:

- [About Managing Storage](#) (page 8-1)
You can add storage at any time without shutting down your databases or applications.
- [Preparing for a Storage Upgrade](#) (page 8-2)
Review and perform these best practices before adding storage to the base shelf or adding the expansion shelf.
- [Adding the 10-Pack of SSDs](#) (page 8-4)
Add the 10-pack solid-state drives (SSDs) for data storage into the existing base configuration to fully populate the base storage shelf.
- [Adding the Storage Expansion Shelf](#) (page 8-6)
After the base storage shelf is fully populated, you can add the storage expansion shelf to expand your data storage.

8.1 About Managing Storage

You can add storage at any time without shutting down your databases or applications.

Oracle Database Appliance uses raw storage to protect data in the following ways:

- Flash or Fast Recovery Area (FRA) backup. Flash or fast recovery area is a storage area (directory on disk or Oracle ASM diskgroup) that contains redo logs, control file, archived logs, backup pieces and copies, and flashback logs.
- Mirroring. Double or triple mirroring provides protection against mechanical issues.

The amount of available storage is determined by the location of the FRA backup (external or internal) and if double or triple mirroring is used.

Oracle Database Appliance uses storage shelves, a base shelf and an optional storage expansion shelf. You can expand the base storage by adding a pack of solid-state drives (SSDs) to fully populate the base storage. You can further expand the storage by adding a second storage shelf. External NFS storage is supported for online backups, data staging, or additional database files.

Note:

You must fully populate the base storage shelf before adding the expansion shelf.

When you add storage, Oracle Automatic Storage Management (Oracle ASM) automatically rebalances the data across all of the storage including the new drives. Rebalancing a disk group moves data between disks to ensure that every file is evenly spread across all of the disks in a disk group and all of the disks are evenly filled to the same percentage. Oracle ASM automatically initiates a rebalance after storage configuration changes, such as when you add disks.

About Expanding Storage

If you need additional storage after fully populating the base shelf, you can add a storage expansion shelf. The expansion shelf is hot-pluggable, enabling you to expand storage without database downtime. After cabling and powering up the expansion shelf, the system automatically configures Oracle ASM storage and data is automatically distributed to the new shelf.

Note:

The process of rebalancing the data might impact performance until the new storage is correctly balanced across all drives. If possible, add a storage expansion shelf during a non-peak or non-production time period to minimize the performance impact of the automatic storage balancing.

The addition of the storage expansion shelf includes checks across both nodes. It is important to confirm that SSH does work across the nodes and all users can connect as expected using their shared password.

The following are the high level steps to expand storage:

1. Review the Oracle Database Appliance storage options.
2. Prepare for a storage upgrade by running checks to verify that the configuration is ready before adding storage to the base shelf or adding the expansion shelf.
3. Add storage if the base configuration is not full.
4. Add the storage expansion shelf, then log in to each server node and validate the cabling. After you confirm that the cabling is correct, power on the shelf and validate the storage.

Caution:

Review cabling instructions carefully to ensure that you have carried out cabling correctly. Incorrect connections can cause data loss when adding a storage expansion shelf to Oracle Database Appliance with existing databases.

8.2 Preparing for a Storage Upgrade

Review and perform these best practices before adding storage to the base shelf or adding the expansion shelf.

1. Update Oracle Database Appliance to the latest Patch Bundle before expanding storage.
2. Confirm both nodes are at the same version and patch bundle level for software and firmware.

```
# oakcli show version -detail

#oakcli inventory -q
```

 **Note:**
 If `oakd` is not running on either node, fix the problem before adding storage.

3. Check the disk health of the existing storage disks.

Run the check on both nodes and use the default checks option to check the NetworkComponents, OSDiskStorage, SharedStorage, and SystemComponents.

```
# oakcli validate -d
```

4. Run the `oakcli show diskgroup` command on each node to display and review Oracle Automatic Storage Management (Oracle ASM) disk group information.

```
# oakcli show diskgroup data

# oakcli show diskgroup reco

# oakcli show diskgroup redo
```

5. Confirm Oracle ASM and CRS health on both nodes.

Run the `oakcli orachk` command on each node. If there is a problem connecting to either node, then check the `/etc/bashrc` file and remove (or remark out) any values in the profile for `root`; `oracle`; `grid` users

Run `oakcli orachk` on Node 0:

```
# oakcli orachk
...

Checking Status of Oracle Software Stack - Clusterware, ASM, RDBMS

. . . . .
-----
Oracle Stack Status
-----
Host Name CRS Installed ASM HOME RDBMS Installed CRS UP ASM UP RDBMS UP DB Instance Name
-----
odax3rml Yes No Yes No No No No .....
-----

...

```

Run `oakcli orachk` on Node 1:

```
# oakcli orachk
...

Checking Status of Oracle Software Stack - Clusterware, ASM, RDBMS

. . . . .
-----
Oracle Stack Status
-----
```

```
Host Name CRS Installed ASM HOME RDBMS Installed CRS UP ASM UP RDBMS UP DB Instance Name
-----
odax3rm2 Yes Yes Yes Yes Yes Yes b22S2 b23S2 b24S2
-----
```

...

6. Confirm communications between the nodes and that SSH is working using the same password for `oracle`, `root` and `grid`.

From each node:

- a. `ssh` to both nodes.
 - b. Ping both nodes.
7. Confirm there is at least 10 GB of space available on each node.

```
[root@oda]# df -h
```

```
[root@odb]# df -h
```

8.3 Adding the 10-Pack of SSDs

Add the 10-pack solid-state drives (SSDs) for data storage into the existing base configuration to fully populate the base storage shelf.

Before adding the disks to the system, ensure that Oracle Database Appliance is on the latest update version.

1. Insert disks one at a time in slots 10 through 19.

Note:

Allow at least one minute between inserting each disk to avoid flooding of disk events into `oakd`.

After all 10 disks are added, go to Step 2.

2. Run the `oakcli show ismaster` command to determine which node is the master.

```
# oakcli show ismaster
```

3. Run the `oakcli expand storage` command on the master node.

```
#oakcli expand storage
Precheck passed.
Successfully formatted 1.6TB SSD disks...
Check the progress of expansion of storage by executing 'oakcli show disk'
Waiting for expansion to finish ...
```

Wait 30 seconds before proceeding to the next step.

4. Execute the `oakcli expand storage` command on the slave node.

```
#oakcli expand storage
Precheck passed.
Successfully formatted 1.6TB SSD disks...
Check the progress of expansion of storage by executing 'oakcli show disk'
Waiting for expansion to finish ...
```

It takes 10 to 12 minutes to add all of the disks to the configuration.

5. Run the `oakcli showdisk` command to ensure that all disks are listed, are online, and are in a good state.

```
# oakcli show disk
```

6. Verify that the disks in slots 10 to 20 are added to Oracle Automatic Storage Management (Oracle ASM).

- a. Run the `asm_script` to verify that the disks in slots 10 to 20 are added to Oracle Automatic Storage Management (Oracle ASM). If the 10 disks are successfully added (CACHED and MEMBER), then go to Step 7.

```
su grid user /opt/oracle/oak/bin/stordiag/asm_script.sh 1 6
```

- b. If the disks are not added to Oracle ASM, then add them manually. As a grid user, execute the `sqlplus '/as sysasm'` command on the master node to add the disks to Oracle ASM.

```
#sqlplus '/as sysasm'
....
SQL> alter diskgroup /*+ _OAK_AsmCookie */ data add disk
'/dev/mapper/SSD_E0_S11_1399764284p1' name SSD_E0_S11_1399764284p1,
'/dev/mapper/SSD_E0_S12_1399765076p1' name SSD_E0_S12_1399765076p1,
'/dev/mapper/SSD_E0_S13_1399765116p1' name SSD_E0_S13_1399765116p1,
'/dev/mapper/SSD_E0_S14_1399765484p1' name SSD_E0_S14_1399765484p1,
'/dev/mapper/SSD_E0_S15_1399765404p1' name SSD_E0_S15_1399765404p1,
'/dev/mapper/SSD_E0_S16_1399766160p1' name SSD_E0_S16_1399766160p1,
'/dev/mapper/SSD_E0_S17_1399765264p1' name SSD_E0_S17_1399765264p1,
'/dev/mapper/SSD_E0_S18_1399763588p1' name SSD_E0_S18_1399763588p1,
'/dev/mapper/SSD_E0_S19_1399765504p1' name SSD_E0_S19_1399765504p1;
```

```
SQL> alter diskgroup /*+ _OAK_AsmCookie */ reco add disk
'/dev/mapper/SSD_E0_S11_1399764284p2' name SSD_E0_S11_1399764284p2,
'/dev/mapper/SSD_E0_S12_1399765076p2' name SSD_E0_S12_1399765076p2,
'/dev/mapper/SSD_E0_S13_1399765116p2' name SSD_E0_S13_1399765116p2,
'/dev/mapper/SSD_E0_S14_1399765484p2' name SSD_E0_S14_1399765484p2,
'/dev/mapper/SSD_E0_S15_1399765404p2' name SSD_E0_S15_1399765404p2,
'/dev/mapper/SSD_E0_S16_1399766160p2' name SSD_E0_S16_1399766160p2,
'/dev/mapper/SSD_E0_S17_1399765264p2' name SSD_E0_S17_1399765264p2,
'/dev/mapper/SSD_E0_S18_1399763588p2' name SSD_E0_S18_1399763588p2,
'/dev/mapper/SSD_E0_S19_1399765504p2' name SSD_E0_S19_1399765504p2;
```

7. Use the `oakcli show validation storage errors` command to show hard storage errors.

Hard errors include having the wrong type of disk inserted into a particular slot, an invalid disk model, or an incorrect disk size.

```
# oakcli show validation storage errors
```

8. Use the `oakcli show validation storage failures` command to show soft validation errors.

A typical soft disk error would be an invalid version of the disk firmware.

```
# oakcli show validation storage failures
```

9. Confirm that the `oak_storage_conf.xml` file shows 24 on both nodes.

```
#cat /opt/oracle/oak/conf/oak_storage_conf.xml
```

8.4 Adding the Storage Expansion Shelf

After the base storage shelf is fully populated, you can add the storage expansion shelf to expand your data storage.

The addition of the storage expansion shelf includes checks across both nodes. It is important to confirm that SSH does work across the nodes and all users can connect as expected using their shared password.

Note:

Oracle recommends that you add a storage expansion shelf when you have relatively little activity on your databases. When the system discovers the new storage, Oracle ASM automatically rebalances the disk groups. The rebalance operation may degrade database performance until the operation completes.

1. Install and cable the storage expansion shelf, but do **not** power on the expansion shelf.

Caution:

Review cabling instructions carefully to ensure that you have carried out cabling correctly. Incorrect connections can cause data loss when adding a storage expansion shelf to Oracle Database Appliance with existing databases.

2. If this is a new deployment or re-image of Oracle Database Appliance, perform the following steps in order:
 - a. Power on the base storage
 - b. Power on Node 0
 - c. Power on Node 1

Caution:

Do not power on the expansion shelf yet.

3. Verify that both nodes plus the base storage shelf are up and running. Log into each server node and run the `oakcli validate` command to confirm that the base configuration cabling is correct.

```
oakcli validate -c storagetopology
...
INFO    : Check if JBOD powered on
SUCCESS : JBOD : Powered-on
INFO    : Check for correct number of EBODS(2 or 4)
SUCCESS : EBOD found :
2
```

```

INFO      : Check for overall status of cable validation on Node0
SUCCESS  : Overall Cable Validation on Node0
SUCCESS  : JBOD Nickname set correctly : Oracle Database Appliance - E0

```

The correct results will confirm if the two server nodes are properly cabled to the base storage shelf and all disks are online, with a good status, and added to the existing diskgroups on both nodes. If there any failures, then fix the cabling before proceeding to the next step.

 **Note:**

IF the output shows that `EBOD found` is 2, then you only have the base storage shelf. If `EBOD found` is 4, then you have a base storage shelf and an expansion shelf.

4. Power on the storage expansion shelf.
5. Log in to each server node and run the `oakcli validate` command to validate the storage cabling and confirm that the new storage shelf is recognized.

```

# oakcli validate -c storagetopology

INFO      : Check if JBOD powered on
SUCCESS  : 2JBOD : Powered-on
INFO      : Check for correct number of EBODS(2 or 4)
SUCCESS  : EBOD found : 4
...
...

INFO      : Check for overall status of cable validation on Node0
SUCCESS  : Overall Cable Validation on Node0
SUCCESS  : JBOD0 Nickname set correctly : Oracle Database Appliance - E0
SUCCESS  : JBOD1 Nickname set correctly : Oracle Database Appliance -
E1

```

Look for the following indicators that both storage shelves are recognized:

- When there are two shelves, the JBOD (just a bunch of disks) is numbered. For example:

```
SUCCESS : 2JBOD : Powered-on
```
- When both shelves are recognized, the `EBOD found` value is 4.

```
SUCCESS : EBOD found : 4
```
- When the expansion shelf is cabled properly, the nickname is `E1`. For example:

```

SUCCESS : JBOD0 Nickname set correctly : Oracle Database Appliance -
E0
SUCCESS : JBOD1 Nickname set correctly : Oracle Database Appliance -
E1

```

Fix any errors before proceeding.

6. Run the `oakcli showdisk` command to ensure that all disks in the expansion shelf are listed, are online, and are in a good state.

```
# oakcli show disk
```

When all disks are online and in a good state, proceed to the next step.

7. Run the `oakcli show enclosure` command to check the health of components in expansion shelf.

```
# oakcli show enclosure
```

8. Run the `oakcli show ismaster` command on Node 0 to confirm that Node 0 is the master.

```
# oakcli show ismaster
```

9. Run the `oakcli expand storage` command on the master node.

```
#oakcli expand storage
```

```
Precheck passed.  
Successfully formatted 1.6TB SSD disks...  
Check the progress of expansion of storage by executing 'oakcli show disk'  
Waiting for expansion to finish ...
```

Wait 30 seconds before proceeding to the next step.

10. Execute the `oakcli expand storage` command on the slave node.

```
#oakcli expand storage
```

```
Precheck passed.  
Successfully formatted 1.6TB SSD disks...  
Check the progress of expansion of storage by executing 'oakcli show disk'  
Waiting for expansion to finish ...
```

It takes approximately 10 to 12 minutes to add all of the disks to the configuration.

11. Use the `oakcli show validation storage errors` command to show hard storage errors.

Hard errors include having the wrong type of disk inserted into a particular slot, an invalid disk model, or an incorrect disk size.

```
# oakcli show validation storage errors
```

12. Use the `oakcli show validation storage failures` command to show soft validation errors.

A typical soft disk error would be an invalid version of the disk firmware.

```
# oakcli show validation storage failures
```

13. Run the `oakcli show version` command to verify that all firmware components in the storage expansion are current.

```
# oakcli show version -detail
```

14. If needed, update the storage shelf and then run the `show version` command to confirm that the firmware is current.

```
# oakcli update
```

```
# oakcli show version -detail
```

9

Managing an Oracle Database Appliance Virtualized Platform

Review the concepts and procedures for Oracle Database Appliance Virtualized Platform.

These topics provides a conceptual overview of the Oracle Database Appliance Virtualized Platform architecture, and procedures for how to deploy a guest virtual machine, manage high availability, manage CPU pools, and configure network settings for Oracle Database Appliance Virtualized Platform. Learn about resizing your Oracle Database domain (ODA_BASE), a privileged virtual machine.

- [About Oracle Database Appliance Virtualized Platform](#) (page 9-2)
You can use Oracle VM to optimize your system resource use for databases and applications.
- [Oracle Database Appliance Virtualized Platform Architecture](#) (page 9-3)
Review these topics to understand Oracle Database Appliance Virtualized Platform, and how you can use it to optimize system resource use.
- [How to Create and Manage Shared Repositories](#) (page 9-7)
These topics describe how to use OAKCLI to create and manage shared repositories on Oracle Database Appliance Virtualized Platform.
- [How to Manage Virtual Disks in Shared Repositories](#) (page 9-10)
These topics describe how to use OAKCLI to create, view, clone, attach, and delete virtual disks on Oracle Database Appliance Virtualized Platform.
- [How to Manage Virtual Machine Templates](#) (page 9-13)
These topics describe how to use OAKCLI to import, configure, modify and check virtual machine templates on Oracle Database Appliance Virtualized Platform.
- [How to Create Clones and Snap Clones of a Template](#) (page 9-18)
Review these topics for an overview of clones and snap clones, and for procedures to use to create clones.
- [How to Manage Virtual Machines on Oracle Database Appliance Virtualized Platform](#) (page 9-20)
Review these topics for an overview of virtual machines, and for procedures to create and manage virtual machines.
- [How to Create Driver Domain Virtual Machines](#) (page 9-28)
Use driver domain virtual machines to improve performance.
- [How to Manage High Availability on Oracle Database Appliance Virtualized Platform](#) (page 9-38)
Use the `oakcli configure vm` command to configure high availability services for your virtual machines.
- [How to Manage CPU Pools on Oracle Database Appliance Virtualized Platform](#) (page 9-39)
These topics describe how to use OAKCLI to create and manage CPU pools on Oracle Database Appliance Virtualized Platform.

- [About Network Infrastructure and Virtual Local Area Networks on Oracle Database Appliance Virtualized Platform](#) (page 9-42)
To specify which network you want to use to access a virtual machine, you employ network infrastructure components of Oracle Database Appliance Virtualized Platform.
- [Managing Virtual Local Area Networks on User Domains and on ODA_BASE](#) (page 9-44)
Use these examples to understand how to configure and manage virtual local area networks (VLANs).
- [How to Resize ODA_BASE](#) (page 9-47)
You can increase or decrease the number of CPU cores that you assign the ODA_BASE domain to add or reduce computing power and memory as required for your workloads.

9.1 About Oracle Database Appliance Virtualized Platform

You can use Oracle VM to optimize your system resource use for databases and applications.

You can deploy a virtualized platform on Oracle Database Appliance. The virtual platform is based on Oracle VM. With Oracle Database Appliance Virtualized Platform, you can use the capabilities of Oracle VM to effectively allocate resources to databases and applications running on the same physical Oracle Database Appliance. Rather than simply disabling unnecessary server cores, you can use the excess capacity to host other workloads. This enables consolidation of both databases and applications, while retaining the ease of deployment and management associated with Oracle Database Appliance.

Oracle Database Appliance Virtualized Platform is supported on all versions of Oracle Database Appliance hardware. All templates and operating systems supported by Oracle VM are also supported on Oracle Database Appliance Virtualized Platform. Supported operating systems include Linux, Windows, and Solaris x86.



Note:

All new systems are currently shipped from the factory with the nonvirtualized ISO image

If you are currently on the nonvirtualized deployment of Oracle Database Appliance, and you want to use Oracle Database Appliance as a virtualized platform, then you must reimage the servers with the Oracle Database Appliance Virtualized Platform ISO image.

Why Virtualize?

Oracle Appliance Manager (oakcli) makes it easy to setup and manage the virtualized environment with little virtualization expertise. With the Virtualized Platform deployment, you can consolidate entire multi-tier environments within a single Oracle Database Appliance system.

The following are some of the advantages of deploying Oracle Database Appliance with the Virtualized Platform option:

1. Deploy database and applications in a single hardware environment.
2. Use the pre-configured VM application templates to rapidly deploy database and applications.
3. Run the database in a virtual machine (ODA_BASE) with direct access to storage (for native performance).
4. Control licensed CPUs by configuring ODA_BASE domain with the required number of CPU cores (and memory).
5. Use your CPU cores (and memory) efficiently. CPU cores not assigned to the ODA_BASE domain are not wasted and are available for use by other, non-database virtual machines.
6. Use virtual local area networks (VLANs) to provide separate networks to different virtual machines.
7. Use shared repository to grow storage for the virtual machine (VM) repository.
8. Improves data center efficiency by increasing space utilization and reducing energy consumption and cooling costs.

9.2 Oracle Database Appliance Virtualized Platform Architecture

Review these topics to understand Oracle Database Appliance Virtualized Platform, and how you can use it to optimize system resource use.

- [About Oracle Database Appliance Virtualized Platform Architecture](#) (page 9-3)
Review this topic to understand how Oracle Database Appliance Virtualized Platform works with Oracle Database Appliance hardware.
- [About Virtual Machines and Oracle Database Appliance Virtualized Platforms](#) (page 9-4)
Oracle Database Appliance Virtualized Platform is designed to run and deploy virtual machines to manage system resources.

9.2.1 About Oracle Database Appliance Virtualized Platform Architecture

Review this topic to understand how Oracle Database Appliance Virtualized Platform works with Oracle Database Appliance hardware.

Oracle Database Appliance Virtualized Platform provides virtualization technology that enables multiple isolated databases and applications to share the same physical server. The Oracle Database Appliance Virtualized Platform ISO image is engineered specifically to leverage the Oracle Database Appliance hardware capabilities.

The Oracle Database Appliance Virtualized Platform architecture uses the virtual machine components shown in the following illustration:

Figure 9-1 Oracle Database Appliance Virtualized Platform Architecture

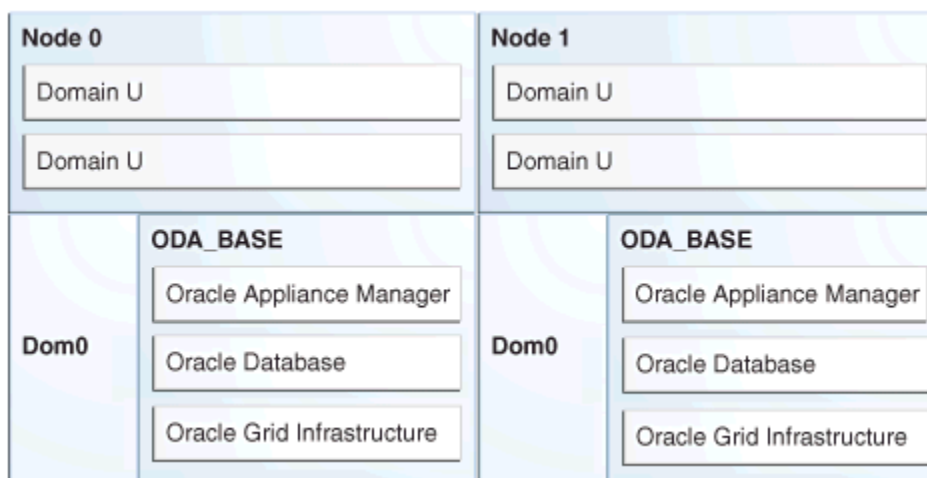

- **Oracle Database Appliance Base Domain (ODA_BASE):** A privileged virtual machine domain, specifically for databases, that provides database performance similar to bare metal deployments. A PCI pass-through driver provides ODA_BASE direct access to the shared storage.
- **Domain 0 (Dom0):** Default domain that initiates Oracle Database Appliance Virtualized Platform provisioning processes and hosts virtual machine templates. Most of the responsibility of hardware detection in an Oracle Database Appliance Virtualized Platform environment is passed to the management domain, referred to as domain zero (or Dom0). On x86-based servers, the Dom0 kernel is actually a small-footprint Linux kernel with support for a broad array of devices, file systems, and software RAID and volume management. In Oracle Database Appliance Virtualized Platform, Dom0 provides access to much of the system hardware, creating, deleting and controlling guest operating systems, and presenting those guests with a set of common virtual hardware.
- **Guest Domains (Domain U):** Virtual machines that are provisioned to host non-database workloads, such as applications and middleware. Guest operating systems each have their own management domain, called a *user domain*, abbreviated to "Domain U". These domains are unprivileged domains that have no direct access to the hardware or to the device drivers. Each Domain U starts after Dom0 is running on Oracle Database Appliance Virtualized Platform.

9.2.2 About Virtual Machines and Oracle Database Appliance Virtualized Platforms

Oracle Database Appliance Virtualized Platform is designed to run and deploy virtual machines to manage system resources.

Configure virtual machines on Oracle Database Appliance Virtualized Platform to manage your application use of shared repository resources, such as the CPU pool, memory, and other shared resources.

Virtual Machine Templates

Virtual machines can be created from a template or assembly containing preconfigured virtual machines. The creation of a virtual machine from a template is based on cloning: the template is imported as an archive, unpacked, and stored as a virtual machine configuration file with disk images. These disk images are cloned to create a new instance in the form of a virtual machine. In the same way, an existing virtual machine can be cloned to create a new virtual machine, or cloned to create a new template.

Virtual Machine Assemblies

Virtual machine assemblies are often described as a template of a group of virtual machines, or a collection of virtual machine templates. An assembly can contain a single virtual machine or a collection of virtual machine templates.

Domains, Guests and Virtual Machines

The terms *domain*, *guest*, and *virtual machine* are often used interchangeably, but they have subtle differences. A *domain* is a configurable set of resources, including memory, virtual CPUs, network devices, and disk devices, in which virtual machines run. A *guest* is a virtualized operating system running within a domain. Multiple guests can run on the same instance of Oracle Database Appliance Virtualized Platform, each within its own domain. A *virtual machine* is granted virtual resources, and can be started, stopped, and restarted independently.

Virtual Disks

In addition to virtual machines, you can create virtual disks in shared repositories. Virtual disks provide additional storage options for virtual machines by enabling you to attach additional block storage to your virtual machines. Similarly, you can detach the storage if you no longer need the additional space. You can use virtual disks to expand existing file system storage inside the virtual machine by extending the storage volume onto a virtual disk, or by creating a new file system on a virtual disk. Your virtual disks can also share multiple virtual machines running on the same shared repository.

A *driver domain* is a user domain that has special privileges and responsibilities for a particular piece of hardware. When you use the driver domain option, the newly created virtual disks are mounted directly from `ODA_BASE` to a guest virtual machine. The option improves performance by enabling guest virtual machines to use `ODA_BASE` instead of `Dom0` to access virtual disks. The driver domain option is available beginning with release 12.1.2.7.0 and is supported with Oracle Linux, Windows, and Oracle Solaris x86 guest operating systems. Live migration of driver domain virtual machines is not supported.

Shared Repositories

A *shared repository* is a central location for storing resources that are essential to creating and managing virtual machines. These resources include virtual machine templates and assemblies, ISO files (virtual DVD images), virtual machine configuration files, and virtual disks. Shared repositories are configured on an Oracle Automatic Storage Management Cluster File System (Oracle ACFS) and then presented to the Oracle Database Appliance nodes that need access to those resources. Oracle Database Appliance Virtualized Platform uses shared repositories to optimize available disk space usage in the environment, and for easy reallocation of

virtual machines if a physical server fails. The virtual machine files can be stored on shared disks, providing shared storage for the virtual machines. Additionally, you can configure CPU pools and a resizable Oracle Database domain (ODA_BASE) to ensure that the virtual machines do not consume cycles from each other or from your assigned database CPU cores.

- The shared disks on Oracle Database Appliance Virtualized Platform are connected directly to ODA_BASE.
- ODA_BASE contains three shared repositories named `fs1`, `fs2`, and `fs3`.
- Each shared repository is an Oracle ACFS in ODA_BASE created on top of the Oracle Automatic Storage Management (Oracle ASM) disk group (DATA or RECO) chosen by the user when creating the shared repository.
- The process that creates a shared repository also performs a network file system (NFS) export of the shared repository to the respective `Dom0` by using the private network.
- The export enables shared storage for the virtual machine files.

Figure 9-2 Architecture Overview of Oracle Database Appliance Virtualized Platform Shared Repositories

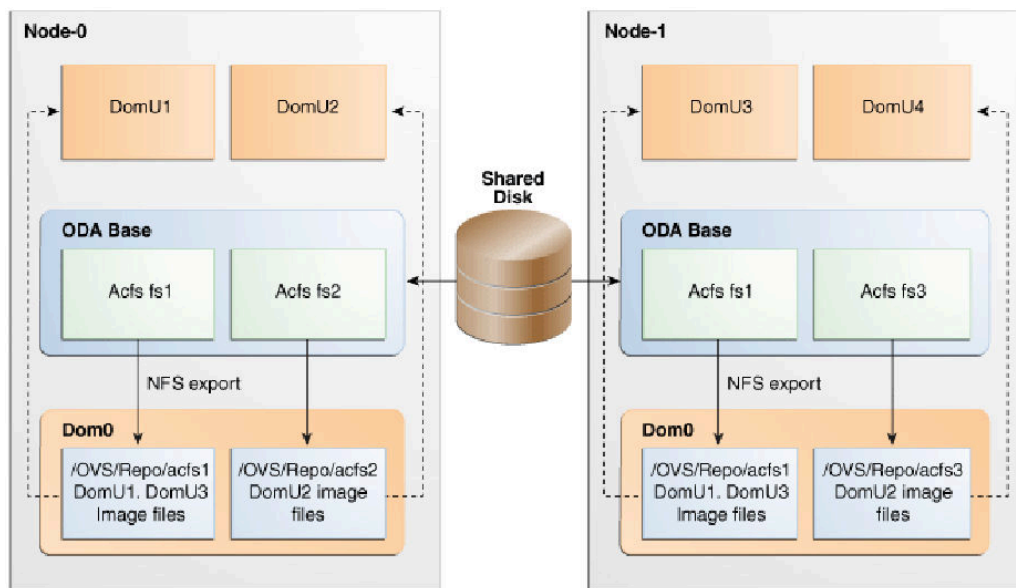

With the configuration shown in the illustration, you can:

- Create multiple repositories.
- Mount these repositories either on the nodes where the virtual machine needs to run (such as `fs2` and `fs3` in the illustration), or on both the nodes (such as `fs1` in the illustration).
- Create one or more virtual machines or virtual machine templates on the shared repositories.
- Use OAKCLI commands to create and manage shared repositories, virtual disks, and their virtual machines, and the underlying architecture shown in the illustration.

 **Note:**

Virtual machine (VM) repositories on Oracle Database Appliance can only be on the boot drives or an Oracle Database Appliance shared storage shelf. External storage cannot be used for VM shared repositories on Oracle Database Appliance.

9.3 How to Create and Manage Shared Repositories

These topics describe how to use OAKCLI to create and manage shared repositories on Oracle Database Appliance Virtualized Platform.

- [Creating a Shared Repository](#) (page 9-7)
Use the `oakcli create repo` command to create a shared repository on Oracle Database Appliance Virtualized Platforms.
- [Showing the Status of Shared Repositories](#) (page 9-8)
Use the `oakcli show repo` command to display information about virtual machine repositories on Oracle Database Appliance Virtualized Platforms.
- [Starting a Shared Repository](#) (page 9-8)
Use the `oakcli start repo` command to start a virtual machine and assign it to a shared repository on Oracle Database Appliance Virtualized Platforms.
- [Stopping a Shared Repository](#) (page 9-9)
Use the `oakcli stop repo` command to command to stop a shared repository on a node on Oracle Database Appliance Virtualized Platforms.
- [Deleting a Shared Repository](#) (page 9-9)
Use the `oakcli delete repo` command to delete a shared repository on Oracle Database Appliance Virtualized Platforms.
- [Increasing the Size of a Shared Repository](#) (page 9-10)
Use the `oakcli configure repo` command to increase the size of a shared repository on Oracle Database Appliance Virtualized Platforms.

9.3.1 Creating a Shared Repository

Use the `oakcli create repo` command to create a shared repository on Oracle Database Appliance Virtualized Platforms.

When you run the `oakcli create repo` command, you identify the repository name using the option `repo`, you identify the disk group that you want to use for its storage (DATA or RECO) using the option `-dg`, and you identify the size of the repository in gigabytes or megabytes (the default size unit is gigabytes) using the `-size` option.

Other Oracle Appliance Manager shared repository commands, including commands to show and to stop (dismount) existing repositories, are similar to those used for nonshared repositories. Unlike the default repositories, which are permanent, you can delete a shared repository that has no active (mounted) virtual machines.

Example of Creating a Shared Repository

The following command creates a shared repository named `repo1` in the ASM DATA disk group (`data`) with 30 gigabytes of available storage:

```
oakcli create repo repol -dg data -size 30
```

9.3.2 Showing the Status of Shared Repositories

Use the `oakcli show repo` command to display information about virtual machine repositories on Oracle Database Appliance Virtualized Platforms.

To see all repositories, omit the repository name and node number. To see a specific shared repository, include the repository name and node number.

Example 9-1 Example of Showing the Status of All Shared Repositories

To show the status of all shared repositories, use the `oakcli show repo` command:

```
oakcli show repo
```

NAME	TYPE	NODENUM	FREE SPACE	STATE
odarepo1	local	0	N/A	N/A
odarepo2	local	1	N/A	N/A
repo1	shared	0	68.25%	ONLINE
repo1	shared	1	68.25%	ONLINE
repo2	shared	0	N/A	OFFLINE
repo2	shared	1	89.83%	ONLINE

Example 9-2 Example of Showing the Status of a Selected Shared Repository

To display information for a particular node in a shared repository, specify the repository name and node number as part of the command syntax. In the following example, information is displayed for Node 1 in the `repo1` shared repository:

```
oakcli show repo repol -node 1
```

```
Resource: repol_1
  AutoStart      : restore
  DG             : DATA
  Device         : /dev/asm/repol-286
  ExpectedState  : Online
  FreeSpace      : 87.703125M
  MountPoint     : /u01/app/repol
  Name           : repol_0
  Node           : all
  RepoType       : shared
  Size           : 30720
  State          : Online
  Version        : 2
```

9.3.3 Starting a Shared Repository

Use the `oakcli start repo` command to start a virtual machine and assign it to a shared repository on Oracle Database Appliance Virtualized Platforms

Before you can assign a virtual machine to a shared repository, use the `oakcli start repo` command to start the repository and make the storage available. Note that the `oakcli start repo` command will also start any virtual machines assigned to the repository that are defined to be automatically started.

You must have a repository already configured. Identify the repository that you start by using the option `repo name`, where `name` is the repository name. Identify the name of the

node on which the repository is located by using the option `-node nodename`, where *nodename* is the name of the node on which the repository is located.

Example 9-3 Example of Starting a Shared Repository

This command starts the shared repository named `repo1` on Node 1:

```
oakcli start repo repo1 -node 1
```

9.3.4 Stopping a Shared Repository

Use the `oakcli stop repo` command to command to stop a shared repository on a node on Oracle Database Appliance Virtualized Platforms.

Identify the repository that you want to stop by using the `repo reponame` option, where *reponame* identifies the repository that you want to stop. Identify the node on which the repository that you want to stop is running by using the `-node number` option where *number* is the node number that you want to stop.

Note:

Do not issue an `oakcli stop repo` command while virtual machines are still active in the repository for the selected node.

Example 9-4 Example of Stopping a Shared Repository

The following example stops the shared repository named `repo1` on Node 0:

```
oakcli stop repo repo1 -node 0
```

9.3.5 Deleting a Shared Repository

Use the `oakcli delete repo` command to delete a shared repository on Oracle Database Appliance Virtualized Platforms.

Identify the repository that you want to delete by using the `repo reponame` option, where *reponame* identifies the repository that you want to delete.

Note:

The shared repository that you want to delete must be offline (stopped) on both nodes before you attempt to delete it.

Example 9-5 Example of Deleting a Shared Repository

The following command deletes the shared repository named `repo1` on both nodes:

```
oakcli delete repo repo1
```

9.3.6 Increasing the Size of a Shared Repository

Use the `oakcli configure repo` command to increase the size of a shared repository on Oracle Database Appliance Virtualized Platforms.

Identify the repository that you want to expand by using the `-repo reponame` option, where `reponame` identifies the repository that you want to expand. Use the option `-incsize size` to specify the size of the increase that you want to configure, where `size` is the size (in gigabytes) that you want to add to the configured size.

Example 9-6 Example of Increasing the Size of a Shared Repository

The following command increases the size of the shared repository `rep01` by 2 gigabytes:

```
# oakcli configure repo rep01 -incsize 2G
```

```
Configured Shared Repo : rep01 with new size 3712.0.
```

9.4 How to Manage Virtual Disks in Shared Repositories

These topics describe how to use OAKCLI to create, view, clone, attach, and delete virtual disks on Oracle Database Appliance Virtualized Platform.

- [Creating a Virtual Disk for Use in a Shared Repository](#) (page 9-10)
Use the command `oakcli create vdisk` to create a virtual disk within a shared repository on Oracle Database Appliance Virtualized Platforms.
- [Viewing Information About Virtual Disks](#) (page 9-11)
Use the command `oakcli show vdisk` to view information about virtual disks on Oracle Database Appliance Virtualized Platforms.
- [Cloning Virtual Disks](#) (page 9-11)
Use the `oakcli clone vdisk` command to create clones of virtual disks on Oracle Database Appliance Virtualized Platforms.
- [Attaching a Virtual Disk to a Virtual Machine](#) (page 9-12)
Use the `oakcli modify vm` command to attach a virtual disk to a virtual machine on Oracle Database Appliance Virtualized Platforms.
- [Deleting a Virtual Disk](#) (page 9-12)
Use the `oakcli delete vdisk` command to remove a virtual disk from a shared repository on Oracle Database Appliance Virtualized Platforms.

9.4.1 Creating a Virtual Disk for Use in a Shared Repository

Use the command `oakcli create vdisk` to create a virtual disk within a shared repository on Oracle Database Appliance Virtualized Platforms.

The command `oakcli create vdisk` defines the size of the virtual disk, the shared repository in which that disk is created, defines the unique name for that disk within that shared repository, and defines if the disk is used for one virtual machine, or can be shared by multiple virtual machines.

The name of the vdisk you create is defined by the command `oakcli create vdisk name`, where `name` is the name of the vdisk you create. Identify the repository in which you create the vdisk by using the `-repo reponame` option, where `reponame` identifies the

repository where you want to create the vdisk. Use the option `-size sizeG` to specify the vdisk size (in gigabytes), where `sizeG` is the size (in gigabytes) that you want to add to the configured size. If you want to configure the vdisk as a shared disk, then use the option `-type shared` to designate the vdisk as a shared disk.

Example 9-7 Example of Creating a Shared Virtual Disk

This example creates a virtual disk named `sdisk1` in the `repo2` shared repository that is 1 gigabyte in size, and that virtual machines can share:

```
oakcli create vdisk sdisk1 -repo repo2 -size 1G -type shared
```

9.4.2 Viewing Information About Virtual Disks

Use the command `oakcli show vdisk` to view information about virtual disks on Oracle Database Appliance Virtualized Platforms.

You can use `oakcli show vdisk` by itself to see information about all of your configured virtual disks. To see information about an individual virtual disk, enter the command `oakcli show vdisk diskname -repo reponame`, where `diskname` is the name of the disk that you want to check, and `reponame` is the name of the shared repository where the virtual disk is located.

Example 9-8 Example of Displaying the Information for All Vdisks

This example displays information about all virtual disks configured on an Oracle Database Appliance:

```
# oakcli show vdisk
```

NAME	SIZE	TYPE	REPOSITORY
----	----	----	-----
myvdisk	10G	local	vdiskrepo
newv	1G	local	vdiskrepo

Example 9-9 Example of Displaying Information for a Single Vdisk

This example displays information for the virtual disk named `myvdisk1`:

```
# oakcli show vdisk myvdisk1
Resource: myvdisk_vdiskrepo
Name      : myvdisk_vdiskrepo
RepoName  : vdiskrepo
Size      : 10G
Type      : local
VmAttached : 0
```

9.4.3 Cloning Virtual Disks

Use the `oakcli clone vdisk` command to create clones of virtual disks on Oracle Database Appliance Virtualized Platforms.

The command `oakcli clone vdisk` defines the size of the virtual disk, the shared repository in which that disk is created, defines the unique name for that disk within that shared repository, and defines if the disk is used for one virtual machine, or can be shared by multiple virtual machines.

The name of the vdisk you create is defined by the command `oakcli clone vdisk name`, where `name` is the name of the vdisk you create. Identify the repository in which you

create the vdisk by using the `-repo reponame` option, where *reponame* is the name of the repository where the original vdisk is located. Use the option `-src sourcevdiskname`, where *sourcevdiskname* is the name of the virtual disk that you are cloning. Add the option `-h` to display help for this command.

**Note:**

Once the virtual disk is attached to a virtual machine, the system administrator should perform normal disk addition tasks for the given operating system to make the newly added storage available to the virtual machine.

Syntax

```
oakcli clone vdisk name -repo reponame -src sourcevdiskname [-h]
```

Example 9-10 Example of Cloning a Virtual Disk

This example clones a virtual disk named `my_vdisk2` from an existing virtual disk named `vdisk1` that is stored in the repository named `vrepo1`:

```
oakcli clone vdisk my_vdisk2 -repo vrepo1 -src vdisk1
```

9.4.4 Attaching a Virtual Disk to a Virtual Machine

Use the `oakcli modify vm` command to attach a virtual disk to a virtual machine on Oracle Database Appliance Virtualized Platforms.

The command `oakcli modify vm name` enables you to modify a virtual machine, where *name* is the name of the virtual machine that you want to modify. To attach a disk to a virtual machine, use the option `-attachvdisk vdiskname`, where *vdiskname* is the name of the virtual disk that you want to attach to the virtual machine.

Example 9-11 Example of Attaching a Virtual Disk To a Virtual Machine

This example attaches the virtual disk named `sdisk1` to the virtual machine named `myol6u_test`:

```
oakcli modify vm myol6u_test -attachvdisk sdisk1
```

9.4.5 Deleting a Virtual Disk

Use the `oakcli delete vdisk` command to remove a virtual disk from a shared repository on Oracle Database Appliance Virtualized Platforms.

The command `oakcli delete vdisk vdiskname` removes a virtual disk, where *vdiskname* is the name of the virtual disk that you want to remove. The option `-repo reponame` indicates the shared repository on which the virtual disk is located, where *reponame* is the name of the shared repository.

Example 9-12 Example of Deleting a Virtual Disk from a Shared Repository

This example removes a virtual disk named `t2g` from the shared repository named `repoprod1`:

```
oakcli delete vdisk t2g -repo repoprod1
```

9.5 How to Manage Virtual Machine Templates

These topics describe how to use OAKCLI to import, configure, modify and check virtual machine templates on Oracle Database Appliance Virtualized Platform.

- [About Managing Virtual Machine Templates](#) (page 9-13)
Import and configure virtual machine templates as the source for the virtual machines deployed on Oracle Database Appliance Virtualized Platform.
- [Listing Virtual Machine Templates](#) (page 9-14)
Use the `oakcli show vmtemplate` command to display virtual machine template details.
- [Importing Virtual Machine Templates](#) (page 9-15)
Use the `oakcli import vmtemplate` command to import virtual machine templates and assemblies on Oracle Database Appliance Virtualized Platforms.
- [Configuring a Virtual Machine Template](#) (page 9-16)
Use the `oakcli configure vmtemplate` command to configure a virtual machine template on Oracle Database Appliance Virtualized Platform.
- [Showing Configured Values for a Virtual Machine Template](#) (page 9-17)
Use the `oakcli show vmtemplate` command to show values for the configurable options in a virtual machine template.
- [Modifying a Virtual Machine Template Configuration](#) (page 9-17)
Use the `oakcli modify vmtemplate` command to modify a virtual machine template.
- [Removing a Virtual Machine Template](#) (page 9-18)
Use the `oakcli delete vmtemplate` command to remove a virtual machine template.

9.5.1 About Managing Virtual Machine Templates

Import and configure virtual machine templates as the source for the virtual machines deployed on Oracle Database Appliance Virtualized Platform.

If you have created shared repositories, then import templates into one of those shared repositories. If you have not created shared repositories, then import templates into the local repository on one of the local nodes.

You can import assemblies that contain one or more templates. When you import a template or assembly into a shared repository, select a node that you want to perform the operation. Select the node carefully to avoid overloading the node. After you create the repository, the repository becomes available to both nodes, regardless of which node performs the import.

Templates imported into local nodes use the repository name supplied in the import command to identify the node that completes the import, and that provides the storage. On Node 0, the local repository is named `odarepo1` and on Node 1, the local repository is named `odarepo2`. If you want to import a template to both local repositories, then you must provide a different template name when you import the template into the second node.

 **Note:**

You cannot create or clone templates directly on Oracle Database Appliance Virtualized Platform, you must use the Oracle VM templates that are available in Oracle Software Delivery.

If you import an assembly that contains more than one template, then the command automatically modifies the template name that you provide, so that all template names remain unique. The first template you import has the number "1" appended to the name. The second template as the number "2" appended, and additional templates have 3, 4, 5 and so on appended in sequence.

After you import a virtual machine template, you can customize the template using OAKCLI commands.

 **Note:**

Find virtual machine templates at the following URL:

<http://edelivery.oracle.com/linux>.

9.5.2 Listing Virtual Machine Templates

Use the `oakcli show vmtemplate` command to display virtual machine template details.

The `oakcli show vmtemplate` command displays the name and repository for each virtual machine template as well as the default number of CPUs and default amount of memory that Oracle Database Appliance Virtualized Platform would assign to a virtual machine created from the template.

Example

Display information about the `sample1_odarepol` virtual template:

```
oakcli show vmtemplate sample_odarepol
Resource: sample1_odarepol
  CPUPriority      :      100
  Disks           :      |file:/OVS/Repositories/odarepol/Te
                   |mplates/otml_sample1_odarepol/Syste
                   |m.img,xvda,w||file:/OVS/Repositorie
                   |s/odarepol/Templates/otml_sample1_o
                   |darepol/u01.img,xvdb,w|
  Domain         :      XEN_PVM
  Keyboard       :      en-us
  MaxMemory      :      2048
  MaxVcpu        :      2
  Memory         :      2048
  Mouse          :      OS_DEFAULT
  Name           :      sample1_odarepol
  Networks       :      |bridge=priv1||bridge=net1||bridge=
                   |net2|
  NodeNum        :      0
  OS             :      OL_5
```

```
ProcessorCap    :    100
RepoName       :    odarepo1
Vcpu           :     2
```

9.5.3 Importing Virtual Machine Templates

Use the `oakcli import vmtemplate` command to import virtual machine templates and assemblies on Oracle Database Appliance Virtualized Platforms.

You import virtual machine templates and assemblies contained in an external repository assembly file. Use the name of the shared repository and include a clause to identify the node where you want to import a template or an assembly.

You can import virtual machine templates and assemblies directly from a remote repository using a URL to identify the source of the files. You can choose to use a remote copy command to copy files from the remote repository into your `Dom0 /OVS` directory, and then import the files using the path and names to identify the downloaded files.

Note:

When importing templates or assemblies to a local repository, do not use the `-node` option. The target node is implicit in the name of the repository.

Syntax

```
oakcli import vmtemplate vmtemplatename -files image_files | -assembly assembly_file
-repo repo_name [- node 0 | 1 ]
```

Example 9-13 Example of Importing Virtual Machine Templates from an External Repository Assembly File

Use the `oakcli import vmtemplate vmtemplatename -assembly assembly_file -repo repo_name` command to import virtual machine templates contained in an external template repository assembly file.

This example imports the template in an external template repository assembly file located at the URL `'http://example.com/assemblies/OEL6/OVM_OL6U1_x86_PVHVM.ova'` to a new template named `OL6U1` in a new repository named `odarepo1`:

```
oakcli import vmtemplate OL6U1 -assembly 'http://example.com/assemblies/OEL6/
OVM_OL6U1_x86_PVHVM.ova' -repo odarepo1
```

Note the single quotation marks that enclose the URL.

Example 9-14 Example of Importing a Virtual Machine Template from Dom0

Use this command syntax to import a virtual machine template from the `/OVS` file system on `Dom0`:

```
oakcli import vmtemplate vmtemplatename -files image_files -repo repo_name
```

This example imports the virtual machine template named `OVM_OL5U7_x86_64_PVM_10GB.tgz` from the `/OVS` directory in `Dom0` into the `odarepo1` repository. The template is assigned the name `OL5U7`:

```
oakcli import vmtemplate OL5U7 -files /OVS/OVM_OL5U7_x86_64_PVM_10GB.tgz -repo odarepol
```

Example 9-15 Example of Importing a Virtual Machine Template Using an External Repository URL

Use the command `oakcli import vmtemplate vmtemplatename -files image_files -repo repo_name` to import a virtual machine template file from an external template repository.

This example imports a virtual machine template named `OVM_OL5U7_x86_64_PVM_10GB.tgz` from an external template repository at the URL `'http://example.com/assemblies/OEL6/OVM_OL6U1_x86_PVHVM.tgz'`. Note the single quotation marks that enclose the URL. The template is assigned the name `OL5U7`, and is imported into the `odarepol` repository:

```
oakcli import vmtemplate OL5U7 -files 'http://example.com/assemblies/OEL6/OVM_OL6U1_x86_PVHVM.tgz'-repo odarepol
```

9.5.4 Configuring a Virtual Machine Template

Use the `oakcli configure vmtemplate` command to configure a virtual machine template on Oracle Database Appliance Virtualized Platform.

The values become the default values for any virtual machine cloned from this template. You can change any or all of them later with the `oakcli configure vm` command.

Example

Set values for the virtual machine template named `myol5u7_10gb`:

```
oakcli configure vmtemplate myol5u7_10gb -vcpu 2 -maxvcpu 4 -cpucap 40 -memory 1536M -maxmemory 2G -os OTHER_LINUX
```

- `-vcpu 2` sets the number of CPUs to be assigned when the virtual machine starts up to 2.
- `-maxvcpu 4` sets the maximum number of CPUs that can be assigned to the virtual machine to 4.
- `-cpucap 40` sets the maximum percentage of a CPU's capacity that can be assigned to the virtual machine to 40%.
- `-memory 1536M` sets the amount of memory to be assigned when the virtual machine starts up to 1536 MB.
- `-maxmemory 2G` sets the maximum amount of memory that can be assigned to the virtual machine to 2 GB.
- `-os OTHER_LINUX` sets `OTHER_LINUX` as the operating system used by the virtual machine.

9.5.5 Showing Configured Values for a Virtual Machine Template

Use the `oakcli show vmtemplate` command to show values for the configurable options in a virtual machine template.

Example

Display information about the `sample1_odarepol` virtual template:

```
oakcli show vmtemplate sample_odarepol
Resource: sample1_odarepol
      CPUPriority      :      100
      Disks            :      |file:/OVS/Repositories/odarepol/Te
                           mplates/otml_sample1_odarepol/Syste
                           m.img,xvda,w||file:/OVS/Repositorie
                           s/odarepol/Templates/otml_sample1_o
                           darepol/u01.img,xvdb,w|
      Domain          :      XEN_PVM
      Keyboard        :      en-us
      MaxMemory       :      2048
      MaxVcpu         :      2
      Memory          :      2048
      Mouse           :      OS_DEFAULT
      Name            :      sample1_odarepol
      Networks        :      |bridge=priv1||bridge=net1||bridge=
                           net2|
      NodeNum         :      0
      OS              :      OL_5
      ProcessorCap    :      100
      RepoName        :      odarepol
      Vcpu            :      2
```

9.5.6 Modifying a Virtual Machine Template Configuration

Use the `oakcli modify vmtemplate` command to modify a virtual machine template.

After you import a virtual machine template to a storage repository, examine the template configuration parameters with the `oakcli show vmtemplate` command. If you need to reconfigure the template for specific requirements, then use the `oakcli configure vmtemplate` command. This is useful if you plan to deploy multiple virtual machines with the same characteristics from a single template. If you will be deploying only one virtual machine or many virtual machines but with different characteristics, then set required values in the virtual machines with the `oakcli configure vm` command after you deploy the template.

When you are satisfied with the configuration of your virtual machine template, use the `oakcli modify` command to assign a new network to the virtual machine template.

Example

Replace the network assigned to the `gc_11g` virtual machine template with the `net1` network:

```
oakcli modify vmtemplate gc_11g -addnetwork net1
```

9.5.7 Removing a Virtual Machine Template

Use the `oakcli delete vmtemplate` command to remove a virtual machine template.

If you no longer need a template that you previously stored, then you can remove the template from the repository.

Example

Remove the virtual machine template named `myo16u_15gb3` from Oracle Database Appliance Virtualized Platform:

```
oakcli delete vmtemplate myo16u_15gb3
```

9.6 How to Create Clones and Snap Clones of a Template

Review these topics for an overview of clones and snap clones, and for procedures to use to create clones.

- [About Creating Clones and Snap Clones of a Template](#) (page 9-18)
You can create, or *clone*, virtual machines from imported templates (or assemblies) or from an existing virtual machine on Oracle Database Appliance Virtualized Platforms.
- [Cloning a Template With OAKCLI](#) (page 9-19)
Use the `oakcli clone vm` command to clone virtual machines that have attached virtual disks on Oracle Database Appliance Virtualized Platforms.
- [Creating a Snap Clone from a Template With OAKCLI](#) (page 9-19)
Use the `oakcli clone vm` command to create a snap clone of a virtual machine template on Oracle Database Appliance Virtualized Platforms.
- [Creating a Snap Clone of an Existing Virtual Machine With OAKCLI](#) (page 9-20)
Use the `oakcli clone vm` command to create a snap clone of an existing virtual machine on Oracle Database Appliance Virtualized Platforms.

9.6.1 About Creating Clones and Snap Clones of a Template

You can create, or *clone*, virtual machines from imported templates (or assemblies) or from an existing virtual machine on Oracle Database Appliance Virtualized Platforms.

Clones and snap clones can be an effective way to provision and clone new databases for test and development systems. They are much more efficient to create than using RMAN scripts, or other cloning approaches.

You can create virtual machines that are a complete clone of the template or assembly, or you can create virtual machines that are snap clones. Snap clones contain only the metadata defined for the virtual machine.

Creating snap clones is a very fast operation compared to cloning the entire template or assembly. However, if you update the contents of a snap clone, then review your space requirements. Unless your changes to the snap clone are carried out on shared virtual disks, you require additional storage on your system for the clone to retain both the original content, as well as changed content.

9.6.2 Cloning a Template With OAKCLI

Use the `oakcli clone vm` command to clone virtual machines that have attached virtual disks on Oracle Database Appliance Virtualized Platforms.

When you clone virtual machines with attached virtual disks, a clone of a virtual machine contains the contents of virtual disks attached locally, but does not contain contents of virtual disks attached in shared mode. If needed, you can clone the virtual disks required by a cloned virtual machine in a separate step.

Use the command `oakcli clone vm` to create a virtual machine from a virtual machine template. Use the `-repo name` option to provide the name of the shared repository, where *name* is the name of the repository. Use the `-node number` option to identify the node on which you want to perform the cloning process, where *number* is the number of the node.

Note:

The `-node` option identifies the node where the cloning activity is carried out. The node value does not assign the default startup node for the virtual machine. You can set the startup assignment with the command `oakcli configure vm`.

Example 9-16 Example of Creating a Virtual Machine Clone from a Virtual Machine Template

This example creates a virtual machine named `myol6u_test` from the virtual machine template named `myol6u_15gb1`, which is located in a shared repository named `repo2` on Node 0:

```
oakcli clone vm myol6u_test -vmtemplate myol6u_15gb1 -repo repo2 -node 0
```

9.6.3 Creating a Snap Clone from a Template With OAKCLI

Use the `oakcli clone vm` command to create a snap clone of a virtual machine template on Oracle Database Appliance Virtualized Platforms.

Use the `-vmtemplate name` option to provide the name of the virtual machine template that you want to clone, where *name* is the name of the template. Use the `-snap` option to designate that you want to create a snap clone.

Example 9-17 Example of Creating a Snap Clone From a Virtual Machine Template

This example creates a snap clone named `myol15u_snap` from the virtual machine template named `myol15u`:

```
oakcli clone vm myol15u_snap -vmtemplate myol15u -snap
```

9.6.4 Creating a Snap Clone of an Existing Virtual Machine With OAKCLI

Use the `oakcli clone vm` command to create a snap clone of an existing virtual machine on Oracle Database Appliance Virtualized Platforms.

Use the `-vm name` option to provide the name of the virtual machine that you want to clone, where `name` is the name of the virtual machine. Use the `-snap` option to designate that you want to create a snap clone.

Example 9-18 Example of Creating a Snap Clone From an Existing Virtual Machine

This example creates a snap clone named `myo115u_test1` from a virtual machine named `myo115u_test`:

```
oakcli clone vm myo115u_test1 -vm myo115u_test1 -snap
```

9.7 How to Manage Virtual Machines on Oracle Database Appliance Virtualized Platform

Review these topics for an overview of virtual machines, and for procedures to create and manage virtual machines.

- [About Managing Virtual Machines on Oracle Database Appliance Virtualized Platform](#) (page 9-21)
Deploy virtual machines on Oracle Database Appliance Virtualized Platform to run other workloads that are independent of databases running in ODA_BASE
- [Listing the Virtual Machines in Your Repositories](#) (page 9-22)
Use the `oakcli show vm` command to display details for all of your existing virtual machines or to display details of a specific virtual machine.
- [Creating a Virtual Machine](#) (page 9-23)
Create a virtual machine by cloning an imported template, cloning an assembly that contains configured virtual machines, or cloning an existing virtual machine.
- [Configuring a Virtual Machine](#) (page 9-23)
Use the `oakcli configure vm` command to configure a virtual machine on Oracle Database Appliance Virtualized Platform.
- [Starting and Stopping a Virtual Machine](#) (page 9-25)
Use the `oakcli start vm` command to start a virtual machine on Oracle Database Appliance Virtualized Platform and use the `oakcli stop vm` command to stop a virtual machine.
- [Externally Configuring a Virtual Machine](#) (page 9-25)
You can initially configure your virtual machines externally without connecting to the virtual machine console by using Oracle VM Guest Additions by passing key-value pairs to the virtual machine.
- [Opening a Virtual Machine Console for a Virtual Machine](#) (page 9-25)
Use the `oakcli show vmconsole` command to open a virtual machine console window for an active virtual machine

- [Creating an Image for a New Virtual Machine](#) (page 9-26)
Use the `oakcli clone vm` command to create an image for a new virtual machine on Oracle Database Appliance Virtualized Platform.
- [Setting Up a Virtual Machine for Access from eth0 Using an IP Address](#) (page 9-26)
Configure a network device (`eth0`) with an IP address for a virtual machine.
- [Adding or Removing a Virtual Disk to or from a Virtual Machine](#) (page 9-26)
Use the `oakcli modify vm` command to add or remove a virtual disk (vdisk) from a virtual machine.
- [Removing a Virtual Machine from a Shared Repository](#) (page 9-27)
Use the `oakcli delete vm` command to delete the virtual machine and reclaim its storage and resources.
- [Performing a Live Migration for an Oracle Database Appliance Virtual Machine](#) (page 9-27)
If your system meets requirements for live migration, then you can use the `oakcli migrate vm` command to migrate a virtual machine from the currently running node to another node.

9.7.1 About Managing Virtual Machines on Oracle Database Appliance Virtualized Platform

Deploy virtual machines on Oracle Database Appliance Virtualized Platform to run other workloads that are independent of databases running in ODA_BASE

Use OAKCLI commands to create and manage virtual machines, including starting and stopping them, and opening consoles for graphical user interface (GUI) access.

Note:

You can use a Virtual Network Computing (VNC) session to open a GUI console for a virtual machine.

You can reconfigure an active virtual machine. However, your changes do not take effect until you stop and restart the virtual machine. You can display high-level information about all of your virtual machines, or display detailed information about the configuration of single virtual machines. When you no longer have use for a particular virtual machine, delete the virtual machine to regain storage.

Note:

Do not modify the default settings for the following parameters in the guest virtual machine:

- `xen_blkfront.max`: Max Indirect Descriptors, default 32
- `xen_blkback.max_ring_page_order`: Shared Ring Page Order, default 0

9.7.2 Listing the Virtual Machines in Your Repositories

Use the `oakcli show vm` command to display details for all of your existing virtual machines or to display details of a specific virtual machine.

The command displays the name, the repository, and the current state (online or offline) for each virtual machine. The output also contains the default number of CPUs and default amount of memory that Oracle Database Appliance Virtualized Platform will assign to each virtual machine.

- Use the `oakcli show vm` command to display the virtual machine names, memory and vCPU allocations, status, virtual disks, and repository name for all virtual machines.

```
oakcli show vm
```

NAME	MEMORY	VCPU	STATE	REPOSITORY
sample5_odarepo1 odarepo1	2048	2	OFFLINE	
sample6_odarepo1 odarepo2	2048	2	OFFLINE	
test1_odarepo1 odarepo1	2048	2	OFFLINE	
test2_odarepo2 odarepo2	2048	2	OFFLINE	
vm1_odarepo1 odarepo1	4096	4	ONLINE	
vm2_odarepo2 odarepo2	2048	2	OFFLINE	
win_vm1	1500	1	ONLINE	odarepo1

- Use the `oakcli show vm virtual machine name` command to display information about a specific virtual machine.

For example, use the following command to display details about the `vm1_odarepo1` virtual machine:

```
oakcli show vm vm1_odarepo1
Resource: vm1_odarepo1
  AutoStart      : restore
  CPUPriority    : 100
  Disks          : |file:/OVS/Repositories/odarepo1/Vi
                  rtualMachines/vm1_odarepo1/System.i
                  mg,xvda,w||file:/OVS/Repositories/o
                  darepo1/VirtualMachines/vm1_odarepo
                  1/u01.img,xvdb,w|
  Domain        : XEN_PVM
  ExpectedState  : online
  FailOver      : false
  IsSharedRepo  : false
  Keyboard      : en-us
  MaxMemory     : 3000
  MaxVcpu       : 4
  Memory        : 4096
  Mouse         : OS_DEFAULT
  Name          : vm1_odarepo1
  Networks      : |mac=00:21:F6:00:00:E4|
  NodeNum       : 0
  NodeNumStart  :
```

```

OS           :      OL_5
PrivateIP    :      None
ProcessorCap :      100
RepoName     :      odarepol
State        :      Online
TemplateName :      otml_sample1_odarepol
Vcpu         :      4
cpupool     :      twocpu
vncport     :      5901

```

9.7.3 Creating a Virtual Machine

Create a virtual machine by cloning an imported template, cloning an assembly that contains configured virtual machines, or cloning an existing virtual machine.

A virtual machine is a software emulation of a computer system that is granted virtual resources, and can be started, stopped, and restarted independently.

When you clone a template, the template is imported as an archive, unpacked, and stored as a virtual machine configuration file with disk images. The disk images are cloned to create a new instance in the form of a virtual machine.

Instead of creating a complete clone of a template or assembly, you can create a snap clone, which contains only the metadata defined for the virtual machine.

Related Topics

- [How to Create Clones and Snap Clones of a Template](#) (page 9-18)
Review these topics for an overview of clones and snap clones, and for procedures to use to create clones.

9.7.4 Configuring a Virtual Machine

Use the `oakcli configure vm` command to configure a virtual machine on Oracle Database Appliance Virtualized Platform.

Include a `-prefnode` clause, to identify the node where you want the virtual machine to run by default and a `-failover` clause to indicate if you want the virtual machine to use the other node when the preferred node is not available (either at startup or while already active).

If you reconfigure a virtual machine that is currently running, then your changes do not take effect until you stop and restart the virtual machine.

Table 9-1 Parameters Available for Configuring a Virtual Machine

Parameter	Description
<code>-vcpu 2</code>	Sets two (2) as the number of CPUs to be assigned to the virtual machine when started
<code>-cpuprio 150</code>	Sets the CPU access priority to 150
<code>-cpucap 20</code>	Sets the maximum percentage of a CPU's capacity that will be assigned to the virtual machine to 20%
<code>-memory 1G</code>	Sets the amount of memory assigned when the virtual machine starts to 1 GB

Table 9-1 (Cont.) Parameters Available for Configuring a Virtual Machine

Parameter	Description
-cpupool linpool	Specifies linpool as the CPU pool to be assigned to the virtual machine
-keyboard en-us	Defines the keyboard type used to access the virtual machine as en-us
-mouse USB_MOUSE	Defines the mouse type used to access the virtual machine as a USB mouse

These values will override values assigned to these same parameters in the virtual machine template from which this virtual machine was derived. The virtual machine will use default values for parameters that are not defined in either the parent template or in a configuration command.

 **Note:**

CPU capacity is controlled by the CPU pool assigned to a virtual machine by either the `-cpupool` parameter or by the `default_unpinned_pool` (if the virtual machine is not configured with a `-cpupool` parameter). Values for `-vcpu` and `-maxvcpu` parameters that are larger than the number of CPUs in the assigned CPU pool are ignored.

Use the `oakcli configure` command and parameters to configure the virtual machine:

```
# oakcli modify vm vmname parameters
```

Example 9-19 Example of Configuring a Virtual Machine

Set values for specific resources in the virtual machine named `myo115u`:

```
oakcli configure vm myo15u
-vcpu 2 -cpuprio 150 -cpucap 20 -memory 1G
-cpupool linpool -keyboard en-us -mouse USB_MOUSE
```

Related Topics

- [oakcli configure vm](#) (page 10-17)
Use the `oakcli configure vm` command to configure a virtual machine on Oracle Database Appliance Virtualized Platform and to increase or decrease resource allocation to user domains.

9.7.5 Starting and Stopping a Virtual Machine

Use the `oakcli start vm` command to start a virtual machine on Oracle Database Appliance Virtualized Platform and use the `oakcli stop vm` command to stop a virtual machine.

Note:

If you reconfigure a virtual machine that is currently running, then your changes will not be effective until you stop and restart the virtual machine.

9.7.6 Externally Configuring a Virtual Machine

You can initially configure your virtual machines externally without connecting to the virtual machine console by using Oracle VM Guest Additions by passing key-value pairs to the virtual machine.

Use the `oakcli modify vm -s` command to pass parameters to the virtual machine:

```
# oakcli modify vm vmname -s 'key1:value1;key2:value2...'
```

The following example has two value pairs:

```
oakcli modify vm vml6u3 -s 'com.oracle.linux.network.device.  
0:eth0;com.oracle.linux.network.ipaddr.0:192.1.2.18'
```

Note:

- For more information about Oracle VM Guest Additions, see "Using the Oracle VM Guest Additions" in the *Oracle VM Utilities Guide for x86* at http://docs.oracle.com/cd/E35328_01/E35333/html/vmutl-guestadd.html.
- Refer to the whitepaper *Oracle Database Appliance: Automated Virtual Machine Provisioning* for more information.

Related Topics

- <http://www.oracle.com/technetwork/database/database-appliance/overview/oda-automatedvmprovisioning-2348232.pdf>

9.7.7 Opening a Virtual Machine Console for a Virtual Machine

Use the `oakcli show vmconsole` command to open a virtual machine console window for an active virtual machine

If the console does not display correctly, then close the console, set the `DISPLAY` environment variable to an appropriate value for your monitor, and then rerun the `oakcli show vmconsole` command.

You can also configure your virtual machine (using `oakcli modify vm` command with the `-s` parameter) to allow access from the OAKCLI command line instead of a graphical user interface (GUI) virtual machine console.

Use the `oakcli show vmconsole vm_name` to open a console for a virtual machine. Open a For example, use the following command to open a console for the virtual machine named `vm1_odarepol`:

```
oakcli show vmconsole vm1_odarepol
```

9.7.8 Creating an Image for a New Virtual Machine

Use the `oakcli clone vm` command to create an image for a new virtual machine on Oracle Database Appliance Virtualized Platform.

By default, the image inherits the content and configuration information from the template or from the virtual machine that you are cloning and resides in the same repository as the source. Unless you are using local repositories for your virtual machines, include the `-node` clause in the `oakcli clone` command to identify the node that should run the cloning process. To create a snap clone, which will only contain the configuration metadata, include the `-snap` clause in the `oakcli clone` command.

9.7.9 Setting Up a Virtual Machine for Access from eth0 Using an IP Address

Configure a network device (`eth0`) with an IP address for a virtual machine.

The following set of commands configures the virtual machine `vmol6u3` (which has `ovmd`) with the IP address `192.168.16.51` for the `eth0` interface and sets the `root` password.

```
oakcli clone vm vmol6u3 -vmtemplate ol6u3 -repo shrepo -node 0
oakcli modify vm vmol6u3 -addnetwork privl
oakcli start vm vmol6u3
oakcli modify vm vmol6u3 -s 'com.oracle.linux.network.device.0:eth0'
oakcli modify vm vmol6u3 -s 'com.oracle.linux.network.onboot.0:yes'
oakcli modify vm vmol6u3 -s 'com.oracle.linux.network.bootproto.0:static'
oakcli modify vm vmol6u3 -s 'com.oracle.linux.network.ipaddr.0:192.168.16.51'
oakcli modify vm vmol6u3 -s 'com.oracle.linux.network.netmask.0:255.255.255.0'
oakcli modify vm vmol6u3 -s 'com.oracle.linux.root-password:password'
```

9.7.10 Adding or Removing a Virtual Disk to or from a Virtual Machine

Use the `oakcli modify vm` command to add or remove a virtual disk (`vdisk`) from a virtual machine.

Do not use the `-attachvdisk` or the `-detachvdisk` option with the `-addnetwork`, `-deletenetwork`, or `-s key:value` pair parameters.

- To attach a virtual disk to a virtual machine, use the `oakcli modify vm vm_name` command with the `-attachvdisk` clause that names the virtual disk.

```
oakcli modify vm vm_name -attachvdisk vdisk_name
```

- To detach a virtual disk from a virtual machine, use the `oakcli modify vm vm_name` command with the `-detachvdisk` clause that names the virtual disk.

```
oakcli modify vm vm_name -detachvdisk vdisk_name
```

9.7.11 Removing a Virtual Machine from a Shared Repository

Use the `oakcli delete vm` command to delete the virtual machine and reclaim its storage and resources.

When you no longer have use for a particular virtual machine, delete the machine. When deleting the machine, you can specify the Oracle Database Appliance node from which you want to remove the virtual machine. If this optional parameter is not included, then the virtual machine is removed from both nodes.

- Delete the virtual machine from Node 1.

For example, run the following command to delete the `ovu22` virtual machine from Node 1.

```
oakcli delete vm ovu22 -server 1
```

- Delete the virtual machine from both nodes.

For example, run the following command to delete the `ovu22` virtual machine from both nodes.

```
oakcli delete vm ovu22
```

9.7.12 Performing a Live Migration for an Oracle Database Appliance Virtual Machine

If your system meets requirements for live migration, then you can use the `oakcli migrate vm` command to migrate a virtual machine from the currently running node to another node.

Live Migration refers to the process of moving a running virtual machine between physical machines without disconnecting the client or application running in the virtual machine. Memory, storage, and network connectivity of the virtual machine are transferred from the original host machine to the destination.

You must meet the following requirements before performing a live migration:

- The virtual machine must be on a shared repository and the repository must be online on both nodes.
- The virtual machine must be running.
- The destination host must have the required resources (memory, CPUs and so on) for successful migration.
- The destination host must have a CPU pool with the same name as the CPU pool of the virtual machine that is being migrated.

Use the `oakcli migrate vm vmname` command to migrate a virtual machine from the currently running node to another node. *vmname* is the name of the virtual machine to be migrated.

When you run this command, the virtual machine must be online and corresponding, and the shared repository must be online on both nodes. If a virtual machine is in the migration process, then OAKCLI will display the virtual machine state as `MIGRATING`.

Example 9-20 Example of Migrating a Virtual Machine from the Currently Running Node to Another Node

This example migrates a virtual machine named `myvm1`

```
# oakcli migrate vm myvm1
```

9.8 How to Create Driver Domain Virtual Machines

Use driver domain virtual machines to improve performance.

- [About Driver Domain Virtual Machines](#) (page 9-28)
Use driver domain virtual machines to improve performance by enabling guest virtual machines (VMs) to use `ODA_BASE` instead of `Dom0` to access virtual disks.
- [Creating a Driver Domain Virtual Machine from a Template](#) (page 9-29)
Create a driver domain virtual machine from a virtual machine template.
- [Converting a Virtual Machine to a Driver Domain Virtual Machine](#) (page 9-30)
Convert a guest virtual machine to a driver domain virtual machine to improve performance.
- [Converting a Root Disk to a Driver Domain Disk](#) (page 9-31)
Set up your guest virtual machine (guest VM) root disk as a driver domain and create a new disk as the boot driver.

9.8.1 About Driver Domain Virtual Machines

Use driver domain virtual machines to improve performance by enabling guest virtual machines (VMs) to use `ODA_BASE` instead of `Dom0` to access virtual disks.

A *driver domain* is a user domain that has special privileges and responsibilities for a particular piece of hardware. When you use the driver domain option, the newly created virtual disks are mounted directly from `ODA_BASE` to a guest virtual machine. The option improves I/O performance by enabling guest virtual machines to use `ODA_BASE` instead of `Dom0` to access virtual disks.

The driver domain functionality applies to non-system disks. Once a virtual machine is created in driver domain mode, any new vDisks are added in driver domain mode. Newly created virtual disks are mounted directly from `ODA_BASE` to a guest virtual machine. To determine if a virtual machine is configured in driver domain mode, use the `oakcli show vm vmname` command. When the virtual machine is in driver mode, the output for the `DriverDomain` attribute is `TRUE`.

The virtual disk and `vm.cfg` files are stored in the following directories:

- `Dom0: /Repositories/vm_repo_name/.ACFS/snaps/vm_name/VirtualMachines/vm_name`
- `ODA_BASE: /app/sharedrepo/vm_repo_name/.ACFS/snaps/vm_name/VirtualMachines/vm_name`

The driver domain only works when you add virtual disks to a guest virtual machine. When a virtual machine is in driver domain mode, the corresponding virtual machine configuration file, `vm.cfg`, has the following disk entries:

When `-driverdomain` is specified, the cloned virtual machine is configured with the driver domain. The corresponding virtual machine configuration file, `vm.cfg`, has the following disk entries:

```

disk = [u'file:/OVS/Repositories/repo5/.ACFS/snaps/vm10/
VirtualMachines/
vm10/System.img,xvda,w',
u'file:/u01/app/sharedrepo/repo5/.ACFS/snaps/
vm10/VirtualMachines/vm10/u01.img,xvdb,w,oakDom1']

```

All disks, with the exception of the `xvda` boot disk, have the path from `oakDom1`, that is `odabase`.

The following guest operating systems are supported for driver domain virtual machines:

- Oracle Linux with the latest Unbreakable Enterprise Kernel 2 (UEK2) or Unbreakable Enterprise Kernel 3 (UEK3).
- Microsoft Windows with Oracle VM Windows PV Driver 3.4.1. Oracle VM Windows PV Driver 3.4.1 release is available for download on My Oracle Support as patch number 23346086.
- Oracle Solaris 11.3 or higher x86.

9.8.2 Creating a Driver Domain Virtual Machine from a Template

Create a driver domain virtual machine from a virtual machine template.

Several options are available to create, or import, a template that you will use to create the clone. Determine the virtual machine template you want, the method to import the template, and the naming convention for the template.

This example imports a virtual machine template from `Dom0` and uses the template to create a driver domain virtual machine. The virtual machine image is named `myol6u_test myol6u_ol5u7_vm_alpha` from the virtual machine template named `myol6u_15gb1 (OL5U7)`, which is stored in the shared repository named `repo2 (odarepo1)` on Node 0 in driver domain mode.

This example

1. Use the `oakcli import vmtemplate` command to import a virtual machine template and name the template.

For example, import virtual machine template `OVM_OL5U7_X86_64_PVM_10GB.tgz` from the `/OVS` directory in `Dom0` into the `odarepo1` shared repository on Node 0 in driver domain mode and name the template file `OL5U7`.

```
oakcli import vmtemplate OL5U7 -files /OVS/OVM_OL5U7_X86_64_PVM_10GB.tgz -repo
odarepo1
```

2. Use the `oakcli clone vm` command to create a clone that uses the driver domain.

For example, create a virtual machine image named `vm1_ol5u7` from the virtual machine template named `OL5U7`, which is stored in the shared repository named `odarepo1` on Node 0:

clone virtual machine

```
oakcli clone vm vm1_ol5u7 -vmtemplate OL5U7 -repo odarepo1 -node 0 -driverdomain
```

3. Run the `oakcli show vm` command to confirm that the virtual machine is configured in driver domain mode.

When the virtual machine is in driver mode, the output for the `DriverDomain` attribute is `TRUE`.

```
oakcli show vm vm1_ol5u7
```

4. Use the `oakcli start vm` command to start the virtual machine.

For example, start the virtual machine named `vm1_ol5u7` on Node 0.

```
oakcli start vm vm1_ol5u7 -node 0
```

Related Topics

- [oakcli import vmtemplate](#) (page 10-40)
Use the `oakcli import vmtemplate` command to import virtual machine templates.
- [oakcli clone vm](#) (page 10-9)
Use the `oakcli clone vm` command to create clones and snap clones of virtual machines.
- [oakcli show vm](#) (page 10-69)
Use the `oakcli show vm` command to display information about virtual machines.
- [oakcli start vm](#) (page 10-72)
Use the `oakcli start vm` command to start a virtual machine on a node.

9.8.3 Converting a Virtual Machine to a Driver Domain Virtual Machine

Convert a guest virtual machine to a driver domain virtual machine to improve performance.

You can clone an existing virtual machine that uses `Dom0` to create a clone virtual machine that uses the driver domain `ODA_BASE` instead of `Dom0`.

In this example, virtual machine `vm-dom0_ol5u7` is on `Dom0` and is not a driver domain virtual machine. The example creates a clone virtual machine named `vm-dd1_ol5u7` that uses the driver domain `ODA_BASE`.

1. Use the `oakcli stop` command to shut down the virtual machine.

For example, stop the virtual machine named `vm-dom0_ol5u7`. Shutting down the virtual machine ensures that there is consistent data from the virtual machine (vm) and virtual disks (vdisk)

```
oakcli stop vm vm2_ol5u7 -force
```

2. Detach the virtual disk (vdisk) from `vm-dom0_ol5u7`

3. Use the `oakcli clone vm` command to clone a new virtual machine from the original.

Create a new virtual machine named `vm-dd1_ol5u7` from the original virtual machine named `vm-dom0_ol5u7`. Use the `-snap` option to create a snapshot of the source virtual machine. Because the original virtual machine is not a driver domain machine, use the `-force` and `-driverdomain` options to create a clone virtual machine that does use the driver domain.

```
oakcli clone vm vm-dd1_ol5u7 -vm vm-dom0_ol5u7 -snap -force -driverdomain
```

4. Attach the virtual disk (vdisk) that you detached from the source virtual machine in Step 2 to the new driver domain virtual machine.

Attaching the vdisk ensures that the `vm.cfg` has the disk information with the driver domain feature.

5. Verify that `oakDom1` is the vdisk in the new `vm.cfg`.
6. Run the `oakcli show vm` to confirm that the newly created virtual machine is configured in driver domain mode.

When the virtual machine, `vm-dd1_ol5u7`, is in driver domain mode, the output for the `DriverDomain` attribute is `TRUE`.

```
oakcli show vm vm-dd1_ol5u7
```

7. Use the `oakcli start vm` command to start the virtual machine.

For example, start the virtual machine named `vm-dd1_ol5u7` on Node 0.

```
oakcli start vm vm-dd1_ol5u7 -node 0
```

Related Topics

- [oakcli stop command](#) (page 10-73)
Use the `oakcli stop` command to stop a virtual machine, to stop a shared repository on a node, or to stop `ODA_BASE` on the local node.
- [oakcli clone vm](#) (page 10-9)
Use the `oakcli clone vm` command to create clones and snap clones of virtual machines.
- [oakcli show vm](#) (page 10-69)
Use the `oakcli show vm` command to display information about virtual machines.
- [oakcli start vm](#) (page 10-72)
Use the `oakcli start vm` command to start a virtual machine on a node.

9.8.4 Converting a Root Disk to a Driver Domain Disk

Set up your guest virtual machine (guest VM) root disk as a driver domain and create a new disk as the boot driver.

This example clones an existing guest virtual machine as a driver domain guest VM and then uses the `OL6U7_x86_64_PVHVM` template to create a guest VM and create a new disk for the boot driver.

Using the driver domain improves the guest VM disk IO performance; however, the driver domain is not applicable for a guest VM virtual disk that is a boot disk. Because the boot disk is generally the root disk, you must create a new disk to be the boot driver.

You can create a guest virtual machine by cloning an existing guest, or use one of the templates, such as `OL6U7_x86_64_PVHVM` or `OVM_OL5U7_X86_64_PVM_10GB.tgz`, that are available in the `/OVS` directory in `Dom0`.

Using driver domains requires at least Oracle Database Appliance version 12.1.2.7.0. In this example, the following is the layout of disks in the original `OL6U7` virtual machine:

```
- boot/root disk '/dev/xvda' (echo -e "p" | fdisk /dev/xvda):
Device Boot Start End Blocks Id System
/dev/xvda1 * 2 503 514048 83 Linux
/dev/xvda2 504 11264 11019264 83 Linux
/dev/xvda3 11265 15360 4194304 82 Linux swap / Solaris
- u01 disk '/dev/xvdb' (echo -e "p" | fdisk /dev/xvdb):
```

```
Device Boot Start End Blocks Id System
/dev/xvdb1 1 13054 104856223+ 83 Linux
```

The `/etc/fstab` is as follows:

```
# cat /etc/fstab
UUID=b072e1e9-05a9-4544-a4dd-b15ba49cea2f / ext4 defaults 1 1
UUID=301e09e2-78e4-47d6-b501-d4f1098b419d /boot ext4 defaults 1 2
UUID=39e5a125-ald8-48f4-9e81-f9e89b4dd51b swap swap defaults 0 0
tmpfs /dev/shm tmpfs defaults 0 0
devpts /dev/pts devpts gid=5,mode=620 0 0
sysfs /sys sysfs defaults 0 0
proc /proc proc defaults 0 0
UUID=770078eb-c083-4d52-81bf-e026ab3f3fa7 /u01 ext4 defaults 1 2
```

The `df -h` is as follows:

```
# df -h
Filesystem Size Used Avail Use% Mounted on
/dev/xvda2 11G 814M 8.9G 9%
/tmpfs 3.9G 0 3.9G 0% /dev/shm
/dev/xvda1 479M 51M 399M 12% /boot
/dev/xvdb1 92G 55G 33G 63% /u01
```

1. Clone a guest VM as a driver domain guest VM.

You can use one of the following commands to clone a virtual machine:

- `oakcli clone vm vm_name -vmtemplate template_name -repo repo_name [-node 0|1] [-driverdomain]`
- `oakcli clone vm vm_name -vmtemplate src_vmtempl_name -snap [-driverdomain]`
- `oakcli clone vm vm_name -vm src_vm_name -snap [-force] [-driverdomain]`

Note:

You must stop the virtual machine before taking a snapshot.

For example, create a driver domain guest VM named `OL6U7` from the `OL6U7_x86_64_PVHVM` source VM template. Use the `-snap` option to designate that you want to create a snapshot of the source virtual machine and the `-driverdomain` option to indicate that the new virtual machine will use the driver domain.

```
oakcli clone vm OL6U7 -vm OL6U7_x86_64_PVHVM -snap -driverdomain
```

2. Create a new boot virtual disk.

```
dd if=/dev/zero of=/u01/app/sharedrepo/repo name/.ACFS/snaps/vm_name/
VirtualMachines/vm_name/virtual diskfile name.img oflag=direct count=0 bs=1M
seek=new size in MB
```

For example, create a 500 MB boot virtual disk named `newboot` for the `OL6U7` virtual machine that is in the `odarepo1` repository:

```
# dd if=/dev/zero of=/u01/app/sharedrepo/odarepo1/.ACFS/snaps/OL6U7/
VirtualMachines/OL6U7/newboot.img oflag=direct count=0 bs=1M seek=500
```

3. Edit the `vm.cfg` file to attach the new boot disk to your guest VM.

- a. Navigate to the `vm.cfg` file.

```
mkdir /virtual diskfile namemount /dev/xvdc1 /virtual diskfile name
```

a. Setup and mount the new boot disk.

```
mkdir /virtual diskfile namemount /dev/xvdc1 /virtual diskfile name
```

For example, make a directory and mount the `newboot` boot disk:

```
mkdir /newbootmount /dev/xvdc1 /newboot
```

b. Get the single blockID.

```
# blkid /dev/xvdc1/dev/xvdc1: UUID="3d7a177b-0fa0-4212-9c0c-c5554bb1817a"  
TYPE="ext4"
```

8. Copy the original boot content to the new boot disk.

```
cp -dpR /boot/* /virtual diskfile name
```

For example, for the disk named `newboot`:

```
cp -dpR /boot/* /newboot
```

9. Make the new boot partition the active boot partition

```
umount /virtual diskfile nameumount /bootmount /dev/xvdc1 /boot
```

```
umount /newbootumount /bootmount /dev/xvdc1 /boot
```

10. Setup Grub in the new boot disk.

Use the `grub` or `grub2` command, where `/dev/xvdc` is the new boot disk device.

- If you are using Oracle Linux 6U7, use `grub`:

```
# grub  
grub> device (hd0) /dev/xvdc  
grub> root (hd0,0)  
grub> setup (hd0)
```

- If you are using Oracle Linux 7u2, use `grub2`:

```
# grub2-mkconfig -o /boot/grub2/grub.cfg  
# grub2-install /dev/xvdc
```

The following example uses `grub`:

```
# grub  
Probing devices to guess BIOS drives. This may take a long time.  
GNU GRUB version 0.97 (640K lower / 3072K upper memory)  
[ Minimal BASH-like line editing is supported. For the first word, TAB  
lists possible command completions. Anywhere else TAB lists the possible  
completions of a device/filename.]  
grub> device (hd0) /dev/xvdc  
device (hd0) /dev/xvdc  
grub> root (hd0,0)  
root (hd0,0)  
Filesystem type is ext2fs, partition type 0x83  
grub> setup (hd0)  
setup (hd0)  
Checking if "/boot/grub/stage1" exists... no  
Checking if "/grub/stage1" exists... yes  
Checking if "/grub/stage2" exists... yes  
Checking if "/grub/e2fs_stage1_5" exists... yes  
Running "embed /grub/e2fs_stage1_5 (hd0)"... 27 sectors are embedded.  
succeeded
```

```
Running "install /grub/stage1 (hd0) (hd0)1+27 p (hd0,0)/grub/stage2 /grub/
grub.conf"... succeeded
Done.
grub> quit
quit
```

The following example uses grub2:

```
# grub2-mkconfig -o /boot/grub2/grub.cfg
Generating grub configuration file ...
Found linux image: /boot/vmlinuz-3.10.0-327.3.1.el7.x86_64
Found initrd image: /boot/initramfs-3.10.0-327.3.1.el7.x86_64.img
Found linux image: /boot/vmlinuz-3.8.13-118.2.1.el7uek.x86_64
Found initrd image: /boot/initramfs-3.8.13-118.2.1.el7uek.x86_64.img
Found linux image: /boot/vmlinuz-0-rescue-8f9df86c6d4c4640a01315a3aa93790e
Found initrd image: /boot/initramfs-0-
rescue-8f9df86c6d4c4640a01315a3aa93790e.img
done

# grub2-install /dev/xvdc
Installing for i386-pc platform.
Installation finished.
No error reported.
```

11. Edit `/etc/fstab` with the new boot device.

```
UUID=b072e1e9-05a9-4544-a4dd-b15ba49cea2f / ext4 defaults 1 1
#UUID=301e09e2-78e4-47d6-b501-d4f1098b419d /boot ext4 defaults 1 2 <<---
Original boot device
UUID=3d7a177b-0fa0-4212-9c0c-c5554bb1817a /boot ext4 defaults 1 2

UUID=39e5a125-a1d8-48f4-9e81-f9e89b4dd51b swap swap defaults 0 0
tmpfs /dev/shm tmpfs defaults 0 0
devpts /dev/pts devpts gid=5,mode=620 0 0
sysfs /sys sysfs defaults 0 0
proc /proc proc defaults 0 0

UUID=770078eb-c083-4d52-81bf-e026ab3f3fa7 /u01 ext4 defaults 1 2
```

12. Edit the `vm.cfg` file and make the new boot virtual disk the first disk on the list.

Note:

The driver domain device use the following root path `/u01/app/sharedrepo`. The boot disk root path is `/OVS/Repositories`.

The entries in the disk section of the `vm.cfg` file will look something like the following:

```
u'file:/OVS/Repositories/rcrepo/.ACFS/snaps/OL6U7/VirtualMachines/
OL6U7/15f96d92a66c4b808035116ab6348d0d.img,xvda,w',
<<-- original boot/root disk
u'file:/u01/app/sharedrepo/rcrepo/.ACFS/snaps/oakvdk_ol6u7_u01/VirtualDisks/
oakvdk_ol6u7_u01,xvdb,w,oakDom1',
<<-- original u01 disku'file:/OVS/Repositories/rcrepo/.ACFS/snaps/OL6U7/
VirtualMachines/OL6U7/newboot.img,xvdc,w'
<<-- new boot disk
```

Move the new boot virtual disk, `newboot`, to the first disk on the list.

```

u'file:/OVS/Repositories/rcrepo/.ACFS/snaps/OL6U7/VirtualMachines/OL6U7/
newboot.img,xvda,w'
<<-- new boot disk
u'file:/u01/app/sharedrepo/rcrepo/.ACFS/snaps/OL6U7/VirtualMachines/
OL6U7/15f96d92a66c4b808035116ab6348d0d.img,xvdb,w,oakDom1
<<-- original boot/root disku'file:/u01/app/sharedrepo/rcrepo/.ACFS/snaps/
oakvdk_ol6u7_u01/VirtualDisks/oakvdk_ol6u7_u01,xvdc,w,oakDom1'
<<-original u01 disk

```

The new boot device (`xvdc`) becomes the first device (not driver domain) and `xvda` is the second domain driver device.

The following is an example of the `vm.cfg` before the edit:

```

# cat vm.cfg
vif = ['type=netfront,bridge=net1']
name = 'OL6U7'
extra = 'NODENAME=OL6U7'
builder = 'hvm'
cpus =
'24,25,26,27,28,29,30,31,32,33,34,35,36,37,38,39,40,41,42,43,44,45,46,47,48,49,50
,51,52,53,54,55,56,57,58,59,60,61,62,63,64,65,6
vcpus = 2
memory = 8192
cpu_cap = 0
vnc = 1
serial = 'pty'
disk =
[u'file:/OVS/Repositories/rcrepo/.ACFS/snaps/OL6U7/VirtualMachines/
OL6U7/15f96d92a66c4b808035116ab6348d0d.img,xvda,w',
u'file:/u01/app/sharedrepo/rcrepo/.ACFS/snaps/oakvdk_ol6u7_u01/VirtualDisks/
oakvdk_ol6u7_u01,xvdb,w,oakDom1',
u'file:/OVS/Repositories/rcrepo/.ACFS/snaps/OL6U7/VirtualMachines/OL6U7/
newboot.img,xvdc,w']
maxvcpus = 2
maxmem = 8192

```

The following is an example of the `vm.cfg` after the edit, where the new boot device (`xvdc`) is the first device and `xvda` is the driver domain device:

```

# cat vm.cfg
vif = ['type=netfront,bridge=net1']
name = 'OL6U7'
extra = 'NODENAME=OL6U7'
builder = 'hvm'
cpus =
'24,25,26,27,28,29,30,31,32,33,34,35,36,37,38,39,40,41,42,43,44,45,46,47,48,49,50
,51,52,53,54,55,56,57,58,59,60,61,62,63,64,65,6
vcpus = 2
memory = 8192
cpu_cap = 0
vnc = 1
serial = 'pty'
disk =[
[u'file:/OVS/Repositories/rcrepo/.ACFS/snaps/OL6U7/VirtualMachines/OL6U7/
newboot.img,xvda,w',
u'file:/u01/app/sharedrepo/u'file:/u01/app/sharedrepo/rcrepo/.ACFS/snaps/
oakvdk_ol6u7_u01/VirtualDisks/oakvdk_ol6u7_u01,xvdc,w,oakDom1']
maxvcpus = 2
maxmem = 8192

```

13. Stop and restart the guest VM

```
oakcli stop vm vm_name
oakcli start vm vm_name
```

```
oakcli stop vm OL6U7
oakcli start vm OL6U7
```

14. Check the layout of the new disks.

The layout should be similar to the following:

```
# df -h
Filesystem Size Used Avail Use% Mounted on/dev/xvdb2 11G 814M 8.9G 9% /
tmpfs 3.9G 0 3.9G 0% /dev/shm
/dev/xvda1 471M 51M 391M 12% /boot
/dev/xvdc1 92G 55G 33G 63% /u01
```

The swap device is now under the driver domain: /dev/xvdb

```
# swapon -s
Filename Type Size Used Priority
/dev/xvdb3 partition 4194300 0 -1
```

15. (Optional) Synchronize the oakcli virtual machine inventory with the `vm.cfg` file.

When you edit the `vm.cfg` file, the `oakcli show vm vm_name` output displays incorrect information about the disk. You can create a temporary duplicate (snapshot) of the virtual machine to fix the output.

```
oakcli stop vm vm_name
oakcli clone vm tmp_vm_name -vm vm_name -snap -driverdomain
oakcli delete vm vm_name
oakcli clone vm vm_name -vm tmp_vm_name -snap -driverdomain
oakcli delete vm tmp_vm_name
```

Note:

Stop the virtual machine before taking a snapshot.

For example, create a temporary clone called `tmp_OL6U7` of the virtual machine `OL6U7` using the `-snap` and `-driverdomain` options. Delete the virtual machine `OL6U7`, and then use the temporary clone to create a new clone. Delete the temporary virtual machine.

```
oakcli stop vm OL6U7
oakcli clone vm tmp_OL6U7 -vm OL6U7 -snap -driverdomain
oakcli delete vm OL6U7
oakcli clone vm OL6U7 -vm tmp_OL6U7 -snap -driverdomain
oakcli delete vm tmp_OL6U7
```

Note:

The `oakcli clone vm` command creates a duplicate (snapshot) of the VDisks that are attached to the guest VM. Use the `oakcli delete vdisk` command to remove the orphan VDisks.

Run the `oakcli show vm vm_name` command to verify that the oakcli virtual machine inventory is in sync with the `vm.cfg` file.

```

# oakcli show vm OL6U7
The Resource is : OL6U7
AutoStart : restore
CPUPriority : 100
Disks : |file:/OVS/Repositories/rcrepo/.ACF
S/snaps/OL6U7/VirtualMachines/OL6U7
/newboot.img,xvda,w||file:/u01/app/
sharedrepo/rcrepo/.ACFS/snaps/OL6U7
/VirtualMachines/OL6U7/15f96d92a66c
4b808035116ab6348d0d.img,xvdb,w,oak
Dom1 |
Domain : XEN_PVM
DriverDomain : True
ExpectedState : offline
FailOver : false
IsSharedRepo : true
Keyboard : en-us
MaxMemory : 8192M
MaxVcpu : 2
Memory : 8192M
Mouse : OS_DEFAULT
Name : OL6U7
Networks : |type=netfront,bridge=net1|
NodeNumStart : 0
OS : OL_5
PrefNodeNum : 0
PrivateIP : None
ProcessorCap : 0
RepoName : rcrepo
State : Offline
TemplateName : tmp_OL6U7
VDisks : |oakvdk_snap_3_ol6u7_u01_rcrepo|
Vcpu : 2
cpupool : default-unpinned-pool

```

9.9 How to Manage High Availability on Oracle Database Appliance Virtualized Platform

Use the `oakcli configure vm` command to configure high availability services for your virtual machines.

A system that is highly available is designed to provide uninterrupted computing services during essential time periods, during most hours of the day, and during most days of the week throughout the year. Reliability, recoverability, timely error detection, and continuous operations are primary characteristics of a highly available solution. Two essential parts of high availability are automatic restart and failover.

Unless you are using local repositories, you can set high availability options for your virtual machines. High availability options identify the node where the virtual machine should be started by default and whether the virtual machine should be failed over to the other node. Failover can occur if the node where the virtual machine is already running fails or if the preferred node is not available when the virtual machines attempt to start.

Configuring Automatic Restart for High Availability

A virtual machine automatically restarts after a hardware or software failure or whenever your database host computer restarts. Use the `oakcli configure vm` command to start a virtual machine on a preferred node by using the `-prefnode` option.

Configuring Failover for High Availability

Configuring failover provides high availability by enabling a virtual machine to restart on the other node after an unplanned failure, without requiring manual intervention. Use the command `oakcli configure vm` with the `-failover` option to configure fail over from one node to another.

9.10 How to Manage CPU Pools on Oracle Database Appliance Virtualized Platform

These topics describe how to use OAKCLI to create and manage CPU pools on Oracle Database Appliance Virtualized Platform.

- [About Managing CPU Pools for Resource Allocation](#) (page 9-39)
Use CPU pools to cage and manage resource allocations to workloads for virtual machines on Oracle Database Appliance Virtualized Platforms.
- [About Over-Subscribed CPU Pools](#) (page 9-40)
Configure virtual machines so that they do not subscribe to more CPU resources than the resources available in CPU pools.
- [Creating a New CPU Pool on Oracle Database Appliance Virtualized Platform Nodes](#) (page 9-41)
Use the command `oakcli create cpupool` to create a CPU pool.
- [Showing the CPU Pools Configured on Oracle Database Appliance Virtualized Platform Nodes](#) (page 9-41)
Use the command `oakcli show cpupool` command to display the CPUs assigned to each defined CPU pool.
- [Changing the Number of CPUs Assigned to a CPU Pool on Oracle Database Appliance Virtualized Platform Nodes](#) (page 9-41)
Use the `oakcli configure cpupool` command to change the number of CPUs assigned to a CPU pool.
- [Assigning a Virtual Machine to a CPU Pool on Oracle Database Appliance Virtualized Platform](#) (page 9-42)
Use the command `oakcli configure vm` to assign a virtual machine to a CPU pool.

9.10.1 About Managing CPU Pools for Resource Allocation

Use CPU pools to cage and manage resource allocations to workloads for virtual machines on Oracle Database Appliance Virtualized Platforms.

Workloads are isolated by creating CPU pools and assigning (pinning) virtual machines to a specific CPU pool. When you pin a virtual machine to a CPU pool, you ensure that the virtual machine uses CPUs in only that CPU pool.

When you initially configure Oracle Database Appliance Virtualized Platform, a default-unpinned-pool is created on each node. The size of this pool depends on the hardware model.

When you create the ODA_BASE domain, a new CPU pool is created on both nodes. The pool is named `odaBaseCpuPool`. The CPUs required for this pool are removed from the default-unpinned-pool. ODA_BASE is the only domain allowed to use the CPUs in the `odaBaseCpuPool`. When you start other virtual machines, the virtual machines run on CPUs that are left in the default-unpinned-pool, effectively removing ODA_BASE from the work being done by other virtual machines.

You can also cage groups of virtual machines by creating additional CPU pools. These additional pools enable you to pin a virtual machine, or a set of virtual machines, to its own CPU pool. Virtual machines running in a specific CPU pool do not share CPU cycles with virtual machines running in other CPU pools. Define as many CPU pools as you want, up to the number of available CPUs on your system.

If your application requirements change over time, then Oracle recommends that you resize, add, or drop CPU pools as needed to make the best use of your resources. You may also want to resize ODA_BASE. However, if you want to resize ODA_BASE, then you must use a special command that also updates your Oracle Database Appliance Virtualized Platform license.

Example 9-21 Example of Showing CPU Pools on a Node

A CPU pool can have a different size on each node (except for the `odaBaseCpuPool`), as shown by the following `oakcli show cpupool` commands, one for each node:

```
oakcli show cpupool -node 0
      Pool                               Cpu List
default-unpinned-pool [14, 15, 16, 17, 18, 19, 20, 2
                        1, 22, 23]
      twocpu                             [12, 13]
odaBaseCpuPool [0, 1, 2, 3, 4, 5, 6, 7, 8, 9,
                        10, 11]

oakcli show cpupool -node 1
      Pool                               Cpu List
default-unpinned-pool [12, 13, 14, 15, 16, 17, 18, 1
                        9, 20, 21, 22, 23]
odaBaseCpuPool [0, 1, 2, 3, 4, 5, 6, 7, 8, 9,
                        10,11]
```

9.10.2 About Over-Subscribed CPU Pools

Configure virtual machines so that they do not subscribe to more CPU resources than the resources available in CPU pools.

A CPU resource can belong to one, and only one, CPU pool. You can assign multiple virtual machines to a CPU pool. A CPU pool becomes oversubscribed when the virtual machines that are active in the pool require more CPUs than you configured for the pool. For example, if a CPU pool has four CPUs, then you can start two virtual machines that are defined to use four CPUs each. In this case, the CPU pool is oversubscribed, because each of the four CPUs is supporting two virtual machines.

If you stop one of those virtual machines, but start another one that requires two CPUs, then the CPU pool is still oversubscribed. This is because two of the CPUs are supporting both virtual machines. When oversubscribing a CPU pool, assess the

performance of the virtual machines in that pool. Reassign one or more virtual machines to a different CPU pool if sharing an oversubscribed pool degrades performance to unacceptable levels.

9.10.3 Creating a New CPU Pool on Oracle Database Appliance Virtualized Platform Nodes

Use the command `oakcli create cpupool` to create a CPU pool.

Manage resource use by creating CPU pools, and then assign these resources to virtual machines.

Example 9-22 Example of Creating a New CPU Pool on Oracle Database Appliance Virtualized Platform Nodes

This example creates a CPU pool named `winpool` that is allocated 4 CPUs on Node 0:

```
oakcli create cpupool winpool -numcpu 4 -node 0
```

9.10.4 Showing the CPU Pools Configured on Oracle Database Appliance Virtualized Platform Nodes

Use the command `oakcli show cpupool` command to display the CPUs assigned to each defined CPU pool.

You can use `oakcli show cpupool` to display any virtual machines assigned to each CPU pool.

Example 9-23 Example of Showing CPUs Assigned to Defined CPU Pools on Oracle Database Appliance Virtualized Platform Nodes

This `oakcli show cpupool` example shows the CPUs assigned to each defined CPU pool on Node 0:

```
oakcli show cpupool -node 0
```

9.10.5 Changing the Number of CPUs Assigned to a CPU Pool on Oracle Database Appliance Virtualized Platform Nodes

Use the `oakcli configure cpupool` command to change the number of CPUs assigned to a CPU pool.

An Oracle VM Server can belong to only one virtual pool. However, you can change the resources allocated to a virtual pool to increase the CPU resources available to the virtual machine.

Example 9-24 Example of Changing the Number of CPUs Assigned to a CPU Pool on Oracle Database Appliance Virtualized Platform Nodes

This `oakcli configure cpupool` example changes the number of CPUs assigned to the CPU pool named `linpool` on Node 1. After the command runs, the new number of CPU resources assigned to the CPU are six.

```
oakcli configure cpupool linpool -numcpu 6 -node 1
```

9.10.6 Assigning a Virtual Machine to a CPU Pool on Oracle Database Appliance Virtualized Platform

Use the command `oakcli configure vm` to assign a virtual machine to a CPU pool.

Review the availability of CPU pools on nodes as part of your placement policy for virtual machines on Oracle Database Appliance Virtualized Platforms.

If your virtual machine is assigned to a specific CPU pool, and the virtual machine is allowed to fail over, then the virtual machine attempts to use the same CPU pool on the secondary node. If the CPU pool exists on the other node, but the CPU pool is a different size, then the performance of your virtual machine can be affected when it runs on the secondary node. If the assigned CPU pool does not exist on the secondary node, then the virtual machine cannot fail over.



Note:

Do not manage `odaBaseCpuPool` by using `oakcli cpupool` commands. Instead, use commands that configure `ODA_BASE`, as discussed in "How to Resize ODA_BASE."

Example 9-25 Example of Assigning a Virtual Machine to a CPU Pool on Oracle Database Appliance Virtualized Platform

This `oakcli configure vm` example pins the virtual machine named `wintest` to the CPU pool named `winpool`:

```
oakcli configure vm wintest -cpupool winpool
```

9.11 About Network Infrastructure and Virtual Local Area Networks on Oracle Database Appliance Virtualized Platform

To specify which network you want to use to access a virtual machine, you employ network infrastructure components of Oracle Database Appliance Virtualized Platform.

Oracle Database Appliance Virtualized Platform manages all of the high-level network infrastructure components for you by pre-creating the bridges for all networks. The front-end point for accessing a virtual machine is one of the bridges defined for `Dom0`.

The network interfaces differ, depending on your Oracle Database Appliance hardware. In all cases, connections to user domains are through the selected interfaces. Refer to the tables for your Oracle Database Appliance. Refer to the figure "Basic Virtual Machine Local Area Network" for an overview of network interface configuration.

Configuration Overview of Oracle Database Appliance Virtual Machine Local Area Networks

When you configure a virtual machine, you define which network the virtual machine should use by identifying the related bridge.

For example, to connect a virtual machine named `myvm1` to the `net1` network, you would use the following command:

```
oakcli modify vm myvm1 -addnetwork net1
```

The illustration "Basic Virtual Machine Local Area Network" shows a typical Oracle Database Appliance local area network configuration that results from this virtual machine network configuration:

Figure 9-3 Basic Virtual Machine Local Area Network

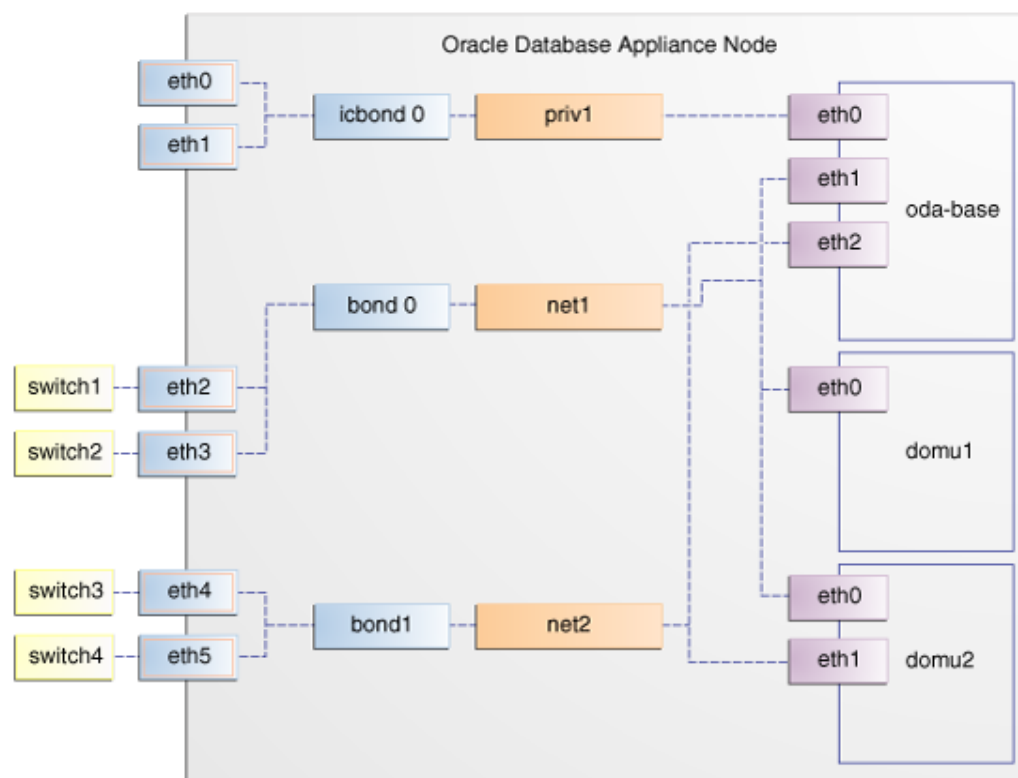

You assign default Virtual Local Area Networks (VLANs) to ODA_BASE during the installation and configuration of Oracle Database Appliance Virtualized Platform. The figure "Oracle Database Appliance Virtualized Platform with Virtual Local Area Networks" shows a typical Oracle Database Appliance configuration using VLANs. The illustration shows the same configuration as in "Basic Virtual Machine Local Area Networks," but with three tagged VLANs added for backups (backup), for applications (application), and for management (mgnt).

Figure 9-4 Oracle Database Appliance Virtualized Platform with Virtual Local Area Networks

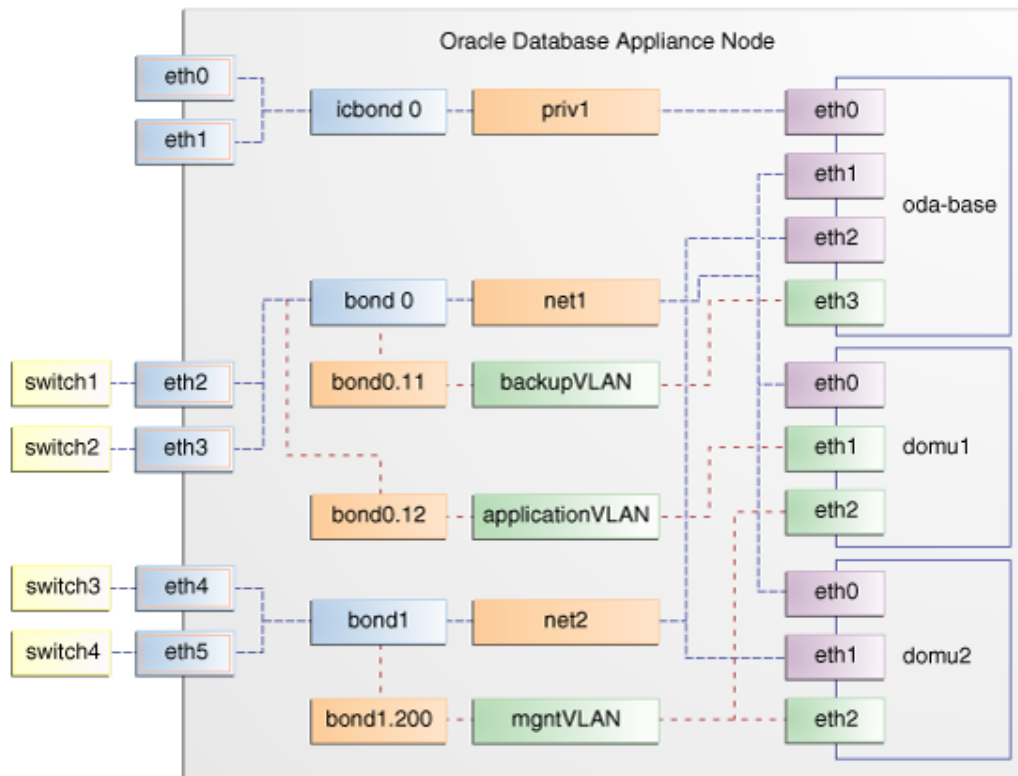

9.12 Managing Virtual Local Area Networks on User Domains and on ODA_BASE

Use these examples to understand how to configure and manage virtual local area networks (VLANs).

To manage VLANs for user domains, log in to ODA_BASE. To manage VLANs for ODA_BASE, log in to Dom0. The examples in this section use a VLAN named `sample10`.

 **Note:**

You can configure VLANs on the physical switches from Dom0 before deploying Oracle Database Appliance or Oracle Database Appliance Virtualized Platform.

Example 9-26 Example of Creating a Virtual Local Area Network

1. Prepare the following information to create a VLAN:
 - A VLAN name that is unique on the node where the VLAN is created (but which can be the same as a VLAN name on the other node of Oracle Database Appliance Virtualized Platform).

- A VLAN tag number between 2 to 4096 inclusive that is unique on the node where the VLAN is created (but which can be the same as a VLAN tag number on the other node of Oracle Database Appliance Virtualized Platform).
 - The name of the interface on which the VLAN is to be created. Find the available interfaces for your hardware listed in the **Bond Devices at Dom0** column in the tables in "About Network Infrastructure and Virtual Local Area Networks on Oracle Database Appliance Virtualized Platform."
 - The node on which to create the VLAN
2. Enter the following command to start creating the VLAN. Enter the information you have prepared when prompted:

```
oakcli create vlan
```

 **Note:**

If you need to create the same VLAN on both nodes, then enter the command `oakcli create vlan` twice: once for Node 0 and once for Node 1.

The following `oakcli create vlan` example creates the VLAN `sample10` on Node 0:

```
oakcli create vlan sample10 -vlanid 10 -if bond0 -node 0
```

 **Caution:**

If you are planning to use a VLAN with a virtual machine created in a shared repository, then create that VLAN on both nodes. A virtual machine fails if an assigned network is not available on the node where the virtual machine is configured to run by default, or where the virtual machine is configured to start up following a failover.

Example 9-27 Example of Assigning and Removing a Virtual Local Area Network for a User Domain

Use the `oakcli modify vm` command with the option `-addnetwork` to assign an existing VLAN to a virtual machine and with a `-deletenetwork` clause to remove a VLAN from a virtual machine. The clauses must also contain the name of the VLAN.

The following `oakcli modify vm` example assigns the `sample10` VLAN to the virtual machine `myol5u_test`:

```
oakcli modify vm myol5u_test -addnetwork sample10
```

Example 9-28 Example of Assigning and Removing a Virtual Local Area Network for ODA_BASE

Use the command `oakcli configure oda_base` to add an existing VLAN to ODA_BASE, or to remove a VLAN from ODA_BASE. Note that this command also enables you to resize ODA_BASE and domain memory size. If you only want to

manage VLANs, then enter the number that corresponds to the number of your current CPU cores and the current number for your memory.

In the following partial example, the CPU core count and default memory values are left unchanged, while the VLAN `test01` is assigned to `ODA_BASE`. Note that the current CPU core count, 6, corresponds to selection number 3 in the Core Licensing Options list of values.

```
# oakcli configure oda_base
Core Licensing Options:
  1. 2 CPU Cores
  2. 4 CPU Cores
  3. 6 CPU Cores
  4. 8 CPU Cores
  5. 10 CPU Cores
  6. 12 CPU Cores
Current CPU Cores      :6
Selection[1 : 6](default 12 CPU Cores) : 3
ODA base domain memory in GB(min 8, max 88)(Current Memory 48G)[default
64]      : 48
INFO: Using default memory size i.e. 64 GB
Additional vlan networks to be assigned to oda_base? (y/n) [n]: y
Select the network to assign (test00,test01,test02,test03): test01
Additional vlan networks to be assigned to oda_base? (y/n) [n]:
Vlan network to be removed from oda_base (y/n) [n]:
INFO: . . .
```

Example 9-29 Example of Viewing Virtual Local Area Networks

To see what VLANs currently exist in `ODA_BASE`, run the `oakcli show vlan` command.

The following example shows VLANs in addition to the `sample10` VLAN used in previous examples:

```
oakcli show vlan

NAME          ID    INTERFACE    NODENUM
----          -
net1          1     bond0        0
net1          1     bond0        1
net2          1     bond1        0
net2          1     bond1        1
net3          2     bond1        0
net3          4     bond0        1
net10         20    bond1        0
net10         20    bond1        1
```

Example 9-30 Example of Deleting Virtual Local Area Networks

To remove an unwanted VLAN from a node, use the `oakcli delete vlan` command and provide the VLAN name and the node number.

This example remove the VLAN `sample10` from Node 0 (where the VLAN was assigned in the earlier `oakcli create vlan` example):

```
oakcli delete vlan sample10 -node 0
```

 **Note:**

You cannot delete a native VLAN. A native VLAN is a virtual local area network configured during the deployment of Oracle Database Appliance Virtualized Platform software.

9.13 How to Resize ODA_BASE

You can increase or decrease the number of CPU cores that you assign the ODA_BASE domain to add or reduce computing power and memory as required for your workloads.

Topics:

- [About Resizing ODA_BASE](#) (page 9-47)
Oracle recommends that you use the following guidelines in reviewing your ODA_BASE resource allocation, and in carrying out resizing.
- [Changing the ODA_BASE Core Count](#) (page 9-47)
After you have reviewed the guidelines about resizing ODA_BASE, complete these steps to change the ODA_BASE core count.

9.13.1 About Resizing ODA_BASE

Oracle recommends that you use the following guidelines in reviewing your ODA_BASE resource allocation, and in carrying out resizing.

Increase the number of CPU cores assigned to the ODA_BASE domain on Oracle Database Appliance Virtualized Platform if you need more computing power or memory for your installed Oracle databases. Alternatively, decrease the CPU cores if you need more CPUs assigned to your virtual machine domains. You must increase or decrease the assigned CPU core count on each node by two or multiples of two.

Oracle recommends that you use templates to size the databases that you deploy in ODA_BASE, following the guidelines in Appendix A of *Oracle Database Appliance Getting Started Guide*. Sum the number of CPUs that these databases require, using the tables in that appendix, and divide the value by two to determine the number of CPU cores that you require for ODA_BASE.

The ODA_BASE domain shuts down during the resizing process. For this reason, plan to change your ODA_BASE core count either when there is no critical activity running on your Oracle databases, or when you schedule a planned maintenance window.

9.13.2 Changing the ODA_BASE Core Count

After you have reviewed the guidelines about resizing ODA_BASE, complete these steps to change the ODA_BASE core count.

1. Log in to Dom0 and run the `oakcli configure oda_base` command as shown in this example, which changes the CPU core count from six to eight in ODA_BASE:

```
# oakcli configure oda_base
Core Licensing Options:
  1. 2 CPU Cores
```

```
2. 4 CPU Cores
3. 6 CPU Cores
4. 8 CPU Cores
5. 10 CPU Cores
6. 12 CPU Cores
Current CPU Cores      :6
Selection[1 : 6](default 12 CPU Cores) : 10
ODA base domain memory in GB(min 8, max 88)(Current Memory 64G)[default
32]      :
INFO: Using default memory size i.e. 32 GB
Additional vlan networks to be assigned to oda_base? (y/n) [n]:
Vlan network to be removed from oda_base (y/n) [n]
INFO: Node 0:Configured oda base pool
INFO: Node 1:Configured oda base pool
INFO: Node 0:ODA Base configured with new memory
INFO: Node 0:ODA Base configured with new vcpus
INFO: Changes will be incorporated after the domain is restarted on Node 0
INFO: Node 1:ODA Base configured with new memory
INFO: Node 1:ODA Base configured with new vcpus
INFO: Changes will be incorporated after the domain is restarted on Node 1
```

2. Perform any actions listed in the output from the command. Not all versions of the software, such as the one shown in the preceding example, require any additional actions before restarting ODA_BASE.
3. Restart the domain to implement the changed configuration for ODA_BASE by running the following restart command on Dom0 of both nodes:

```
oakcli restart oda_base
```

10

Oracle Appliance Manager Command Line Interface

Oracle Appliance Manager Command Line Interface (OAKCLI) is a command line interface (CLI) dedicated to Oracle Database Appliance.

Topics:

- [About the Oracle Appliance Manager Command-line Interface \(OAKCLI\)](#) (page 10-3)
The `oakcli` commands are the primary method for performing database and system administration on Oracle Database Appliance, and on Oracle Database Appliance Virtualized Platform.
- [Managing OAKCLI Privileges and Security with SUDO](#) (page 10-4)
Oracle Appliance Manager command-line utility requires `root` system privileges for most administration actions. You may want to use SUDO as part of your system auditing and security policy.
- [oakcli add disk -local](#) (page 10-6)
Use the `oakcli add disk -local` command to add a local disk to the system after physically replacing a failed disk.
- [oakcli apply](#) (page 10-7)
Use the `oakcli apply` command from Node 0 to reconfigure your Oracle Database Appliance core capacity.
- [oakcli clone commands](#) (page 10-8)
Use the `oakcli clone` commands to clone virtual machines or virtual disks.
- [oakcli configure commands](#) (page 10-11)
Use the `oakcli configure` commands to configure components on Oracle Database Appliance.
- [oakcli copy](#) (page 10-21)
Use the `oakcli copy` command to prepare a copy of the configuration file for use during the configuration of Oracle Database Appliance.
- [oakcli create commands](#) (page 10-21)
Use the `oakcli create` commands to create components on Oracle Database Appliance.
- [oakcli delete commands](#) (page 10-32)
Use the `oakcli delete` commands to delete components from Oracle Database Appliance.
- [oakcli deploy](#) (page 10-37)
Use the command `oakcli deploy` to deploy Oracle Grid Infrastructure for a cluster on Oracle Database Appliance.
- [oakcli describe-cpucores](#) (page 10-38)

- [oakcli expand storage](#) (page 10-39)
Use the `oakcli expand storage` command to configure the solid-state drives (SSDs) for data storage into the existing base configuration to fully populate the base storage shelf.
- [oakcli diskwritecache](#) (page 10-40)
Use the `oakcli diskwritecache` command to locate disks with write cache enabled and to disable disk write cache for those disks.
- [oakcli import vmtemplate](#) (page 10-40)
Use the `oakcli import vmtemplate` command to import virtual machine templates.
- [oakcli locate disk](#) (page 10-42)
Use the `oakcli locate disk` command to locate the physical disk that is associated with a named Oracle ASM disk by turning the disk's LED light on or off.
- [oakcli manage diagcollect](#) (page 10-42)
Use the `oakcli manage diagcollect` command to collect diagnostic information about Oracle Database Appliance for troubleshooting purposes, and for working with Oracle Support Services.
- [oakcli migrate vm](#) (page 10-43)
Use the `oakcli migrate vm` command to migrate a currently running virtual machine to another node.
- [oakcli modify commands](#) (page 10-44)
Use the `oakcli modify` commands to modify the database, an existing virtual machine or virtual machine template.
- [oakcli orachk](#) (page 10-46)
Use the `oakcli orachk` command to audit configuration settings with the ORAchK utility.
- [oakcli reconfigure osparams](#) (page 10-48)
Use the `oakcli reconfigure osparams` command to adjust the kernel parameters based on the available RAM after you upgrade memory or DIMM.
- [oakcli resize dbstorage](#) (page 10-49)
Use the `oakcli resize dbstorage` command to resize the space used for a storage structure that was created for the purpose of migrating databases from Oracle ASM to Oracle ACFS.
- [oakcli restart oda_base](#) (page 10-49)
Use the `oakcli restart oda_base` command to stop and restart ODA_BASE on the local node.
- [oakcli show commands](#) (page 10-50)
Use the `oakcli show` commands to display the status of Oracle Database Appliance components.
- [oakcli start commands](#) (page 10-71)
Use the `oakcli start` commands to start a virtual machine, to start a shared repository on a node, or to start ODA_BASE on the local node.
- [oakcli stop command](#) (page 10-73)
Use the `oakcli stop` command to stop a virtual machine, to stop a shared repository on a node, or to stop ODA_BASE on the local node.
- [oakcli stordiag](#) (page 10-74)
Use the `oakcli stordiag` command to run diagnostic tests on a disk in the storage shelf or storage expansion shelf.

- [oakcli test asr](#) (page 10-75)
Use the `oakcli test asr` command to send a test trap to determine if Oracle Auto Service Request (Oracle ASR) is configured and working correctly.
- [oakcli unpack](#) (page 10-75)
Use the `oakcli unpack` command to unpack packages into the Oracle Appliance Manager repository.
- [oakcli update](#) (page 10-75)
Use the `oakcli update` command to apply Oracle Database Appliance patches.
- [oakcli update-cpucores](#) (page 10-77)
Use the `oakcli update-cpucores` command to enable a specified number of licensed CPU cores for Oracle Database Appliance.
- [oakcli upgrade](#) (page 10-78)
Use the `oakcli upgrade` command to upgrade the Oracle Database software on Oracle Database Appliance.
- [oakcli validate](#) (page 10-79)
Validates the state of an Oracle Database Appliance or the viability of an operating system patch.

10.1 About the Oracle Appliance Manager Command-line Interface (OAKCLI)

The `oakcli` commands are the primary method for performing database and system administration on Oracle Database Appliance, and on Oracle Database Appliance Virtualized Platform.

You can perform the following tasks with OAKCLI commands:

- List the hardware components
- Validate and diagnose the hardware components
- Install and upgrade software
- Apply software patches
- Create and drop databases
- Install and uninstall Oracle Homes
- Deploy and manage virtual machines
- Test Oracle Auto Service Request (Oracle ASR)
- Enable CPU cores

Depending on your version of Oracle Appliance Manager and your hardware, some of the OAKCLI commands may not be available to you. To see which OAKCLI commands are supported on your version of Oracle Appliance Manager and your hardware, run the help command for OAKCLI: `oakcli -h`

OAKCLI Command Location and Path Configuration

The Oracle Appliance Manager command-line interface is in the following directory:

```
/opt/oracle/oak/bin/oakcli
```

Configure the `root` user account on your Oracle Database Appliance servers to have the `PATH` variable defined to search for oakcli commands in the path `/opt/oracle/oak/bin/oakcli`.

OAKCLI Syntax

Oracle Appliance Manager command-line interface commands and parameters are case-insensitive.

An oakcli command uses the following command syntax:

```
oakcli command object [options]
```

- *command* is an action you want to perform on the appliance. For example: `show`, `locate`, `apply`.
- *object* is the target or object on which the oakcli command performs the operation. For example, you issue a command to create or configure a disk, or a controller, or perform other system or software administration. You can also use object abbreviations.
- *options* are optional parts of the oakcli command. Options can consist of one or more options that extend the use of the oakcli command carried out on an object. Options include additional information about the action that you want to perform on the object. Option names are preceded with a dash. Many options require the name of an object for the command to perform the action that you want to carry out. The help option (`-h`) is an option that is available with every command. When you include the `-h` option, you can obtain additional information about the command that you want to perform.

Oracle Appliance Manager Command-Line Interface Help

Run the following command to see the usage information for all oakcli commands available for your Oracle Database Appliance:

```
oakcli -h
```

Run the following command to see detailed help about a specific oakcli command:

```
oakcli command -h
```

Run the following command to see detailed help about a specific oakcli command carried out on an object, and the options that are available for you to use with that object.

```
oakcli command object -h
```

10.2 Managing OAKCLI Privileges and Security with SUDO

Oracle Appliance Manager command-line utility requires `root` system privileges for most administration actions. You may want to use SUDO as part of your system auditing and security policy.

For most tasks, Oracle recommends that you log in as `root` to use the Oracle Appliance Manager command-line interface on Oracle Database Appliance. If you are not logged in as `root`, then you cannot carry out most actions on the appliance. For example, if you are not logged in as `root`, then you can view storage information, but you cannot modify the storage.

Allowing Root User Access Using SUDO

In environments where system administration is handled by a different group than database administration, or where security is a significant concern, you may want to limit access to the `root` user account and password. SUDO enables system administrators to grant certain users (or groups of users) the ability to run commands as `root`, while logging all commands and arguments as part of your security and compliance protocol.

A SUDO security policy is configured by using the file `/etc/sudoers`. Within the `sudoers` file, you can configure groups of users and sets of commands to simplify and audit server administration with SUDO commands.

Caution:

Configuring SUDO to allow a user to perform any operation is equivalent to giving that user `root` privileges. Consider carefully if this is appropriate for your security needs.

SUDO Example 1: Allow a User to Perform Any OAKCLI Operation

This example shows how to configure SUDO to enable a user to perform any OAKCLI operation. You do this by adding lines to the commands section in the `/etc/sudoers` file:

```
## The commands section may have other options added to it.
##
Cmnd_Alias OAKCLI_CMDS=/opt/oracle/oak/bin/oakcli *
jdoe ALL = OAKCLI_CMDS
```

In this example, the user name is `jdoe`. The file parameter setting `ALL= OAKCLI_CMDS` grants the user `jdoe` permission to run all `oakcli` commands that are defined by the command alias `OAKCLI_CMDS`. After configuration, you can copy one `sudoers` file to multiple hosts. You can also create different rules on each host.

Note:

Before database creation, you must set up user equivalency with SSH for the root user on each server. If you do not set up user equivalency and configure SSH on each server, then you are prompted to provide the root password for each server during database creation.

After you configure the `sudoer` file with the user, the user `jdoe` can run the set of `oakcli` commands configured with the command alias `OAKCLI_CMDS`. For example:

```
$ sudo oakcli create database -db newdb
```

```
INFO: 2015-08-05 14:40:55: Look at the logfile '/opt/oracle/oak/log/scaoda1011/
tools/12.1.2.4.0/createdb_newdb_91715.log' for more details
```

```
INFO: 2015-08-05 14:40:59: Database parameter file is not provided. Will be using
```

```

default parameters for DB creation
Please enter the 'SYSASM' password:
Please re-enter the 'SYSASM' password:

INFO: 2015-08-05 14:41:10: Installing a new home: OraDb12102_home3 at /u01/app/
oracle/product/12.1.0.2/dbhome_3

Please select one of the following for Database type [1 .. 3]:
1   => OLTP
2   => DSS
3   => In-Memory

```

SUDO Example 2: Allow a User to Perform Only Selected OAKCLI Operations

To configure SUDO to allow a user to perform only selected OAKCLI operations, add lines to the commands section in the `/etc/sudoers` file as follows:

```

## oakcli commands
Cmnd_Alias OAKENV = /opt/oracle/oak/bin/oakcli show env_hw
Cmnd_Alias OAKVER = /opt/oracle/oak/bin/oakcli show version
oracle ALL= OAKENV,OAKVER

```

The following are sample outputs for the commands:

```

$ sudo /opt/oracle/oak/bin/oakcli show env_hw
VM-ODA_BASE ODA X6-2-HA

```

```

$ sudo /opt/oracle/oak/bin/oakcli show version
Version
-----
12.2.1.2.0

```

In this example, the user `jdoue2` tries to run the `oakcli show databases` command, which is not part of the set of commands that is configured for that user. Sudo prevents `jdoue2` from running the command.

```

$ sudo /opt/oracle/oak/bin/oakcli show databases
Sorry, user oracle is not allowed to execute '/opt/oracle/oak/bin/oakcli show
databases' as root on servernode1.

```

10.3 oakcli add disk -local

Use the `oakcli add disk -local` command to add a local disk to the system after physically replacing a failed disk.

Syntax

```
oakcli add disk -local
```

Usage Notes

- You cannot add more than two disks per node.
- You must remove the failed drive and replace it with a new drive before running the `oakcli add disk -local` command.
- The new disk must be inserted into the slot before you run this command.
- The `oakcli add disk -local` command is supported only on bare metal deployments. It is not supported on virtualized configurations.

10.4 oakcli apply

Use the `oakcli apply` command from Node 0 to reconfigure your Oracle Database Appliance core capacity.

Syntax

Use the following syntax where `core_config_key_file` is the full path name of a configuration key file generated on My Oracle Support and copied to Oracle Database Appliance:

```
oakcli apply core_configuration_key core_config_key_file [-h]
```

Parameters

Parameter	Description
<code>core_config_key_file</code>	Identifies the full path and name of the configuration key file
<code>-h</code>	(Optional) Display help for using the command.

Usage Notes

-
- Run the `oakcli apply` command from the first node in Oracle Database Appliance as the `root` user.
- After you run the `oakcli apply` command, Oracle Database Appliance applies the key to both nodes and reboots both nodes. Run the `oakcli show core_config_key` command to view the core configuration key.
- The core key application is applicable only to bare metal implementations. It is not available on an Oracle Database Appliance Virtualized Platform.

Example 10-1 Reconfiguring Oracle Database Appliance with a New Core Count

Reconfigure Oracle Database Appliance with a new core count using the configuration key file `/tmp/set8cores.conf`:

```
oakcli apply core_configuration_key /tmp/set8cores.conf
.....done
INFO: Cluster will be rebooted after applying the core_configuration_key successfully
INFO: .....

INFO: Applying core_configuration_key on '192.0.2.21'
INFO: .....
INFO: Running as root: /usr/bin/ssh -l root 192.0.2.21 /tmp/tmp_lic_exec.pl
INFO: Running as root: /usr/bin/ssh -l root 192.0.2.21 /opt/oracle/oak/bin/oakcli
enforce core_configuration_key /tmp/.lic_file
INFO: Applying core_configuration_key on '192.0.2.20'

INFO: .....
INFO: Running as root: /usr/bin/ssh -l root 192.0.2.20 /tmp/tmp_lic_exec.pl
INFO: Running as root: /usr/bin/ssh -l root 192.0.2.20 /opt/oracle/oak/bin/oakcli
enforce core_configuration_key /tmp/.lic_file
INFO: Applying core_configuration_key on '192.0.2.20'
```

Related Topics

- [oakcli show core_config_key](#) (page 10-54)
Use the `oakcli show core_config_key` command to display information about how to deploy your Oracle Database Appliance cores.

10.5 oakcli clone commands

Use the `oakcli clone` commands to clone virtual machines or virtual disks.

Topics:

- [oakcli clone vdisk](#) (page 10-8)
Use the `oakcli clone vdisk` command to create clones of virtual disks.
- [oakcli clone vm](#) (page 10-9)
Use the `oakcli clone vm` command to create clones and snap clones of virtual machines.

10.5.1 oakcli clone vdisk

Use the `oakcli clone vdisk` command to create clones of virtual disks.

Syntax

```
oakcli clone vdisk new_vdisk_name -repo repo_name -src source_vdisk_name [-h]
```

Parameters

Parameter	Description
<i>new_vdisk_name</i>	Name given to the clone virtual disk
<i>repo_name</i>	Name of the repository source for the virtual disk being cloned
<i>source_vdisk_name</i>	Name of the virtual disk being cloned
-h	(Optional) Display help for using the command.

Usage

The virtual disk and `vm.cfg` files are stored in the following directories:

- Dom0: `/Repositories/vm_repo_name/.ACFS/snaps/vm_name/VirtualMachines/vm_name`
- ODA_BASE: `/app/sharedrepo/vm_repo_name/.ACFS/snaps/vm_name/VirtualMachines/vm_name`

Example 10-2 Cloning a Virtual Disk

Clone a virtual disk named `my_vdisk2` from an existing virtual disk named `vdisk1` that is stored in the repository named `vrep01`:

```
oakcli clone vdisk my_vdisk2 -repo vrep01 -src vdisk1
```

10.5.2 oakcli clone vm

Use the `oakcli clone vm` command to create clones and snap clones of virtual machines.

Syntax

To create a virtual machine from a template:

```
oakcli clone vm vm_name -vmtemplate template_name -repo repo_name [-node 0/1] [-driverdomain]
```

To create a snapshot clone of an existing virtual machine:

```
oakcli clone vm vm_name -vm src_vm_name -snap [-force] [-driverdomain]
```

To create a virtual machine snapshot from a template:

```
oakcli clone vm <vm_name> -vmtemplate src_vmtmpl_name -snap [-driverdomain]
```

Parameters

Parameter	Description
<code>-vm<i>vm_name</i></code>	Identifies the name given to the new cloned virtual machine.
<code>-vmtemplate <i>template_name</i></code>	Identifies the name of the template containing the virtual machine that you want to clone.
<code>-repo <i>repo_name</i></code>	Identifies the name of the repository that contains the template being cloned.
<code>-node <i>0 1</i></code>	Identifies the Oracle Database Appliance node that contains the shared repository from which the virtual machine is to be cloned.
<code>-vm <i>src_name</i></code>	Identifies the name of the virtual machine that is to be cloned.
<code>-snap</code>	(Optional) Creates a snapshot of the source virtual machine or virtual machine template.
<code>-driverdomain</code>	(Optional) Creates the virtual machine with the driver domain option. The driver domain option improves performance by enabling guest virtual machines to use <code>ODA_BASE</code> instead of <code>Dom0</code> to access virtual disks. Newly created virtual disks are mounted directly from <code>ODA_BASE</code> to a guest virtual machine.
<code>-force</code>	(Optional) When cloning a source virtual machine, the <code>-force</code> option enables you to make a change from the source virtual machine. For example, if the source file does not use a driver domain, you can use <code>-force -driverdomain</code> to create a clone virtual machine that does use the driver domain.
<code>-h</code>	(Optional) Displays help for using the command.

Usage Notes

- The `-node` parameter must be used when you clone from a shared repository. The `-node` parameter is invalid for non-shared repositories.
- The virtual disk and `vm.cfg` files are stored in the following directories:

- Dom0: /Repositories/vm_repo_name/.ACFS/snaps/vm_name/
VirtualMachines/vm_name
- ODA_BASE: /app/sharedrepo/vm_repo_name/.ACFS/snaps/vm_name/
VirtualMachines/vm_name
- Live migration of driver domain virtual machines is not supported.
- The driver domain option is supported with the following guest operating systems:
 - Oracle Linux with the latest Unbreakable Enterprise Kernel 2 (UEK2), Unbreakable Enterprise Kernel 3 (UEK3), or Unbreakable Enterprise Kernel Release 4 (UEK R4).
 - Microsoft Windows with Oracle VM Windows PV Driver 3.4.1. Oracle VM Windows PV Driver 3.4.1 release is available for download on My Oracle Support as patch number 23346086.
 - Oracle Solaris 11.3 or higher x86.

- The driver domain only works when you add virtual disks to a guest virtual machine. When `-driverdomain` is specified, the cloned virtual machine is in driver domain mode. The corresponding virtual machine configuration file, `vm.cfg`, has the following disk entries:

When `-driverdomain` is specified, the cloned virtual machine is in driver domain mode. The corresponding virtual machine configuration file, `vm.cfg`, has the following disk entries:

```
disk = [u'file:/OVS/Repositories/repo5/.ACFS/snaps/vm10/  
VirtualMachines/  
vm10/System.img,xvda,w',  
u'file:/u01/app/sharedrepo/repo5/.ACFS/snaps/  
vm10/VirtualMachines/vm10/u01.img,xvdb,w,oakDom1' ]
```

All disks, with the exception of the `xvda` boot disk, have the path from `oakDom1`, that is `odabase`.

- The driver domain functionality applies to non-system disks. Once a virtual machine is created in driver domain mode, any new vDisks are added in driver domain mode.
- To determine if a virtual machine is configured in driver domain mode, use the `oakcli show vm vmname` command. When the virtual machine is in driver mode, the output for the `DriverDomain` attribute is `TRUE`.

Example 10-3 Creating a Virtual Machine Image

Create a virtual machine image named `myol6u_test` from the virtual machine template named `myol6u_15gb1`, which is stored in the shared repository named `repo2` on Node 0:

```
oakcli clone vm myol6u_test -vmtemplate myol6u_15gb1 -repo repo2 -node 0
```

Example 10-4 Creating a Virtual Machine Image in Driver Domain Mode

Create a virtual machine image named `myol6u_test` from the virtual machine template named `myol6u_15gb1`, which is stored in the shared repository named `repo2` on Node 0 in driver domain mode:

```
oakcli clone vm myol6u_test -vmtemplate myol6u_15gb1 -repo repo2 -node 0 -  
driverdomain
```

10.6 oakcli configure commands

Use the `oakcli configure` commands to configure components on Oracle Database Appliance.

- [oakcli configure additionalnet](#) (page 10-12)
Use the `oakcli configure additionalnet` command to configure any unconfigured public networks in bare metal, Domain 0, and ODA_BASE.
- [oakcli configure asr](#) (page 10-12)
Use the `oakcli configure asr` command to configure Oracle Auto Service Request (Oracle ASR) on Oracle Database Appliance.
- [oakcli configure cpupool](#) (page 10-13)
Use the `oakcli configure cpupool` command to configure a CPU pool on one Oracle Database Appliance Virtualized Platform node.
- [oakcli configure firstnet](#) (page 10-14)
Use the `oakcli configure firstnet` command to configure an initial network on Oracle Database Appliance that enables you to download deployment software.
- [oakcli configure ib2fiber](#) (page 10-14)
Run the `oakcli configure ib2fiber` command after replacing InfiniBand 10GbE SFP+ cards (fiber) cards and before deployment to unconfigure IB setup and configure fiber cards.
- [oakcli configure network](#) (page 10-15)
Use the `oakcli configure network` command to configure the network after either replacing a network card or swapping the public network from copper to fiber and vice versa. The meaning of the command changes depending on which parameter you use.
- [oakcli configure oda_base](#) (page 10-15)
Use the `oakcli configure oda_base` command to change the CPU core count assigned to ODA_BASE, add or remove virtual local area networks assigned to ODA_BASE, and adjust resource allocation among user domains and between ODA_BASE and other user domains.
- [oakcli configure repo](#) (page 10-16)
Use the `oakcli configure repo` command to increase the size of a shared repository.
- [oakcli configure vm](#) (page 10-17)
Use the `oakcli configure vm` command to configure a virtual machine on Oracle Database Appliance Virtualized Platform and to increase or decrease resource allocation to user domains.
- [oakcli configure vmtemplate](#) (page 10-19)
Use the `oakcli configure vmtemplate` command to configure a virtual machine template on Oracle Database Appliance Virtualized Platform.

10.6.1 oakcli configure additionalnet

Use the `oakcli configure additionalnet` command to configure any unconfigured public networks in bare metal, Domain 0, and ODA_BASE.

Syntax

```
oakcli configure additionalnet [-h]
```

Parameter

`-h` displays online help for using the command.

Usage Notes

The `oakcli configure additionalnet` command automatically detects any unconfigured networks and runs an interactive script that guides you through how to configure the network. The script requires the following input:

- Interface name
- DHCP [Y/N]
- IP
- Netmask



Note:

If you are running the command on a bare metal deployment, then the interface name expects a bond name. If you are running the command on Dom0, then the interface name expects a net name. If you are running the command on Dom1, then the interface name expects an eth name.

10.6.2 oakcli configure asr

Use the `oakcli configure asr` command to configure Oracle Auto Service Request (Oracle ASR) on Oracle Database Appliance.

Syntax

```
oakcli configure asr [-h]
```

Parameter

`-h` displays help for using the command.

Usage Notes

- The `oakcli configure asr` command initiates an interactive script that requests the following information to implement Oracle ASR on Oracle Database Appliance:
 - Action to be performed (setup internal, setup external, deinstall, or reconfigure Oracle ASR Manager)
 - PROXY server name, port, user ID, and password

- Oracle ASR user ID and password
- Oracle ASR Manager IP and port
- You can configure Oracle ASR on Oracle Database Appliance to use its own ASR Manager (**internal Oracle ASR**) or use Oracle ASR Manager configured on another server in the same network as your appliance (**external Oracle ASR**). If you already have Oracle ASR Manager configured in your environment, you can register Oracle Database Appliance with your existing Oracle ASR Manager.

 **Note:**

With an internal Oracle ASR Manager, an alert is not sent when the server goes down. If a critical event occurs on Oracle Database Appliance with an external Oracle ASR Manager, then an alert can still be sent to Oracle.

Configuring Oracle ASR

```
# oakcli configure asr

INFO : Logging all actions in /opt/oracle/oak/onecmd/tmp/
scaodal011-20150805153300.log and traces in /opt/oracle/oak/onecmd/tmp/
scaodal011-20150805153300.trc

Please enter
1 to setup Internal ASR
2 to setup External ASR
3 to Deinstall ASR
0 to Exit

[1]:INFO : Logging all actions in /opt/oracle/oak/onecmd/tmp/
scaodal011-20150805153300.log and traces in /opt/oracle/oak/onecmd/tmp/
scaodal011-20150805153300.trc
```

10.6.3 oakcli configure cpupool

Use the `oakcli configure cpupool` command to configure a CPU pool on one Oracle Database Appliance Virtualized Platform node.

Syntax

```
oakcli configure cpupool poolname -numcpu cpu_count -node nodenum [-h]
```

Parameters

Parameter	Description
<i>poolname</i>	Unique name for the CPU pool
-numcpu <i>cpu_count</i>	Number of CPUs for the CPU pool
-node <i>nodenum</i>	Node where the CPU pool will be created (0 or 1)
-h	(Optional) Display help for using the command.

Configuring a CPU Pool

Configure a CPU pool named `twonode` with two cores on Node 1 of Oracle Database Appliance Virtualized Platform:

```
oakcli configure cpupool twonode -numcpu 2 -node 1
```

10.6.4 oakcli configure firstnet

Use the `oakcli configure firstnet` command to configure an initial network on Oracle Database Appliance that enables you to download deployment software.

Syntax

```
oakcli configure firstnet
```

Example

The `oakcli configure firstnet` command creates an initial network on a new Oracle Database Appliance using an interactive script. The following example shows how to configure the initial network on a bare metal Oracle Database Appliance:

```
oakcli configure firstnet
Select the interface to configure network on [bond0 bond1 bond2 xbond0]:bond0
Configure DHCP on bond0?(yes/no):no
    INFO: Static configuration selected
    Enter the IP address to configure:192.0.2.18
    Enter the netmask address to configure:255.255.252.0
    Enter the gateway address to configure:192.0.2.1
Plumbing the IPs now
Restarting the network
::::::::::::::::::
```



Note:

Oracle recommends using the `oakcli configure firstnet` command only one time on Oracle Database Appliance. Subsequent use after configuring the initial network can cause unpredictable changes to your network settings.

10.6.5 oakcli configure ib2fiber

Run the `oakcli configure ib2fiber` command after replacing InfiniBand 10GbE SFP+ cards (fiber) cards and before deployment to unconfigure IB setup and configure fiber cards.



Note:

If you are using Oracle Database Appliance Virtualized Platform, then you must execute the command from Dom0.

Usage Notes

This command must be run before deployment to configure 10GbE SFP+ (fiber) cards.

Syntax

```
oakcli configure ib2fiber [-h]
```

Parameter

-h displays help for using the command.

10.6.6 oakcli configure network

Use the `oakcli configure network` command to configure the network after either replacing a network card or swapping the public network from copper to fiber and vice versa. The meaning of the command changes depending on which parameter you use.

Syntax

```
oakcli configure network [-changeNetCard|-publicNet][[-h]]
```

Parameters

Parameter	Description
-changeNetCard	Configures the network card after it has been replaced. You must run the <code>oakcli configure network -changeNetCard</code> command on each node if the network card was replaced. This parameter is supported on all Oracle Database Appliance hardware models. This command must be executed from Dom0 on virtualized platforms.
-publicNet	Configures the network after you have swapped the public network from copper to fiber and vice versa. You must run the <code>oakcli configure network -publicNet</code> command on each node, and this requires the stack to be down. The stack includes GI and RDBMS. If you are using Oracle Database Appliance Virtualized Platform, the virtual machines must be down. The virtual machines may need some configuration changes, especially if they are using VLANs. This parameter is supported only on Oracle Database Appliance X4-2 hardware models.
-h	(Optional) Display help for using the command.

10.6.7 oakcli configure oda_base

Use the `oakcli configure oda_base` command to change the CPU core count assigned to ODA_BASE, add or remove virtual local area networks assigned to ODA_BASE, and adjust resource allocation among user domains and between ODA_BASE and other user domains.

You must restart the domain for the resource allocation change to take effect.

Syntax

```
oakcli configure oda_base
```

Examples

Here are examples of how to use the `oakcli configure oda_base` command.

Changing the CPU Core Count in ODA_BASE

Change the CPU core count from six to eight in ODA_BASE:

```
# oakcli configure oda_base
Core Licensing Options:
  1. 2 CPU Cores
  2. 4 CPU Cores
  3. 6 CPU Cores
  4. 8 CPU Cores
  5. 10 CPU Cores
  6. 12 CPU Cores
Current CPU Cores      :6
Selection[1 : 6](default 12 CPU Cores) : 4
ODA base domain memory in GB(min 8, max 88)(Current Memory 64G)[default
32]      :
INFO: Using default memory size i.e. 32 GB
Additional vlan networks to be assigned to oda_base? (y/n) [n]:
Vlan network to be removed from oda_base (y/n) [n]
INFO: Node 0:Configured oda base pool
INFO: Node 1:Configured oda base pool
INFO: Node 0:ODA Base configured with new memory
INFO: Node 0:ODA Base configured with new vcpus
INFO: Changes will be incorporated after the domain is restarted on Node 0
INFO: Node 1:ODA Base configured with new memory
INFO: Node 1:ODA Base configured with new vcpus
INFO: Changes will be incorporated after the domain is restarted on Node 1
```

Changing the Amount of Memory Allocated to ODA_BASE

1. Log in to Dom0.
2. Execute the `oakcli configure oda_base` command and change the configuration.
3. Restart ODA_BASE.

Assigning VLANs to ODA_BASE

1. Log in to Dom0.
2. Execute the `oakcli configure oda_base` command.
3. Change the setting for `Additional vlan networks to be assigned to oda_base?` (y/n) to **y**.
4. Follow the prompts to assign additional VLANs to ODA_BASE.
5. Restart ODA_BASE.

10.6.8 oakcli configure repo

Use the `oakcli configure repo` command to increase the size of a shared repository.

Syntax

```
oakcli configure repo reponame -incsize size [M|G] [-h]
```

Parameter	Description
reponame	Name of the shared repository
size	Number that can be followed by M to define the size as megabytes or by G to define as size as gigabytes
-h	(Optional) Display help for using the command.

Increasing the Size of a Shared Repo

Increase the size of the `repol` shared repository by 2 gigabytes:

```
# oakcli configure repo repol -incsize 2G
```

Configured Shared Repo : `repol` with new size 3712.0.

10.6.9 oakcli configure vm

Use the `oakcli configure vm` command to configure a virtual machine on Oracle Database Appliance Virtualized Platform and to increase or decrease resource allocation to user domains.

You must restart the domain for the resource allocation change to take effect.

Syntax

```
oakcli configure vm name [-vcpu cpucount -maxvcpu maxcpu -cpuprio priority
-cpucap cap -memory memsize -maxmemory max_memsize -os sys -keyboard lang -mouse
mouse_type -domain dom -network netlist -autostart astart -disk disks -bootoption
bootstrap -cpupool pool -prefnode 0|1 -failover true|false][-h]
```

Parameters

Parameter	Description
name	The name assigned to the virtual machine.
-vcpu <i>cpucount</i>	Number of nodes assigned to the virtual machine. The range is 1 to 72. This number depends on your Oracle Database Appliance configuration
-maxvcpu <i>maxcpu</i>	Maximum number of CPUs that the virtual machine can consume. The range is 1 to 72. This number depends on your Oracle Database Appliance configuration.
-cpuprio <i>priority</i>	Priority for CPU usage, where larger values have higher priority. The range is 1 to 65535.
-cpucap <i>cap</i>	Percentage of a CPU the virtual machine can receive. The range is 10 to 100.
-memory <i>memsize</i>	Amount of memory given to the virtual machine: (1 to 248)G to (1to 760G) or (1 to 253952)M to (1 to 778240)M, based on RAM. The default is M.
-maxmemory <i>max_memsize</i>	Maximum amount of memory allowed for the virtual machine: (1 to 248)G to (1 to 760)G or (1-253952)M to (1-778240)M, based on RAM. The default is M.

Parameter	Description
-os <i>sys</i>	Operating system used by the virtual machine (WIN_2003, WIN_2008, WIN_7, WIN_VISTA, OTHER_WIN, OL_4, OL_5, OL_6, RHL_4, RHL_5, RHL_6, LINUX_RECOVERY, OTHER_LINUX, SOLARIS_10, SOLARIS_11, OTHER_SOLARIS, or NONE)
-keyboard <i>lang</i>	Keyboard used by virtual machine (en-us, ar, da, de, de-ch, en-gb, es, et, fi, fo, fr, fr-be, fr-ca, hr, hu, is, it, ja, lt, lv, mk, nl, n--be, no, pl, pt, pt-br, ru, sl, sv, th, or tr)
-mouse <i>mouse_type</i>	Mouse type used by the virtual machine (OS_DEFAULT, PS2_MOUSE, USB_MOUSE, or USB_TABLET)
-domain <i>dom</i>	Domain type from the following options: <ul style="list-style-type: none"> • Hardware virtualized guest (XEN_HVM) <ul style="list-style-type: none"> - The kernel or operating system is not virtualization-aware and can run unmodified. - Device drivers are emulated. • Para virtualized guest (XEN_PVM) <ul style="list-style-type: none"> - The guest is virtualization-aware and is optimized for a virtualized environment. - PV guests use generic, idealized device drivers. • Hardware virtualized guest (XEN_HVM_PV_DRIVERS) <ul style="list-style-type: none"> The PV drivers are hypervisor-aware and significantly reduce the overhead of emulated device input/output. • Hardware virtualized guest (UNKNOWN)
-network <i>netlist</i>	MAC address and list of networks used by the virtual machine
-autostart <i>astart</i>	Startup option for virtual machine (always, restore, or never)
-disk <i>disks</i>	List of disks (slot, disktype, and content) used by virtual machine
-bootoption <i>bootstrap</i>	Boot option used to bootstrap the virtual machine (PXE, DISK, or CDROM)
-cpupool <i>pool</i>	Named CPU pool assigned to the virtual machine
-prefnode 0 1	Preferred node on which the virtual machine will attempt to start (Node 0 or Node 1). This parameter is only valid for virtual machines created in shared repositories.
-failover true false	Allow (use the keyword "true") or disallow (use the keyword "false") the virtual machine to start or restart on a node other than the node defined by the -prefnode parameter. This parameter is only valid for virtual machines created in shared repositories.
-h	(Optional) Display help for using the command.

Usage Notes

- All of the parameters, except for *name*, are optional.
- You must include at least one optional parameter for the command to work.
- When you create a virtual machine, select the Processor Cap as a percentage, between 10 and 100%. The default is 100%. This value is then converted to a CPU utilization limit in the `vm.cfg` file for the virtual machine. The value set in the `vm.cfg` file limits the amount of CPU a guest is allowed to consume. If the Processor Cap is set at 100% in Oracle VM, then the value set in `vm.cfg` is 0, which means there is no limit to CPU utilization.

 **See Also:**

Oracle VM release 3.1 documentation contains more information about the options in the preceding table. Access the library at the following URL:

http://docs.oracle.com/cd/E27300_01

For example, refer to 2.8. Virtual Machines for information about the the -domain *dom* options:

http://docs.oracle.com/cd/E27300_01/E27309/html/vmusg-ovm-vms.html

Changing the Number of Virtual CPUs

This command example changes the number of virtual CPUs to 3, and changes the virtual memory size to 4 GB in a virtual machine named `odarep01`:

```
oakcli configure vm odarep01 -vcpu 3 -memory 4196
```

10.6.10 oakcli configure vmtemplate

Use the `oakcli configure vmtemplate` command to configure a virtual machine template on Oracle Database Appliance Virtualized Platform.

Syntax

```
oakcli configure vmtemplate name [-vcpu cpucount -maxvcpu maxcpu -cpuprio priority -cpucap cap -memory memsize -maxmemory max_memsize -os sys -keyboard lang -mouse mouse_type -domain dom -network netlist -disk disks][h]
```

Parameters

Parameter	Description
<i>name</i>	Name assigned to the virtual machine template
<code>-vcpu <i>cpucount</i></code>	Number of nodes assigned to virtual machines cloned from the template.
<code>-maxvcpu <i>maxcpu</i></code>	Maximum number of CPUs that virtual machines cloned from the template can consume.
<code>-cpuprio <i>priority</i></code>	Priority for CPU usage, where larger values have higher priority (1 to 256).
<code>-cpucap <i>cap</i></code>	Percentage of a CPU that virtual machines cloned from the template can receive (1 to 100).
<code>-memory <i>memsize</i></code>	Amount of memory given to virtual machines cloned from the template (1G to 88 G or 1M to 90112M)
<code>-maxmemory <i>max_memsize</i></code>	Maximum amount of memory allowed for virtual machines cloned from the template
<code>-os <i>sys</i></code>	Operating system used by virtual machines cloned from the template (WIN_2003, WIN_2008, WIN_7, WIN_VISTA, OTHER_WIN, OL_4, OL_5, OL_6, RHL_4, RHL_5, RHL_6, LINUX_RECOVERY, OTHER_LINUX, SOLARIS_10, SOLARIS_11, OTHER_SOLARIS, or NONE)

Parameter	Description
-keyboard <i>lang</i>	Keyboard used by virtual machines cloned from the template (en-us, ar, da, de, de-ch, en-gb, es, et, fi, fo, fr, fr-be, fr-ca, hr, hu, is, it, ja, lt, lv, mk, nl, n--be, no, pl, pt, pt-br, ru, sl, sv, th, or tr)
-mouse <i>mouse_type</i>	Mouse type used by virtual machines cloned from the template (OS_DEFAULT, PS2_MOUSE, USB_MOUSE, or USB_TABLET)
-domain <i>dom</i>	Domain type from the following options: <ul style="list-style-type: none"> • Hardware virtualized guest (XEN_HVM) <ul style="list-style-type: none"> - The kernel or operating system is not virtualization-aware and can run unmodified. - Device drivers are emulated. • Para virtualized guest (XEN_PVM) <ul style="list-style-type: none"> - The guest is virtualization-aware and is optimized for a virtualized environment. - PV guests use generic, idealized device drivers. • Hardware virtualized guest (XEN_HVM_PV_DRIVERS) <ul style="list-style-type: none"> The PV drivers are hypervisor-aware and significantly reduce the overhead of emulated device input/output.
-network <i>netlist</i>	MAC address and list of networks used by virtual machines cloned from the template
-disk <i>disks</i>	List of disks (slot, disktype, and content) used by virtual machines cloned from the template
-h	(Optional) Display help for using the command.

Usage Notes

- All of the parameters, except for *name*, are optional.
- You must include at least one optional parameter for the command to work.



See Also::

Oracle VM Release 3.1 documentation, which is available at the following URL:

http://docs.oracle.com/cd/E27300_01 for more information about the options in the preceding table.

For example, see 2.8. Virtual Machines for details about the option -domain *dom*

http://docs.oracle.com/cd/E27300_01/E27309/html/vmusg-ovm-vms.html

Setting Values for a Virtual Machine

Set values for the following configuration values in the virtual machine template named `myol5u7_10gb`:

```
oakcli configure vmtemplate myol5u7_10gb
-vcpu 2 -maxvcpu 4 -cpucap 40 -memory 1536M -maxmemory 2G
-network "['type=netfront,bridge=net1']" -os OTHER_LINUX
```

- `-vcpu 2` = Two CPUs will assigned when the virtual machine starts up
- `-maxvcpu 4` = The maximum number of CPUs that can be assigned to the virtual machine is 4.
- `-cucap 40` = The maximum percentage of a CPU's capacity that will be assigned to the virtual machine is 40%.
- `-memory 1536M` = The amount of memory assigned when the virtual machine starts up is 1536 MB.
- `-maxmemory 2G` = The maximum amount of memory that can be assigned to the virtual machine is 2 GB.
- `-network type=netfront,bridge=net1` = This is the list of networks used by virtual machines cloned from the template.
- `-os` = The operating system used by the virtual machine is OTHER_LINUX.

10.7 oakcli copy

Use the `oakcli copy` command to prepare a copy of the configuration file for use during the configuration of Oracle Database Appliance.

Syntax

```
oakcli copy -conf absolute_conf_file [-h]
```

Parameters

Parameter	Description
<code>-conf absolute_conf_file</code>	Specifies the full path name of the configuration file
<code>-h</code>	(Optional) Display help for using the command.

Example 10-5 Preparing a Copy of the Configuration File

If you created a configuration file previously and copied this file to Oracle Database Appliance, then prepare the configuration file to be used during the configuration process. For example, if you copied the file `myserver1.conf` to `/tmp`, then enter the following command:

```
oakcli copy -conf /tmp/myserver1.conf
```

10.8 oakcli create commands

Use the `oakcli create` commands to create components on Oracle Database Appliance.

- [oakcli create cpupool](#) (page 10-22)
Use the command `oakcli create cpupool` to create a CPU pool on one Oracle Database Appliance Virtualized Platform node.
- [oakcli create database](#) (page 10-23)
Use the `oakcli create database` command to create additional databases on Oracle Database Appliance.

- [oakcli create dbhome](#) (page 10-26)
Use the `oakcli create dbhome` command to create a new database home on Oracle Database Appliance.
- [oakcli create dbstorage](#) (page 10-27)
Use the `oakcli create dbstorage` command to create a storage structure for migrating databases from Oracle ASM to Oracle ACFS.
- [oakcli create db_config_params](#) (page 10-28)
Use the `oakcli create db_config_params` command to generate a database configuration file.
- [oakcli create repo](#) (page 10-29)
Use the `oakcli create repo` command to create a new shared repository on Oracle Database Appliance Virtualized Platform.
- [oakcli create snapshotdb](#) (page 10-30)
Use the `oakcli create snapshotdb` command to create a snapshot database from an existing database.
- [oakcli create vdisk](#) (page 10-30)
Use the `oakcli create vdisk` command to create a new virtual disk in a shared repository on Oracle Database Appliance Virtualized Platform.
- [oakcli create vlan](#) (page 10-31)
Use the `oakcli create vlan` command to create a new virtual local area network (VLAN) on an Oracle Database Appliance Virtualized Platform node.

10.8.1 oakcli create cpupool

Use the command `oakcli create cpupool` to create a CPU pool on one Oracle Database Appliance Virtualized Platform node.

Syntax

```
oakcli create cpupool poolname -numcpu cpu_count -node nodenum [-h]
```

Parameters

Parameter	Description
<i>poolname</i>	Uniquely names the CPU pool
-numcpu <i>cpu_count</i>	Defines the number of CPUs for the CPU pool
-node <i>nodenum</i>	Defines the node where the CPU pool will be created (0 or 1)
-h	(Optional) Display help for using the command.

Example

Create a CPU pool with two CPUs on Node 1 of Oracle Database Appliance Virtualized Platform:

```
oakcli create cpupool twonode -numcpu 2 -node 1
```

10.8.2 oakcli create database

Use the `oakcli create database` command to create additional databases on Oracle Database Appliance.

When you run `oakcli create database`, the command prompts you for further inputs.

Note:

Do not use Oracle Database Configuration Assistant (DBCA) to create databases on Oracle Database Appliance. Only use Oracle Appliance Manager for database configuration. Deploying Oracle Database instances using Oracle Appliance Manager ensures that these databases are properly configured, optimized, and supported on Oracle Database Appliance.

Syntax

```
oakcli create database -db db_name [[[-oh home] | [-version version]] [-params
params_file] [-storage acsf] [-cdb]][h]
```

Parameters

Parameter	Description
<code>-cdb</code>	(Optional) Creates the database as a container database.
<code>-db <i>db_name</i></code>	Name of the database that you want to create.
<code>-oh <i>home</i></code>	(Optional) Name of an existing Oracle home to use when creating the database. By default, the command creates a new database home.
<code>-params <i>params_file</i></code>	(Optional) Name of the configuration file. By default, Oracle Database Appliance uses the default configuration file.
<code>-storage <i>acfs</i></code>	(Optional) Creates an Oracle 12c database in Oracle Automatic Storage Management Cluster File System (Oracle ACFS).
<code>-version <i>version</i></code>	(Optional) Version of the database that you want to create. By default, Oracle Database Appliance uses the highest version that you have downloaded.
<code>-h</code>	(Optional) Display help for using the command.

Usage Notes

- Flash cache is disabled and cannot be enabled.
- The `-oh` and the `-version` parameters are mutually exclusive. Attempting to use both in the same command will generate an error.
- When a database is created without identifying an Oracle home, a new Oracle home is created using a standard naming convention (for example, OraDb11204_home3). The number at the end of the name is incremented by one for each new home created with the same version number.
- The minimum supported Oracle Database release is 11.2.0.4. Oracle Database 11.2.0.3.x is not supported.

- When you upgrade the database, infrastructure, and Oracle Grid Infrastructure, you must specify an existing home to create a new database.
- If you try to create a database using the option `-version version` before downloading and unpacking the specific version database clone files, then the command will fail.
- You can create configuration files with the `oakcli create db_config_params` command.
- The prompt "Do you want to keep the data files on FLASH storage: [Y | N]" is only shown if you choose the OLTP database type and if there is some free space available on flash storage.
- Beginning with Oracle Database 12c release 1 (12.1.0.2), the default database location is Oracle Automatic Storage Management (Oracle ASM). You can use the `-storage acfs` parameter to create an Oracle Database in Oracle ACFS.

Examples

This section shows different scenarios for using the command `oakcli create database`.

Example 10-6 Creating a New Database Showing Prompts

When you run `oakcli create database`, you are prompted for several inputs.

The following command creates a database named `mydb` using an existing Oracle home named `OraDb12102_home1`:

```
# oakcli create database -db DBPROD

INFO: 2017-07-25 19:21:16: Please check the logfile
'/opt/oracle/oak/log/ODADBI1/tools/12.1.2.12.0/createdb_DBPROD_29285.log' for more
details
INFO: 2017-07-25 19:21:24: Database parameter file is not provided.
Will be using default parameters for DB creation

Please enter the 'SYSASM' password : password
Please re-enter the 'SYSASM' password: password

INFO: 2017-07-25 19:21:35: Installing a new Home : OraDb12102_home2 at
/u01/app/oracle/product/12.1.0.2/dbhome_2

Please select one of the following for Database type [1 .. 3] :
1  => OLTP
2  => DSS
3  => In-Memory
1
The selected value is : OLTP

1 => EE : Enterprise Edition
2 => RACONE
3 => RAC1
3
Selected value is : RAC

Specify the Database Class (1. odb-01 '1 core, 8 GB memory' 2.Others) [1]
:2

Please select one of the following for Database Class [1 .. 10]:
1  => odb-01s ( 1 cores , 4 GB memory)
2  => odb-01 ( 1 cores , 8 GB memory)
```

```

3 => odb-02 ( 2 cores , 16 GB memory)
4 => odb-04 ( 4 cores , 32 GB memory)
5 => odb-06 ( 6 cores , 48 GB memory)
6 => odb-12 ( 12 cores , 96 GB memory)
7 => odb-16 ( 16 cores , 128 GB memory)
8 => odb-20 ( 32 cores , 256 GB memory)

```

Example 10-7 Creating a New Database in an Existing Oracle Home

Create a database called `sales1` in `OraDb11204_home2`:

```
oakcli create database -db sales1 -oh OraDb11204_home2
```

Example 10-8 Creating a New Database from a Template

Create a database called `sales2` from the `salesdbtemplate.bconf` file (by appending the default file extension to the file name provided). This example also creates a new Oracle home:

```
oakcli create database -db sales2 -params salesdbtemplate
```

Example 10-9 Creating a New Database as a Container Database

Create a version 12.1.0.2 container database called `sales3`:

```
oakcli create database -db sales3 -version 12.1.0.2 -cdb
```

Example 10-10 Creating a Database in Oracle ACFS

You can create a database called `sales4` in Oracle 12c database in Oracle ACFS:

```
oakcli create database -db sales4 -version 12.1.0.2 -storage acfs
```

Example 10-11 Creating an Enterprise Edition Database

Create a version 12.1.0.2 database named `DBPROD` from the database configuration file named `dbprodconf`:

```
oakcli create database -db DBPROD -version 12.1.0.2 -params dbprodconf
```

The `oakcli create database` command starts a wizard that requires some basic inputs such as the root, oracle and SYSASM password. After you enter the password information, specify the type of database and running node:

```

# oakcli create database -db DBPROD

INFO: 2017-07-25 19:21:16: Please check the logfile
'/opt/oracle/oak/log/ODADBI1/tools/12.1.2.12.0/createdb_DBPROD_29285.log' for more
details
INFO: 2017-07-25 19:21:24: Database parameter file is not provided.
Will be using default parameters for DB creation

Please enter the 'SYSASM' password : password:
Please re-enter the 'SYSASM' password: password

INFO: 2017-07-25 19:21:35: Installing a new Home : OraDb12102_home2 at
/u01/app/oracle/product/12.1.0.2/dbhome_2

Please select one of the following for Database type [1 .. 3] :
1 => OLTP
2 => DSS
3 => In-Memory

```



```

1
The selected value is : OLTP

1 => EE : Enterprise Edition
2 => RACONE
3 => RAC1
1
Selected value is: EE

Please select one of the following for Node Number [1 .. 2]:

1 => ODADBI1-base
2 => ODADBI2-base2
1
Selected value is: ODADBI1-base

Specify the Database Class (1. odb-01 '1 core, 8 GB memory' 2. Others) [1]
: 2

Please select one of the following for Database Class [1 .. 8] :
1 => odb-01s (1 cores , 4 GB memory)
2 => odb-01 (1 cores , 8 GB memory)
3 => odb-02 (2 cores , 16 GB memory)
4 => odb-04 (4 cores , 32 GB memory)
5 => odb-06 (6 cores , 48 GB memory)
6 => odb-12 (12 cores, 96 GB memory)
7 => odb-16 (16 cores, 128 GB memory)
8 => odb-20 (20 cores, 160 GB memory)

```

**Note:**

The database class only defines the Oracle Database Configuration Assistant (DBCA) template to be used for the database creation. Oracle Database Appliance comes with a specific number of templates and none can be added. See [Database Templates for Oracle Database Appliance](#) (page C-1) for template specifications.

10.8.3 oakcli create dbhome

Use the `oakcli create dbhome` command to create a new database home on Oracle Database Appliance.

Syntax

```
oakcli create dbhome [-version version] [-h]
```

Parameters

Parameter	Description
<code>-version <i>version</i></code>	(Optional) Version that you want to install. If this is not provided, then Oracle Database Appliance uses the latest available version.
<code>-h</code>	(Optional) Display help for using the command.

Creating a Database Home

Create a database home called `sales1` using Oracle Database version 12.1.0.2.4.

```
oakcli create dbhome -version 12.1.0.2.4
```

10.8.4 oakcli create dbstorage

Use the `oakcli create dbstorage` command to create a storage structure for migrating databases from Oracle ASM to Oracle ACFS.

Syntax

```
oakcli create dbstorage -db db_name [-cdb][-h]
```

Parameters

Parameter	Description
-db <i>db_name</i>	Sets up the required Oracle ACFS storage structure for the database to be created called <i>db_name</i>
-cdb	Must be passed if you are creating a multitenant container database
-h	(Optional) Display help for using the command.

Example

The `oakcli create dbstorage` command requests user input to determine the size of the storage structure to create, as shown in this example:

```
oakcli create dbstorage -db sales

Please enter the 'root' password :
Please re-enter the 'root' password:

Please enter the 'oracle' password :
Please re-enter the 'oracle' password:

Please enter the 'SYSASM' password:
Please re-enter the 'SYSASM' password:

Specify the Database Class (1. odb-01 '1 core, 8 GB memory' 2. Others) [1]:2

Please select one of the following for Database Class [1 .. 8] :
1 => odb-01s ( 1 cores , 4 GB memory)
2 => odb-01 ( 1 cores , 8 GB memory)
3 => odb-02 ( 2 cores , 16 GB memory)
4 => odb-04 ( 4 cores , 32 GB memory)
5 => odb-06 ( 6 cores , 48 GB memory)
6 => odb-12 ( 12 cores , 96 GB memory)
7 => odb-16 ( 16 cores , 128 GB memory)
8 => odb-24 ( 24 cores , 192 GB memory)

Selected value is: odb-01s ( 1 cores , 4 GB memory)
...
```

10.8.5 oakcli create db_config_params

Use the `oakcli create db_config_params` command to generate a database configuration file.

The configuration file is created in `/opt/oracle/oak/install/dbconf` and is given the default extension `.dbconf`.

Syntax

```
oakcli create db_config_params -conf filename [-h]
```

Parameters

Parameter	Description
<code>-conf filename</code>	Name you want to give to the configuration file, without its path name.
<code>-h</code>	(Optional) Display help for using the command

Example

Create the database parameter file: `/opt/oracle/oak/install/dbconf/newconf.dbconf`:

```
# oakcli create db_config_params -conf newconf
```

```
Please select one of the following for Database Block Size [1 .. 4]:
```

```
1 ==> 4096
```

```
2 ==> 8192
```

```
3 ==> 16384
```

```
4 ==> 32768
```

```
2
```

```
Selected value is: 8192
```

```
Specify the Database Language (1. AMERICAN 2. Others) [1]:
```

```
Selected value is: AMERICAN
```

```
Specify the Database Characterset (1. AL32UTF8 2. Others) [1]:2
```

```
Please select one of the following for Database Characterset [0 .. 10] :
```

```
0 => Others
```

```
1 => AL32UTF8
```

```
2 => AR8ADOS710
```

```
3 => AR8ADOS710T
```

```
4 => AR8ADOS720
```

```
5 => AR8ADOS720T
```

```
6 => AR8APTEC715
```

```
7 => AR8APTEC715T
```

```
8 => AR8ARABICMACS
```

```
9 => AR8ASMO708PLUS
```

```
10 => AR8ASMO8X
```

```
1
```

```
Selected value is: AL32UTF8
```

```
Specify the Database Territory (1. AMERICA 2. Others) [1]:2
```

```
Please select one of the following for Database Territory [0 .. 10] :
```

```
0 => Others
```

```

1 => ALBANIA
2 => ALGERIA
3 => AMERICA
4 => ARGENTINA
5 => AUSTRALIA
6 => AUSTRIA
7 => AZERBAIJAN
8 => BAHRAIN
9 => BANGLADESH
10 => BELARUS
3
Selected value is: AMERICA

Specify the Component Language (1. en 2. Others) [1]:2

Please select one of the following for Component Language [0 .. 10] :
0 => Others
1 => en : English
2 => fr : French
3 => ar : Arabic
4 => bn : Bengali
5 => pt_BR : Brazilian Portuguese
6 => bg : Bulgarian
7 => fr_CA : Canadian French
8 => ca : Catalan
9 => hr : Croatian
10 => cs : Czech
1
Selected value is: en
Successfully generated the Database parameter file 'newconf'

```

10.8.6 oakcli create repo

Use the `oakcli create repo` command to create a new shared repository on Oracle Database Appliance Virtualized Platform.

Syntax

```
oakcli create repo repo_name -size size [M|G] -dg DATA|RECO [-h]
```

Parameters

Parameter	Description
<i>repo_name</i>	Name assigned to the shared repository
-size <i>size</i> [M G]	Amount of storage to be assigned to the shared repository. It can be defined in megabytes with the M option or in gigabytes with the G option.
-dg DATA RECO	Oracle ASM disk group in which the shared repository is to be stored, either the DATA+ disk group or the RECO+ disk group, selected by using the DATA or RECO option respectively
-h	(Optional) Display help for using the command.

Usage Notes

- The `-size` parameter requires a whole number for size.

- The minimum value for *size* is 500 when M is used or 1 when G is used for the sizing unit.
- The default unit for *size* is G (gigabytes).
- A shared repository should only be used for the virtual machine and not as a file staging area. Avoid copying or moving files into a shared repository.

Example

Create a 25-gigabyte shared repository named `repoprod1` in the DATA+ disk group:

```
oakcli create repo repoprod1 -dg DATA -size 25
```

10.8.7 oakcli create snapshotdb

Use the `oakcli create snapshotdb` command to create a snapshot database from an existing database.

Syntax

```
oakcli create snapshotdb [-db snap_dbname -from dbname] | [-h]
```

Parameters

Parameter	Description
<code>-db <i>snap_dbname</i></code>	Name of the snapshot database to be created
<code>-from <i>source_dbname</i></code>	Name of the source database
<code>-h</code>	(Optional) Display help for using the command

Example

Create a new snapshot database, name `snapprod`, from the database named `prod`:

```
oakcli create snapshotdb -db snapprod -from prod
```

10.8.8 oakcli create vdisk

Use the `oakcli create vdisk` command to create a new virtual disk in a shared repository on Oracle Database Appliance Virtualized Platform.

Syntax

```
oakcli create vdisk vdisk_name -repo repository_name -size size -type shared|local -sparse [-h]
```

Parameters

Parameter	Description
<code><i>vdisk_name</i></code>	Name assigned to the virtual disk that is unique within the name repository
<code>-repo <i>repository_name</i></code>	Name of the shared repository where the virtual disk will be created and from which it will acquire its storage

Parameter	Description
-size <i>size</i>	Amount of storage to be assigned from the shared repository to the shared disk. The default unit is G (for gigabytes) and the minimum size is 500 M (for megabytes)
-type <i>shared</i> <i>local</i>	Sets the option of allowing the virtual disk to be shared by more than one virtual machine (<i>shared</i>) or used by only one virtual machine (<i>local</i>)
-sparse	Creates a sparse vdisk
-h	(Optional) Display help for using the command.

Example

Create a virtual disk named `t2g` in the shared repository named `repoprod1` for use by only one virtual machine at a time in that repository. Assign the `t2g` virtual disk 2 GB in the `repoprod1` shared repository.

```
oakcli create vdisk t2g -repo repoprod1 -type local -size 2G
```

10.8.9 oakcli create vlan

Use the `oakcli create vlan` command to create a new virtual local area network (VLAN) on an Oracle Database Appliance Virtualized Platform node.

Syntax

```
oakcli create vlan vlan_name -vlanid tag_id -if interface_name -node 0|1 [-h]
```

Parameters

Parameter	Description
<i>vlan_name</i>	Name assigned to the VLAN.
-vlanid <i>tag_id</i>	Tag number, used for packet routing, from 2 to 4096 inclusive. It uniquely identifies the VLAN on a node. You assign the ID and you can use the same tag number on both nodes.
-if <i>interface_name</i>	Name of the interface on which the VLAN network is created
-node 0 1	Node on which the VLAN is created, either Node0 or Node1.
-h	(Optional) Display help for using the command.

Usage Notes

- You can assign VLANs to ODA_BASE during the deployment.
- The VLAN for the ODA_BASE is created from DOM-0.
- Only execute the VLAN created in Dom-0 from Node0.
- VLAN creation in dom0 should be executed only from Node 0.

Examples

Here are examples of how to use the `oakcli create vlan` command.

Creating a New VLAN

Create a VLAN named `sample10` on Node 1 using the `bond1` interface and a tag with the number 10:

```
oakcli create vlan sample10 -vlanid 10 -if bond1 -node 1
```

Duplicating a VLAN on the Second Node

Create a VLAN named `sample10` on Node 0:

```
oakcli create vlan sample10 -vlanid 10 -if bond1 -node 0
```

10.9 oakcli delete commands

Use the `oakcli delete` commands to delete components from Oracle Database Appliance.

- [oakcli delete cpupool](#) (page 10-33)
Use the `oakcli delete cpupool` command to delete a CPU pool from one Oracle Database Appliance Virtualized Platform node.
- [oakcli delete database](#) (page 10-33)
Use the `oakcli delete database` command to delete a database from Oracle Database Appliance.
- [oakcli delete db_config_params](#) (page 10-33)
Use the `oakcli delete db_config_params` command to delete a database configuration file.
- [oakcli delete dbhome](#) (page 10-34)
Use the `oakcli delete dbhome` command to delete a database home from Oracle Database Appliance.
- [oakcli delete dbstorage](#) (page 10-34)
Use the `oakcli delete dbstorage` command to delete a storage structure that was created for the purpose of migrating databases from Oracle ASM to Oracle ACFS.
- [oakcli delete repo](#) (page 10-35)
Use the `oakcli delete repo` command to delete a shared repository.
- [oakcli delete vdisk](#) (page 10-35)
Use the `oakcli delete vdisk` command to delete a virtual disk from a shared repository on Oracle Database Appliance Virtualized Platform.
- [oakcli delete vlan](#) (page 10-36)
Use the `oakcli delete vlan` command to delete a virtual local area network.
- [oakcli delete vm](#) (page 10-36)
Use the `oakcli delete vm` command to delete a virtual machine.
- [oakcli delete vmtemplate](#) (page 10-36)
Use the `oakcli delete vmtemplate` command to delete a virtual machine template.

10.9.1 oakcli delete cpupool

Use the `oakcli delete cpupool` command to delete a CPU pool from one Oracle Database Appliance Virtualized Platform node.

Syntax

```
oakcli delete cpupool poolname -node nodenum [-h]
```

Parameters

Parameter	Description
<i>poolname</i>	Name of the CPU pool to be deleted
-node <i>nodenum</i>	Node from which the CPU pool will be deleted (0 or 1)
-h	(Optional) Display help for using the command.

Example

Delete the CPU pool named *twonode* from Node 1 of Oracle Database Appliance Virtualized Platform:

```
oakcli delete cpupool twonode -node 1
```

10.9.2 oakcli delete database

Use the `oakcli delete database` command to delete a database from Oracle Database Appliance.

Syntax

```
oakcli delete database -db db_name [-h]
```

Parameters

Parameter	Description
<i>db_name</i>	Name of the database that you want to delete
-h	(Optional) Display help for using the command

Example

Delete the database named *sales1*:

```
oakcli delete database -db sales1
```

10.9.3 oakcli delete db_config_params

Use the `oakcli delete db_config_params` command to delete a database configuration file.

Syntax

```
oakcli delete db_config_params -conf filename [-h]
```

Parameters

Parameter	Description
<code>-conffilename</code>	Name of the configuration file that you want to remove, without its path name
<code>-h</code>	(Optional) Display help for using the command

10.9.4 oakcli delete dbhome

Use the `oakcli delete dbhome` command to delete a database home from Oracle Database Appliance.

Syntax

```
oakcli delete dbhome -oh oracle_home [-h]
```

Parameters

Parameter	Description
<code>-oh <i>oracle_home</i></code>	The database home to be uninstalled
<code>-h</code>	(Optional) Display help for using the command.

Example

Delete a database home called `ora11_1`:

```
oakcli delete dbhome -oh ora11_1
```

10.9.5 oakcli delete dbstorage

Use the `oakcli delete dbstorage` command to delete a storage structure that was created for the purpose of migrating databases from Oracle ASM to Oracle ACFS.

For example, run this command if you created a storage structure using `create dbstorage` that is no longer required.

Syntax

```
oakcli delete dbstorage -db db_name [-cdb] [-h]
```

Parameters

Parameter	Description
<code>db <i>db_name</i></code>	Name of the database structure to be deleted
<code>-cdb</code>	Must be passed if you are deleting a multitenant container database
<code>-h</code>	(Optional) Display help for using the command

Example

Delete the `sales` storage structure:

```
oakcli delete dbstorage -db sales
```

10.9.6 oakcli delete repo

Use the `oakcli delete repo` command to delete a shared repository.

Syntax

```
oakcli delete repo repository_name [-h]
```

Parameter

Parameter	Description
<i>repository_name</i>	The name of the shared repository to be deleted
-h	(Optional) Display help for using the command.

Example

Delete the `testrepo01` shared repository:

```
oakcli delete repo testrepo01
```

The command will not succeed if `testrepo01` is active on one or both nodes.

10.9.7 oakcli delete vdisk

Use the `oakcli delete vdisk` command to delete a virtual disk from a shared repository on Oracle Database Appliance Virtualized Platform.

Syntax

```
oakcli delete vdisk vdisk_name -repo repository_name [-h]
```

Parameters

Parameter	Description
<i>vdisk_name</i>	Name assigned to the virtual disk
-repo <i>repository_name</i>	Name of the shared repository where the virtual disk was created
-h	(Optional) Display help for using the command.

Example

Remove a virtual disk named `t2g` from the shared repository named `repoprod1`:

```
oakcli delete vdisk t2g -repo repoprod1
```

10.9.8 oakcli delete vlan

Use the `oakcli delete vlan` command to delete a virtual local area network.

Syntax

```
oakcli delete vlan vlan_name -node node_number [-h]
```

Parameters

Parameter	Description
<code>vlan <i>vlan_name</i></code>	Name of the virtual local area network to be deleted
<code>-node <i>node_number</i></code>	Oracle Database Appliance node from which you want to remove the virtual local area network
<code>-h</code>	(Optional) Display help for using the command.

Example

Delete the `sample1` virtual local area network from Node 1:

```
oakcli delete vlan sample1 -node 1
```

10.9.9 oakcli delete vm

Use the `oakcli delete vm` command to delete a virtual machine.

Syntax

```
oakcli delete vm vm_name [-server node_number] [-h]
```

Parameters

Parameter	Description
<code>vm <i>vm_name</i></code>	(Optional) Name of the virtual machine to be deleted
<code>-server <i>node_number</i></code>	(Optional) Oracle Database Appliance node from which you want to remove the virtual machine. If this optional parameter is not included, then the virtual machine is removed from both nodes.
<code>-h</code>	(Optional) Display help for using the command.

Example

Delete the `ovu22` virtual machine from Node 1:

```
oakcli delete vm ovu22 -server 1
```

10.9.10 oakcli delete vmtemplate

Use the `oakcli delete vmtemplate` command to delete a virtual machine template.

Syntax

```
oakcli delete vmtemplate template_name [-server=node_number][-h]
```

Parameters

Parameter	Description
<i>template_name</i>	Name of the virtual machine template to be removed
-server <i>node_number</i>	(Optional) Oracle Database Appliance node from which you want to remove the virtual machine template. If this optional parameter is not included, then the virtual machine template is removed from both nodes.
-h	(Optional) Display help for using the command.

Example

Delete the `ovu22` virtual machine template from both nodes:

```
oakcli delete vmtemplate ovu22
```

10.10 oakcli deploy

Use the command `oakcli deploy` to deploy Oracle Grid Infrastructure for a cluster on Oracle Database Appliance.

Syntax

```
oakcli deploy [-config] [-conf config_file] [-advance][-h]
```

Parameters

Parameter	Description
-config	(Optional) Run the Oracle Appliance Manager Configurator.
-conf <i>config_file</i>	(Optional) Preload the configuration stored in the named configuration file, <i>config_file</i> .
-advance	(Optional) Perform the deployment, or run the Oracle Appliance Manager Configurator, in advance mode. Use this option to launch Oracle Appliance Manager and change the default user ID or group user ID.
-h	(Optional) Display help for using the command.

Usage Notes

When defining the user ID and the group ID, it is a best practice to use different values.

Examples

Use these examples to understand how to use the command `oakcli deploy`.

Example 10-12 Deploying the Complete Oracle Database Appliance

```
oakcli deploy
```

Example 10-13 Running the Configurator

```
oakcli deploy -config
```

Example 10-14 Running the Offline Configurator with Advance Mode

To run the offline Configurator with advance mode, update the `config.sh` file and add `-advance`.

```
cat config.sh #!/bin/sh java -Djava.util.logging.config.file=onecommand.properties -
jar onecommand.jar config -advance run ./config.sh
```

Example 10-15 Preloading an Existing Configuration File

Preload the configuration stored in the configuration file `MYCONFIG-VM`:

```
oakcli deploy -conf myconfig -vm_file
```

Example 10-16 Changing a User Group Name or ID

You can change the following group user names or IDs on the User Group Information page: GI User, DB User, Install Group, DBA Group, DBA Oper Group, ASM DBA Group, ASM Oper Group, and ASM Admin Group.

1. Run the Configurator or Offline Configurator in `-advance` mode.
2. Select **Custom** to display the User Group Information page.
3. Change the group name or ID, then click **Next**.
4. Click **Finish**.

Example 10-17 Viewing the Log File

The command `oakcli deploy` creates a log file that is prepended with the character string `STEP*`. The log file is stored in the following location:

```
/opt/oracle/oak/onecmd/tmp/
```

10.11 oakcli describe-cpucore

Use the `oakcli describe-cpucore` command to display the number of CPU cores enabled for Oracle Database Appliance X6-2-HA.

File Path

```
$ORACLE_HOME/opt/oracle/oak/bin/oakcli
```

Syntax

```
oakcli describe-cpucore [-h]
```

Parameters

Parameter	Description
-h	(Optional) Display help for using the command.

Usage Notes

This command applies only to bare metal deployments. It is not available on an Oracle Database Appliance Virtualized Platform.

Example 10-18 Enabling 10 CPU Cores for Oracle Database Appliance X6-2-HA

```
# oakcli describe-cpucore

Enabled Cores (per server)           =    12
Total Enabled Cores (on two servers) =    24
Server type                           =    X6-2 -> Oracle Server X6-2
Hyperthreading is enabled. Each core has 2 threads.
Operating system displays 24 processors per server.
```

10.12 oakcli expand storage

Use the `oakcli expand storage` command to configure the solid-state drives (SSDs) for data storage into the existing base configuration to fully populate the base storage shelf.

File Path

```
$ORACLE_HOME/opt/oracle/oak/bin/oakcli
```

Syntax

```
oakcli expand storage [-h]
```

Parameters

Parameter	Description
-h	(Optional) Display help for using the command.

Usage Notes

After all disks are inserted into the slots, execute the `oakcli expand storage` command on both nodes. First on the master node and then wait for 30 seconds and execute from the slave nodes. It takes about 10 to 12 minutes to add all of the disks.

Review the procedure for how to add the storage shelf for detailed steps on how to add the disks, the timing needed to avoid flooding disk events, and the steps to validate that all disks are online and are in a good state.

Example 10-19 Expanding Storage

```
#oakcli expand storage

Precheck passed.
Successfully formatted 1.6TB SSD disks...
Check the progress of expansion of storage by executing 'oakcli show disk'
Waiting for expansion to finish ...
```

Related Topics

- [Preparing for a Storage Upgrade](#) (page 8-2)
Review and perform these best practices before adding storage to the base shelf or adding the expansion shelf.
- [Adding the 10-Pack of SSDs](#) (page 8-4)
Add the 10-pack solid-state drives (SSDs) for data storage into the existing base configuration to fully populate the base storage shelf.

10.13 oakcli diskwritecache

Use the `oakcli diskwritecache` command to locate disks with write cache enabled and to disable disk write cache for those disks.

Enabled write caches should be disabled as soon as downtime for Oracle Database Appliance can be scheduled. During the downtime, use this command with the `disable` option for each disk, in turn, that has an enabled write cache.

Syntax

```
oakcli diskwritecache [disable disk_name | enable disk_name | status ] [-h]
```

Parameters

Parameter	Description
<code>disable <i>disk_name</i></code>	(Optional) Disable disk write cache for named disk.
<code>enable <i>disk_name</i></code>	(Optional) Enable disk write cache for named disk.
<code>status</code>	(Optional) Show the write cache status of all disks.
<code>-h</code>	(Optional) Display help for using the command.

Example 10-20 Displaying the Write Cache Status of Disks

Show the write cache status of all disks:

```
oakcli diskwritecache status
```

10.14 oakcli import vmtemplate

Use the `oakcli import vmtemplate` command to import virtual machine templates.

Syntax

```
oakcli import vmtemplate vmtemplatename -files image_files | -assembly assembly_file  
-repo repo_name [- node 0 | 1 ] [-h]
```

Parameters

Parameter	Description
<code><i>vmtemplatename</i></code>	Name that you want to assign to the template
<code>-files</code>	Use the <code>-files</code> option when importing one or more files that comprise a template.

Parameter	Description
<i>image_files</i>	<i>image_files</i> is one of the following: <ul style="list-style-type: none"> • A single template file name • A comma-separated list of files that comprise a single template • A URL enclosed in single quotation marks that links to a template file
-assembly	Use the -assembly option when importing an assembly file.
<i>assembly_file</i>	An assembly file, or a URL enclosed in single quotation marks, that links to an assembly file
<i>repo_name</i>	Name of the repository to store the template or templates that you are importing
-node	When you are importing to a shared repository, use the -node option with a value of 0 or 1 to identify the node.
-h	(Optional) Display help for using the command.

Usage Notes

- Include only one of the options, -files or -assembly, each time you run this command. You cannot include both of these options in the same statement.
- If the command imports more than one template from an assembly, then each template will automatically be given a unique name. These template names will include the name given in the vmtemplate vmtemplatename clause followed by a sequence number, such as vmtemplatename1, vmtemplatename2, and vmtemplatename3.
- When importing into a shared repository, you must include the -node option with a valid node number, 0 or 1. Using the -node option for imports into non-shared repositories will cause the command to fail.

Examples

Here are examples of how to use the oakcli import vmtemplate command.

Example 10-21 Importing a Virtual Machine Template from Dom0

Import the required template (OVM_OL5U7_X86_64_PVM_10GB.tgz) from the /OVS directory in Dom0 into the odarepo1 repository and name the template file OL5U7:

```
oakcli import vmtemplate OL5U7 -files /OVS/OVM_OL5U7_X86_64_PVM_10GB.tgz -repo
odarepo1
```

Example 10-22 Importing a Virtual Machine Template from a Remote Server

Import a template from a remote server using a URL to identify the server and the template file:

```
oakcli import vmtemplate OL5U6 -files 'http://example.com/vm-template/OEL-5/
OVM_OL5U6_X86_64_PVM_10GB.tgz' -repo odarepo2
```

Example 10-23 Importing Virtual Machine Templates from an Assembly on a Remote Server

Import the templates contained in the assembly file stored on a remote server at the URL provided into the odarepo1 repository:

```
oakcli import vmtemplate OL6U1 -assembly 'http://example.com/assemblies/OEL6/
OVM_OL6U1_x86_PVHVM.ova' -repo odarepo1
```

Example 10-24 Importing Virtual Machine Templates Into a Shared Repository From an Assembly on a Remote Server

Import the templates contained in the assembly file stored on a remote server at the URL provided into a shared repository named `repo4` on Node 1:

```
oakcli import vmtemplate OL6U1 -assembly 'http://example.com/assemblies/OEL6/
OVM_OL6U1_x86_PVHVM.ova' -repo repo4 -node 1
```

10.15 oakcli locate disk

Use the `oakcli locate disk` command to locate the physical disk that is associated with a named Oracle ASM disk by turning the disk's LED light on or off.

Syntax

```
oakcli locate disk diskname [on|off][-h]
```

Parameters

Parameter	Description
<i>diskname</i>	Name of the Oracle ASM disk to locate
on	(Optional) Turns on the LED of the named disk
off	(Optional) Turns off the LED of the named disk
<i>-h</i>	(Optional) Display help for using the command.

Example 10-25 Locating an Oracle ASM Disk by Turning on the Disk's LED

Turn on the LED of the Oracle ASM disk named `disk pd_23`:

```
oakcli locate disk pd_23 on
```

10.16 oakcli manage diagcollect

Use the `oakcli manage diagcollect` command to collect diagnostic information about Oracle Database Appliance for troubleshooting purposes, and for working with Oracle Support Services.

Syntax

```
oakcli manage diagcollect [--all | --crs [--crshome crs_home_dir]
(continued)
[--core] | --install | --chmos [--incidenttime time] [--incidentduration time]
(continued)
|--adr adr_location [--afterdate date]
(continued)
[--aftertime time] [--beforetime time] ]
[excl comp1,comp2,...] [--clean] [--storage][-h]
```

Parameters

Parameter	Description
<code>--all</code>	Collect all of the diagnostic information excluding Automatic Diagnostic Repository (ADR) and Cluster Health Monitor. This is the default option.
<code>--crs</code>	Collect Oracle Clusterware diagnostic information.
<code>--crshome <i>crs_home_dir</i></code>	Specifies the location of the Oracle Clusterware home directory
<code>--core</code>	Package core files with the Oracle Clusterware diagnostic data.
<code>--install</code>	Collect the installation logs when the installation failed before running the script <code>root.sh</code> .
<code>--adr <i>adr_location</i></code>	Collect diagnostic information for ADR, where <i>adr_location</i> specifies the location of the ADR information.
<code>--afterdate <i>date</i></code>	Collect archives from the specified date. Specify the date in the <code>mm/dd/yyyy</code> format.
<code>--aftertime <i>time</i></code>	Collect the archives after the specified time. Enter the time using the format <code>YYYYMMDDHHMMSS24</code> . Supported only with the <code>-adr</code> parameter.
<code>--beforetime <i>time</i></code>	Collect the archives before the specified time. Enter the time using the format: <code>YYYYMMDDHHMMSS24</code> . Supported only with the <code>-adr</code> parameter.
<code>--chmos</code>	Collect Cluster Health Monitor data.
<code>--incidenttime <i>time</i></code>	Collect Cluster Health Monitor data from the specified time. Enter the time using the format: <code>YYYYMMDDHHMMSS24</code> . If you do not use the <code>--incidenttime</code> parameter, then the command collects data for the past 24 hours.
<code>--incidentduration <i>time</i></code>	Collect Cluster Health Monitor data for the duration after the specified time. Enter the time using the format: <code>HH:MM</code> . If you do not specify a duration, then the command collects all Cluster Health Monitor data after the specified incident time.
<code>--excl [<i>comp1,comp2...</i>]</code>	Exclude the specified component logs. Valid components are: <code>acfs, invt, sys, ocr, crs, home, and base</code> .
<code>--clean</code>	Remove the diagnosability information gathered by this command.
<code>--storage</code>	Collect all of the logs for any storage issues. The logs can be used when you are experiencing any problems with storage and need support to diagnose the logs.
<code>--h</code>	(Optional) Display help for using the command.

10.17 oakcli migrate vm

Use the `oakcli migrate vm` command to migrate a currently running virtual machine to another node.

Syntax

```
oakcli migrate vm vmname [-h]
```

Parameters

Parameter	Description
<i>vmname</i>	Name of the virtual machine to be migrated
-h	(Optional) Display help for using the command.

10.18 oakcli modify commands

Use the `oakcli modify` commands to modify the database, an existing virtual machine or virtual machine template.

You can use `oakcli modify` to modify databases, attach virtual disks to or detach virtual disks from virtual machines, transmit first-boot installation configuration messages to virtual machines, and to assign networks to or delete networks from virtual machines and virtual machine templates.

Topics:

- [oakcli modify database](#) (page 10-44)
Use the `oakcli modify database` command to modify the database type or size class for a named database.
- [oakcli modify vm](#) (page 10-45)
Use the `oakcli modify vm` command to modify an existing virtual machine.
- [oakcli modify vmtemplate](#) (page 10-46)
Use the `oakcli modify vmtemplate` command to add networks to or delete networks from an existing virtual machine template.

10.18.1 oakcli modify database

Use the `oakcli modify database` command to modify the database type or size class for a named database.

Syntax

```
oakcli modify database -db db name [-dbtypeOLTP/DSS/in-Memory] [-to dbSizeclass]
```

Parameters

Parameter	Description
-db <i>db-name</i>	Identifies the database being modified.
-dbtype <code>OLTP</code> / <code>DSS</code> / <code>in-Memory</code>	(Optional) Changes the database type. The parameter <code>dbtype</code> takes one of the following three options: <ul style="list-style-type: none"> • <code>OLTP</code>: Online transaction processing • <code>DSS</code>: Decision support system • <code>in-Memory</code>: Oracle Database In-Memory
-to <i>dbclass</i>	(Optional) Changes the database size class.
-h	(Optional) Displays help for using the command.

Usage Notes

 **Note:**

When you resize the database, the redo log file size is not modified automatically. Change the size of the redo log manually to the size that you require for your applications.

Example 10-26 Modifying the Database Type

Here are examples of how to use the `oakcli modify database` command.

Change the database type assigned to the database `dbhome_1` to a DSS database:

```
oakcli modify database DB dbhome_1 -dbtype DSS
```

Example 10-27 Modifying the Database Size

Change the database size for the database named `dbhome_1` to a 6-core CPU Oracle Database Appliance DSS database template:

```
oakcli modify database dbhome_1 -to odb-06
```

10.18.2 oakcli modify vm

Use the `oakcli modify vm` command to modify an existing virtual machine.

Syntax

```
oakcli modify vm vmname [-attachvdisk|-deletenetworkvlaname] [-s  
key1:value1;key2:value2;...] [-addnetwork|-deletenetworkvlaname] [-h]
```

Parameters

Parameter	Description
<code>-attachvdiskvdisk_name</code>	(Optional) Attaches the named VDisk (virtual disk) to the named virtual machine.
<code>-detachvdiskvdisk_name</code>	(Optional) Detaches the named VDisk disk from the named virtual machine.
<code>-s key1:value1;key2:value2; ...</code>	(Optional) Identifies a message consisting of one or more semicolon separated key:value pairs to send to the ovm utility. Each key and value is separated by a colon (:) and each key/value pair is separated from the next key/value pair by quotation marks.
<code>-addnetworkvlaname</code>	(Optional) Adds a VLAN network to the named virtual machine.
<code>-deletenetworkvlaname</code>	(Optional) Removes a VLAN network from the named virtual machine.
<code>-h</code>	(Optional) Displays help for using the command.

Usage Notes

- Do not use the `-attachvdisk` or the `-detachvdisk` option with the `-addnetwork`, `-deletenetwork`, or `-s` parameters.
- Include only one of the `-addnetwork`, `-deletenetwork`, or `-s` parameters when you use this command.

Example 10-28 Sending a Message to a Running Virtual Machine

Update the `root` user password for the `gc_11g` virtual machine:

```
oakcli modify vm gc_11g -s "com.oracle.linux.root-password:password"
```

10.18.3 oakcli modify vmtemplate

Use the `oakcli modify vmtemplate` command to add networks to or delete networks from an existing virtual machine template.

Syntax

```
oakcli modify vmtemplate vmtemplatename [-addnetwork|-deletenetworkvlanname] [-h]
```

Parameters

Parameter	Description
<code>-addnetworkvlanname</code>	(Optional) Adds a VLAN network to the named virtual machine template
<code>-deketenetworkvlanname</code>	(Optional) Deletes a VLAN network from the named virtual machine template
<code>-h</code>	(Optional) Displays help for using the command.

Example 10-29 Modifying the Network Defined in a Virtual Machine Template

Replace the network assigned to the `gc_11g` virtual machine template with the `net1` network:

```
oakcli modify vmtemplate gc_11g -addnetwork net1
```

10.19 oakcli orachk

Use the `oakcli orachk` command to audit configuration settings with the ORAchk utility.

Syntax

```
oakcli orachk [-a|-b|-v|-h|-p|-f|-m[-u -o][o]-c -t][--clusternodes |--localonly][--debug][--dbnames |--dbnone|--dball][upgrade]listlist
```

Parameters

Parameter	Description
<code>-a</code>	Perform a best practice check and recommended patch check.
<code>-b</code>	Perform a best practice check only without the recommended patch check.

Parameter	Description
-v	Display version.
-h	Display command usage (help).
-p	Perform patch check only.
-f	Run the command offline.
-m	Exclude checks for Maximum Availability scorecards.
-u -o	Perform check on pre-upgrade best practices (-u -o pre) or on post-upgrade best practices (-u -o post).
-o	As an argument to an option, if -o is followed by v, V, Verbose, or VERBOSE, output will display checks that pass on the display. Without the -o option, only failures will display on the screen.
-c	Determines granularity of information displayed on the screen. For use only when working with Oracle Support Services.
-clusternodes <i>list</i>	<i>list</i> is a comma-delimited list containing the names of the nodes where the command should run.
-localonly	Run the command only on the local node.
-debug	Creates a debug log.
-dbnames <i>list</i>	<i>list</i> is a comma-delimited list containing the names of the subset of databases on which the command should run.
-dbnone	Skip all database-related checks on all databases without prompting to select which database to skip.
-dball	Run all database-related checks on all databases without prompting to select which databases to check.
-upgrade	Force upgrade of the version of the ORAchK utility being run.

Usage Notes

- The command offers multiple options that are generic to the ORAchK command when run on servers other than the Oracle Database Appliance server. You can find details about these options by running the command `oakcli orachk -h`. The options are grouped into the following categories, but this document does not list the options for each category:
 - Report Options
 - Auto Restart Options
 - Daemon Options
 - Profile Run Options
- For more information about ORAchK, see My Oracle Support note 1268927.2, "ORAchK Health Checks for the Oracle Stack" at <https://support.oracle.com/CSP/main/article?cmd=show&type=NOT&id=1268927.2>

10.20 oakcli reconfigure osparams

Use the `oakcli reconfigure osparams` command to adjust the kernel parameters based on the available RAM after you upgrade memory or DIMM.

After you change or expand memory on Oracle Database Appliance, use the `oakcli reconfigure osparams` command to display the current configuration and suggested values for `memlock` and `vm.nr_hugepages`. When prompted, answer `yes` or `no` to change the value to the suggested value.

Syntax

```
oakcli reconfigure osparams [-h]
```

Parameters

Parameter	Description
-h	(Optional) Displays help for using the command.

Usage Notes

After you change or expand memory on Oracle Database Appliance, use this command to update the kernel parameters.



Note:

When adjusting the settings, ensure that you make the changes on both nodes.

Example 10-30 Viewing the Current and Suggested Kernel Parameters

In this example, the output displays the configured and suggested values for `memlock` and `vm.nr_hugepages`. When prompted, enter `no` for both parameters to view, but not implement the suggested values.

```
# oakcli reconfigure osparams
Configured value for memlock is: 11000000
Suggested value for memlock is: 11000000
Do you want to use suggested value of memlock?: yes/no
no
User entered no, not updating kernel.memlock
Configured value for vm.nr_hugepages is: 2048
Suggested value for vm.nr_hugepages parameter is: 4150
Do you want to update to suggested value?: yes/no
no
User entered no, not updating kernel.vm.nr_hugepages
```

Example 10-31 Reconfiguring the Kernel Based on Available RAM

In this example, the output displays the configured and suggested values for `memlock` and `vm.nr_hugepages`. The `memlock` value does not require changing. A new value is suggested for `vm.nr_hugepages`. When prompted, enter `yes` to update to the suggested value.

 **Note:**

You must adjust the value on both nodes.

```
# oakcli reconfigure osparams
Configured value for memlock is: 193000000
Suggested value for memlock is: 193000000
Configured and suggested values are same
Configured value for vm.nr_hugepages is: 67815
Suggested value for vm.nr_hugepages parameter is: 67748
Do you want to update to suggested value?: yes/no
yes
```

10.21 oakcli resize dbstorage

Use the `oakcli resize dbstorage` command to resize the space used for a storage structure that was created for the purpose of migrating databases from Oracle ASM to Oracle ACFS.

You can check the current space usage using `oakcli show fs` and then add space using `oakcli resize dbstorage`.

 **Note:**

You cannot decrease the size of the space used for Oracle ACFS.

Syntax

```
oakcli resize dbstorage -data size -reco size -redo size -db db_name [-h]
```

Parameters

Parameter	Description
-data <i>size</i>	Extendable size in GB for the DATA volume.
-reco <i>size</i>	Extendable size in GB for the REDO volume.
-redo <i>size</i>	Extendable size in GB for the RECO volume.
-db <i>db_name</i>	Database for which these volumes must be resized.
-h	(Optional) Display help for using the command.

Example 10-32 Increasing the Size of the DATA Volume

Increase the size of the volume by 10 GB on the DATA volume:

```
oakcli resize dbstorage -data 10
```

10.22 oakcli restart oda_base

Use the `oakcli restart oda_base` command to stop and restart ODA_BASE on the local node.

Use this command only when you are not concerned about the current status of ODA_BASE, because it performs a forced shutdown. You must run this command from Dom0. Typically, if ODA_BASE needs to be restarted, then you must restart it on both nodes.

Syntax

```
oakcli restart oda_base [-h]
```

The ODA_BASE that you want to restart is on the same node as the Dom0 from which you run this command.

Parameter

(Optional) -h displays help for using the command.

10.23 oakcli show commands

Use the `oakcli show` commands to display the status of Oracle Database Appliance components.

The `oakcli show` commands display status information for the node where you run the command. To see the list of components available on the current node, use the help option: `oakcli show -h`:

Note:

Depending on your model and version of Oracle Database Appliance software, the `oakcli show` command options may differ from the ones shown in this section and explained in the following sections. To obtain an annotated list of components available on your system, run the command `oakcli show -h`.

- [oakcli show asr](#) (page 10-53)
Use the `oakcli show asr` command to display your Oracle Auto Service Request configuration details.
- [oakcli show cooling](#) (page 10-53)
Use the `oakcli show cooling` command to display the status of the cooling units.
- [oakcli show controller](#) (page 10-53)
Use the `oakcli show controller` command to display information about the disk controllers.
- [oakcli show core_config_key](#) (page 10-54)
Use the `oakcli show core_config_key` command to display information about how to deploy your Oracle Database Appliance cores.
- [oakcli show cpupool](#) (page 10-54)
Use the `oakcli show cpupool` command to display core allocations to virtual machine mappings.

- [oakcli show databases](#) (page 10-55)
Use the `oakcli show databases` command to display information about each existing database, including database name, database type, database home name and location, and database version.
- [oakcli show db_config_params](#) (page 10-56)
Use the `oakcli show db_config_params` command to display configuration file names and parameters.
- [oakcli show dbhomes](#) (page 10-56)
Use the `oakcli show dbhomes` command to display information about each existing Oracle database home, including home name, home location, and database version.
- [oakcli show dbstorage](#) (page 10-57)
Use the `oakcli show dbstorage` command to display database storage information for databases created on Oracle Automatic Storage Management Cluster File System (Oracle ACFS).
- [oakcli show disk](#) (page 10-58)
Use the `oakcli show disk` command to display disk information.
- [oakcli show diskgroup](#) (page 10-59)
Use the `oakcli show diskgroup` command to display Oracle Automatic Storage Management (Oracle ASM) disk group information.
- [oakcli show enclosure](#) (page 10-59)
Use the `oakcli show enclosure` command to display information about the storage enclosure subsystem on the node where the command is executed.
- [oakcli show env_hw](#) (page 10-60)
Use the `oakcli show env_hw` command to display the environment type and hardware version of the current node.
- [oakcli show expander](#) (page 10-60)
Use the `oakcli show expander` command to display information about a SAS expander.
- [oakcli show ib](#) (page 10-60)
Use the `oakcli show ib` command to display InfiniBand card and port information if InfiniBand exists in the system.
- [oakcli show ismaster](#) (page 10-61)
Use the `oakcli show ismaster` command to determine which node is the master node.
- [oakcli show fs](#) (page 10-61)
Use the `oakcli show fs` command to display all database and cloudfs file systems created on ASM Cluster File System (ACFS) in addition to the local file systems on the Oracle Database Appliance node.
- [oakcli show iraid](#) (page 10-61)
Use the `oakcli show iraid` command to display internal RAID and local disk information.
- [oakcli show memory](#) (page 10-62)
Use the `oakcli show memory` command to display information about memory modules.
- [oakcli show network](#) (page 10-62)
Use the `oakcli show network` command to display information about the network subsystem.

- [oakcli show power](#) (page 10-62)
Use the `oakcli show power` command to display information about the power supply subsystem.
- [oakcli show processor](#) (page 10-63)
Use the `oakcli show processor` command to display information about CPU processors.
- [oakcli show raidsyncstatus](#) (page 10-63)
Use the `oakcli show raidsyncstatus` command to display the status of the RAID rebuild after a failed local disk is replaced.
- [oakcli show repo](#) (page 10-63)
Use the `oakcli show repo` command to display information about virtual machine repositories.
- [oakcli show server](#) (page 10-64)
Use the `oakcli show server` command to display information about the server subsystem.
- [oakcli show storage](#) (page 10-65)
Use the `oakcli show storage` command to display information about the storage for controllers, expanders, and disks.
- [oakcli show validation storage](#) (page 10-65)
Use the `oakcli show validation storage` command to show whether validation storage is enabled or disabled.
- [oakcli show validation storage errors](#) (page 10-65)
Use the `oakcli show validation storage errors` command to show hard storage errors.
- [oakcli show validation storage failures](#) (page 10-66)
Use the `oakcli show validation storage failures` command to show soft validation errors. A typical soft disk error would be an invalid version of the disk firmware.
- [oakcli show vdisk](#) (page 10-66)
Use the `oakcli show vdisk` command to display information about virtual disks on Oracle Database Appliance Virtualized Platform.
- [oakcli show version](#) (page 10-67)
Use the `oakcli show version` command to display the applied patch versions for Oracle Database Appliance software and firmware.
- [oakcli show vlan](#) (page 10-68)
Use the `oakcli show vlan` command to display information about virtual local area networks (VLANs) configured on Oracle Database Appliance.
- [oakcli show vm](#) (page 10-69)
Use the `oakcli show vm` command to display information about virtual machines.
- [oakcli show vmconsole](#) (page 10-70)
Use the `oakcli show vmconsole` command to open a GUI virtual machine console to manage a specific virtual machine.
- [oakcli show vmtemplate](#) (page 10-70)
Use the `oakcli show vmtemplate` command to display information about virtual machine templates.

10.23.1 oakcli show asr

Use the `oakcli show asr` command to display your Oracle Auto Service Request configuration details.

Syntax

```
oakcli show asr [-h]
```

Parameters

(Optional) `-h` displays the help for using this command.

10.23.2 oakcli show cooling

Use the `oakcli show cooling` command to display the status of the cooling units.

Syntax

```
oakcli show cooling [-h]
```

Parameters

(Optional) `-h` displays the help for using this command.

Example

Display the cooling unit information for the node where the command is executed:

```
oakcli show cooling
NAME    HEALTH HEALTH_DETAILS LOCATION FAN % FAN SPEED
Fan_0   OK      -             FM0     30 % 6300 RPM
Fan_1   OK      -             FM0     19 % 3800 RPM
Fan_10  OK      -             FM2     34 % 6600 RPM
Fan_11  OK      -             FM2     23 % 4100 RPM
Fan_12  OK      -             FM3     32 % 6300 RPM
Fan_13  OK      -             FM3     22 % 3900 RPM
Fan_14  OK      -             FM3     24 % 4700 RPM
Fan_15  OK      -             FM3     14 % 2500 RPM
Fan_2   OK      -             FM0     29 % 6400 RPM
Fan_3   OK      -             FM0     18 % 3700 RPM
Fan_4   OK      -             FM1     32 % 6400 RPM
Fan_5   OK      -             FM1     20 % 3700 RPM
Fan_6   OK      -             FM1     33 % 6400 RPM
Fan_7   OK      -             FM1     22 % 3800 RPM
Fan_8   OK      -             FM2     33 % 6400 RPM
Fan_9   OK      -             FM2     22 % 3900 RPM
```

10.23.3 oakcli show controller

Use the `oakcli show controller` command to display information about the disk controllers.

Syntax

```
oakcli show controller controller_id [-h]
```

Parameters

Parameter	Description
<i>controller_id</i>	Specifies the controller for which to display information
-h	(Optional) Display help for using the command.

Displaying Disk Controller Details

Display details of controller 0:

```
oakcli show controller 0
```

10.23.4 oakcli show core_config_key

Use the `oakcli show core_config_key` command to display information about how to deploy your Oracle Database Appliance cores.

Syntax

```
oakcli show core_config_key
```

Examples

Here are examples of how to use the `oakcli show core_config_key` command.

Determining Whether the Oracle Database Appliance Core Configuration Key Has Been Applied

Show the core count status on a new Oracle Database Appliance that has not been configured:

```
oakcli show core_config_key
Optional core_config_key is not applied on this machine yet!
```

Displaying the Oracle Database Appliance Core Count Status on a Configured Oracle Database Appliance

Show the core count status on a previously configured Oracle Database Appliance:

```
oakcli show core_config_key
Host's serialnumber = 1132FMW003
Configured Cores = 20
```

10.23.5 oakcli show cpupool

Use the `oakcli show cpupool` command to display core allocations to virtual machine mappings.

Syntax

```
oakcli show cpupool -node nodenum
```

nodenum is the number of the Oracle Database Appliance node that you want to examine, either 0 or 1.

Displaying Core Mapping for Node 0

Display the core mapping information for Node 0:

```
oakcli show cpupool -node 0
      Pool          Cpu List          VM List
default-unpinned-pool [14, 15, 16, 17, 18, 19, 20, 21, 22, 23] ['test1_odarepo1', 'sample5_odarepo1', 'vm_very_long_name_sample1_odarepo1', 'win_vm1']
      twocpu        [12, 13]          ['vm1_odarepo1']
odaBaseCpuPool        [0, 1, 2, 3, 10, 11] ['oakDom1']
```

10.23.6 oakcli show databases

Use the `oakcli show databases` command to display information about each existing database, including database name, database type, database home name and location, and database version.

Syntax

```
oakcli show databases [-h]
```

Parameters

Parameter	Description
-h	(Optional) Displays help for using the command.

Usage Notes

On Oracle Database Appliance, the minimum supported Oracle Database release is 11.2.0.4. Oracle Database 11.2.0.3.x is not supported.

Example 10-33 Displaying Database Details

```
# oakcli show databases
Name Type Storage HomeName HomeLocation
Version
-----
omydb RAC ACFS OraDb12102_home1 /u01/app/oracle/product/12.1.0.2/dbhome_1
12.1.0.2.160719(23054246,23054327)
orcl RAC ACFS OraDb12102_home1 /u01/app/oracle/product/12.1.0.2/dbhome_1
12.1.0.2.160719(23054246,23054327)
```

Example 10-34 Displaying Database Details for Four Databases

```
#oakcli show databases
Name Type Storage HomeName HomeLocation Version
-----
db1 RAC ACFS OraDb12102_home1 /u01/app/oracle/product/12.1.0.2/dbhome_1 12.1.0.2.5(21359755,21359758)
db2 SINGLE ACFS OraDb12102_home2 /u01/app/oracle/product/12.1.0.2/dbhome_2 12.1.0.2.5(21359755,21359758)
db3 RACOneNode ACFS OraDb12102_home3 /u01/app/oracle/product/12.1.0.2/dbhome_3 12.1.0.2.5(21359755,21359758)
db4 RAC ACFS OraDb12102_home4 /u01/app/oracle/product/12.1.0.2/dbhome_4 12.1.0.2.5(21359755,21359758)
```

10.23.7 oakcli show db_config_params

Use the `oakcli show db_config_params` command to display configuration file names and parameters.

The command searches for files with the extension `.dbconf` located in the `/opt/oracle/oak/install/dbconf` directory.

Syntax

```
oakcli show db_config_params [-conf filename] [-detail] [-h]
```

Parameters

Parameter	Description
<code>-conf filename</code>	(Optional) Name of configuration file to be displayed. If not included, then the command displays all configuration files.
<code>-detail</code>	(Optional) Display the parameter values stored in the configuration file or files.
<code>-h</code>	(Optional) Display help for using the command.

Displaying the Default Database Configuration Parameters

Display the default database configuration parameter values stored in the configuration file or files:

```
oakcli show db_config_params -detail
Available DB configuration files are:
  Default
  DATABASE_BLOCK_SIZE      => 8192
  DATABASE_LANGUAGE        => AMERICAN
  DATABASE_CHARACTERSET    => AL32UTF8
  DATABASE_TERRITORY       => AMERICA
  COMPONENT_LANGUAGES     => en
```

10.23.8 oakcli show dbhomes

Use the `oakcli show dbhomes` command to display information about each existing Oracle database home, including home name, home location, and database version.

Syntax

```
oakcli show dbhomes [-detail] [-h]
```

Parameters

Parameter	Description
<code>-detail</code>	(Optional) Include a list of databases associated with each home.
<code>-h</code>	(Optional) Display help for using the command.

Usage Notes

On Oracle Database Appliance, the minimum supported Oracle Database release is 11.2.0.4. Oracle Database 11.2.0.3.x is not supported.

Example 10-35 Displaying DB Home Details

```
# oakcli show dbhomes
```

Oracle Home Name	Oracle Home version	Home Location
OraDb12102_home1	12.1.0.2.160719(23054246,23054327)	/u01/app/oracle/product/12.1.0.2/dbhome_1

Example 10-36 Displaying DB Home Details

```
oakcli show dbhomes -detail
```

Oracle HomeName	Oracle Home Version	Oracle HomeLocation	Database Name	Database Type
OraDb11204_home1	11.2.0.4.8(21352635,21352649)	/u01/app/oracle/product/11.2.0.4/dbhome_1	no DB	available
OraDb12102_home1	12.1.0.2.5(21359755,21359758)	/u01/app/oracle/product/12.1.0.2/dbhome_1	one43	RACOneNode
OraDb12102_home1	12.1.0.2.5(21359755,21359758)	/u01/app/oracle/product/12.1.0.2/dbhome_1	ee120	SINGLE
OraDb12102_home1	12.1.0.2.5(21359755,21359758)	/u01/app/oracle/product/12.1.0.2/dbhome_1	one311	RACOneNode
OraDb12102_home1	12.1.0.2.5(21359755,21359758)	/u01/app/oracle/product/12.1.0.2/dbhome_1	ee311	SINGLE
OraDb12102_home1	12.1.0.2.5(21359755,21359758)	/u01/app/oracle/product/12.1.0.2/dbhome_1	rac311	RAC
OraDb12102_home1	12.1.0.2.5(21359755,21359758)	/u01/app/oracle/product/12.1.0.2/dbhome_1	ee43	SINGLE
OraDb12102_home1	12.1.0.2.5(21359755,21359758)	/u01/app/oracle/product/12.1.0.2/dbhome_1	one120	RACOneNode
OraDb12102_home1	12.1.0.2.5(21359755,21359758)	/u01/app/oracle/product/12.1.0.2/dbhome_1	odacn	RAC
OraDb12102_home1	12.1.0.2.5(21359755,21359758)	/u01/app/oracle/product/12.1.0.2/dbhome_1	rac43	RAC
OraDb12102_home1	12.1.0.2.5(21359755,21359758)	/u01/app/oracle/product/12.1.0.2/dbhome_1	rac120	RAC

10.23.9 oakcli show dbstorage

Use the `oakcli show dbstorage` command to display database storage information for databases created on Oracle Automatic Storage Management Cluster File System (Oracle ACFS).

All non-cdb databases are listed together, because they share a common set of volumes. Each CDB database is listed separately.

Syntax

```
oakcli show dbstorage [-db ][-h]db_name
```

Parameters

Parameter	Description
-db <i>dbname</i>	(Optional) Display the name of the database for the storage information.
-h	(Optional) Display help for using the command.

Oracle Database Appliance X5-2 with a Storage Expansion Shelf and Non-CDB Databases

Here is an example of the `oakcli show dbstorage` command output for an Oracle Database Appliance plus the storage expansion shelf. The output includes only non-CDB databases. Half of the available disk group storage is allocated to Oracle ACFS,

except for the FLASH disk group. In the FLASH disk group, all storage is allocated to Oracle ACFS.

```
# oakcli show dbstorage
```

```
All the DBs with DB TYPE as non-CDB share the same volumes
```

DB_NAMES	DB_TYPE	Filesystem	Size	Used	Available	AutoExtend	Size	DiskGroup
db1, db2, db3, db4	non-CDB	/u01/app/oracle/oradata/datastore	62G	27.26G	34.74G	6G		REDO
		/u02/app/oracle/oradata/datastore	3730G	7.86G	3722.14G	373G		DATA
		/u02/app/oracle/oradata/flashdata	558G	205.25G	352.75G	55G		FLASH
		/u01/app/oracle/fast_recovery_area/datastore	4958G	21.05G	4936.95G	495G		RECO

Oracle Database Appliance X3-2 or X4-2 with a Storage Expansion Shelf

Here is an example of the `oakcli show dbstorage` command output for an Oracle Database Appliance plus the storage expansion shelf. The output includes both CDB and non-CDB databases. The **Available** heading shows the available AFCS storage, which can be auto-extended. Half of the available disk group storage is allocated to Oracle ACFS, except for the FLASH disk group. In the FLASH disk group, all storage is allocated to Oracle ACFS.

```
# oakcli show dbstorage
```

```
All the DBs with DB TYPE as non-CDB share the same volumes
```

DB_NAMES	DB_TYPE	Filesystem	Size	Used	Available	AutoExtend	Size	DiskGroup
odacn	CDB	/u01/app/oracle/oradata/rdoacn	5G	3.15G	1.85G	1G		REDO
		/u02/app/oracle/oradata/datodacn	100G	3.86G	96.14G	10G		DATA
		/u01/app/oracle/fast_recovery_area/rcodacn	132G	0.92G	131.08G	13G		RECO
rac120, rac401, rac408	non-CDB	/u01/app/oracle/oradata/datastore	60G	11.30G	48.70G	5G		REDO
		/u02/app/oracle/oradata/datastore	1027G	5.77G	1021.23G	102G		DATA
		/u01/app/oracle/fast_recovery_area/datastore	1336G	7.27G	1328.73G	133G		RECO
cdbracon	CDB	/u01/app/oracle/oradata/rdocdracon	6G	4.15G	1.85G	1G		REDO
		/u02/app/oracle/oradata/datcdbracon	100G	4.05G	95.95G	10G		DATA
		/u01/app/oracle/fast_recovery_area/rcodbracon	132G	0.79G	131.21G	13G		RECO

10.23.10 oakcli show disk

Use the `oakcli show disk` command to display disk information.

Syntax

```
oakcli show disk [-shared | -local | -shared_disk_name] [-asm [-all]] [-h]
```

Parameters

Parameter	Description
<code>-local</code>	(Optional) Display information for all of the local disks.
<code>-shared</code>	(Optional) Display information for all of the shared disks.
<code>-shared_disk_name</code>	(Optional) Display information for only the specified shared disk.
<code>-asm</code>	(Optional) Displays information for an assembly.
<code>-all</code>	(Optional) Display complete details of the selected disk or disks.
<code>-h</code>	(Optional) Display help for using the command.

Usage Notes

- Running the command with no parameters is identical to running the `oakcli show disk -shared` command.
- The `-all` parameter produces valid output only when used with the `shared_disk_name` parameter. All other parameters are optional and cannot be combined with other parameters.

Example 10-37 Displaying Information About the Local Disks

```
oakcli show disk -local
```

Example 10-38 Displaying Information About the Shared Disks

```
oakcli show disk -shared
```

Example 10-39 Displaying Information About a Specific Shared Disk

Display information about the shared disk named `pd_01`:

```
oakcli show disk -shared pd_01
```

10.23.11 oakcli show diskgroup

Use the `oakcli show diskgroup` command to display Oracle Automatic Storage Management (Oracle ASM) disk group information.

Syntax

```
oakcli show diskgroup [disk_group_name][-h]
```

Parameters

Parameter	Description
<i>disk_group_name</i>	(Optional) The name of an Oracle ASM disk group for which complete details should be displayed. If you do not specify this parameter, then information for all of the Oracle ASM disk groups is displayed.
-h	(Optional) Display help for using the command.

10.23.12 oakcli show enclosure

Use the `oakcli show enclosure` command to display information about the storage enclosure subsystem on the node where the command is executed.

Syntax

```
oakcli show enclosure [-h]
```

Parameter

-h displays help for using the command.

10.23.13 oakcli show env_hw

Use the `oakcli show env_hw` command to display the environment type and hardware version of the current node.

Syntax

```
oakcli show env_hw [-h]
```

Parameter

(Optional) `-h` displays help for using the command.

Displaying the Environment and Hardware for a Virtualized Platform

Show the environment type and hardware model when logged in to ODA_BASE on Oracle Database Appliance Virtualized Platform:

```
oakcli show env_hw
VM-ODA_BASE ODA X7-2
```

10.23.14 oakcli show expander

Use the `oakcli show expander` command to display information about a SAS expander.

Syntax

```
oakcli show expander [expander_id] [-h]
```

Parameter

Parameter	Description
<i>expander_id</i>	(Optional) Identifies the specific SAS expander
<code>-h</code>	(Optional) Display help for using the command.

10.23.15 oakcli show ib

Use the `oakcli show ib` command to display InfiniBand card and port information if InfiniBand exists in the system.

Syntax

```
oakcli show ib [-h]
```

Parameter

(Optional) `-h` displays help for using the command.

10.23.16 oakcli show ismaster

Use the `oakcli show ismaster` command to determine which node is the master node.

File Path

```
$ORACLE_HOME/opt/oracle/oak/bin/oakcli
```

Syntax

```
oakcli show ismaster [-h]
```

Parameters

Parameter	Description
-h	(Optional) Display help for using the command.

Example 10-40 Determining Which Node is the Master Node

```
# oakcli show ismaster
```

10.23.17 oakcli show fs

Use the `oakcli show fs` command to display all database and cloudfs file systems created on ASM Cluster File System (ACFS) in addition to the local file systems on the Oracle Database Appliance node.

Syntax

```
oakcli show fs [-h]
```

Parameter

(Optional) `-h` displays help for using the command.

10.23.18 oakcli show iraid

Use the `oakcli show iraid` command to display internal RAID and local disk information.

This command is only available on X5-2 systems and later.

Syntax

```
oakcli show iraid [-h]
```

Parameter

(Optional) `-h` displays help for using the command.

10.23.19 oakcli show memory

Use the `oakcli show memory` command to display information about memory modules.

Syntax

```
oakcli show memory [-h]
```

Parameter

(Optional) `-h` displays help for using the command.

10.23.20 oakcli show network

Use the `oakcli show network` command to display information about the network subsystem.

Syntax

```
oakcli show network
```

Parameter

(Optional) `-h` displays help for using the command.

10.23.21 oakcli show power

Use the `oakcli show power` command to display information about the power supply subsystem.

Syntax

```
oakcli show power [-h]
```

Parameter

(Optional) `-h` displays help for using the command.

Example 10-41 Displaying Power Supply Information

Display the power supply information of the node where the command is executed:

```
# oakcli show power
```

NAME	HEALTH	HEALTH_DETAILS	PART_NO.	SERIAL_NO.	LOCATION
INPUT_POWER	OUTPUT_POWER	INLET_TEMP		EXHAUST_TEMP	
Power_Supply_0	OK	-	7047410	476856F+1242CE0020	PS0
Present	113 watts	33.250 degree C		36.688 degree C	
Power_Supply_1	OK	-	7047410	476856F+1242CE004J	PS1
Present	89 watts	37.000 degree C		39.438 degree C	

10.23.22 oakcli show processor

Use the `oakcli show processor` command to display information about CPU processors.

Syntax

```
oakcli show processor [-h]
```

Parameter

(Optional) `-h` displays help for using the command.

Displaying CPU Processor Information

Display the CPU processor information of the node where the command is executed:

```
oakcli show processor
      NAME HEALTH HEALTH_DETAILS PART_NO. LOCATION
MODEL                                MAX_CLK_SPEED TOTAL_CORES ENABLED_CORES

      CPU_0 OK      -                060D      P0 (CPU 0)
Intel(R) Xeon(R) CPU E5-2690  2.900 GHZ      8          8
      CPU_1 OK      -                060D      P1 (CPU 1)
Intel(R) Xeon(R) CPU E5-2690  2.900 GHZ      8          8
```

10.23.23 oakcli show raidsyncstatus

Use the `oakcli show raidsyncstatus` command to display the status of the RAID rebuild after a failed local disk is replaced.

Note:

The `show raidsyncstatus` command is only supported on a bare metal platform; it is not supported on the virtualized platform. For general RAID information, use the `oakcli show iraid` command.

Syntax

```
oakcli show raidsyncstatus [-h]
```

Parameter

(Optional) `-h` displays help for using the command.

10.23.24 oakcli show repo

Use the `oakcli show repo` command to display information about virtual machine repositories.

Syntax

```
oakcli show repo [reponame -node 0|1] [-h]
```

Parameters

Parameter	Description
<i>reponame</i>	[Optional] Identifies a specific repository name
<i>-node</i>	[Optional] Identifies the node number 0 or 1
<i>-h</i>	[Optional] Display help for using the command.

To see all repositories, omit the repository name and node number. To see a specific shared repository, include the repository name and node.

Examples

Here are examples of how to use the `oakcli show repo` command.

Example 10-42 Displaying the Available Virtual Machine Repositories

Display the virtual machine repositories on Oracle Database Appliance Virtualized Platform nodes:

```
oakcli show repo
      NAME      REPOTYPE  NODENUM
  odarepo1    local      0
  odarepo2    local      1
  repo1       shared     0
  repo1       shared     1
```

Example 10-43 Displaying Details About a Specific Shared Repository

Display information about the repository named `repo1` on Node 1:

```
oakcli show repo repo1 -node 1

Resource: repo1_1
  AutoStart      :      restore
  DG              :      DATA
  Device         :      /dev/asm/repo1-286
  ExpectedState  :      Online
  MountPoint     :      /u01/app/repo1
  Name           :      repo1_0
  Node           :      all
  RepoType       :      shared
  Size           :      102400
  State          :      Online
```

10.23.25 oakcli show server

Use the `oakcli show server` command to display information about the server subsystem.

Syntax

```
oakcli show server [-h]
```

Parameter

(Optional) `-h` displays help for using the command.

10.23.26 oakcli show storage

Use the `oakcli show storage` command to display information about the storage for controllers, expanders, and disks.

Syntax

```
oakcli show storage -errors [-h]
```

Parameters

Parameter	Description
<code>-errors</code>	Display detailed information about reported errors.
<code>-h</code>	(Optional) Display help for using the command.

10.23.27 oakcli show validation storage

Use the `oakcli show validation storage` command to show whether validation storage is enabled or disabled.

Syntax

```
oakcli show validation storage [-h]
```

Parameter

(Optional) `-h` displays help for using the command.

Example 10-44 Determining if Storage Validation is Enabled

```
# oakcli show validation storage  
Enabled
```

10.23.28 oakcli show validation storage errors

Use the `oakcli show validation storage errors` command to show hard storage errors.

Hard errors include having the wrong type of disk inserted into a particular slot, an invalid disk model, or an incorrect disk size.

Syntax

```
oakcli show validation storage errors [-h]
```

Parameter

(Optional) `-h` displays help for using the command.

10.23.29 oakcli show validation storage failures

Use the `oakcli show validation storage failures` command to show soft validation errors. A typical soft disk error would be an invalid version of the disk firmware.

Syntax

```
oakcli show validation storage failures [-h]
```

Parameter

(Optional) `-h` displays help for using the command.

10.23.30 oakcli show vdisk

Use the `oakcli show vdisk` command to display information about virtual disks on Oracle Database Appliance Virtualized Platform.

Syntax

```
oakcli show vdisk [vdisk_name -repo repository_name] [-h]
```

Parameters

Parameter	Description
<code>vdisk_name</code>	(Optional) Display information for just one virtual disk.
<code>-repo repository_name</code>	Required parameter if a virtual disk is specified in the command
<code>-h</code>	(Optional) Display help for using the command.

Examples

Here are examples of how to use the `oakcli show vdisk` command.

Example 10-45 Displaying Information for All Virtual Disks

Display information about all virtual disks on Oracle Database Appliance Virtualized Platform:

```
# oakcli show vdisk
```

NAME	SIZE	TYPE	REPOSITORY
myvdisk	10G	local	vdiskrepo
newv	1G	local	vdiskrepo

Example 10-46 Displaying Information for a Single Virtual Disk

Display information for the virtual disk named `myvdisk1`:

```
# oakcli show vdisk myvdisk1
Resource: myvdisk_vdiskrepo
  Name       : myvdisk_vdiskrepo
  RepoName   : vdiskrepo
  Size       : 10G
  Type       : local
  VmAttached : 0
```

10.23.31 oakcli show version

Use the `oakcli show version` command to display the applied patch versions for Oracle Database Appliance software and firmware.

Syntax

```
oakcli show version [-detail] [-h]
```

Parameter	Description
-detail	(Optional) Display detailed version information.
-h	(Optional) Display help for using the command.

Usage Notes

When you apply the patch and then run the command `oakcli show version -detail`, the output shows the installed version and that the supported versions are `Up-to-date` for each component. If you unpack the patch bundle (`oakcli unpack -pack`) and then run the command `oakcli show version -detail` before applying the patch, the output shows `No-update` in the Supported Version column.

Note:

After unpacking the patch bundle, but before applying the patch, use the `oakcli update -patch version --verify` command to verify the contents of the patch instead of issuing `oakcli show version -detail`.

Displaying the Oracle Database Appliance Version

This is an example of how to determine if all of the components are successfully updated after applying the 12.1.2.10.0 patch. You can also view the applied patch version information for the software and firmware on Oracle Database Appliance. All components are successfully updated when `Up-to-date` appears in the Supported Version column.

```
# oakcli show version -detail

Mon Feb 13 03:31:48 PST 2017
Reading the metadata. It takes a while...
System Version  Component Name           Installed Version           Supported Version
-----
12.1.2.10.0

Controller_INT           4.230.40-3739              Up-to-date
Controller_EXT           09.00.00.00                Up-to-date
Expander                  0291                        Up-to-date
SSD_SHARED {
  [ c2d20,c2d21,c2d22,    A29A                        Up-to-date
  c2d23 ]
  [ c2d0,c2d1,c2d2,c2d   A29A                        Up-to-date
  3,c2d4,c2d5,c2d6,c2d
```

```

7,c2d8,c2d9,c2d10,c2
d11,c2d12,c2d13,c2d1
4,c2d15,c2d16,c2d17,
c2d18,c2d19 ]
}

SSD_LOCAL          0R3Q          Up-to-date
ILOM                3.2.8.24 r114611 Up-to-date
BIOS                38070000       Up-to-date
IPMI                1.8.12.4       Up-to-date
HMP                 2.3.5.2.8      Up-to-date
OAK                 12.1.2.10.0    Up-to-date
OL                  6.8            Up-to-date
GI_HOME             12.1.0.2.170117(2473
                    2082,24828633) Up-to-date
DB_HOME             12.1.0.2.170117(2473
                    2082,24828633) Up-to-date

```

Related Topics

- [oakcli update](#) (page 10-75)
Use the `oakcli update` command to apply Oracle Database Appliance patches.

10.23.32 oakcli show vlan

Use the `oakcli show vlan` command to display information about virtual local area networks (VLANs) configured on Oracle Database Appliance.

Syntax

```
oakcli show vlan [-h]
```

Parameter

(Optional) `-h` displays help for using the command.

Example 10-47 Displaying Details of Available Virtual Area Networks (VLANs)

Display the names, tag ID numbers, networks, and node assignments for the available virtual local area networks:

```
oakcli show vlan
```

	NAME	ID	INTERFACE	NODENUM
	net1	1	bond1	0
	net1	1	bond1	1
	net2	1	bond2	0
	net2	1	bond2	1
	net3	1	bond3	0
	net3	1	bond3	1
	net4	1	xbond0	0
	net4	1	xbond0	1

```

privl          1    bond0    0
privl          1    bond0    1

```

10.23.33 oakcli show vm

Use the `oakcli show vm` command to display information about virtual machines.

Syntax

```
oakcli show vm [vm_name | -h]
```

Parameters

Parameter	Description
<code>vm_name</code>	(Optional) The name of the virtual machine for which details should be displayed. If you do not specify this parameter, then information for all the virtual machines is displayed.
<code>-h</code>	(Optional) Display help for using the command.

Usage Notes

When a virtual machine is configured in driver domain mode, the output of the `oakcli show vm vmname` command displays TRUE for the DriverDomain attribute.

Examples

Here are examples of how to use the `oakcli show vm` command.

Example 10-48 Displaying Details for All Virtual Machines

Display the virtual machine names, memory and vCPU allocations, status, virtual disks, and repository name for all virtual machines:

```
# oakcli show vm
```

NAME	MEMORY	VCPU	STATE	REPOSITORY
sample5_odarepo1	2048	2	OFFLINE	odarepo1
sample6_odarepo1	2048	2	OFFLINE	odarepo2
test1_odarepo1	2048	2	OFFLINE	odarepo1
test2_odarepo2	2048	2	OFFLINE	odarepo2
vm1_odarepo1	4096	4	ONLINE	odarepo1
vm2_odarepo2	2048	2	OFFLINE	odarepo2
win_vm1	1500	1	ONLINE	odarepo1

Example 10-49 Displaying Information for a Single Virtual Machine

Display information about the `vm1_odarepo1` virtual machine:

```
oakcli show vm vm1_odarepo1
Resource: vm1_odarepo1
  AutoStart      :      restore
  CPUPriority    :      100
  Disks          :      |file:/OVS/Repositories/odarepo1/Vi
                    |rtualMachines/vm1_odarepo1/System.i
                    |mg,xvda,w||file:/OVS/Repositories/o
                    |darepo1/VirtualMachines/vm1_odarepo
                    |1/u01.img,xvdb,w|
```

```

Domain          : XEN_PVM
ExpectedState   : online
FailOver        : false
IsSharedRepo    : false
Keyboard        : en-us
MaxMemory       : 3000
MaxVcpu         : 4
Memory          : 4096
Mouse           : OS_DEFAULT
Name            : vml_odarepol
Networks        : |mac=00:21:F6:00:00:E4|
NodeNum         : 0
NodeNumStart    :
OS              : OL_5
PrivateIP       : None
ProcessorCap    : 100
RepoName        : odarepol
State           : Online
TemplateName    : otml_sample1_odarepol
Vcpu            : 4
cpupool         : twocpu
vncport         : 5901

```

10.23.34 oakcli show vmconsole

Use the `oakcli show vmconsole` command to open a GUI virtual machine console to manage a specific virtual machine.

Syntax

```
oakcli show vmconsole vm_name [-h]
```

Parameters

Parameter	Description
<i>vm_name</i>	Name of the virtual machine for which you want to open a console.
-h	(Optional) Display help for using the command.

Example 10-50 Opening a Virtual Machine Console

Open a console for the virtual machine named `vml_odarepol`:

```
oakcli show vmconsole vml_odarepol
```

10.23.35 oakcli show vmtemplate

Use the `oakcli show vmtemplate` command to display information about virtual machine templates.

Syntax

```
oakcli show vmtemplate [vmtemplate_name | -h]
```

Parameters

Parameter	Description
<i>vmtemplate_name</i>	(Optional) The name of the virtual template for which details should be displayed. If you do not specify this parameter, then information for all of the virtual templates is displayed.
-h	(Optional) Display help for using the command.

Example 10-51 Display Information About a Virtual Template

Display information about the `sample1_odarepol` virtual template:

```
oakcli show vmtemplate sample_odarepol
Resource: sample1_odarepol
      CPUPriority      :      100
      Disks             :      |file:/OVS/Repositories/odarepol/Te
                           mplates/otml_sample1_odarepol/Syste
                           m.img,xvda,w|file:/OVS/Repositorie
                           s/odarepol/Templates/otml_sample1_o
                           darepol/u01.img,xvdb,w|
      Domain           :      XEN_PVM
      Keyboard         :      en-us
      MaxMemory        :      2048
      MaxVcpu          :      2
      Memory           :      2048
      Mouse            :      OS_DEFAULT
      Name              :      sample1_odarepol
      Networks         :      |bridge=priv1||bridge=net1||bridge=
                           net2|
      NodeNum          :      0
      OS                :      OL_5
      ProcessorCap     :      100
      RepoName         :      odarepol
      Vcpu             :      2
```

10.24 oakcli start commands

Use the `oakcli start` commands to start a virtual machine, to start a shared repository on a node, or to start ODA_BASE on the local node.

- [oakcli start oda_base](#) (page 10-71)
Use the `oakcli start oda_base` command to start ODA_BASE on the local node.
- [oakcli start repo](#) (page 10-72)
Use the `oakcli start repo` command to start a shared repository on a node.
- [oakcli start vm](#) (page 10-72)
Use the `oakcli start vm` command to start a virtual machine on a node.

10.24.1 oakcli start oda_base

Use the `oakcli start oda_base` command to start ODA_BASE on the local node.

Syntax

```
oakcli start oda_base [-h]
```

Parameter

(Optional) `-h` displays help for using the command.

Example 10-52 Starting ODA_BASE on the Local Node

Connect to Dom0 on the desired node and enter the following command to start ODA_BASE on that node:

```
oakcli start oda_base
```

10.24.2 oakcli start repo

Use the `oakcli start repo` command to start a shared repository on a node.

Syntax

```
oakcli start repo repo_name [-node node_number] [-h]
```

Parameters

Parameter	Description
<i>repo_name</i>	<i>repo_name</i> is the name of the shared repository to be started.
<code>-node <i>node_number</i></code>	Specifies the node on which to start the shared repository. <i>node_number</i> is the number of the node where it is to be started, either 0 or 1. If <code>-node</code> is not specified, the shared repository is started on both nodes.
<code>-h</code>	(Optional) Displays help for using the command.

Example 10-53 Starting a Shared Repository on Node 0

Start the shared repository named `repo1` on Node 0:

```
oakcli start repo repo1 -node 0
```

10.24.3 oakcli start vm

Use the `oakcli start vm` command to start a virtual machine on a node.

Syntax

```
oakcli start vm vm_name [-node node_number] [-d] [-h]
```

Parameters

Parameter	Description
<i>vm_name</i>	<i>vm_name</i> is the name of the virtual machine to be started.
<code>-node <i>node_number</i></code>	Specifies the node on which to start the virtual machine. <i>node_number</i> is the number of the node where it is to be started, either 0 or 1. If <code>-node</code> is not specified, a virtual machine is started on both nodes.
<code>-d</code>	Provides details about the virtual machine starting procedure
<code>-h</code>	(Optional) Display help for using the command.

Example 10-54 Starting a Virtual Machine on Node 0

Start the virtual machine named `vm1_odarepo1` on Node 0.

```
oakcli start vm vm_odarepo1 -node 0
```

10.25 oakcli stop command

Use the `oakcli stop` command to stop a virtual machine, to stop a shared repository on a node, or to stop ODA_BASE on the local node.

Syntax

```
oakcli stop [vm vm_name [-force] | repo repo_name [-node node_number] | oda_base ] [-h]
```

Parameters

Parameter	Description
<code>vm <i>vm_name</i></code>	<i>vm_name</i> is the name of the virtual machine to be stopped.
<code>-force</code>	(Optional) forces the virtual machine to stop.
<code>repo <i>repo_name</i></code>	<i>repo_name</i> is the name of the shared repository to be stopped.
<code>-node <i>node_number</i></code>	<i>node_number</i> is the number of the node where the shared repository is to be stopped, either 0 or 1. The <code>-node</code> parameter is only valid when stopping a virtual machine on a shared repository. If <code>-node</code> is not specified, the shared repository is stopped on both nodes.
<code>oda_base</code>	Stops ODA_BASE on the local node
<code>-h</code>	(Optional) Displays help for using the command.

Examples

Here are examples of how to use the `oakcli stop` command.

Example 10-55 Forcing a Virtual Machine to Stop

Force the virtual machine named `vm1_odarepo1` to stop:

```
oakcli stop vm vm_odarepo1 -force
```

Example 10-56 Stopping a Shared Repository

Stop the shared repository named `repo1` on Node 0:

```
oakcli stop repo repo1 -node 0
```

Example 10-57 Stopping the Local ODA_Base

Connect to Dom0 on the desired node and enter the following command to stop ODA_BASE on that node:

```
oakcli stop oda_base
```

10.26 oakcli stordiag

Use the `oakcli stordiag` command to run diagnostic tests on a disk in the storage shelf or storage expansion shelf.

The tool produces a list of 14 disk checks for each node.

Syntax

```
oakcli stordiag resource_type [n] [-h]
```

Parameters

Parameter	Description
<code>resource_type</code>	Prefix that depends on the configuration. See "Usage Notes."
<code>n</code>	(Optional) Disk number (starting with 0 and increasing to one less than the number of disks)
<code>-h</code>	(Optional) Display help for using the command.

Usage Notes

Select the value for `resource_type` based from one of the following options:

- On Oracle Database Appliance Version 1, use `d`.
- On Oracle Database Appliance with a single storage shelf, use `pd_`.
- On Oracle Database Appliance with an expansion storage shelf, use `e0_pd_` for a disk in the storage shelf and use `e1_pd_` for a disk in the expansion storage shelf.

For Oracle Database Appliance systems that have internal storage, use the format `d[.]` to identify the disk to be diagnosed. For Oracle Database Appliance systems that have connected a storage shelf (and optional storage expansion shelf), use the format `e[0..1] pd_[0..23]` to identify the disk to be diagnosed.

Example 10-58 Running Diagnostic Tests on a Disk in the Expansion Storage Shelf

Runs the diagnostic tests on disk 3 in the expansion storage shelf:

```
# oakcli stordiag e1_pd_3
Node Name : hr0
Test : Diagnostic Test Description

  1 : OAK Check
      NAME          PATH          TYPE          STATE          STATE_DETAILS
      pd_03         /dev/sdw      HDD           ONLINE         Good

  2 : ASM Check
  . . .
<output truncated>
```

10.27 oakcli test asr

Use the `oakcli test asr` command to send a test trap to determine if Oracle Auto Service Request (Oracle ASR) is configured and working correctly.

The command returns a success message if Oracle ASR is functioning properly.

Syntax

```
oakcli test asr [-h]
```

Parameter

(Optional) `-h` displays help for using the command.

Usage Notes

Run the command on both nodes. The Oracle ASR logs are always on the node where the ASR Manager is installed, which is the master node.

10.28 oakcli unpack

Use the `oakcli unpack` command to unpack packages into the Oracle Appliance Manager repository.

Syntax

```
oakcli unpack -package absolute_package_name
```

Parameters

Parameters	Description
<i>absolute_package_name</i>	Identifies the package to be unpacked using the package's full absolute path and file name
<code>-h</code>	(Optional) Display help for using the command.

Example 10-59 Unpacking Packages into the Oracle Appliance Manager Repository

Unpack the `p13982331_23000_Linux-86-62.zip` package, which was previously copied to `/tmp` on the current node, into the node's Oracle Appliance Manager command-line interface repository:

```
oakcli unpack -package /tmp/p13982331_23000_Linux-86-62.zip
```

10.29 oakcli update

Use the `oakcli update` command to apply Oracle Database Appliance patches.

You can apply patches using the patch bundle and use the `--local` patching option to patch components one node at a time without impacting the other node. This reduces the downtime when applying the patch.

 **Note:**

If you want to update only the Oracle Database software, use the `oakcli upgrade` command.

Syntax

```
oakcli update -patch version [--server | --storage | --database] [--local] [--noreboot] | [--clean] | [--verify][-h]
```

Parameters

Parameter	Description
<code>- patch version</code>	Patch version that you want to install. For example: 12.2.1.3.0.
<code>--server</code>	Contains the patches previously obtained in earlier releases from the Infrastructure (infra) and Grid Infrastructure (gi) patch updates.
<code>--storage</code>	Contains only patches for shared storage components.
<code>--database</code>	(Optional) Patches Oracle database homes.
<code>--local</code>	Patches the component only on the local node on bare metal deployments. By default, this is set to false.
<code>--noreboot</code>	(Optional) Node is not rebooted after patching.
<code>--clean</code>	(Optional) Cleans up all temporary files on the local node.
<code>--verify</code>	(Optional) Lists the patchable components on the node.
<code>-h</code>	(Optional) Display help for using the command.

Usage Notes

After unpacking the patch bundle, but before applying the patch, verify the contents of the patch for the release.

 **Note:**

When patching a virtualized platform, the `--local` option is not supported.

Example 10-60 Verify the Contents of a Patch Bundle

Display the installed version and the version available in the 12.2.1.3.0 release patch bundle for each of the components on the node. When the latest supported version is installed, `Up-to-date` appears in the Proposed column.

```
# oakcli update -patch 12.2.1.3.0 --verify
```

```
INFO: 2017-02-13 14:20:37: Reading the metadata file now...
```

Patch Version	Component Name	Installed Version	Proposed
	Controller_INT	4.230.40-3739	Up-to-date
	Controller_EXT	09.00.00.00	10.00.00.00
	Expander	0291	Up-to-date
	SSD_SHARED {		

[c2d20,c2d21,c2d22, c2d23]	A29A	Up-to-date
[c2d0,c2d1,c2d2,c2d 3,c2d4,c2d5,c2d6,c2d 7,c2d8,c2d9,c2d10,c2 d11,c2d12,c2d13,c2d1 4,c2d15,c2d16,c2d17, c2d18,c2d19]	A29A	Up-to-date
SSD_LOCAL	0R3Q	Up-to-date
ILOM	3.2.7.26.a r112632	3.2.8.24 r114611
BIOS	38050100	38070000
IPMI	1.8.12.4	Up-to-date
HMP	2.3.5.2.5	2.3.5.2.8
OAK	12.2.1.2	12.2.1.3.0
OL	6.8	Up-to-date
GI_HOME	12.1.0.2.161018(2400 6101,23854735)	12.1.0.2.170117(2473 2082,24828633)
DB_HOME	12.1.0.2.160719(2305 4246,23054327)	12.1.0.2.170117(2473 2082,24828633)
ASR	5.5.1	Up-to-date

oakcli update -patch Command Examples

Update the appliance with the 12.2.1.3.0 patch:

```
oakcli update -patch 12.2.1.3.0
```

Patch the server on the current node with the 12.2.1.3.0 patch:

```
oakcli update -patch 12.2.1.3.0 --server --local
```

Patch the grid home only on the local node:

```
oakcli update -patch 12.2.1.3.0 --storage --local
```

Patch the Oracle Database homes on both nodes:

```
oakcli update -patch 12.2.1.3.0 --database
```

10.30 oakcli update-cpucore

Use the `oakcli update-cpucore` command to enable a specified number of licensed CPU cores for Oracle Database Appliance.

Prerequisites

If all cores are not enabled, you can enable multiples of 2 licensed CPU cores up to the maximum number of cores.

File Path

```
$ORACLE_HOME/opt/oracle/oak/bin/oakcli
```

Syntax

```
oakcli update-cpucore -cores number of cores per server [-h]
```

Parameters

Parameter	Description
-cores	Defines the number of cores to enable per server, in multiples of 2. To enable all available cores, specify <code>All</code> instead of the number of cores.
-h	(Optional) Display help for using the command.

Usage Notes

- This command applies only to bare metal deployments. It is not available on an Oracle Database Appliance Virtualized Platform.
- The number of licensed cores you enable must be a multiple of 2, up to the maximum number of cores.
- After the initial configuration, you cannot reduce the number of cores. You can purchase additional cores and increase the number of cores, up to the maximum number of cores for the hardware model.

Example 10-61 Enabling 12 CPU Cores for Oracle Database Appliance

The following command enables 12 CPU cores on an Oracle Database Appliance system.

```
oakcli update-cpucore -cores 12
```

```
Please enter the 'root' password:
```

```
Please re-enter the 'root' password:
```

```
Setting up SSH .....Completed
```

```
INFO : Running as root: /usr/bin/ssh -l root 192.0.2.1 /etc/rc.d/rc3.d/S90cpu-core
```

```
INFO : Running as root: /usr/bin/ssh -l root 192.0.2.1 /etc/rc.d/rc3.d/S90cpu-core
```

Example 10-62 Enabling All CPU Cores for Oracle Database Appliance

The following command enables all cores on an Oracle Database Appliance system.

```
oakcli update-cpucore -cores All
```

```
Please enter the 'root' password:
```

```
Please re-enter the 'root' password:
```

```
Setting up SSH .....Completed
```

```
INFO : Running as root: /usr/bin/ssh -l root 192.0.2.1 /etc/rc.d/rc3.d/S90cpu-core
```

```
INFO : Running as root: /usr/bin/ssh -l root 192.0.2.1 /etc/rc.d/rc3.d/S90cpu-core
```

10.31 oakcli upgrade

Use the `oakcli upgrade` command to upgrade the Oracle Database software on Oracle Database Appliance.

For patching Oracle Database Appliance itself, use the `oakcli update` command.

Syntax

```
oakcli upgrade database [-db db_names | -from source_home] -to destination_home
```

Parameters

Parameter	Description
<code>-db db_names</code>	Specifies the name or names (in a comma-delimited list) of the database or databases you want to upgrade
<code>-from source_home</code>	Specifies the current Oracle Database home of the databases you are upgrading
<code>-to destination_home</code>	Specifies the Oracle Database home containing the version to which you want to upgrade the databases
<code>-h</code>	(Optional) Display help for using the command.

Usage Notes

- You must include either a `-db` parameter or a `-from` parameter.
- Running the command with a `-db` parameter upgrades only the named databases, regardless of their current Oracle Database homes. If you include a `-from` parameter in addition to a `-db` parameter, then the command ignores the `-from` parameter. That is, the command upgrades named databases from other homes and ignores the databases in the named home if they are not listed in the `-db` parameter.
- Running the command without a `-db` parameter will upgrade all of the databases in the named Oracle Database home.
- You must always provide a `-to` parameter that names an existing Oracle Database home.

Example

Upgrade an Oracle 11.2.0.3.1 database named `tpcc` from Oracle Database 11.2.0.3.1 to Oracle Database 12.1.0.2 using the Oracle Database home directory

`OraDb12102_home1:`

```
oakcli upgrade database -db tpcc -to OraDb12102_home1
```

10.32 oakcli validate

Validates the state of an Oracle Database Appliance or the viability of an operating system patch.

Syntax

```
oakcli validate [[-v | -l | -h]] | [[-v][-f output_file] [-a | -d | -c checklist][-ver patch_version]]
```

Parameters

Parameter	Description
<code>-v</code>	Display the version of <code>oakValidation</code> .
<code>-l</code>	List the items that can be checked (and their descriptions).
<code>-h</code>	(Optional) Display help for using the command.

Parameter	Description
-v	Show verbose output (must be used with a parameter that generates a validation report).
-f <i>output_file</i>	Send output to a file with a fully qualified file name, <i>output_file</i> , instead of to the screen (stdout).
-a	Run all system checks, including <code>DiskCalibration</code> . Oracle recommends that you use this command to validate system readiness before deployment. Do not run <code>oakcli validate</code> with this option on a busy production system, because the <code>DiskCalibration</code> system check can cause performance issues.
-d	Run only the default checks. The default checks are <code>NetworkComponents</code> , <code>OSDiskStorage</code> , <code>SharedStorage</code> , and <code>SystemComponents</code> . The <code>NetworkComponents</code> validation check is not available on Oracle Database Appliance V1.
-c <i>checklist</i>	Run the validation checks for the items identified in <i>checklist</i> , a comma-delimited list. Use this parameter to check either a single item or subset of items.
-c <i>ospatch</i>	Run the validation checks for the patch version identified in <i>-ver patch_version</i> .
-ver <i>patch_version</i>	Report any reasons for not being able to patch Oracle Database Appliance with the patch named in <i>patch_version</i> .

Listing All Checks and Their Descriptions

```
oakcli validate -l
```

```

Checkname -- Description
=====
*SystemComponents -- Validate system components based on ilom sensor data
readings
*OSDiskStorage -- Validate OS disks and filesystem information
*SharedStorage -- Validate Shared storage and multipathing information
DiskCalibration -- Check disk performance with orion
*NetworkComponents -- Validate public and private network components
*StorageTopology -- Validate external JBOD connectivity
asr -- Validate asr components based on asr config file and ilom sensor
data readings

```

* -- These checks are also performed as part of default checks

Running All Checks

Enter the following command to run all checks:

```
oakcli validate -a
```

Validating Storage Cable Connections

Check the cable connections between the system controllers and the storage shelf, as well as the cable connection to the storage expansion shelf (if one is installed):

```
oakcli validate -c storagetopology
```

Oracle recommends that you run the `oakcli validate -c StorageTopology` command

before deploying the system. This will avoid and prevent problems during deployment due to wrong or missing cable connections. The output shown in the following example reports a successful configuration. If the cabling is not correct, you will see errors in your output.

```
# oakcli validate -c storagetopology
It may take a while. Please wait...
INFO : ODA Topology Verification
INFO : Running on Node0
INFO : Check hardware type
SUCCESS : Type of hardware found : X4-2
INFO : Check for Environment(Bare Metal or Virtual Machine)
SUCCESS : Type of environment found : Virtual Machine(ODA BASE)
SUCCESS : Number of External LSI SAS controller found : 2
INFO : Check for Controllers correct PCIe slot address
SUCCESS : External LSI SAS controller 0 : 00:15.0
SUCCESS : External LSI SAS controller 1 : 00:16.0
INFO : Check if powered on
SUCCESS : 1 : Powered-on
INFO : Check for correct number of EBODS(2 or 4)
SUCCESS : EBOD found : 2
INFO : Check for External Controller 0
SUCCESS : Controller connected to correct ebod number
SUCCESS : Controller port connected to correct ebod port
SUCCESS : Overall Cable check for controller 0
INFO : Check for External Controller 1
SUCCESS : Controller connected to correct ebod number
SUCCESS : Controller port connected to correct ebod port
SUCCESS : Overall Cable check for controller 1
INFO : Check for overall status of cable validation on Node0
SUCCESS : Overall Cable Validation on Node0
INFO : Check Node Identification status
SUCCESS : Node Identification
SUCCESS : Node name based on cable configuration found : NODE0
INFO : Check Nickname
SUCCESS : Nickname set correctly : Oracle Database Appliance - E0
INFO : The details for Storage Topology Validation can also be found in log
file=/opt/oracle/oak/log/<hostname>/storagetopology/
StorageTopology-2014-07-03-08:57:31_7661_15914.log
```

Validating Oracle ASR

Enter the following syntax to validate your Oracle ASR configuration:

```
# oakcli validate -c asr
INFO: oak Asr information and Validations
RESULT: /opt/oracle/oak/conf/asr.conf exist
RESULT: ASR Manager ip:10.139.154.17
RESULT: ASR Manager port:1162
SUCCESS: ASR configuration file validation successfully completed
RESULT: /etc/hosts has entry 141.146.156.46 transport.oracle.com
RESULT: ilom alertmgmt level is set to minor
RESULT: ilom alertmgmt type is set to snmptrap
RESULT: alertmgmt snmp_version is set to 2c
RESULT: alertmgmt community_or_username is set to public
RESULT: alertmgmt destination is set to 10.139.154.17
RESULT: alertmgmt destination_port is set to 1162
SUCCESS: Ilom snmp configuration for asr set correctly
RESULT: notification trap configured to ip:10.139.154.17
RESULT: notification trap configured to port:1162
SUCCESS: Asr notification trap set correctly
```



```
INFO: IP_ADDRESS HOST_NAME SERIAL_NUMBER ASR PROTOCOL SOURCE PRODUCT_NAME
INFO: -----
-----
10.170.79.98 oda-02-c 1130FMW00D Enabled SNMP ILOM SUN FIRE X4370 M2 SERVER
10.170.79.97 oda-01-c 1130FMW00D Enabled SNMP ILOM SUN FIRE X4370 M2 SERVER
INFO: Please use My Oracle Support 'http://support.oracle.com' to view the
activation status.
SUCCESS: asr log level is already set to Fine.
RESULT: Registered with ASR backend.
RESULT: test connection successfully completed.
RESULT: submitted test event for asset:10.139.154.17
RESULT: bundle com.sun.svc.asr.sw is in active state
RESULT: bundle com.sun.svc.asr.sw-frag is in resolved state
RESULT: bundle com.sun.svc.asr.sw-rulesdefinitions is in resolved state
RESULT: bundle com.sun.svc.ServiceActivation is in active state
SUCCESS: ASR diag successfully completed
```

Checking the Viability of a Patch

Use the `oakcli validate ospatch -ver patch_version` command to report any reasons for not being able to patch Oracle Database Appliance with the patch named in *patch_version*. Run this command before you attempt to patch Oracle Database Appliance to determine if it will succeed or if you need to make changes before applying the patch.

```
# oakcli validate -c ospatch -ver 12.1.2.5.0
INFO: Validating the OS patch for the version 12.1.2.5.0
WARNING: 2015-10-10 06:30:32: Patching sub directory /opt/oracle/oak/pkgrepos/
orapkgs/OEL/5.10/Patches/5.10.1 is not existing
INFO: 2015-10-10 06:30:32: May need to unpack the Infra patch bundle for the
version: 12.1.2.5.0
ERROR: 2015-10-10 06:30:32: No OS patch directory found in the repository
```

Validating Hardware System and Network Components

The following command runs system checks to validate hardware system components and Oracle Database Appliance network components:

```
# oakcli validate -c SystemComponents,NetworkComponents
```

11

Validating and Troubleshooting Oracle Database Appliance

This chapter contains information about how to validate changes and troubleshoot Oracle Database Appliance problems.

Topics:

- [Oracle Database Appliance Diagnostics and Validation](#) (page 11-1)
Use `oakcli validate` to check your Oracle Database Appliance configuration, and if necessary, to provide information to Oracle Support Services.
- [Oracle Database Appliance Configuration Error Messages](#) (page 11-5)
If you encounter errors while configuring Oracle Database Appliance, then review the following messages and actions:
- [Preparing Log Files for Oracle Support Services](#) (page 11-7)
If necessary, use the command `oakcli manage diagcollect` to collect diagnostic files to send to Oracle Support Services.
- [Additional Troubleshooting Tools and Commands](#) (page 11-7)
This section describes additional tools and commands for diagnosing and troubleshooting problems with Oracle Database Appliance.
- [Oracle Database Appliance Hardware Monitoring Tool](#) (page 11-9)
The Oracle Database Appliance Hardware Monitoring Tool displays the status of different hardware components in Oracle Database Appliance server nodes.

11.1 Oracle Database Appliance Diagnostics and Validation

Use `oakcli validate` to check your Oracle Database Appliance configuration, and if necessary, to provide information to Oracle Support Services.

The `oakcli validate` command is the Oracle Appliance Manager diagnostic and validation utility to identify and resolve support issues. If you experience problems with Oracle Database Appliance, then use the `oakcli validate` command options to verify that your environment is properly configured, and that best practices are in effect. When placing a service request, also use Oracle Appliance Manager as described in this chapter to prepare the log files to send to Oracle Support Services.

Topics:

- [Oracle Database Appliance Validation Command Overview](#) (page 11-2)
Use the `oakcli validate` command and options to validate the status of Oracle Database Appliance.
- [Examples of OAKCLI Validate Command Checks](#) (page 11-3)
Review these examples to see you can perform validation checks using the `oakcli validate` command and options.

11.1.1 Oracle Database Appliance Validation Command Overview

Use the `oakcli validate` command and options to validate the status of Oracle Database Appliance.

You must run the `oakcli validate` command as the `root` user.

Syntax

The command `oakcli validate` uses the following syntax, where *checklist* is a single check or a comma-delimited list of checks, and *output_file* is the name that you designate for a validation output file:

```
oakcli validate -h
oakcli validate [-V | -l | -h]
oakcli validate [-v] [-f output_file] [-a | -d | -c checklist] [-v patch_version]
```

Parameters

Option	Purpose
-a	Run all system checks, including <code>DiskCalibration</code> . Oracle recommends that you use this command to validate system readiness before deployment. Do not run <code>oakcli validate</code> with this option on a busy production system, because the <code>DiskCalibration</code> system check can cause performance degradation.
-c <i>checklist</i>	Run the validation checks for the items identified in <i>checklist</i> , a comma-delimited list. Use this parameter to check either a single item or subset of items.
-d	Run only the default checks. The default checks are <code>NetworkComponents</code> , <code>OSDiskStorage</code> , <code>SharedStorage</code> , and <code>SystemComponents</code> .
-f <i>output_file</i>	Send output to a file with a fully qualified file name, <i>output_file</i> , instead of to the screen (<code>stdout</code>).
-h	Display the online help.
-l	List the items that can be checked (and their descriptions).
-v	Show verbose output (must be used with a parameter that generates a validation report).
-V	Display the version of <code>oakValidation</code> .
-ver <i>patch_version</i>	Report any reasons for not being able to patch Oracle Database Appliance with the patch named in <i>patch_version</i> .

VALIDATE Options

Command	Purpose
-c <code>asr</code>	Validate Oracle Auto Service Request (Oracle ASR) components based on the Oracle ASR configuration file and Oracle Integrated Lights Out Manager (Oracle ILOM) sensor data.

Command	Purpose
-c DiskCalibration	Preinstallation check for the storage disk performance using <code>/opt/oracle/oak/bin/orion</code> Do not run this check after you have deployed Oracle software on Oracle Database Appliance, because running the <code>DiskCalibration</code> command on a deployed system creates performance issues. Use the default check option (<code>oakcli validate -d</code>) if you do not want to perform a system check for disk calibration.
-c NetworkComponents	Validate public and private network hardware connections.
-c OSDiskStorage	Validate the operating system disks, and file system information.
-c ospatch	Validate that the system can complete an upgrade successfully using the named patch.
-c SharedStorage	Validate shared storage and multipathing information.
-c StorageTopology	Validate the storage shelf connectivity.
-c SystemComponents	Validate system components, based on Oracle ILOM sensor data readings.

11.1.2 Examples of OAKCLI Validate Command Checks

Review these examples to see you can perform validation checks using the `oakcli validate` command and options.

Listing All Checks and Their Descriptions

```
oakcli validate -l

Checkname -- Description
=====
*SystemComponents -- Validate system components based on ilom sensor data
readings
*OSDiskStorage -- Validate OS disks and filesystem information
*SharedStorage -- Validate Shared storage and multipathing information
DiskCalibration -- Check disk performance with orion
*NetworkComponents -- Validate public and private network components
*StorageTopology -- Validate external JBOD connectivity
asr -- Validate asr components based on asr config file and ilom sensor
data readings

* -- These checks are also performed as part of default checks
```

Note:

The `NetworkComponents` validation check is not available on hardware prior to Oracle Database Appliance X3-2.

Running All Checks

Enter the following command to run all checks:

```
oakcli validate -a
```

Validating Storage Cable Connections

Check the cable connections between the system controllers and the storage shelf, as well as the cable connection to the storage expansion shelf (if one is installed):

```
oakcli validate -c storagetopology
```

Oracle recommends that you run the `oakcli validate -c StorageTopology` command before deploying the system. This will avoid and prevent problems during deployment due to wrong or missing cable connections. The output shown in the following example reports a successful configuration. If the cabling is not correct, you will see errors in your output.

```
# oakcli validate -c storagetopology
It may take a while. Please wait...
INFO : ODA Topology Verification
INFO : Running on Node0
INFO : Check hardware type
SUCCESS : Type of hardware found : X4-2
INFO : Check for Environment(Bare Metal or Virtual Machine)
SUCCESS : Type of environment found : Virtual Machine(ODA BASE)
SUCCESS : Number of External LSI SAS controller found : 2
INFO : Check for Controllers correct PCIe slot address
SUCCESS : External LSI SAS controller 0 : 00:15.0
SUCCESS : External LSI SAS controller 1 : 00:16.0
INFO : Check if powered on
SUCCESS : 1 : Powered-on
INFO : Check for correct number of EBODS(2 or 4)
SUCCESS : EBOD found : 2
INFO : Check for External Controller 0
SUCCESS : Controller connected to correct ebod number
SUCCESS : Controller port connected to correct ebod port
SUCCESS : Overall Cable check for controller 0
INFO : Check for External Controller 1
SUCCESS : Controller connected to correct ebod number
SUCCESS : Controller port connected to correct ebod port
SUCCESS : Overall Cable check for controller 1
INFO : Check for overall status of cable validation on Node0
SUCCESS : Overall Cable Validation on Node0
INFO : Check Node Identification status
SUCCESS : Node Identification
SUCCESS : Node name based on cable configuration found : NODE0
INFO : Check Nickname
SUCCESS : Nickname set correctly : Oracle Database Appliance - E0
INFO : The details for Storage Topology Validation can also be found in
log file=/opt/oracle/oak/log/<hostname>/storagetopology/
StorageTopology-2014-07-03-08:57:31_7661_15914.log
```

Validating Oracle ASR

Enter the following syntax to validate your Oracle ASR configuration:

```
# oakcli validate -c asr
INFO: oak Asr information and Validations
RESULT: /opt/oracle/oak/conf/asr.conf exist
RESULT: ASR Manager ip:10.139.154.17
RESULT: ASR Manager port:1162
SUCCESS: ASR configuration file validation successfully completed
RESULT: /etc/hosts has entry 141.146.156.46 transport.oracle.com
RESULT: ilom alertmgmt level is set to minor
```

```

RESULT: ilom alertmgmt type is set to snmptrap
RESULT: alertmgmt snmp_version is set to 2c
RESULT: alertmgmt community_or_username is set to public
RESULT: alertmgmt destination is set to 10.139.154.17
RESULT: alertmgmt destination_port is set to 1162
SUCCESS: Ilom snmp configuration for asr set correctly
RESULT: notification trap configured to ip:10.139.154.17
RESULT: notification trap configured to port:1162
SUCCESS: Asr notification trap set correctly
INFO: IP_ADDRESS HOST_NAME SERIAL_NUMBER ASR PROTOCOL SOURCE PRODUCT_NAME
INFO: -----
10.170.79.98 oda-02-c 1130FMW00D Enabled SNMP ILOM SUN FIRE X4370 M2 SERVER
10.170.79.97 oda-01-c 1130FMW00D Enabled SNMP ILOM SUN FIRE X4370 M2 SERVER
INFO: Please use My Oracle Support 'http://support.oracle.com' to view the
activation status.
SUCCESS: asr log level is already set to Fine.
RESULT: Registered with ASR backend.
RESULT: test connection successfully completed.
RESULT: submitted test event for asset:10.139.154.17
RESULT: bundle com.sun.svc.asr.sw is in active state
RESULT: bundle com.sun.svc.asr.sw-frag is in resolved state
RESULT: bundle com.sun.svc.asr.rulesdefinitions is in resolved state
RESULT: bundle com.sun.svc.ServiceActivation is in active state
SUCCESS: ASR diag successfully completed

```

Checking the Viability of a Patch

Use the `oakcli validate ospatch -ver` command to report any reasons for not being able to patch Oracle Database Appliance with the patch named in `patch_version`. Run this command before you attempt to patch Oracle Database Appliance to determine if it succeeds or if you must make changes before applying the patch.

```

# oakcli validate -c ospatch -ver 12.1.2.5.0
INFO: Validating the OS patch for the version 12.1.2.5.0
WARNING: 2015-10-10 06:30:32: Patching sub directory /opt/oracle/oak/pkgrepos/
orapkgs/OEL/5.10/Patches/5.10.1 is not existing
INFO: 2015-10-10 06:30:32: May need to unpack the Infra patch bundle for the
version: 12.1.2.5.0
ERROR: 2015-10-10 06:30:32: No OS patch directory found in the repository

```

Validating Hardware System and Network Components

The following command runs system checks to validate hardware system components and Oracle Database Appliance network components:

```
# oakcli validate -c SystemComponents,NetworkComponents
```

11.2 Oracle Database Appliance Configuration Error Messages

If you encounter errors while configuring Oracle Database Appliance, then review the following messages and actions:

Error Encountered in Step 11 Validation VIP appears to be up on the network

Cause: This message is most likely to occur when you attempt to redeploy the End-User Bundle without cleaning up a previous deployment. This error occurs because

an existing VIP is configured for the addresses assigned to Oracle Database Appliance.

Action: Run cleanupDeploy.pl on Node 0, and then restart Oracle Appliance Manager.

Error "CRS-4402: The CSS daemon was started in exclusive mode but found an active CSS daemon on node oda2-1, number 1, and is terminating"

Cause: This error occurs when the Oracle Grid Infrastructure CSS daemon attempts to start the node as a standalone cluster node, but during startup discovers that the other cluster node is running, and changes to cluster mode to join the cluster.

Action: Ignore this error.

Installation requires partitioning of your hard drive

Cause: This message occurs on a node if one of the two operating system disks is not installed, but you are attempting to reimage the operating system.

Action: Ensure that both operating system disks are installed and are available.

Machine Check Exception ...This is not a software problem

Cause: There is a hardware system error.

Action: Log in to the Oracle ILOM Remote Console to determine the specific hardware error.

No volume control GStreamer plug-ins and/or devices found

Cause: Operating system plug-ins required for sound cards for the Oracle ILOM remote redirection console are not installed.

Action: Ignore this message. You do not require volume control for the console.

Reboot and select proper boot device or insert boot media in selected boot device and press a key

Cause: One or both operating system disks are not available. This message occurs if you select "Default hard disk" during reimaging the system, but that disk is not available.

Action: Ensure that both operating system disks are installed and are available.

The AoDB Linux installation tree in that directory does not seem to match your boot media

Cause: If you select "Default (use BIOS settings)" as your imaging option, but one or both of the disks is not available, this message occurs on a node if both operating disks are installed, and you choose to reimage the operating system disks.

Action: Ensure that both operating system disks are available for use.

ERROR: Gateway IP is not pingable

Cause: On Windows platforms, the Oracle Appliance Manager configurator uses the echo service on port 7 to contact the gateway. If the echo service is disabled, possibly for security reasons, the ping fails.

Action: Run the native platform ping command. If the ping is successful, then the configurator validation output can be ignored.

ACFS resources failed to start after applying 2.2 INFRA patch

Cause: Oracle Database Appliance operating system upgrade includes upgrade of Oracle Linux to Unbreakable Enterprise Kernel (UEK). Because Oracle Automatic Storage Management Cluster File System (Oracle ACFS) is not supported on all versions of Oracle Linux, a successful upgrade of the operating system may effectively disable Oracle ACFS.

Upgrade to Oracle Database Appliance 2.2 has three options: `-infra`, `-gi`, and `-database`. The `-infra` option includes upgrade from Oracle Linux to UEK. Before the `-infra` upgrade to 2.2, the operating system is Oracle Linux with 11.2.0.2.x Grid Infrastructure. After the `-infra` upgrade, the operating system is UEK and 11.2.0.2.x Oracle ACFS, which is not compatible with UEK.

For example, upgrade to Oracle Linux 2.6.32-300.11.1.el5uek causes `reco.acfsvol.acfs` and `ora.registry.acfs` to temporarily go to an OFFLINE state, because 2.6.32-300.11.1.el5uek does not support Oracle 11.2.0.2.x ACFS. However, when Oracle Grid Infrastructure is upgraded to 11.2.0.3.2, these components are online again.

Action: Upgrade to Oracle Database Appliance 2.2 with the `-gi` option. This version of the software includes Oracle Grid Infrastructure 11.2.0.3.2, which includes Oracle ACFS modules that work with UEK.

For more information, see My Oracle Support note 1369107.1:

<https://support.oracle.com/CSP/main/article?cmd=show&type=NOT&id=1369107.1>

11.3 Preparing Log Files for Oracle Support Services

If necessary, use the command `oakcli manage diagcollect` to collect diagnostic files to send to Oracle Support Services.

If you have a system fault that requires help from Oracle Support Services, then you may need to provide log records to help Oracle support diagnose your issue.

Collect log file information by running the command `oakcli manage diagcollect`. This command consolidates information from log files stored on Oracle Database Appliance into a single log file for use by Oracle Support Services. The location of the file is specified in the command output.

11.4 Additional Troubleshooting Tools and Commands

This section describes additional tools and commands for diagnosing and troubleshooting problems with Oracle Database Appliance.

Although some of these tools are specific to Oracle Database Appliance, others are tools for all clustered systems.

Topics:

- [Oracle Appliance Manager Tools for Configuration Auditing and Disk Diagnosis](#) (page 11-8)
Oracle Appliance Manager provides access to a number of sophisticated monitoring and reporting tools, some of them derived from standalone tools that require their own syntax and command sets.
- [Trace File Analyzer Collector](#) (page 11-8)
Trace File Analyzer (TFA) Collector simplifies diagnostic data collection on Oracle Grid Infrastructure and Oracle Real Application Clusters systems.

11.4.1 Oracle Appliance Manager Tools for Configuration Auditing and Disk Diagnosis

Oracle Appliance Manager provides access to a number of sophisticated monitoring and reporting tools, some of them derived from standalone tools that require their own syntax and command sets.

The following list briefly describes the ORAchk command, and the disk diagnostic tool:

- ORAchk

The ORAchk Configuration Audit Tool audits important configuration settings for Oracle RAC two-node deployments in the following categories:

- Operating system kernel parameters and packages
- RDBMS
- Database parameters, and other database configuration settings
- Oracle Grid Infrastructure, which includes Oracle Clusterware and Oracle Automatic Storage Management

ORAchk is aware of the entire system. It checks the configuration to indicate if best practices are being followed. For example, ORAchk reviews the system and identifies best practice issues that are specific to Oracle Database Appliance when ORAchk is run by Oracle Appliance Manager. To explore ORAchk on Oracle Database Appliance, use the following command:

```
oakcli orachk -h
```

Also review My Oracle Support note 1268927.2, which is available from My Oracle Support.

- Disk Diagnostic Tool

Use the Disk Diagnostic Tool to help identify the cause of disk problems. The tool produces a list of 14 disk checks for each node. To run the tool, enter the following command:

```
# oakcli stordiag resource_type
```



See also:

<https://support.oracle.com/CSP/main/article?cmd=show&type=NOT&id=1268927.2>

11.4.2 Trace File Analyzer Collector

Trace File Analyzer (TFA) Collector simplifies diagnostic data collection on Oracle Grid Infrastructure and Oracle Real Application Clusters systems.

TFA behaves in a similar manner to the ion utility packaged with Oracle Clusterware. Both tools collect and package diagnostic data. However, TFA is much more powerful than ion, because TFA centralizes and automates the collection of diagnostic information.

TFA provides the following key benefits and options:

- Encapsulation of diagnostic data collection for all Oracle Grid Infrastructure and Oracle RAC components on all cluster nodes into a single command, which you run from a single node
- Option to "trim" diagnostic files during data collection to reduce data upload size
- Options to isolate diagnostic data collection to a given time period, and to a particular product component, such as Oracle ASM, RDBMS, or Oracle Clusterware
- Centralization of collected diagnostic output to a single node in Oracle Database Appliance, if desired
- On-Demand Scans of all log and trace files for conditions indicating a problem
- Real-Time Scan Alert Logs for conditions indicating a problem (for example, Database Alert Logs, Oracle ASM Alert Logs, and Oracle Clusterware Alert Logs)

11.5 Oracle Database Appliance Hardware Monitoring Tool

The Oracle Database Appliance Hardware Monitoring Tool displays the status of different hardware components in Oracle Database Appliance server nodes.

The tool is implemented with the Trace File Analyzer collector. Use the tool both on bare-metal and on virtualized systems.

You can see the list of monitored components by running the command `oakcli show -h`

To see information about specific components, use the command syntax `oakcli show component`, where *component* is the hardware component that you want to query. For example, the command `oakcli show power` shows information specifically about the Oracle Database Appliance power supply:

```
oakcli show power
```

NAME	HEALTH	HEALTH DETAILS	PART_NO.	SERIAL_NO.	LOCATION
INPUT POWER	OUTPUT POWER	INLET TEMP	EXHAUST TEMP		
Power Supply_0	OK	-	7047410	476856F+1242CE0020	PS0
Present	88 watts	31.250 degree C	34.188 degree C		
Power Supply_1	OK	-	7047410	476856F+1242CE004J	PS1
Present	66 watts	31.250 degree C	34.188 degree C		

Note:

Oracle Database Appliance Server Hardware Monitoring Tool is enabled during initial startup of ODA_BASE on Oracle Database Appliance Virtualized Platform. When it starts, the tool collects base statistics for about 5 minutes. During this time, the tool displays the message "Gathering Statistics..." message.

The Oracle Database Appliance Hardware Monitoring Tool reports information only for the node on which you run the command. The information it displays in the output depend on the component that you select to review.

A

Oracle Database Appliance Software Configuration Defaults

Oracle Database Appliance software configuration defaults.

- [Directory Paths for Oracle Database Appliance](#) (page A-1)
Oracle homes on Oracle Database Appliance follow Optimal Flexible Architecture guidelines.
- [Oracle Groups and Users Configuration for Oracle Database Appliance](#) (page A-2)
Review the table to see the groups and default users created when you deploy the appliance. All passwords are set to the Master password that you define during deployment.
- [System Configuration for Oracle Database Appliance](#) (page A-2)
Review to see the configuration options for Oracle Database Appliance.
- [Tuning I/Os Values for Improved Performance with Expanded Memory](#) (page A-3)
After you expand memory, tune the I/O per second (I/Os) values by adjusting the values for `kernel.sem`, `hugepage size`, and `oracle memlock limit` to improve storage performance.
- [Changing the Password](#) (page A-5)
Change the administrative account passwords to secure your system.

A.1 Directory Paths for Oracle Database Appliance

Oracle homes on Oracle Database Appliance follow Optimal Flexible Architecture guidelines.

Table A-1 Directory Paths for Oracle Database Appliance

Item	Directory Path
Grid home	<code>/u01/app/release-specific_name/grid</code>
Grid base	<code>/u01/app/grid</code>
Oracle home	<code>/u01/app/oracle/product/dbhome_release-specific_name/sequence_number</code>
Oracle base	<code>/u01/app/oracle</code>
Oracle Inventory	<code>/u01/app/oraInventory</code>

A.2 Oracle Groups and Users Configuration for Oracle Database Appliance

Review the table to see the groups and default users created when you deploy the appliance. All passwords are set to the Master password that you define during deployment.

Oracle Groups and Users Configurations

Table A-2 Oracle Groups and Users Configuration for Oracle Database Appliance

Groups and Users	Default Value
Oracle Grid Infrastructure installation owner	grid, UID 1001
Oracle Database installation owner	oracle, UID 1000
Oracle Database system administrator	sys
Oracle Database generic administrator	system
Oracle Inventory system privileges group	oinstall, GID 1001
Oracle ASM Administrators system privileges	asmadmin, GID 1004
Oracle ASM Users system privileges	asmdba, GID 1006
Oracle ASM Operator system privileges	asmoper, GID 1005
Oracle Database Administrators system privileges	dba, GID 1003
Oracle Database Operator system privileges	dbaoper, GID 1002

A.3 System Configuration for Oracle Database Appliance

Review to see the configuration options for Oracle Database Appliance.

Table A-3 System Configuration for Oracle Database Appliance

Item	Value
Oracle Linux with the Red Hat-compatible kernel	Oracle Linux 6.9 with kernel-4.1.12-112.14.1.el6uek.x86_64
Oracle Database release	12.1.0.2.180116, 11.2.0.4.180116 Oracle Database Enterprise Edition, Oracle Database Standard Edition 2, Oracle Database Standard Edition 1, Oracle Database Standard Edition
SCAN port number	1521
Oracle Enterprise Edition DB control port	1158 To access Enterprise Manager , enter the following URL string, where <i>hostname</i> is the name of one of the Oracle Database Appliance server nodes: <code>https://hostname:1158/em</code>

A.4 Tuning I/Os Values for Improved Performance with Expanded Memory

After you expand memory, tune the I/O per second (I/Os) values by adjusting the values for `kernel.sem`, `hugepage size`, and `oracle memlock limit` to improve storage performance.

Performance is determined by the configuration of a fully deployed Oracle Database Appliance. After you expand the memory, use the `oakcli reconfigure osparams` command to view the current configuration and suggested values for `memlock` and `vm.nr_hugepages`. The values provided for tuning the `kernel.sem`, `hugepage size`, and `oracle memlock` are estimated values. Your settings might vary, depending on the workload.

 **Note:**

When adjusting the settings, ensure that you make the changes on both nodes.

Increasing the `kernel.sem` Parameter

When running multiple Oracle databases on Oracle Database Appliance, increase the semaphore parameters (`kernel.sem`) on both nodes to improve performance.

The following semaphore parameters define shared memory:

- `semmsl`: The number of semaphores per set. The default is usually 250.
- `semms`: The total number of semaphores available. The default is usually 32000.
- `semopm`: The number of operations which can be made per semaphore call. The default is usually 100.
- `semmni`: The maximum number of shared memory segments available in the system. The default is usually 142.

The parameters appear in order in the `/etc/sysctl.conf` file. For example, `kernel.sem = 250 32000 100 142`

Edit the values in the `/etc/sysctl.conf` file from `250 32000 100 142` to `1510 214420 1510 2000` on both nodes as follows:

```
# vi /etc/sysctl.conf
kernel.sem=1510 214420 1510 200
# sysctl -p /etc/sysctl.conf
```

Increasing the Size of HugePages

Using very large page sizes (greater than the default 4 KB) can improve system performance by reducing the amount of system resources required to access page table entries. With `HugePages`, the operating system page table (virtual memory to physical memory mapping) is smaller, since each page table entry is pointing to larger pages and the kernel has fewer pages whose lifecycle must be monitored.

Increase the `hugepages` from 67200 to 103865 on both nodes:

```
# vi /etc/sysctl.conf vm.nr_hugepages=103865 # sysctl -p /etc/sysctl.conf
```

Increasing the Memory Limits for the Oracle User

The memory limits for user `oracle` are calculated by multiplying the number of HugePages with the `Hugepagesize`. For example, $2013 * 2048 = 4122624$.

Increase the `memlock` limit from 192000000 to 256000000 on both nodes:

```
# vi /etc/security/limits.conf
oracle soft memlock 256000000
oracle hard memlock 256000000
```

Shared Memory Settings

The following parameters determine how much shared memory (in pages) is available to use:

- `shmall`: The total amount of shared memory that can be allocated on the system.
- `shmmax`: The maximum size of a shared memory segment.
- `shmmni`: The maximum number of shared memory segments available on the system. Oracle recommends 4096.

The current setting fully covers all the memory combinations.

```
total_mem = `cat /proc/meminfo | grep MemTotal: | awk '{print $2}`
```

For Huge pages = $(total_mem / 4096) * 1.05$ (an extra 5% is added to handle any other processes, such as `oc4j`)

For memlock = $3/4 * total_mem$

Estimated IOps Configuration for Performance with Expanded Memory

The table provides suggested configuration settings to improve performance after expanding memory. Adjust the settings on both nodes.

Table A-4 Oracle Database Appliance IOps Configuration Settings

Environment Variable	384 GB	512 GB	768 GB
<code>memlock for oracle user</code>	294000000	391000000	588000000
<code>hugepages</code>	102681	137088	205900



Note:

The `memlock` and `hugepages` settings are specified in KB.

Related Topics

- [oakcli reconfigure osparams](#) (page 10-48)
Use the `oakcli reconfigure osparams` command to adjust the kernel parameters based on the available RAM after you upgrade memory or DIMM.

A.5 Changing the Password

Change the administrative account passwords to secure your system.

During deployment, the `root` and database users `SYS`, `SYSTEM` and `PDBADMIN` are set to the master password. After deployment, the `oracle` and `grid` passwords are also set to the master password, which is `welcome1`.

 **Note:**

Change the passwords to comply with your enterprise user security protocols.

Refer to the *Oracle Database Appliance Security Guide* and *Oracle Database Security Guide* for information about the required configuration and best practices to secure database systems.

B

Storage on Oracle Database Appliance

Review this section to understand Oracle Database Appliance storage architecture and options and how to determine usable storage.

- [About Oracle Database Appliance Storage](#) (page B-1)
Oracle Database Appliance uses the Oracle Automatic Storage Management Cluster File System (Oracle ACFS) for storage of database and virtual machine files.
- [Determining Usable Storage for Oracle Database Appliance X6-2-HA](#) (page B-4)
Review the usable disk capacity available for Oracle Database Appliance X6-2-HA and how capacity is derived.
- [Oracle ACFS Space Management](#) (page B-6)
The Oracle ACFS file systems are automatically created when you create a database on Oracle Database Appliance.

B.1 About Oracle Database Appliance Storage

Oracle Database Appliance uses the Oracle Automatic Storage Management Cluster File System (Oracle ACFS) for storage of database and virtual machine files.

Oracle ACFS provides both servers with concurrent access to some or all of the shared storage on Oracle Database Appliance. Oracle ACFS supports space-efficient storage snapshots, which provides fast provisioning databases and virtual machines within Oracle Database Appliance.

Storage Systems Used With Oracle Database Appliance

Three types of Oracle ACFS file systems are used in Oracle Database Appliance:

- Database File Systems
- Shared repositories
- General-purpose storage

About Database File Systems

Database file systems are used exclusively for storing database files, and they include a FLASH file system for storing database data files and flash cache files, a DATA file system for database data files, a RECO file system for storing archive files and backups, and a REDO file system for storing redo log files.

About Shared Repositories

Shared repositories are file systems created on Oracle Database Appliance Virtualized Platform, and they are used to store virtual machine templates, runtime images, and virtual disks.

About General Purpose Storage

Every Oracle Database Appliance has a general-purpose cluster file system created by default. That cluster file system is named `cloudfs`. You can use the `cloudfs` file system for general-purpose storage of files that must be shared between the servers. For example, you can use the `cloudfs` file system for staging data loads.

All Oracle ACFS file systems are created on Oracle ASM Dynamic Volumes provisioned from disk groups that are created in the shared disk storage pool. In a bare-metal deployment, these file systems are mounted directly in the operating system hosting the databases. In a virtualized deployment, these file systems are managed and mounted directly in `ODA_BASE`.

- [Oracle ACFS Mount Points and Storage Space](#) (page B-2)
Review Oracle ASM Cluster file system (ACFS) mount points for Oracle Database Appliance.
- [Displaying Mounted Disk Details](#) (page B-3)
Use the Oracle Automatic Storage Management `lsdgs` command to display mounted disk groups and their information for Oracle Database Appliance.

B.1.1 Oracle ACFS Mount Points and Storage Space

Review Oracle ASM Cluster file system (ACFS) mount points for Oracle Database Appliance.

The storage shelf in the base Oracle Database Appliance X6-2-HA system is half populated with 10 solid-state drives (SSDs) for data storage, totaling 12TB of raw storage capacity. The storage shelf in the base system also has four 200 GB high endurance SSDs for database redo logs to improve performance and reliability. A separate ACFS file system is created from the REDO diskgroup for redo log files. Add 10 more SSDs on the base system for a total of 20 SSDs and 24 TB of raw storage capacity.

If you need additional storage, an optional storage expansion shelf is available. With the optional storage expansion shelf, the raw data storage capacity increases to a total of 48TB. The expansion shelf contains four 200 GB SSDs to expand the storage capacity for the database REDO logs. In addition, you can use external NFS storage outside of the appliance for online backups, data staging, or additional database files.

Table B-1 Oracle ACFS Mount Points and Related Oracle ASM Disk Groups and Volume Information

File System	Oracle ASM Disk Group	Oracle ASM Dynamic Volume	Mount Point
DATA	+DATA	<code>/dev/asm/datdbname-<i>nnn</i></code> For example: <code>/dev/asm/datodacn-123</code>	<code>/u02/app/oracleuser/oradata/<i>dbname</i></code> For example: <code>/u02/app/example/oradata/odacn</code>

Table B-1 (Cont.) Oracle ACFS Mount Points and Related Oracle ASM Disk Groups and Volume Information

File System	Oracle ASM Disk Group	Oracle ASM Dynamic Volume	Mount Point
RECO	+RECO	/dev/asm/reco- <i>nn</i>	<p><i>/u03/app/oracleuser</i></p> <p>This mount point is shared by all databases for <i>fast_recovery_area</i> and redo logs.</p> <p>For <i>fast_recovery_area</i>, the path is: <i>/u03/app/oracleuser/fast_recovery_area/db_name</i></p> <p>For redo logs, the path is: <i>/u03/app/oracleuser/redo/db_name</i></p>

Example B-1 Oracle ACFS Storage Space

When the Oracle ACFS file systems are created, they do not initially consume all of the storage in the appliance. Space is preserved for additional repositories, or in some cases, database files stored directly in Oracle ASM. You can check for available storage space in your file systems by running the operating system command `df -k` as shown in the following example.

```
# df -k
Filesystem                1K-blocks  Used    Available  Use%    /
Mounted on
/dev/mapper/VolGroupSys-LogVolRoot  30963708  14203568  15187276   49%    /
tmpfs                    65952292    647800   65304492
1% /dev/shm
/dev/sda1                 495844     43872    426372   10%    /
boot
/dev/mapper/VolGroupSys-LogVolOpt  61927420  18594420  40187272   32%    /
opt
/dev/mapper/VolGroupSys-LogVolU01  103212320  49621560  48347880   51%    /
u01
/dev/asm/reco-62          76546048  1469676  75076372
2% /u03/app/oracle
/dev/asm/datrdb2-268      104857600  3872368  100985232
4% /u02/app/oracle/oradata/rdb2
/dev/asm/datndb11-268    104857600  247160  104610440
1% /u02/app/oracle/oradata/ndb11
/dev/asm/datndb12-268    104857600  247160  104610440
1% /u02/app/oracle/oradata/ndb12
```

B.1.2 Displaying Mounted Disk Details

Use the Oracle Automatic Storage Management `lsdsg` command to display mounted disk groups and their information for Oracle Database Appliance.

To display information about a specific disk group, specify the disk group in the command.

1. Log in as a `grid` user.
2. Run the Oracle Automatic Storage Management `lsdsg` command.

Example B-2 Determining Storage on the DATA Disk Group

```

ASMCMD [+] > lsdg data

State      Type      Rebal  Sector  Block      AU  Total_MB  Free_MB  Req_mir_free_MB
Usable_file_MB
MOUNTED   NORMAL    N           512    4096  4194304    12288    8835
1117                3859

(continued)
Offline_disks  Voting_files  Name
              0                N  DATA
    
```

B.2 Determining Usable Storage for Oracle Database Appliance X6-2-HA

Review the usable disk capacity available for Oracle Database Appliance X6-2-HA and how capacity is derived.

Oracle Database Appliance X6-2-HA use 1.6TB raw Solid-State Drives, formatted to 1.2TB for performance. The usable data capacity varies because it is derived by converting disk hardware terabytes (based on 1 kilobyte equals 1,000 bytes) into software storage terabytes (based on 1 kilobyte equals 1,024 bytes) and splitting the usable capacity into Oracle Automatic Storage Management (Oracle ASM) disk groups.

Each of the SSD usable storage is approximately 1.1TB. This is calculated by the storage usable capacity of the drive converted to TB (1.2 TB divided by 1.024⁴= 1.1TB.)

The following tables provide the approximate amount of usable space for the Oracle Database Appliance X6-2-HA for the DATA and RECO disk groups.

Usable Disk Capacity on Oracle Database Appliance X6-2-HA

The following table provides the approximate amount of usable space for the Oracle Database Appliance X6-2-HA.

Table B-2 Usable Disk Capacity on Oracle Database Appliance X6-2-HA

Description	Sizing for X6-2-HA with 10 SSD Drives	Sizing for X6-2-HA with 20 SSD Drives	Sizing for X6-2-HA with 40 SSD Drives
Number of SSD Drives	10	20	40
Total usable Space	10.9TB	22TB	44TB
Reserved Space Normal Redundancy	1.1TB	1.1TB	1.1TB
Total Usable Normal (Double Mirror) Oracle ASM Redundancy	4.9TB	10.5TB	21.5TB
DATA Disk Group Normal Redundancy, External Backup (80% usable)	3.9TB	8.4TB	17.2TB
RECO Disk Group Normal Redundancy, External Backup (20% usable)	1.0TB	2.1TB	4.3TB

Table B-2 (Cont.) Usable Disk Capacity on Oracle Database Appliance X6-2-HA

Description	Sizing for X6-2-HA with 10 SSD Drives	Sizing for X6-2-HA with 20 SSD Drives	Sizing for X6-2-HA with 40 SSD Drives
DATA Disk Group Normal Redundancy, Internal Backup (40% Usable)	2.0TB	4.2TB	8.6TB
RECO Disk Group Normal Redundancy, Internal Backup (60% usable)	2.9TB	6.3TB	12.9TB
Reserved Space High Redundancy	2.2TB	2.2TB	2.2TB
Total usable High (Triple Mirror) Oracle ASM Redundancy	2.9TB	6.6TB	13.9TB
DATA Disk Group High Redundancy, External Backup(80% usable)	2.3TB	5.3TB	11.1TB
RECO Disk Group High Redundancy, External Backup (20% usable)	0.6TB	1.3TB	2.8TB
DATA Disk Group High Redundancy, Internal Backup(40% usable)	1.2TB	2.6TB	5.6TB
RECO Disk Group (10% usable)	1.7TB	4.0TB	8.3TB

The Reserved Space values represent the amount of storage required to maintain full redundancy in case of disk failure.

The REDO disk group uses 800 GB raw Solid-State Drives or 0.8TB total usable space. The REDO disk group uses high redundancy that provides approximately 0.3TB usable space for database redo logs.

 **Note:**

For non-CDB databases, the REDO disk group has 50% free disk space.

For CDB databases, an Oracle ASM Cluster file system (ACFS) mount point is created per CDB database, based on the template log file size. If this is a Single Instance (SI) database, then multiply by 3. If the database is an Oracle RAC database, then multiply by 4.

Oracle ASM Calculations

When Oracle ASM calculates Usable Free Space, it determines the amount of space to reserve in the case of a disk failure. When you query Oracle ASM or Oracle Database Appliance commands to view the amount of storage available, the `usable_file_MB` value may report a negative number.

Table B-3 Oracle ASM Calculations

Number of Drives	Redundancy	Total_MB	Free_MB	Req_mir_free_MB	Usable_file_MB	Name
2	NORMAL	4894016	4893372	2441888	1220644	DATA/
4	NORMAL	1231176	1230996	610468	305150	RECO/



Note:

Note: 1TB = MB divided by 1024²

The following table describes how capacity terms are defined by Oracle ASM and Oracle Database Appliance.

Table B-4 Definition of Terminology

Term	Oracle ASM Definition	Oracle Database Appliance Definition
Total_MB	Size of the disk group in MB	Total usable storage. For example, for 2 NVMe drives, total usable storage is 5.8TB.
Free_MB	Free space in the disk group in MB, without regard to redundancy.	Total usable storage after formatting to Oracle ASM disk groups. For example, for 2 NVMe drives, total usable storage is 5.8TB.
Req_mir_free_MB	Amount of space that must be available in the disk group to restore full redundancy after the worst failure that can be tolerated by the disk group.	Usable space required to restore full redundancy. When storage is consumed higher than the <code>usable_file_MB</code> value, this number will report a negative value.
Usable_file_MB	Amount of free space, adjusted for mirroring, that is available for new files.	Total usable space taking into consideration the mirroring level. Oracle ASM also calculates the amount of space required

B.3 Oracle ACFS Space Management

The Oracle ACFS file systems are automatically created when you create a database on Oracle Database Appliance.

When you use Oracle ACFS for database storage, the following is created:

- A 100G ACFS is created from +DATA diskgroup for each database. This Oracle ACFS automatically extends the space on demand.
- A common Oracle ACFS with 25% of +RECO diskgroup is created with auto extension on. This file system is used for fast recovery area and redo logs for all databases.

When the Oracle ACFS file systems are created, they do not initially consume all of the storage in the appliance. Space is preserved for additional repositories, or in some cases, database files stored directly in Oracle ASM. You can check for available storage space in your file systems by running the operating system command `df -k` as shown in the following example.

```
# df -k
Filesystem                1K-blocks    Used      Available   Use%    /
/dev/mapper/VolGroupSys-LogVolRoot 30963708    14203568    15187276    49%    /
tmpfs                     65952292     647800     65304492
1% /dev/shm
```

/dev/sda1	495844	43872	426372	10%	/
boot					
/dev/mapper/VolGroupSys-LogVolOpt	61927420	18594420	40187272	32%	/
opt					
/dev/mapper/VolGroupSys-LogVolU01	103212320	49621560	48347880	51%	/
u01					
/dev/asm/reco-62	76546048	1469676	75076372		
2% /u03/app/oracle					
/dev/asm/datrdb2-268	104857600	3872368	100985232		
4% /u02/app/oracle/oradata/rdb2					
/dev/asm/datndb11-268	104857600	247160	104610440		
1% /u02/app/oracle/oradata/ndb11					
/dev/asm/datndb12-268	104857600	247160	104610440		
1% /u02/app/oracle/oradata/ndb12					

C

Database Templates for Oracle Database Appliance

Use the information in this appendix to select database templates for your planned databases.

Topics:

- [About Database Templates for Oracle Database Appliance](#) (page C-1)
Review this information to help determine the database template to use.
- [Types of Database Templates for Oracle Database Appliance X6-2-HA](#) (page C-3)
Use one of the database templates defined for Oracle Database Appliance X6-2-HA.

C.1 About Database Templates for Oracle Database Appliance

Review this information to help determine the database template to use.

Oracle Database Appliance enables you to consolidate many databases into a single system. Consolidation can minimize idle resources, maximize efficiency, and lower costs. By using instance caging in conjunction with Oracle Database Resource Manager (the Resource Manager), you can provide desired levels of service across multiple instances on a single Oracle Database Appliance.

Oracle Database Appliance templates are already tuned for the size of each database instance workload. They are designed to run on a specific number of cores. Caging ensures that each database workload is restricted to the set of cores allocated by the template, enabling multiple databases to run concurrently with no performance degradation, up to the capacity of Oracle Database Appliance. You can select database template sizes larger than your current needs to provide for planned growth, which you accommodate later by adjusting System Global Area (SGA) and Program Global Area (PGA) sizes as well as the number of cores.

The Oracle Appliance Manager Configurator refers to the database sizing templates as *classes* of databases.

Note:

Oracle strongly recommends that you use the Oracle Database Appliance templates, because they implement best practices and are configured specifically for Oracle Database Appliance.

Use the database sizing tables to help select the best templates for your databases. When using the sizing tables remember that:

- The information in the tables assumes that you are creating disk backups. The information in the tables assume that you are creating local disk backups. Consider the space requirements for your database and the policy for local disk backups versus external backups. Typically, external backups have more space available for the database than local backups.
- Container databases are created on Oracle ACFS.
- The log file size assumes four redo log groups for each instance with a log switch every 15 minutes when the system is running at full capacity.
- Storage is shared between the servers on Oracle Database Appliance.

About Oracle Database Appliance Template Options

The database templates are configured specifically for the type of database workload that you want to carry out on your databases on Oracle Database Appliance. Choose the template that best matches the common workload your databases perform (OLTP, DSS, In-Memory).

The database sizing tables provide template names and sizing based on the number of CPUs and memory attributes for each type of database workload.

Identify the template type that is appropriate to your database workload and hardware:

- Use Oracle Database Appliance OLTP Database Templates if your database workload is primarily online transaction processing (OLTP).
- Use Oracle Database Appliance DSS database templates if your database workload is primarily decision support services (DSS) or data warehousing.
- Use Oracle Database Appliance In-Memory (IMDB) database templates if your database workload can fit in memory, and can benefit from in-memory performance capabilities.
- Use the platform-specific database templates if your database is on a specific platform. For example, use Oracle Database Appliance X6-2-HA generic database templates if your database is on Oracle Database Appliance X6-2-HA.

The templates provide general guidelines about the maximum number of databases on a fully deployed Oracle Database Appliance. Base the memory and CPU sizing on the number of instances per server, not the number of databases. Memory and CPUs are shared by all databases and the number of databases impacts performance. For example, when you have one database, the database receives full I/O throughput. If you have 9 databases, then each database has only 1/9th of the available I/O throughput for all disks.

When you have multiple databases, they share and compete over available CPU resources. When choosing a template, do not have more CPU_COUNTs distributed than available threads in the system. Oracle recommends partitioning, where every database has exclusive CPUs. If you choose to exceed the recommended maximum number of databases on Oracle Database Appliance (over-provision), be aware of your I/O results and performance degradation. With the over-provisioned approach, the sum of the CPU_COUNT across all instances can exceed the number of CPUs. Better resource utilization is provided with over-provisioning; however, it is possible for contention to occur when multiple databases are heavily loaded at the same time. Over-provisioning is best used for systems running non-critical applications. Avoid using over-provisioning for databases with high I/O requirements or those with high

transaction rates. If you choose to over-provision, then do not exceed twice the number of total CPUs. Twice the allocation of total CPUs is based on hyper-threading of 2 CPU threads per core.

C.2 Types of Database Templates for Oracle Database Appliance X6-2-HA

Use one of the database templates defined for Oracle Database Appliance X6-2-HA.

Oracle Database Appliance OLTP Database Template Sizes

Table C-1 Oracle Database Appliance OLTP Database Template Sizes

Template	CPU Cores	SGA (GB)	PGA (GB)	Processes	LOG buffer, Redo Log
odb-01s	1	2	1	200	16 MB, 1 GB
odb-01	1	4	2	200	16 MB, 1 GB
odb-02	2	8	4	400	16 MB, 1 GB
odb-04	4	16	8	800	32 MB, 1 GB
odb-06	6	24	12	1200	64 MB, 2 GB
odb-12	12	48	24	2400	64 MB, 4 GB
odb-16	16	64	32	3200	64 MB, 4 GB
odb-20	20	80	40	4000	64 MB, 4 GB

Oracle Database Appliance DSS Database Template Sizes

Table C-2 Oracle Database Appliance DSS Database Template Sizes

Template	CPU Cores	SGA (GB)	PGA (GB)	Processes	Redo log file size (GB)	Log buffer (MB)
odb-01s	1	1	2	200	1	16
odb-01	1	2	4	200	1	16
odb-02	2	4	8	400	1	16
odb-04	4	8	16	800	1	32
odb-06	6	12	24	1200	2	64
odb-12	12	24	48	2400	4	64
odb-16	16	32	64	3200	4	64
odb-20	20	40	80	4000	4	64

Oracle Database Appliance In-Memory Database Template Size

Table C-3 Oracle Database Appliance In-Memory Database Template Size

Template	CPU Cores	SGA (GB)	PGA (GB)	In-Memory (GB)	Processes	Redo log file size (GB)	Log buffer (MB)
odb-01s	1	2	1	1	200	1	16
odb-01	1	4	2	2	200	1	16
odb-02	2	8	4	4	400	1	16
odb-04	4	16	8	8	800	1	32
odb-06	6	24	12	12	1200	2	64
odb-12	12	48	24	24	2400	4	64
odb-16	16	64	32	32	3200	4	64
odb-20	20	80	40	40	4000	4	64

Index

Numerics

10-GbE network interface, [9-42](#)

A

about deploying, [4-8](#)

ACFS, [B-1](#), [B-2](#), [B-6](#)

ACFS mount points, [B-2](#)

administrative account users, [7-4](#)

administrative accounts, [7-4](#)

ASM Cluster File System

See Oracle ACFS

ASR

See Oracle ASR (Auto Service Request)

Automatic Storage Management

See Oracle ASM

B

backup and recovery

RMAN, [7-2](#)

backup file location

configurator, [2-8](#)

bare metal restore, [6-17](#)

BIOS (basic input/output system)

software inventory, [1-1](#)

bond

network interface, [9-42](#)

bridge

network interface, [9-42](#)

C

cabling, [3-2](#)

changing deployment types, [4-1](#)

checklist

for system requirements, [2-6](#)

tasks to complete before deployment, [2-1](#)

cleaning up deployment, [11-5](#)

cleanup script

See cleanupDeploy.sh

cleanupDeploy.sh, [4-1](#)

cloudfs

display file systems, [10-61](#)

Cluster Health Monitor

collect diagnostic data, [10-43](#)

Cluster Time Synchronization Service

See CTSS

component version

display, [10-75](#)

Configuration Audit Tool (ORAchk), [11-8](#)

configuration file, [2-12](#), [4-2](#)

configure virtual machine, [9-38](#)

configuring, [4-14](#)

container database, [2-12](#)

controllers

display details, [10-65](#)

convert single instance database

to Oracle RAC, [7-8](#)

to Oracle RAC One Node, [7-8](#)

cooling

show status, [10-53](#)

cores

display how allocated to virtual machines,
[10-54](#)

CPU

caging, [9-39](#)

display details, [10-54](#)

display processor details, [10-63](#)

CPU core

describe, [10-38](#)

update, [10-77](#)

CPU pool, [9-39](#)

default-unpinned-pool, [9-39](#)

over-subscribed, [9-40](#)

CTSS (Cluster Time Synchronization Service),

[2-7](#)

D

DATA disk group, [B-3](#), [B-4](#)

database, [2-8](#), [7-8](#), [C-1](#), [C-3](#)

block size

configurator, [2-8](#)

configuration file, [7-6](#)

remove, [7-6](#)

view contents, [7-6](#)

consolidate multiple, [C-1](#), [C-3](#)

display file systems, [10-61](#)

- database (*continued*)
 - home, [7-8](#)
 - create multiple, [7-8](#)
 - multiple, [7-8](#)
 - language
 - configurator, [2-8](#)
 - managing and maintaining, [7-1](#)
 - template
 - See template, database
 - territory
 - configurator, [2-8](#)
 - upgrade, [7-12](#)
 - database class, [2-12](#)
 - database configuration
 - display parameters, [10-56](#)
 - database configuration file
 - create, [10-28](#)
 - delete, [10-33](#)
 - database homes
 - display details, [10-56](#)
 - database language, [2-12](#)
 - database snapshot, [7-7](#)
 - create, [10-30](#)
 - database storage, [B-1](#)
 - database template
 - See template, database
 - database templates, [C-1](#), [C-3](#)
 - database type, [2-12](#)
 - dbhome
 - delete, [10-34](#)
 - default groups and users, [A-2](#)
 - deploy
 - how to, [4-1](#)
 - deploying, [4-11](#)
 - virtualized platform, [4-14](#)
 - deployment options
 - virtualized platform, [2-2](#)
 - deployment plan, [2-12](#)
 - deployment steps
 - overview, [1-2](#)
 - DHCP (Dynamic Host Configuration Protocol)
 - configuring initial network, [3-11](#)
 - connect to Oracle ILOM, [3-10](#)
 - initial network, [3-11](#), [10-14](#)
 - Oracle ILOM configuration, [3-10](#)
 - directory paths, [A-1](#)
 - disk
 - display details, [10-58](#)
 - disk controllers
 - display details, [10-53](#)
 - disk diagnostic tool, [11-8](#)
 - disk group sizes, [A-2](#)
 - disk storage
 - display details, [10-65](#)
 - DNS
 - See domain name system
 - domain
 - definition, [9-4](#)
 - Domain 0 (Dom0)
 - definition, [9-3](#)
 - domain name system, [1-2](#), [2-7](#), [3-11](#)
 - initial network, [3-11](#)
 - prepare to install, [1-2](#)
 - domain name system server
 - configure network names, [1-2](#)
 - Domain U
 - definition, [9-3](#)
 - driver domain virtual machine
 - about, [9-28](#)
 - Dynamic Host Configuration Protocol
 - See DHCP
- ## E
-
- electrical connections
 - attach power cords, [3-8](#)
 - electrical power cords
 - connecting, [3-8](#)
 - end-user bundle
 - deployment, [4-2](#)
 - download, [4-2](#)
 - software inventory, [1-1](#)
 - environment
 - display, [10-60](#)
 - errors
 - display validation, [10-65](#)
 - expander
 - display information, [10-60](#)
 - error detection, [10-60](#)
 - expanders
 - display details, [10-65](#)
- ## F
-
- failures
 - display validation, [10-66](#)
 - fiber connections, [3-3](#)
 - firmware
 - display version, [10-67](#)
 - invalid version failure, [10-65](#), [10-66](#)
 - patching, [10-75](#)
- ## G
-
- GI/RDBMS Clone
 - download, [4-2](#)
 - Grid user, [7-4](#)
 - group user
 - change name or ID, [10-37](#)
 - groups and users defaults, [A-2](#)

Guest Domains (Domain U)
 definition, [9-3](#)
 guest virtual machine
 definition, [9-4](#)

H

hardware
 display version, [10-60](#)
 hardware driver
 software inventory, [1-1](#)
 high availability, [9-38](#)
 HRD tool, [11-8](#)
 hugepages
 size, [A-3](#)

I

InfiniBand, [3-3](#)
 display details, [10-60](#)
 display port, [10-60](#)
 InfiniBand interconnect cabling, [3-2](#)
 initial network
 configure, [3-11](#)
 installation owner
 grid, [5-1](#), [A-5](#)
 oracle, [5-1](#), [A-5](#)
 password, [5-1](#), [A-5](#)
 instance caging, [7-10](#)
 enable, [7-10](#)
 overview, [1-2](#)
 template, [C-1](#), [C-3](#)
 Integrated Lights Out Manager
 See Oracle ILOM
 interconnect cables
 attach, [3-2](#)
 storage expansion shelf, [3-7](#)
 IOps
 performance, [A-3](#)
 IPMI (Intelligent Platform Management Interface)
 change password, [5-1](#)
 ISO
 downloading, [4-10](#), [6-17](#)
 virtualized OS image, [4-10](#)
 ISO image
 virtualized, [4-11](#)

K

kernel parameters
 adjust after memory upgrade, [10-48](#)
 kernel.sem
 values, [A-3](#)
 keyboard
 adding, [3-7](#)

L

LED
 physical disk identifier, [10-42](#)
 status when blinking, [3-9](#)
 status when steady, [3-9](#)
 status when steady on, [3-9](#)
 Linux
 and virtualization, [9-2](#)
 software inventory, [1-1](#)
 local disk
 display details, [10-61](#)
 local repository, [9-13](#)
 log files
 sending to Oracle Support Services, [11-7](#)
 log switch
 select template, [C-1](#), [C-3](#)

M

manual database updates, [7-12](#), [7-13](#)
 manual database upgrades, [7-16](#)
 master node
 command, [10-61](#)
 memlock
 size, [A-3](#)
 memory module
 display details, [10-62](#)
 migration
 from an existing database, [7-2](#)
 monitor
 adding, [3-7](#)
 mouse
 adding, [3-7](#)
 multiple database instances
 instance caging, [7-10](#)
 multiple Oracle homes, [7-8](#)
 create, [7-8](#)
 My Oracle Support, [11-7](#)
 hardware SI, [2-1](#)
 register, [1-2](#)
 send log files for troubleshooting, [11-7](#)

N

network
 display details, [10-62](#)
 network infrastructure, [9-42](#)
 network interface
 default values, [9-42](#)
 network planning, [2-7](#)
 network time protocol service (NTP service)
 configurator, [2-8](#)
 network validation, [2-12](#)
 NTP service

See network time protocol service

O

oakcli

show cooling, [10-53](#)

OAKCLI

See Oracle Appliance Manager command-line interface

oakcli commands, [4-8](#)

-repo parameter, [9-19](#)

-snap, [9-19](#), [9-20](#)

-vm, [9-20](#)

-vmtemplate, [9-19](#)

add disk -local, [10-6](#)

apply, [10-7](#)

clone, [10-8](#)

clone vdisk, [9-11](#), [10-8](#)

clone vm, [9-19](#), [9-20](#), [10-9](#)

clones and snap clones, [9-18](#)

configure, [10-11](#)

configure additionalnet, [10-12](#)

configure asr, [5-2](#)

configure ASR, [10-12](#)

configure cpupool, [9-41](#), [10-13](#)

configure firstnet, [10-14](#)

configure ib2fiber, [10-14](#)

configure network, [10-15](#)

configure networks, [10-12](#)

configure oda_base, [10-15](#)

configure ODA_BASE, [9-47](#)

configure repo, [9-10](#), [10-16](#)

configure vm, [9-16](#), [9-17](#), [9-38](#), [9-42](#), [10-17](#)

configure vmtemplate, [9-16](#), [9-17](#), [10-19](#)

copy, [10-21](#)

create, [10-21](#)

db_config_params, [10-28](#)

dbhome, [7-16](#)

create cpupool, [9-41](#), [10-22](#)

create database, [7-6](#), [7-8](#), [10-23](#)

create db_config_params, [7-6](#)

create dbhome, [10-26](#)

create dbstorage, [10-27](#)

create repo, [9-7](#), [10-29](#)

create vdisk, [9-10](#)

create vlan, [9-44](#), [10-31](#)

delete, [10-32](#)

delete cpupool, [10-33](#)

delete database, [10-33](#)

delete db_config_params, [7-6](#), [10-33](#)

delete dbhome, [10-34](#)

delete dbstorage, [10-34](#)

delete repo, [9-9](#), [10-35](#)

delete vdisk, [9-12](#)

delete vlan, [9-44](#), [10-36](#)

oakcli commands (*continued*)

delete vm, [10-36](#)

delete vmtemplate, [9-18](#), [10-36](#)

deploy, [4-1](#)

change group name and ID, [10-37](#)

log file, [10-37](#)

describe-cpucore, [10-38](#)

diskwritocache, [10-40](#)

expand storage, [10-39](#)

import vmtemplate, [9-15](#), [10-40](#)

locate, [10-42](#)

manage diagcollec, [11-7](#)

manage diagcollect, [10-42](#)

migrate vm, [10-43](#)

modify, [10-44](#)

modify database, [10-44](#)

modify vm, [9-12](#), [9-44](#), [10-45](#)

-addnetwork parameter, [9-44](#)

modify vmtemplate, [10-46](#)

oakcli create db_config_params, [10-28](#)

oakcli create snapshotdb, [10-30](#)

oakcli create vdisk, [10-30](#)

oakcli delete vdisk, [10-35](#)

oakcli oakcli show ib, [10-60](#)

oakcli show dbstorage, [10-57](#)

oakcli show fs, [10-61](#)

oakcli show iraid, [10-61](#)

oakcli show vmconsole, [10-70](#)

orachk, [10-46](#)

reconfigure kernel parameters, [10-48](#)

reconfigure memlock, [10-48](#)

reconfigure osparams, [10-48](#)

reconfigure vm.nearhugepage, [10-48](#)

resize dbstorage, [10-49](#)

restart oda_base, [10-49](#)

restart ODA_BASE, [9-47](#)

show, [10-50](#)

databases, [6-14](#), [7-12](#), [7-13](#)

dbhome, [7-16](#)

show -h

with Oracle Database Appliance

Hardware Monitoring Tool, [11-9](#)

show asr, [10-53](#)

show controller, [10-53](#)

show core_config_key, [10-54](#)

show cpupool, [9-41](#), [10-54](#)

show databases, [10-55](#)

show db_config_params, [7-6](#), [10-56](#)

show dbhomes, [10-56](#)

show disk, [10-58](#)

show diskgroup, [10-59](#)

show enclosure, [10-59](#)

show env_hw, [10-60](#)

show expander, [10-60](#)

show ismaster, [10-61](#)

- oakcli commands (*continued*)
 - show memory, [10-62](#)
 - show network, [10-62](#)
 - show power, [10-62](#)
 - example, [11-9](#)
 - show processor, [10-63](#)
 - show raidsyncstatus, [10-63](#)
 - show repo, [9-8](#), [10-63](#)
 - show server, [10-64](#)
 - show storage, [10-65](#)
 - show validation storage, [10-65](#)
 - show validation storage errors, [10-65](#)
 - show validation storage failures, [10-66](#)
 - show vdisk, [9-11](#), [10-66](#)
 - show version, [6-15](#), [10-67](#)
 - show vlan, [9-44](#), [10-68](#)
 - show vm, [10-69](#)
 - show vmtemplate, [9-14](#), [9-17](#), [10-70](#)
 - start, [10-71](#)
 - start oda_base, [10-71](#)
 - start repo, [9-8](#), [10-72](#)
 - start vm, [9-25](#), [10-72](#)
 - stop, [10-73](#)
 - stop repo, [9-9](#)
 - stop vm, [9-25](#)
 - stordiag, [10-74](#), [11-8](#)
 - test asr, [10-75](#)
 - unpack, [10-75](#)
 - update, [6-14](#), [7-12](#), [7-13](#), [10-75](#)
 - update-cpucore, [10-77](#)
 - upgrade, [10-78](#)
 - upgrade database, [7-16](#)
 - validate, [10-79](#), [11-1–11-3](#)
 - validate -c ospatch, [6-10](#)
- OAKCLI commands
 - create database, [7-5](#)
- oakcli deploy, [10-37](#)
- ODA_BASE
 - caging, [9-39](#)
 - definition, [9-3](#)
 - Dom1, [4-8](#)
 - domain, [9-39](#)
 - resize, [9-47](#)
 - resizing, [9-47](#)
 - software inventory, [1-1](#)
 - VLAN management, [9-44](#)
- odarepo1
 - local repository, [9-13](#)
- odarepo2
 - local repository, [9-13](#)
- OINSTALL group, [7-4](#)
- Optimal Flexible Architecture
 - and Oracle homes, [A-1](#)
- ORAchk, [11-8](#)
- Oracle ACFS, [9-4](#)
 - Oracle ACFS (*continued*)
 - display database storage information, [10-57](#)
 - Oracle ACFS (Oracle Automatic Storage Management Cluster File System)
 - shared repository, [9-4](#)
 - Oracle Appliance Kit
 - Command-Line Interface
 - Database management, [7-1](#)
 - Oracle Appliance Manager
 - software inventory, [1-1](#)
 - Oracle Appliance Manager command-line interface, [1-1](#)
 - alphabetical list of commands, [10-1](#)
 - help for, [10-3](#)
 - location of, [10-3](#)
 - uses for, [10-3](#)
 - Oracle Appliance Manager command-line-interface
 - operational notes, [10-3](#)
 - Oracle Appliance Manager Configurator
 - about, [2-12](#)
 - download standalone, [1-2](#)
 - network names and addresses, [1-2](#)
 - network validation errors, [2-12](#)
 - using, [2-12](#)
 - Oracle ASM (Oracle Automatic Storage Management)
 - add storage expansion shelf, [3-4](#)
 - configuration check, [11-8](#)
 - data migration, [7-2](#)
 - deployment overview, [1-2](#)
 - physical disk identifier, [10-42](#)
 - shared repositories, [2-2](#)
 - trace file analyzer diagnostics, [11-8](#)
 - user group, [A-2](#)
 - Oracle ASM disk group
 - display details, [10-59](#)
 - Oracle ASR (Auto Service Request), [10-75](#)
 - configure, [10-12](#)
 - display configuration details, [10-53](#)
 - test asr, [10-75](#)
 - Oracle ASR (Oracle Auto Service Request)
 - configurator, [2-8](#)
 - configuring, [5-2](#)
 - Oracle Automatic Storage Management
 - See Oracle ASM
 - Oracle Cloud File System
 - configurator, [2-8](#)
 - Oracle Clusterware
 - deployment overview, [1-2](#)
 - description, [7-3](#)
 - Oracle Database, [2-8](#), [7-8](#), [C-1](#), [C-3](#)
 - upgrading, [6-14](#)
 - See also database

Oracle Database Appliance Hardware Monitoring Tool, [11-9](#)

Oracle Database Appliance Virtualized Platform and oakcli, [10-3](#)

Oracle Database Enterprise Edition
deployment overview, [1-2](#)
overview, [2-4](#)

Oracle Database Resource Manager
instance caging, [7-10](#)

Oracle DBCA (Oracle Database Configuration Assistant)
add database, [7-3](#)
convert database, [7-8](#)
drop database, [7-3](#)

Oracle Grid Infrastructure
deployment overview, [1-2](#)
software inventory, [1-1](#)

Oracle home
multiple, [7-8](#)

Oracle ILOM (Oracle Integrated Lights Out Manager)
configurator, [2-8](#)
configure, [3-10](#)
software inventory, [1-1](#)

Oracle Integrated Lights Out Manager
See Oracle ILOM

Oracle RAC (Oracle Real Application Clusters),
[1-2](#), [2-4](#), [11-8](#)
check configuration settings, [11-8](#)
convert single-instance database to, [7-8](#)
deployment option, [2-4](#)
deployment overview, [1-2](#)
description, [7-3](#)
Oracle Clusterware, [7-3](#)
trace file analyzer, [11-8](#)
VIP address requirement, [2-10](#)
See also Oracle RAC One Node

Oracle RAC One Node, [1-2](#), [2-4](#), [2-12](#)
convert single instance database to, [7-8](#)
deployment option, [2-4](#)
deployment overview, [1-2](#)
description, [7-3](#)

Oracle Real Application Clusters
See Oracle RAC

Oracle Support Services
See My Oracle Support

Oracle user, [7-4](#)

Oracle VM, [9-2](#)

OSASM group, [7-4](#)

OSDBA, [7-4](#)

OSDBA for ASM group, [7-4](#)

OSDBA group, [7-4](#)

OSOPER groups, [7-4](#)

over-subscribed CPU pool, [9-40](#)

P

password
changing, [5-1](#), [A-5](#)

patch bundle, [6-1](#)
software inventory, [1-1](#)
unpack, [6-9](#)

patching, [6-1](#)
deployment overview, [1-2](#)
Oracle Database, [6-14](#)
validating patches, [6-10](#)

patching, downloading patch bundle, [6-8](#)

performance
improve, [A-3](#)

performance tuning, [9-40](#), [9-42](#)

physical disk
LED identifier, [10-42](#)

power cords
connecting, [3-8](#)

power supply
display details, [10-62](#)

R

RAID
display details, [10-61](#)

raidsyncstatus
display, [10-63](#)

re-imaging
bare metal, [6-17](#)

Real Application Clusters
See Oracle RAC

redundancy level
disk group
configurator, [2-8](#)

reimaging, [4-11](#)
bare metal, [6-17](#)
virtualized machine, [4-10](#)
virtualized platform, [4-11](#)

resource management
CPU pools, [9-40](#)
Oracle VM, [9-2](#)
supported virtual operating systems, [9-2](#)

restore, [4-10](#)

RMAN (Recovery Manager utility)
database management, [7-2](#)

S

SAP Application, [2-12](#)

SAS expander
display details, [10-60](#)

SCAN (single client access name), [2-7](#)
IP address, [2-10](#)
no NIS support, [2-7](#)

SCAN (single client access name) (*continued*)
 system configuration, [A-2](#)
 sending log files to Oracle Support Services,
[11-7](#)
 server
 display details, [10-64](#)
 shared repositories
 about, [9-4](#)
 architecture, [9-4](#)
 shared repository
 creating and managing, [9-7](#)
 delete, [10-35](#)
 deleting, [9-9](#)
 increasing the size, [9-10](#)
 show status, [9-8](#)
 starting, [9-8](#)
 stopping, [9-9](#)
 SI (Support Identifier)
 add to profile, [2-1](#)
 ASR requirement, [5-2](#)
 register, [1-2](#), [2-1](#)
 single client access name
 See SCAN
 single instance database
 convert to Oracle RAC or Oracle RAC One
 Node, [7-8](#)
 snapshot database, [7-7](#)
 software
 installation troubleshooting, [11-5](#)
 license registration, [2-1](#)
 Solaris x86
 and virtualization, [9-2](#)
 space management, [B-2](#), [B-6](#)
 SQL*Loader, [7-2](#)
 SRVCTL (server control utility)
 add and remove database, [7-3](#)
 start up the system, [3-9](#)
 storage, [8-1](#), [B-3](#), [B-4](#)
 show enclosure subsystem, [10-59](#)
 storage expansion
 command, [10-39](#)
 storage expansion shelf
 about, [3-5](#)
 adding, [3-4](#)
 storage planning, [2-7](#)
 support identifier
 See SI
 system requirements
 checklist, [2-6](#)

T

template
 database, [1-1](#)
 choosing, [C-1](#)

template (*continued*)
 database (*continued*)
 select, [2-5](#)
 virtual machine
 automatic unique naming, [9-13](#)
 unique name for each node, [9-13](#)
 templates, [C-1](#)
 database
 choosing, [C-3](#)
 Trace File Analyzer utility, [11-8](#)
 troubleshooting
 AoDB Linux installation tree, [11-5](#)
 expander, [10-60](#)
 hrd disk diagnostic tool, [11-8](#)
 log files for Oracle Support Services, [11-7](#)
 machine check exception, [11-5](#)
 network validation, [2-12](#)
 partitioning hard drive, [11-5](#)
 performance issues, [11-2](#)
 preinstallation deployment checks, [11-2](#)
 software installation, [11-5](#)
 system startup, [11-5](#)
 trace file analyzer, [11-8](#)
 turning on Oracle Database Appliance, [3-9](#)

U

upgrade database, [7-12](#)
 upgrading
 Oracle Database, [6-14](#)
 usable storage, [B-3](#), [B-4](#)

V

validation errors
 display, [10-65](#)
 names and addresses on the DNS, [2-12](#)
 validation failures
 display, [10-66](#)
 virtual disk
 attaching to a virtual machine, [9-12](#)
 cloning, [9-11](#)
 create, [10-30](#)
 creating, [9-10](#)
 delete, [10-35](#)
 deleting, [9-12](#)
 display details, [10-66](#)
 viewing information about, [9-11](#)
 virtual disks, [9-4](#)
 virtual IP address (virtual Internet Protocol
 address)
 Oracle RAC requirement, [2-10](#)
 subnet, [2-7](#)
 virtual local area network, [9-42](#)
 assigning to ODA_BASE, [9-44](#)

virtual local area network (*continued*)
 assigning to user domain, [9-44](#)
 create, [9-44](#)
 native, [9-44](#)
 on ODA_BASE, [9-44](#)
 on user domains, [9-44](#)
 removing from ODA_BASE, [9-44](#)
 removing from user domain, [9-44](#)

virtual machine
 about, [9-4](#), [9-28](#)
 assemblies, [9-4](#)
 caging, [9-39](#)
 display repository details, [10-63](#)
 high availability, [9-38](#)
 ODA_BASE caging, [9-39](#)
 open console, [10-70](#)
 pin, [9-39](#)
 template, [9-13](#)
 templates, [9-4](#), [9-28](#)

virtual machine (*continued*)
virtual machine templates
 importing, [9-15](#)
 listing, [9-14](#)

virtualization, [4-8](#), [4-11](#), [4-14](#), [9-2](#)

virtualized platform
 deploying, [4-14](#)
 deployment options, [2-2](#)

VLAN
 display details, [10-68](#)

VM Template
 downloading, [4-10](#)

vm templates
 display details, [10-70](#)

W

Windows
 and virtualization, [9-2](#)