

Oracle Utilities Network Management System

OMS for Water User's Guide

Release 2.4.0.0.0

E98856-01

December 2018

Copyright © 1991, 2018 Oracle and/or its affiliates. All rights reserved.

This software and related documentation are provided under a license agreement containing restrictions on use and disclosure and are protected by intellectual property laws. Except as expressly permitted in your license agreement or allowed by law, you may not use, copy, reproduce, translate, broadcast, modify, license, transmit, distribute, exhibit, perform, publish, or display any part, in any form, or by any means. Reverse engineering, disassembly, or decompilation of this software, unless required by law for interoperability, is prohibited.

The information contained herein is subject to change without notice and is not warranted to be error-free. If you find any errors, please report them to us in writing.

If this is software or related documentation that is delivered to the U.S. Government or anyone licensing it on behalf of the U.S. Government, then the following notice is applicable:

U.S. GOVERNMENT END USERS: Oracle programs, including any operating system, integrated software, any programs installed on the hardware, and/or documentation, delivered to U.S. Government end users are "commercial computer software" pursuant to the applicable Federal Acquisition Regulation and agency-specific supplemental regulations. As such, use, duplication, disclosure, modification, and adaptation of the programs, including any operating system, integrated software, any programs installed on the hardware, and/or documentation, shall be subject to license terms and license restrictions applicable to the programs. No other rights are granted to the U.S. Government.

This software or hardware is developed for general use in a variety of information management applications. It is not developed or intended for use in any inherently dangerous applications, including applications that may create a risk of personal injury. If you use this software or hardware in dangerous applications, then you shall be responsible to take all appropriate fail-safe, backup, redundancy, and other measures to ensure its safe use. Oracle Corporation and its affiliates disclaim any liability for any damages caused by use of this software or hardware in dangerous applications.

Oracle and Java are registered trademarks of Oracle and/or its affiliates. Other names may be trademarks of their respective owners.

Intel and Intel Xeon are trademarks or registered trademarks of Intel Corporation. All SPARC trademarks are used under license and are trademarks or registered trademarks of SPARC International, Inc. AMD, Opteron, the AMD logo, and the AMD Opteron logo are trademarks or registered trademarks of Advanced Micro Devices. UNIX is a registered trademark of The Open Group.

This software or hardware and documentation may provide access to or information about content, products, and services from third parties. Oracle Corporation and its affiliates are not responsible for and expressly disclaim all warranties of any kind with respect to third-party content, products, and services unless otherwise set forth in an applicable agreement between you and Oracle. Oracle Corporation and its affiliates will not be responsible for any loss, costs, or damages incurred due to your access to or use of third-party content, products, or services, except as set forth in an applicable agreement between you and Oracle.

Contents

Contents

| | |
|--|------------|
| Preface | -ix |
| Audience | -ix |
| Related Documents | -ix |
| Integration Guides | -ix |
| Conventions | -x |
| | |
| Chapter 1 | |
| Web Workspace | 1-1 |
| Getting Started with Web Workspace..... | 1-1 |
| Launching the Web Workspace and Logging In..... | 1-2 |
| Understanding the Web Workspace Window | 1-3 |
| Window Positioning and Sizing..... | 1-9 |
| Saving Workspace Preferences | 1-11 |
| Working with Tables | 1-12 |
| Sorting and Filtering Data | 1-14 |
| Printing | 1-19 |
| Taking Authority for Control Zones | 1-20 |
| Using the Authority Tool..... | 1-20 |
| Subscribing to a Control Zone | 1-22 |
| Subscribing to an Authority Group | 1-22 |
| Unsubscribing from a Control Zone | 1-22 |
| Searching for a Zone | 1-23 |
| Creating an Event | 1-23 |
| Using the Work Agenda | 1-24 |
| Opening Multiple Work Agenda Windows | 1-24 |
| Work Agenda Views..... | 1-24 |
| Work Agenda Menu and Toolbar Features | 1-25 |
| Work Agenda Data Fields | 1-29 |
| Using the Work Agenda Reading Pane | 1-33 |
| Acknowledging Events | 1-33 |
| Using the Viewer | 1-34 |
| Starting the Viewer..... | 1-34 |
| Understanding the Viewer..... | 1-35 |
| Displaying Asset Details | 1-43 |
| Viewing Asset Attribute Information from the Viewer..... | 1-44 |
| Viewing the Color Legend..... | 1-44 |
| Searching and Loading Viewer Maps..... | 1-44 |
| Navigating in the Viewer | 1-46 |
| Scaling Symbols and Text..... | 1-47 |
| Displaying Pointer Coordinates | 1-47 |
| Viewer Focus | 1-47 |
| Using Lens Windows..... | 1-48 |
| Real-Time and Study Mode | 1-48 |

| | |
|--|------|
| Selecting Assets | 1-49 |
| Identifying Symbology | 1-50 |
| Hiding and Displaying Viewer Objects | 1-51 |
| Executing Traces..... | 1-52 |
| Using the Commissioning Tool..... | 1-56 |
| Using the Save Case Management Tool..... | 1-59 |
| Using the Control Tool | 1-62 |
| Understanding the Control Tool..... | 1-62 |
| Operating Assets | 1-65 |
| Tagging Assets..... | 1-66 |
| Highlighting Events in the Work Agenda..... | 1-67 |
| Repredicting Upstream/Downstream | 1-67 |
| Viewing Documents Associated with an Asset..... | 1-67 |
| Adding Notes..... | 1-68 |
| Viewing Asset Attribute Information from the Control Tool..... | 1-69 |
| Toggling Call Display | 1-69 |
| Viewing Associated Customers..... | 1-69 |
| Viewing Customers..... | 1-69 |
| Using the Look Ahead Dialog | 1-70 |
| Associating Documents with Assets | 1-74 |
| Associating Damage Assessments to an Asset..... | 1-76 |
| Completing and Instructing Actions..... | 1-77 |
| Condition Summaries | 1-78 |
| Using the Condition Summaries Window..... | 1-78 |
| Toolbar and Menu Options..... | 1-79 |
| Using Condition Summaries Balloon Details | 1-81 |
| Editing or Deleting Conditions | 1-81 |
| Using the Alarms and Assets Lists..... | 1-82 |
| Menus and Toolbar..... | 1-82 |
| Abnormal Assets List | 1-84 |
| Asset Operations List..... | 1-84 |
| SCADA Alarms List..... | 1-84 |
| System Alarms List | 1-85 |
| Acknowledging Alarms | 1-85 |
| Silencing Alarms..... | 1-85 |
| Clearing Alarms from the List..... | 1-86 |
| Preventing an Asset from Reporting SCADA Alarms..... | 1-86 |
| Using the User Log | 1-87 |
| Menus and Toolbar..... | 1-87 |
| Adding Entries to the User Log | 1-89 |

Chapter 2

| | |
|---|------------|
| Web Trouble..... | 2-1 |
| Overview..... | 2-1 |
| Managing Events with Web Trouble..... | 2-1 |
| Event Details | 2-1 |
| Confirm Outages..... | 2-8 |
| Setting Work Queues..... | 2-11 |
| Associating and Unassociating Calls with Assets or Control Zones..... | 2-14 |
| Working with Damage Assessments..... | 2-15 |
| Updating the ERT for Selected Events | 2-22 |
| Setting the System-Wide Estimated Restoration Time | 2-22 |
| Clearing the System-Wide Estimated Restoration Time..... | 2-23 |
| Using the Event Log..... | 2-23 |
| Managing Crews with Web Trouble..... | 2-25 |

| | |
|---|------|
| Crew Actions | 2-26 |
| Displaying the Crew Gantt Chart..... | 2-34 |
| Crew Makeup..... | 2-35 |
| Crew Info | 2-37 |
| Active Job Info..... | 2-40 |
| Releasing Crews from an Event..... | 2-43 |
| Using Drag and Drop..... | 2-44 |
| Bulk Crew Loading and Deleting (Administrative Users) | 2-46 |
| Managing Calls with Web Trouble | 2-47 |
| Changing Rule Sets | 2-48 |
| Using the Trouble Info Window | 2-48 |
| Viewing Call Info | 2-54 |

Chapter 3

| | |
|--|------------|
| SCADA Extensions | 3-1 |
| Overview..... | 3-1 |
| SCADA Measurements | 3-2 |
| Using SCADA Features..... | 3-2 |
| Using the SCADA Summary | 3-3 |
| Understanding SCADA Information in the Viewer | 3-7 |
| Enabling/Disabling SCADA Measurements in the Viewer..... | 3-7 |
| Displaying SCADA Measurements with Asset Details..... | 3-8 |
| Remote SCADA Operation Warnings..... | 3-8 |
| Using SCADA Control Tool Features | 3-9 |
| Switching Management SCADA Integration..... | 3-10 |

Chapter 4

| | |
|--|------------|
| Web Switching Management..... | 4-1 |
| Overview..... | 4-1 |
| Operating Modes | 4-2 |
| Understanding Web Switching Management Windows | 4-2 |
| Overview | 4-2 |
| Web Switching Sheets..... | 4-3 |
| Switching Sheet Types..... | 4-3 |
| Switching Sheet States..... | 4-4 |
| Switching Sheet Window Components | 4-4 |
| Planned Switching | 4-11 |
| Creating a Planned Switching Sheet..... | 4-12 |
| Switching Sheet Requests..... | 4-14 |
| Changing the Switching Sheet State..... | 4-17 |
| Adding and Editing Steps | 4-21 |
| Reviewing a Switching Sheet in Study Mode | 4-45 |
| Replaying Steps..... | 4-45 |
| Implementing a Planned Switching Sheet..... | 4-45 |
| Working with Switching Sheet Versions | 4-51 |
| Viewing Impacted Customers..... | 4-53 |
| Checking for Overlaps | 4-57 |
| Saving and Loading View Areas | 4-59 |
| Viewing the Audit Log..... | 4-61 |
| Emailing Switching Sheet Data..... | 4-62 |
| Adding External Documents to a Switching Sheet | 4-63 |
| Opening an Existing Switching Sheet..... | 4-65 |
| Copying a Switching Sheet | 4-67 |
| Deleting a Switching Sheet | 4-68 |
| Emergency Switching..... | 4-69 |
| Switching Sheet List..... | 4-71 |

| | |
|---|-------|
| Menu and Toolbar Features | 4-71 |
| Switching Sheet List Data Fields | 4-75 |
| Opening Locked Documents | 4-75 |
| Stealing Locks | 4-76 |
| Event Associations..... | 4-76 |
| Hard Associations..... | 4-76 |
| Soft Associations..... | 4-77 |
| Rules for Grouping Event Associations..... | 4-77 |
| Crew Assignments..... | 4-77 |
| Working with Safety Documents..... | 4-78 |
| Understanding Safety Document Types..... | 4-78 |
| Mapping Step Types to Safety Document Types..... | 4-79 |
| Using Safety Documents in Switching Plans..... | 4-80 |
| Delegating Control of a Network Area..... | 4-91 |
| Safety Document List..... | 4-93 |
| Menu and Toolbar Features..... | 4-93 |
| Safety Document List Data Fields..... | 4-95 |
| Opening Existing Safety Documents..... | 4-95 |
| Completing Safety Documents..... | 4-96 |
| Aborting Safety Documents..... | 4-97 |
| Switching Sheet Associations..... | 4-97 |
| Outage Correction..... | 4-98 |
| Correcting Outages in a Rework Sheet..... | 4-98 |
| Using Outage Correction Sheets..... | 4-98 |
| Using the Miscellaneous Log..... | 4-99 |
| Displaying the Miscellaneous Log..... | 4-99 |
| Filtering the Log..... | 4-100 |
| Editing the Miscellaneous Log Steps..... | 4-100 |
| Viewing Global Overlaps..... | 4-100 |
| Web Safety..... | 4-101 |
| Understanding the Stand Alone Safety Document Window..... | 4-101 |
| Creating New Stand Alone Safety Documents..... | 4-105 |
| Using Stand Alone Safety Documents..... | 4-106 |

Chapter 5

| | |
|--|------------|
| Model Management..... | 5-1 |
| Overview..... | 5-1 |
| Logging In..... | 5-2 |
| Using the Model Management Window..... | 5-3 |
| Menu and Toolbar Options..... | 5-3 |
| Pending Map Section..... | 5-5 |
| Patches Section..... | 5-6 |
| Status Bar..... | 5-6 |
| Model Management Actions..... | 5-7 |
| Displaying Map History..... | 5-7 |
| Displaying the Preprocessor Log..... | 5-7 |
| Building Maps..... | 5-7 |
| Rebuilding a Patch..... | 5-8 |
| Displaying the Patch Build Log..... | 5-8 |
| Displaying the Patch Build Report..... | 5-8 |
| Enabling and Disabling Model Building..... | 5-8 |

Chapter 6

| | |
|---|------------|
| Configuration Assistant..... | 6-1 |
| Getting Started with the Configuration Assistant..... | 6-1 |
| Accessing Configuration Assistant..... | 6-1 |

| | |
|---|------|
| Logging In | 6-2 |
| Using Common Configuration Assistant Features | 6-3 |
| Using the User Administration Tab | 6-5 |
| Understanding the Current Users Panel..... | 6-5 |
| Understanding the User Type Memberships Panel | 6-8 |
| Understanding the User Log Panel | 6-10 |
| Using the Mobile User Administration Tab..... | 6-11 |
| Mobile Users..... | 6-11 |
| Current Keys..... | 6-11 |
| Permission Sets..... | 6-11 |
| Permissions | 6-12 |
| Using the Event Management Rules Tab | 6-13 |
| Event Management Rules Components..... | 6-13 |
| Working with Rules | 6-17 |
| Using the Event Details Options Tab..... | 6-19 |
| Event Details Options Panel..... | 6-19 |
| Using the Work Agenda Predefined Filters Tab | 6-23 |
| Adding a Filter..... | 6-24 |
| Editing a Filter..... | 6-24 |
| Deleting a Filter..... | 6-24 |
| Saving an Exported User Configuration | 6-25 |
| Using the State Transitions Tab..... | 6-25 |
| Viewing State Transitions | 6-26 |
| Using the Default Restoration Times Tab..... | 6-28 |
| Asset/Zone Default Restoration Times Pane | 6-28 |
| Adding an Asset/Zone-Based Default Restoration Time | 6-29 |
| Modifying an Asset/Zone-Based Default Restoration Time..... | 6-30 |
| Deleting an Asset/Zone-Based Default Restoration Time | 6-30 |
| Saving an Exported Default Restoration Time Configuration | 6-30 |
| Using the Customer Administration Tab | 6-31 |
| Menus and Toolbar..... | 6-31 |
| Setting Debug..... | 6-32 |
| Using the Customer Administration Weighted Priority Editor..... | 6-33 |

Appendix A

| | |
|----------------|-----|
| Acronyms | A-1 |
|----------------|-----|

Appendix B

| | |
|---|-----|
| Event Status and Event Type Codes | B-1 |
| Event Status Codes | B-1 |
| Event Type Codes | B-4 |

Appendix C

| | |
|------------------------|-----|
| Color Coding..... | C-1 |
| Crew Status..... | C-1 |
| Event Status..... | C-2 |
| Pipe Symbolology | C-3 |
| Callback Status | C-4 |
| | C-4 |

Appendix D

| | |
|--------------------------------|-----|
| Tool to User Type Matrix | D-1 |
|--------------------------------|-----|

Preface

This guide describes how to use the Oracle Utilities Network Management System. It provides instructions for completing common tasks and provides descriptions of the fields, windows, buttons, and menus you will use to perform those tasks. The instructions and descriptions in this guide are based on the default product configuration for a user with full authority to use all functionality. Because the system is highly configurable, your system may look and behave differently.

Audience

This document is intended for users of the Oracle Utilities Network Management System application.

Related Documents

For more information, see the following documents:

- *Oracle Utilities Network Management System Installation Guide*
- *Oracle Utilities Network Management System Quick Install Guide*
- *Oracle Utilities Network Management System Licensing Information User Manual*
- *Oracle Utilities Network Management System Configuration Guide*
- *Oracle Utilities Network Management System Adapters Guide*

Integration Guides

The following guides provide additional information for use when integrating with other Oracle Utilities applications.

- *Oracle Utilities Network Management System – Mobile Workforce Management Interface Implementation Guide*
- *Oracle Utilities Network Management System – Mobile Workforce Management Interface User Guide*

Conventions

The following text conventions are used in this document:

| Convention | Meaning |
|-------------------|--|
| boldface | Boldface type indicates graphical user interface elements associated with an action, or terms defined in text or the glossary. |
| <i>italic</i> | Italic type indicates book titles, emphasis, or placeholder variables for which you supply particular values. |
| monospace | Monospace type indicates commands within a paragraph, URLs, code in examples, text that appears on the screen, or text that you enter. |

Resources

[Appendix A - Acronyms](#) and [Appendix B- Event Status and Event Type Codes](#) provide lists of acronyms and statuses used in Oracle Utilities Network Management System.

Chapter 1

Web Workspace

This chapter describes the Oracle Utilities Network Management System Web Workspace application. It includes the following topics:

- [Getting Started with Web Workspace](#)
- [Using the Work Agenda](#)
- [Using the Viewer](#)
- [Using the Control Tool](#)
- [Condition Summaries](#)
- [Using the Alarms and Assets Lists](#)
- [Using the User Log](#)

Getting Started with Web Workspace

The **Web Workspace** is a real-time application that provides the tool sets and views that are the foundation of the Oracle Utilities Network Management System user environment. The common features and platform provided by the Web Workspace provide a cohesive user experience for the Oracle Utilities Network Management System application modules, such as Web Trouble Management or Web Switching Management. This section provides information on common Web Workspace features, including the following topics:

- [Launching the Web Workspace and Logging In](#)
- [Understanding the Web Workspace Window](#)
 - [Common Features](#)
 - [Menus and Toolbars](#)
 - [Annunciators](#)
- [Window Positioning and Sizing](#)
 - [Moving Windows](#)
 - [Adjusting Window Size](#)
- [Working with Tables](#)
- [Sorting and Filtering Data](#)
- [Printing](#)
- [Taking Authority for Control Zones](#)
- [Creating an Event](#)

Launching the Web Workspace and Logging In

Launching the Web Workspace

Depending on your system installation, Web Workspace is typically accessed by an URL (provided by your Oracle Utilities Network Management System implementation team) or through shortcuts installed on your desktop or in your application menu (such as the Microsoft Windows **Start** menu or Linux Applications menu). Use the installed shortcuts, if applicable, or open the URL in a web browser to launch the application. The Oracle Utilities Network Management System will begin downloading *Java* components of the Web Workspace to your computer. The Web Workspace Login window will open.

Logging In

1. To log in, enter the following information in the Login window:

User ID: enter the user name provided to you by your system administrator.

Password: enter the password provided to you by your system administrator.

Validate: click the **Validate** button to verify your login credentials.

Note: If your user name and password are not entered correctly, the system will display a "Login Error" message.

Once you have entered your user name and password, the **Validate** button will become activated.

2. Click **Validate** (or press **Enter** while in the password field) to validate your credentials.
3. Select **User Type** from the drop-down menu to determine what tools and functions will be available to you. See [User Types](#) on page 1-2 for more information.
4. Once the login criteria have been entered, click the **Login** button to complete the login process and open the Web Workspace. The Web Workspace *view* is based on the selected User Type.

Note: If two-factor authentication is enabled, the Two Factor Authentication dialog box will open. To request an authentication code, select a delivery method from the drop-down list, and then click **Request Code**. Once you receive the code, enter it in the **Code** field, and click **OK**.

5. The **Quit** button closes the Login window and exits the Network Management System.

User Types

User type determines which Web Workspace environment will be displayed when you log in.

- **Administration:** provides the full Web Workspace complement of tools with additional tools and functions to change operational parameters.
- **Crew Operations:** provides a limited workspace with only the tools necessary for crew administration functions.
- **Full Operations:** provides operational access to all Web Workspace tools.
- **Full Operations plus Switching:** provides operational access to all Web Workspace tools plus the Web Switching Management tools.
- **Trouble Maintenance:** provides a limited workspace with tools necessary for outage management functions.
- **Switching Request:** provides access to the Web Switching Request environment with only the tools necessary to create switching requests.
- **View Only:** provides read-only access to the operational environment.

Understanding the Web Workspace Window

Web Workspace features and functionality are accessed through menus and toolbar buttons. A particular configuration of a user type's environment determines whether a tool is displayed as a window when you first log in to the system.

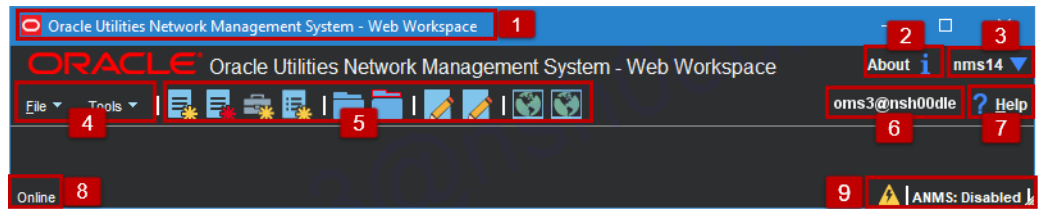

Web Workspace without any tools displayed.

Annotations:

- | | |
|-------------------------|----------------------------|
| 1. Title Bar | 6. Environment Information |
| 2. About Link | 7. Help Menu |
| 3. User Menu | 8. System Status Indicator |
| 4. File and Tools Menus | 9. Annunciators |
| 5. Toolbar | |

Common Features

There are several features that are common to nearly all Web Workspace windows:







- **Title Bars** display the name of the tool or dialog box.
- **Menus** provide access to tools and user actions. Menu options that are followed by an ellipsis [...] indicate that the option opens another window or dialog box.
 - **File** menu items typically start standard procedures (for example, printing or saving) and exit the window.
 - **Sort** and **Filter** menus allow you to modify how table data is sorted and filtered.
 - **Actions** menus provides access to features that are almost always specific to a particular window. Frequently used options on the Actions menu are often repeated as toolbar buttons.
 - **Help** menus provide access to information relevant to that window.
- **Toolbars** provide quick access to common functions. Toolbar buttons are used to perform an action or open a window. Button actions often correspond to **Action** menu options.
- **Right-Click Option Menus** provide many of the actions available through the Actions menus and toolbar buttons.
- **Annunciators** (or indicators) provide visual cues to system state or something that needs your attention.
- **Table columns** may be reordered by dragging the column (by its header) to a new position.

Menus and Toolbars









This section describes the menu and toolbar options. In the tables below, each menu item is listed along with submenu options, if available, and the default toolbar icon, if applicable; menu items without a default toolbar icon are indicated with a double dash (--) in the toolbar icon cell.

Note: Menu and toolbar options vary depending on your user type, your system configuration, and licensed products.

File Menu

| Menu Option | Submenu Option | Description | Toolbar Icon |
|-------------|---------------------------|---|---|
| New | Switching Sheet... | Opens the New Switching Sheet tool that allows you to create a new switching sheet based on switching event type (for example, planned or emergency). |  |
| | Safety Document... | Opens the New Safety Document tool that allows you to create a new safety document from a set of predefined types. |  |
| | Event... | Opens the Create Event tool that allows you to create a new outage, non-outage, or restored real outage event. |  |
| | Damage Assessment... | Opens a new Damage Assessment document window. See Creating Fuzzy Damage Assessments on page 2-29 for information. |  |
| Open | Switching Sheet... | Allows you to open a switching sheet. |  |
| | Switching Sheet Search... | Allows you to search for a switching sheet. By default, the search field searches against the switching sheet number and description fields. See Open Switching Sheet using Switching Sheet Search on page 8-65. | |
| | Safety Document... | Allows you to open a safety document. |  |
| | Safety Document Search... | Allows you to search for a safety document. By default, the search field searches against the safety document number and description fields. See From the Web Workspace Search Safety Document Dialog on page 8-92. | |

Tools Menu

| Menu Option | Submenu Option | Description | Toolbar Icon |
|-------------------------------|----------------|---|---|
| Work Agenda 1... | | Opens the Work Agenda. See Using the Work Agenda on page 1-25. |  |
| Work Agenda 2... | | Opens a second Work Agenda. |  |
| Viewer 1... | | Opens the Viewer. See Using the Viewer on page 1-36. |  |
| Viewer 2... | | Opens a second Viewer. |  |
| Authority... | | Opens the Authority tool, which grants control authority to users subscribing to discrete operations zones. See Taking Authority for Control Zones on page 1-21. | -- |
| Crews... | | Opens the Crew Actions tool, which shows the crews available in the subscribed control zone. See Managing Crews with Web Trouble on page 2-32. | -- |
| User Log... | | Opens the User Log, which displays a list of all single-user actions within a certain time period. See Using the User Log on page 1-93. |  |
| Manage Documents... | | Opens the Manage Documents window, which allows you to associate documents to objects. See Associating Documents with Assets on page 1-80. |  |
| Topology Validation Viewer... | | Opens the Topology Validation Viewer, which displays reports of a number of different common problem areas with a data model, such as de-energized supply points, loops, and faulted areas. See Topology Validation Viewer on page 20-1 for more information. | -- |
| Switching Overlaps... | | Opens the Global Overlaps tool. See Viewing Global Overlaps on page 8-100. |  |
| Miscellaneous Log... | | Opens the Miscellaneous Log. See Using the Miscellaneous Log on page 8-98. |  |

| Menu Option | Submenu Option | Description | Toolbar Icon |
|-------------------------------|---------------------------------|--|---|
| Condition Summaries... | | <p>Opens the Condition Summaries. Predefined filters include:</p> <ul style="list-style-type: none"> • All Conditions • Notes • Pending Construction • Pending Decommission • Tags <p>See Condition Summaries on page 1-84 for details.</p> |  |
| SCADA Summary... | | Displays the SCADA Summary. See Using the SCADA Summary on page 7-3 for more information. | -- |
| Alarms and Assets List | Abnormal Assets List... | Displays a list of off-nominal assets in the subscribed authority zones. See Abnormal Assets List on page 1-90. | -- |
| | Asset Operations List... | Displays all recent operations performed in the user's control zones. See Asset Operations List on page 1-90. | -- |
| | SCADA Alarms List... | Displays a list of all SCADA alarms in the subscribed authority zones. See SCADA Alarms List on page 1-90. | -- |
| | System Alarms List... | Displays a list of system alarms. See System Alarms List on page 1-91. | -- |
| | | | -- |

| Menu Option | Submenu Option | Description | Toolbar Icon |
|--------------|---|---|--------------|
| DMS Settings | FLISR Mode - Disabled - Manual - Automatic | Allows you to set the Fault Location, Isolation, and Service Restoration (FLISR) mode. See Setting the FLISR Mode on page 16-3. | -- |
| | Optimization Mode - Disabled - Manual - Automatic | Allows you to set the Optimization mode. See Setting the Optimization Mode on page 12-5. | |
| | FLM Status - Disabled - Enabled | Allows Administrators to set the Feeder Load Management status. See Feeder Load Management Overview on page 15-1. <ul style="list-style-type: none"> • Disabled: FLM forecasts have been disabled, usually due to a model build. Only real-time information will be displayed. • Enabled: FLM forecasts are currently enabled. | -- |
| | ANMS Status - Disabled - Manual - Automatic | Allows Administrators to set the Active Network Management Schemes (ANMS) global mode. See Understanding ANMS Modes on page 18-2 for more information. Note: you must be logged in as an Administrative user to see this option. | |

User Menu

The User Menu provides options to set preferences, transfer control of the session to another user, and log out of the Web Workspace.

Preferences Menu

The **Preferences** sub-menu allows you to control certain common features of the Web Workspace.

| Menu Option | Description |
|-------------------------------|---|
| Smaller Font | Decreases the font size in text and icons. Repeat to further decrease the font size. |
| Bigger Font | Increases the font size in text and icons. Repeat to further increase the font size. |
| Reset Font | The application will reset the text and icons to use their default font size. |
| Change Color Scheme... | Opens the Change Color Scheme dialog box, which allows you to select from different user interface coloring schemes. The options are a Light scheme, a Dark scheme, and the default High Definition scheme. Unlike other user preferences, these apply to all environments for the user on the machine. |
| Darken Watermarks | Make the watermarks more opaque. |
| Lighten Watermarks | Make the watermarks more transparent. |
| Show Watermarks | Check to turn on watermarks. See Watermarks on page 1-10. |
| Save Preferences | Saves the current settings as the user's preference. See Saving Workspace Preferences on page 1-12 for details. |
| Restore Preferences | Restores the environment preferences to the default settings. See Restoring Default Preferences on page 1-12 for information. |
| Audio Enabled | Un-check to turn off audible alarms. |
| Alarm Popups | Check to turn on popup alarms. |





| Menu Option | Description |
|---|-------------|
| Color Coding Options | |
| The color coding options determine how table data and related views are color coded in tools that support color coding of data. | |
| <ul style="list-style-type: none"> • Disable Coloring: disables table cell and row coloring. • Enable Cell Coloring: enables table cell coloring. • Enable Row Coloring: enables table row and cell coloring. | |

Help Menu

| Menu Option | Description |
|-------------------------------------|--|
| Web Workspace Help | Launches the online help system and loads the Web Workspace content. |
| Calculate Network Latency... | Runs a network diagnostic utility and returns the results in the Network connectivity results window. |
| Email Log Files... | Gathers the environment's log files and attaches them to a new email message using your default email client. The log files can then be sent to your support team or contact for further analysis. |
| Set Debug... | Launches the Set Debug dialog box allowing you to set debug on or off within your current environment. This is used for debugging and analysis purposes. See Setting Debug on page 10-33 for more information. |
| About Web Workspace | Opens a window with environment and software information. |

Annunciators

Annunciators, located in the bottom right corner of the Web Workspace window, are a combination of symbolic and text-based notifications of system statuses. In the base environment, annunciator alerts are displayed for the statuses listed below.

- **Unacknowledged Outage Events** (). See [Acknowledging Events](#) on page 1-35 for details on responding to new events.
- **Unacknowledged Non-Outage Events** (). See [Acknowledging Events](#) on page 1-35 for details on responding to new events.
- **Unacknowledged System Alarms** (). See [Using the Alarms and Assets Lists](#) on page 1-88 for details on viewing and acknowledging system alarms.

Note: Additional annunciators may be added on a per implementation basis.

Watermarks

Watermarks are used to show the environment that you are in. The semi-transparent text provides information about the system you are on. You may toggle watermarks on or off through the Preference menu, which also allows you to lighten or darken the watermark.

Window Positioning and Sizing

Web Workspace tool windows may be moved and sized in many ways within or outside of the Web Workspace primary window. The window positioning at startup is determined by the product or project configuration, but each user may move and size windows to support their workflow and preferences.

Moving Windows

To move a window, click the window tab and drag the window to the desired location either within the Web Workspace or on the desktop. When moving windows with the Web Workspace, the window can be docked to a side (top, bottom, left, or right) or to a tab connected to another pane.

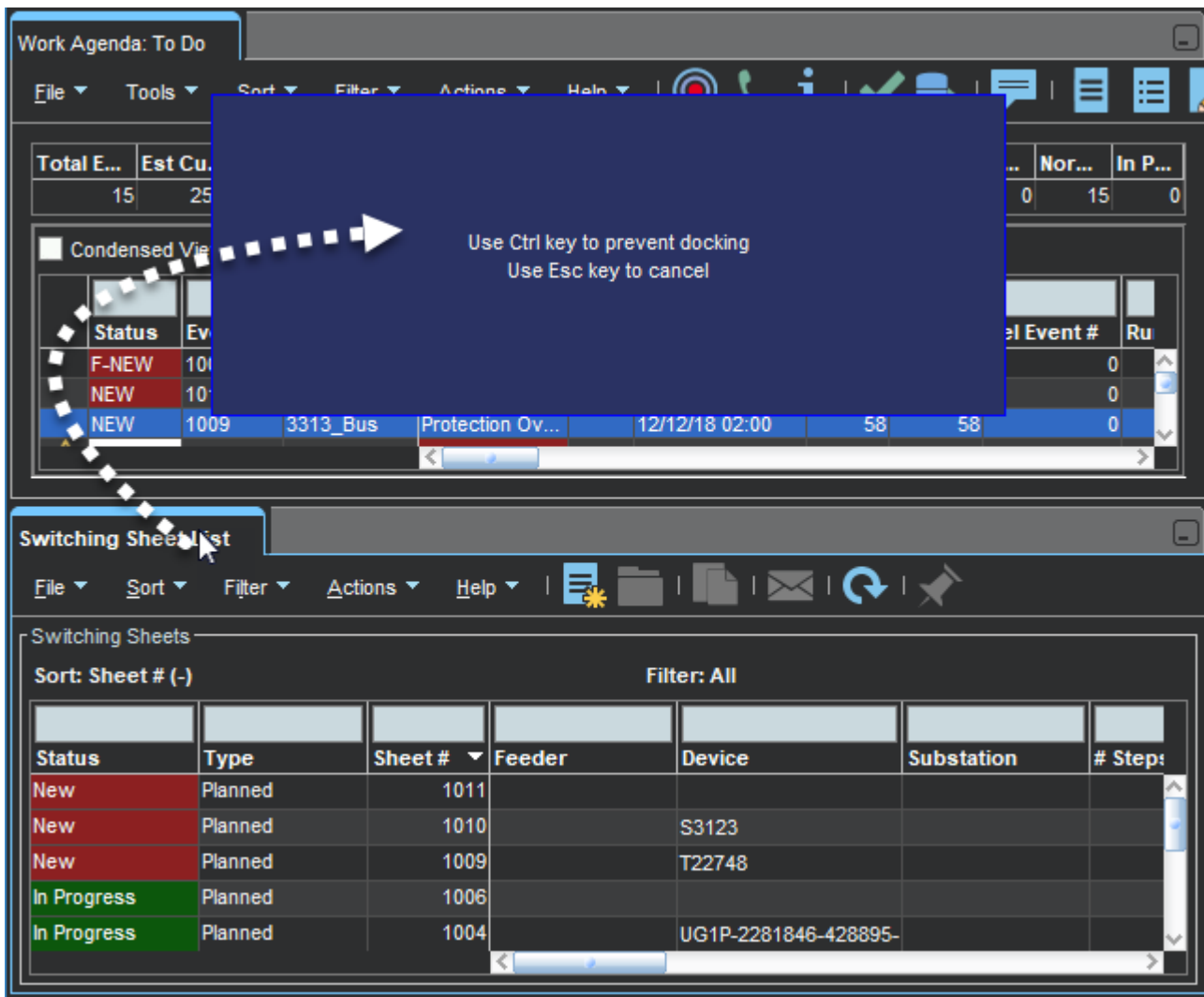

If you drop a window in the middle of an existing window, as shown above, it displays as a tab of the existing window:

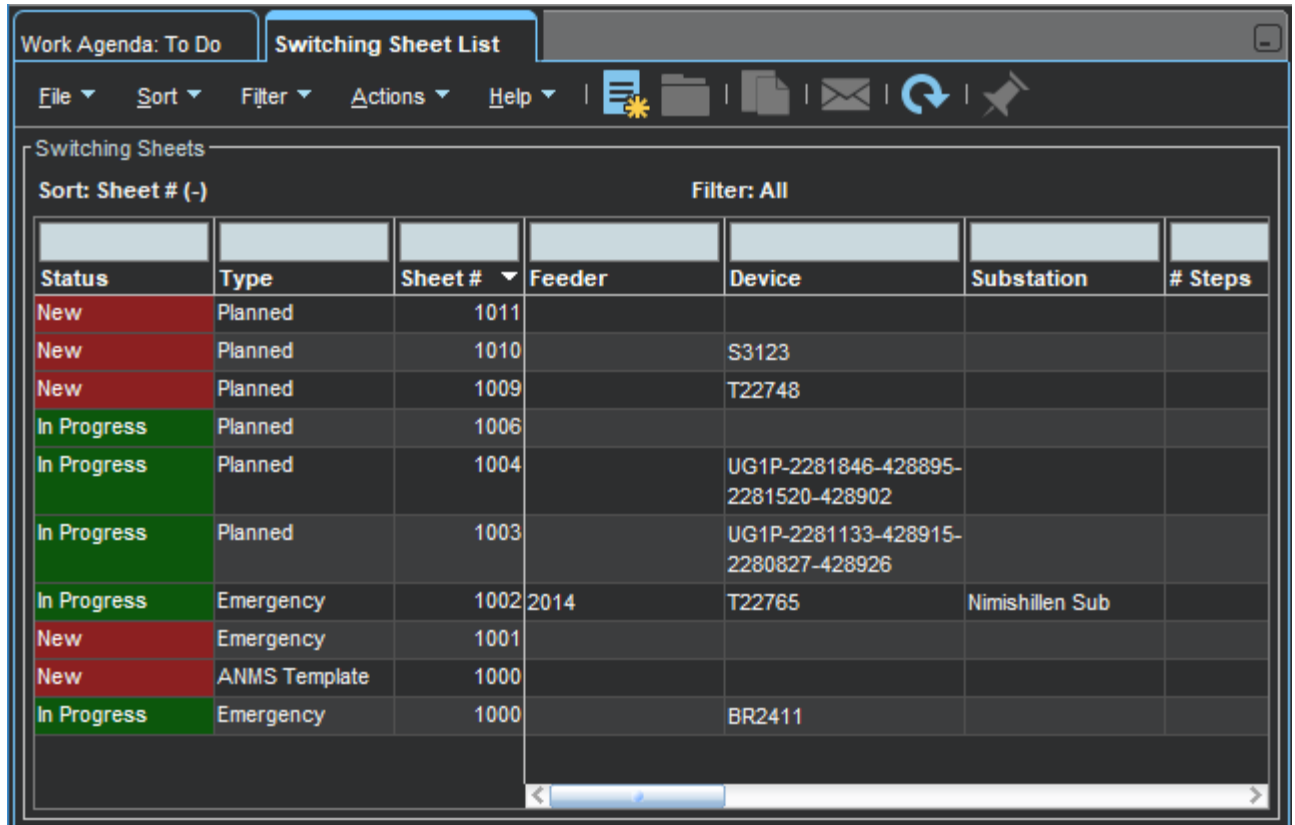

If you do not want a window (or window group) to dock to other windows or positions in the Web Workspace, drag the window away from other windows until it does not snap to a location; alternatively, press the **Ctrl** key as you release the mouse.

Adjusting Window Size

Resizing windows in NMS is equivalent to resizing an application window in Microsoft Windows or Linux. You may resize by clicking and holding a window edge and dragging until the window is the desired size; minimize by clicking the minimize button in the upper right corner of the window; maximize either by double-clicking the top of the window frame or by right-clicking and selecting **Maximize**. Depending on the windows state, right-click options will allow you to minimize, float, move, or dock the window. The Size right-click option displays the windows dimensions, in pixels.

Saving Workspace Preferences

Web Workspace starts with a standard configuration for window locations and sizes, font sizes, visible tools, and tool settings, such as column size and order. You can make adjustment to the workspace and then save those changes for future sessions.

To save your preferences, select **Save Preferences** from the Web Workspace **Preferences** menu.

Preferences are saved as follows:

Windows

The currently open windows are saved and reopened when you login. This feature is restricted to the following windows:

- Condition Summary
- Crew Actions
- Viewers (each Viewer is saved separately)
- Service Alarms
- SCADA Summary
- Work Agendas (each Work Agenda is saved separately)

Table Attributes

- Column widths
- Column ordering
- Locked columns
- Current sort
- Current filter

Non-Docked Window Attributes

- Size
- Placement (does not apply to dialog boxes)

Viewer Settings

- Unload on Focus
- Fixed Size
- Search Type
- Search Case
- Search Max Results
- Spatial Landbase
- Declutter
- Predicted Highlight Enable
- Pipe State Highlight

Note: To save user preferences for switching tools, each switching plan type (for example, emergency, planned, and so on) needs to be saved separately. Ensure that only one switch plan of each type is displayed when you save preferences.

Restoring Default Preferences

To restore the default environment settings, select **Restore Preferences** from the Web Workspace **Preferences** menu; the restored environment settings will take effect when you next log in.

Working with Tables

Selecting and Deselecting Rows

Many tables in Oracle Utilities Network Management System applications and tools allow multiple rows to be selected for a subsequent action, such as acknowledging new events in the Work Agenda or new system alarms in the Alarms and Assets Lists.

Selecting a Single Row

To select a row, click anywhere in the row; the row will change to the selected highlight color.

Selecting Contiguous Rows

To select contiguous rows, click the first row, press **Shift**, and then click the last row to select the anchors and all rows in between.

Selecting Noncontiguous Rows

To select noncontiguous rows, select the first row, press **Ctrl**, and then click each additional row.

Deselecting Rows

To deselect a row, press **Ctrl** and then click any cell in the row. The highlight color will be removed. Note that the cell may have a highlighted border, but it is not in a selected state.

Column Display Options

Tables may have the option to hide/unhide columns and to unlock columns that are set to be shown even when scrolling to the right. For example, in the image below, the first four columns are locked, and the horizontal scroll bar starts in the next column.

| Status | Event # | Feeder | DMS Status | E/H | Start Date | # Out | Still Out | Rel Event |
|---------|---------|--------------|------------------|-----|----------------|-------|-----------|-----------|
| F-NEW | 1006 | 2412_Bus | FLA Location... | | 12/12/18 00:40 | 0 | 0 | |
| NEW | 1017 | 2424 | | | 12/12/18 04:41 | 1 | 1 | |
| NEW | 1009 | 3313_Bus | Protection Ov... | | 12/12/18 02:00 | 58 | 58 | |
| ⚠ NFY | 1009 | 3313_Bus | Protection Ov... | | 12/12/18 02:00 | 58 | 58 | |
| NEW | 1008 | 2422 | Protection Ov... | | 12/12/18 01:58 | 272 | 272 | |
| ⚠ NFY | 1008 | 2422 | Protection Ov... | | 12/12/18 01:58 | 272 | 272 | |
| NEW | 1000 | 2413 | | | 12/11/18 23:04 | 1 | 1 | |
| NEW | 1013 | OPAL_Dies... | Protection Ov... | | 12/12/18 03:36 | 0 | 0 | |
| ⚠ NFY | 1013 | OPAL_Dies... | Protection Ov... | | 12/12/18 03:36 | 0 | 0 | |
| NEW | 1015 | 2412_Bus | | | 12/12/18 04:40 | 1 | 1 | |
| M-NEW | 1015 | 2412_Bus | | | 12/12/18 04:22 | 2209 | 2209 | |
| ✓ UAS | 1002 | 2014 | | | 12/11/18 23:18 | 8 | 8 | 1 |
| ✓ W-UAS | 1003 | UNKNOWN | | | 12/12/18 23:26 | 0 | 0 | 1 |
| ✓ W-UAS | 1004 | UNKNOWN | | | 12/11/18 23:33 | 0 | 0 | 10 |
| ✓ W-UAS | 1005 | UNKNOWN | | | 12/11/18 23:42 | 0 | 0 | 10 |
| NEW | 1012 | OPAL_Dies... | Dist Gen Over... | | 12/12/18 13:00 | 0 | 0 | |
| NEW | 1019 | OPAL_Dies... | Dist Gen TTL ... | | 12/12/18 23:37 | 0 | 0 | |
| ✓ UAS | 1021 | 2414 | | | 12/12/18 06:18 | 9 | 9 | |

Displaying Columns

Table columns can be hidden or unhidden by right-clicking the table header and selecting **Select Columns...** from the context menu. The dialog box displays all columns and you may show or hide columns by selecting or deselecting the check box, respectively.

Unlocking and Locking Columns

Locked table columns may be unlocked by right-clicking the table header and selecting **Unlock Columns** from the context menu. To lock columns, right-click the table header of the column you want to be the rightmost locked columns.

Copying Table Data

Many tables in Oracle Utilities Network Management System applications and tools allow data to be copied and pasted into other applications.

1. Select the row or rows to be copied.
2. Press **Ctrl+C** to copy the row data.
3. In the target application, such as a spreadsheet application, press **Ctrl+V** to paste the data.

Exporting Table Data

Many tables in Oracle Utilities Network Management System applications and tools allow data to be exported as comma separated values (csv) files. If the export option is available, it will typically be listed under the tool's File menu as **Export Table...** or the export table button () will be available from the toolbar.

Table Cell Tooltips

If a table cell's content is truncated, you may hover your mouse over the cell to see the full value.

Sorting and Filtering Data

You can sort many Web Workspace data tables to display rows in a particular order or filter them to display a specific subset of the rows. Some of the Web Workspace tools also allow you to create your own user-defined sorts and filters. These options, if available, will be found in the tool's Sort and Filter menus or from an context menu when you right-click on the column heading.

Sorting

You can apply ascending or descending sorts to a single column in a table (where configured) by clicking once on the column header; clicking a second time on the column header will sort the rows in the opposite order. An arrow appears next to the column label identifying if the sort is ascending or descending.

Sort topics include:

- [Using the Sort Dialog](#)
- [Creating a User-Defined Sort](#)
- [Editing and Deleting Saved Sorts](#)

Using the Sort Dialog

Some Web Workspace tools allow you to create, modify, apply, and save user-defined sorts. Sorts are saved for each application, user, and user type. Thus, if a user logs in with multiple user types, each type will have their own set of sorts.

If a table supports user-defined sorts, select **Sort Dialog...** from the Sort menu or click the **Sort** button on the toolbar to display the Sort Dialog. You can also right-click the table header and then select **Sort...** from the context menu.

The Sort Dialog displays the following items:

- The **Current Sort** drop-down menu presents a list of saved sorts for modification. When you select a sort from the list, the sort criteria are displayed.
- The table within the dialog box allows you to specify the order in which the sort criteria is applied, which column in the application is to be used in the sort criteria, and in which direction the sort is to be applied (ascending, descending).
- The **OK** button applies the current sort to the table of data and exits the Sort dialog box.
- The **Save...** button opens a dialog box for naming and saving the current sort. Saving automatically applies the sort. You can retrieve sorts through the option menu on the Sort Dialog and the Sort menu in the window.
- The **Delete** button opens a dialog box asking you to confirm the deletion of the selected sort. Once it is deleted, you can no longer retrieve the sort.
- The **Show** button applies the current sort settings to the table of data, but does not exit the Sort Dialog.
- The **Help...** button display help for using the Sort Dialog.
- The **Exit** button closes the Sort Dialog.
- The **Current Sort** drop-down presents a list of saved sorts for modification.

Creating a User-Defined Sort



To create a user-defined sort, complete these steps:

1. Open the Sort Dialog by selecting **Sort Dialog...** from the Sort menu or by right-clicking the table header and selecting **Sort...** from the context menu.
2. In the row for Order 1, click on the drop-down menu under **Column** and select the first column you wish to sort by, and then click on the drop-down menu under **Direction** and select which order you wish to sort the column by.
3. Repeat the previous step for any other columns you additionally want to sort by.
4. Click the **Save...** button. The Store the Sort? dialog box appears, prompting you to name the sort.
5. Click the **Yes** button. The Store the Sort? dialog box appears, and the name you provided now appears in the option menu of saved sorts.
6. Click the **OK** button. The Sort Dialog closes, and the sort is saved to the database.

Editing and Deleting Saved Sorts

You can use the option menu in the Sort Dialog to select a saved sort for modification. You can also delete a saved sort by selecting it from this menu and clicking on the **Delete** button.

Quick Sorting

You can sort the contents of a list by clicking on a column header. An icon indicates that the column is being sorted; ascending () or descending () order.

Filtering

In addition to sorting, certain windows allow you to filter the data displayed. Filtering topics include:

- [Using the Filter Dialog](#)
- [Creating a User-Defined Filter](#)
- [Editing and Deleting Saved Filters](#)
- [Dynamic Filtering](#)
- [Auto Filtering](#)

Using the Filter Dialog

The Filter Dialog is used to create, modify, apply, and save user-defined filters. User-defined filters are only accessible to the user who creates them and are erased when the user logs out unless they have been saved; to save, select **Save Preferences** from the Web Workspace **Preferences** menu.

To display this dialog box, select **Filter Dialog...** from the Filter menu. You can also right-click on the table header, and select **Filter...** from the context menu.

The Filter Dialog displays the following items:

- The **Current Filter** drop-down menu presents a list of saved filters for modification. When you select a filter from the list, the filter criteria are displayed.
- **Filter Criteria**
 - **Column Name** displays the name of each column available in the table of data you are filtering.
 - The **Operator** column displays the type of filter.
 - The **Match Value** field is the value you want to filter by. For example, to show only data for the current day, you would set the Type to Match and the Value to the current date.
- **Actions**
 - **Save...** opens a dialog box for naming and saving the current filter. Saving automatically applies the filter. You can subsequently retrieve saved filters through the Current Filter option menu and the Filter menu in the window.
 - **Delete** opens a dialog box asking you to confirm the deletion of the selected filter. Once it is deleted, you can no longer retrieve the filter.
 - **Apply** applies the current filter settings to the table of data, but does not exit the Filter Dialog.
 - **Help...** displays help for the Filter Dialog.
 - **Exit** closes the Filter Dialog and removes any applied filter settings.

Creating a User-Defined Filter

To create a user-defined filter, complete these steps:

1. Open the Filter Dialog by selecting **Show Filter Dialog** from the Filter menu or by right-clicking the table header and selecting **Filter...** from the context menu.
2. Click on the **Operator** drop-down menu of a column you want to filter by and select the option you want.

Operators

| Option | Description |
|--------------------|---|
| any | No filter is applied to this field. |
| match | Table rows display only if the field value exactly matches the filter value. |
| like | Table rows display if the field value includes the some part of the filter value (for example, "Status" includes "tat"). like may also be used with Perl-style regular expressions. Examples: <ul style="list-style-type: none"> • To find values that match either X or Y, select like and enter X Y in the Match Value field. • To find values that match X and Y, select like and enter (?=.*X)(?=.*Y) in the Match Value field. <p>Note: There are many regular expression references, including books, web sites, and tutorials. For example: http://www.regular-expressions.info/tutorial.html.</p> |
| not like | Table rows display only if the field value does not include the filter value (for example, "Status" does not include "tot"). |
| multi-match | Matches with multiple arguments. Multiple filter values may be entered in the same field, separated by spaces. |
| not | Table rows display only if the field value does not match the filter value. |
| multi-not | Not with multiple arguments. Multiple filter values may be entered in the same field, separated by spaces. |
| >= | Greater than or equal to. Table rows display only if the field value is greater than or equal to the filter value. |
| <= | Less than or equal to. Table rows display only if the field value is less than or equal to the filter value. |

3. In the **Match Value** column next to the selected **Operator**, enter the desired filter value.
4. Repeat the two previous steps for any other columns you want to filter by.
5. Click **Save**. A dialog box appears, prompting you to name the filter.
6. Type a name into the field and click **Yes**. The table is filtered according to the selected criteria, and the Filter field above the table now displays the name of your newly created filter.

Note: You can view the filter by clicking on the **Apply** button, but if you click **Exit**, the applied filter will be undone before the dialog box closes.

Editing and Deleting Saved Filters

You can use the Current Filter drop-down menu in the Filter Dialog window to select a saved filter for modification. You can also delete a saved filter by selecting it from this menu and clicking on the **Delete** button.

Dynamic Filtering











Some tables provide a row of blank filter boxes above the column headers. Enter all or part of the text you want to filter by in the appropriate filter box. The table data is dynamically filtered to display items that contain matching values as you enter the filter criteria. You can combine filter criteria by typing values in more than one column.

Auto Filtering

Some tables support auto filtering (also referred to as cell filtering), which allows you to filter the list by the value of any cell. To use auto filtering, right-click a cell containing the value you want to filter, and select the **Toggle Auto Filter** option. (When enabled, the menu option is checked.) The table is refreshed to display only rows where the value matches the selected cell. For example, if you click a cell in the Pressure Zone column with a value of "2413" and enable auto filter, the table will refresh to display only events for Pressure Zone 2413. Click the option again to turn off cell filtering.

Printing

Printing is an option from several of the Web Workspace and Web Trouble windows. The Print Preview dialog box appears whenever one of the printing options is selected in Web Workspace or Web Trouble. The following table describes the buttons on the Print Preview dialog box.

| Button | Description |
|---|---|
|  | Used to preview the previous page in a multi-page output. |
|  | Used to preview the next page in a multi-page output. |
|  | Used to zoom out on the contents of the preview. |
|  | Used to zoom in on the contents of the preview. |
|  | Used to scale out the font used for the print output. |
|  | Used to scale in the font used for the print output. |
|  | Toggles the page orientation of the output between portrait and landscape. |
|  | Brings up the Page Setup dialog box, which allows you to select paper size and source, set page orientation, set margins, and select the printer. |
|  | Reverts the preview window back to its default settings. |
|  | Sends the print output to your selected printer, and then closes the Print Preview dialog box. |
| Close | Closes the Print Preview dialog box without printing any output. |

Setting Print Margins

The Print Preview dialog box also allows you to set the margins of the output interactively. Follow these steps:

1. Position your cursor over the preview output until you see a red outline and your cursor becomes a double-headed arrow.
2. While the cursor is a double-headed arrow, click and hold your left mouse button and drag the red line to the desired location.

Taking Authority for Control Zones

The Authority tool is used to manage permissions to view data and perform operations in the operations network. Permissions are granted to operate in *Control Zones*, which are discrete sections of a utility's distribution system. *Control Groups* are groups of control zones. You must subscribe to a control zone or a zone group to see events, manage crews, or perform asset operations in that section. Once subscribed, you can examine and change the assignment of control zones, view control areas within the distribution system, and identify which users have authority over each section. This section provides information on using the **Authority tool**, including the following topics:

- [Using the Authority Tool](#)
- [Subscribing to a Control Zone](#)
- [Subscribing to an Authority Group](#)
- [Unsubscribing from a Control Zone](#)
- [Searching for a Zone](#)

Using the Authority Tool

If the Authority tool is not visible in the Web Workspace, select **Authority...** from the Web Workspace **Tools** menu.

Authority Tool Fields

The Authority tool has the following fields:

- The **Zones** area displays control zones or control groups.
- **Zone Users** displays the users that are currently subscribed to the selected control zone. If no user is subscribed to the selected control zone, the Zone User will be **system**.
- **Control Zone** displays the currently selected control zone.
- **Rule Set** displays the rule set currently being used.

Note: Rule Sets are operating conditions, such as *Normal* or **Storm**, that are typically set by Administrators or Shift Supervisors.

Authority Tool Menus



File Menu

| Menu Option | Description | Toolbar Icon |
|-------------|-----------------------------------|--------------|
| Exit | Closes the Authority tool window. | -- |

Filter Menu

| Menu Option | Description | Toolbar Icon |
|--------------------|---|---------------------|
| All Zones | Shows all Control Zones in the tree structure. | -- |
| My Zones | Shows all Control Zones controlled by you. | -- |
| Users' Zones | Shows Control Zones that are controlled by users/operators. | -- |
| System Zones | Shows control zones that are controlled by the System. | -- |
| Zone Groups | Shows the Zone Group table, which allows you to subscribe to or view zone groups. | -- |



Actions Menu

| Menu Option | Description | Toolbar Icon |
|--------------------|---|---|
| Subscribe... | Opens the Subscribe window that allows you to subscribe to Control Zones or Control Groups. |  |
| Unsubscribe... | Allows you to unsubscribe from subscribed control zones. |  |
| Zone Search | Allows you to search for a control zone in the control hierarchy. |  |
| Change Rule Set... | Allows you to change the operations rule set. | -- |

Help Menu

| Menu Option | Description | Toolbar Icon |
|--------------------|--|---------------------|
| Authority Help | Opens the online help system to the Authority tool help content. | -- |

Subscribing to a Control Zone

With the Authority tool filter set to All Zones, the Authority tool lists all control zones in a hierarchical tree view. You may subscribe to an individual control zone, which is represented by a page icon () , or a zone collection, which is represented by a folder icon ().

To subscribe to one or more control zones, complete these steps:

1. Expand the list of Control Zones to locate the zone you want to control.
2. Select the row for the zone or zone folder. The zone will populate the Control Zone field.
 - To select multiple adjacent zones, press **Shift** and click the first and last zones to select all of the zones in that range; to select multiple non-adjacent zones, press **Ctrl** and click each zone individually.
3. Click the **Subscribe** button () , select **Subscribe...** from the **Actions** menu, or right-click and select **Subscribe...** from the context menu. The Subscribe dialog box opens.
4. Click **Subscribe** in the dialog box. You are now subscribed to the selected zones.

Subscribing to an Authority Group

To subscribe to a Authority Group, first select Zone Groups from the Authority tool's Filter menu to view the Authority Group table and then complete these steps:

1. Select one or more rows from the Authority Group table. If the list of Authority Groups is long, you may use the filter box above the Authority Group title to find the desired group.
2. Click the **Subscribe** button () , select **Subscribe...** from the **Actions** menu, or right-click and select **Subscribe...** from the context menu. The Subscribe dialog box opens.
3. If applicable, deselect any control zones in the Authority Group that you do not wish to subscribe to.
4. Click **Subscribe**. You are now subscribed to the selected zones.

Unsubscribing from a Control Zone

When you are finished working in a control zone, you can unsubscribe from the control zone.

Note: Remember that you are automatically unsubscribed to all of your control zones when you logout.

To unsubscribe, complete these steps:

1. Select **My Zones** from the Filter menu.
2. Select the row containing the zone that you want to unsubscribe from. The zone will populate the Control Zone field.
3. Click the **Unsubscribe** button () to open the Unsubscribe dialog box.

Note: Alternatively, you may select **Unsubscribe...** from the **Actions** menu or select **Unsubscribe...** from the context menu.

4. Click **Unsubscribe**. You are now unsubscribed from the zone.

Searching for a Zone

The Search feature can help you locate a control zone more quickly than expanding and viewing zones in the Authority window. To search for a zone, complete these steps:

1. In the Authority window, click the **Zone Search** button () in the toolbar or select **Zone Search...** from the **Actions** menu. The Search Tool dialog box opens.
2. Enter the name or first part of the name of the control zone in the Zone field and then click the **Find Next** button. The search is not case-sensitive, but you must match exactly in your typing of spaces, hyphens, and so on. If the system finds a match, the list of control zones expands and that zone is highlighted.
3. If there are multiple matches, click **Find Next** to locate the next control zone that matches your search criteria.
4. When you locate the zone you want, click the **Cancel** button to close the Search Tool dialog box.

Creating an Event

If a crew in the field discovers an event that has not been identified by a customer, you may use the **Create Event** tool to add the event to the NMS.

To open the Create Event window, select **New** and then **Event...** from the Web Workspace **File** menu. Alternatively, you may click the Web Workspace new event button ()

The Create Event window displays the following fields and buttons:

- The **Selected Asset** field displays the name of the asset on which to create the event.
- The **Event Began** field allows you to enter the date and time when the event began.
- The **Event Type** selection allows you to designate whether the event should be created as a Probable Asset Outage, Non-Outage, or Restored Real Outage.
- The Restored Real Outage Options panel allows you to add the restored time to a restored real outage event. The **Create Switching Sheet** check box allow you to create an emergency switching sheet for the restored outage (see [Emergency Switching](#) on page 8-68 for information on emergency switching sheets).
- The **OK** button creates the new event on the selected asset and closes the Create Event window.
- The **Help...** button displays help for the current window.
- The **Cancel** button closes the Create Event window without creating a new event.

Using the Work Agenda

The Work Agenda displays event (or work) data. These events vary based on the modules and interfaces that have been implemented, but may include switching actions (with Switching Management), outage events (with Outage Management), and so on. Events may be in various states, such as *New*, *In Progress*, *Incomplete*, or *Complete*.

This section includes the following topics:

- [Opening Multiple Work Agenda Windows](#)
- [Work Agenda Views](#)
- [Work Agenda Menu and Toolbar Features](#)
- [Work Agenda Data Fields](#)
- [Acknowledging Events](#)

Opening Multiple Work Agenda Windows

You can open more than one Work Agenda. To open a new Work Agenda, select the **Work Agenda 1** or **Work Agenda 2** option from the Web Workspace **Tools** menu. The new Work Agenda displays as a tab next on the Web Workspace window, to the right of any existing Work Agenda tabs.

When you select a row in one Work Agenda window, the system automatically selects the row for that event in all other Work Agendas (if the row is not being filtered).

All Work Agendas are subscribed at the same level as the original Work Agenda and other tools, but can have their own dynamic sorts and filters applied. The selected events are shared across the Work Agendas.

Work Agenda Views

Work Agenda *views* are filters based on event type and/or status. These filtered views are referred to as *lists* and the list name is displayed on the Work Agenda tab. For example, in the standard NMS product offering, the Web Workspace starts with Work Agenda open in the **To Do** list view, which displays all new and unassigned events that require attention, and the tab is labeled "Work Agenda: To Do."

Note: The Work Agenda does not display any events until you take authority of a control zone (see [Taking Authority for Control Zones](#) on page 1-21).







Each row of the Work Agenda contains information about an event. A summary row at the top of the Work Agenda displays summary counts for all of the events listed in the current view.

The Work Agenda is configured with several different views that can be selected through the Filter menu or toolbar icons.



Work Agenda Menu and Toolbar Features

This section lists and describes the menu options and toolbar icons available in the Work Agenda.

File Menu - The table below describes the options available on the File menu.

| Menu Option | Description | Toolbar Icon |
|-------------------------------|---|---|
| Export Table... | Opens a dialog box that allows you to save the current table view data to a comma separated value (csv) file. |  |
| Print | Displays the Print Preview dialog box so you can view or print the list. |  |
| Print Reading Pane | Displays the Print Preview dialog box so you can view or print the Reading Pane. |  |
| Print Preview Calls... | Opens the Report dialog box that allows you to choose a preview type (for example, PDF, HTML, and so on); click Preview.... to display the calls report for the highlighted rows. |  |
| Print Calls... | Opens the Report dialog box that allows you to choose a report type (for example, PDF, HTML, and so on) and printer for the highlighted rows; click Print to send the report to the selected printer. |  |
| Email Calls... | Opens the Report dialog box that allows you to choose the type of report (for example, PDF, HTML, and so on) to be generated for each highlighted row; click Email... to attach the calls to a new email message (using your default email application) that may then be sent to your chosen recipients. |  |
| Exit | Closes the Work Agenda window. | -- |

Tools Menu - The table below describes the options available on the Tools menu.



| Menu Option | Description | Toolbar Icon |
|-------------------------|--|---|
| View... | Opens Viewer 1 if not already open, and then focuses Viewer 1 on the asset from the selected Work Agenda row. |  |
| Trouble Info... | Opens the Trouble Info window with information about the selected event. |  |
| Event Details... | Opens the Event Details window with information about the selected event. |  |
| Event Log... | Opens the Event Log window for the selected event. | -- |
| Switching... | Opens the Open or Create New Switching Sheet dialog box, which allows you to create a new switching sheet or open a switching sheet associated with the selected event. See Open or Create New Switching Sheet on page 8-68 for more information. | -- |



| Menu Option | Description | Toolbar Icon |
|-----------------------------|---|--------------|
| Damage Assessment... | Opens the Damage Assessments tool, which displays a list of damage assessments associated with the selected event and allows you to add additional damage assessments. See Using the Damage Assessments Tab on page 2-12. | -- |
| Show AMI Request... | Displays a list of active and completed AMI requests for the selected event. | -- |

Sort Menu - The table below describes the options available on the Sort menu.

| Menu Option | Description | Toolbar Icon |
|-----------------------|--|--------------|
| Sort Dialog... | Opens the Sort Dialog, allowing you to create, modify, apply, and save user-defined sorts. See Using the Sort Dialog on page 1-15. | -- |
| Default | Applies the default sort. | -- |



Filter Menu - The table below describes the options available on the Filter menu.



| Menu Option | Description | Toolbar Icon |
|-------------------------|--|---|
| Outages | Displays all outage events. | -- |
| Non Outages | Displays all non-outage events. | -- |
| Both | Displays both outage and non-outage events. | -- |
| Filter Dialog... | Opens the Filter Dialog where you can create, modify, apply, and save user-defined filters. See Using the Filter Dialog on page 1-17. | -- |
| All | Displays all events of any status. Note: Statuses are displayed in the Work Agenda Status column; see Event Status Codes on page B-1 for a complete list of status codes and descriptions. |  |
| Completed | Displays all completed and cancelled trouble events. Statuses: CMP, P-CMP, S-CMP, W-CMP, CNL, S-CNL, and W-CNL. Note: See Event Status Codes on page B-1 for event status descriptions. |  |
| Default | Applies the filter for the currently selected view. | -- |

| Menu Option | Description | Toolbar Icon |
|--------------------|---|---|
| In Progress | <p>Displays most trouble events that have crew resources associated with them and any trouble event alarms.</p> <p>Statuses: ASN, S-ASN, W-ASN, ENR, S-ENR, W-ENR, S-ONS, W-ONS, NFY, ONS, RSCH, RST, S-RST, SUS, S-SUS, W-SUS, and VFY.</p> <p>Note: See Event Status Codes on page B-1 for event status descriptions.</p> |  |
| Incomplete | <p>Displays all incomplete trouble events and events that have maintenance work pending. Incomplete events are events that are complete in the field but still require that Managing Crews with Web TroubleEvent Details be completed.</p> <p>Statuses: INC, P-INC, S-INC, MNP, and S-MNP.</p> <p>Note: See Event Status Codes on page B-1 for event status descriptions.</p> |  |
| Switching | <p>Displays all events that have an associated planned switching sheet in a Scheduled (or later) status.</p> | -- |
| To Do | <p>Displays trouble events that require attention and any trouble event alarms.</p> <p>Statuses: CRT, C-CNL, NEW, P-NEW, S-NEW, NFY, RED, RSCH, SNT, P-SNT, S-SNT, W-SNT, UAS, P-UAS, S-UAS, W-UAS, VFY</p> <p>Note: See Event Status Codes on page B-1 for event status descriptions.</p> |  |

Actions Menu

The table below describes the options available on the Actions menu. It also indicates whether the option displays in a context menu when you right-click a row in the Work Agenda.

| Menu Option | Description | Toolbar Icon | Right-Click Y/N |
|-----------------------|--|---|-----------------|
| Acknowledge | Acknowledges the selected event. |  | Y |
| Work Queues... | Opens the Work Queues dialog box, allowing you to select work groups to refer the event to and enter any necessary notes. |  | Y |
| Send to Mobile | Changes the event status to a Sent status that is appropriate for the selected event (for example, SNT, S-SNT, P-SNT, W-SNT). Also, if the Sent to Mobile column value happens to be <i>N</i> at the time the Send to Mobile button is pressed, it will update to a value of <i>Y</i> . | -- | N |
| Update ERTs... | Opens the Update ERT dialog box so you can enter a new ERT (Estimated Restoration Time) for all selected events. | -- | N |

| Menu Option | Description | Toolbar Icon | Right-Click Y/N |
|-------------------------------------|--|---|-----------------|
| System-Wide Default ERT... | Opens the System-Wide Default ERT dialog box, which allows you to view and modify the system-wide default restoration time value. (Use the Configuration Assistant to set restoration times for specific control zone-asset class combinations.) | -- | N |
| Associate Event... | Allows you to associate the selected fuzzy event to an asset. | -- | N |
| Group Events... | Opens the Group Events dialog box, which allows you to manually merge, relate, and un-relate events. | -- | N |
| Undo Grouping | Ungroups and repredicts all calls from an event. It may be used to undo the results of manual grouping or repredict upstream/downstream. This action is not allowed for events with crews. See Ungroup Events on page 2-23. | -- | N |
| Update Events... | Opens the Update Events dialog box, which allows you to update multiple Event Details fields for the selected events. See Using the Update Events Window on page 2-16. | | Y |
| Update All Related Events... | Opens the Update Events dialog box, which allows you to update multiple Event Details fields for all events related to the selected event. See Using the Update Events Window on page 2-16. | | Y |
| Confirm Outages... | Opens the Confirm Outages dialog box, which allows you to confirm secondary or service outages for customers associated with event assets. | -- | Y |
| Release Crews... | Opens the Release Crews dialog box, which allows you to release assigned en route or onsite crews from an event. See Releasing Crews from an Event Selected in the Work Agenda on page 2-49 for more information. | -- | Y |
| Cancel Event... | Cancels the selected event. A dialog box opens prompting you for a reason for the cancellation. |  | Y |
| Incomplete | Changes the status of the event to an Incomplete status that is appropriate for the selected event (for example, INC, S-INC, P-INC). | -- | N |
| Reading Pane | Splits the Work Agenda table to display a panel with the selected row's details. | | N |
| Show Event Note Balloon | Enables a balloon dialog box that displays event notes, if they exist. |  | Y |

| Menu Option | Description | Toolbar Icon | Right-Click Y/N |
|---|--|--------------|-----------------|
| Toggle Auto Filter | Allows you to quickly filter the table by the selected cell value. | -- | Y |
| Find Selection | Scrolls the currently selected event back into view should it scroll off of the list. | -- | N |
| Load Completed Events | By default, completed events are not loaded into the Work Agenda on startup for performance reasons. This action will open the Load Completed Events dialog box. | -- | N |
| Load Completed Events - Range... | Opens the Load Completed Events - Range dialog box, which allows you to filter completed events by a start and end date. Note: the total number of events returned is bounded by the <code>RULE_VALUE_INTEGER_1</code> field of the <code>completedRetainPeriodSRS</code> Rule. See the Using the Event Management Rules Tab on page 10-13 for more details. | -- | N |
| Load Completed Event... | Opens the Load Completed Event Dialog, which allows you to load a specific completed event by specifying its Event number (index). | -- | N |
| Cancel Callbacks | Cancels callback requests for selected event. | | N |

Help Menu - The table below describes the options available on the Help menu.

| Menu Option | Description | Toolbar Icon |
|-------------------------|--|--------------|
| Work Agenda Help | Opens the online help system to the Work Agenda tool help content. | -- |

Work Agenda Data Fields

The Work Agenda displays data in a summary row and an events list table.

Summary Row

The summary row tabulates data for the events in the displayed (filtered) events list.

- The **Total Events in View** field displays the number of events.
- The **Est Customers Out** field displays the number of customers estimated to be affected.
- The **Calls** field displays the number of calls received.
- The **Priority Calls** field displays the number of priority calls received.
- The **Emergency Customers Out** field displays the number of impacted emergency customers.
- The **Medical Customers Out** field displays the number of impacted medical customers.
- The **Key Customers Out** field displays the number of impacted key customers.
- The **Sensitive Customers Out** field displays the number of sensitive customers.
- The **Crews En Route/Onsite** field displays the number of crews en route or onsite.

The last three columns are based on the total counts (in your subscribed control zones) and, unlike the other Summary Row columns, ignore any filters:

- The **Priority To Do** field displays the number of priority events that are in the To Do list.
- The **Normal To Do** field displays the number of normal events that are in the To Do list.
- The **In Progress** field displays the number of in progress events.

Events List

The Events List provides a tabular view of events. The filter and sort criteria are displayed above the table; the Work Agenda tab displays the selected list view/filter (for example, To Do, All, In Progress, and so on).

Columns

- The first column displays event status symbols (for example, a checkmark (✓) for Acknowledged events).
- The **Status** column displays the status assigned to the event. See [Event Status Codes](#) on page B-1 for a complete list of status codes and descriptions.
- The **+** column displays a plus (+) or minus (-) sign for lead events when in the condensed view. See [Using the Condensed View](#) on page 1-34 for more information.
- The **Event #** column displays the number the system has assigned to the event.
- The **Pressure Zone** column displays the name of the pressure zone associated with the event.
- The **E/H** column indicates whether the event is an extreme emergency (**E**) or has hazardous (**H**) conditions.
- The **Start Date** column contains the date and time the event began.
- The **# Out** column contains the number of customers experiencing an outage for the event.
- The **Still Out** column contains the number of customers still experiencing an outage for the event.
- The **Rel Event #** column contains the event number of the parent or lead event when the event has a special relationship with one or more other events.

- The **Run CMI** column contains the current *customer minutes interrupted* value for the event. Note that this value is automatically updated once a minute. By default, the CMI is 0 for restored events, but this can be customized
- The **# Calls** column contains the number of calls received for the event.
- The **Clues** column contains the clue codes for the calls received, if any.
- The **Asset** column contains the name of the asset associated with the event.
- The **Location** column contains either the address of the first customer that called if the event is a service outage or non-outage or the pressure zone location of the asset if the event is an asset outage.
- The **Crew** column contains the crew ID of associated crews.
- The **Est Restore Time** column contains the estimated restoration time (ERT) for the event.
- The **Est Src** column contains the source of the ERT for the event. The possible values for the ERT Source, from highest precedence to lowest, are as follows:
 - **U:** User-entered via applications or tools (for example, Work Agenda, Event Details, or Crew tools) other than Storm Management.
 - **C:** Crew-entered via the mobile interface.
 - **G:** Storm Management published global ERT from the ERT Override dialog box.
 - **D:** Storm Management published global ERT delay from the ERT Override dialog box.
 - **P:** Storm Management non-published global ERT from the ERT Override dialog box.
 - **m:** Minimum ERT is not reached. The ERT is below the set threshold for minimum ERT; no ERT is shown.
 - **M:** Maximum ERT exceeded. The Storm Management calculated ERT is beyond a set threshold for maximum ERT; no ERT is shown.
 - **O:** Storm Management on-site ERT calculated when the crew changes to onsite.
 - **E:** ERT generated by Storm Management while a crew is en route to the event.
 - **S:** Storm Management calculated ERT based on outages and crews in Storm Management.
 - **I:** Initial default ERT, based on asset class and control zone.
 - **W:** system-wide default ERT.
 - **N:** none (no ERT)
- The **Prediction Type** column contains the type of prediction (for example, New, Revised, Asset Operation, and so on) or type of notification for NFY events (for example, Crew contact required).
- The **Restore Date** column contains the actual restoration date and time of the event.
- The **# Crit** column contains the total number of critical customers experiencing an outage for the event.
- The **# EMR** column contains the number of emergency customers experiencing an outage for the event.
- The **# MED** column contains the number of medically urgent customers experiencing an outage for the event.
- The **# KEY** column contains the number of key customers experiencing an outage for the event.

- The **Evt Type** column contains a description of the type of event. See [Event Type Codes](#) on page B-4 for a complete list of event type codes and their descriptions.
- The **Work Queues** column contains a comma-separated list of names of the work group queues that the event has been referred to.
- The **Region** column contains the control zone region where the event occurred.
- The **Branch** column contains the control zone branch where the event occurred.
- The **Lift Station** column contains the control zone **lift station** where the event occurred.
- The **Plan #** column contains the switching sheet number associated with the event, if any. The switching sheet number is prefixed by the switching sheet type (such as "Plan" or "Emer").
- The **Grp Type** column indicates whether the event is manually grouped or related. The possible types are:
 - GRP – manually grouped
 - REL – manually related
- The **Rel Type** column contains the type of special relationship that the event is involved in. The possible types are:
 - L – lead event of a partial restoration
 - N – nested
 - P – non-lead event of a partial restoration
 - R – manually related
 - S – switching (relationship between switching jobs and planned outages)
- The **Sent to Mobile** column indicates whether or not the event is in a state that makes it eligible to be sent to the mobile system.
- The **Dmg Asmt** column displays whether a damage assessment is needed and, if so, the status of the damage assessment. Possible values are:
 - **None** – damage assessment is not required. This is the initial state for new events.
 - **Needed** – damage assessment is required for the event, but not yet started. This state indicates that the event is assigned to an assessment work queue or an assessment crew is assigned to the event.
 - **Started** – damage assessment has been started for this event. This state indicates that an assessment crew is en-route or there is at least one damage assessment in the New state for the event.
 - **Assessed** – damage has been assessed. This state indicates that there is at least one damage assessment in the Assessed state and no damage assessments in the New state for the event.
- The **Appt Type** column indicates the type of appointment scheduled using the types in the Web Call Entry application. See [Appointment Request](#) on page 3-7 for more information on scheduling appointments.
- The **Appt Range** column indicates the window of time given for a scheduled meeting. See [Appointment Request](#) on page 3-7 for more information on scheduling appointments.
- The **Appt Date** is the date an appointment has been scheduled for a customer meeting. See [Appointment Request](#) on page 3-7 for more information on scheduling appointments.
- The **Wgt Out** column displays the sum of weighted priority values for all the customers experiencing an outage for the event. See [Using the Customer Administration Weighted Priority Editor](#) on page 10-34 for more information on weighted priority.

Filtering, Sorting, Selecting, and Locking Columns

When you right-click the events table header, a context menu displays a list of options that allow you to perform the following functions:

| Menu Option | Description |
|-------------------|---|
| Filter... | Displays the Filter Dialog so you can create, modify, apply, and save user-defined filters. See Using the Filter Dialog on page 1-17. |
| Sort... | Displays the Sort Dialog so you can modify the default sort. See Using the Sort Dialog on page 1-15. |
| Select Columns... | <p>Opens a dialog box that displays a list of columns that can be displayed in the Work Agenda table. A checkmark appears next to columns that are currently displayed. To remove a column from the table, deselect the box. To add a column that is not currently displayed, check the box. Click OK to exit.</p> <p>Note: These settings are applied immediately and affect only the current user session. To save these settings as the default view for the Work Agenda (for the currently logged-in user), select Save Preferences from the Web Workspace Preferences menu.</p> |
| Unlock Columns | <p>When the Work Agenda is first launched, the first four columns are locked in place so they stay in view as you scroll the table to the right.</p> <ul style="list-style-type: none"> You may unlock the columns by choosing Unlock Columns from the context menu. With the columns unlocked, you may lock columns by right-clicking the column you wish to be the right-most frozen column. |

The Work Agenda table supports [Quick Sorting](#), [Dynamic Filtering](#), and [Auto Filtering](#).

Using the Condensed View

When you select the **Condensed View** check box, related event rows will be condensed to the single summary row. The + column will then display a + sign on the lead event. Clicking the plus sign (+) will filter the events table to show only the related events, and change the plus sign (+) to a minus sign (-). While displaying this group of related events, filters and sorts are disabled so that all related events are displayed, with the lead event at the top of the list. Click the minus sign (-) to revert back to the previous view, and reinstate the previous filters and sorts.

Using the Work Agenda Reading Pane

The Work Agenda Reading Pane provides a summarized view of data for an event selected in the Work Agenda or Viewer.

Fields:

- Event Information**
 - Event #:** displays the number the system has assigned to the event.
 - Start Date:** displays the date and time the event began.
 - Est Restore Date:** the estimated restoration time (ERT) for the event.
 - # Out:** the total number of customers experiencing an outage for the event.
 - # Emergency:** contains the number of emergency customers experiencing an outage for the event.

- **#Medical:** contains the number of medically urgent customers experiencing an outage for the event.
- **# Key:** contains the number of key customers experiencing an outage for the event.
- **Asset:** contains the name of the asset associated with the event.
- **Zone:** contains the affected Control Zones.
- **Clues:** contains any clues associated with the event.
- **Switching Plan...:** click to open or create a new switching plan. Associated plans are listed in the field next to the button. See [Web Switching Sheets](#) on page 8-3.
- **Event Crews:** provides a crew data table with information about crews assigned to the event. See [Managing Crews with Web Trouble](#) on page 2-32.
- **Call Comments:** lists call comments.
- **Operations Event Note:** lists operations event notes. See [Managing Crews with Web Trouble](#) on page 2-32.

Acknowledging Events

To acknowledge an event, complete these steps:

1. Select the row of the event with NEW, S-NEW, P-NEW, or RED status in the Work Agenda Events List.
2. Click on the **Acknowledge** toolbar button or select **Acknowledge** from the **Actions** menu. The event becomes acknowledged and its status changes accordingly.

Using the Viewer

The Viewer presents a graphical representation of the distribution system, with additional symbology for conditions such as outages, crew locations, notes, tags, and so on. The Viewer dynamically updates with condition and distribution changes.

This section includes the following topics:

- [Starting the Viewer](#)
- [Understanding the Viewer](#)
- [Displaying Asset Details](#)
- [Understanding Viewer Coloring](#)
- [Searching and Loading Viewer Maps](#)
- [Navigating in the Viewer](#)
- [Viewer Focus](#)
- [Using Lens Windows](#)
- [Real-Time and Study Mode](#)
- [Selecting Assets](#)
- [Identifying Symbology](#)
- [Hiding and Displaying Viewer Objects](#)
- [Executing Traces](#)
- [Using the Commissioning Tool](#)
- [Using the Save Case Management Tool](#)

Starting the Viewer

To open a Viewer, select the **Viewer 1...** option on the Web Workspace **Tools** menu. To start a second Viewer, select **Viewer 2...** After you have opened the Viewer, selecting the menu option will change the focus to that Viewer.

Understanding the Viewer

The following diagram shows the functional areas of the Viewer: **Viewer Functional Areas**

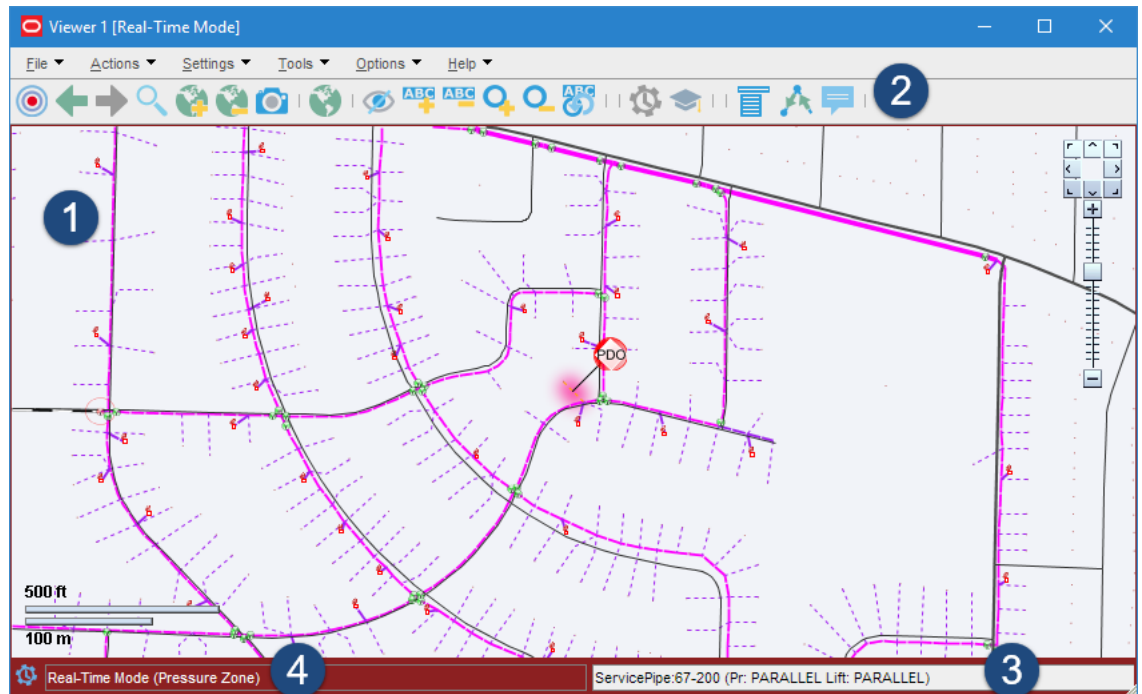

Legend:

- 1: Drawing Area
- 2: Menus and Toolbar
- 3: Message Area
- 4: Real-Time and Study Mode Indicator with View Setting

Drawing Area

The Viewer's drawing area displays dynamic maps that reflect the status of the system. The lines (used to represent pipes) and the icons (used to represent assets and conditions) are called *symbols*; the conventions that govern symbols are referred to as *symbolology*.

Certain condition symbols, such as event type or note indicator, provide tooltips indicating the symbol's meaning. For example, as shown in the illustration above, the Note symbol's hover text is *Operator Note*.

If configured, the Viewer will dim the parts of the model that are outside of the user's authority. In those sections, the user will not be able to operate or otherwise modify those assets without taking authority using the Authority tool (see [Taking Authority for Control Zones](#) on page 1-21).

Message Area

The Viewer's message area displays asset aliases, pressure zone names, and lift station names.









Menus and Toolbar

The Viewer's menus and toolbars provide access to common functions.

File Menu





| Option | Description | Toolbar Button |
|--------|--|---|
| Print | Opens the Print Preview window, which allows you to print the contents of the Viewer window. |  |
| Exit | Exits the Viewer. | -- |

Actions Menu

| Option | Description | Toolbar Button |
|---------------------|--|---|
| Focus | Focuses the Viewer on selected assets or assets associated with selected events. See Viewer Focus on page 1-51 for details. |  |
| Zoom In | Zooms in on the map to show a smaller area in more detail. | -- |
| Zoom Out | Zooms out on the map to show a larger area. | -- |
| Back | Moves to the previous view before a pan, zoom, or object focus operation (if any) changed the focus location in the Viewer. This button functions similarly to a web browser back button, storing a dozen "views." However, the loaded maps, the hide/display layers, and other options will use the current settings. |  |
| Forward | Moves to the next view if the Back button has been used. It functions similarly to a web browser's forward button. However, the loaded maps, the hide/display layers, and other options will use the current settings. |  |
| Search | Opens the Search dialog box, which allows you to enter search criteria and execute a search in the Viewer. |  |
| Load Maps | Allows you to explicitly load additional maps to display more of the surrounding area or additional detail. |  |
| Unload Maps | Unloads all maps, not just those in the visible drawing area. |  |
| Save View Area... | Saves the viewing area after prompting for a name for the saved area. If a view area already exists with that name, you will be asked if you want to replace it. |  |
| Delete View Area... | Deletes the viewing area after prompting for confirmation. | -- |
| Show Lens | Opens a Lens window zoomed in on selected asset. See Using Lens Windows on page 1-52. | -- |
| View Browser Map | Opens a web browser map to display the geographic area. |  |

| Option | Description | Toolbar Button |
|------------------------|---|---|
| Hide/Display... | Opens the Hide / Display dialog box, which allows you to select what information will be displayed on the map. See Hiding and Displaying Viewer Objects on page 1-56. |  |
| Toggle Landbase | Turns the background landbase map on or off. | -- |
| Pointer Coordinates... | Opens a dialog box that displays the geographic coordinates for a selected object. | -- |
| Group Events... | Opens the Group Events dialog box, which allows you to manually merge, relate, and un-relate events. | -- |



Settings Menu

| Option | Description | Toolbar Button |
|-------------------------|---|---|
| Fixed Size | This mode will keep the symbol and text sizes the same regardless of the zoom level. | -- |
| Text Bigger | Increases the text font size. |  |
| Text Smaller | Decreases the text font size. |  |
| Symbols Bigger | Increases the size of symbols. |  |
| Symbols Smaller | Decreases the size of symbols. |  |
| Attributes Farther | Displays attributes (for example, flags, note symbols, and so on) away from the asset. Each subsequent action moves the attribute farther away. | -- |
| Attributes Closer | Displays attributes closer to the asset. | -- |
| Reset Scale | Resets the size of symbols and text to its default size. |  |
| Unload Maps on Map Load | Selection that sets the Viewer to unload previously loaded maps before loading another map. | -- |

Tools Menu

| Option | Description | Toolbar Button |
|--------------------|--|----------------|
| Commissioning Tool | Opens the Commissioning Tool. See Using the Commissioning Tool on page 1-62. | |

Options Menu



| Option | Description | Toolbar Button |
|--------------------|--|---|
| Big Symbols | Allows you to toggle the display of Big Symbols, which are enlarged versions of normal symbology that allow you to see certain asset types and conditions when zoomed out. | -- |
| Real Time | If you are currently in Study mode, select this to switch to real-time mode. If you are currently in real-time mode, this is grayed out. For more information on real-time mode, see Real-Time and Study Mode on page 1-52. |  |
| Study | If you are currently in real-time mode, select this to switch to Study mode. If you are currently in Study mode, this is grayed out. For more information on study mode, see Real-Time and Study Mode on page 1-52. |  |
| Study Mode | <p>Reset to Real-Time: reset the study session to the current real-time model.</p> <p>Reset to Nominal: reset the study session to the nominal model.</p> <p>Reset...: displays the Reset Study Session dialog, which allows you to reset your session.</p> <p>Save Case Management...: opens the Save Case Management tool, which allows you to view, modify, delete, or reset to session changes. See Using the Save Case Management Tool on page 1-64 for more information.</p> <p>Close Study Session: closes the study session and returns the Viewer to real-time mode.</p> | |

Help Menu

| Option | Description | Toolbar Button |
|-------------------------|--|----------------|
| Viewer Help | Opens online help content for the Viewer. | -- |
| Color Legend | Opens the Color Legend window, which displays information about symbology coloring. See Understanding Viewer Coloring on page 1-46 for more information. | -- |
| Highlight Legend | Opens the Highlight Legend window, which displays information about the current view. See Understanding Viewer Coloring on page 1-46 for more information. | |

Additional Toolbar Options

The following toolbar options do not have corresponding menu options:

| Option | Description |
|---|---|
|  | The Control Tool button opens the Control Tool for the selected asset. The Control Tool may also be opened by double-clicking an asset or by right clicking the asset and selecting Control Tool... from the context menu. (See Using the Control Tool on page 1-67.) |
|  | The Trace button opens the Trace tool window, set to the current asset. The Trace tool may also be started by right clicking the asset and selecting Trace... from the context menu. (See Executing Traces on page 1-58.) |
|  | The Asset Details button toggles asset details on or off. Asset Details may also be toggled on or off by right clicking the asset and selecting Asset Details... from the context menu. (See Displaying Asset Details on page 1-44.) |

Saving Viewer Preferences

When you have adjusted the Viewer options to render symbols, text, and window information as desired, you may select **Save Preferences** from the Web Workspace **Preferences** menu to save the options for subsequent sessions.

Context Menu Options

When you select certain objects in the Viewer and right-click, a context menu will display a list of options available for the object.

Crew Context Menu Options

The following options are displayed when you right-click a crew symbol in the Viewer window; these options are only available for crews with AVL (Automatic Vehicle Location) systems.

| Menu Option | Description |
|------------------------|---|
| Assign | Assigns the crew selected in the Viewer to the event currently selected in Work Agenda. See Assigning a Crew on page 2-38 for more information. |
| En Route | Puts the crew selected in the Viewer en route to the event currently selected in Work Agenda. This is enabled only if the selected crew is an on-shift, available, non-mobile crew that is not currently en route or onsite. See Placing a Crew En Route Using the Crew Actions Window on page 2-39 for more information. |
| Release Crew | Releases the crew selected in the Viewer from the en route/onsite event selected in the Work Agenda. See Releasing Crews from an Event on page 2-49 for more information. |
| Update Availability... | Opens the Update Crew Availability dialog box for the selected crew. See Changing Crew Availability on page 2-39 for more information. |
| Crew Info... | Opens the Crew Info dialog box for the selected crew. See Using Crew Info on page 2-43 for more information. |
| Active Job Info... | Opens the Active Job Info dialog box for the selected crew. This is enabled only if an en route or onsite crew is selected. See Active Job Info on page 2-47 for more information. |

Event Options

The following options are displayed when you select an event symbol and right-click to open the context menu:

| Menu Option | Description |
|----------------------|---|
| Event Details... | Opens the Event Details window for the event. See Managing Crews with Web TroubleEvent Details on page 2-2. |
| Trouble Info... | Opens the Trouble Info window for the event. See Using the Trouble Info Tab on page 2-6. |
| Event Log... | Opens the Event Log window for the event. See Managing Crews with Web Trouble on page 2-32. |
| Damage Assessment... | Opens the Damage Assessment window. See Working with Damage Assessments on page 2-25. |
| Crew Info... | Opens the Crew Info window for the crew assigned to the selected event. See Using Crew Info on page 2-43. |
| Active Job Info... | Opens the Active Job Info window for the crew assigned to the selected event. This is enabled only if one crew is assigned to the event and is en route or onsite. See Active Job Info on page 2-47 for more information. |

| Menu Option | Description |
|---------------------------|--|
| Show En Route Location... | Shows the AVL location of the crew that is currently en route to the selected event. This option is only enabled when one crew is assigned to the event. |
| Release Crews... | Opens the Release Crews dialog box. Enabled when one or more crew is assigned to the event. See Releasing Crews from an Event Symbol in the Viewer on page 2-49. |

Asset Options



Depending on the asset type, the following options may be displayed when you select an asset and right-click to open the context menu:



| Menu Option | Description |
|----------------------|---|
| Control Tool... | Opens the Control Tool for the selected asset. See Using the Control Tool on page 1-67. |
| Asset Details... | Displays the Asset Details balloon above the selected asset. See Displaying Asset Details on page 1-44. |
| Attributes... | Opens the Attributes window, which displays information about the selected asset. See Viewing Asset Attribute Information from the Viewer on page 1-46. |
| Open... | Initiates the Control Tool's Open command. See Control Tool Actions on page 1-68. |
| Close... | Initiates the Control Tool's Open command, if applicable. See Control Tool Actions on page 1-68. |
| Customer List... | Displays the Trouble Info Customers List. See Customers View on page 2-10 for more information. |
| Damage Assessment... | Opens the Damage Assessments window, which displays a list of damage assessments associated with the asset and allows you to add new damage assessments. See Using the Damage Assessments Tab on page 2-12. |
| Toggle Call Display | Toggles call display on or off. When enabled, a symbol is displayed in the Viewer window for any assets that have calls associated with an event. Events with calls and clues will show the call symbol and clue symbol. |
| Trace... | Opens the Trace tool, which allows you to display the path from a selected asset to other assets based on specific criteria. See Executing Traces on page 1-58. |

Displaying Asset Details

Asset Details provides information about assets selected in the Viewer. Asset Details is enabled by clicking the **Asset Details** button () in the Viewer's toolbar or by right-clicking an **asset** and selecting **Asset Details...** from the context menu.

Note: The Viewer's **Asset Details** button is highlighted when enabled.

When **Asset** Details is enabled, selecting an asset will automatically launch a balloon-style callout window attached to the asset in the Viewer. Selecting a different asset will close the first window and open a window for the newly selected asset. To keep a window open, you may "pin" it by clicking the pin button () or close it by clicking the close button (). **Asset** Details windows may be dragged to a different location in the Viewer or resized.

The **Asset** Details tabbed data views provide relevant information based on the object selected. Data is refreshed whenever you select a different tab, but you may manually refresh the data by clicking the refresh button (). Click the **Help** button () to display help for the active tab.

The **Asset** Details tabs provide the following information:

- **Asset Info:** The information contained in the **Asset** Info tab varies depending on the type of **asset** and its current condition, but may include the following types of information:
 - Event information, such as number of customers affected, when the event began, estimated restoration time, event type, event number
 - Event Note
 - Location
 - **Asset** Notes
 - Crew information
- **SCADA:** The SCADA tab displays SCADA **asset** data. It is only enabled for SCADA **assets** in systems that have implemented SCADA Extensions; see [Displaying SCADA Measurements with Asset Details](#) on page 7-9 for details.

Viewing Asset Attribute Information from the Viewer

You can access attribute information related to an asset using the Viewer. Asset attributes include physical and reference information about an asset, such as location and rating.

To view asset attributes from the Viewer, complete these steps:

1. Right-click an asset in the Viewer.
2. From the context menu, click **Attributes....** The Attributes window opens.

About the Attributes Window

The Attributes window is tabular and allows standard sorting and filtering; see [Sorting and Filtering Data](#) on page 1-15.

The information in the Asset Information is view-only. Once the asset attribute window is open, selecting another asset in the Viewer will update the information for the selected asset.

See also [Viewing Asset Attribute Information](#) on page 1-72.

Understanding Viewer Coloring

When the Viewer is launched, the network model is displayed with Pressure Zone coloring where all pipes fed from a source are displayed in the same color. Conditions affecting the network are displayed with highlight coloring, which overlays a glow on the affected network component.

Viewing the Color Legend

To see the color legend for the view, select **Color Legend...** from the Viewer **Help** menu.

Viewing the Highlight Legend

To see the highlight legend for the view, select **Color Legend...** from the Viewer **Help** menu.

Searching and Loading Viewer Maps

The Viewer *Search* functionality allows you to quickly focus the Viewer on an area or object.

- Search Type Option
- Search Case Option
- Search Result Limit
- Customer Information Section
 - Account #
 - Name
 - Address
 - Telephone
 - Meter Number
- Intersection
 - Street 1
 - Street 2
- Feeder Name
- Asset ID
- View Area
- Crew ID
- Event #

Using the Search Tool to Locate Map Areas and Objects

To locate a particular area or object in the Viewer, complete these steps:

1. Click the **Search** button on the Viewer toolbar or from the Actions menu. The Search dialog box opens.
2. Select the **Search Type** you wish to perform (Exact Match, Wildcard Before, Wildcard After, Wildcard Before and After, Soundex) from the **Search Type** option menu.
3. Select the **Search Case** option you wish to use (Case Insensitive, Case Sensitive) from the **Search Case** option menu.
4. Enter your search result limit in the **Search Result Limit** field (default value is 100).
5. Click the desired search field and either enter search criteria **or** leave the field blank to return all possible values (up to the search result limit).
6. Press **ENTER** or click the **Search** button.
7. If there is *only one match*, the Viewer will shift focus to the search result. If there are multiple matches, a Search Results dialog box displays the search results and the Search dialog box closes.

For example, an **Intersection** search using the term Oaklynn returns six matches.

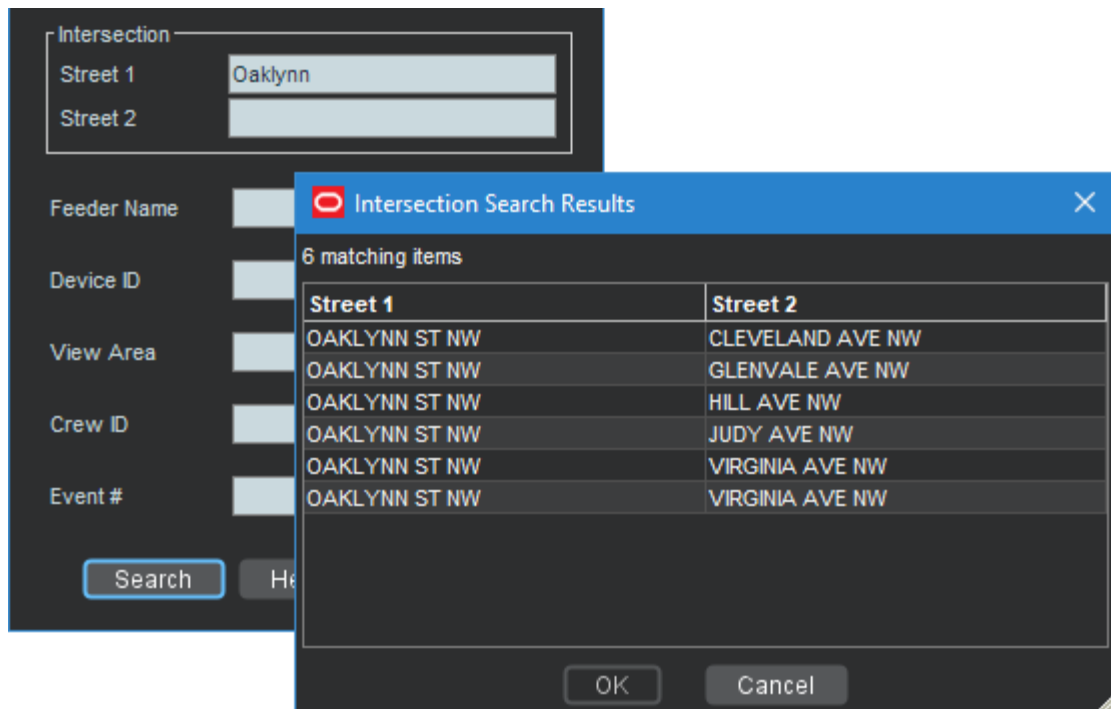

8. If there are multiple matches, select a row in the Search Results dialog box and click the **OK** button. The object appears centered in the Viewer and the Search Results dialog box closes.

Note: If none of the results are what you wanted, click **Cancel** in the Search Results dialog box. The Search Results dialog box closes and the Search dialog box is redisplayed.

Loading and Unloading Viewer Maps

Once you have located an area or object using the Search dialog box, you can navigate to an adjacent area where the maps are not yet loaded. From here, you can load all the maps that should appear in the drawing area.

To load maps, do one of the following:

- Select **Load Maps** from the **Actions** menu.
- Press the **M** key.
- Click the **Load Maps** button () on the toolbar.

To unload all maps (not just those in the visible drawing area), do one of the following:

- Select **Unload Maps** from the **Actions** menu.
- Press **Shift+U**.
- Click the **Unload Maps** button () on the toolbar.

Note: Unless your system is configured to unload maps with each focus, any loaded maps will continue to be loaded until you explicitly unload maps or you switch mode (that is, from study to real-time or from real-time to study).

If there are more assets displayed than the configured maximum, which is 500,000 in the product configuration, the viewer will unload the maps that have the oldest access time to get the total under the limit.

Navigating in the Viewer

There are a number of ways to navigate around the Viewer:

- Pan left, right, up, down, or diagonally in the map using the pan compass.
- Use the Plus (+) and Minus (-) buttons on the zoom slider to zoom in and out. You can also drag the zoom slider toward the + to zoom in or toward the - to zoom out. The scale indicator displays the current zoom scale. The scale is hidden if a schematic view, such as a substation, is selected.
- Navigate using your mouse controls, as described in the next section.



Navigating Using Mouse Controls



There are various mouse controls you can use to navigate within the Viewer. The following table shows all of the mouse commands for the Viewer.

| To... | Do this... |
|-------------------------|--|
| Select an object | Click the object. |
| Select multiple objects | Shift-click and drag to extend the selection rectangle around the area with the object you want to select. The Select an Asset dialog box will open listing all of the assets in the selection area. |
| Box Zoom | Box Zoom allows you to focus on an area. Click and hold the middle mouse button to begin drawing the rectangle and release it to complete drawing the rectangle; the Viewer will display the area selected at a zoom level that allows the area to fill the Viewer drawing area. |
| Zoom out | Scroll upward with the scroll wheel, if available. |
| Zoom in | Scroll downward with the scroll wheel, if available. |

| To... | Do this... |
|-----------------------|---|
| Open the Control Tool | Double-click the object. |
| Move the map | Click and drag the map to a new location. |

Scaling Symbols and Text

To make the symbols for major assets and conditions prominent while zoomed out, select **Symbols Bigger** () from the Viewer's **Actions** menu. The symbols remain large even as you zoom out, but will still disappear at standard Declutter levels. Conversely, you may make the symbols smaller by selecting **Symbols Smaller** () from the Viewer's **Actions** menu.

To make text annotations, such as asset ID, phase indicator, and so on, larger, select **Text Bigger** () from the Viewer's **Actions** menu. To make text smaller, select **Smaller Text** () from the Viewer's **Actions** menu.

To reset symbols and text to their standard sizes, select **Reset Size** () from the Viewer's **Actions** menu.

Displaying Pointer Coordinates

To view the coordinates of a point in the Viewer, click and select **Pointer Coordinates...** from the Viewer's **Actions** menu. The **Pointer Coordinates** dialog box will open with the following information:

- **Window X/Y:** the position in the current drawing area view.
- **Coordinates (X/Y) (Geographic Coordinate System):**
- **Latitude/Longitude:**
- **Distance from Previous Coordinate (Feet):**

Note: The keyboard accelerator (**C**) is very useful for quickly opening the **Pointer Coordinates** window.

Viewer Focus

The Viewer's **Focus** option is context aware and will function according to your selection.

- If you select an object in the Viewer, clicking the Viewer Focus button will focus on that object.
- If you select an event in the Work Agenda and click the Viewer Focus button, the Viewer will focus on the asset/object associated with the event.

Focus on Viewer Selection

If you select an object in a geographic view in the Viewer and click the Focus button, the Viewer will center the object and zoom in/out as necessary. If the object is part of a schematic view, the first Focus action will display the object in the diagram view. Each successive click will cycle the Viewer through alternate views, if available, until it cycles back to the geographic view.

Note: Viewing schematics may not reflect the current (real-time) state of the network since the schematic views are generated by the model build process.

Focus on Selection Made in another Window

When you make a selection of an event in another window (for example, the Work Agenda) and click the **Viewer Focus** button, the Viewer will find the asset and focus the drawing area on it.

9.

Using Lens Windows

The Viewer's Lens functionality allows you to start a "mini-Viewer" window that is focused and zoomed in on a selected asset. To start a Lens window, select an asset in the Viewer and select **Show Lens** from the Viewer's **Actions** menu. The Lens window will open zoomed in on the asset

Behaviors of the Lens Window and Viewer Lens Area

The area displayed in the Lens window is indicated by a red rectangle in the Viewer's Drawing Area. The red rectangle may be moved directly in the Viewer by clicking and dragging. As the rectangle moves, the Lens window will update to show the area inside the rectangle. Likewise, panning and zooming in the Lens window will be reflected by position and size of the rectangle in the Viewer.

When the Lens is started, its text size, symbol size, attribute size, coloring rule, and big symbols are all synchronized with the Viewer; thereafter, the Lens settings are independent. If you want to resynchronize the Lens settings with the Viewer settings, close and reopen the Lens. Note that real-time/study mode and tracing are always synchronized between the Viewer and the Lens.

Real-Time and Study Mode

NMS applications start in real-time mode, where every action you perform is applied to the real-time model and displayed to all users. Certain windows (the Viewer and the Control Tool) allow you to change to study mode, where your actions are reflected in your study session on your workstation, but not recorded in the real-time model. Study mode is especially useful in "what if" studies, when you need to evaluate the effects of an action before you record it in real-time.

When in real-time mode, the Viewer displays status, topology, and condition information based on real-time operations information. All changes to these items made by any user in real-time mode are reflected on all real-time Viewers in the system.

When in study mode, the Viewer displays only status and topology changes you make on your workstation. Changes made in your study session are not reflected in the real-time model, and likewise changes made in real-time are not reflected in your study session.

A study session is created for a specific workstation the first time you put the Viewer into study mode. The study session is initially created as a copy of the current real-time model. From that point on, changes in the study session and real-time are independent of each other. You can reset the study session to current real-time by using the Study Session Control tool. In addition, some Web Switching Management actions can also cause study session resets. Please refer to the [Web Switching Management](#) chapter for more information.

Note: It is recommended that you reset study sessions to real-time as often as makes sense (for example, when starting a new switching plan, testing a new 'what if' scenario, and so on). This is especially important during high load periods (for example, a storm).

Switching to Study Mode

To toggle the Viewer to study mode, do one of the following:

- Select **Study** from the **Options** menu, or
- Click the study mode button () on the toolbar.

The Viewer window borders change color to gray.

- You can reset the study session to either the current real-time model or the nominal model using the Viewer's **Reset Study Session...** button in the **Options** menu.

Switching to Real-Time Mode

To toggle the Viewer back to real-time mode, do one of the following:

- Select **Real Time** from the **Options** menu, or
- Click the real-time button () on the toolbar.

The Viewer window borders and dialog boxes change color back to red.

Selecting Assets

Asset Selection

To select a single asset in the Viewer, click the asset symbol.

Box Selection

Box selection is used to select an asset from an area containing multiple assets. To perform a box selection, Shift-click and drag in the Viewer drawing area to create a rectangular selection box. When you release the mouse, the **Select an Asset** window opens and is populated with all assets within the selection area. Select any asset in the list to highlight it in the Viewer; highlighting changes the asset symbology to the selection color, but the asset is not selected until a selection action is initiated.

Select an Asset provides the following actions:

- **Select** - selects the highlighted asset and closes the window.
- **Control Tool** - selects the highlighted asset, opens its Control Tool, and closes the window.
- **Asset Details** - selects the highlighted asset, opens the Asset Details window above the asset in the Viewer, and closes the window.
- **Cancel** - closes the window. The last highlighted asset, if any, will remain highlighted in the Viewer, but will **not** be selected for subsequent Viewer actions.

Note: Only a single asset can be selected at any given time unless the Viewer is in Supply Points mode.

Polygon Selection

Polygon selection is an advanced form of box selection. To begin a polygon selection, press the Alt key and click the Viewer drawing area to place the first anchor point; continue to press Alt and click to add additional vertices. To complete the polygon, press Alt and right-click to connect the last vertex to the first vertex. Once the selection polygon is complete, the **Select an Asset** window will appear listing all assets that were inside the area.

Multiple Selections

If you are in Supply Points mode, you can use Box Selection or Polygon Selection to select multiple supply points. To add a supply point to your selection press the Control key and click the supply point; likewise, to remove a supply point from your selection, press the Control key and click a selected supply point. You may also add multiple supply points to your selection by pressing the Control key while performing a box selection.

Identifying Symbolology

Asset Symbolology

Changes in the status of an asset (for example, valves, pumps, and so on) are reflected by changes in symbology.

Condition Symbolology

Dynamic conditions on an asset (for example, "predicted service outage," "crew on-site," "notes," and so on) are indicated with specific symbols attached to the asset to which the conditions apply.

Condition symbols display in specific areas around an asset or object. The following table provides examples of where condition symbols display in relation to the asset they are attached to. The following figure displays the Viewer with probable asset outage, crew on-site, note and tag conditions.

| Area | Symbols |
|-------------|--|
| Above Left | Tags |
| Above Right | Probable Service/Asset Outages Real Outages |
| Below Left | En route/Onsite Crews |
| Below Right | Notes Call Clues |

Work Agenda Interaction with Event Condition Symbols

When you select a condition symbol for an event, such as a predicted service outage symbol, the corresponding row in the Work Agenda will be highlighted and the Work Agenda table will scroll to display the row, if necessary. If the event is not in the Work Agenda filtered view, the Work Agenda will not change to a filter that would show the event and the selection will be cleared; for example, if the Work Agenda is set to show completed events, selecting an active event symbol will not change the Work Agenda to the "To Do" view to show the event.

Related

- [Work Agenda Views](#) on page 1-25

Pipe Symbolology

Pipe symbology changes color, dash patterns, and thickness for different types of pipes and topology states.

SCADA Symbolology

For systems with SCADA Extensions, the Viewer provides many visual cues about SCADA assets and their statuses. For details on SCADA symbology, see [Understanding SCADA Information in the Viewer](#) on page 7-8.

Hiding and Displaying Viewer Objects

The Viewer's Hide/Display tool allows you to display only those map elements (for example, layers, objects, crew types) that are of interest to you. To change visibility of components displayed in the Viewer, complete these steps:

1. Click the Hide/Display () toolbar button. (Alternatively, you may select **Hide/Display...** from the **Actions** menu.)
2. Select the elements that you want displayed; deselect those elements that you do not want displayed.

Note: Hide/Display is a configurable feature of NMS so your dialog box may have different options.

3. Hide/Display options may include:

- **Layer Groups:** defined groups of single layers listed in the **Layers** pane.
- **Layers**
- **Highlighting**
 - Predicted Impacted - adds a glow around an object that is predicted to be off supply
 - Confirmed Impacted - adds a glow around an object that is confirmed to be off supply.

Note: If more than one highlighting color matches, the following order of importance is used:

1. Predicted Impacted
2. 4. All other highlighting (following the configured pipe coloring priority).

To see the color legend for highlighting glows, select **Highlight Legend...** from Viewer's **Help** menu.

- **Crew Types**
 - Incidents - allows you to choose whether to display all calls or just AMI notifications.
 - Show All Calls
 - Show All AMI
 - Declutter (On/Off) - see [Decluttering the Viewer](#) on page 1-56 for details.
 - Hide Conditions with Assets (On/Off) - see [Hiding Conditions with Assets](#) on page 1-57 for details.
 - Spatial Landbase Menu - allows you to chose which Spatial Landbase to use. The options available will depend on your installation.
 - The Network Level menu allows you to choose to display:
 - The Pending Assets menu allows you to choose to display construction pending, decommissioning conditions, and inactive assets. Options are:
 - Hide Pending Assets (the default)
 - Show Pending Assets
4. Click the **Close** button to close the Hide/Display dialog box.

Decluttering the Viewer

The Viewer automatically hides objects based on predefined declutter zoom levels. This allows you to only see high-level information at higher zoom levels, removing small text and other items that are no longer readable at that zoom level. When an object is decluttered, any associated

conditions and text will also be decluttered. The declutter option is enabled by default, but you can turn it off by unchecking the Declutter (On/Off) option in the Hide/Display dialog box.

Hiding Conditions with Assets

The Hide Conditions with Assets option, which is selected by default, will hide all conditions when their associated assets are hidden, either due to other Hide/Display options or decluttering. When not checked, the conditions will always display, even when their assets do not.

Executing Traces

The trace feature allows you to display the path from a selected asset to other assets based on specific criteria. The trace path is displayed on the Viewer by changing all pipes that are part of the path to a thick light blue.

This section includes the following topics:

- [Trace Types](#)
- [Executing a Trace](#)
- [Inspecting Direct Connections and Navigating to Connected Objects](#)

For a description of the fields and buttons on the Trace dialog box, see [Using the Trace Dialog Box](#).

Trace Types

The following table describes the various types of traces.

| Trace Type | Description |
|----------------------------|--|
| To Source | Traces from the selected asset to its source. |
| All Connected | Traces from the selected asset to all connected assets, stopping only at sources. |
| To Valve | Traces from the selected asset to upstream and downstream valves. |
| To Asset Class | Traces from the selected asset to an asset class. |
| To Closed Points | Traces from the selected asset to all directly-connected closed points on the pressure zone. |
| To Nominally Closed Points | Traces from the selected asset to all directly connected nominally closed points on the pressure zone. |

Using the Trace Dialog Box

Use the Trace dialog box to execute traces of all types.

To display the Trace dialog box, click the **Trace** button on the Viewer toolbar and select an object. The Trace dialog box displays the following fields and buttons:

- The first drop-down menu allows you to select the trace type, as described in the table above.
- The second drop-down menu contains the options for the trace direction:
 - **Upstream** - Constrains the trace to be only upstream of the selected asset.
 - **Downstream** - Constrains the trace to be only downstream of the selected asset.
 - **All** - Allows the trace to be both downstream and upstream of the selected asset.

Note: Tracing all connected assets will automatically trace both upstream and downstream. Tracing to source will automatically trace upstream.
- The third drop-down menu allows you to select the trace mode:
 - **Current Session** - Performs the trace by using statuses currently displayed in the Viewer. This is the default.
 - **Nominal** - Performs the trace by assuming nominal statuses for all assets.

Advanced Trace Dialog Box Fields

Click the **Advanced** button (▼) in the bottom-right corner of the Trace dialog box to display additional information about the selected object, including detailed topology. You can also inspect direct connections and navigate to connected objects.

When you click the **Advanced** button, the Trace dialog box expands to display the following information:

The **Asset Details** section displays the following asset information:

- Asset type
- Asset handle
- Network Component Group (NCG)
- Map containing the asset
- Display group

The **Symbol Details** section displays the following symbol information:







- Symbolology class
- Symbol ID
- Coloring status
- Valid statuses
- Coloring rule

The **Connectivity Details** section displays the following connection information:

- Pressure Zones
- Current statuses
- Nominal statuses
- Other statuses

The **Connections** section displays a list of connected nodes for the selected object. You can expand the list of connections for each node and focus the Viewer on an object in the list. For more information, see [Inspecting Direct Connections and Navigating to Connected Objects](#) on page 1-61.

Trace Dialog Box Toolbar

| Toolbar Icon | Description |
|---|--|
|  | The Trace button executes the trace. |
|  | The Clear button erases the trace color from the Viewer and returns to normal color. |
|  | The Refresh button performs the trace again. This is useful if assets have been operated or the model was rebuilt. |
|  | The Trace Focus button focuses the Viewer on the entire extent of the trace. |
|  | The Endpoint button focuses the Viewer on the endpoint asset of the trace. This option is disabled if the trace is in all directions (since there will not be a single endpoint). |
|  | The Help button displays online help for the Trace function. |

Executing a Trace

To execute a trace, complete these steps:

1. Select the asset you want to trace from and click the Trace button () (See [Using the Trace Dialog Box](#) on page 1-58 for field descriptions.)
2. Select the trace type, direction, and mode as described in the following table:

| To trace... | Do this... |
|---------------------------|--|
| To all connected assets | Select "All Connected" from the drop-down and then click the Trace button. The Viewer traces from the asset to all connected assets stopping only at a source. |
| To connected valves | Select "To Valve" from the first drop-down and select the direction from the second drop-down. Click the Trace button. The Viewer traces from the asset to all valves in the specified direction. |
| To the source | Select "To Source" from the first drop-down. Click the Trace button. The Viewer traces from the asset upstream to the source. |
| To a specific asset class | Select "To Asset Class" from the first drop-down. The Asset Class field and Search button will be displayed. Click the Search button to open the Select Class dialog box. Expand the object tree and select the asset class that you wish to trace to. Click OK to populate the Asset Class field. Click the Trace button. The Viewer traces to that asset class. |
| Upstream | Select either "To Valve" from the first drop-down, and then select "Upstream" from the second drop-down. Click the Trace button. |

| To trace... | Do this... |
|--|--|
| Downstream | Select either "To Valve" from the first drop-down, and then select "Downstream" from the second drop-down. Click the Trace button. |
| Both upstream and downstream | Select either "To Valve" from the first drop-down, and the select "All" from the second drop-down menu. Click the Trace button. (Tracing all connected assets and tracing to the source will automatically trace both upstream and downstream.) |
| Using statuses currently displayed in the Viewer | Select "Current Session" from the third drop-down menu. Select the tracing option (All Connected, To Valve, and so on) and the direction, then click the Trace button. |
| Using nominal statuses | Select "Nominal" from the third drop-down menu. Select the tracing option (All Connected, To Valve, and so on) and the direction, then click the Trace button. |

Inspecting Direct Connections and Navigating to Connected Objects

Use the advanced fields on the Trace dialog box to inspect direct connections and navigate to connected objects.

1. In the Viewer drawing area, select the asset you want to trace from and click the **Trace** button.
2. Click the **Advanced** button (▼) in the bottom-right corner of the Trace dialog box. The dialog box expands to display detailed connection information.
3. In the Connections box at the bottom of dialog box, click the + sign to expand a node and display all connection branches.
4. Right-click a connection row and select **Focus** from the context menu. The Viewer focuses on the object and colors it with the specified color. The Trace dialog box displays details for the newly selected object, including a list of its connections. Refer to [Advanced Trace Dialog Box Fields](#) on page 1-59 for more information.
5. Repeat steps 4 and 5 needed to inspect more connections.

Using the Commissioning Tool

The Commissioning Tool allows you to commission an asset that is currently in construction or decommission assets currently marked for removal.





To open the Commissioning Tool, select **Commissioning Tool...** from the Viewer's Actions menu. The Commissioning Tool displays two panels:

- The **Waiting for Approval Panel** displays a table of assets that need to be approved and indicates their current statuses (To Commission or To Decommission).
- The **Approved Panel** displays a table of assets approved for removal and indicates their current statuses (Commissioned or Decommissioned).

If no pending assets are currently selected, both panels will be empty.

The tables may be sorted by either the Asset or Status column and may be filtered using the filter fields at the top of the table columns (see [Sorting and Filtering Data](#) on page 1-15). The status bar at the bottom of the Commissioning Tool window indicates the current real-time or study mode status.

You can perform the following actions on the assets displayed in the Commissioning Tool window:

| Task | Description |
|--|---|
| Approve the selected assets. | Select one or more assets in the Waiting for Approval list and click the approve button (); alternatively, you may use the right-click menu option. The assets are moved to the Approved list and their symbols in the Viewer change from red or green to gray. |
| Focus on the asset in the master Viewer window. | Select a single asset in either list and click the Focus button (); alternatively, you may use the right-click menu option. |
| Remove selected assets from the list. | Select one or more assets in either list and click the Remove button (); alternatively, you may use the right-click menu option. |
| Undo the approval for the selected asset. | Select one or more assets in the Approved list and click the Undo button (); alternatively, you may use the right-click menu option. The assets are moved to the Waiting For Approval list and their symbols in the Viewer change from gray back to red or green. |

Commissioning and Decommissioning Assets

To commission or decommission sets of assets, perform the following steps:

1. In the Viewer, load the pending asset changes you wish to modify. You can select multiple assets.
2. Enable the **Show Pending Assets** option in the Hide/Display dialog box.
3. Switch to study mode if you don't want to affect the real-time model.
4. Select **Commissioning Tool...** from the Viewer's Actions menu. Selected assets pending approval are listed in the Waiting for Approval panel.

- Select the assets you want to commission or decommission, then click the **Approve** () button.

Notes:





- Assets being decommissioned are no longer part of the model and are immediately colored as disconnected.
- Commissioned assets immediately become part of the model and connections are recalculated (that is, a newly commissioned asset attached to a supply will color as supplied).

Selecting Pending Assets

When you select an asset in the Viewer that is pending construction or decommission, the asset is listed in one of the panels in the Commissioning Tool. To select multiple objects, shift-click and drag until the selection box surrounds the objects.

Note: Use the **Show Pending Assets** option in the Hide/Display dialog box to display or hide pending assets.

The Viewer displays the following commissioning-related conditions:

| Symbol | Description |
|---|----------------------------------|
|  | Unapproved pending construction. |
|  | Approved pending construction. |
|  | Unapproved pending decommission. |
|  | Approved pending decommission. |

Using the Commissioning Tool with Web Switching Management

The Commissioning Tool will generate switching steps for each commissioning/decommissioning assets action when Web Switching Management is licensed. Commissioning/decommissioning actions will always be recorded in Real-Time mode. The actions will either go into the Miscellaneous Log or a switching sheet recording Real-Time operations.

Non-complete Commissioning and Decommissioning steps can be executed over and over again in Study mode within the switching sheet they were recorded into. In Real Time, the steps can only be Instructed and Completed one time which will initiate the action against the Real Time model. Completing the step in study mode will only cause the action to be completed in the user's study session.

For performance purposes, Commissioning and Decommissioning steps should be completed in groups by highlighting multiple steps during step execution operations. This will force the requests to be packaged and processed as a batch request. The batch processing will only work if the Commissioning and Decommissioning steps are contiguous in the steps list without any other type of step mixed in. You can still highlight a larger group of steps containing a mixture of step actions and execute them, but each contiguous group of Commissioning and Decommissioning steps will be processed as a batch request.

An error will be generated when completing a commissioning/decommissioning step where the asset has not been setup for commissioning or decommissioning. This error will cause the step to not complete and will halt step execution.

A warning scenario will be generated when completing a commissioning/decommissioning step where the resulting action has already been applied to the asset in question. The user will have the option of ignoring the warning, which will cause step execution to continue. If the warning is not ignored, then step execution will be stopped.

Using the Save Case Management Tool

A study session 'Save Case' is the collection of changes made during a study session. The Save Case Management tool displays a table with rows for any existing save cases. The tool allows you to create a new save case containing the changes made during a current study session or, like resetting your study session to Real-Time or Nominal mode, you may set your study session based on an existing save cases.

Note: Only topology changes are included in a save case.

Opening the Save Case Management Tool

If you are creating a new save case, you would perform asset operations prior to opening the Save Case Management tool. Conversely, if you want to start a study session based on an existing save case, you would not want to perform any asset operations because the model will be reset to the topology as it existed when the save case was created.

To open the Save Case Management tool, do the following:

1. Start a Study Session. See [Real-Time and Study Mode](#) on page 1-52 for more information.
2. From the Viewer's **Options** menu, select **Study Mode**, and then select **Save Case Management...**



Note: This option is also available from the Web Switching Steps tab's **Reset** context menu.

Save Case Management Tool Menus and Toolbar Options

File Menu.

| Option | Description | Toolbar Button |
|--------------|---|---|
| Print | Displays the Print Preview dialog box, which allows you print the Save Cases table. |  |
| Exit | Closes the Save Case Management tool. | |

Actions Menu.

| Option | Description | Toolbar Button |
|----------------------|---|---|
| Save Case Details... | Displays the Save Case Details dialog box with the save case details for the selected row. |  |
| Reset | Real-Time: resets the current study session to the real-time model. Nominal: resets the current study session to the nominal model. Selected Save Case: resets the current study session to the save case for the selected row. | |
| Save... | Opens the Save Case Details dialog box with the steps from the current study session. |  |
| Delete... | Displays a confirmation dialog box before deleting the selected save case. |  |

Help Menu.

| Option | Description | Toolbar Button |
|----------------|---|----------------|
| Save Case Help | Opens the Oracle Utilities Network Management System's online help content for the Save Case Management tool. | -- |

Save Case Management Tool Data Fields

The Save Case Management tool's table contains the following information:

- The **Save Case Name** field displays the name of the save case.
- The **Description** field displays a description added to the save case.
- The **User** field displays the name of the user who created the save case.
- The **Created Date** field displays the date when the save case was saved.
- The **Base** field displays the model that the save case was created against.

Creating a New Save Case

To create a new save case, you will first perform operations in study mode and then open the Save Case Management tool.

1. In the Save Case Management tool, click the **Save...** button () to open the Save Case Details dialog box.
2. Enter a name for the save case in the **Save Case** field.
3. Enter a description for the save case.
4. Click the **Save** button to save the save case.

Note: If a row was selected in the Save Case Management tool's Save Cases table, the **Save Case** and the **Description** fields will be populated with the

name and description of the selected save case. If you click **Save**, an **Overwrite Save Case?** dialog box will ask you if you want to overwrite the save case with the operations in your study session.

- Click **Yes** to overwrite the save case.
- Click **No** to go back to the **Save Case Details** dialog box and enter a new name and description.

If you select a row in the **Save Case Management** tool, but want to create a new save case, click outside of a table row to deselect the row.

Understanding the Save Case Details Dialog Box

The **Save Case Details** dialog box contains fields, buttons, and a data table listing the operations performed in a study session.

Save Case Details Fields

The **Save Case Details** dialog box contains the following fields and buttons:

- The **Save Case** field allows you to enter a name for the save case.
- The **Description** field allows you to enter a description for the save case.

Save Case Details Buttons

- The **Save** button saves the save case with the name entered in the **Save Case** field. The button is only sensitized when a name has been entered.
- The **Help...** button launches online help for the **Save Case Management** tool.
- The **Cancel** button closes the dialog box without saving any changes.

Save Case Changes Table Fields

The current study session's operations are listed in the **Save Case Changes** table. The **Save Case Changes** table contains the following information:

- The **Operation** field displays the type of operation performed.
- The **Asset** field displays the operated asset's ID.

Viewing an Existing Save Case

When you click the **Save Case Details...** button () or double-click in a row in the **Save Case Management** tool table, the **Save Case Details** dialog box is displayed in viewing mode.

The save case details are displayed, along with a **Reset to Save Case** and a **Delete** button. The **Reset to Save Case** button resets the current study session to the displayed save case. The **Delete...** button deletes the displayed save case.

Using the Control Tool

The Control Tool lets you perform actions on assets. It is typically brought up from the Viewer, although it can also be brought up from an event in the Work Agenda window. The actions you can perform on assets include tagging an asset, placing a note on an asset, re-predicting an outage upstream or downstream from an asset and opening and closing an asset.

Control Tool topics include:

- [Understanding the Control Tool](#)
- [Highlighting Events in the Work Agenda](#)
- [Tagging Assets](#)
- [Highlighting Events in the Work Agenda](#)
- [Viewing Documents Associated with an Asset](#)
- [Viewing Associated Customers](#)
- [Adding Notes](#)
- [Viewing Asset Attribute Information](#)
- [Toggling Call Display](#)
- [Viewing Associated Customers](#)
- [Using the Look Ahead Dialog Box](#)
- [Associating Documents with Assets](#)
- [Associating Damage Assessments to an Asset](#)
- [Completing and Instructing Actions](#)

For related topics, see also:

- [Using SCADA Control Tool Features](#) on page 7-11
- [Web Switching Management](#) on page 8-1
- [Working with Safety Documents](#) on page 8-77
- [Using the Training Environment Control Tool](#) on page 22-4

Understanding the Control Tool

The Control Tool lets you perform asset operations based on the current status of the asset. For example, if an asset is already open, you can close it. If the asset is closed, you can open it.

You can access the Control Tool from the Viewer by double-clicking an asset or by selecting an asset and then clicking the **Control Tool** button () on the Viewer toolbar. If you click the Viewer drawing area without selecting an asset, the system selects the nearest asset.

The name of the asset is displayed at the top of the Control Tool. The left side of the Control Tool provides a set of buttons with options that you can perform; the options that appear differ depending on the type of asset that the Control Tool was opened from (and so on).

Control Tool Actions

Control Tool operations and functions are performed by clicking their corresponding buttons. The following table describes common Control Tool buttons and the actions that they perform.

| Option | Description |
|------------------------------|---|
| Operate... | Allows you to perform asset operations; options available depend on the asset and asset state: <ul style="list-style-type: none"> • Close • Open • Instruct Close • Instruct Open • Close and Tag • Instruct Close and Tag • Remove Tag and Open • Instruct Remove Tag and Open • Inhibit • Un-Inhibit • Undo Close • |
| Main Break | Inserts a main break condition into the model. |
| Main Break Repaired | Removes the main break condition from the model. |
| Tag... | Allows you to Place Tag, Instruct Place Tag, Remove Tag, and Instruct Remove Tag. |
| Highlight Event | Displays the event in the Work Agenda. You must have the correct view of the Work Agenda window open in order to see the highlighted event (for example, the In Progress list). |
| Repredict Upstream | Allows you to manually repredict the outage to the next predictable upstream asset. |
| Repredict Downstream | Allows you to manually repredict the outage to the next predictable downstream asset. |
| Repredict to Here | Allows you to manually repredict downstream outages to the selected asset. |
| Repredict PMO to Here | Allows you to manually repredict downstream momentary outages to the selected asset. |
| View Documents... | Allows you to view documents associated with asset. |
| Note... | Allows you to place notes on assets. |

| Option | Description |
|----------------------------------|---|
| Attributes... | Displays the Asset Attributes window, which lists information about the selected asset's properties. See Viewing Asset Attribute Information on page 1-72. |
| Damage Assessment... | Opens the Damage Assessments window, which displays a list of damage assessments associated with the asset selected in the Viewer and allows you to add new damage assessments. See Using the Damage Assessments Tab on page 2-12. |
| Toggle Call Display | Toggles the call display on or off. When enabled, a symbol is displayed in the Viewer window for any assets that have calls associated with the event. This option is only available on Control Tools that are opened from a predictable outage asset, such as a valve or pump, which has an open associated event. |
| Customer List... | Displays the customers downstream from an asset. |
| Switching Plans... | Allows you to open a switching plan associated with the asset. If multiple plans are associated with the asset, the Asset to Sheet Operation List displays a list of switching sheets and associated operations. Each operation represents a step in the switching sheet. Select a sheet operation and click Open . See Web Switching Management on page 8-1 for more information on using Web Switching Management. |
| Generate Isolate Steps... | Allows you to generate a set of steps in the active switch sheet to isolate the selected pipe. These will appear in a new "Isolate" steps block. Sub-options allow you to ignore assets with certain conditions on them. |
| Safety Documents... | Allows you to open or create safety documents associated with the asset. See Opening Existing Safety Documents on page 8-92 or Create a New Safety Document from the Control Tool on page 8-106. |
| SCADA Summary... | Opens the SCADA Summary window. See Using the SCADA Summary on page 7-3 for more information. |
| Date and Time | Allows you to record the date and time an operation was performed. The field defaults to the current date and time, but you can adjust the date using the up and down arrow buttons next to the field. The date and time of the operation displays in the Event Recorder window. Note that this will also affect reported outage times. |
| Help | Displays Control Tool help. |
| Exit | Closes the Control Tool. |

Highlighting Events in the Work Agenda

If an event is associated with a selected asset, you can find it in the Work Agenda window using the Control Tool's **Highlight Event** button. You must have the correct view of the Work Agenda window open in order to see the highlighted event (for example, the In Progress list).

Note: If there are multiple events associated with an asset, only the first one found will be highlighted. See also [Work Agenda Interaction with Event Condition Symbols](#) on page 1-55.

Viewing Documents Associated with an Asset

To view documents associated with an asset, complete these steps:

1. Open a Viewer window. Locate an asset that has an associated document you wish to view. (Assets with associated documents have a "**DOC**" condition symbol.)
2. Open the asset's Control Tool.
3. Select the Control Tool's **View Documents...** option. The Manage Documents window will open listing any associated documents for the selected asset.
4. Select the document and click **View Document**; the document will open for viewing.
5. Click **Exit** to close the Manage Documents window.

For instructions on associating documents to assets, see [Associating Documents with Assets](#) on page 1-80; note that this function is available only to administrative users.

Adding Notes

The Control Tool allows you to place notes on assets. Notes may be created or opened by clicking the Control Tool **Note...** button, which will open the **Condition Data** dialog box. Existing notes for the selected asset are listed in the **Conditions** pane.

Note: Note text is also displayed in the Asset Details balloon (see [Displaying Asset Details](#) on page 1-44)

Condition Data Dialog Box

The Condition Data dialog box displays the following fields and buttons:

- **Fields**
 - The **Condition Type** field displays the condition type of note.
 - The **Object** field displays the asset object class.
 - The **Object Name** field displays the assetname or ID.
 - The **Conditions** pane contains a table that lists existing notes.
 - The **Condition Text** field displays the text of the selected note.
- **Buttons**
 - The **New** button allows you to enter a new note.
 - The **Edit** button allows you to edit the text of the selected note.
 - The **Delete** button deletes the selected note.
 - The **Cancel** button closes the Condition Data dialog box without saving changes.

Creating a Note

You can create one or more notes for an asset using the Control Tool. Once you save a note, a note symbol displays in the Viewer next to the asset. If you create multiple notes for an asset, the number of notes is displayed in parentheses next to the note symbol.

To enter a note, complete these steps:

1. In the Viewer, open the Control Tool for the asset.
2. Click the Control Tool's **Note...** button. The Condition Data dialog box opens.
3. Click the **New** button. The **Condition Text** pane's label changes to **Add/Edit Text**.
4. Click in the **Add/Edit Text** field, and enter the note text.
5. Click **Save**. The note is saved and listed in the **Conditions** pane. A note symbol appears in the Viewer next to the asset. As notes are added to the asset, the number of notes is displayed in parentheses next to the note symbol.

Editing a Note

To edit an existing note from the Control Tool, complete these steps:

1. In the Viewer, open the Control Tool for the asset.
2. Click the **Note...** button. The Condition Data dialog box opens with existing notes listed in the **Conditions** pane.
3. Select the note that you want to edit; the note text will display in the **Condition Text** pane.
4. Click the **Edit** button. The **Condition Text** pane changes to an Add/Edit Text field.
5. In the **Add/Edit Text** field, edit the note text as needed.
6. Click **Save**. The note is saved.

Deleting a Note

You can delete a note once it no longer applies to the asset or the event.

To delete a note, complete these steps:

1. In the Viewer, open the Control Tool for the asset.
2. Click the **Note...** button. The Condition Data dialog box opens with existing notes listed in the **Conditions** pane.
3. Select the note that you want to delete.
4. Click the **Delete** button. The note is deleted from the Condition Data dialog box.
 - If the deleted note was the only note for the asset, then the note symbol disappears from the Viewer.
 - If there is one note remaining, the number of notes displayed in the Viewer is removed.
 - If there are two or more notes remaining, the new number of notes is displayed in the parenthesis.

Viewing Asset Attribute Information

You can use the Control Tool to access attribute information for an asset. Attributes include physical and reference information about an asset, such as location and manufacturer.

To view asset attributes using the Control Tool, complete these steps:

1. Open the Control Tool for an asset.
2. Click the **Attributes...** button. The Attributes window opens.

Note: The information displayed in the Attributes window is variable based on the available data and what your implementation configured to display for an asset type.

See also [Viewing Asset Attribute Information from the Viewer](#) on page 1-46.

Toggling Call Display

You can view the calls associated with an event in the Viewer by clicking the **Toggle Call Display** button. A symbol appears attached to any transformers serving customers that have calls associated with the event. If there were multiple calls with the same "clues" then a number will appear in parentheses next to the call symbol. To hide the symbols, open the Control Tool from the asset and click the **Toggle Call Display** button again.

Viewing Associated Customers

To view the customers on and downstream from an asset, click the Control Tool **Customer List...** button. The Event Details window opens showing the **Trouble Info** tab's **Customers** views, which lists all customers on and downstream from the asset.

Note: You cannot change to the **Trouble Info** tab's **Calls** view when you open Event Details from the Customer List option.

If the selected asset is de-energized, the list will display all customers downstream from it in the nominal model configuration. From this page, you can initiate a ping request, as well as monitor previous ping results. See [Using the Trouble Info Tab](#) on page 2-6 for more information.

Operating Assets

You can open or close an asset in the Viewer to reflect the current state of the asset in the field. The Control Tool's available asset operation options depend on the status of the asset. For example, a Control Tool opened from an open asset will only allow you to close the asset. In real-time mode, you must have authority over the control zone where the asset is located in order to operate the asset.

Closing an Asset

To close an asset:

1. Open the Control Tool for an open asset.
2. Click **Close**.

Undoing the Close Operation

You can undo a **Close** operation, which is different than opening an asset. With the **Undo Close** operation, any RDO that would have been restored will revert back to a predicted outage. As a result, no restore time is set for the associated event and the event remains active.

Opening an Asset

To close an asset:

1. Open the Control Tool for a closed asset.
2. Click **Open**. The asset opens.

Instructing Actions

Many **Operate** options, such as **Open** or **Close**, will have an **Instruct** version (for example, **Instruct Open**). These do not perform the action in the model, but instead place an Instruct condition in the model, which indicates that another party (usually a crew) has been instructed to perform the action.

Instructed actions display the Look Ahead and other warnings and errors, but, if the action is being recorded in a switching sheet, the Look Ahead and associated errors and warnings display data as if the instructed steps in that sheet were already completed, which allows you to instruct actions in the Control Tool that are dependent upon instructed actions in the current sheet. This will also give you the correct customer count as if the instructed steps were already executed. This considers all instructed steps in the single active sheet only if recording is on and the mode matches the Control Tool's, and then applies them to the model in the order that they were instructed (using the Instructed Date field). The instructed actions can then be completed in the sheet or in the Control Tool's **Instructed Actions** panel.

Instructed Actions Panel

The Instructed Actions panel provides a way of recording results of instructed actions from the Control Tool rather than through an Emergency Switching Sheet, Standalone Safety Document, or the Miscellaneous Log. When an action is instructed, the panel's buttons are enabled so you can record the response.

To record instructed actions results:

1. Open the Control Tool for an asset.
2. Click the **Operate...** button.
3. Select an instruct operation, such as **Instruct Open**. The Instructed Actions pane will become sensitized.
4. At this point, the crew would be instructed to open the asset and would report back whether:
 - they completed the action
 - they aborted the action
 - the action failed
5. Click the button corresponding to the result.

You may also click the **Show Sheet** button to open an associated Emergency Switching Sheet or Standalone Safety Document (if one exists) or the Miscellaneous Log if there is not an existing Emergency Switching Sheet or Standalone Safety Document.

Note: This example assumes a crew is in the field being instructed to perform certain operations. The sequence of events is designed to be illustrative of the Control Tool actions rather than a suggested workflow for field operations.

Related

- [Emergency Switching](#) on page 8-68.
- [Using the Miscellaneous Log](#) on page 8-98.
- [Using Stand Alone Safety Documents](#) on page 8-107.

Tagging Assets

You can tag assets in the Viewer window that are physically tagged in the field. Tags placed on assets in the system prevent users from performing open or close operations on the asset. When you place a tag on an asset, a tag symbol appears attached to that asset in the Viewer. You can place multiple tags on a single asset. When you do, the number of tags on the asset appears in parentheses next to the tag in the Viewer. You must have authority over the control zone containing the asset in order to tag the asset.

Placing a Tag

To place a tag on an asset:

1. Open the Control Tool for the asset.
2. Click the **Place Tag** button. A tag symbol displays next to that asset in the Viewer. If a tag symbol already existed (the asset had at least one current tag), a number in parentheses next to the tag symbol will indicate the updated current number of tags.

Removing a Tag

To remove a tag from an asset:

1. Open the Control Tool for the asset.
2. Click the **Remove Tag** button. The Remove Tag dialog box opens, displaying a list of the tags on that asset, including when the tag was placed and the user who placed it.
3. Select the row of the tag that you want to remove, and click the **Remove** button. The tag is removed. The number next to the tag symbol is decreased by one, unless there is now only one tag left, in which case the number is removed. If the last tag is removed, the tag symbol is removed from the Viewer.

Repredicting Upstream/Downstream

You can force the system to manually repredict a predicted outage either upstream or downstream from the current system predicted asset. This is typically done when a crew finds that the problem is not at the predicted asset.

- If the asset is supplied, the problem is actually one or more downstream outages.
- If the asset is not supplied, the problem will actually be upstream.

Clicking the **Repredict Upstream** or **Repredict Downstream** button manually repredicts the outage to the next predictable upstream or downstream asset. When repredicting downstream, the system distributes the event to one or more assets. Once a predicted outage is manually repredicted upstream or downstream, the system will treat the repredicted outages as non-grouping and no longer automatically repredict them.

For example, a crew finds that a predicted service outage (indicated by the "PSO" symbol) at a customer point is not actually where the trouble is located. Using the Control Tool, you can repredict the outage upstream to a different valve. When you repredict the outage, the valve displays a "PDO" (predicted outage) symbol. The original predicted service outage displayed in one of Work Agenda's Trouble Events list windows changes to a predicted outage located at the valve.

Using the Look Ahead Dialog Box

The Look Ahead dialog box provides information concerning the results of performing a requested asset operation. The Look Ahead dialog box uses system status and topology tracing to "look ahead" of the requested operation and determine its consequences.

The Look Ahead dialog box displays whenever you attempt to perform an action that would result in the distribution system status or topology changing (that is, a switching operation). Once you have looked at key information in the Look Ahead dialog box, you may perform or cancel the operation.

This section includes the following topics:

- [Understanding the Look-Ahead Process](#)
- [Drop Count Tab](#)
- [Pickup Count Tab](#)
- [View Conditions Tab](#)
- [View Abnormal Tab](#)
- [View Critical Tab](#)

Understanding the Look-Ahead Process

The Look Ahead dialog box displays whenever a switching operation is initiated from the Control Tool in supplied or un-supplied portions of the distribution system. The Look Ahead dialog box displays a warning if an operation will create or break loops or parallels. Counts, conditions, and abnormal asset information are not available when dealing with loops and parallels.

If the operation will outage or restore the system, additional data is gathered and displayed in the Look Ahead dialog box. The information displayed depends on the results of performing the operation. A tab is enabled only if table information is available. You cannot open or close an asset until you view any abnormal assets or conditions (see [View Abnormal Tab](#) on page 1-79).

Note: If you attempt to close a valve in an outage area, the system displays the Create Nested Outage dialog box before displaying the Look Ahead dialog box. The dialog box provides the following options:

- Click **Yes** to create a nested outage.
- Click **No** to close the valve without creating a nested outage.
- Click **Cancel** to cancel the operation.

The following flow diagram below shows the basic logic of the Look Ahead dialog box.

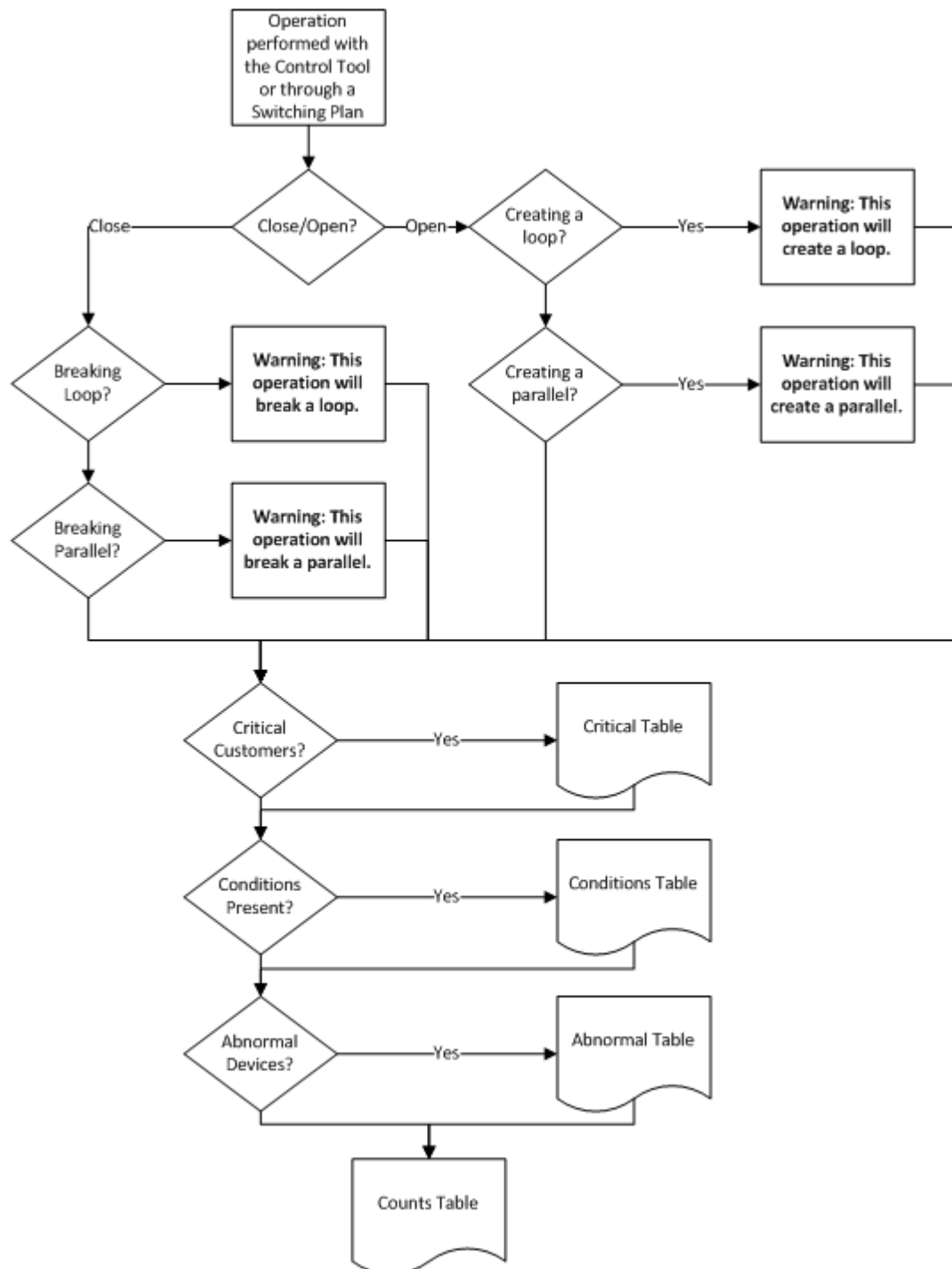

The Look Ahead Dialog Box

The Look Ahead dialog box contains tabs and tables that display event and asset-related information. The items on the Look Ahead dialog box are described below:

- [Header](#)
- [Drop Count Tab](#)
- [Pickup Count Tab](#)
- [View Conditions Tab](#)
- [View Abnormal Tab](#)
- [View Critical Tab](#)

Header

- **Information Provided**
 - The **Asset** field displays the name of the asset being operated.
- **Buttons**
 - **Preview:** allows you to generate a trace in Viewer that highlights the area affected by the asset operation. For example, if you open an asset and click the **Preview** button, the Viewer displays the network area that will be outaged.

Note: The **Preview** button is only enabled when the network is going to be outaged. When the Look Ahead is closed (by confirming the operation or clicking **Cancel**), the trace highlighting will be removed.

Drop Count Tab

The Drop Count tab displays the number of customers affected by the asset operation. This tab provides information for Total Customers and total Critical Customers, with sub counts for four groups of critical customers.

- The **Drop** columns display the drop information for the asset. Information is displayed as counts dropped downstream of the asset.
- The **Pressure Zone** column display the total counts for the pressure zone on which the asset to operate is located.

Pickup Count Tab

The Pickup Count tab displays the number of customers affected by the asset operation. This tab provides information for Total Customers and total Critical Customers, with sub counts for four groups of critical customers.

- The first set of two columns shows data for the total counts.
- The **Pickup** columns display the pickup information for the asset. Information is displayed as counts picked up downstream of the asset.
- The **Pressure Zone** columns display the total counts for the pressure zone on which the asset to operate is located.

View Conditions Tab

The View Conditions tab shows any special conditions currently active, including crew locations, tags, notes, and so on. If conditions are present, you must view the conditions table to complete the operation. Click on the View Conditions tab to access condition information.

The Conditions table displays the following columns:

- The **Condition** column displays the type of condition that is present on the pressure zone such as a truck_location (crew), tag, note, and so on.
- The **Asset** column displays the name of the asset on which the condition is located.

- The **Location** column indicates whether the condition is upstream or downstream of the current asset.
- The **User Name** column displays the user name of the user that created the condition.
- The **Date/Time** column displays the date and time that the condition was created.
- The **Description** column displays information about the condition. For example, if the operation affects an asset with an associated document, the file name would be listed.

View Abnormal Tab

The View Abnormal tab displays data about abnormal assets on the same pressure zone as the asset to operate. An “abnormal asset is any asset that is not in its nominal state (for example, an open valve that is normally closed).

The Abnormal table displays the following columns:

- The **Asset** column displays the name of the asset that is in an abnormal state.
- The **Nominal Status** column displays the normal status of the asset.
- The **Current Status** column displays the current status of the asset.

View Critical Tab

The View Critical tab shows customers classified as critical (for example, emergency, medical, key) that would be impacted by the proposed asset operation.

The Critical Customers table displays the following columns:

- The **Name** column displays the critical customer's name.
- The **Critical Type** column displays the critical classifications for the customer.
- The **Address** column displays the critical customer's address.
- The **Phone** column displays the critical customer's telephone number.

Buttons

- The **Open** button opens the asset. If an "open" operation is being performed on a closed asset, the **Open** button is enabled. If special conditions exist, then you must view the **View Conditions** tab before the **Open** button becomes enabled. Likewise, if abnormal asset statuses exist, then you must view the **View Abnormal** tab before the **Open** button becomes enabled.
- The **Close** button closes the asset. If a "close" operation is being performed on an open asset, the **Close** button is enabled. If special conditions exist, then you must view the **View Conditions** tab before the **Close** button becomes enabled. Likewise, if abnormal asset statuses exist, then you must view the **View Abnormal** tab before the **Close** button becomes enabled.
- The **Help...** button opens the online help content for Look Ahead.
- The **Cancel** button cancels the asset operation and closes the Look Ahead dialog box.

Associating Documents with Assets

The Manage Documents window allows **Administrative users** to create and remove associations between modeled asset and documents that are stored in the Oracle Utilities Network Management System.

Using the Manage Documents Window

To open this window, select **Manage Documents...** from the Web Workspace **Tools** menu.

The Manage Documents window displays the following fields and buttons:

- The **Selected Asset** field lists the asset selected in the Viewer.
- The **Manage Documents** field lists any documents associated to the asset.
 - The **Unassociate** button allows you to remove the association between the selected asset and a document selected in the Manage Documents field.
 - The **View Document** button allows you to view the selected document.
- The **Available Documents** field lists the contents of the `§CES_DRAWINGS` directory (that is, `§NMS_HOME/data/drawings`). Use the blank text field to filter the Available Documents list. Enter all or part of the document you are looking for; the list is dynamically updated to display document names that include the text you enter.

Note: Documents must be saved directly to the `§CES_DRAWINGS` directory as any files saved to sub-directories will not be visible to the tool.
- The **Associated Assets** field lists which assets have an association with the currently selected item in the Available Documents list.
- The **Associate** button allows you to associate the currently selected item in the Available Documents list with the Selected Asset.
- The **View Document** button allows you to view the currently selected item in the Available Documents list.
- The **Exit** button closes the Manage Documents window.

Associating a Document with an Asset

To associate a document with an asset, complete these steps:

1. Login to Web Workspace as an Administration user.
2. Select **Manage Documents...** from the Web Workspace **Tools** menu. The Manage Documents window opens. (See the previous section for field descriptions.)
3. Open a Viewer. Locate and select the asset to associate to a document. The Manage Document window's Selected Asset field populates with the name of the selected asset.
4. Select the item from the Available Documents list that you wish to associate with the selected asset. The **Associate** and **View Document** buttons are activated.
5. [Optional] Click **View Document** to display the document in an external viewer. For example, viewing a JPEG file might open the file in Windows Photo Viewer.
6. Click **Associate** to create the association between the selected document and selected asset. The following occurs:
 - The Manage Documents list populates with the document's filename and the Associated Assets field populates with the name of the selected asset.
 - In the Viewer, a document condition now appears on the selected asset.
7. Click **Exit** to close the Manage Documents window.

Removing a Document Association

To remove an association between a document and an asset, complete these steps:

1. Login to Web Workspace as an Administration user.
2. Select **Manage Documents...** from the Web Workspace **Tools** menu. The Manage Documents window opens.
3. Open a Viewer. Locate and select the asset that you wish to disassociate from a document. The Manage Document window's Selected Asset field populates with the name of the asset and the Manage Documents pane lists all associated documents.
4. In the Manage Documents list, select the document you wish to disassociate from the asset. The **Unassociate** and **View Document** buttons are activated.
5. [Optional] Click **View Document** to display the document in an external viewer. For example, viewing a JPEG file might open the file in Windows Photo Viewer.
6. Click the **Unassociate** button to remove the association between the selected document and selected asset. The following occurs:
 - The selected document is removed from the Manage Documents list.
 - In the Viewer, a document condition is removed from the selected asset.
7. Click **Exit** to close the Manage Documents window.



Associating Damage Assessments to an Asset

You can enter damage assessment for an asset. Damage assessment incidents are not included in counts for the event. The damage assessment trouble code has an associated clue symbol Damage Assessment clue symbol (letters 'DA' in a red circle), which will be displayed in Viewer at the damage location.

When you enter damage assessment information, you can select one or more crew types needed to repair the reported damage.

If multiple damage assessments exist for an event, the system will calculate the estimated repair time by adding together estimated repair times from each active damage assessment.

To enter damage assessment information for an asset, complete the following steps:

1. Open the Viewer.
2. Select an asset and open its Control Tool.
3. Click the Control Tool's **Damage Assessment...** button. The Event Details Damage Assessments tab opens for the selected asset. Any existing damage assessment records for the asset will be displayed in the list.
4. Click the **New Damage Assessment**  toolbar button. The Damage Assessment window opens.
5. Complete additional fields on this screen as needed. See [Understanding the Damage Assessment Window](#) on page 2-25 for field descriptions.
6. Click the **Save** button on the toolbar.
7. New damage assessment is created. In the Viewer, a damage assessment symbol appears on the asset. The damage assessment would either create new event or group into an existing event.
8. Once the damage has been assessed, populate the Damage Specifics, Required Material, and Attachments sections and click the **damage has been assessed**  toolbar button to indicate that the damage assessment has been performed. The status of the damage

assessment changes to Assessed. Estimated Time to Repair for the event may get updated based on entered damage details.

Completing and Instructing Actions

When you perform actions in the Control Tool while you are recording in Web Switching Management, the system automatically populates fields in the associated switching sheet as follows:

- The date field on the Control Tool, which defaults to the current date and time, is used to populate the Completed Date field in the associated switching sheet when an operation is completed in the Control Tool.
- If steps are instructed to a crew, this date is used to populate the Instructed Date field in the switching sheet.

The **Instructed Actions** area below the date field displays a list of actions that have been instructed on the selected asset. The drop-down allows you to select an instructed action to complete.

The **Show Sheet...** button displays the sheet that contains the selected instructed action so you can execute the actions from Web Switching Management.

Note: This option is available only when Web Switching Management is licensed. This allows you to navigate to the switching sheet so you can perform the step from there. If you are not using Web Switching Management, you can **Complete, Abort, or Fail** the selected instructed action from the Control Tool.

Condition Summaries

The Condition Summaries window lists all conditions, including notes, tags, pending decommissions, and pending

This section includes the following topics:

- [Using the Condition Summaries Window](#)
- [Toolbar and Menu Options](#)
- [Using Condition Summaries Balloon Details](#)
- [Editing or Deleting Conditions](#)

Using the Condition Summaries Window

To view the Condition Summaries window, select **Condition Summaries...** from the Web Workspace **Actions** menu in.

The Condition Summaries includes the following fields and buttons:

- The **Type** column contains the type of condition, such as Note, Tag, Pending Construction, Pending Decommission, and Associated Document.
- The **Status** contains the status of the condition. Usually blank, but will list "Issued" for conditions that are part of an issued safety document. Other values may be configured.
- **Condition #** is the system-assigned identifier of the condition.
- The **Date Created** column contains the date and time the condition was created.
- The **Lift Station** column contains the name of the lift station that serves the asset on which the condition is located.
- The **Pressure Zone** column contains the name of the pressure zone that serves the asset on which the condition is located.
- The **User** column contains the user name of the individual who placed the condition.
- The **Asset** column contains the name of the asset on which the condition is located.
- The **Condition Info** column contains the text of the note or other condition.



Sorting and Filtering

The Conditions Summaries table supports common sorting and filtering functions. The predefined filters are based on the Condition Type; for example, the **Notes** filter selects all rows where the Type column has a value of *Note*.

See [Sorting and Filtering Data](#) on page 1-15 for additional information on using standard sorting and filtering features.

Toolbar and Menu Options

File Menu

| Menu Option | Description | Toolbar Icon |
|------------------|--|---|
| Refresh | Refreshes the Condition Summaries window to display the most recent updates. If you edit a condition using the Edit button, you must refresh the summary to see your changes. |  |
| Print Preview... | Displays the Print Preview window, from which you can view and print the summary. |  |
| Delete Row... | Deletes the selected condition from the system. A confirmation dialog box prompts you to confirm before deleting. Once deleted, the condition disappears from both the Summary and the Viewer. |  |
| Exit | Closes the Condition Summaries window. | -- |



Sort Menu

| Menu Option | Description | Toolbar Icon |
|----------------|---|--------------|
| Sort Dialog... | Displays the Sort Dialog. The Sort Dialog option on the Sort menu performs the same function. See Using the Sort Dialog on page 1-15 for common sort functions. | |
| Condition # | Sorts the Conditions Summaries table by the Condition # column. | -- |
| Asset | Sorts the Conditions Summaries table by the Asset column. | -- |
| Date Created | Sorts the Conditions Summaries table by the Date Created column. | -- |

Filter Menu

| Menu Option | Description | Toolbar Icon |
|----------------------|--|--------------|
| Filter Dialog... | Displays the Filter Dialog box. The Filter Dialog option on the Filter menu performs the same function. See Using the Filter Dialog on page 1-17 for more information. | |
| All Conditions | Displays all conditions. | -- |
| Notes | Displays only rows with Type equal to <i>Note</i> . | -- |
| Pending Construction | Displays only rows with Type equal to <i>Pending Construction</i> . | -- |
| Pending Decommission | Displays only rows with Type equal to <i>Pending Decommission</i> . | -- |
| Tags | Displays only rows with Type equal to <i>Tag</i> . | -- |

Actions Menu

| Menu Option | Description | Toolbar Icon |
|---------------------|---|---|
| Edit... | Opens the Edit balloon dialog box. See Editing or Deleting Conditions on page 1-87. |  |
| Enable View Balloon | Enables or disables balloon details. When enabled, a callout-like balloon opens that provides information, such as notes or related asset documents, for the selected row. See Using Condition Summaries Balloon Details on page 1-87 for more information. |  |
| View... | Focuses the Viewer on the asset associated with the condition. |  |

Help Menu

| Menu Option | Description | Toolbar Icon |
|--------------------------|---|--------------|
| Condition Summaries Help | Opens the online help system to the Condition Summaries help content. | -- |

Using Condition Summaries Balloon Details

The Condition Summaries Balloon Details displays asset information (for example, note text and associated documents) for rows selected in the Condition Summaries list.

To enable Balloon Details:

1. Click **Balloon Details** () on the Condition Summaries toolbar. When enabled, the toolbar behind the Balloon Details button will be highlighted.

To view condition details:

1. Select a row in the Condition Summaries table. Balloon Details displays applicable information about the selected condition.
2. To close the balloon, click the close button in the balloon's top right corner.

Editing or Deleting Conditions

To edit a selected condition, click the **Edit** button. The Edit balloon opens. This dialog box also appears if you double-click a condition when Balloon Details are turned off.

From this dialog box, you can perform the following tasks:

- Edit the condition information as desired, then click the **Save** button.
- Click the **View** button to focus the Viewer on the asset.
- Click the **Print** button to print the condition text.
- Click the **Revert** button to revert to the last saved version of the condition text.
- Click the **Help** button to launch online help for the dialog box.
- Click the **Delete** button to delete the condition.

Note: You can also delete a condition by selecting the condition row and clicking the delete button from the Condition Summaries toolbar.

Using the Alarms and Assets Lists

The Alarms and Assets Lists window provides the following views:

- [Abnormal Assets List](#)
- [Asset Operations List](#)
- [SCADA Alarms List](#)
- [System Alarms List](#)

To display the Alarms and Assets Lists window, select **Alarms and Assets Lists** from the Web Workspace **Tools** menu, then select one of the views listed above.





Menus and Toolbar

File Menu

| Menu Option | Description | Toolbar Icon |
|-----------------|--|---|
| Print... | Opens the print dialog box to allow you to print the current list. |  |
| Exit | Closes the window. | |

Actions Menu

Action menu options vary by the list view.

| Menu Option | Description | Toolbar Icon | Views |
|--------------------|---|---|---|
| Acknowledge | Acknowledges the selected alarms. |  | <ul style="list-style-type: none"> • System Alarms |
| Clear | Clears the selected alarms. |  | <ul style="list-style-type: none"> • SCADA Alarms • System Alarms |
| Silence | Silences the selected alarms. |  | <ul style="list-style-type: none"> • SCADA Alarms • System Alarms |
| View... | Shows the associated asset in the Viewer. |  | <ul style="list-style-type: none"> • Abnormal Assets • Asset Operations • SCADA Alarms |

Note: Toolbar action options are also displayed as context menu options when you right-click a row in a list view.

Filter Menu

| Menu Option | Description | Toolbar Icon |
|------------------------------|--|---------------------|
| Show Filter Dialog | Opens the Filter Dialog, allowing you to create, modify, apply, and save user-defined filters. | -- |
| Abnormal Assets List | Opens the Abnormal Assets view. | -- |
| All | Displays all alarms of the selected alarm type. | |
| Asset Operations List | Opens the Asset Operations view. | -- |
| SCADA Alarms List | Opens the SCADA Alarms view. | -- |
| System Alarms List | Opens the System Alarms view. | -- |

Help Menu

| Menu Option | Description | Toolbar Icon |
|--------------------|--------------------------------|---------------------|
| Help | Opens the online help content. | -- |

Abnormal Assets List

The Abnormal Assets view displays all assets that are not in their nominal state. For example, if a valve that is nominally closed is currently open, it will display in the Abnormal Asset Summary. If a SCADA system is integrated with Oracle Utilities Network Management System, any assets that are reported by a SCADA point as being in an off-nominal state will also display. This will also display any main breaks.

To access the Abnormal Asset Summary, select **Alarms and Assets Lists** and then **Abnormal Asset Summary...** from the Web Workspace **Tools** menu.

The Abnormal Assets List displays the following fields:

- The **Date** column contains the date and time that the asset was last operated.
- The **Pressure Zone** column contains the name of the pressure zone that serves the abnormal asset.
- The **Asset** column contains the name of the abnormal asset.
- The **Description** column contains a description of the operation that caused the abnormal state.
- The **Source** column contains the source of the abnormal operation.
- The **Value** column contains the current state of the asset.
- The **Attribute** column contains the type of operation. In the Abnormal Assets List, this column displays 'status.'
- The **Nominal** column contains the normal state of the asset.

Asset Operations List

The Asset Operations List displays all recent operations performed in the user's control zones.

To access the Asset Operations List, select **Alarms and Assets** and then **Alarms and Assets Operations List...** from the Web Workspace **Tools** menu.

This list displays the same columns as the [Abnormal Assets List](#).

SCADA Alarms List

The SCADA Alarms view is only available if your system supports SCADA extensions. For more information about SCADA extensions, see [SCADA Extensions](#) on page 7-1.

To access the SCADA Alarms List, select **Alarms and Assets Lists** and then **SCADA Alarms List...** from the Work Agenda **Tools** menu.

The SCADA Alarms List displays the following fields:

- The **Date** column contains the date and time the alarm was generated.
- The **Pressure Zone** column contains the pressure zone on which the asset in the alarm is located.
- The **Asset** column contains the identification of the asset associated with the alarm.
- The **Description** column contains a description of the alarm.
- The **Source** column contains the originator of the alarm.
- The **Value** column contains the last reported measurement value. The value can be status, digital, or analog. For status measurements, typically a value of "0" indicates open and a value of "1" indicates closed. Any special tags placed on the asset would be indicated by a digital value.

- The **Attribute** column contains the type of SCADA measurement (for example, pressure, temperature).
- The **Nominal** column contains the nominal state of the asset.
- The **Quality** column provides additional information about the SCADA measurement (for example, out of scan, inhibited, manual override) that is in alarm.
- The **Limit** column contains the configurable threshold value. If the analog crosses a low or high threshold, the system creates a limit alarm, and the threshold value appears here.
- The **Who Ack** column contains the ID of the user who acknowledged the alarm.
- The **Time Ack** column contains the date/time stamp when the alarm was acknowledged.
- The **Silenced** column indicates whether a row has been silenced.

System Alarms List

The System Alarms List displays a list of all system alarms.

To access the System Alarms List, select **Alarms and Assets Lists** and then **System Alarms List...** from the Web Workspace **Tools** menu.

The System Alarms List displays the following fields:

- The **Date** column contains the date and time the alarm was generated.
- The **Description** column contains a description of the alarm.
- The **Source** column contains the originator of the alarm.
- The **Who Ack** column contains the ID of the user who acknowledged the alarm.
- The **Time Ack** column contains the date/time stamp when the alarm was acknowledged.
- The **Silenced** column indicates whether a row has been silenced.

Acknowledging Alarms

To acknowledge an alarm, complete these steps:

1. In the Alarms and Assets List, select the row of the alarm you want to acknowledge.
2. Click the **Acknowledge** button. The following occurs:
 - The alarm becomes acknowledged.
 - Its audible alarm is silenced.
 - Your user name appears in the Who Ack field.
 - The current date and time appears in the Date Ack field.
 - The Silenced column is populated with a "Y."

Silencing Alarms

To silence an alarm, complete these steps:

1. In the Alarms and Assets List, select the row of the alarm you want to silence.
2. Click the **Silence** button.
 - The audio notification for the alarm becomes silent.
 - The alarm is still not acknowledged.
 - The Silenced column is populated with a "Y."

- Subsequent new alarms will cause the audio notification to sound.

Note: To turn audio notifications on or off, select **Audio Enabled** from the Web Workspace **Preferences** menu. The audio for the entire system (all alarms) will toggle on or off. See [Preferences Menu](#) on page 1-8.

Clearing Alarms from the List

To remove an alarm from the Alarms and Assets List, complete these steps:

1. In the Alarms and Assets List, select the row of the alarm you want to silence.
2. Click the **Clear** button. The alarm disappears from the list.

Note: You can remove multiple alarms by selecting multiple rows before you click the **Clear** button.

Preventing an Asset from Reporting SCADA Alarms

To prevent an asset from reporting Alarms, complete these steps:

1. In the Alarms and Assets List, select the row of an alarm that belongs to the asset you want to inhibit.
2. Click the **Inhibit Alarm** button.
 - The asset will not report SCADA alarms until the inhibit is cancelled.
 - An "I" appears next to the asset in the Viewer indicating the asset is inhibited.
 - An "I" appears in the Quality columns of the SCADA Alarms List and the SCADA Summary.

Note: Inhibiting alarms does not affect the physical SCADA asset; it only prevents Oracle Utilities Network Management System SCADA Extensions from reporting an incoming alarm.

Using the User Log

The User Log displays a log of actions taken by a user.

To open the User Log, select **User Log...** from the Web Workspace **Tools** menu.

The User Log window displays the following fields:



- The **User ID** field opens with the current user's identification, but the field may be edited to load log entries for a different user; for a different user log, enter their user ID and click **Load User Log** button ()
- The **Begin Time** and **End Time** fields allow you to filter the User Log by time. To load log entries for a specific time period:
 - Enter a starting date in the Begin Time field.
 - Enter an ending date in the End Time field.

Note: You can enter a beginning date, an ending date, or both.





 - Click the **Load User Log** button () . The list is refreshed to display only entries with a date and time greater than or equal to the Begin Time and less than or equal to the End Time.
- The **User Comment** field allows you to enter a user comment log entry.
- The **User Log Table** has the following fields:
 - The **Date/Time** field displays the date/time at which the log entry occurred.
 - The **Event** field displays the Event # associated with the log entry.
 - The **Text** field displays a description of the log entry.
 - The **Sheet/Doc #** field displays the switching sheet or safety document number associated with the log entry.

Menus and Toolbar

File Menu

| Menu Option | Description | Toolbar Icon |
|------------------------|---|---|
| Export Table... | Opens a dialog box to allow you to save the table data to a comma separated value (csv) file. |  |
| Print... | Opens the print dialog box to allow you to print the current list. |  |
| Exit | Closes the window. | |

Actions Menu



| Menu Option | Description | Toolbar Icon |
|-------------------------|---|---|
| Load User Log | Loads the User Log for the for the current filter parameters (User ID, Begin Time, and End Time). |  |
| Clear | Clears the user log. |  |
| View... | Displays the asset associated with the log entry in the Viewer. |  |
| Event Log... | Displays the Event Log for a selected user log entry associated with an event. | |
| Event Details... | Displays the Event Details window for the event associated with the selected log entry. This option is also available from the context menu. |  |
| Switching... | Displays the switching sheet or safety document associated with the selected log entry. Enabled only when the log entry is associated with a switching sheet or safety document. This option is also available from the context menu. |  |

Help Menu

| Menu Option | Description | Toolbar Icon |
|----------------------|--|--------------|
| User Log Help | Opens the online help system to the User Log help content. | |

Adding Entries to the User Log

Comments may be entered for the current time or for the time associated with a selected log entry. When you begin to add text to the **User Comment** field, the button to add the entry will be sensitized; there are two types of buttons based on whether a row is selected in the User Log table

() or not ()

Adding New User Log Entries

To enter a new note to the User Log:

1. Enter the note text in the field and click the add button () to submit the entry.

Note: The **User Log** does not automatically refresh on other user environments, so the new comment will not appear in the table for other users until the user log is reloaded by clicking the **Load User Log** button ()

Adding an Associated User Log Entry



To enter a note associated to an existing User Log entry:

1. Select a User Log entry row to associate to a new note.
2. Enter the note text in the field and click the add to selected entry button () to submit the entry.

Note: The **User Log** does not automatically refresh on other user environments, so the new comment will not appear in the table for other users until the user log is reloaded by clicking the **Load User Log** button ()

Changing Entry Type Before Submitting User Log Entry

When you begin to add text to the User Comment field and the add button becomes sensitized, you may select or deselect a row to change the entry type.

For example, you want to enter a new note, but realize that the add associated comment button () is sensitized, press Control and click the selected row to deselect it; the button will change to the add new entry button ()

Chapter 2

Web Trouble

This chapter describes the Oracle Utilities Network Management System Web Trouble application. It includes the following topics:

- [Overview](#)
- [Managing Events with Web Trouble](#)
- [Managing Crews with Web Trouble](#)

Overview

Oracle Utilities Network Management System - Web Trouble augments the Web Workspace module with event and crew management capabilities. Web Workspace's crew dispatch and management functions facilitate operations in daily maintenance and outage restoration situations.

Managing Events with Web Trouble

Web Trouble includes tools that build upon the Web Workspace to help you manage trouble events. This section describes those tools and how to perform basic event functions. It includes the following topics:

- [Managing Crews with Web Trouble](#)
- [Event Details](#)
- [Setting Work Queues](#)
- [Event Grouping](#)
- [Associating and Unassociating Calls with Assets or Control Zones](#)
- [Working with Damage Assessments](#)
- [Updating the ERT for Selected Events](#)
- [Setting the System-Wide Estimated Restoration Time](#)

Managing Crews with Web Trouble **Event Details**

The **Event Details** window is used to enter and track information about the cause of an event and how the event is resolved. It displays event information, including crew contact details, both the begin and restoration times for the event, any partial restoration steps, and the operations event note. Some information is automatically added to **Event Details**, and you can manually override some of this data. In addition, you can complete events from this window, giving you an opportunity to enter more detail about the event and validate the completion for proper event reporting.

Understanding the Event Details Window

To open Event Details, double-click the desired event's row in the Work Agenda. You can also select an event and then click the **Event Details** toolbar button or select **Event Details...** from the **Actions** menu.



The Event Details window is comprised of:

- [Menus and Toolbar](#)
- [Event Information Pane](#)
- [Tabs](#)



Menus and Toolbar



This section describes the menu and toolbar options. In the tables below, each menu item is listed along with submenu options, if available, and the default toolbar icon, if applicable; menu items without a default toolbar icon are indicated with a double dash (--) in the toolbar icon cell.

File Menu

| Menu Option | Description | Toolbar Icon |
|---------------------|--|---|
| Save | Saves the current event. If the event has already been completed, you are prompted to provide a reason for the update. |  |
| Print Tab... | Opens the Print Preview dialog box and allows you to print the current contents of the Job Actions tab. |  |
| Print All... | Opens the Print Preview dialog box and allows you to print the contents of all three Event Details tabs. |  |
| Exit | Exits Event Details. You must press the Save button before pressing the Exit button if you wish to save any revisions you may have made. | -- |

Actions Menu

| Menu Option | Description | Toolbar Icon |
|-----------------------|--|---|
| Complete Event | Sets the status of the current event to Complete. If the required fields (Remedy and Failure) have not been entered, this option will not be available. This option is not available for switching or planned outage events. |  |
| Maintenance | Sets the status of the current event to Maintenance Pending. If the required fields (Remedy and Case Note) have not been entered prior to selecting, an error will be displayed that will list the missing information. |  |

| Menu Option | Description | Toolbar Icon |
|--------------|--|---|
| Copy | Copies the case notes and details for the currently loaded event to all other events related to it based on its partial restoration. |  |
| Switching... | Opens the Open or Create New Switching Sheet dialog box, which allows you to create a new switching sheet or open a switching sheet associated with the selected event. See Open or Create New Switching Sheet on page 8-68 for more information. |  |
| View... | Show asset associated with the event in the Viewer. |  |
| Refresh | Refreshes the information in the window. | |

Event Information Pane

The top section of the Event Details window contains event attributes:

- The **Event #** is the number the system has assigned to the event.
- **Customers Out** contains the estimated number of customers experiencing an outage for this event.
- **Start Date** contains the date and time when the event began. This field is editable except for switching events. For switching events, you must edit the Completed Date in the switching step itself. See [Steps Tab](#) on page 8-20 for more information.
- **Restore Date** contains the date and time of event restoration (that is, when the outage area was restored). This field is editable except for switching events. For switching events, you must edit the Completed Date in the switching step itself. See [Steps Tab](#) on page 8-20 for more information.
- The **Sheet #** is the switching sheet number associated with the event, if any. The switching sheet number is prefixed by the switching sheet type.
- The **Asset** is the name of the asset associated with the event.
- The **Asset Type** is the type of asset.
- **Zone** displays the control zone where the associated asset is located.

Tabs

The Event Details windows provides a tabbed user interface to provide the tools to work an event in discrete views. The tabs are described in the following sections:

- [Using the Job Actions Tab](#)
- [Using the Completion Actions Tab](#)
- [Using the Equipment Failure Tab](#)
- [Using the Trouble Info Tab](#)
- [Using the Damage Assessments Tab](#)
- [Using the Event Log Tab](#)

Using the Job Actions Tab

The **Job Actions** tab lets you view detailed information about the event.

- The **Estimated Restore Time** pane displays the following:
 - **Est Restore Time:** displays the estimated restore time. The first date and time will be based on default values for the event type. The **Clear ERT** button allows you to remove the estimated restore time.
 - **Est Time to Restore (HH:MM):** displays the estimated time from the current time to complete the restoration in hours and minutes. Click **Update ERT** to apply the estimate to the estimated restore time.
 - **Est Time to Repair (HH:MM):** allows you to enter the estimated time to repair in hours and minutes. This field is used when the crew on-site is only assessing the event and providing an estimate for the time it will take another crew to do the work. This field is editable, and Oracle Utilities Network Management System Storm Management uses the value, if installed.
- The **Partial Restoration Log** pane contains a table that displays information related to restoration, if the event is restored in stages. This table does not display when the event is a non-outage. This table contains the following columns:
 - **# Cust Out Before:** Contains the total number of customers out at each stage.
 - **Operation Time:** Contains the date and time of the operation. User can modify values in this column as long as the changes do not alter the order of partial restoration steps. Changing partial restoration step operation time can affect outage restoration time if it is the final restoration step for the outage.
 - **Asset :** Displays the asset operated at each stage.
 - **# Cust Restored:** Contains the total number of customers that were restored at each stage.
 - **# Cust Added:** Contains the total number of customers that were added at each stage.
 - **# Cust Out After:** Contains total number of customers still isolated.
 - **Remarks:** Contains any comments or remarks entered by the user.
 - The **Event #:** column contains the event number associated with each partial restoration step.
- The **Operations Event Note** is a text field that allows you to enter notes about the event.

Once you enter text in the text field (top), click the add note button (). The note will be added to the Operations Event Note table, which displays operations event notes for this and all related events. This table contains the following columns:

 - **Event #:** the event for which the note was submitted.
 - **Date/Time:** the date and time when the note was submitted.
 - **User:** the user who added the note.
 - **Note:** the note text.
- **The En Route/Onsite Crews Pane**
 - The **Next Crew Contact Required at** table displays when the operator next anticipates receiving contact from associated crews. Use the **Reset Selected Crew Contact Time** button to reset the crew contact time to the date and time you enter in the **Date** field beside this button.
 - The En Route/Onsite Crews table contains the following columns:
 - **Crew ID:** Contains the crew name.

- **Contact:** Displays the contact name for the assignment.
- **Mobile #:** The crew's mobile phone number.
- **En Route Date:** Contains the time at which the crew was placed en route to the event. This column is empty if the crew has not arrived yet.
- **On Site Date:** Contains the time at which the crew arrived on site.
- **Contact Required By:** Contains the date and time at which the next contact is expected.

Using the Completion Actions Tab

The Completion Actions tab lets you view detailed information about the event, as well as enter information about the actions taken to complete the event. The first section displays summary information about the event, including the duration and scope of the event. The second section lets you enter information about the cause of the outage, the affected system and subsystem, environmental factors, and the actions that were taken to restore the outage. The third section allows you to exclude the event from the interruption indices calculations. The fourth section displays a log of changes made to the event details after the event was completed. The fifth section contains buttons that let you perform various actions associated with the event (for example, complete the event).

For instructions on completing an event, see [Completing an Event](#) on page 2-15.

The Completion Actions tab displays the following fields and buttons:

- **Event Began** contains the date and time at which the event began. This field is editable except for switching events.
- **Est # of Cust Out** contains the estimated number of customers experiencing an outage for this event.
- **Event Restored** contains the date and time of event restoration (that is, when the outage area was restored). This field is editable except for switching events.
- The **Details** section displays the following drop-down lists.
 - The **System** drop-down lets you specify what type of system the failure is on (for example, distribution, purification, pressurization, storage, supply, and so on).
 - The **Sub-System** indicates the type of sub-system (for example, water main, water tower, reservoir, main, and so on).
 - The **Type** drop-down lets you specify the type of asset that is experiencing the problem.
 - The **Failure** drop-down lets you specify the type of failure that is occurring.
 - The **Interrupting Asset** drop-down lets you specify the type of interrupting asset involved with the event.
 - The **Cause** drop-down lets you specify the type of primary cause issues involved with the event, such as contamination, corrosion, and so on.
 - The **Weather** drop-down lets you specify weather conditions at the time of the event.
 - The **Environment** drop-down lets you specify any environmental factors that may have been involved with the event.
 - The **Remedy** drop-down lets you specify the task performed to resolve the event.
- The **Interruption Indices** section displays the following fields:
 - The **Exclude This Event** check box allows you to designate if you want to exclude this event from the interruption indices calculations done by the Oracle Utilities Network Management System – Trouble Reporting application. The Exclude from Interruption Indices check box is not displayed for switching or planned outage events.

- The **Reason for Exclusion** field provides free-form text entry of the reason for the exclusion of this event from the interruption indices. The Reason for Exclusion field is not displayed for switching or planned outage events.
- The **Edit Log** table displays information related to event details being edited after the event is completed. This table contains the following columns:
 - The **Who** column contains the user ID of who performed the edit.
 - The **Date** column contains the date and time of the edit.
 - The **Reason** column contains a description of why the edit was made.
 - The **Field** column contains the name of an **Event Details** field that changed after the event was completed.
 - The **Previous Value** column contains the value of the field prior to the change.

Note: If multiple fields are edited post-completion, each change will be listed in a separate row.

Using the Equipment Failure Tab

The Equipment Failure tab lets you record detailed information about any failed equipment related to an event. You can record and track the type of equipment that failed, the manufacturer, serial number, and other details.

For instructions on entering failed equipment details, see [Recording Failed Equipment Information](#) on page 2-15.

The Equipment Failure tab displays the following fields and buttons:

- **Failure Item** is automatically populated with the Failure option selected in the Event Details tab.
- The **Manufacturer** drop-down menu provides a list of manufacturers to select from.
- **Serial #** is an editable (alphanumeric) field for you to enter the serial number for the equipment.
- **Date of Manufacture** is an editable (date/time) field for you to enter the date of manufacture of the equipment.
- **Date of Installation** is an editable (date/time) field for you to enter the date of installation of the equipment.
- **Type** is an editable (alphanumeric) field for you to enter the type of equipment.
- **Size** is an editable (alphanumeric) field for you to enter the size of the equipment.

Using the Trouble Info Tab

The Trouble Info tab has two views; the view displayed when you open the Trouble Info tab depends on where you launched it from.

The table below describes the Trouble Info views.





| View | Description | Toolbar Icon |
|------------------------------|---|---|
| Callers View | Lists all calls associated with an event. |  |

| View | Description | Toolbar Icon |
|----------------|--|---|
| Customers View | Lists all the customers: <ul style="list-style-type: none"> located on or downstream from a given asset, when accessed via the Control Tool affected by a given event, when accessed via the Work Agenda Trouble Event lists |  |

Trouble Info Tab Features

The Trouble Info tab changes dynamically based on the view. The following tables describe the menus and toolbar actions available in the Trouble Info views.

File Menu

| Menu Option | Description | View | Toolbar Icon |
|-----------------|--|------|---|
| Callers | Changes the Trouble Info window to the Callers View . | All |  |
| Customers | Changes the Trouble Info window to the Customers View . | All |  |
| Export Table... | Opens a dialog box to allow you to save the current table view data to a comma separated value (csv) file. | All |  |
| Print | Opens the Print Preview dialog box, allowing you to print the current contents of the current view. | All |  |

Sort Menu







| Menu Option | Description | View |
|----------------|---|------|
| Sort Dialog... | Opens the Sort Dialog, which allows you to choose the sort columns and type (that is, ascending or descending). | All |
| Default | Sorts the table according to the default settings for the view. | All |

Filter Menu

| Menu Option | Description |
|------------------|--|
| Filter Dialog... | Opens the Filter Dialog, which allows you to choose the columns to sort on. |
| All | The All filter (default) displays all of the rows in the table. |
| All Critical | The All Critical filter displays all rows where the Critical column is populated. |

| | |
|-------------|--|
| EMR | The EMR filter displays all rows where the Critical column contains Emergency, Fire, Police, or 911. |
| KEY | The KEY filter displays all rows where the Critical column contains Entertainment, Government, Key, Manufacturing, or Transportation. |
| MED | The MED filter displays all rows where the Critical column contains Medical, Hospital, Nursing Home, or Life Support. |
| SENS | The SENS filter displays all rows where the Critical column is set to Sensitive. |

Actions Menu

| Menu Option | Description | Views | Icon |
|--------------------------|---|--------------------|---|
| Refresh | Refreshes the data in the current view. | All |  |
| Call Info... | Opens the Call Info Window for the selected call. | Callers |  |
| Ungroup | Opens the Ungroup dialog box, allowing you to ungroup the selected calls from the event. | Callers |  |
| Unassociate | Opens the Unassociate dialog box, allowing you to unassociate the selected calls from this asset and (optionally) associate them with a new asset. See Unassociating a Call from an Asset for more information. | Callers |  |
| Move Customers... | Opens the Move Customers dialog box, allowing you to move selected customers to a new asset. See Moving Customers to a Different Asset on page 2-11 for more information. | Callers, Customers |  |
| Edit Clues... | Opens the Edit Clues dialog box for the selected call. See Editing Clues for details. | Callers |  |

Callers View

The Trouble Info tab's Callers view lists all calls associated with an event.

Event Information

The Event Information panel contains the following information:

- The **Event #** field displays the number assigned to the event by the system.
- The **Began At** field displays the time the event began.
- The **Pressure Zone** field displays the pressure zone on which the affected asset resides.
- The **Event Asset** field displays the name of the asset associated with the event.
- The **Asset Type** field displays the type of asset associated with the event.

Calls Table

The Calls Table lists all calls associated with an event. The table provides the following information:

- The **Clues** column displays the trouble code clues received for the call.
- The **Asset** column displays the name of the customer's service asset.
- The **Name** column displays the customer's name.
- The **Telephone** column displays the customer's telephone number.
- The **Date/Time** column displays the date and time of the customer's call.
- The **Critical** column displays the customer type value of the customer.
- The **Cmt** column displays a Y/N code depending on whether the call contains customer comments or not, respectively.
- The **Address** column displays the customer's address.
- The **Account #** field displays the customer's account number.

Comments

The Comments table displays all customer comments associated with the event. If there is a comment associated with a call, selecting the call in the Calls Table will highlight the comment in the Comments table. The Comments table contains the following information:

- The **Name** column displays the customer's name.
- The **Comment** column displays the customer's comment.

Callers View Actions

The following actions are available using the Callers View:

- [Viewing Call Info](#)
- [Ungrouping Calls](#)
- [Unassociating a Call from an Asset](#)
- [Moving Customers to a Different Asset](#)
- [Editing Clues](#)

Ungrouping Calls

You can ungroup calls that were automatically grouped by the system as a result of trouble analysis rules. For example, you would ungroup a call from an event that is not actually related to the event, but rather should be its own non-groupable event. To ungroup calls, complete these steps:

1. Select the event row in the Work Agenda you want to ungroup and click the **Trouble Info...** button (). The Trouble Info window opens to the Callers view.
2. Select the row in the Calls Table for the call you want to ungroup.
3. Select **Ungroup** from the **Actions** menu. The Ungroup dialog box opens with the asset related to the event populated in the **Asset** field.
4. Click **OK**.
 - In the Work Agenda, the call is ungrouped and a new event row appears in the Trouble Events list with the appropriate asset association.

- In the Work Agenda, the ungrouped call is removed from the # Calls column for the event it was ungrouped from.

Note: Events that are manually ungrouped will not be automatically grouped again by the system. However, you can manually group them again.

Editing Clues

You can edit the clues associated with a call, which will cause the call's trouble code to be changed. You can also enter comments that will be appended to the existing call comments.

To edit clues for a call, complete these steps:

1. Select an event in the Work Agenda with at least one call.
2. Select the **Trouble Info** button (). The Trouble Info window opens to the Callers view.
3. Select a row in the Calls Table.
4. Click the **Edit Clues** toolbar button or select **Edit Clues...** from the Action menu. The Edit Clues dialog box opens.
5. Use the drop-down boxes to select different clues.
6. Enter remarks in the Comments box, if desired.

Note: The Customer Remarks section is view-only.

7. Click **OK**. The system performs a reprediction to see if the event can now be grouped to other events or be grouped to by other events, based on the updated clues. The system also recalculates the dispatch priority and target response time for any event associated with this call.

Unassociating a Call from an Asset

You can move a customer to a different asset if you discover the customer is associated with an incorrect asset. To move a customer to a different asset, complete these steps:

1. Select an event in the Trouble Events list (in the Work Agenda window) with at least one call.
2. Select the **Trouble Info** button (). The Trouble Info window opens to the Callers view.
3. Select a row in the Calls table and select **Unassociate** from the Actions menu.

Customers View

The data shown in the Trouble Info Customers view depends on how it is launched.

- If launched from the Control Tool, it displays all customers located on or downstream from a given asset (see [Asset Options](#) on page 1-44 and [Control Tool Actions](#) on page 1-68 for information).
- When Trouble Info is launched from the Work Agenda, the Customers view displays all customers affected by a given event.

Event Information

The Event Information panel contains the following information, depending on the tool that launched it:

- The **Event #** field displays the number assigned to the event by the system. (Work Agenda)
- The **Began At** field displays date and time when the event began. (Work Agenda)
- The **Pressure Zone** field displays the pressure zone on which the associated asset resides.
- **# Customers** displays either how many customers are located on or downstream from a given asset or affected by a given event. (Control Tool or Work Agenda, respectively.)

- The **Event Asset** field displays the name of the associated asset.
- The **Asset Type** field displays the type of the associated asset. (Work Agenda)
- The **Updated:** field displays the date and time when the data was last updated. (All)

Customer Table

The Customer Table lists all customers associated with an event or asset. The table provides the following information:

- The **Asset** column displays the name of the customer's service asset.
- The **Name** column displays the customer's name.
- The **Telephone** column displays the customer's telephone number.
- The **Critical** column displays the customer type value.
- The **Priority** column displays the customer's weighted priority. See [Using the Customer Administration Weighted Priority Editor](#) on page 10-34 for more information on weighted priority.
- The **Address** column displays the customer's address.
- The **Account #** column displays the customer's account number.
- The **DER Count** column displays the number of DER units associated with the customer.
- The **Event ID** column displays any customer associated events.
- The **Clues** column displays the clues for the outage or event. Only the clues associated with the first customer call will be listed.
- The **Call Date** column displays the date and time when a customer reported the event. If there are multiple calls from a customer, the first (non-AMI) call will be displayed.
- The **Restore Date** column displays the most recent time an outage affecting the customer was restored. When Trouble Info is opened for an event, only the restoration times for that event are displayed; if the **Restore Date** column is empty, then the customer is currently affected by the selected outage event. When Trouble Info is opened for an asset, this will also occur if the customer never experienced an outage.
- The **Total Calls** column display the number of times the customer called.

Customers View Actions

You can perform the following task from the Customers View:

- [Moving Customers to a Different Asset](#)
- [Viewing a Customers DER Units](#)

Moving Customers to a Different Asset

Trouble Info allows you to move customers to a different asset if you discover they are associated with an incorrect asset. The Move Customers tool is available from both the Callers and Customers views.

To move customers to a different asset, complete these steps:

1. Select one or more customers to move from the Customers view

Notes:

- You can use the Callers view if the customers that you want to move are all also callers.
- To select multiple adjacent customers, click the first customer row and then press the Shift key and click the last customer row.

- To select multiple non-adjacent customers, press the Control key and click each customer row individually.
2. Select **Move Customers...** from the **Actions** menu. The Move Customers dialog box appears.
 3. Select an asset in the Viewer to move the customers to. The **New Asset** field is populated with the asset identifier.
 4. Click **OK**. The Move Customers dialog box closes.

Note: If the selected customers were previously moved to a new asset, a confirmation dialog box (that is, Overwrite Moved Customers) is displayed. Do one of the following:

 - Click **Yes** to continue and overwrite the existing customer move record.
 - Click **Cancel** to cancel your selection and return to the Move Customers dialog box to select a different asset.
 - Click **No** to abort the move completely.
 5. The event is then re-analyzed using the new asset information. If it does not repredict into the same event, the # Calls and # Customers for the original event are adjusted. Calls may be grouped into another existing event or a new event will be created.

Note: Trouble Info will be updated with the Move Customer information.

Viewing a Customers DER Units

Trouble Info allows a user to view information related to DER units associated to an individual customer. This dialog will show the following information related to DER units, the technology type, phasing, rated size, and voltage. This dialog is only available from the Customers view.

To view DER units for a customer, complete the following steps:

1. Select a single customer in the Customers view that has a DER Count greater than or equal to one.
2. Select Show DER Units... from the Actions menu. The Customer DER Units dialog box appears.

Note: The **Show DER Units...** option will only be available if the DER Count is greater than or equal to one.



3. The dialog will open showing relevant information for each DER associated to the customer.
4. Click **Close**. The Customer DER Units dialog box closes.



Using the Damage Assessments Tab

The **Damage Assessments** tab displays summary information for damage assessment records associated with an event. See [Working with Damage Assessments](#) on page 2-25 for information about creating and working with damage assessments.

Menus and Toolbar Icons

File Menu

| Menu Option | Description | Toolbar Icon |
|----------------|---|---|
| New... | Create a damage assessment in the Damage Assessment tool. |  |
| Open... | Open the currently selected record in the Damage Assessment window. |  |

| Menu Option | Description | Toolbar Icon |
|-------------|--|---|
| Reload | Reload the table data. |  |
| Print... | Print the content of the Damage Assessments table. |  |

Actions Menu

| Menu Option | Description | Toolbar Icon |
|-----------------|---|---|
| View... | Focuses the Viewer on the asset associated with the selected damage assessment. |  |
| Event... | Opens the Event Details for the event associated with the selected damage assessment. | |
| Patrol Event... | Opens the Event Details for the patrol event associated with the selected damage assessment. Only enabled when the column Patrol Event # is populated for the selected damage assessment. | |

Filter Menu

| Menu Option | Description | Toolbar Icon |
|--------------------|--|--------------|
| Active | Show all active Damage Assessments. | -- |
| Complete | Show all complete Damage Assessments. | -- |
| Auto Filter Off | Clears any auto-filter values that were set by right-clicking a Damage Assessment record in the table and selecting Auto Filter . | -- |
| Show Filter Dialog | Open the filter dialog box to choose filter criteria. | -- |
| All | Show all damage assessments. | -- |

Damage Assessments Table

- **Status** is the status of the listed damage assessment.
 - **New:** the initial state of a damage assessment.
 - **Assessed:** the assessment is done. Damage Assessments in the Assessed state are included in estimated repair time calculations.
 - **Complete:** the event has been restored.
 - **Obsolete:** the damage assessment no longer applies to the event.
- **Event #** is the event number associated with the damage assessment.
- **Patrol Event #** is the patrol event number associated with the damage assessment, if applicable.
- **Report Date** is the date and time when damage assessment was performed.

- **Reported By** is the crew that reported the damage.
- **Crew** is the crew that performed the damage assessment.
- **Mobile #** is the crew's mobile number.
- **Assigned Crew** is the crew assigned to the assessment.
- **Hazard?** is whether the damage is hazardous.
- **Asset** is the asset alias.
- **Address** is the damage location address.
- **Pressure Zone** is the name of the pressure zone.
- **Region** is the region-level control zone name.
- Branch is the branch-level control zone name
- Lift Station is the lift station-level control zone name.

To view, edit, or create damage assessment information for an event:

1. Select an event from the Event List in the Work Agenda.
2. Select **Damage Assessment...** from the **Actions** menu. Event Details will open with the **Damage Assessments** tab in focus. Any existing damage assessments will be displayed in the table.

Using the Event Log Tab

The Event Log tab displays a table with all actions taken for the event. To display the Event Log for a particular event, select a row in the Work Agenda list and select **Event Log...** from the **Actions** menu.

The table displays the following information:

- The **Date/Time** field displays the date/time at which the log entry occurred.
- The **User** field displays the user that initiated the action.
- The **Event** field displays the identifier of the original event for which the log entry was generated. Note that, due to grouping activities, the original event may no longer exist.
- The **Text** field displays a description of the log entry.

The Event Log may be exported using the Event Details **File** menu's **Export Table...** option, which is visible on the Event Log and certain other tabs having table data that can be exported.

Using the Fault Location Analysis Tab

See

Using the FLISR Report Tab

See **Using the Optimization Report Tab**

See [Viewing the Optimization Report](#) on page 12-7 for details on the Optimization Report.

Updating the Estimated Restoration Time

Once a crew has arrived onsite and reported their assessment of when the event will be restored, you can update the estimated restoration time using Event Details. To update the estimated restoration time, complete these steps:

1. Select the event in the Work Agenda window.

2. Click the **Event Details** toolbar button or select **Event Detail...** from the **Actions** menu. The Event Details window opens.
3. On the **Job Actions** tab, enter the amount of time (in hours and minutes) that the crew will take to restore the outage in the **Est Time to Restore** field.
4. Click the **Update ERT** button. The updated time displays in the Est Restore Date fields, and other windows that display the Est Restore Date will be updated.

Recording Failed Equipment Information

To record information about a failed asset, complete these steps:

1. From the Event Details window, click on the Equipment Failure tab.
2. Select the manufacturer from the **Manufacturer** drop-down menu.
3. Enter the serial number, dates of manufacture and installation, type, and size of the equipment, as applicable.
4. Click the **Save** button.

Copying Event Details to Related Partial Restoration Events

You can copy the case notes and other event details for the currently loaded event to all other events related to it based on its partial restoration.

Note: Any previously stored Event Details information for the related events will be overwritten (except for system-populated fields such as Event #, Asset, Zones, Event Began, Est # of Cust Out, and Event Restored).

1. Select the event in the Work Agenda window.
2. Click the **Event Details** toolbar button or select **Event Detail...** from the Actions menu. The Event Details window opens.
3. Make any desired changes to the event details. Any comments you enter in the Operations Event Note will be applied to all related partial restoration events.
4. Click the **Copy** toolbar button or select **Copy** from the Actions menu. The corresponding event details are copied to all related partial restoration events of the currently displayed event. Note that ERT information is only copied to active related events.

Completing an Event

After a crew has reported that an event is complete, you can update the event information in the Event Details window and complete the event. To complete an event, follow these steps:

1. Select the event in the Work Agenda window.
2. Click the **Event Details** toolbar button or select **Event Detail...** from the Actions menu. The Event Details window opens.
3. Click the **Completion Actions** tab.
4. Select the appropriate options from the drop-down menus. You must select a Failure, Cause, and a Remedy; additional options may be required, based on your configuration. Once the required options have been provided, the **Complete Event** button is enabled.
5. Click the **Complete Event** button or select **Complete Event** from the **Actions** menu. The event information is updated, the event is marked as "complete," and the Event Details window closes.

Note: If you do not select the Failure, Primary Cause, and Remedy prior to selecting **Complete Event**, the system will display the Validation Errors and Warnings dialog box that warns you that you must select the missing option(s) in the Completion Actions tab.

Using the Update Events Window

You can use the **Update Events** dialog box to update multiple events with the same completion actions. The dialog box will display all events related to a single Work Agenda row, if any exist, or multiple events selected in the Work Agenda. See the Work Agenda [Actions Menu](#) on page 1-28 for details on the options available for selected rows.

The **Update Events** window includes the following panes and buttons:

- **Panes**
 - **Events to Update:** Lists the events included in the selection.
 - **Operations Event Note:** Text field allowing you to add a note that will apply to all of the selected events.
 - **Details:** Provides a subset of fields from the Event Details **Completion Actions** tab.
- **Buttons**
 - **Select All:** Selects all of the checkboxes in the **Details** pane.
 - **Unselect All:** Causes any selected checkboxes in the **Details** pane to become deselected.
 - **Complete:** Completes all of the events.
Note: You may only complete events when the required details have been added.
 - **Update:** Updates the events with the selected details or a new operations event note.
 - **Help...:** Launches online help for the Update Events dialog box.
 - **Cancel:** Closes the Update Events dialog box without making any changes to the events.

Updating Multiple Events

1. In the Work Agenda, select an event with related events or select multiple event rows.
2. In the Update Events window, select the values in the **Details** pane that you wish to add to all events. All fields are selected by default when you open the Update Events window; if you do not want a value to change for all events, deselect the checkbox next to the drop-down list.

Note: If an event already has information in one or more of the fields, you may select the event to populate the value(s) in the drop-down list(s) and, then, you may update the other events with those values.

3. (Optional) Add an **Operations Event Note**.
4. If you click **Update** or **Complete**, you will be prompted for a reason. Enter the reason, and click **OK** to update all events with the selected event data; if you clicked **Complete**, the system will attempt to complete the events.

If you subsequently open Event Details for an event separately, you will see that the selected fields were updated and the unselected fields were not modified, any operations event notes were also added to the list of notes for each event, and an Edit Log entry was added for each selected field.

Confirm Outages

If you need to confirm a probable service outage or create new confirmed service/secondary outage events when a crew reports in from a site, you can use the Confirm Outages window. This window displays a table listing either all of the customers downstream of the predicted or confirmed outage asset (when accessed from the Work Agenda) or all of the customers connected to the selected asset (when accessed via the Control Tool).

This section includes the following topics:

- [Using Confirm Outages Window](#)
- [Creating a Confirmed Service Outage](#)
- [Creating a Confirmed Secondary Outage](#)
- [Creating a Confirmed Service and Secondary Outage for the Same Customer](#)
- [Restoring a Customer with a Confirmed Service or Secondary Outage](#)

Using Confirm Outages Window

To access the Confirm Outages window, do one of the following:

- Select **Confirm Outages...** from the Work Agenda Actions menu.
- Select an asset in the Viewer that has customers connected to it, bring up the Control Tool, then click on the **Confirm Outages...** button.

The Confirm Outages window displays the following columns:

- The **Asset** column contains the name of the asset the customer is connected to.
- The **Address** column contains the customer's address.
- The **Name** column contains the name of the customer.
- The **Customer Type** column contains the customer type code.
- The **Prediction** column contains the outage prediction type (for example, Confirmed Service, Confirmed Secondary), if available.
- The **Restored** column contains "Yes" to indicate the customer has had their confirmed outage restored.
- The **Grouping** column contains "Yes" if the call for the customer is groupable. The column is empty if there are no calls for the customer or if the call is not groupable.
- The **Event #** column displays the number the system has assigned to the customer's event. If a customer call is made groupable, the event number will change if the call is grouped to an existing or repredicted event.
- The **Call Time** column displays the time when the customer call was received.
- The **Telephone** column contains the customer's telephone number.
- The **Account #** column contains the customer's account number.

Color Coding



The rows in the Confirm Outages window are color-coded to designate when a customer has a confirmed service outage, a confirmed secondary outage, or when the customer has been

restored. When a customer is affected by multiple outages, multiple rows will be displayed representing the different outages.



| Color | Description |
|--------|----------------------------|
| Green | Confirmed Service Outage |
| Orange | Confirmed Secondary Outage |
| Blue | Restored |

Confirm Outages Menus and Toolbar

File Menu

| Menu Option | Description | Toolbar Icon |
|-------------|--|---|
| Print... | Opens the print dialog box to allow you to print the current list. |  |
| Refresh | Refreshes the data. |  |
| Exit | Closes the Confirm Outages window. | -- |

Actions Menu

| Menu Option | Description | Toolbar Icon |
|-------------------|---|---|
| Confirm Service | Confirms a service outage for the selected rows. | -- |
| Confirm Secondary | Confirms a secondary outage for the selected rows | -- |
| Restore | Sets the outage to restored. The Restored column is populated with <i>Yes</i> . | -- |
| Make Groupable | Makes the selected call groupable. The Groupable column is populated with <i>Yes</i> . This option is only available when a row for a customer with a non-groupable call is selected and the call is not part of a confirmed outage. | -- |
| Event Details... | Opens the Event Details window for the selected event, if applicable. |  |
| View... | Shows the associated asset in the Viewer. |  |

Help Menu

| Menu Option | Description | Toolbar Icon |
|----------------------|--|--------------|
| Confirm Outages Help | Opens the Confirm Outages online help content. | -- |

Creating a Confirmed Service Outage

To create a confirmed service outage for a customer, complete these steps:

1. Select the row in the Confirm Outages window for the applicable customer.
2. Select **Confirm Service** from either the right-click option menu or from the Actions menu.
3. The Confirm Outages window refreshes. The row for the selected customer is now colored green, and the **Prediction** column is now populated with *Confirmed Service*. A new event row appears in the Work Agenda Trouble Event list. A **CSVO** symbol appears on the customer's asset in the Viewer window.

Creating a Confirmed Secondary Outage

To create a confirmed secondary outage for a customer, complete these steps:

1. Select the row in the Confirm Outages window for the applicable customer.
2. Select **Confirm Secondary** from either the right-click option menu or from the Actions menu.
3. The Confirm Outages window refreshes. The row for the selected customer is now colored orange and the **Prediction** column is now populated with *Confirmed Secondary*. A new event row appears in the Work Agenda Trouble Event list. A **CSCO** symbol appears on the customer's asset in the Viewer window.

Creating a Confirmed Service and Secondary Outage for the Same Customer

To create a confirmed service outage and secondary outage for a customer, complete these steps:

1. Select the row in the Confirm Outages window for the applicable customer.
2. Select **Confirm Service** as described above; the Confirm Outages window will refresh with the confirmed service data. Likewise, with the same row selected, select **Confirm Secondary**.
3. The Confirm Outages window refreshes. There are now 2 rows for the customer with **Prediction** column populated with the outage type (that is, **Confirmed Service** and **Confirmed Secondary**). Both a CSVO and CSCO symbol appear on the customer's asset in the Viewer window.

Restoring a Customer with a Confirmed Service or Secondary Outage

To restore a confirmed service or secondary outage for a customer, complete these steps:

1. Select the row in the Confirm Outages for the applicable customer.
2. Select **Restore** from either the right-click option menu or from the Actions menu.
3. The Confirm Outages window refreshes. The row for the selected customer is now colored blue and the **Restore** column is populated with *Yes*. The CSVO/CSCO symbol disappears from the customer's asset in the Viewer window (or the CSVO/CSCO numbers are decreased by one).

Setting Work Queues

To add an event to a Work Queue, do the following:

1. Select the desired event's row in the Work Agenda.
2. Click the **Work Queues** toolbar button () or select **Work Queues...** from the **Actions** menu.
3. In the Work Queues dialog box, select the **Refer To** check box for the work queues for the event.
4. Enter any desired remarks into the **Add Note** field.
5. Click the **OK** button. The Work Queues dialog box closes, and the Work Agenda Work Queues column updates with the selected Refer To values.

Event Grouping

While the system automatically groups events according to the trouble analysis rules, you may come across some events that are related, but are not grouped because of data modeling issues (for example, connectivity problems). You can manually group these events together using the Group Events dialog box.

Group Events Dialog Box

The Group Events dialog box allows you to group events. To open the Group Events dialog box, select **Group Events** from the **Actions** menu in the Work Agenda window.

The Group Events dialog box displays the following fields:

- The **Use first event as lead event** check box allows you to retain the first event as the lead event, if desired. Otherwise, the system will choose the lead event automatically, giving precedence to real outages and asset outages with the most customers.
- The **Selected Events** area displays all of the events that have been selected for grouping.
- The **Group Method** contains a selection of grouping options:
 - The **merge** option is used for event grouping.
 - The **relate** option does not group the selected events, but rather allows you to record a relationship between the events and enter notes in the Relationship Comments field.
 - The **unrelate** option allows you to remove one or more previously related events from the relationship.
- The **Relationship Comments** field allows you to enter comments about the relationship when the Group Method is set to *relate*.

Grouping Events

To group events, complete these steps:

1. Open the Group Events dialog box by selecting **Group Events** from the Work Agenda Actions menu.
2. Make sure the **Group Method** is *merge*.
3. In the Trouble Events list, select the row for the event that all subsequent events will be grouped to. The event number appears in the Selected Events field.
4. Select the row of an event in the Trouble Events list that you want to group to the first selected event. The event number for the event is added to the Selected Events field.
5. If there are other events you want to add, select the row for those events in the Trouble Events list. The event numbers for the events are added to the Selected Events field.
6. To deselect a selected event, select its row again. The event number is removed from the Selected Events field.
7. Click on the **OK** button.
 - The selected events are grouped to the first selected event.
 - The rows for the subordinate events disappear from the Trouble Events List.
 - The number of customer calls are added together and their sum appears in the # Calls column.

Grouping Rules

If the events that you selected do not meet the manual grouping rules, the system will not let you group them. An error message will appear explaining the problem. Manual grouping rules include the following:

- General fuzzy events can group to any outage.
- Fuzzy events associated with a control zone can only group to other events in the same control zone.
- Non-outage events can group to outage or non-outage events.
- Outage events can group to other outage events, but outage events cannot be grouped to other outage events that they are not downstream of.
- Real outages (where an asset is closed in the Viewer causing a segment of the model to be outaged) cannot group to one another.
- Outage events cannot group to non-outage events.
- Meets (for example, meet fire, and so on) cannot group to anything.
- Switching events cannot group to anything.

Behavior of Grouped Events

Once events have been manually grouped, the system will no longer repredict the outage asset nor will a manually grouped event be automatically merged into another event. However, other events and calls may be automatically merged into a manually grouped event.

Relating Events

To relate events, complete these steps:

1. Open the Group Events dialog box by selecting **Group Events** from the Work Agenda Actions menu.
2. Change the Group Method to "relate." The Relationship Comments field is now accessible.
3. In the Trouble Events list, select the row for the event that all subsequent events will be related to. The event number appears in the Selected Events field.
4. Select the row of an event in the Trouble Events list that you want to relate to the first selected event.
5. If there are other events you want to add, select the row for those events in the Trouble Events list. The event numbers for the events are added to the Selected Events field.
6. Type a comment into the Relationship Comments field, if desired.
7. Click the **OK** button. The selected events are related to one another. The **Grp Type** column in the Work Agenda for each event now contains "REL", the **Rel Type** column now contains "R", and **Rel Event #** column now contains the event number of the earliest event.

Unrelating Events

To unrelate events that have been related, complete these steps:

1. Open the Group Events dialog box by selecting **Group Events** from the Work Agenda Actions menu.
2. Change the Group Method to "unrelate."
3. In the Trouble Events list, select the row for the event that you wish to unrelate. The event number appears in the Selected Events field.
4. If there are other events that you want to unrelate, select the row for those events in the Trouble Events list. The event numbers for the events are added to the Selected Events field.

5. Click the **OK** button. The selected events are unrelated. If two or more events are still part of that relationship, they remain related to each other. If the event that was displayed in the **Rel Event #** column was unrelated and two or more events are still part of that relationship, the **Rel Event #** column is updated with the event number of the earliest event remaining in the relationship.

Ungroup Events

To ungroup manually grouped events or repredicted upstream asset outages, complete these steps:

1. Select a grouped event in Work Agenda.
2. Select Undo Grouping from the Work Agenda **Actions** menu. The event will be ungrouped and new events will be created for the previously grouped events.

Notes:

- You cannot ungroup events with crew assignments, whether assigned, en route, onsite, or suspended.
- If the grouped event was predicted (for example, a Predicted Asset Outage (PDO)), it is destroyed and the event number is lost along with any data entered in Event Details.
- Ungrouped calls are put at the front of the grouping queue and then grouped normally.

Associating and Unassociating Calls with Assets or Control Zones

Sometimes a call comes in reporting a problem that is not clearly related to a particular customer or asset. Until an asset is identified for the problem, the event is considered a *fuzzy call*. When more information becomes available, you can associate the fuzzy call with an asset or control zone. You can also unassociate these calls using the Trouble Info window.

Associating Fuzzy Calls

To associate a call with an asset or control zone, complete the following steps:

1. In the Work Agenda, select the fuzzy event row.
2. Select **Associate Event...** from the Work Agenda **Actions** menu. The Associate Event dialog box will open.
3. Select the asset or control zone that you wish to associate the event to:
 - If you know then asset that you want to associate the call to, open the Viewer and load the map containing the asset.
 - Select the asset in the Viewer. The asset identification appears in the **Asset** field.
 - If you are associating the fuzzy call to a control zone, select the control zone from the Control Zone selection menu (). The control zone name will populate the **Zone** field.
4. Click **OK** to complete the selection in the Associate Event dialog box. The Oracle Utilities Network Management System analysis engine re-analyzes the fuzzy call using the selected associated asset or control zone and may group it with other events.

Unassociating/Reassociating a Call from/to an Asset

To unassociate a call from one asset and reassociate it to another asset, complete these steps:

Note: If you are unassociating a call and you want to turn it into a fuzzy call, simply do not select an asset to re-associate it with (omit the third and sixth steps below).

1. In the Work Agenda window, select the row for the active event that contains the calls you want to unassociate.

Note: You cannot unassociate a call from a restored or inactive event.
2. Click the **Trouble Info** toolbar button or select **Trouble Info...** from the **Actions** menu. Call information about the event appears in the Trouble Info window.
3. Open a Viewer window and load the map containing the new asset you would like to re-associate the calls with.
4. In the Trouble Info window, select the row for the call you wish to unassociate from its present asset.
5. Select **Unassociate** from the Trouble Info **Actions** menu. The Unassociate dialog box opens.
6. Select an asset in the Viewer to populate the New Asset field in the Unassociate dialog box.
7. Click **OK**.
 - The call is unassociated from the current asset and associated with the new asset, if specified.
 - The Oracle Utilities Network Management System Web Trouble analysis engine re-analyzes the event from which the calls were unassociated, as well as the unassociated calls using their new associated asset.

Working with Damage Assessments

The Damage Assessments feature includes summaries of existing damage assessments (displayed in the Event Details Damage Assessments tab) and methods for creating new damage assessments. New damage assessments may be associated with an existing event, an asset, or may be created as *fuzzy* events.

Damage assessments include:

- Damage description
- Equipment needed for the repair.
- Crew types needed for the repair.

Based on the reported damage, the system will calculate estimated repair time for an event. If multiple damage assessments exist for an event, the system will calculate the estimated repair time by adding together estimated repair times from each active damage assessment. Damage assessment trouble codes have associated clue symbols, which will be displayed in Viewer at the damage locations.

Notes:

- Damage assessment incidents are not included in counts for the event.
- Damage assessment cannot be performed for switching events or meets.



Understanding the Damage Assessment Window





The Damage Assessment window is used to create or edit damage assessment information. The Damage Assessment window is displayed when you do one of the following:

- To create a new *fuzzy* (in other words, not associated to an event) Damage Assessment, select **New** and then **Damage Assessment...** from the Web Workspace **File** menu or clicking the **New Damage Assessment** button () on the Web Workspace toolbar.
- To create a new damage assessment for an event,
 - **From the Work Agenda:** Select the event row in the Work Agenda and then select **Damage Assessment...** from the Work Agenda **Actions** menu. The Event Details **Damage Assessments** tab will open. Select **New** from the tab's **File** menu.
 - **From the Control Tool:** Open the Control Tool for the asset to associate with a new damage assessment. Select the Control Tool's **Damage Assessment...** option to open the Event Details Damage Assessments tab. Select **New** from the tab's **File** menu.
 - To create a new Damage Assessment, select **New...** from the Damage Assessment **File** menu.
 - To open an existing Damage Assessment, select the Damage Assessment in the table and select **Open...** from the Damage Assessments tab's **File** menu.





Menu and Toolbar

File Menu

| Menu Option | Description | Toolbar Icon |
|---------------|--|---|
| Reload | Reloads the data |  |
| Save | Saves changes to the Damage Assessment |  |

| Menu Option | Description | Toolbar Icon |
|--------------------|---|---|
| Assessing | The damage is being assessed. |  |
| Assessed | The damage assessment is complete. |  |
| Standing By | The damage is in standby mode. |  |
| Fixed | The damage is fixed. |  |
| Obsolete | The damage assessment is no longer valid. |  |
| Exit | Closes the Damage Assessment window. | -- |



The Damage Assessment window displays the following fields and buttons:

- The **Damage Assessment #** is the ID of the damage assessment.
- **Event #** is the ID of the event associated with this damage assessment. **0** is displayed if an event has not yet been created for this damage assessment. Once event is created, click the Reload button to populate the field with the event ID. The Event Details button () to the right of the field opens the Event Details for the event.
- **Patrol Event #** is the ID of the patrol event associated with the damage assessment, if applicable. The **Event Details** button () to the right of the field opens Event Details for the patrol event; the button is only enabled when the **Patrol Event #** field is populated.
- **Report Date** is the date and time when damage assessment was performed. Click the date-time icon to use the date picker to set the date.
- **Reporting Crew Information**
 These fields represent the crew that reported the damage assessment.
 - The **Reported By** field is the crew that reported the damage.
 - The **Select Crew** button () opens the **Select Crew** dialog box so you can select the crew that reported the damage.
 - **Phone #** is the mobile number of the crew that reported the damage.
- **Assigned Crew Information**
 These fields represent the crew assigned to the damage assessment, if different from the Reporting Crew.
 - The **Assigned Crew** field is the crew assigned to the damage assessment.
 - The **Select Crew** button () opens the **Select Crew** dialog box so you can select the assigned crew.
 - **Phone #** is the mobile number of the crew assigned to the damage assessment.



Damage Location Section

- **Zone** is the name of the company, region, branch, lift station, and pressure zone.
- **Asset** is the asset alias. You may move the damage assessment to a different asset by editing this field.

Actions

-  : search for an asset to associate to the damage assessment.
-  : link the currently selected asset to the damage assessment.
-  : view the asset in the Viewer.
- **Address** is the street address where the damage assessment was performed.
 - Latitude: latitude of the damage location
 - Longitude: longitude of the damage location

Actions

-  : focuses the Viewer on the saved latitude and longitude coordinates.
-  : opens the Select Damage Location dialog box, which captures the latitude and longitude of a point selected in the Viewer. With the dialog box open and the Viewer in focus, the cursor will appear as a crosshair until you select a location; whenever you click in the Viewer, the Select Damage Location's **Latitude** and **Longitude** fields will update with values for that point. Click **OK** to add the selected coordinates to the damage assessment or click **Cancel** to reset the cursor and close the dialog box.

Note: You may also press the escape key (**Esc**) to reset the cursor.

Action

-  : opens the Control Zone selection menu, which allows you to associate fuzzy damage assessment with a control zone. This is only possible during the initial creation of the damage assessment.

Damage Specifics Section

- **Section Affected** allows you to specify the section affected by the damage. You can select from a list or enter a value manually.
- **Location** allows you to specify the damage location. You can select from a list or enter a value manually.
- The **Load Affected** check box indicates whether the damage affects customers. If checked, the damage assessment will generate an outage incident; otherwise, a non-outage incident will be generated. When damage assessment is performed for an existing non-outage, this check box will be unchecked and non-editable.
- The **Hazard** check box indicates a hazardous situation.
- The **Road Blocked** check box indicates whether a blocked road is reported. When the **Load Affected** check box is checked, this check box will be unchecked and non-editable (road blocked is a non-outage condition).
- The Crew Types indicates the types of crews needed to repair the damage. Enter the number of each crew type.
- The **Damage Type** column in the Damage Specifics table displays all known types of damage.

- The **Accessible** column in the Damage Specifics table displays the number of accessible instances of a particular type of damage. Enter a value for each applicable damage type. When you modify a row, its background changes to green.
- The **Inaccessible** column in the Damage Specifics table displays the number of inaccessible instances of the particular type of damage. Enter a value for each applicable damage type. When you modify a row, its background changes to green.
- **Comments** contains any remarks associated with the damage specifics.



Required Material Section

- The **Add Required Part** button opens the Add Required Part dialog box so you can select a part and specify a quantity.
- The **Remove Required Part** button allows you to mark a row in the Required Material list for removal. Rows marked for removal display a red background.
- **Part ID** contains the IDs of parts required to repair the damage.
- **Part Name** contains the names of parts required to repair the damage.
- **Quantity** displays the quantity of the specified part.
- **Comments** displays remarks associated with the required material.
- The status bar displays the damage assessment status (New, Assessed, Complete, or Obsolete) and the estimated time to repair the reported damage. This is calculated from the information entered into the Damage Specifics table, but you can also enter it manually.

Attachments Section

The Attachments section allows you to attach a file or link an externally stored file to the damage assessment.

Actions

-  : opens the Attach Files dialog box that allows you to attach a file to the damage assessment. Maximum size of the attachment is 50M.
-  : opens the Add Link dialog box that allows you to add a link to an externally stored attachment that is accessible with an URL. To add a link, complete the following fields:

Name: a name that is unique to the damage assessment.

URL: link to attachment.

Description: short description of the attachment contents.

Click **OK** to add the attachment link or click **Cancel** to abort the action.



-  : marks the selected attachments for removal.
-  : opens the selected attachment. Links are opened in a web browser. Files are opened using application associated with the given file type.
-  : saves local copies of the selected attachments. Only the file attachments can be saved.

Table Columns

- **Name:** attachment name (unique within a single damage assessment)
- **File Size:** attachment size in bytes (0 for links)
- **Modified Date:** last modification date for file attachments

- **Status:** status of the attachment (New, Modified or Deleted)
- **Link:** URL of the externally stored attachment
- **Description:** attachment description



Setting the Estimated Time to Repair

The **Est Time to Repair** field in the status bar allows you to enter the estimated time to repair.

Click the **Recalculate** button () to recalculate the repair time based on the information in the Damage Specifics table. This allows you to revert from the manually entered repair time back to the system-generated value.

Creating Fuzzy Damage Assessments

When a crew reports damage that is not associated with an event in the system, you may create a fuzzy damage assessment and link it to a location in the Viewer. Like with creating an event, you may create a fuzzy damage assessment for an outage or non-outage situation.

1. Open the Viewer to the general location of the damage.
2. Create a new damage assessment by clicking the new Damage Assessment button () in the Web Workspace toolbar.
3. Click the location selection button () to open the Select Damage Location dialog box.
4. Click the location in the Viewer where the damage was found. The Select Damage Location dialog box will be populated with the latitude and longitude data from the Viewer.
5. Click **OK** to accept the latitude and longitude.
6. Add any other known information to the damage assessment and click the **Save** button.
7. Close the Damage Assessment.

When you reopen the damage assessment, click the damage location focus button () to open the Viewer and focus on the saved coordinate data.

Fuzzy damage assessment can be associated to an asset by populating the **Asset** field with the valid asset alias (either by entering it directly or selecting asset in the Viewer) and then saving the damage assessment.

Updating the ERT for Selected Events

You can set the estimated restoration time for one or more events selected in Work Agenda.

Note: Updating the ERT from the Work Agenda is not allowed for some event types. For Notify Alarms, Planned Outages, and Switching events, the user cannot set or clear the ERT. For Non Outages, Critical Meets, and Future Meets, you can clear the ERT, but cannot set it.

If the ERT update operation cannot be performed on one or more of the selected events, the *Ignored ERT Updates* dialog box will be displayed when the other updates have completed. The *Ignored ERT Updates* dialog box list the events where the ERT was not updated.

To set the ERT for selected events, follow these steps:

1. From the Work Agenda events list, select all the events for which you want to update the ERT.
2. Select **Update ERTs...** from the **Actions** menu. The Update ERT dialog box opens.
3. Enter the new ERT using the calendar tool.

4. Click the **Set ERT** button. The Update ERT dialog box closes, and the new ERT value is displayed for the selected events in the Work Agenda list.

Clearing the ERT

To clear the ERT for events selected in Web Work Agenda, follow these steps:

1. Selects one or more events in Web Work Agenda.
2. Select **Update ERTs...** from the **Actions** menu. The Update ERT dialog box opens.
3. Click the **Clear ERT** button. The Update ERT dialog box closes, and the ERT values for the selected events are cleared in the Work Agenda list.

Setting the System-Wide Estimated Restoration Time

Use this procedure to view and modify the system-wide default ERT value. The system-wide ERT is used for all events; it overrides any default ERTs defined at the control zone/asset class level in the Configuration Assistant.

To set the system-wide default, follow these steps:

1. Select **System-Wide Default ERT...** from the Web Work Agenda **Actions** menu. The System-Wide Default ERT dialog box opens.
2. Enter a new value in the New System-Wide ERT field, using the calendar tool.

Note: Only future dates are allowed.

3. Click the **Set ERT** button. The dialog box closes and the specified ERT becomes the default for any new events for which no specific default is specified. All not completed events with an Est Src value of I or N in the Work Agenda will have their ERT values reset to the system-wide default ERT value.

Note: This action causes a full re-examination of all events currently in the system; thus, it is advised to use it sparingly when there are a large number of events present.

Clearing the System-Wide Estimated Restoration Time

Use this procedure to clear the system-wide default ERT value so that all events will use the default values specified for their control zone and asset class combination, as defined in the Configuration Assistant. (See [Adding an Asset/Zone-Based Default Restoration Time](#) on page 10-30.)

Note: If you clear the system-wide default ERT and no default ERT has been defined that matches the control zone/asset class of an event, the event will not be assigned a default ERT. The ERT will remain empty for the event unless you manually change it.

To clear the system-wide default, follow these steps:

1. Select **System-Wide Default ERT...** from the Web Work Agenda **Actions** menu. The System-Wide Default ERT dialog box opens.
2. Click the **Clear ERT** button. The dialog box closes and the previously specified ERT is no longer used as the default for any new events. The ERT for an event will default to the value defined for its control zone and asset class.

Note: This action causes a full re-examination of all events currently in the system; thus, it is advised to use it sparingly when there are a large number of events present.

Managing Crews with Web Trouble

Oracle Utilities Network Management System – Web Trouble allows you to manage crews efficiently. This section describes the various windows and functions that relate to managing crews. It includes the following topics:

- Using Crew Actions
 - Assigning a Crew
 - Placing a Crew En Route Using the Crew Actions Window
 - Changing Crew Availability
 - Finding the Event a Crew is En Route To
 - Activating a Crew and Making a Crew Inactive
 - Setting a Crew's Status to On Shift and Setting a Crew's Status to Off Shift
 - Deleting a Crew
 - Filtering Crew Lists
- Using Crew Makeup
 - Creating a New Crew
 - Removing Personnel from a Crew
 - Removing a Vehicle from a Crew
 - Editing a Crew
- Using Crew Info
 - Unassigning a Crew
 - Placing a Crew En Route to an Assigned Event
 - Suspending a Crew
- Active Job Info
 - Moving a Crew
 - Releasing Crews from an Event
 - Updating Event Information

Using Crew Actions

Use the Crew Actions window to view and manage crews. The Crew Actions window opens by default when you login to Oracle Utilities Network Management System Web Workspace. It is displayed below the Web Work Agenda window. You can also display this window by selecting **Crew...** from the Web Workspace **Tools** menu.

The Crew Actions window displays a **Menu and Toolbar** and provides two views: [Crew List View](#) and [Crew Icons View](#).



From the Crew Actions window, you can perform the following tasks:

- [Assigning a Crew](#)
- [Placing a Crew En Route Using the Crew Actions Window](#)
- [Changing Crew Availability](#)
- [Finding the Event a Crew is En Route To](#)
- [Transferring a Crew to a Temporary Control Zone](#)
- [Activating a Crew and Making a Crew Inactive](#)
- [Setting a Crew's Status to On Shift and Setting a Crew's Status to Off Shift](#)
- [Deleting a Crew](#)

Menu and Toolbar

The Crew Actions window displays a toolbar and menu bar, as described in the following tables.

File Menu

| Menu Option | Description | Toolbar Icon |
|-----------------|--|---|
| New... | Opens the Crew Makeup window, which allows you to define a new crew. |  |
| Delete | Deletes the currently selected crew after prompting for confirmation. This is enabled only if an inactive non-mobile crew is selected. |  |
| Export Table... | Opens a dialog box to allow you to save the current table view data to a comma separated value (csv) file. |  |
| Exit | Closes the Crew Actions window. | -- |









View Menu

| Menu Option | Description | Toolbar Icon |
|---------------------|---|--------------|
| Icons | Switches to the Icons view if the List view is currently active. | -- |
| List | Switches to List view if Icons view is currently active. | -- |
| Crew Gantt Chart... | Displays the onsite, en route, and assigned crews in a Gantt chart. See Working with the Crew Gantt Chart on page 2-41 for information. | -- |

Filter Menu

| Menu Option | Description | Toolbar Icon |
|--------------------|--|---------------------|
| Shift Status | Filters by shift statuses. The product environment includes the following shift options: <ul style="list-style-type: none"> • All • On Shift • Off shift • Inactive | -- |
| Job Status | Filters by job statuses. The product environment includes the following job status options: <ul style="list-style-type: none"> • All • Available • Assigned • En Route • Onsite • Suspended • Unavailable | -- |
| Crew Type | Filters by crew types. The product environment includes the following crew type options: <ul style="list-style-type: none"> • All • Service • Trouble • Eval | -- |
| Event Zone | Filters crews by the zone of the event selected in the Work Agenda. The product environment includes the following event zone options: <ul style="list-style-type: none"> • All • Region (Control Zone Hierarchy Level 2) • Branch (Control Zone Hierarchy Level 3) | -- |
| Parent Zones | Filters crews by parent Control Zone. <ul style="list-style-type: none"> • Include - Display crews created for zones that are parents of the subscribed zones. • Exclude - Excludes crews created for zones that are parents of the subscribed zones. | |
| All Zones | Displays crews in all control zones. When checked, the Parent Zones and Event Zones options are disabled. | |

Actions Menu

| Menu Option | Description | Toolbar Icon |
|--------------------|---|---|
| Edit... | Opens the Crew Makeup window, which allows you to edit the currently selected crew. This is enabled only if a non-mobile crew is selected. |  |
| Crew Info... | Opens the Crew Info dialog box for the selected crew. |  |
| Switching... | Opens the switch plan to which the selected crew is associated. This is enabled only if a crew is selected and Web Switching Management is licensed for your system. If more than one plan is associated with the crew, a dialog box prompts you to select one. | -- |
| View... | Opens Viewer 1, focused on the asset where the selected crew is en route or onsite, and selects event in the Work Agenda Event List to which the crew is en route or onsite. This is enabled only if an en route or onsite crew is selected. |  |
| Locate Crew... | Displays the selected crew in the Viewer window at the current coordinates of the crew. This option is available only for crews with AVL (Automatic Vehicle Location) systems. | -- |
| Availability... | Opens the Update Crew Availability dialog box for the selected crew. See Changing Crew Availability on page 2-39. |  |
| Assign | Assigns the selected crew to the event currently selected in Work Agenda. |  |
| En Route | Puts the selected crew en route to the event currently selected in Work Agenda. This is enabled only if the selected crew is an on-shift, available, non-mobile crew that is not currently en route or onsite. |  |
| Active Job Info... | Opens the Active Job Info dialog box for the selected crew. This is enabled only if an en route or onsite crew is selected. |  |
| Onsite | Puts the selected crew onsite at the event currently selected in the Work Agenda. This is enabled after the crew is en route. |  |
| Toggle Mobile On | Turns off override for a crew that is currently overridden by the Toggle Mobile Off action. | -- |
| Toggle Mobile Off | Overrides the selected crew to act as a non-mobile crew. Enabled if an active off shift mobile crew is selected. Not available to view only users. | -- |
| Activate | Activates the selected crew. This is enabled only if an inactive non-mobile crew is selected. | -- |
| Deactivate | Deactivates the selected crew. This is enabled only if the selected crew is an off-shift, active non-mobile crew that has no assignments. | -- |

| Menu Option | Description | Toolbar Icon |
|------------------------|--|--------------|
| Set On Shift... | Opens a dialog box that allows you to enter an on-shift time for the selected crew. This is enabled only if an off-shift active crew is selected. | -- |
| Set Off Shift... | Opens a dialog box that allows you to enter an off-shift time. This is enabled only if the selected crew is an on-shift crew that is not en route or onsite. | -- |
| Transfer Zone... | Temporarily transfer the crew to a different control zone. | -- |
| Release Temporary Zone | Return the crew from its temporary control zone assignment back to its original control zone. | -- |

Crew List View

The Crew List view on the Crew Actions window displays a list of crews, in table format. The crews that appear in the list are based on the current filter settings. See [Crew Status](#) on page C-1 for a list of color codes used to indicate crew status.

The Crew List contains the following fields and buttons:

- The **Control Zone** column contains the name of the control zone the crew is assigned to.
- The **Crew ID** column contains a string that identifies the crew.
- The **Crew Type** column contains the type of crew (for example, Eval, Service, and so on).
- The **Contact** column contains the contact name for the crew.
- The **Crew Size** column contains the number of crew members.
- The **Pressure Zone** column contains the pressure zone for the asset where the crew is en route/onsite.
- The **Asset** column contains the name of the asset where the crew is en route/onsite.
- The **Est Restore Time** column contains the date and time when the event where the crew is en route/onsite is estimated to be restored.
- The **# Assign** column contains the number of events assigned to the crew.
- The **Hours Worked** column contains the length of time the crew has been active.
- The **Mobile** column indicates whether this is a mobile crew.
- The **Shift Status** field displays the crew's current shift status. Valid statuses are:
 - Inactive
 - Off Shift
 - On Shift
- The **Job Status** field displays the crew's current job status. Valid statuses are:
 - Available
 - En Route
 - Onsite
 - Suspended
 - Unavailable

Crew Icons View

The Crew Actions window displays buttons to represent the each crew. In this view, use the Actions menu to perform actions on the selected crew icon. As the crew's status changes, a symbol will be added to the button that depicts the current status; see [Event Status Codes](#) on page B-1 for the symbol icons that correlate to each status. See also [Crew Status](#) on page C-1 for a list of color codes that may be used to indicate crew status when cell or row coloring is enabled in the Web Workspace **Preferences** menu.

Activating a Crew

Crews are activated by changing their status from **Inactive** to **Active**, which indicates that they are available for work.

To activate a crew, complete these steps:

1. In the Crew Actions window, select the inactive crew you want to activate.
2. Select **Activate** from the **Actions** menu. (In List view, you can also right-click the crew and then select **Activate** from the context menu.) The status changes to Off Shift.

Note: You cannot activate a crew if its Mobile is Yes. You must choose the **Toggle Mobile Off** option on the Actions menu to change the mobile status before activating. The Mobile Flag column displays No (Override), indicating that the crew's mobile status has been manually overridden.

3. You can now set the crew's status to On Shift. See [Setting a Crew's Status to On Shift](#) on page 2-37.

Setting a Crew's Status to On Shift

Setting an active crew's status to On Shift indicates that the crew has started working the shift and sets the time the crew went on shift. You can only set a crew's status to On Shift if its current status is Active.

To put a crew On Shift, do the following:

1. In the Crew Actions window, select the active crew you want to put On Shift.
2. Select **Set On Shift...** from the **Actions** menu. (In List view, you can also right-click the crew and then select **Set On Shift...** from the context menu.) The Set Crew On Shift dialog box opens.
3. The Set Crew On Shift dialog box opens with the **On Shift Time** field showing number signs (#) rather than values for date and time. The date and time may be added by performing one of the following options.
 - To set the On Shift Time to the current time, click **OK**.
 - To specify a different time:
 - Click the date/time button  to expand the date/time selector.
 - In the date/time selector, select the date/time the crew went on shift, and click **OK**. The selector will be minimized and the **On Shift Time** field will be populated with the selected date/time.
 - In the Set Crew On Shift dialog box, click **OK**.

Setting a Crew's Status to Off Shift

Setting an active crew's status to **Off Shift** indicates that the crew has stopped working the shift and sets the time when the crew went off shift. You can only set a crew's status to Off Shift when its status is On Shift.

To put a crew Off Shift, follow these steps:

1. The Set Crew Off Shift dialog box opens with the **Off Shift Time** field showing number signs (#) rather than values for date and time. The date and time may be added by performing one of the following options.
 - To set the Off Shift Time to the current time, click **OK**.
 - To specify a different time:
 - Click the date/time button  to expand the date/time selector.
 - In the date/time selector, select the date/time the crew went off shift, and click **OK**. The selector will be minimized and the **Off Shift Time** field will be populated with the selected date/time.
 - In the Set Crew Off Shift dialog box, click **OK**

Making a Crew Inactive

You can deactivate a crew to indicate that it is not available for work. You can only deactivate a crew if its status is Active or Off Shift and it has no current assignments.

To deactivate a crew, complete these steps:

1. In the Crew Actions window, select the active or off shift crew you want to deactivate.
2. Select **Deactivate** from the **Actions** menu. (In List view, you can also right-click the crew and then select **Deactivate** from the context menu.) The status changes to Inactive.

Deleting a Crew

To delete a crew, complete these steps:

Note: You can only delete a crew if it is inactive. You cannot delete a mobile crew, even if the mobile flag has been overridden.

1. If the crew is active, you must first deactivate it (see [Making a Crew Inactive](#)). If a crew is on shift, you must first set the crew to off shift (see [Setting a Crew's Status to Off Shift](#)) and then deactivate it before you can delete it.
2. Select the crew in the Crew Actions window.
3. Select **Delete** from the **Actions** menu. (In List view, you can also right-click the crew and then select **Delete** from the context menu.) A dialog box prompts you to confirm the deletion.
4. Click **OK**. The crew is deleted from the system.

Assigning a Crew

Assigning a crew adds the event to the crew's work queue.

Note: You do not have to assign a crew to an event before placing it en route. Assigning merely lines up the event for the crew to work later.

To assign a crew to an event, complete the steps that follow.

1. In the Work Agenda Trouble Events list, select the row containing the event that you want to assign the crew to.
2. Select the crew you want to assign the event to in the Crew Actions window.
3. Select **Assign** from the **Actions** menu. (In List view, you can also right-click the crew and then select **Assign** from the context menu.) The event information is automatically entered into the Crew Info window for the crew.

Note: You can assign multiple events to a single crew. You can also assign multiple crews to a single event.

Placing a Crew En Route Using the Crew Actions Window

To place a crew en route to an event, complete these steps:

Note: You can only place a crew en route to an event if the crew is an on-shift, available, non-mobile crew that is not currently en route or onsite to an event.

1. In the Work Agenda Trouble Events list, select the row containing the event that you want to place the crew en route to.
2. In Crew Actions, select the crew you want to place en route.
3. Select **En Route** from the **Actions** menu. (In List view, you can select the crew row, right-click, and then select **En Route** from the context menu.) The icon for the crew turns green, and the event information is automatically entered into the Crew Info and Active Job Info windows for the crew.

Note: You can place multiple crews en route to a single event.

Changing Crew Availability

Making a crew available/unavailable is different from making it active/inactive. When a crew is inactive (for example, finished working for the day), the crew does not appear in the Crew Actions window. When a crew is unavailable, (for example, at lunch), it appears in the Crew Actions window (in yellow). You can assign an unavailable crew, but you cannot place it en route. See [Activating a Crew](#) and [Making a Crew Inactive](#) for more information on active/inactive crews.

To change a crew's availability, complete these steps:

1. Select the crew you want to change in the Crew Actions window. You cannot change an en route/onsite crew.
2. Select **Availability...** from the **Actions** menu. (In List view, you can also right-click the crew row and select **Availability...** from the context menu.) The Update Crew Availability dialog box opens.
3. Select the appropriate option to change the crew's availability.
 - **Available** button to make the crew available
 - **Unavailable** to make it unavailable

If you are making an available crew unavailable, select the **Description** field and add a brief reason for the change (for example, on break).

Note: The description text is shown in the description field until you set the crew back to available.

4. Click **OK** to confirm your change or **Cancel** to abort the action.

If the crew has been made unavailable, the Crew ID will be displayed in yellow as will the crew icon.

Note: You can assign events to both available and unavailable crews.

Finding the Event a Crew is En Route To

To find the event a crew is en route to, select the crew in the Crew Actions window and then select the **View** toolbar button or select **View...** from the **Actions** menu. The event row is highlighted in the Work Agenda Trouble Events list, and Viewer 1 focuses on the asset associated with the en route event.

Note: The Work Agenda event row will only be highlighted if the Work Agenda window is open and the event is on the list you currently have displayed

in the Work Agenda window. The Viewer will only focus on the asset if you have the Viewer 1 window open.

Transferring a Crew to a Temporary Control Zone

To transfer a crew to a temporary control zone, perhaps to offset a crew shortage in the zone, complete these steps:

1. Select the crew to transfer control.
2. Select **Transfer Zone...** from the Actions menu.
3. Select a control zone in the Transfer Crew Zone dialog box.
4. Click **OK** to complete the transfer.

Returning Control of a Transferred Crew

To return control of the crew to their usual control zone, complete these steps:

1. Select the crew from the crew list.
2. Select **Release Temporary Zone** from the Actions menu.

The crew list will update to show that the crew's control zone has reverted to their permanent assignment.

Filtering Crew Lists

Crews may be filtered in either of the Crew Actions views (that is, List or Icons). Filters may be applied in any of the following ways:

1. Filter Menu Options

- Choose any combination of options from the Shift Status, Job Status, and Crew Type to view only those crews meeting the criteria.

2. List View Dynamic Filtering

- Enter filter criteria in the List View Dynamic Filter field at the top of each column in the crew table.

3. Filter by Work Agenda Event Criteria

- Select an event zone option from the **Event Zone** sub-menu of the Crew Actions **Filter** menu.
- Select one or more events in the Work Agenda that are in a control zone.
- The Crew List will display only those crews assigned to the control zone.

Note: If you select multiple rows in the Work Agenda that cross multiple control zones, the Event Zone filter will be removed from the Crew List or Crew Icons views. Once you select a single row or rows with events in the same control zone, the filter will be re-enabled automatically.

Working with the Crew Gantt Chart

Select **Crew Gantt Chart...** from the Crew Actions **View** menu to launch the Crew Gantt Chart. The chart will update automatically based on the crews shown in Crew Actions and crew updates.

Hovering over an event provides details about the event. To zoom in or out, click the **+** or **-** buttons, respectively.

Right-click an event in the Crew Gantt Chart to reveal the following options:

- **Assignments...:** opens Crew Info for the assigned crew. See [Using Crew Info](#) on page 2-43 for information.
- **Duration...:** opens a dialog box that allows you to change the duration of an event. See [Modifying a Crew Assignment Duration](#) on page 2-45 for information.
- **View...:** launches the Viewer and focuses on the event asset. See [Viewer Focus](#) on page 1-51 for more information.
- **Trouble Info...:** opens Trouble Info. See [Using the Trouble Info Tab](#) on page 2-6 for details.
- **Event Details...:** opens Event Details for the event. See [Managing Crews with Web TroubleEvent Details](#) on page 2-2 for information.
- **Release Crew...:** opens the Release Crew dialog box. See [Releasing Crews from an Event](#) on page 2-49 for details.

Using Crew Makeup

To open the Crew Makeup window, select **New...** or **Edit...** from the **File** menu in the Crew Actions window or click either the **New...** or **Edit...** button in the Crew Actions window.

The Crew Makeup window displays the following fields and buttons:

- The **Crew ID** field displays the alphanumeric ID that identifies the crew.
- The **Mobile #** field displays the mobile telephone or radio number.
- The **Pager #** field displays the pager number.
- The **Contact** field displays the Name of the contact person for the crew.
- The **Crew Size** field displays the Number of members of the crew. The crew size is initially set to zero.
- The **Type** drop-down allows you to select the type of crew (for example, Eval, Trouble).
- The **Temp/Perm** drop-down allows you to define the crew as either temporary or permanent. When a crew is set to temporary, you would normally delete it when it is deactivated.
- The **Control Zone** field displays the control zone that the crew is assigned to. When you click the **Edit...** button, a Control Zone dialog box opens letting you assign the crew to the selected control zone.
- The **Personnel** list displays the name and job title of each crew member. You can add crew members by clicking the **Add...** or **Select Personnel...** buttons. You can remove a crew member by selecting their row in the Personnel table and clicking the **Remove** button.
- The **Vehicles/Equipment** list displays the vehicles or equipment assigned to the crew. You can add vehicles or equipment by clicking the **Add...** or **Select Personnel...** buttons. You can remove a vehicle or piece of equipment by selecting the item and clicking the **Remove** button.

Buttons

- The **Edit...** button opens the Control Zones dialog box, allowing you to select the Control Zone the crew will be assigned to.
- The **Add...** (Personnel) button opens the Add Personnel dialog box, allowing you to enter a crew member's name and select their job type.
- The **Select Personnel...** button opens the Select Personnel dialog box, allowing you to select from a predefined list of personnel.
- The **Remove...** (Personnel) button removes the selected individual from the personnel list.
- The **Add...** (Vehicles/Equipment) button opens the Add Vehicle/Equipment dialog box, allowing you to assign vehicles to the crew.
- The **Select Vehicles/Equipment...** button opens the Select Vehicles/Equipment dialog box, allowing you to select from a predefined list of vehicles/equipment.
- The **Remove...** (Vehicles/Equipment) button removes the selected vehicle from the Vehicles/Equipment list.
- The **OK** button saves the crew changes and closes Crew Makeup.
- The **Cancel** button closes Crew Makeup without saving any changes.

Creating a New Crew

To create a new crew, complete these steps:

1. Open the Crew Makeup window either by selecting **New...** from the File menu in Crew Actions or by clicking the **New...** button in Crew Actions.
2. Enter the Crew ID, mobile and pager numbers, and contact.
3. Select the crew type and temporary or permanent from the drop-down lists.
4. Click the **Edit...** button to open the Control Zone dialog box. Select a control zone and click **OK**.
5. Check the **Mobile App Crew** if this crew should be available to all mobile users.
6. Click the **Add...** (Personnel) button to open the Add Personnel dialog box. Enter a crew member's name and select their job title, then click **OK**.

Or

Click the **Select Personnel...** button to open the Select Personnel dialog box. Select one or more rows from the Select Personnel dialog box (using the Control and/or Shift keys), then click **OK**.

7. Repeat the previous step until all crew members are added.
8. Click on the **Add...** (Vehicles/Equipment) button to open the Add Vehicle/Equipment dialog box. Select the vehicle type, and then click **OK**.

Or

Click the **Select Vehicles/Equipment...** button to open the Select Vehicles/Equipment dialog box. Select one or more rows from the Select Vehicles/Equipment dialog box (using the Control and/or Shift keys), then click **OK**.

9. Repeat the previous step until all vehicles are added.
10. Click **OK** on the Crew Makeup dialog box to create the crew.

Removing Personnel from a Crew

To remove an individual from a crew you have open in Crew Makeup, select his or her name in the Personnel list and click **Remove**. The name disappears from the Personnel list.

Removing a Vehicle from a Crew

To remove a vehicle from a crew you have open in Crew Makeup, select the vehicle from the Vehicles/Equipment list and click **Remove**. The vehicle disappears from the Vehicles/Equipment list.

Editing a Crew

To edit a crew, complete these steps:

1. Open the Crew Makeup window either by selecting **Edit...** from the **File** menu or by clicking the **Edit** toolbar button in the Crew Actions window.
2. Make the changes to the crew.
3. Click **OK** on the Crew Makeup dialog box to save the changes.

Using Crew Info

Crew Info displays detailed crew information not shown in Crew Actions window. It allows you to unassign a crew or access the Active Job Info window to place a crew en route to any of its assigned events.

Crew Info topics include:

- [Opening Crew Info](#)
- [Understanding Crew Info](#)
- [Modifying a Crew Assignment Duration](#)
- [Changing the Crew Assignment Order](#)
- [Unassigning a Crew](#)
- [Placing a Crew En Route to an Assigned Event](#)

Opening Crew Info

To open the Crew Info window, do the following:

1. Select the crew:
 - From the Crew Actions List view, select the row of the crew you want to view.
 - From the Crew Actions Icons view, select the icon of the crew you want to view.
2. Click the **Crew Info...** button () or select **Crew Info...** from the **Actions** menu.



Understanding Crew Info

Menus and Toolbar Icons

File Menu

| Menu Option | Description | Toolbar Icon |
|-------------|------------------------------|--------------|
| Exit | Closes the Crew Info window. | -- |

Actions Menu

| Menu Option | Description | Toolbar Icon |
|-------------------------------|--|---|
| Change Assignment Duration... | Change the duration for an event assigned to the crew. |  |
| Drop Assignments | Unassign the crew from the selected assignment. |  |
| Place En Route | Place the crew en route to selected assignment. |  |
| Transfer Zone... | Opens the Transfer Zone dialog box, which allows you to assign the crew to a temporary zone. | -- |
| Release Temporary Zone | Removes the temporary zone assignment. | -- |

Help Menu

| Menu Option | Description | Toolbar Icon |
|----------------|---|--------------|
| Crew Info Help | Opens the online help system to the Crew Info help content. | -- |

The Crew Info window contains the following fields and buttons:

- The **Crew ID** field displays the string that identifies the crew.
- The **Mobile #** field displays the crew's mobile phone number.
- The **Pager #** field displays the crew's pager number.
- The **Contact** field displays the name of the crew's contact person.
- The **Type** field displays the type of crew (for example, Eval, Service, and so on).
- The **Temp/Perm** field displays whether the crew is a temporary crew or a permanent crew.
- The **Control Zone** field displays the control zone the crew is assigned to.
- The **Status** field displays the crew's current status. Valid statuses are:
 - Inactive
 - Off Shift
 - On Shift
- The **Mobile Flag** field indicates whether this is a mobile crew.
- The **Out of Range** field indicates whether the crew is currently out of range (no connectivity).

Personnel Section

- The **Name** column displays the names of all the crew members.
- The **Job Title** column displays the job titles of all crew members.
- The **Empl ID** column displays the employee ID of all crew members.

Vehicles/Equipment Section

- The **Type** field displays the vehicle types assigned to the crew.
- The **Vehicle ID** column displays the ID of all vehicles assigned to the crew.

Active Job Section

- The **Event #** field displays the event number of the event where the crew is currently en route/onsite, if any.
- The **Pressure Zone** number displays the name of the pressure zone for the asset where the crew is currently en route/onsite, if any.
- The **Est Restore Time** field displays the date and time when the event to which the crew is en route/onsite is estimated to be restored.
- The **Asset** field displays the name of the asset related to the event.

Current Assignment Section

- The **Event #** column contains the event number of the event the crew is assigned to.
- The **Assign Time** column contains the time the crew was assigned to the event.
- The **Pressure Zone** column contains the name of the pressure zone involved in the event.
- The **Asset** column contains the name of the asset related to the event.
- The **# Calls** column contains the number of customer calls received for the event.
- The **# Out** column contains the estimated number of customers experiencing an outage for the event.
- The **Suspended** column indicates whether the assignment was suspended.

Context Menu Options

When you right-click an assignment row, the following context menu options are available:

- The **Change Duration...** option opens the Update the duration of an Event dialog box, which allows you to change the current hours and minutes with new duration values. See [Modifying a Crew Assignment Duration](#) on page 2-45 for details.
- The **Drop Assignment** option removes the selected event from the list of crew assignments.
- The **Place En Route** option opens the Active Job Info window for you to place the crew en route to an event on the assigned list. You must select an event on the assigned list before you click this button.

Modifying a Crew Assignment Duration

1. In Crew Info, select the event from the Current Assignments table. The buttons at the bottom of the window become enabled.
2. Select **Change Duration...** from the Crew Info **Actions** menu.
3. Enter the new duration in hours and minutes (hh:mm); for example, 01:30 for a new duration of one hour and 30 minutes.
4. Click **OK** to close the dialog box.

Changing the Crew Assignment Order

1. In Crew Info, select one or more events in the Current Assignments pane.
2. Drag the selected row(s) to the desired location in the list and release the mouse.

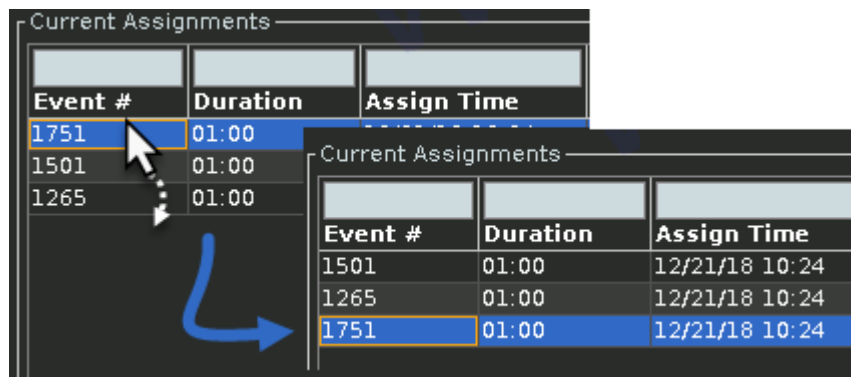

Unassigning a Crew

To drop an assignment from a crew, complete these steps:

1. In the Crew Info window, select the event from the Current Assignments table. The buttons at the bottom of the window become enabled.
2. Click the **Drop Assignment** button (🔧). A dialog box opens asking if you are sure you want to remove the assignment.
3. Click **OK**.
 - The crew is unassigned from the event.
 - The event is removed from the list of crew assignments.
 - The crew button/crew row changes to white (if the crew is not en route/onsite, unavailable, or assigned to another event).

Placing a Crew En Route to an Assigned Event

If a crew has been assigned to an event, you can place the crew en route to the event using Crew Info.

To place the crew en route to the assigned event, complete these steps:

1. In Crew Info, select the event from the Current Assignments table. The toolbar buttons become enabled.
2. Click the **Place En Route** button (🚚). The Active Job Info window opens and the crew is placed en route to the event.

Active Job Info

The Active Job Info window provides basic crew information, as well as information for the event where they are en route to/onsite at. It allows you to move and release crews. You can also use the Active Job Info window to record that a crew has arrived onsite, enter an estimated restoration time, and add an operations event note.

This section includes the following topics:

- [Using the Active Job Info Window](#)
- [Updating Event Information](#)
- [Moving a Crew](#)
- [Releasing Crews from an Event](#)
- [Suspending a Crew](#)

Using the Active Job Info Window

You can open the Active Job Info window either from the Crew Actions window or while placing a crew en route from the Crew Info window.

To open the Active Job Info window from Crew Actions, complete these steps:

1. In the Crew Actions window, select the en route/onsite crew you want to view active job information about.
2. Select **Active Job Info...** from the Actions menu. (From the List view, you can also right-click the crew and select **Active Job Info...** from the context menu.) The Active Job Info window opens.

To open the Active Job Info window from Crew Info, complete these steps:

1. In the Crew Info window, select the row of the assigned event you want to place the crew en route to.
2. Click on the **Place En Route** button. The Active Job Info window opens.

The Active Job Info window displays the following fields and buttons:

- The **Crew ID** field displays the string that identifies the crew.
- The **Contact** field displays the name of the crew's contact person.
- The **Event #** field displays the event number of the event where the crew is en route/onsite.
- The **Pressure Zone** number displays the name of the pressure zone for the asset where the crew is en route/onsite.
- The **Asset** field displays the name of the asset related to the event.
- The **Not Onsite** drop-down menu is a toggle for you to designate whether the crew has arrived onsite yet or not. The field to the right of the drop-down is editable and populates with the current time when you toggle the crew to **Onsite**. You may use the calendar button to the right of the date/time field to specify a different time.
- The **Suspend Crew** check box indicates whether the crew is suspended. To suspend this crew, click the check box. The field to the right of the check box is editable and populates with the current time when you check this box. You may use the calendar button to specify a different time.
- The **Est Time to Restore (HH:MM)** field allows you to enter the estimated amount of time (in hours and minutes) for the event to be restored. If you enter a value here (to the left of the Update Time button) and then click the **Update Time** button, the system updates the Est Time to Restore (displayed to the right of the button) based on the value you entered. You can also enter the Est Time to Restore field directly if you prefer.

- The **Clear ERT** button clears the estimated time to restore for the event and resets the **Est Restore Time** field.
- The **Operations Event Note** field allows you to enter notes about the event.

Buttons

- The **OK** button saves the changes you have made and closes the Active Job Info window.
- The **Move Crew...** button opens the Choose Work location dialog box where you enter the location you want to move the crew to by selecting an asset in the Viewer.
- The **Release Crew** button releases the crew from the event and closes the Active Job Info window.
- The **Cancel** button closes the Active Job Info window without saving any changes to the estimated restore time or Operations Event.

Note: If you moved the crew, the change is still saved.

Updating Event Information

To update event information, complete these steps:

1. Open the Active Job Info window by selecting an en route/onsite crew in Crew Actions and then selecting **Active Job Info...** from the Actions menu.
2. To update the Estimated Restore Date or time, enter the Estimated Time to Restore and click the **Update Time** button. The Est Restore Date and time will change accordingly. You can also directly edit the estimated restore date and time field.
3. You can add event notes in the Operations Event Notes field.
4. Click **OK**. The Active Job Info window closes and your changes are saved.

Moving a Crew

Moving a crew does not change the event the crew is en route to/onsite at; rather, it moves the crew to another asset location and keeps it associated with the same event. By default, Oracle Utilities Network Management System locates a crew at the predicted or confirmed clearing asset so that graphically the crew appears to be at the same location as the outage symbol in the Viewer. In some cases, the crew may actually have to work at a location different from the clearing asset. It is not required or necessary to move the crew, but moving the crew to the actual asset location is helpful in keeping more accurate track of what is going on in the field.

To move a crew, complete these steps:

1. Open the Active Job Info window for the crew you want to move by selecting the crew in the Crew Actions window and then selecting **Active Job Info...** from the Actions menu.
2. Click the **Move Crew...** button. The Choose Work location dialog box opens.
3. Select the new asset location in the Viewer window or select an event in the Work Agenda Trouble Events list that has the same asset as the one where the crew is currently working.
4. Click **OK**. The crew symbol moves on the Viewer map and the crew's Asset updates in the Active Job Info, Crew Info, and Crew Actions windows. The crew remains en route to/onsite at that same event.

Releasing Crews from an Event

You may release crews from an en route/onsite event using the Work Agenda, the Crew Actions Active Job Info window, or from event or crew symbology in the Viewer.

Releasing a Crew from the Active Job Info

1. Open the Active Job Info window for the crew you want to release by selecting the crew in the Crew Actions window and then selecting **Active Job Info...** from the Actions menu.
2. Click the **Release Crew** button. The following occurs:
 - The crew is released from the event.
 - The crew's active job information is removed from the Crew Info window.
 - The crew button/row changes to white (if the crew is not assigned to another event).
 - The Active Job Info window closes.

Releasing Crews from an Event Selected in the Work Agenda

1. Select a row in the Work Agenda with en route or onsite crews.
2. Select **Release Crews...** from the Actions menu. The **Release Crews** dialog box opens listing the crews assigned to the event. One or more crews may be selected:
3. Click a crew name to select one crew.

To select additional crews:

- Click, hold, and drag to select multiple adjacent crews.
 - Control-click to select multiple non-adjacent crews.
4. With the crews selected, click **Release** to release the crews from the event.

The Release Crew dialog box will close, the crew will no longer be associated with the event, and the crew symbology will disappear from the Viewer.

Releasing a Crew from the Crew Symbol in the Viewer

1. Right-click the crew symbol in the Viewer.
2. Select **Release Crew** to release the crew from the event.

Releasing Crews from an Event Symbol in the Viewer

1. Right-click the event symbol.
2. Select **Release Crews...** from the option menu. The **Release Crews** dialog box opens listing the crews assigned to the event. One or more crews may be selected:
3. Click a crew name to select one crew.

To select additional crews:

- Click, hold, and drag to select multiple adjacent crews.
 - Control-click to select multiple non-adjacent crews.
4. With the crews selected, click **Release** to release the crews from the event.

The Release Crews dialog box will close, the crew will no longer be associated with the event, and the crew symbology will disappear from the Viewer.

Suspending a Crew

You can suspend a crew that is currently en route or on site to an event. Suspending the crew indicates that the crew is not able to complete the work at this time and is expected to resume work on the assignment at a later time.

To suspend a crew from an en route/onsite event, complete these steps:

1. Open the Active Job Info window for the crew you want to release by selecting the crew in the Crew Actions window and then selecting **Active Job Info...** from the Actions menu.
2. Click the **Suspend** check box. The suspend date and time defaults to the current date and time. To specify a different date and time, click the calendar icon and then select the date and time the crew was suspended.

The following occurs:

- The Active Job Info window closes.
- The crew button in the Icons view and the crew row in the List view change to the Suspended color (orange, by default).
- The Current Assignments table in the Crew Info window displays Yes in the Suspended column for this assignment.

Using Drag and Drop

Oracle Utilities Network Management System Web Workspace supports drag and drop between Crew Actions and the Viewer, Crew Actions and the Work Agenda, two Viewers, or within a Viewer window.

Placing a Crew En Route

You can place a crew en route to an asset in the Viewer either by dragging a crew icon from the Crew Actions window to the affected asset in the Viewer or by dragging a crew symbol on another asset already in a Viewer to the affected asset.

Note: You can cancel the in-progress dispatch or crew move by pressing the **Esc** key or by dragging the crew outside the Viewer and releasing the mouse button.

Placing a Crew En Route from Crew Actions Window

To place a crew en route from the Crew Actions window using drag and drop, complete these steps:

1. Focus the Viewer on the event-related asset you wish to place the crew en route to.
2. In the Crew Actions window, select an available, undispached crew and drag it to the Viewer window toward the asset associated with the event you wish to place the crew en route to.
3. Release the mouse button when the asset becomes selected (highlighted) in the Viewer.
 - If multiple events are on the asset, a dialog box prompts you to specify which event the crew should be placed en route to. Select the appropriate event.
 - The crew symbol appears at the asset. The Crew Actions and Work Agenda windows update to indicate that the crew is now en route to the event.

Placing a Crew En Route from the Viewer

To place a crew en route from the Viewer using drag and drop, complete these steps:

1. Focus the Viewer such that you can see both the symbol of the crew you wish to re-dispatch and the event you wish to re-dispatch the crew to. Alternatively, you can open two Viewers and focus one Viewer on the crew's current location, and the other Viewer on the new location.

2. In the Viewer window, click and drag the crew symbol to the asset that has the event you wish to place the crew en route to.
3. Release the mouse button when the asset becomes selected (highlighted) in the Viewer.
 - If multiple events are on the asset, a dialog box prompts you to specify which event the crew should be placed en route to. Select the appropriate event.
 - The crew symbol appears at the asset. The crew is released from its previous event and placed en route to the new event. The Crew Actions and Work Agenda windows update to indicate that the crew is now en route to the new event and no crew is en route to the old event.

Moving a Crew with Drag and Drop

Moving a crew does not change the event the crew is en route to, rather, it moves the crew to another asset location and keeps it associated with the same event. By default, Oracle Utilities Network Management System locates a crew at the predicted or confirmed clearing asset so that graphically the crew appears to be at the same location as the outage symbol in the Viewer. In some cases, the crew may actually have to work at a location different from the clearing asset.

Note: You are not required to move the crew to the actual asset location, but moving the crew can help you better keep track of what is going on in the field.

Moving a Crew from the Crew Actions Window

To move a crew from the Crew Actions window using drag and drop, complete these steps:

1. Focus the Viewer on the asset you wish to relocate the crew to.
2. In the Crew Actions window, click the en route crew and drag it to the Viewer window toward the asset that has the event you wish to relocate the crew to.
3. Release the mouse button when the relocation asset is selected (highlighted) in the Viewer. A confirmation dialog box appears.
4. Click **OK** to complete the move or **Cancel** to cancel the move.

Moving a Crew from the Viewer

To move a crew in the Viewer using drag and drop, complete these steps:

1. Focus the Viewer such that you can see both the symbol of the crew you wish to relocate and the asset you wish to relocate the crew to. Alternatively, you can open two Viewers, and focus one Viewer on the crew's current location and the other on the new location.
2. In the Viewer window, click and drag the crew symbol to asset that you wish to relocate the crew to.
3. Release the mouse button when the relocation asset is selected (highlighted) in the Viewer. A confirmation dialog box appears.
4. Click **OK** to complete the move or **Cancel** to cancel the move.

Bulk Crew Loading and Deleting (Administrative Users)

Administrative Users may perform a bulk import or deletion of crews and crew components (members and vehicles) using the `nms_load_crews` program. The program, which is run from a terminal, requires separate CSV files for crews, crew members, and vehicles.

```
nms_load_crews -crews filename
               -members filename
               -vehicles filename
               [-add|-delete]
               [-force]
               [-status inactive|off-shift|on-shift]
```

[] optional parameter

Options

crews: Required. The crew file to import.

members: Required. The members file to import.

vehicles: Required. The vehicles file to import.

add|delete: Whether to add or delete the crews, members, and vehicles. The default is **add**, which is assumed if omitted.

status: Used with the **-add** option. Whether to add new crews as inactive, off-shift, or on-shift. Default: off-shift.

force: Used with the **-delete** option. Whether to force the deletion of active crews. Default: false.

Example

```
nms_load_crews.ces -crews crews.csv -members members.csv -vehicles
vehicles.csv
```

Crew CSV Columns

The columns in the Crew CSV file matches the CREWS database table column names:

CREW_KEY: numerical key for the crew

CREW_TYPE: CREW_TYPES.CREW_TYPE value

TEMP_FLAG: temporary crew Y/N flag

ZONE_NAME: CONTROL_ZONES.NAME value

ZONE_CLS: CONTROL_ZONES.NCG_CLASS value

ZONE_IDX: CONTROL_ZONES.NCG_ID value

CREW_SIZE: the crew size

CONTACT: the contact name

CREW_NAME: the crew name

MOBILE_NUM: the mobile number

PAGER_NUM: the pager number

MDT_CREW: MDT crew Y/N flag

EXTERNAL_KEY: external ID of the crew

OUT_OF_RANGE: out of range Y/N flag

MOBILE_FLAG: Y, N, or O (mobile overridden for NMS)

MEMBERS: colon-separated list of MEMBER_EMP_NUMB

VEHICLES: colon-separated list of VEHICLE_NUMB

Crew Member CSV Columns

The columns in the Crew Members CSV file matches the CREW_MEMBERS database table column names:

MEMBER_NAME: member name

MEMBER_CLASS: CREW_MEMBER_CLASSES.MEMBER_CLASS

MEMBER_EMP_NUMB: employee ID

Crew Vehicles CSV Columns

The columns in the Crew Vehicles CSV file matches the CREW_VEHICLES database table column names:

VEHICLE_TYPE: CREW_VEHICLE_TYPES.VEHICLE_TYPE

VEHICLE_NUMB: vehicle ID

Using Bulk Add/Delete Scripts

For convenience, two scripts (**nms_add_crews.ces** and **nms_delete_crews.ces**) are available to run the bulk crew changes. Pass arguments to these scripts as stated above or create your own project version that uses a consistent set of options that follow your project's business practices.

Examples

```
nms_add_crews.ces -crews crews.csv -members members.csv -vehicles  
vehicles.csv
```

```
nms_delete_crews.ces -crews crews.csv -members members.csv -vehicles  
vehicles.csv
```

```
nms_delete_crews.ces -crews crews.csv -members members.csv -vehicles  
vehicles.csv -force
```

Managing Calls with Web Trouble

Oracle Utilities Network Management System – Web Trouble includes windows that help you manage trouble calls. This section describes those windows and how to perform basic call management functions. It includes the following topics:

- [Changing Rule Sets](#)
- [Using the Trouble Info Tab](#)
- [Viewing Call Info](#)
- [Ungrouping Calls](#)
- [Moving Customers to a Different Asset](#)
- [Unassociating/Reassociating a Call from/to an Asset](#)
- [Editing Clues](#)

Changing Rule Sets

Rule sets are a collection of analysis rules that Oracle Utilities Network Management System Web Trouble uses to determine how and when certain asset will be predicted out and how fast a prediction moves upstream.

You can change the rule set for control zones over which you have authority over using the Authority window.

To change the rule set for a control zone, complete these steps:

1. Select **Authority** from the **Tools** menu in the Work Agenda. The Authority window opens.
2. Select the row of the control zone you want to change.
3. Click the **Change Rule Set...** button. A dialog box opens.
4. In the Rule Sets Available list, select the rule set you want to change to.
5. Click the **OK** button. The rule set for that control zone is updated. Oracle Utilities Network Management System Web Trouble will begin grouping and prioritizing new trouble calls in that control zone based on the new rule set.

Viewing Call Info

Detailed information about a logged call is displayed in the Call Info window. An event (represented by a single row in the Work Agenda) can have multiple calls if the calls have been grouped to one event. The Call Info window may be accessed from the Trouble Info window. You cannot edit the fields in the Call Info window; they are read only.

To open the Call Info window from the Trouble Info Callers view, select the row of the call you want to display and either click on the **Call Info...** button or select **Call Info...** from the Actions menu.

Call Info Window

The Call Info window displays the following fields and buttons:

- **Account #** displays the customer's account number.
- **Event Status** displays the current status of the event that this call is a part of.
- **Telephone** displays the customer's phone number.
- **Event #** displays the number assigned to the event by the system.
- **Name** displays the customer's name.
- **Clues** displays the short description representation of the Request drop-down menu selections that were entered when the call was logged.
- **Address** displays the customer's address.
- **Reported Start Date** displays the date and time the problem began for the customer.
- **City** displays the customer's city, state and zip code.
- **Call Taker ID** displays the user name of the person who entered the call.
- **Customer Type** displays the customer type value for the customer.
- **Crew ID** displays the name of the crew that has been placed en route to/is onsite at the event, if any.
- **Customer Asset** displays the name of the customer's service asset.
- **Callback Date** displays the date and time of the last callback attempt.
- **Zones** displays the control zones the customer is located in.
- **Customer Comment** displays any customer comments that were entered at the time the call was logged.

Buttons

- The **Print** button opens the Print Preview dialog box, which allows you to print the currently displayed customer call information.

Menus

The following table describes the Call Info menus.

- **File Menu**
 - **Print** – Opens up the Print Preview dialog box, which allows you to print out the contents of the currently displayed customer call information
 - **Exit** – Closes the Call Info window
- **Help Menu**
 - The Help menu displays the standard Help and About options.

Chapter 3

Web Call Entry

This chapter describes the Oracle Utilities Network Management System Web Call Entry application. Web Call Entry is used to enter and access customer call and event information. The application streamlines data entry and allows access to customer call, event, and dispatch information by personnel in various operations settings. Web Call Entry shares a database with other Oracle Utilities Network Management System applications. This allows you to view certain data that operations personnel and crew supervisors have entered into the system. The event history and call history information for a customer is often helpful when you are handling a new call from a customer reporting a service outage.

This chapter includes the following topics:

- [Logging in to Web Call Entry](#)
- [Using Web Call Entry](#)
- [Searching for a Customer](#)
- [Viewing Call History](#)
- [Viewing Event History](#)
- [Entering a Customer Call](#)
- [Entering a Fuzzy Call](#)
- [Canceling a Customer Call](#)
- [Viewing the Outages Summary](#)

Logging in to Web Call Entry

Web Call Entry is accessed using a URL (web address) or as a local application, depending on your site's policy. Your system administrator determines the web address, if applicable. If accessing Web Call Entry from a browser, complete these steps:

To log in to Web Workspace, complete these steps:

1. Depending on how your system was installed, do one of the following:
 - Click the Web Call Entry icon found under the appropriate program group in your Windows Start Menu.
 - Double click the Web Call Entry icon on your desktop.
 - Open a web browser and type the Web Call Entry URL in the browser's Address field.

The Web Call Entry Login window displays.

2. Enter your user name.

3. Enter your password.
4. Click the **Validate** button. The bottom portion of the Web Call Entry Login window sensitizes.
5. Select the appropriate User Type from the drop-down menu.
6. Click the **Login** button. The Web Call Entry main window appears.
7. If this is the first time running an Oracle Utilities Network Management System Windows-based product on your PC, you may be prompted to do a one-time download of a Java plug-in. If so, select **Yes** (or Accept or Agree) on all subsequent dialogs until Web Workspace opens.

Note: You or your system administrator can add Web Workspace to your Start menu and/or create a shortcut icon on your desktop for quick access to Web Workspace. When you start up Web Workspace for the first time, it will (depending on installation method) ask if you want to install a shortcut in your Start menu and on your desktop.

Using Web Call Entry

Web Workspace is presented as a single window that is divided into sections based on functionality and type of information displayed. The sections provide functional groupings of features, such as searchability and data display.

The following topics describe Web Workspace:

- [Menu and Toolbar](#)
- [Field Descriptions](#)

Related Topics:

- [Searching for a Customer](#)
- [Viewing Call History](#)
- [Viewing Event History](#)
- [Entering a Customer Call](#)
- [Entering a Fuzzy Call](#)
- [Canceling a Customer Call](#)
- [Viewing the Outages Summary](#)









Menu and Toolbar

The Web Call Entry menu and toolbar provide access to commonly used functions. Most of the functions in the **Actions** menu are also available on the toolbar.

File Menu

| Menu Option | Description | Toolbar Icon |
|--------------------|-----------------------------------|--------------|
| Outages Summary... | Opens the Outages Summary window. | |

Actions Menu

| Menu Option | Description | Toolbar Icon |
|----------------------------|--|---|
| Customer Search | Searches for customers based on the search criteria entered into the Searchable Information section. The system displays up to the first 100 customers located in the database that match the criteria. |  |
| Intersection Search | Searches for a street intersection based on one or two street names entered into the Intersection Search section. The order of the street names does not matter for matching purposes. |  |
| Call Search | Searches through previous calls based on the search criteria entered into the Searchable Information section. The system displays up to the first 100 calls located in the database that match the criteria. |  |
| Submit Call | Saves the call details entered into the request sections and clears the form. |  |
| Check Meter | Requests current status of the meter for the customer. This option is disabled if the customer is not AMR-enabled. |  |
| Call History... | Opens Call History , which lists current and historical calls from the customer. This option is disabled if a previous call does not exist. |  |
| Event History... | Opens Event History , which lists current and historical events involving the customer. Note that the customer need not have called to be part of an event. This option is disabled if a previous event does not exist. |  |
| Clear Form | Removes customer, event, and crew information from the fields on the window. Remember to save the call, if desired, before clearing the fields. |  |

Options Menu

| Menu Option | Description | Toolbar Icon |
|----------------------------------|---|--------------|
| Set Wild Card Searching | <p>Allows you to set the wild card search option. Wild card searching allows you to enter partial names or numbers in the searchable fields and all matching results will be returned. For example, if you have the wild card searching set to Both, and you enter "anders" into the Name field, the system returns customers named "Anderson", "Andersen", and "Sanders".</p> <ul style="list-style-type: none"> • Before - puts a wild card before the search string • After - puts a wild card following the search string • Both - puts a wild card both before and after the search string | -- |
| Use Sound Search | <p>Allows you to use the "sounds like" search feature, which displays search results that are phonetically similar to the search criteria. For example, if you enter "Jon Doh", the system would return customers such as "John Doe." If you select this search option, Wild Card searching and Exact Match searching options are disabled until this option is toggled off.</p> | -- |
| Use Exact Match Search | <p>Displays search results that exactly match the search criteria. This is the most restrictive search option. Wild Card searching and Sound searching options are disabled until this option is toggled off.</p> | -- |
| Set Max Searching Results | <p>Allows you to set the maximum number of search results returned. If you enter a maximum search result of "50", up to 50 entries display in the Customer Selection or Call Selection (search results) dialog box. This feature is helpful when using wild card searching. (For performance reasons, the system will not allow the maximum search results to be set above 100.)</p> | -- |

User Menu

The User Menu provides options to set preferences and log out of the Web Call Entry.

Preferences Menu

The **Preferences** menu allows you to control certain common features of the Web Workspace.

| Menu Option | Description |
|---------------------|--|
| Smaller Font | Decreases the font size in text and icons. Repeat to further decrease the font size. |
| Bigger Font | Increases the font size in text and icons. Repeat to further increase the font size. |
| Reset Font | The application will reset the text and icons to use their default font size. |

| Menu Option | Description |
|------------------------|---|
| Save Preferences | Saves the current settings as the user's preference. See Saving Workspace Preferences on page 1-12 for details. |
| Restore Preferences | Restores the environment preferences to the default settings. See Restoring Default Preferences on page 1-12 for information. |
| Change Color Scheme... | Opens the Change Color Scheme dialog box, which allows you to select from different user interface coloring schemes. The options are a Light scheme, a Dark scheme, and the default High Definition scheme. Unlike other user preferences, these apply to all environments for the user on the machine. |

Help Menu

| Menu Option | Description |
|----------------------|--|
| Web Call Entry Help | Launches the online help system and loads the Web Call Entry content. |
| Email Log Files... | Gathers the environment's log files and attaches them to a new email message using your default email client. The log files can then be sent to your support team or contact for further analysis. |
| Set Debug... | Launches the Set Debug dialog box allowing you to set debug on or off within your current environment. This is used for debugging and analysis purposes. See Setting Debug on page 10-33 for more information. |
| About Web Call Entry | Opens a window with environment and software information. |

Field Descriptions

This section describes the fields and buttons on the Web Call Entry window.

Searchable Information

The Searchable Information section allows you to enter search criteria to locate information for the customer calling to report a problem or request service. You can execute a search with full or partial data by entering information in any of the searchable fields and then either clicking the **Search** button or selecting Search from the Actions menu. If there is more than one match for the query, results are displayed in a Customer Selection table. From the Customer Selection table, you can select the appropriate record. For more information, see [Searching for a Customer](#).

The Searchable Information section displays the following fields:

- The **Call ID** field contains the unique Call ID generated when a call is entered. A successful search on this field will open the Call History window with information from this call.
- The **Account #** field contains the customer account number. Enter all or part of the account number to **search for the customer**.
- The **Telephone** field contains the customer telephone number. Enter all or part of the telephone number to **search for the customer**.

- The **Name** field contains the customer name. Enter all or part of the customer name to search for the customer.
- The **Address** field contains the customer address or the address for the problem location. Enter all or part of the address to search for the customer or problem location.
- The **City** field contains the city and state. Enter all or part of the city to search for the customer.
- The **Zip** field contains the zip code. Enter all or part of the zip code to search for the customer.

Intersection Search Section

The Intersection Search section allows you to enter one or two street names and see a list of all matching street intersections containing the names. This allows the entry of a call that can be associated to the street intersection, which is helpful if someone is reporting a leak or an outage, but is not correctly located in the database.

The Intersection Search section displays the following fields:

- The **Street 1** field is required for searches and should just contain the street name with no numeric address part and no suffix such as St, Ln, Rd, S, W, and so on. Capitalization does not matter.
- The **Street 2** field is optional for searches and should just contain the street name with no numeric address part and no suffix such as St, Ln, Rd, S, W, and so on. Capitalization does not matter.

Note: The order of the street names does not matter. If the database has "W 50th ST & BIRCH ST" as the intersection, it still will be found if you enter "Birch" for **Street 1**.

Additional Customer Information

The Additional Customer Information section displays the following fields:

- The **Account Type** field is a view-only field that indicates the type of customer account (for example, electric).
- The **Customer Type** field is a view-only field that indicates the type of customer (for example, critical). If a customer type has not been designated for the customer, this field will have 'STD'.
- The **Customer Asset** field is a view-only field that indicates the asset name associated with the customer.
- The **ERT to Report** field is used to track the estimated restore times (ERTs) given to a caller. If the customer is part of one or more outages, the **ERT to Report** field will default to the latest of the ERTs for outages affecting that customer. The button on the right opens a calendar dialog box from which the reported date and time can be selected.

When the **amr** product is licensed, the Additional Customer Information section contains several fields, which allow users to check the current customer's meter status.

- The **Meter** field is a view-only field that displays the meter identification.
- The **Request Meter Status** button allows the user to request the customer's current meter status. This button is disabled if the customer is not AMR-enabled.
- The **Meter Status** field is a view-only field that displays meter status information received from the AMI system or an indication that there is an outstanding meter status request for the customer.

Appointment Request

The Appointment Request section allows you to schedule an appointment or record a prior notification requirement for a meet. The Appointment Request section includes the following fields:

- **Type** is a drop-down menu that allows you to select the appointment type:
 - **None**, the default value, signifies that there is not an appointment request for the call.
 - **After** signifies that an appointment is being scheduled within a range after the time given in the Date/Time field. For example, scheduling a meet between 8:00 a.m. and noon would have range of 04:00 and a time beginning at 08:00.

- **Call Before** is for appointments where there is not a specific time or range, but the customer needs a certain amount of forewarning prior to the appointment. For example, it may be the time required for the customer travel from work to their home for the appointment.

Callback Request

The Callback Request section allows you to specify a 'call before' date/time and an optional callback phone number, or indicate if no callback was requested. The information you enter in these fields is saved to the database and used by other Oracle Utilities Network Management System applications and possibly other 3rd party systems that are interfaced to Oracle Utilities Network Management System.

The Callback Request section includes the following fields:

- **Call Before Date** is a radio button that allows you to indicate that the customer would like to be contacted (called back) when the event is restored. Click on the calendar button to select a date and time after which the callback should not be performed. The date field can be left blank if the customer does not indicate a restriction.
- **No Callback Requested** is a radio button that allows you to indicate that the customer does not want to be called back regarding the event.
- The **Callback Phone** field contains an optional phone number, to be entered if the customer wishes to be called back at a different number (for example, their cell phone) than the primary phone number on their account.

Request

The Request section allows you to enter general details provided by the caller. The information you enter in these fields is saved to the database and used by other Oracle Utilities Network Management System applications and possibly other third party systems that are interfaced to Oracle Utilities Network Management System.

- **Flow** is a drop-down menu that allows you to select the status of the water flow (for example, **Gushing**).
- **Quality** is a drop-down menu that allows you to select the status of the water quality (for example, **Bad Taste**).
- **Cause** is a drop-down menu that allows you to select the cause (if known) of the event (for example, **Frozen Pipe**).
- **Meter** is a drop-down menu that allows you to select an action needed in regard to the meter (for example, **Connect**).

Note: The actual set of drop-down menus may be different at your company.

Customer Comment

- The **Customer Comment** field allows you to enter a note based on the remarks of the caller.

Operations Event Note

- The **Operations Event Note** field displays any dispatcher or crew notes that may have been entered into the system, such as waiting for special equipment or for traffic police to secure an area. This field is view-only.

Event Information

The Event Information section is view-only and populated with information only if one or more active events are associated with the customer. The Event Information table displays information about each active event associated with the customer. To view the Operations Event Note if there are multiple events, select the desired event from the table.

The Event Information Section displays the following columns:

- The **Event #** column contains the unique number assigned to the event. The event number is also displayed in other Oracle Utilities Network Management System applications in order to track the status of the event.
- The **Event Asset** column contains the name of the asset associated with the event.
- The **Event Type** column contains a classification of the event. See [Event Type Codes](#) on page B-4 for a complete list of event type codes and their descriptions.
- The **Start Date** column contains the date and time the event began.
- The **Est Rest Time** column contains the date and time the operations center or the crew predicts the event will be resolved.
- The **Trouble Codes** column contains the trouble codes that were entered when the call was taken (for example, Low). See [Event Type Codes](#) on page B-4 for a complete list of event type codes and their descriptions.
- The **Primary Cause** column contains the Primary Cause selected for the event in Event Details. See the Event Details [Using the Completion Actions Tab](#) on page 2-5 for information on Primary Cause selection.
- The **# Cust** column contains the estimated number of customers affected by the event.

Crew Information

The Crew Information section displays the following information about any crew currently associated with active events.

- The **Event #** column contains the unique number assigned to the event. The event number is also displayed in other Oracle Utilities Network Management System applications in order to track the status of the event.
- The **Crew ID** column contains the identification name or number of the crew.
- The **Assigned Date** column contains the date and time the crew was assigned to the event. If the crew is released or changed to en route, the column will be blank.
- The **# Assignments** column contains the total number of events to which the crew is assigned.
- The **En Route Date** column contains the date and time the crew was placed en route to the event.
- The **On Site Date** column contains the date and time the crew arrived on site.

Planned Outages Information

The Planned Outages Information section displays the following information about any upcoming planned outage that the customer will be a part of.

- The **Planned Start** column contains the date and time the planned switching work is scheduled to begin.
- The **Planned Finish** column contains the date and time the planned switching work is scheduled to end.
- The **Office** column contains the office responsible for the switching plan.
- The **Work Location** column contains the street address or specific location for the switching operation.
- The **Description of Work** column contains a general description about what the planned switching work is trying to accomplish.

Searching for a Customer

When a customer calls in, you can enter the details for the call in Web Call Entry. First you must search for the customer in order to populate the necessary information for submitting the call.

To search for a customer, complete these steps:

1. Verify that you have selected the preferred search option settings. Select the **Options** menu to view the current settings.
2. Enter all or part of the customer's information in the **Searchable Information** fields (for example, name, telephone number, and so on). Typically you will fill in search information in only one of the fields for a search.
3. Click the **Search** button on the toolbar, or press **Enter**. If a match is found, the customer information is displayed on the Web Call Entry window.
4. If more than one customer matches the search criteria, the Customer Selection dialog box displays the search results display in a table that contains the customer's account number, name, address, city, state, zip code, and telephone number. You can use this information to confirm that you are entering an event for the correct customer.
5. Select the customer from the list and click the **OK** button. The customer's information displays on the main Web Call Entry window.

Searching for a Customer Using the Call ID

When a customer calls in to follow up on a previous call, you can search for that call in Web Call Entry.

To search for a call using the original call ID, complete these steps:

1. Enter the call ID in the Searchable Information **Call ID** field.
2. Click the **Search** button on the toolbar, or press Enter. If a match is found, the Call History window opens. (See [Viewing Call History](#) on page 3-11.) Skip to step 5.
3. If more than one call matches your search criteria, the Call Selection dialog box opens. The search results display in a table that contains the call date/time, name, address, city, state, zip code, and telephone number. You can use this information to confirm that you are retrieving the correct call.
4. Select a call from the list and click the **OK** button. The call's information displays on the main Web Call Entry window.
5. Confirm that it is the correct call and click the **Load** button. The Call History window closes and the call information displays in the Web Call Entry window.

Search for a Call using Caller Information

To search for a call using previous caller information, complete these steps:

1. Verify that you have selected the preferred search option settings. Select the **Options** menu to view the current settings.
2. Enter all or part of the caller's information in the **Searchable Information** fields (for example, name, telephone number, and so on) Typically you will fill in search information in only one of the fields for a search.
3. Click the **Call Search** button on the toolbar. If a match is found, the call information is displayed.
4. If more than one call matches the search criteria, the Call Selection dialog box opens (see above). The search results display in a table that contains the call date/time, name, address,

city, state, zip code, and telephone number. You can use this information to confirm that you are retrieving the correct call.

5. Select a call and click the **OK** button. The call information displays in the Web Call Entry window.

Viewing Call History

Call History allows you to view a historical record of customer calls. This is important for managing the relationship with customers who are repeat callers. Once you have selected a call from the customer's call history, you can view the details for the call.

Call History offers a tabular summary of each call a customer has made that is still in the database. The calls are chronologically ordered by call date, but can be sorted by any of the other columns by clicking on the column header. Click the column header once to sort in one direction (for example, ascending order), and click a second time to sort in the other direction (*e.g.*, descending order).

You can access **Call History** by clicking the **Call History** button on the toolbar or selecting **Call History...** from the Actions menu.

Note: Your system administrator sets up the amount of call history data maintained in the database.

Call History User Interface

Call History displays the following sections:

Call History

- The **Call Date** column contains the date and time the customer call was entered.
- The **Trouble Codes** column contains the trouble conditions for the event (for example, out).
- The **Customer Comment** column contains comments from the customer as entered by the call taker, if any.
- The **Active** column is an indicator of whether the call is active. Values are:
 - Y - Yes, call (and associated event) are still active
 - N - No, call (and associated event) are resolved
 - C - Cancelled, customer called back to cancel call
 - E - Cancelled, operator cancelled event via Work Agenda
- The **Reported ERT** column contains the ERT value that was explicitly provided to the customer on that call.
- The **Call ID** column contains the unique ID generated when call is entered into system.

If you select a row in the table, the details for that call are displayed in the window below the table. The call details include customer information, callback request information, event information (for example, cause), and customer comments. The information on the Call History window is view-only except for the Callback Phone and the Customer Comment area. The fields on the Call Details window generally match the fields on the main Web Call Entry window.

Call Taker ID

- The **Call Taker ID** field displays the ID of the user who recorded the call.

Control Zone

- The **Control Zone** field displays the Control Zone where the problem is located.

Call Information

- The **Reported Start Date** field is a field that indicates when the event was first reported to have started.

Customer Information

- The **Call ID** field contains the unique Call ID generated when a call is entered.
- The **Account #** field contains the customer account number.
- The **Telephone** field contains the customer telephone number.
- The **Name field** contains the customer name.
- The **Address** field contains the customer address or the address for the problem location.
- The **City** field contains the city, state, and zip code.
- The **Customer Type** field is a field that indicates the type of customer (for example, critical). If a customer type has not been designated for the customer, this field will have a value of zero (0).
- The **Customer Asset** field is a field that indicates the asset name associated with the customer.

Appointment Request

The Appointment Request section includes the following fields:

- **Type** is a drop-down menu that allows you to select the appointment type:
 - **None**, the default value, signifies that there is not an appointment request for the call.
 - **After** signifies that an appointment is being scheduled within a range after the time given in the Date/Time field. For example, scheduling a meet between 8:00 a.m. and noon would have range of 04:00 and a time beginning at 08:00.
 - **Call Before** is for appointments where there is not a specific time or range, but the customer needs a certain amount of forewarning prior to the appointment. For example, it may be the time required for the customer travel from work to their home for the appointment.

Callback Request

- **Call Before Date** is a radio button that indicates that the customer wanted to be contacted (called back) when the event is restored.
- **No Callback Requested** is a radio button that indicates that the customer did not want to be called back regarding the event.
- The **Callback Phone** field contains an optional phone number that was entered if the customer wished to be called back at a different number than the primary phone number on their account.

Last Callback

- This displays the last **Callback Time** and **Callback Result**.

Request

- **Power** is a drop-down menu that indicates the status of the power (for example, dim lights).
- **Cause** is a drop-down menu that indicates the cause (if known) of the event (for example, tree limb on wire).
- **Description** is a drop-down menu that indicates an additional description of the event (for example, sagging wire).

- **Street Light** is a drop-down menu that indicates problems with streetlights or traffic lights.
- **Meter** is a drop-down menu that indicates an action needed in regard to the meter (for example, connect).
- **Meet** is a drop-down menu that indicates whether emergency or other personnel were to be met on the scene (for example, meet fire).
- **Priority** is a drop-down menu that indicates whether the event is/was a priority situation (for example, extreme/life).
- **Other** is a drop-down menu that indicates whether or not the call was simply an "informational" one (the call to cancel a previous call doesn't show up in the Call History, so this would never display the value of "Cancel").

Customer Comment

- The **Customer Comment** field displays the remarks of the caller, if any.

Toolbar Buttons

- The **Load** button loads Customer Information (based on the call) in the Web Call Entry window and closes the Call History window. Other information, such as Events and Crews, will be populated as if you had searched for the customer in the Web Call Entry window.

Note: The **Load** button is only enabled if the search was based on Call ID.

- The **Save** button saves any changes to the Callback Phone or Customer Comment fields and closes the Call History window.
- The **Cancel** button allows you to cancel the selected call.
- The **Close** button closes the Call History dialog box.
- The **Help** button displays help for this window.

Viewing Event History

Event History offers a table summary of events related to the customer. The events are chronologically ordered by start date, but can be sorted by any of the other columns by clicking on the column header. You can access **Event History** by clicking the **Event History** button on the toolbar or selecting **Event History...** from the Actions menu.

Note: Your system administrator sets up the amount of event history data available.

Event History Section

- The **Event #** column contains the unique number assigned to the event. The event number is also displayed in other Oracle Utilities Network Management System applications in order to track the status of the event.
- The **Customer Start Date** column contains the date and time the event was reported to have begun for this customer.
- The **Customer Restored Date** column contains the date and time the event was resolved for this customer. If this field is empty, then the event has not been completed in Oracle Utilities Network Management System.
- The **Event Type** column indicates whether the event was an outage or non-outage.
 - **OUT:** An outage event where some customers were without service.
 - **NON:** A non-outage event, such as a minor quality issue.)

- If you select a row in the table, the details for that event are displayed in the window below the table. The event details include the event number, asset and pressure zone information, and event time information. The information on the Event History window is view-only. Many of the fields on the Event History window match the Event Information and other fields on the main Web Call Entry window.

Event Information Section

- The **Event #** field displays the unique number assigned to the event. The event number is also displayed in other Oracle Utilities Network Management System applications in order to track the status of the event.
- The **Pressure Zone** field displays the pressure zone associated with the event.
- The **Event Asset** field displays the asset associated with the event.
- The **Est Cust Affected** field displays the estimated number of customers affected by the event.
- The **Customer Start Date** field displays the date and time the event was reported to have begun for this customer.
- The **Customer Restored Date** field displays the date and time the event was resolved for this customer. If this field is empty, then the event has not been completed in Oracle Utilities Network Management System.
- The **Primary Cause** field displays the Event Details Primary Cause, if available. See the Event Details [Using the Completion Actions Tab](#) on page 2-5 for information on Primary Cause selection.
- The **Remedy** field displays the value from the Event Details Remedy drop-down if it has been populated from Web Trouble.

Cause Factors

- The **Scheduled** field displays the value from the Event Details Scheduled drop-down if it has been populated from Web Trouble.
- The **Utility Error** field displays the value from the Event Details Utility Error drop-down if it has been populated from Web Trouble.
- The **Other** field displays the value from the Event Details Other drop-down if it has been populated from Web Trouble.
- The **Foreign Interf.** field indicates any foreign interference associated with the outage.
- The **Vegetation** field displays the value from the Event Details Vegetation drop-down if it has been populated from Web Trouble.
- The **Defective Equip.** field displays the value from the Event Details Defective Equip. drop-down if it has been populated from Web Trouble.
- The **Environment** field displays the value from the Event Details Environment drop-down if it has been populated from Web Trouble.
- The **Weather** field displays the value from the Event Details Weather drop-down if it has been populated from Web Trouble.

Operations Cancellation Reason

- The **Operations Cancellation Reason** field displays the reason given for canceling the event if cancelled by operations personnel. Typically done if event was inadvertently entered in the system.

Operations Cancellation Reason

- The **Operations Event Note** field displays notes entered regarding the event. These notes may include crew remarks and resolution issues.

Toolbar Buttons

- The **Close** button closes the Event History window.
- The **Help** button displays help for this window.

Entering a Customer Call

After you have located the information for a customer and have reviewed any call history and event history, you can proceed to enter a call. You enter all call information in the main Web Call Entry window.

To enter a customer call, complete these steps:

1. Search for the customer information. (For details on how to search for customer information, see [Searching for a Customer](#).)
2. If the customer wishes to be called back when the event is complete, click the **Call Before Date** radio button. If part of your business process, and if the customer indicates a restriction, click on the **Calendar** button (at right) to enter the date and time after which the customer no longer wants to be called. If the customer provides a different phone number for the callback, enter it in the Callback Phone field.
3. Select the appropriate options from the drop-down menus in the Request section. These are necessary for operations personnel to understand and quickly resolve the event.
4. In the Customer Comments field, enter any information that the customer provides that will assist the operations personnel or the crew.
5. Save the call by clicking the **Submit Call** button on the toolbar or selecting the Submit Call option from the **Actions** menu. A dialog box will open displaying a Call ID.
6. Provide the Call ID to the customer, and then click the **OK** button to dismiss the dialog box.

Entering an Informational Call

A customer may call back to ask when their service is expected to be restored. If you need to keep track of when estimated restore times (ERTs) are provided to a customer, complete these steps:

1. Search for the customer information. (For details on how to search for customer information, see [Searching for a Customer](#) on page 3-10.)

Note: The **ERT to Report** field will default to the latest of the ERTs for outages affecting that customer. If the field is blank, or if a different ERT is given to the customer (for example, by rounding the listed ERT up to the next half hour), then modify the field to display the actual ERT that the customer is told. Select the button on the right to open a calendar dialog box from which the reported date and time can be selected.

2. In the Web Workspace Request section, select the **Informational** option from the **Other** drop-down.
3. Save the call by clicking the **Submit Call** button on the toolbar or selecting the Submit Call option from the Actions menu.

Entering a Fuzzy Call

Fuzzy calls are calls that are not initially associated with a customer or asset. For example, a fuzzy call results when you receive a call from the police reporting a leak. The fuzzy call can later be associated with a specific asset.

The search will not match a specific customer, but will instead display the Fuzzy Call dialog box.

To enter a fuzzy call, complete these steps:

1. Enter the address information (for example, cross streets). A fuzzy call should have some address information filled in, even if it just an intersection.
2. Click the **Search** toolbar icon or select the **Search** option from the **Actions** menu. A dialog box appears, indicating that there was no match for the search criteria, but the call can be edited or saved.
3. If you know the control zone associated with the trouble location indicated by the caller, click on the **Control Zone Selection** button to the right of the Control Zone field. Select the control zone from the tree display and then click the **OK** button.
4. Click the **Edit Call** button.
5. If the caller wishes to be called back when the event is resolved, click the **Call Before Date** radio button. Then, click on the **Calendar** button (at right) to enter the date and time after which the customer no longer wants to be called. Enter the caller's phone number in the **Callback Phone** field.
6. Select the appropriate options from the drop-down menus in the **Request** section, such as Cause, Description, Meet, Priority, and Other. (See [Callback Request](#) for details.) These are necessary for operations personnel to understand and quickly resolve the event.
7. In the **Customer Comments** field, enter any information that the caller provides that will assist the operations personnel or the crew.
8. Save the call by clicking the **Submit Call** button on the toolbar or selecting the **Submit Call** option from the **Actions** menu.

Note: This button is only enabled if the Address field was filled in when the search was done.

A dialog box will open displaying the Call ID.

9. Provide the Call ID to the caller, and then click the **OK** button to close the dialog box.

Canceling a Customer Call

You can cancel a call from the Call History window. This is useful if a customer calls back to indicate that the problem related to the initial call has been resolved. You can cancel fuzzy calls using this procedure.

Note: The original call is not removed from the system; rather, its status is changed to C (cancelled) and a new call is created with a status of N, indicating that the original call and its associated event have been resolved.

To cancel a customer call, complete these steps:

1. Search for the customer information. (For details on how to search for customer information, see [Searching for a Customer](#).)
2. Click the **Call History** button on the toolbar or select **Call History...** from the Actions menu.
3. Select the call in the Call History list. The Cancel button is enabled.
4. Click the **Cancel** button on the toolbar. The Cancel Call dialog box is displayed.
5. Enter the reason for the cancellation, and click **OK**.
6. You can view the original cancelled call and the new call entry in the Call History.

Canceling All Calls For a Customer Account

Use this procedure to cancel all calls for a customer account.

1. Search for the customer information. (For details on how to search for customer information, see [Searching for a Customer](#) on page 3-10.)
1. In the Request section of the main Web Call Entry window, select the Cancel option from the Other drop-down.
1. Save the call by clicking the **Submit Call** button on the toolbar or selecting the Submit Call option from the Actions menu.

Note: Fuzzy calls must be cancelled in the Work Agenda. See the previous procedure.

Viewing the Outages Summary

The **Outages Summary** presents the user with a view-only summary of the total active outage events in the system. The information in the window dynamically updates as new calls come in and as new outages are created and restored. The events are sorted by default on the E/H and # Out values, but can be sorted by any of the other columns by clicking on the column header. You can access the Outages Summary by clicking the **Outages Summary** button on the toolbar or selecting **Outages Summary** from the **File** menu.

Note: the Outages Summary is not available when Web Call Entry is integrated in the Web Workspace since the information is available in the Work Agenda.

The **Outages Summary** contains two tables. The top table is a summary and the table below it displays a row for each event in the summary table.

The summary table at the top of the Outages Summary window displays the following columns:

- The **Events in View** field displays the number of events currently displayed in the Outages Summary.
- The **Est Cust Out** field displays the number of customers estimated to be affected by the events currently displayed in the Outages Summary.
- The **Calls** field displays the number of calls entered for the events currently displayed in the Outages Summary.
- The **Pri Calls** field displays the number of priority calls entered for the events currently displayed in the Outages Summary.
- The **EMR Cust Out** field displays the number of emergency customers affected by the events currently displayed in the Outages Summary.
- The **MED Cust Out** field displays the number of medical customers affected by the events currently displayed in the Outages Summary.
- The **KEY Cust Out** field displays the number of key customers affected by the events currently displayed in the Outages Summary.
- The **Crews En Route/Onsite** field displays the number of crews en route to/onsite at the events currently displayed in the Outages Summary.

The **Current Outages** table displays the following columns:

- The **E/H** column indicates whether or not the event is an emergency or hazardous condition. An "E" in this column denotes extreme emergency, and an "H" in this column denotes hazardous.
- The **# Out** column contains the number of customers experiencing an outage for the event.
- The **# Crit** column contains the total number of critical customers experiencing an outage for the event.
- The **# Calls** column contains the number of calls received for the event.
- The **Region** column contains the control zone region where the event occurred.
- The **Branch** column contains the control zone branch where the event occurred.
- The **Substation** column contains the control zone substation where the event occurred.
- The **Location** column contains either the address of the first customer that called if the event is a service outage or non-outage or the pressure zone location of the asset if the event is an asset outage.
- The **Start Date** column contains the date and time the event began.
- The **Est Restore Date** column contains the estimated restoration time (ERT) for the event.

- The **Est Src** column contains the source of the ERT for the event. The possible source values are:
 - N - none (no ERT)
 - S - Oracle Utilities Network Management System - Storm Management
 - P - Oracle Utilities Network Management System Storm Management "non-published global ERT"
 - O - Oracle Utilities Network Management System Storm Management "onsite ERT" used when the crew is en route or onsite. If the crew is en route, the ERT includes the travel time plus the repair time; if the crew is onsite, the ERT only includes the repair time.
 - G - Oracle Utilities Network Management System Storm Management "published global ERT"
 - C - User-entered (assumed to have been provided by the crew)
 - I - Initial default ERT
- The **Clues** column contains the clue codes for the calls received, if any.
- The **Status** column displays the status assigned to the event. See [Event Status Codes](#) on page B-1 for a complete list of status codes and descriptions.
- The **Crews** column contains the crew ids of the associated crews.

The **Operations Event Note** field displays the Operations Event Note for the selected event, if any.

Buttons

- The **Auto Filter** button allows you to quickly filter the view by the selected cell value.
- The **Auto Filter Off** button turns off any auto filter that has been applied.

Menus

The following table describes the Outages Summary menus.

| Menu | Option | Description |
|---------|----------------------|--|
| File | Print | Opens up the Print Preview dialog box, which allows you to print out the Outages Summary window. |
| File | Exit | Closes the Outages Summary window. |
| Filter | Auto Filter | Allows you to quickly filter the view by the selected cell value. |
| Filter | Auto Filter Off | Turns off any auto filter that has been applied. |
| Actions | Default Sort | Applies the default sort to the Outages Summary. |
| Help | Web Call Entry Help | Opens online help for Web Call Entry. |
| Help | About Web Call Entry | Opens the standard About dialog. |

Chapter 4

Web Callbacks

This chapter describes the Web Callbacks module functionality. It includes the following topics:

- [Overview](#)
- [Starting Web Callbacks](#)
- [The Web Callbacks Window](#)
- [Assigning Callbacks](#)
- [Viewing Callback Assignments](#)
- [Unassigning Callbacks](#)
- [Performing Callbacks](#)

Overview

Oracle Utilities Network Management System Web Callbacks is an application used to manage callback requests for customers who have called in reporting an outage. When the outage is resolved, Web Callbacks provides the information necessary to call customers. Web Callbacks allows you to assign groups of callbacks to users and outsourcing agencies, and also supports a "one-at-a-time" approach, where you can select an outage and perform the next callback. Callbacks are only created for customers who called in and had "Callback Requested" indicated when their call was entered.

Web Callbacks displays information about the outage and the original customer call, and allows you to save the results of the callback (outage restored, phone busy, and so on). Customers whose outage is not restored are re-introduced into the Oracle Utilities Network Management System for re-analysis and restoration. A Still Out trouble code clue, which appears in Clues field in Work Agenda and Trouble Info, is added to calls re-introduced in this way. Web Callbacks interfaces with other Oracle Utilities Network Management System modules to display customer comments and operations remarks.

Starting Web Callbacks

Web Callbacks is accessed using a URL (web address) or as a local application, depending on your site's policy. Your system administrator determines the web address, if applicable. If accessing Web Callbacks from a browser, complete these steps:

- Open your web browser by clicking the shortcut on the desktop, or from the Start menu.
- In the Address field of the browser, enter the URL for Web Callbacks, then press Enter. Please wait while Web Callbacks starts.
- If this is the first time running an Oracle Utilities Network Management System Windows-based product on your PC, you may be prompted to do a one-time download of a Java plug-in. If so, select Yes/Accept/Agree on all subsequent dialogs until Web Callbacks opens.

Note: You or your system administrator can add Web Callbacks to your Start menu and/or create a shortcut icon on your desktop for quick access to Web Callbacks. When you start up Web Callbacks for the first time, it will (depending on installation method) ask if you want to install a shortcut in your Start menu and on your desktop.

Logging In

The Login window is the first Web Callbacks window you see. You must enter a valid user name and password, and then click the **Validate** button. Once your user name and password are validated, the system populates the option menu that allows you to select a user type.

The Login window displays the following fields and buttons:

- The **User ID** field allows you to enter the user name provided to you by the system administrator.
- The **Password** field allows you to enter the password provided to you by the system administrator.
- The **Validate** button verifies your login credentials. If the user name and password are not entered correctly, the system displays a warning dialog box.
- The **User Type** drop-down menu contains the list of user types within your authority.
- The **Login** button allows you to complete the login process. Once you click the Login button, the Web Callbacks window opens.
- The **Quit** button exits the Login window.

Logging In

To login to Web Callbacks, complete these steps:

1. Depending on how your system was installed, do one of the following:
 - Click the **Web Callbacks** icon found under the appropriate program group in your Windows Start Menu.
 - Double-click the **Web Callbacks** icon on your desktop.
 - Open a web browser and type the Web Callbacks URL in the browser's Address field.

The Web Callbacks Login window displays.

2. Enter your user name in the User Name field.
3. Enter your password in the Password field.
4. Click the **Validate** button. The bottom portion of the Web Callbacks Login window sensitizes.

5. Select the appropriate User Type from the drop-down menu.
6. Click the **Login** button. The main Web Callbacks window will display.

The Web Callbacks Window

The Web Callbacks main window displays all of the events that have callbacks that must be completed. You can perform callback actions in the window using the menu, the buttons on the toolbar, or the buttons at the bottom of the window.

The following topics describe how to use the Web Callbacks window:

- [Menus and Toolbars](#)
- [Header](#)
- [Callbacks Table](#)
- [Callbacks Summary Panel](#)

Related Topics:



- [Starting Web Callbacks](#)
- [Assigning Callbacks](#)
- [Viewing Callback Assignments](#)
- [Unassigning Callbacks](#)
- [Performing Callbacks](#)

Menus and Toolbars

The Web Callbacks menu bar provides access to all functions. The commonly used functions are also available on the toolbar and in buttons at the bottom of the window.

Actions Menu

The **Actions** menu allows you to control certain common features of the Web Workspace.

| Menu Option | Description | |
|----------------------------------|---|---|
| View My Callback Lists... | Opens the View My Callback Lists window, which displays a list of callbacks assigned to you. |  |
| Perform Next Callback... | Opens the Perform Next Callback window, which allows you to perform the next callback for the selected event. |  |
| Assign Callbacks... | Opens the Assign Callbacks window, which allows you to assign callbacks for the selected event. |  |

User Menu

The User Menu provides options to set preferences and log out of the Web Callbacks.

Preferences Menu

The **Preferences** menu allows you to control certain common features of the Web Workspace.

| Menu Option | Description |
|-------------------------------|---|
| Smaller Font | Decreases the font size in text and icons. Repeat to further decrease the font size. |
| Bigger Font | Increases the font size in text and icons. Repeat to further increase the font size. |
| Reset Font | The application will reset the text and icons to use their default font size. |
| Save Preferences | Saves the current settings as the user's preference. See Saving Workspace Preferences on page 1-12 for details. |
| Restore Preferences | Restores the environment preferences to the default settings. See Restoring Default Preferences on page 1-12 for information. |
| Change Color Scheme... | Opens the Change Color Scheme dialog box, which allows you to select from different user interface coloring schemes. The options are a Light scheme, a Dark scheme, and the default High Definition scheme. Unlike other user preferences, these apply to all environments for the user on the machine. |

Help Menu

| Menu Option | Description |
|----------------------------|--|
| Web Callbacks Help | Launches the online help system and loads the Web Callbacks content. |
| Email Log Files... | Gathers the environment's log files and attaches them to a new email message using your default email client. The log files can then be sent to your support team or contact for further analysis. |
| Set Debug... | Launches the Set Debug dialog box allowing you to set debug on or off within your current environment. This is used for debugging and analysis purposes. See Setting Debug on page 10-33 for more information. |
| About Web Callbacks | Opens a window with environment and software information. |

- **Logout Menu**
 - User Logout - exits Web Workspace.

Header

Beneath the Web Callbacks Toolbar is the header section. This section contains information regarding who is logged in to the application.

- The **User Name** field displays your Web Callbacks login user name. This field is not editable.

Callbacks Table

The Web Callbacks table contains a detailed list of each resolved event that still has callbacks remaining. These rows are color-coded by the status of the callback (not started versus in progress).

The Callbacks Table displays the following columns:

- The **Event #** column contains the unique number of the event.
- The **# Callbacks** column contains the number of callbacks for the event.
- The **# Pri** column contains the number of callbacks from priority calls for the event.
- The **% Comp** column contains the percentage of callbacks completed for the event.
- The **# Rem** column contains the number of callbacks remaining for the event.
- The **# Asn** column contains the number of remaining callbacks for the event that have been assigned.
- The **Start Date** column contains the reported start date and time of the event.
- The **Restore Date** column contains the date and time the event was restored.
- The **Asset** column contains the name of the asset associated with the event.
- The **Status** column contains the status of callbacks for the event:
 - **In Progress** - Some callbacks for the event have been completed.
 - **Not Started** - Some callbacks for the event may have been assigned, but no callbacks are completed.
- The **Lift Station** column contains the name of the lift station for the asset associated with the event.
- The **Zone** column contains the name of the branch office where the event occurred.
- The **# Users** column contains the number of users with assigned callbacks for the event.

Callbacks Table Column Features

Web Callbacks allows you to sort columns of its table by clicking on the particular column. The column displays an ascending sort after the first click and a descending sort after the second. A black arrow displays the direction of the sort. Clicking on other columns will initially sort based on the opposite sort type from the last column (ascending if previous column was sorted descending) and the sort direction reverses with subsequent clicks.

Sorting Callbacks

To sort based on a callback list column, complete these steps:

1. Click on the column that you want to sort. The column sorts in ascending order, indicated by a black arrow pointing upward.
2. Click again to sort the column in descending order, indicated by a black arrow pointing downward.
3. Click on a different column and the list is sorted ascending based on that column.

Rearranging Columns

You can dynamically rearrange the columns in a Web Callbacks list by dragging and releasing the column headers. To rearrange the columns, complete these steps:

1. On the column header for the column you want to move, click and hold down the mouse button with the pointer.
2. Move the pointer to drag the column left or right to the new location.

3. Release the mouse button. The column appears in the new location.

Note that this change is temporary. The next time you start Web Callbacks, the columns will display in their default order.

Callbacks Summary Panel

The Callbacks Summary panel appears in the lower portion of the Web Callbacks window. This panel displays summary information from the callback list. The Callbacks Summary panel includes the following fields:

- The **# Callbacks** field displays the total number of callbacks from events that still have active callbacks.
- The **% Complete** field displays the total percentage of callbacks listed in # Callbacks that are complete.
- The **# Remaining** field displays the total number of callbacks not completed, based on the # Callbacks.
- The **# Priority Calls** field displays the total number of callbacks that were priority, meaning those where the original call was for a priority situation (for example, hazardous area).

Note: Once all callbacks for an event have been completed, they are removed from the data displayed in the Callbacks Summary Panel. As a result, the % Complete can actually decrease when the last callback for an event is completed and that event is removed from the calculation.

The status bar appears at the bottom of the Web Callbacks window, providing informational messages to the user at various times. Messages will appear in the status bar when callbacks are assigned, unassigned, or cancelled, when callbacks are saved or when a new callbacks user is created.

Assigning Callbacks

The Assign Callbacks window is used to assign callbacks for a specific event to you and/or other logged in users in order to manage the completion of the callback requests. If callbacks have been assigned to a user and that person is unable to complete the callbacks in a timely fashion, you can unassign those callbacks.

To access the Assign Callbacks window, select an event in the main Web Callbacks window, and then do one of the following:

- Select the **Assign Callbacks...** option from the **Actions** menu, or
- Click the **Assign Callbacks** button () on the toolbar, or
- Click the **Assign Callbacks...** button beneath the Callbacks Summary panel.

This section includes the following topics:

- [Using the Assign Callbacks Window](#)
- [Assigning Numbers of Callbacks](#)
- [Assigning Percentages of Callbacks](#)
- [Assigning All Remaining Callbacks](#)
- [Reassigning All Remaining Callbacks](#)
- [Unassigning Callbacks](#)

Using the Assign Callbacks Window

The Event Info panel at the top of the Assign Callbacks window provides summary information about the event. The Event Callbacks panel provides a current status of callback assignments for the event per user, and allows you to change the number or percentage of assigned callbacks for each user.

Note: When assigning callbacks to multiple users, you can assign a specific number of callbacks for the event to each user, or assign a percentage of the callbacks to each user.

The Assign Callbacks window displays the following fields and buttons:

- The **Event #** field displays the event number for which callbacks are being assigned.
- The **Asset** field displays the name of the asset associated with the event.
- The Lift Station field displays the name of the lift station associated with the event.
- The **Total Callbacks** field displays the total number of callbacks for the event.
- The **% Complete** field displays the percentage of callbacks that are complete for the event.
- The **# Unassigned** field displays the number of callbacks for the event that have not been assigned.
- The **User Name** column contains the user name for each user currently logged in to the system. Other users appear in this column if they are permanently available (for example, a third party agency or IVR system). You can assign callbacks to any user in this column.
- The **Include Priority Calls** column contains a check box that allows you to specify whether you want to include priority calls in the callback assignments for the user. This option is only available to users who have been designated as **Priority Users** (see [Adding a User](#) on page 10-6 for details).
- The **% Assigned** column contains the percentage of the total number of callbacks assigned to the user for the event. You can assign a specific percentage to the user by editing this field and then pressing the **Enter** key. If the percentage does not result in an exact number of callbacks (for example, the callback assignment would be 4.78), the system rounds to the nearest number (in this case, 5).
- The **# Asn** column contains the number of callbacks assigned to the user for the event. You can assign a specific number of callbacks to each user by editing this field and then pressing the **Enter** key.
- The **# Pri** column contains the number of callbacks for priority calls assigned to the user for the event. This column is not editable.
- The **# Rem** column contains the number of callbacks remaining assigned to the user for the event. This column is not editable.
- The **% Comp** column contains the percentage of the total number of callbacks assigned to the user for the event that are complete. This column is not editable.

Buttons

- The **Save** button saves any callback assignment changes and closes the Assign Callbacks window. There is also an option under the Assign Callbacks window's Actions menu for this action.
- The **Unassign** button unassigns the remaining uncompleted callbacks for the event for the selected user and closes the Assign Callbacks window. There is also an option under the Assign Callbacks window's Actions menu for this action.
- The **Assign Remaining** button assigns the remaining unassigned callbacks for the event to the selected user and closes the Assign Callbacks window. There is also an option under the Assign Callbacks window's Actions menu for this action.

- The **Exit** button closes the Assign Callbacks window without saving any changes. There is also an option under the Assign Callbacks window's File menu for this action.

Assigning Callbacks to Users

You can assign callbacks to yourself or to another user that is currently logged into the system, or to an external service if it has been set up in your system. All of the users that have access to the system can assign callbacks to themselves and to others.

Assigning Numbers of Callbacks

When assigning callbacks for an event, you can assign all callbacks to a single user or distribute the callbacks to multiple users. To assign a specific number of callbacks, follow these steps:

1. Select an event with multiple unassigned callbacks from the Web Callbacks main window.
2. Click the **Assign Callbacks** button () on the toolbar.
3. Select the **# Asn** column for a user from the list of users.
4. Type the number of callbacks you want to assign to the user.
5. If the event has additional callbacks, select the column for another user and enter the number of callbacks that you want to assign to that user.
6. Once you have assigned all of the callbacks that you want to assign, click the **Save** button. The Assign Callbacks window closes.

Assigning Percentages of Callbacks

When assigning callbacks for an event, you can assign all callbacks to a single user, or distribute the callbacks to multiple users by percentage. To assign a percentage of callbacks for an event to a user, complete these steps:

1. Select an event with multiple unassigned callbacks from the Web Callbacks main window.
2. Click the **Assign Callbacks** button () on the toolbar. The Assign Callbacks window opens.
3. Select the **% Assigned** column for a user.
4. Type "50" and press **Enter**. This will assign 50% of the callbacks to the selected user.
5. Click the **Save** button. The Assign Callbacks window closes.

Assigning All Remaining Callbacks

To assign all remaining callbacks for an event to a single user, complete these steps:

1. Select an event with multiple unassigned callbacks from the Web Callbacks main window.
2. Click the **Assign Callbacks** button () on the toolbar. The Assign Callbacks window opens.
3. Select the **User Name** column for a user.
4. Click the **Assign Remaining** button. All remaining unassigned callbacks are assigned to the selected user. The Assign Callbacks window closes.

Reassigning All Remaining Callbacks

To reassign all remaining event callbacks for a user to another user, complete these steps:

1. Select the event with assigned callbacks for a user from the Web Callbacks main window.
2. Click the **Assign Callbacks** button () on the toolbar. The Assign Callbacks window opens.
3. Select the **User Name** column for the user with uncompleted assigned callbacks.
4. Click the **Unassign** button. All remaining assigned callbacks for the selected user are now unassigned. The Assign Callbacks window closes.
5. Reopen the Assign Callbacks window using one of the methods above.
6. Select the **User Name** column for the user you wish to perform the remaining callbacks.
7. Click the **Assign Remaining** button. All remaining unassigned callbacks are assigned to the selected user. The Assign Callbacks window closes.

Viewing Callback Assignments

With the View My Callback Lists window, you can view all of the callbacks currently assigned to you. To access the View My Callback Lists window, do any of the following:

- Select the **View My Callback Lists...** option from the **Actions** menu, or
- Click the **View My Callback Lists** button () on the toolbar, or
- Click the **View My Callbacks Lists...** button beneath the Callbacks Summary panel.

This section includes the following topics:

- [View My Callback Lists Window](#)
- [Viewing Your Callback Assignments](#)
- [Canceling Your Callback Assignments](#)

View My Callback Lists Window

The View My Callback Lists window displays the following fields and buttons:

- The **User Name** field displays the user name that you are logged in as.
- The **# of Callback Lists Assigned** field displays the total number of events for which you have callback assignments.
- The **Event #** column contains the event number associated with the callback list.
- The **# Callbacks** column contains the number of callbacks assigned to you for the event.
- The **# Pri** column contains the number of priority calls among your assigned callbacks for the event.
- The **% Comp** column contains the percentage of your assigned callbacks that are complete.
- The **# Rem** column contains the number of callbacks assigned to you for the event that need to be completed.
- The **Restore Date** column contains the date and time the event was restored.
- The **Asset** column contains the name of the asset associated with the event.
- The **Lift Station** column contains the name of the lift station for the asset associated with the event.

Buttons

- The **Unassign All** button unassigns all of your remaining callbacks for all lists. This might be done if you are taking a break and therefore need to make the callbacks available for others to do. There is also an option under the View My Callback Lists window's Actions menu for this action.
- The **Perform Callback List...** button opens the Perform Callback List window for the selected event, which allows you to enter the callback response for each callback assigned to you from that event. There is also an option under the View My Callback Lists window's Actions menu for this action.
- The **Cancel Callbacks** button allows you to cancel all of your remaining callbacks for the selected event and consider them complete.
- The **Exit** button closes the View My Callback Lists window.

Viewing Your Callback Assignments

To view callbacks assigned to you, complete these steps:

1. Click the **View My Callback Lists** button () on the toolbar. The View My Callback Lists window opens, displaying all events with callbacks assigned to you.
2. Click the **Exit** button to exit the View My Callbacks Lists window.

Canceling Your Callback Assignments

To cancel callbacks assigned to you for a specific event, complete these steps:

1. Click the **View My Callback Lists** button () on the toolbar. The View My Callback Lists window opens, displaying all events with callbacks assigned to you.
2. Select the row of the event you wish to cancel your assigned callbacks for.
3. Click the **Cancel Callbacks** button. A confirmation dialog box appears.
4. Click the **Yes** button on the confirmation dialog box. Your assigned callbacks for that event are now considered complete. If there are no more uncompleted callbacks assigned to other users remaining for that event, that event row will disappear from the window. Otherwise, that event row will remain displayed until all callbacks for that event are complete.
5. Click the **Exit** button to exit the View My Callbacks Lists window.

Unassigning Callbacks

You can unassign callbacks that have not been completed. You may unassign callbacks for a single event, or unassign all callbacks assigned to you.

Note: If you exit Web Callbacks, the system automatically unassigns all of your remaining callbacks.

This section includes the following topics:

- [Unassigning Callbacks for a Specific Event](#)
- [Unassigning All of Your Callbacks](#)

Unassigning Callbacks for a Specific Event

To unassign callbacks for a specific event, complete these steps:

1. On the main Web Callbacks window, select the event for which you want to unassign callbacks.
2. Click the **Assign Callbacks** button () on the toolbar. The Assign Callbacks window opens.
3. Select the **User Name** column for the user whose callbacks you wish to unassign.
4. Do one of the following:
 - To unassign all of the user's remaining callbacks for the event, click the **Unassign** button. The Assign Callbacks window closes.
 - To unassign a portion of the user's remaining callbacks for the event, enter a lower number of callbacks in the **# Asn** column for the user, or a lower percentage of callbacks in the **% Assigned** column, then press the **Enter** or **Tab** key. Click the **Save** button. The Assign Callbacks window closes.

Unassigning All of Your Callbacks

To unassign all of your callbacks, complete these steps:

1. Click the **View My Callback Lists** button () on the toolbar. The View My Callback Lists window opens, displaying all events with callbacks assigned to you.
2. Click the **Unassign All** button. A confirmation dialog box appears.
3. Click **Yes** on the confirmation dialog box. The View My Callback Lists window closes.

Performing Callbacks

Once you have assigned callbacks to yourself, or another user has assigned callbacks to you, you can complete those callbacks using the Perform Callback List window. You may also perform callbacks that are unassigned (not currently assigned to any user) using the Perform Next Callback window.

The Perform Callback List window is used to record the results as you are completing your assigned callbacks for an event. The Event Information panel at the top of the window provides summary information about the event. The Event Callbacks Summary panel provides a status of your callback assignments for the event. The callback list table lists customers who have requested a callback for the event, and the Additional Customer Information panel provides more details regarding the customer selected in the callbacks list table.

This section includes the following topics:

- [Accessing the Perform Callback List](#)
- [Using the Perform Next Callback Window](#)
- [Performing Assigned Callbacks for an Event](#)
- [Performing Unassigned Callbacks \(Next Callback\)](#)

Accessing the Perform Callback List

To access the Perform Callback List window:

1. Click the **View My Callback Lists** button () on the toolbar. The View My Callback Lists window opens, displaying all events with callbacks assigned to you.
2. Select a row for an event in the View My Callback Lists table and either:
 - Select the **Perform Callback List...** option from the Actions menu, or
 - Click the **Perform Callback List...** button.

The [Using the Perform Callbacks List Window](#) opens.

Using the Perform Callbacks List Window

The Perform Callbacks List window displays the following information:

- The **Event #** field displays the event number for which callbacks are being performed.
- The **Lift Station** field displays the name of the lift station associated with the event.
- The **Zone** field displays the name of the branch office associated with the event.
- The **Asset** field displays the name of the asset associated with the event.
- The **Start Date** field displays the date and time the event began.
- The **Restore Date** field displays the date and time the event was restored.
- The **Operations Event Note** field displays any comments entered for the event by operations staff.
- The **# Callbacks** field displays the total number of your assigned callbacks for the event.
- The **# Remaining** field displays the number of your callbacks remaining for the event.
- The **% Complete** field displays the percentage of your callbacks that are complete for the event.
- The **Account #** column contains the customer account number.
- The **Name** column contains the name of the customer to be called back.
- The **Telephone** column contains the telephone number on record for the customer.
- The **Callback Phone** column contains the alternate telephone number (for example, cell phone) for the customer, if provided during original call.
- The **Call Before Date** column contains the date and time after which the customer does not wish to be called.
- The **Callback Status** column is a drop-down menu that lets you select the result of the call to the customer. This is the only editable field on the form. See [Callback Status](#) on page C-4 for status colors and descriptions.
- The **Callback Date** column contains the date and time the callback was performed. This column is automatically populated when you change the Callback Status.
- The **Customer Type** column contains an indication of whether the customer is a critical customer (for example, medical or key account).
- The **Priority** check box indicates whether or not the callback is associated with a priority call.
- The **Asset** field in the Additional Customer Information panel displays the name of the selected customer's service asset.
- The **Address** field displays the selected customer's service address.

- The **City** field displays the selected customer's city.
- The **Clues** field displays the trouble code clues received for the customer's call.
- The **Customer Comment** field displays the customer comments entered when the customer called, if any.

Buttons

- The **Save** button saves all callback status changes since the last save. This can be done after each callback (recommended), after every several callbacks, or just before exiting. There is also an option under the Perform Callback List window's File menu for this action.
- The **Cancel Callbacks** button allows you to cancel all of your remaining callbacks for the selected event and consider them complete.
- The **Exit** button closes the Perform Callback List window, returning you to the View My Callback Lists window. There is also an option under the Perform Callback List window's File menu for this action.

Performing Assigned Callbacks for an Event

Once you have been assigned a number of callbacks, you can begin completing them. To perform a callback, complete these steps:

1. Click the **View My Callback Lists** button () on the toolbar. The View My Callback Lists window opens, displaying all events with callbacks assigned to you.
2. Select a row for an event in the View My Callback Lists table and click the **Perform Callback List...** button.

The Perform Callback List window opens displaying the details of the event and information for each customer to be called back.

3. Select a row for the callback you want to perform. At this time, you would physically make the call to the customer. Use the Callback Phone number if it exists. Otherwise use the number listed in the Telephone column.
4. Once the call is complete, change the Callback Status based on the result (for example, restored).
5. Click the **Save** button.
6. Make any remaining callbacks and change the Callback Status accordingly. Make sure that you click the **Save** button before exiting if you aren't saving after each call.
7. Click the **Exit** button when you have completed all of the callbacks.

Performing Unassigned Callbacks (Next Callback)

You can perform callbacks that are not assigned to any user using the Perform Next Callback window. This window allows you to select events from the main window and perform callbacks that have not yet been assigned to a user. The Perform Next Callback window displays the same information as the Perform Callback List window, just in a different order.

The callback that displays is automatically assigned to you so it cannot be assigned to anyone else. If you save a Callback Status of anything other than "Restored," "Not Restored," or "Cancel," the callback is not considered complete and remains assigned to you. If you do not save a Callback Status, the callback will be unassigned when you exit the Perform Next Callback window. You can also continue to process unassigned callbacks for this event by clicking the **Next Callback** button.

This section includes the following topics:

- [Using the Perform Next Callback Window](#)

- [Performing the Next Unassigned Callback for an Event](#)

Using the Perform Next Callback Window

To access the Perform Next Callback window, select an event in the main Web Callbacks window that has unassigned callbacks remaining, and then do one of the following:

- Click the **Perform Next Callback** button () on the toolbar, or
- Select the **Perform Next Callback...** option from the Actions menu, or
- Click **Perform Next Callback...** button beneath the Callbacks Summary panel.

The Perform Next Callback Window displays the following fields and buttons:

- The **Event #** field displays the event number for which callbacks are being performed.
- The **Lift Station** field displays the name of the lift station associated with the event.
- The **Zone** field displays the name of the branch office associated with the event.
- The **Asset** field displays the name of the asset associated with the event.
- The **Start Date** field displays the date and time the event began.
- The **Restore Date** field displays the date and time the event was restored.
- The **Operations Event Note** field displays any comments entered for the event by operations staff.
- The **# Callbacks** field displays the total number of callbacks for the event.
- The **# Remaining** field displays the number of callbacks remaining for the event.
- The **% Complete** field displays the percentage of callbacks that are complete for the event.
- The **Account #** field displays the selected customer's account number.
- The **Name** field displays the name of the customer to be called back.
- The **Address** field displays the selected customer's service address.
- The **City** field displays the selected customer's city.
- The **Customer Type** field displays an indication of whether the customer is a critical customer (for example, medical or key account).
- The **Asset** field in the Customer Information panel displays the name of the selected customer's service asset.
- The **Clues** field displays the trouble code clues received for the customer's call.
- The **Customer Comment** field displays the customer comments entered when the customer called, if any.
- The **Priority** check box indicates whether or not the callback is associated with a priority call.
- The **Telephone** field displays the telephone number on record for the customer.
- The **Callback Phone** field displays the alternate telephone number (for example, cell phone) for the customer, if provided during original call.
- The **Callback Status** column is a drop-down menu that lets you select the result of the call to the customer. See [Callback Status](#) on page C-4 for status colors and descriptions.
- The **Callback Date** column contains the date and time the callback was performed. This column is automatically populated when you change the Callback Status.

Buttons

- The **Next Callback** button populates the Perform Next Callback window with the next unassigned callback for this event, if any, and assigns the callback to you. There is also an option under the Perform Next Callback window's **Actions** menu for this action.
- The **Save** button saves the result for this callback and enables the Next Callback button. There is also an option under the Perform Next Callback window's **File** menu for this action.
- The **Exit** button closes the Perform Next Callback window. There is also an option under the Perform Next Callback window's File menu for this action.

Performing the Next Unassigned Callback for an Event

To perform the next unassigned callback for an event, complete these steps:

1. On the Web Callbacks main window, select an event that has unassigned callbacks remaining (# Asn column less than # Rem column).
2. Click the **Perform Next Callback** button () on the toolbar. If all callbacks for the selected event have been assigned, an error dialog box displays.
3. Place the phone call to the customer, using the phone number listed in the Callback Phone field, if provided. Otherwise, use the number in the Telephone field.
4. When the call is complete, select the appropriate option from the Callback Status drop-down menu.
5. Click the **Save** button.
6. If there are unassigned callbacks remaining for the event and you want to perform them, click the **Next Callback** button and repeat the three previous steps.
7. Click the **Exit** button to close the Perform Next Callback window.

Note: The callback accessed from the Perform Next Callback window is assigned to you when the window opens to prevent another user from being assigned to it as well. If you save a result for the callback that does not actually complete it (for example, Busy, No Answer) and then exit the Perform Next Callback window, it will remain assigned to you. If you exit the Perform Next Callback window without saving a result for the callback, the callback returns to being unassigned.

Chapter 5

Storm Management

This chapter describes the Oracle Utilities Network Management System Storm Management application. It includes the following topics:

- [Getting Started with Storm Management](#)
- [Storm Management Full Operations Environment](#)
- [Storm Management Information Overview](#)
- [Storm Management View Only Environment](#)
- [Storm Management Storm Administration Environment](#)

Getting Started with Storm Management

Storm Management enables you to manipulate the event and crew information that the system will use to make its calculations. This section describes the login, menus, toolbar, and status bar, and other common sections of Storm Management.

Note: Many utilities have different rules sets configured for storms versus normal conditions, which will affect the operation of Storm Management. Changing rule sets is done using the **Change Rule Set...** button on the **Web Workspace Authority** tool. For information on changing rule sets, see [Changing Rule Sets](#) on page 2-54.

Login Window

The Login window is the first Storm Management window you see. You must enter a valid user name and password, and then click the **Validate** button. Once your user name and password are validated, the system populates the option menu that allows you to select a user type. You will see different initial windows and options depending upon the user type specified.

The Login window displays the following fields and buttons:

- The **User ID** field allows you to enter the user name provided to you by the system administrator.
- The **Password** field allows you to enter the password provided to you by the system administrator.
- The **Validate** button verifies your login credentials. If the user name and password are not entered correctly, the system displays a warning dialog box.
- The **User Type** drop-down menu contains the list of user types within your authority.

- **Full Operations:** provides Storm Management functionality for the operations user to edit storm, system, and crew criteria. See [Storm Management Full Operations Environment](#) on page 5-3 for details of the Full Operations environment
- **View Only:** displays the information available to the Full Operations environment in a read-only mode. See [Storm Management View Only Environment](#) on page 5-37 for details.
- **Storm Administration:** provides a post-storm data maintenance environment. See [Storm Management Storm Administration Environment](#) on page 5-39 for details.
- The **Login** button allows you to complete the login process. Once you click the Login button, the appropriate Storm Management window opens, based upon the User Type selected.
- The **Quit** button exits the Login window.

Logging In

To login to Storm Management, complete these steps:

1. Depending on how your system was installed, do one of the following:
 - Click the **Storm Management** icon found under the appropriate program group in your Windows Start Menu, or
 - Double click the **Storm Management** icon on your desktop, or
 - Open a web browser and type the Storm Management URL in the browser's Address field. The Storm Management Login window displays.
2. Enter your user name.
3. Enter your password.
4. Click the **Validate** button. The bottom portion of the Storm Management Login window sensitizes.
5. Select the appropriate **User Type** from the drop-down menu.
6. Click the **Login** button. The appropriate Storm Management window opens.
7. Click the **Login** button to finish logging in.

Storm Management Full Operations Environment

This section describes the Storm Management window and general functionality. It includes the following topics:

- [User Interface Features](#)
 - [Menus](#)
 - [Status Bar](#)
 - [Storm Management Information Panels](#)

User Interface Features





Menus



There are four menus on the Storm Management menu bar:

- [System Menu](#)
- [Storm Menu](#)
- [User Menu](#)
- [Help Menu](#)

System Menu





The options in the System menu are available in both storm and non-storm modes. The following table describes the System Menu options and associated toolbar icons.

| Menu Option | Description | Toolbar Icon |
|-----------------------------|--|---|
| Toggle Storm Mode... | Used to transition a control zone between the Storm Management non-storm and storm modes of operation. Opens the Define Storm dialog box, prompting you to enter the information required to transition between modes. This option is not available in study mode. |  |
| Save Changes | Saves any changes made in the window outside of the Crew Information table. |  |
| ERT Override... | While periodically simulating the restoration process, Storm Management makes an estimated assessment and calculates an <i>Estimated Restoration Time</i> (ERT) for each eligible event. The estimates are accessible to other NMS modules. This option opens the ERT Override dialog box, which allows the accessibility of the Storm Management estimates to other modules to be turned on and off at any control zone level, and also allows for an alternate global or <i>tiered</i> estimate to be applied at any control zone level instead. The ERT Delays tab allows the user to adjust calculated ERT values, for any control zone, with a delay factor. |  |
| Force Simulation Run | Immediately invokes the simulation of the entire restoration process, recalculating the estimates. This option is typically only used in study mode. |  |

| Menu Option | Description | Toolbar Icon |
|------------------------|---|---|
| Retrieve Update | Refreshes the window with the most recent information from the system. In most cases, the window refreshes itself on a periodic basis. But, if there are unsaved changes in the Storm Management window at the time the automatic refresh is due to occur, the window will not refresh. Instead, an alert appears in the status bar indicating that an update is available, and the Retrieve Update option must be invoked in order to refresh the window with the new update. This allows you to continue making your changes and save them first before refreshing. |  |
| Print All... | Opens the Print Preview dialog box, which allows you to print the Summary Information panel, Storm Report panel, Storm Information panel (if present), Crew Information panel (if present), and status bar information from the current Storm Management window. See Printing on page 1-20 for details on printing and using the Print Preview window. |  |
| Print Crews... | Opens the Print Preview dialog box, which allows you to print out the Crew Information panel from the current Storm Management window. This option is only available in storm mode. |  |

Storm Menu

The options in the Storm menu are only enabled when Storm Management is in storm mode. The following table describes the Storm Menu and associated toolbar options.

| Menu Option | Description | Toolbar Icon |
|-----------------------------|--|---|
| Toggle Study Mode | Toggles the Storm Management window between real-time and study modes of operation. The current mode is displayed in the status bar. |  |
| Export Study Session | When in study mode, allows you to export the current study session crews and parameters to the real-time session. |  |
| Reset Study Session | When in study mode, allows you to reset the current study session with the current real-time session crews and parameters. |  |
| Forecast Profiles... | Opens the Forecast Profiles dialog box, which is used to save and pre-load outage forecasting parameters. This option is only available in storm mode at the simulation level. |  |
| Calculate Crews... | Opens the Calculate Crews dialog box, which is used to determine the approximate number of crews needed to complete assessment and repair by a specified date and time. |  |

User Menu

The User Menu provides options to set preferences and log out of Storm Management

Preferences Menu

The **Preferences** menu allows you to control certain common features of the Storm Management.

| Menu Option | Description |
|-------------------------------|---|
| Smaller Font | Decreases the font size in text and icons. Repeat to further decrease the font size. |
| Bigger Font | Increases the font size in text and icons. Repeat to further increase the font size. |
| Reset Font | The application will reset the text and icons to use their default font size. |
| Save Preferences | Saves the current settings as the user's preference. See Saving Workspace Preferences on page 1-12 for details. |
| Restore Preferences | Restores the environment preferences to the default settings. See Restoring Default Preferences on page 1-12 for information. |
| Change Color Scheme... | Opens the Change Color Scheme dialog box, which allows you to select from different user interface coloring schemes. The options are a Light scheme, a Dark scheme, and the default High Definition scheme. Unlike other user preferences, these apply to all environments for the user on the machine. |

Help Menu

The options in the Help menu are available at all times. The following table describes the Help Menu options.

| Option | Description |
|-------------------------------|---|
| Storm Management Help | Opens the Online Help content for Storm Management. |
| Email Log Files... | Gathers the environment's log files and attaches them to a new email message using your default email client. The log files can then be sent to your support team or contact for further analysis. |
| Set Debug... | Launches the Set Debug dialog box allowing you to set debug on or off within your current environment. This is used for debugging and analysis purposes. See Setting Debug on page 10-33 for more information. |
| About Storm Management | Opens a dialog box that displays information regarding what version of the application is presently running, as well as version and other information about the Oracle Utilities Network Management System Web Gateway that the application is using. |

Status Bar

The status bar appears at the bottom of the Storm Management window, providing operating details for the system. The status bar displays the following fields:

- The **Last Update** field displays a time stamp indicating the date and time at which the most recent estimates were calculated.
- The **Update** field is an indicator that changes from *"No Update"* to *"Available Update"* (with a highlighted background) when there are unsaved changes at the time the automatic refresh of the Storm Management window is due to occur. The refresh does not occur until you click the Retrieve Update button on the toolbar or select the Retrieve Update option from the System menu.
- The **Real-Time/Study Mode** field displays *"Study Mode"* when the currently selected control zone is in the Storm Management study mode of operation and *"Real-Time Mode"* with a highlighted background when the zone is in real-time mode.
- The **Storm/Non-Storm Mode** field displays "Non-Storm Mode" when the currently selected control zone is in the Storm Management non-storm mode of operation and "Storm Mode" with a highlighted background when the currently selected zone is in the Storm Management storm mode of operation.
- The **ERT Override** field indicates whether any control zone in the system presently has its Storm Management estimates accessible to other modules (for example, may be displayed in an Oracle Utilities Network Management System **Work Agenda** column and available in Oracle Utilities Network Management System **Web Call Entry**) or overridden by an alternate estimate. If they are not accessible, or if they are overridden, this field displays *"ERT Override: On"* with a highlighted background. If not, this field displays *"ERT Override: Off."*
- The **ERT Delay** field indicates if any ERT Delays are active. If there is an active ERT Delay, the field displays *"ERT Delay: On"* with a highlighted background. If not, the field displays the *"ERT Delay: Off."*
- The **Lookups** field indicated the historical lookup value Shift, Season, and Day Type attributes that apply to the current time.

Storm Management Information Panels

The Storm Management **Full Operations** environment is divided into panels that contain information in labeled and bordered panes. A pane may be visible or hidden based on whether Storm Management is in Non-Storm or Storm Mode.

| Pane Name | Description | Displayed in Modes |
|---------------------|---|--------------------|
| Zone Selection | The Zone Selection pane provides the Control Zone hierarchy in a tree view. An individual Control Zone may be selected for a given storm or to drill down to get information about that zone when the storm applies to a higher level zone. See Zone Selection on page 5-10 for details. | Non-Storm, Storm |
| Storm Information | The Storm Information pane displays data entered when defining the storm. See Storm Information on page 5-7 for details. | Storm |
| Summary Information | The Summary Information pane provides an overview of the estimates for both the selected zone and the Company level zone. See Summary Information on page 5-9 for details. | Non-Storm, Storm |

| Pane Name | Description | Displayed in Modes |
|------------------|--|--------------------|
| Storm Report | The Storm Report pane provides an overview of the historical averages, actual averages, and estimates for each outage type in the currently selected control zone. See Storm Report on page 5-8 for details. | Non-Storm, Storm |
| Crew Information | The Crew Information pane lists crew information for the currently selected control zone and its children. Crews are grouped by skill/type and by control zone. | Storm |

Storm Management Information Overview

This section describes the Storm Management operating modes and related information displays:

- [Storm Management Modes](#)
- [Storm Information](#)
- [Summary Information](#)
- [Storm Report](#)
- [Zone Selection](#)

Storm Management Modes

Storm Management has two major modes of operation: *Non-storm* and *Storm*.

Non-Storm Mode

Non-storm mode applies to everyday operations. When calculating estimates, crew resources are not taken into account because it is assumed there are enough crews available to handle all events. All control zone views operate in non-storm mode until explicitly placed into storm mode.

Storm Mode

Storm mode is useful during and after a storm or other high volume outage period. In Storm mode, the estimate calculations factor in crew availability.

Study Mode

Study mode, which is an option when in Storm Mode, enables you to manipulate parameters that affect the estimate calculations, such as outage forecasting, manual overrides, and crew information without altering the current real-time calculations. Also, once in study mode, the user can export parameters from the study session back into the real-time session. Study mode is only valid while the storm is active. If another user ends the storm while you are in study mode, you will see a message that the zone is no longer in storm mode.

Storm Information

The Storm Information panel displays information about a defined storm (see [Using Define Storm Dialog](#) on page 5-17).

The Storm Information Panel displays the following fields:

- The **Storm Name** field displays the name of the storm. This field is not editable and is populated by information entered into the Storm Name field of the Define Storm dialog box.

- The **Storm Start** field displays the starting date of the storm. This field is not editable and is populated by information entered into the Start Date field of the Define Storm dialog box.
- **Storm Level** is a drop-down menu of severity levels of the storm. It is initially populated by the option selected on the Storm Level drop-down menu of the Define Storm dialog box. If you modify the Storm Level for a control zone that has child zones as part of the same storm, the Storm Level for all of those child zones will be changed to the modified value as well.
- **Special Condition** is a drop-down menu of special storm types. It is initially populated by the option selected on the Special Condition drop-down menu of the Define Storm dialog box. If you modify the Special Condition for a control zone that has child zones as part of the same storm, the Special Condition for all of those child zones will be changed to the modified value as well.

Storm Report

The Storm Report is the main Storm Management pane. It provides an overview of the historical averages, actual averages, and estimates for each outage type in the currently selected control zone. Each time you select a different control zone from the Zone Selection tree, the Storm Report Panel refreshes to display the information for the newly selected zone.

The Storm Report pane displays the following columns:

- The **Outage Types** column contains the name of the Storm Management outage type category.
- The **Actual Outages** column contains the actual number of unrestored events of the corresponding outage type in the currently selected control zone.
- The **Total Outages** column contains the total number of forecasted outages of the corresponding outage type in the currently selected control zone. If the currently selected control zone is operating storm mode, this value may be assigned or calculated as a percentage of the Actual Outages column using the Storm Management outage forecasting functionality. If the currently selected control zone is operating in non-storm mode, the value of this column is equal to the value of the Actual Outages column, because the outage forecasting functionality is not available in non-storm mode.
- The **Travel to Assess** column contains the average number of minutes between dispatch of an assessment crew and the arrival of that crew on the job site. The number outside of the parentheses is the historical average used in the Storm Management estimate calculations. The number in parentheses is the actual average that has been occurring in the field over the past 2 hours.
- The **Assess** column contains the average number of minutes taken to assess the effort needed to restore/repair the event. The number outside of the parentheses is the historical average used in the Storm Management estimate calculations. The number in parentheses is the actual average that has been occurring out in the field over the past 2 hours.
- The **Travel to Repair** column contains the average number of minutes between dispatch of the repair crew and the arrival of that crew on the job site. The number outside of the parentheses is the historical average used in the Storm Management estimate calculations. The number in parentheses is the actual average that has been occurring out in the field over the past 2 hours.
- The **Repair** column contains the average number of minutes taken to restore/repair the event. The number outside of the parentheses is the historical average used in the Storm Management estimate calculations. The number in parentheses is the actual average that has been occurring out in the field over the past 2 hours.
- The **Clean** column contains the average number of minutes taken to by the repair crew to clean up after the event is restored before going to the next job. The number outside of the parentheses is the historical average used in the Storm Management estimate calculations.

The number in parentheses is the actual average that has been occurring out in the field over the past 2 hours.

- The **Total Time to Assess hrs:min** column contains the raw amount of time required to assess all outages of the corresponding outage type in the currently selected control zone, in hours and minutes. The very basic formula for calculating this value is the following: (Travel to Assess + Assess) * number of Actual Outages. However, if any outage forecasting or manual overrides are currently applied, or if the simulation has any of the outages projected to be assessed at a time that would use a different Travel to Assess or Assess time other than what's currently displayed in the Storm Management window, then that basic formula no longer holds.
- The **Estimated Assessed By** column contains the estimated date and time at which the last of all outages with the corresponding outage type in the currently selected control zone will be assessed.
- The **Total Time to Restore hrs:min** column contains the raw amount of time required to repair all events of the corresponding outage type in the currently selected control zone, in hours and minutes. The very basic formula for calculating this value is the following: (Travel to Repair + Repair) * number of Actual Outages in non-storm mode, or (Travel to Repair + Repair + Clean) * number of Actual Outages in storm mode. However, if any outage forecasting or manual overrides are currently applied, or if the simulation has any of the outages projected to be repaired at a time that would use a different Travel to Repair or Repair or Clean time other than what's currently displayed in the Storm Management window, then that basic formula no longer holds.
- The **Estimated Restored By** column contains the estimated date and time at which the last of all outages with the corresponding outage type in the currently selected control zone will be restored.
- The **Forecast Mode** drop-down menu enables you to select what kind of outage forecasting you want to apply. This field is only enabled when the currently selected control zone is one at the simulation level operating under storm mode. List options include:
 - **% Change** - Allows the % Change cell beneath the Actual Outages column to become editable, enabling you enter a percentage greater than 100. This increases the value in the Total Outages column for each outage type by that percentage.
 - **Value** - Allows the Total Outages cell for each outage type row to become editable. It also disables the % Change cell under the Actual Outages column.

Summary Information

The Storm Management Summary Information panel provides an overview of the estimates for both the selected zone and the Company level zone. Each time you select a different control zone from the Zone Selection tree, the Summary Information Panel refreshes to display the information for the newly selected zone. (If you select the Company level zone, the Summary Information table contains only the one row of Company information.)

The Summary Information Panel displays the following fields:

- The **Zone** column contains the name of the Company level zone and the currently selected zone.
- The **Est Assessed By** column contains the estimated date and time when all assessment within the control zone will be complete.
- The **Est Restored By** column contains the estimated date and time when all events within the control zone will be restored.
- The **ERT Override** field displays the alternate estimated restoration time, if a published or non-published control-zone wide alternate estimate is currently being applied to the selected zone. See [ERT Override Dialog Box](#) on page 5-10 for more information.

Zone Selection

The Zone Selection panel is available in both Non-Storm and Storm modes. Storm Management information is displayed on a per control zone basis, supporting views for the top three levels of the control zone hierarchy in the operations model. The top-level (usually the "Company" level) control zone view displays when Storm Management starts up.

Selecting the Control Zone to View

You can view the information for another control zone by selecting that zone in the Zone Selection tree. The data displayed applies to the selected zone and all of its children. However, some components may be disabled if the currently selected control zone is not at the simulation level.

Using Storm Management

Storm Management supports two operational modes: Non-storm Mode and Storm Mode. Non-storm mode applies to everyday operations. When calculating estimates, crew resources are not taken into account because it is assumed there are enough crews available to handle all events. Storm mode is useful during and after a storm or other high volume outage periods. In this mode, the estimate calculations factor in crew availability. All control zone views operate in non-storm mode until explicitly placed into storm mode.

Using ERT Overrides

While it is periodically simulating the entire restoration process, Storm Management calculates an estimated assessment and restoration time for each eligible event. These estimates for each event are accessible to other modules (for example, may be displayed in a Work Agenda column). However, it is not always prudent to have these estimates available to the other modules; for example, when you initially enter storm mode and the available crew resources have not been fully defined, the calculated estimates would be rather inaccurate.

ERT Overrides provides the ability to override calculated ERTs for one or more specified control zones. The ERT overrides will impact existing outages as well as future outages in those control zones until the override is removed. Either a new specific ERT can be specified using the ERT Override tab, or an ERT offset from the outage start time can be specified using the ERT Delay tab. Both tabs also support tiering, which provides more granular override values based on the number of customers impacted by an event.

Note: The ERT overrides will not affect the ERT of existing outages with an ERT source of 'C', meaning it was input by a crew or operator as opposed to calculated by the system.

ERT Override Dialog Box

To open the ERT Override dialog box, do one of the following:

- Select the **ERT Override...** option from the System menu, or
- Click the **ERT Override** button on the toolbar.

The ERT Override window opens with the ERT Override tab displayed. The ERT Delay functionality is accessed via the ERT Delay tab. Both window tabs offer consistent actions via the buttons at the bottom of the window.

ERT Override Tab Fields

- The **Zone** column contains the control zone that is having its Storm Management calculated estimates made inaccessible or overridden. With a row selected, click in the Zone field to activate the Control Zone Selection button () , which opens the Control Zone Selection dialog box. Select the desired Control Zone and click **OK**.

- The **Tier** column contains the optional tier criteria for using a given ERT Override value. See the **Add Tier** button description below to learn how to add tiers. Note that if tiers are used, the ERT Override field on the Summary Information panel will not display a value (since there will likely be more than one), but rather just display "Published" or "Non-Published."
- The **ERT Override** column contains the estimated restoration date and time for all events within the control zone to be displayed outside of Storm Management. Once you click in the ERT Override column, a button displays. This button opens a calendar that enables you select a date and time. The date/time you enter must be in the future. This field may be left blank.
- The **Publish Projections** column contains a check box that indicates whether or not the ERT Override value is published to other modules for the affected events.
- The **User** column displays the id of the user who provided the ERT override/delay value.

ERT Delay Tab

The ERT Delay tab exchanges the ERT Override column for a Delay column; all other columns function exactly the same as described in the ERT Override tab overview including the ability to add tiers to the delay.

- The ERT Delay column contains the delay to be added to the start time of outages to calculate the ERT, rather than using the normally calculated ERT. Once you click in the ERT Delay column, a mask for hours and minutes is displayed (that is, ##:##). Enter a delay value in hours and minutes to set the delay value. The ERT Delay will be activated once the OK button is clicked.

Example - Using the Mask

If you want to set the ERTs to be four hours and 30 minutes from the outage start times, enter 0430; the mask will show 04:30.

ERT Override Buttons

- The **Add** button adds a new row to the table in the ERT Override dialog box. That row may then be edited to contain the desired control zone, ERT Tier (using the **Add Tier** button), ERT Override date/time, and publish values. If a row marked for removal is selected, pressing the Add button will undo the removal mark. New, unsaved rows display in the table as green. Edited, unsaved rows display in the table as cyan.
- The **Add Tier** button adds a tier to a *selected* row. The Tier column will be populated with a context menu that defaults to the first tier criteria. Clicking the menu will display all of the tiers configured in the system. If multiple tiers are configured with overlapping numbers of customers impacted, the first tier (T1) values will take precedence over the second (T2) and third (T3) tiers; likewise, T2 will take precedence over T3.

The product configuration has three tiers each with five values:

- Tier 1
 - T1 1-5 customers
 - T1 6-25 customers
 - T1 26-100 customers
 - T1 101-250 customers
 - T1 >250 customers
- Tier 2
 - T2 1-10 customers
 - T2 11-100 customers
 - T2 101-250 customers
 - T2 251-500 customers
 - T2 >500 customers
- Tier 3
 - T3 1-50 customers
 - T3 51-250 customers
 - T3 251-500 customers
 - T3 501-750 customers
 - T3 >750 customers
- The **Remove** button highlights the selected row (in red) to indicate that it has been marked for removal from the table in the ERT Override dialog box. Rows are not removed until the **OK** button has been clicked.
- The **OK** button applies any actions taken, with the following exceptions:
 - If the ERT Override table contains more than one row for the same zone, an error dialog box will appear and no changes will be saved. I
 - If another user enters an ERT override while you have the dialog box open, the system will block the update and display an ERT override conflict message that tells you to refresh the data to see the latest values. Once the data has been refreshed, using the Refresh button, you may then modify the ERT override, if still applicable.
- The **Print...** button brings up the Print Preview dialog box, which allows you to print out the contents of the ERT Override dialog box.
- The **Cancel** button closes the dialog box without saving changes, and leaves the accessibility/overrides of the Storm Management estimates as they were.
- The **Refresh** button repopulates the ERT Override dialog box with the latest information from the server.

Note: Applying overrides to the Storm Management estimates has no effect on events that have a crew onsite or events that have had an ERT manually entered in Oracle Utilities Network Management System. Those events will retain the display of their present manually entered/Storm Management ERT.

The following table describes what occurs when different combinations of ERT Override column and Publish Projections column values are applied.

| If... | Then... |
|---|---|
| The Publish Projections check box is checked and you enter a date and time in the ERT Override column for that row... | All events in that control zone will receive that date and time as their default ERT value outside of Storm Management: The ERT Override value displays in the ERT Override field of the Summary Information table along with the word "Published". The ERT Override value displays for current outages in that control zone in other modules. New outages in that control zone receive the ERT Override value until you turn the override of the Storm Management estimates off. |
| The Publish Projections check box is checked and you did not enter a date and time in the ERT Override column for that row... | Publishing an empty ERT Override value is not a supported operation. Such entries will not be saved. The correct way to hide ERT values is to uncheck Publish Projections check box. |
| If the Publish Projections check box is not checked and a date and time are entered in the ERT Override column for that row... | All events in that control zone will receive a blank value as their default ERT value outside of Storm Management, regardless of whether or not a date and time is entered in the ERT Override column for that row; current and new events display a blank ERT value in other modules until you turn the override of the Storm Management estimates off: The ERT Override value displays in the ERT Override field of the Summary Information table along with the word "Non-Published". |
| If the Publish Projections check box is not checked and a date and time are not provided in the ERT Override column for that row... | All events in that control zone will receive a blank value as their default ERT value outside of Storm Management, regardless of whether or not a date and time is entered in the ERT Override column for that row; current and new events display a blank ERT value in other modules until you turn the override of the Storm Management estimates off: The ERT Override field in the Summary Information panel contains the word "Non-Published". |

Turning Off Accessibility of the Estimates

To turn the accessibility of the estimates off, complete these steps:

1. Do one of the following:
 - Click the **ERT Override** button on the toolbar, or
 - Select the ERT Override option from the System menu. The ERT Override dialog box opens.
2. Click the **Add** button to add a new row to the ERT Override table.
3. Click into the Zone cell of the new row, and then click the button on the right of the Zone field.
 - The Control Zone Selection dialog box opens.
4. Select the control zone whose estimates you wish to make inaccessible.
5. Click **OK**.
 - The Control Zone Selection dialog box closes.
 - The zone you selected populates the Zone field.
6. Uncheck the Publish Projections check box.
7. Click **OK**. Storm Management's calculated estimates for that control zone are no longer accessible to other Oracle Utilities Network Management System windows and the ERT Override dialog box closes.

Overriding the Estimates

To override the estimates to a default "global" ERT for the events in a zone, complete these steps:

1. Do one of the following:
 - Click the **ERT Override** button on the toolbar, or
 - Select the **ERT Override...** option from the System menu. The ERT Override dialog box opens.
2. Press the **Add** button to add a new row to the ERT Override table.
3. Click into the Zone cell of the new row, and then click the button on the right of the Zone field.
 - The Control Zone Selection dialog box opens.
4. Select the control zone whose estimates you wish to make inaccessible and click **OK**.
 - The Control Zone Selection dialog box closes.
 - The zone you selected populates the Zone field.
5. Click into the ERT Override cell of the new row, and then click on the Calendar button.
6. Select a date and time for the new default ERT. Click **OK** on the Calendar dialog box to close it.
7. Click out of the ERT Override cell and into a different cell to ensure the ERT Override time is saved.
8. Make sure the Publish Projections check box is checked.
9. Click **OK**. Storm Management's calculated estimates for that control zone are no longer displayed to other modules; the provided ERT Override value is displayed instead. The ERT Override dialog box closes.

Changing Publish/Non-Publish or Default ERT Information

If you have the accessibility of the Storm Management estimates turned off, you can revise the default ERT, or you can change from publishing the default ERT to not publishing it or vice versa, without having to first turn the accessibility back on. To do this, complete these steps:

1. Do one of the following:
 - Click the **ERT Override** button on the toolbar, or
 - Select **ERT Override...** option from the System menu. The ERT Override dialog box opens.
2. If you want to update the ERT Override for a zone, click into the ERT Override cell of the applicable row, click on the Calendar button.
3. Select a date and time, then click **OK**.
4. Click out of the ERT Override cell and into a different cell to ensure the ERT Override time is saved.
5. Check or uncheck the Publish Projections check box for the applicable row.
6. Click **OK**. The following occurs:
 - The ERT Override dialog box closes.
 - The default ERT is published and/or revised if the Publish Projections check box was checked, or
 - The default ERT is not published if the Publish Projections check box was not checked.

Turning Accessibility of Projections Back On/Removing Overrides

To turn the accessibility of the Storm Management estimates back on and/or remove ERT Overrides, complete these steps:

1. Do one of the following:
 - Click the **ERT Override** button on the toolbar, or
 - Select the **ERT Override...** option from the System menu. The ERT Override dialog box opens.
2. Select the row that corresponds to the zone for which you want to turn the accessibility of estimates back on/remove the applied ERT Override.
3. Press the **Esc** key.
4. Click **Remove**.
5. Repeat previous steps as needed.
6. Click **OK**. The following occurs:
 - All eligible events immediately receive the most recently calculated Storm Management estimates.
 - If all rows have been removed from the ERT Override table, the status bar indicates ERT Override is off.

Printing ERT Overrides

To print the contents of the ERT Override dialog box, complete these steps:

1. Do one of the following:
 - Click the **ERT Override** button on the toolbar, or
 - Select the **ERT Override...** option from the System menu. The ERT Override dialog box opens.
2. Click the **Print...** button. The Print Preview dialog box opens.
3. Adjust the scale, orientation, and page setup as desired.
4. Click the **Print** button on the toolbar to print the pages. The Print Preview dialog box disappears and the print output appears at your selected printer.

Manual Overrides

It may occur that the actual averages are significantly different from the historical averages. The % Change row of the Storm Report lets you temporarily manually override each category of the historical averages. The percentage you enter changes the lookup values used in the calculation of the estimates. This functionality is only available when the currently selected control zone is at the simulation level.

Overriding Historical Averages

To override the historical averages, complete these steps:

1. Make sure the currently selected control zone is at the simulation level.
2. Click in the cell of the % Change row for the column of the corresponding historical average category you want to change.
3. Revise the percentage in the cell to the value you want to use.
4. Click **Enter**.
5. Click the **Save** button on the toolbar or select Save from the System menu. The historical averages in the column immediately update to reflect the change.

Storm Management will use the modified values when recalculating estimates during the next scheduled simulation iteration. The modified values stay in place until you manually change the % Change row back to 100% or, if applied during storm mode, you exit storm mode. The historical averages are not changed in the database.

Using Storm Mode

Storm mode is useful during and after a storm or other high volume outage period. In this mode, the estimate calculations factor in crew availability.

Once a crew arrives onsite at an event, the Storm Management estimate calculation will then use the actual crew arrival time rather than the projected arrival time. The estimate calculation can adjust again when a crew reports an estimated repair time based upon observed field conditions.

This section includes the following topics:

- [Entering Storm Mode](#)
- [Using Define Storm Dialog](#)
- [Placing a Control Zone in Storm Mode and Defining the Storm Information](#)
- [Joining Existing Storms](#)
- [Joining a Control Zone to an Existing Storm](#)
- [Changing Storm Levels](#)
- [Changing Storm Types](#)
- [Forecasting Outages](#)
- [Using Forecast Profiles](#)
- [Working with Crew Information](#)
- [Using Study Mode](#)
- [Exiting Storm Mode](#)

Entering Storm Mode

To enter storm mode for a control zone, complete these steps:

1. Do one of the following:
 - Select **Toggle Storm Mode** from the System menu, or
 - Click the **Toggle Storm Mode** button on the toolbar.

The Define Storm dialog box opens. Enter the storm data.

2. Click the **Ok** button.

Note: You can only enter storm mode from real-time mode. Once in storm mode, you can switch to study mode.

Using Define Storm Dialog

The Define Storm dialog box opens once you toggle to storm mode. You must enter information about the storm before Storm Management will change modes. The information you provide here is used to populate parts of the Storm Information section of the window.

The Define Storm dialog box displays the following fields and buttons:

- The **Zone** field displays the Name of the currently selected zone. This control zone and all of its children that aren't already in storm mode will be placed into storm mode as a part of this storm. This field is not editable.
- The **Storm Name** field allows you to enter the name of the storm. This value is used in conjunction with the current date as the unique identifier of the storm. If this field is not populated when you click the **OK** button, an error appears. Click **OK** to close the message and correct the error.

- **Special Condition** is a drop-down menu of storm types that indicate a predefined condition existing with the storm. This condition may also dictate a different set of historical average values be used in the estimate calculations made by the system.
- **Storm Level** is a drop-down menu of severity levels for the storm. This value is recorded for information and reporting purposes only and has no effect on the estimate calculations.
- **Start Date** is the date and time at which the storm started. When you uncheck the "Use current time" option, the button on the right of this field opens a calendar that enables you to select the date and time. Valid dates and times are those prior to (and including) the current time. If your entry is invalid, an error message appears. Click **OK** to close the message and correct the error.
- The **Use Current Time** check box is selected by default. This option allows you to leave the Start Date field blank and have the current system time on the server be used as the Start Date of the storm. Deselecting this option enables the calendar button to the right of the Start Date field.
- The **Ok** button saves the entered storm information and closes the dialog box. Storm Management is now operating in storm mode for the corresponding control zones.
- The **Cancel** button discards the entered storm information and closes the dialog box without switching the currently selected control zone into storm mode.

Placing a Control Zone in Storm Mode and Defining the Storm Information

To place a control zone in storm mode and define the storm information, complete these steps:

1. Make sure the desired control zone is selected in the Zone Selection panel, and that the zone is in non-storm mode.
2. Do one of the following:
 - Select the Toggle Storm Mode option from the System menu, or
 - Click the **Toggle Storm Mode** button on the toolbar. The Define Storm dialog box opens.
3. Provide information in the Storm Name field.
4. Select a Special Condition from the drop-down list, if desired.
5. Select a Storm Level from the drop-down list, if desired.
6. Select a date and time for the storm's Start Date. Either:
 - Leave the Use Current Time option checked.
 - Uncheck the Use Current Time option. Click the Start Date calendar button and select a date and time for the storm's start date. Click **OK**. The calendar closes, and the selected date and time populate the Start Date field.
7. In the Define Storm dialog box, click **Ok**. The following occurs:
 - The Storm Information panel appears in between the Zone Selection and Summary Information panels. The Crew Information panel appears below the Zone Selection and Storm Report panels.
 - Storm Management operates in storm mode for the selected control zone.
 - If the selected control zone has any child zones not already operating in storm mode, the child zones operate in storm mode as part of this same storm.

Note: If your system has a control zone set up directly beneath the top-level control zone to contain all of the fuzzy events in the system, that fuzzy control zone cannot be placed into storm mode. That fuzzy zone will only go into storm mode when its parent zone is placed into storm mode.

Joining Existing Storms

If you try to place a control zone into storm mode and either: 1) there are other control zones at the same level that are already operating in storm mode, or 2) the selected zone has children that are currently operating in storm mode, then the Define Storm dialog box opens with a Join Existing Storm panel. This panel gives you the option of adding the currently selected control zone to an existing storm rather than creating a separate new one.

The Join Existing Storm panel lists the existing storms that the selected control zone can be added to. When you select a storm from the list, the Storm Details section of the dialog box populates with the information that pertains to the selected storm, and then the only editable field is the Start Date.

The Join Existing Storm panel displays the following buttons:

- The **Clear Selection** button deselects the storm in the list and reverts the fields of the Storm Details section back to their default, editable values. This button is only enabled when an existing storm is selected from the list.
- The **Ok** button saves the entered storm information and closes the dialog box. Storm Management is now operating in storm mode for the corresponding control zones.
- The **Cancel** button discards the entered storm information and closes the dialog box without switching the currently selected control zone into storm mode.

Joining a Control Zone to an Existing Storm

To join a control zone to an existing storm, complete these steps:

1. Make sure the desired control zone is selected in the Zone Selection tree, and that the zone is in non-storm mode.
2. Do one of the following:
 - Select the Toggle Storm Mode option from the System menu, or
 - Click the **Toggle Storm Mode** button on the toolbar. The Define Storm dialog box opens with the Join Existing Storm panel displayed.
3. In the Join Existing Storm panel, select the storm you want the selected zone to join.
4. Select a date and time for the storm's start date using one of the methods below:
 - Leave the Use Current Time option checked. The current system time on the server will be used as the Start Date of the storm in this control zone.
 - Uncheck the Use Current Time option. The Start Date of the storm you selected to join will be used as the Start Date of the storm in this control zone, unless you explicitly edit it.
 - To then edit the Start Date, click on the Start Date **calendar** button and select a date and time for the storm's start date. Click **OK**. The calendar closes, and the selected date and time populate the Start Date field.
5. In the Define Storm dialog box, click **Ok**. The following occurs:
 - The Storm Information panel appears in between the Zone Selection and Summary Information panels. The Crew Information panel appears below the Zone Selection and Storm Report panels.
 - Storm Management operates in storm mode for the selected control zone.
 - If the selected control zone has any child zones not already operating in storm mode, the child zones operate in storm mode as part of this same storm.

Note: If all of the children of a zone are eventually placed under the same storm individually with the Join Existing Storm panel, the parent zone is

automatically placed into storm mode when the last child zone is joined to that storm. The parent zone adopts the earliest Start Date of all of its children.

Changing Storm Levels

The Storm Level value is recorded for information and reporting purposes only and has no effect on the estimate calculations.

To change the Storm Level selection, complete these steps:

1. Make sure the currently selected control zone is at the simulation level and operating in storm mode.
2. In the Storm Information panel, select the new storm type from the Storm Level drop-down menu.
3. Click the **Save Changes** button or select the Save Changes option from the System menu.
 - Any child zones of the currently selected zone that are also part of this same storm will receive the new storm level as well.

Changing Storm Types

The storm type listed in the Special Condition drop-down menu is linked to a specific set of historical average values. If the characteristics of a zone's storm change, you can change the Special Condition value and have the system use a new set of historical average values in its estimate calculations for that zone.

To change the Special Condition storm type, complete these steps:

1. Make sure the currently selected control zone is at the simulation level and operating in storm mode.
2. In the Storm Information panel, select the new storm type from the Special Condition drop-down menu.
3. Click the **Save Changes** button or select **Save Changes** from the System menu.
 - The Storm Report panel immediately repopulates with the historical averages for the new storm type.
 - Any child zones of the currently selected zone that are also part of this same storm will receive the new storm type as well.
 - Storm Management will use the historical average values that apply to the new storm type when recalculating estimates for events in that control zone, as well as its child zones that belong to the same storm, during the next scheduled simulation iteration.

Example of Changing Storm Types

For example, the Branch level of the control zone hierarchy is the simulation level. A Wind/Rain storm was defined for the Stark branch zones, which includes the Lake, Alliance, and Massillon zones. However, the temperature in the Alliance zone was cold enough for ice to form. The Special Condition in the Stark zone is set to Wind/Rain storm, so estimates being calculated for Alliance could be inaccurate due to the increased travel time involved in the icy conditions observed there.

If you change Special Condition in the Alliance zone to Ice, the historical value averages in the Storm Report repopulate with values appropriate for an ice storm. When the next scheduled simulation iteration occurs, the events in the Alliance zone receive estimates calculated using the historical averages for Ice, while the events in all other control zones in the Stark region continue to receive estimates calculated using the historical averages for Wind/Rain.

Forecasting Outages

Outage forecasting takes into account future storm load. It provides more accurate estimated restoration projections in the early stages of a storm by simulating the expected impact of the storm. Outage forecasting can be performed in a control zone at the simulation level currently operating storm mode.

Forecasting Outages by Percentage

To perform outage forecasting by percentage, complete these steps:

1. Make sure the Forecast Mode field in the Storm Report panel is set to % Change, and the current control zone is at the simulation level.
2. Click in the % Change cell beneath the Actual Outages column.
3. Revise the percentage in the cell to the value you want to use. This value must be greater than or equal to 100%.
4. Press **Enter**.
5. Click the **Save Changes** button on the toolbar or select **Save Changes** from the System menu. The following occurs:
 - The value in the Actual Outages column for each outage category is multiplied by the percentage in the % Change row and the result is displayed in the Total Outages column for each outage type. If any outage type currently has an Actual Outages value of 0, then 0 will remain displayed in the Total Outages column until at least one event of that outage type appears.
 - New outages that enter the system reflect the forecasting percentage and update the Total Outages column accordingly.
 - During the next scheduled simulation, the Storm Management estimates calculation takes into account the increased outage percentage. The modified percentage stays in place until the value in the % Change row is changed back to 100 or until storm mode is exited for the control zone.

Forecasting Outages by Value

The Total Outages column of the Storm Report is a calculated column containing the number of total forecasted outages for each outage type. When the currently selected control zone is at the simulation level and operating in storm mode, you can override the value of this column by editing individual cells within the column.

To perform outage forecasting by value, complete these steps:

1. Make sure the Forecast Mode field is set to Value and the current control zone is at the simulation level.
2. Click in the cell beneath the Total Outages column for the Outage Type whose value you wish to forecast.
3. Enter the new value.
4. Click **Enter**.
5. Click the **Save Changes** button on the toolbar or select **Save Changes** from the System menu. The following occurs:
 - The Total cell value beneath the Total Outages column updates to reflect the new sum using the modified forecast values.
 - During the next scheduled simulation, the Storm Management estimates calculation takes into account the increased number of outages.

- As new outages enter the system, the Total Outages column stays the same until the number of Actual Outages for an outage type exceeds the number of total outages. Once that occurs, Value forecasting is no longer applied to that outage type.

Note: If you enter an invalid value into the Total Outages column, the cell reverts to its previous value when the **Save** button is pressed.

Using Forecast Profiles

You may want to define and save one or more outage forecasting profiles to be used for analysis and resource planning prior to a storm's occurrence. You can create, edit, delete, and apply forecasting profiles by using the Forecast Profiles window.

This section includes the following topics:

- [Forecast Profiles Window](#)
- [Adding a Profile](#)
- [Editing a Profile](#)
- [Removing a Profile](#)
- [Applying a Profile](#)
- [Printing Forecast Profiles](#)

Forecast Profiles Window

To open the Forecast Profiles window, complete these steps:

1. Make sure the currently selected control zone is at the simulation level.
2. Do one of the following:
 - Select the **Forecast Profiles...** option from the System menu, or
 - Click the **Forecast Profiles** on the toolbar.

The Forecast Profiles window displays the following fields and buttons:

- The **Add Profile** button adds a new default row to the table in the Forecast Profiles dialog box. That default row may then be edited to contain the desired profile name and outage type values. If a row marked for removal is selected, pressing the Add Profile button will undo the removal mark. New, unsaved rows display in the table as green. Edited, unsaved rows display in the table as cyan.
- The **Remove Profile** button marks the selected row for removal from the table in the Forecast Profiles window. Rows marked for removal display in the table as red.
- The **Save Profiles** button saves any new or modified profiles, and any rows marked for removal will be deleted. If the Forecast Profiles table contains more than one row with the same profile name, an error dialog box will appear and no changes will be saved.
- The **Profile Name** column contains a unique name for the profile.
- The remaining columns correspond to each Storm Management outage type category. These columns contain the number of outages of that outage type that comprise the forecast profile.

Buttons

- The **Apply Profile** button applies the selected forecast profile values into the Total Outages column of the Storm Report panel.
- The **Print...** button brings up the Print Preview dialog box, which allows you to print out the contents of the Forecast Profiles dialog box.
- The **Cancel** button closes the dialog box without saving changes, and leaves the forecast profiles as they were.

Adding a Profile

To add a new outage forecasting profile:

1. Do one of the following:
 - Click the **Forecast Profiles** button on the toolbar, or
 - Select **Forecast Profiles** from the System menu. The Forecast Profiles dialog box opens.
2. Click the **Add Profile** button to add a new row to the Forecast Profiles table.
3. Click into the Profile Name cell of the row and specify a unique name for this profile.
4. Click in the desired outage type cells of the row and specify a number of outages.
5. Click the **Save Profiles** button. The Forecast Profiles dialog box closes and the new profile is saved for later use.

Editing a Profile

To edit an existing outage forecasting profile:

1. Do one of the following:
 - Click the **Forecast Profiles** button on the toolbar, or
 - Select **Forecast Profiles** from the System menu. The Forecast Profiles dialog box opens.
2. Click into the desired cell of the desired forecast profile and modify the profile name/outage type count.
3. Click the **Save Profiles** button. The Forecast Profiles dialog box closes and the edited profile is saved for later use.

Removing a Profile

To remove an existing outage forecasting profile:

1. Do one of the following:
 - Click the **Forecast Profiles** button on the toolbar, or
 - Select the Forecast Profiles option from the System menu. The Forecast Profiles dialog box opens.
2. Click into the any cell of the forecast profile to be removed.
3. Press the **Esc** key.
4. Click the **Remove Profile** button.
5. Click the **Save Profiles** button. The Forecast Profiles dialog box closes and the marked profile is removed.

Applying a Profile

To apply an outage forecasting profile:

1. Do one of the following:
 - Click the **Forecast Profiles** button on the toolbar, or
 - Select **Forecast Profiles** from the System menu. The Forecast Profiles dialog box opens.
2. Click into the any cell of the forecast profile to be applied.
3. Click the **Apply Profile** button. The Forecast Profiles dialog box closes, and the Total Outages column of the Storm Report for each outage type is now populated with the corresponding value from the forecast profile.
4. Click the **Save Changes** button. The Total cell value beneath the Total Outages column updates to reflect the new sum using the modified forecast values. For any outage type where

the Actual Outages value exceeds the forecasted value, the Total Outages column for that outage type will instead display the Actual Outages value rather than the forecasted value.

Printing Forecast Profiles

To print the contents of the Forecast Profiles dialog box, complete these steps:

1. Do one of the following:
 - Click the **Forecast Profiles** button on the toolbar, or
 - Select **Forecast Profiles...** from the System menu. The Forecast Profiles dialog box opens.
2. Click the **Print...** button. The Print Preview dialog box opens.
3. Adjust the scale, orientation, and page setup as desired.
4. Click the **Print** button on the toolbar to print the pages. The Print Preview dialog box disappears and the print output appears at your selected printer.

Working with Crew Information





Storms create critical outage situations that make it vital to account for crew resources. For example, you may need to move a crew to a different control zone depending on the backlog of outages within each zone.

Crew Information Pane

The Crew Information pane lists all of the crews identified in Storm Management for the currently selected control zone and its children. Crews of certain skill and availability within a control zone are grouped together. Each row in the Crew Information table represents a group of crews.

Crew Information Toolbar

The Crew Information pane provides toolbar action buttons:

| Button | Description |
|---|---|
|  Add Crew... | The Add Crew... button opens the Add Crew Group dialog box, which lets you define new crew groups for the Crew Information table. |
|  Edit Crew... | The Edit Crew... button opens the Edit Crew Group dialog box, which lets you change crew data for a selected crew group in the Crew Information table. |
|  Delete Crew... | The Delete Crew... button removes the selected crew group from the Crew Information table. A warning dialog box opens, prompting you for confirmation before deleting. |
|  Move Crew... | The Move Crew... button opens the Move Crew Group dialog box, used to transfer crews from the selected crew group in the Crew Information table to another control zone. |
|  Apply Crew Change... | The Apply Crew Changes button saves changes made in the Crew Information table. Unapplied changes in the Crew Information table are highlighted in different colors. |

| Button | Description |
|--|---|
|  Import Crews... | The Import Crews... button opens the Import Crews dialog box. In real-time mode, this dialog box lets you import crews from Oracle Utilities Network Management System Web Trouble into the Crew Information table. In study mode, it additionally lets you import crew group information from the real-time session or the applied manual override or outage forecasting parameters from the real-time session into study mode. |

Crew Information Table

The Crew Information panel displays the following fields:

- The **# Crews** column contains the number of crews that belong to the group.
- The **Zone** column contains the name of the control zone that crew group is assigned to.
- The **Company** column contains the name of the company that the crew group works for. This column is for informational purposes and does not affect the outcome of the estimate calculations.
- The **Crew Type** column contains the type of crew within the group. This indicates the type of work performed by the crews. The options here match the crew types defined in the Crew Makeup window (see [Using Crew Makeup](#) on page 2-41 for details).
- The **Start Date** column contains the date and time at which each crew in the group is available for work.
- The **End Date** column contains the date and time at which each crew in the group becomes unavailable for work.
- The **Hours On** column contains the length of the shift worked by each crew in the group.
- The **Hours Off** column contains the length of time between shifts worked by each crew in the group (that is, the number of hours that the each crew in the group has off after completing each shift).

Hiding the Crew Information Table

You can hide the Crew Information table by clicking the down arrow button in the upper left corner of the pane.

Sorting the Crew Information Table

You can sort the Crew Information table in ascending or descending order according to any column in the table.

To sort the Crew Information table, click on the column heading of the column you want to sort by. The table sorts in ascending order of the selected column, and an up arrow appears on the column heading, indicating that the sort is ascending.

Click the same heading again to toggle to descending sort order. A down arrow appears, and the table re-sorts.

Applying Changes

A highlighted row in the Crew Information table indicates that there have been changes entered but not yet saved.

- Green highlighted rows are new rows that are added to the table.
- Cyan highlighted rows are rows that have been edited or updated.

A crew group may have been added, edited, moved or imported, but the changes are not permanent until you click the **Apply Crew Changes** button on the Crew Information toolbar.

Once you save the changes, the new or changed rows in the Crew Information table are no longer highlighted. If at the time of the application there are rows in the Crew Information table that contain the same data in all of their columns (except the # Crews column), then those rows are combined. The numbers of crews for each row are added together and the sum appears in the # Crews column.

If you try to change the control zone view while there are unsaved changes in the Crew Information table, a dialog box prompts you to do one of the following:

- The **Yes** button saves the changes in the Crew Information table and moves to the newly selected control zone.
- The **No** button discards the changes in the Crew Information table and moves to the newly selected control zone.
- The **Cancel** button closes the dialog box without altering the changes in the Crew Information table or moving to the selected control zone.

Importing Crews

The crew information used by Storm Management is maintained separately from that in Oracle Utilities Network Management System Web Trouble. However, crew information defined in Web Trouble can be imported into Storm Management with the Import Crews dialog box.

To open the Import Crews dialog box when in storm mode, click the **Import Crews...** button on the toolbar.

Note: Changes made within Storm Management to the imported crews will not affect the data in Oracle Utilities Network Management System Web Trouble.

The Import Crews dialog box serves two functions:

- In real-time mode, it lets you import crew information from Web Trouble into the Crew Information table, based on specified filtering criteria.
- In study mode, it lets you import Web Trouble crew information, as well as the manual override/outage forecasting parameters of the currently selected control zone and any crew information from real-time mode into study mode.

Import Crews Window

The Import Crews window contains the following fields and buttons:

- Zone Information
 - The **Current Zone** field displays the name of the currently selected control zone. This field is not editable.
- Import Criteria
 - The **Reset** option, when checked, replaces all crews currently in the Crew Information table with the imported crews. When not checked, the imported crews are added to the existing data in the Crew Information table.
 - The **Real Crews** option is checked by default. This option imports crew information from Web Trouble. This option is only deselectable in study mode.
 - The **Crew Groups** option, when checked, lets you import the crew groups from the real-time session. This option is only enabled in study mode.
 - The **Parameters** option, when checked, lets you import the outage forecasting and manual overrides from real-time mode for the selected control zone. This option is only enabled in study mode.

- Filters
 - The **Zone** option, when checked, option imports only crews from the specified control zone. The button on the right opens the Control Zone Selection dialog box. (In this dialog box, select the zone you want and click **OK**.)
 - The **Company** option is only enabled when the Real Crews Import Criteria option is not selected. It imports only the crews with the Company specified in the drop-down list.
 - The **Crew Type** option, when checked, imports only the crews whose type matches the crew type specified in the drop-down list.
 - The **Real Crew Status** option, when checked, imports the crews whose status in Web Trouble matches the status specified in the drop-down list. Available crew status options are On-Shift (crew is active and currently on shift), Off-Shift (crew is active and currently off shift) and Inactive (crew is currently not active). This option is only enabled when the Real Crews Import Criteria is selected.
- The **Import** button imports the crew information and/or outage forecasting and manual override parameters as specified and closes the dialog box. In the Crew Information table, the imported data is highlighted and crews with identical parameters are automatically combined into the same group. To confirm the changes and remove the highlighting, click the **Apply Crew Changes** button.
- The **Cancel** button discards the import criteria options and closes the dialog box without importing anything.

How to Import Crews

To import crews, complete these steps:

1. Make sure the currently selected control zone is operating in storm mode.
2. Click **Import Crews...** on the Crew Information toolbar.
3. Select the import criteria and filters for the crews you want to import.
4. Click **Import**. If an imported crew is not an identical match to any existing crew group rows in the Crew Information table, then it's added to the table as a new row and highlighted in green. If an imported crew is an identical match to any existing crew group rows in the Crew Information table, then the number of crews in the existing crew group row is incremented and the row is highlighted in cyan.
5. To apply the changes, click the **Apply Crew Changes** button on the toolbar.

Example of Importing Crews

The highlighted rows in the Crew Information table below show the results of importing crews into real-time without using the Reset option. The Hours On and Hours Off values default to 8 and 16 respectively for any crew information imported from Web Trouble.

- Green highlighted rows are new rows that are being added to the table.
- Cyan highlighted rows are crew groups that are having crews added to them. The # Crews column has been increased to reflect the new number of crews in the group.

Note: The End Date column is not populated because there is no corresponding value defined in Web Trouble.

Adding Crew Groups

You can add new crew groups to Crew Information table using the **Add Crew** dialog box. To open the **Add Crew** dialog box, click the **Add Crew...** button on the toolbar.

- **Details Pane**
 - The **Zone** field is the control zone that the crew group is assigned to. The default value is the control zone that Storm Management is currently viewing. The button on the right

opens the Control Zone Selection dialog box. (In this dialog box, click on the zone you want and click **OK**.)

- The **Company** drop-down menu is the name of the company that the crew group works for. This column is for informational purposes and does not affect the outcome of the estimate calculations.
- The **Crew Type** drop-down menu is the type of crew within the group. This indicates the type of work performed by the crews. The options here match the crew types defined in the Crew Makeup window of Web Trouble.
- The **# Crews** field allows you to specify the number of crews that belong to the group.
- **Schedule**
 - The **Start Date** field is the date and time at which each crew in the group is available for work. The button on the right opens a calendar dialog box to select the date and time from.
 - The **Avail Until** field is the date and time at which each crew in the group becomes unavailable for work. The button on the right opens a calendar dialog box to select the date and time from.
 - The **Hours On** field allows you to specify the length of the shift worked by each crew in the group, beginning at the Start Date.
 - The **Hours Off** field allows you to specify the length of time between shifts worked by each crew in the group (that is, the number of hours that the each crew in the group has off after completing each shift).
- The **OK** button confirms the details and schedule for the new crew group, inserts the information into the Crew Information table, and closes the dialog box. You must save the new crews by clicking the **Apply Crew Changes** button or selecting the Apply Crew Changes option from the Crew menu.
- The **Cancel** button discards the details and schedule and closes the dialog box without inserting any information.

When there is at least one crew in the table, right-click to select the row in the Crew Information table and display the context menu .

- The **Copy Crew** option copies the selected row in the Crew Information table.
- The **Paste Crew** option inserts the copied crew into the Crew Information table below the current line.
- The **Add Crew** option inserts a new row into the Crew Information table containing default values. Once the new row is added, you can change the values in each column.

Adding Crew Groups with the Right-Click Context Menu

You can add crews directly in the Crew Information table by using the right-click context menu. To do this, complete these steps:

1. Right-click in the Crew Information table. The context menu appears, with the **Add Crew** option enabled.
2. Select **Add Crew**. A new row appears in the Crew Information table with the default values, highlighted in green.

Editing Crew Groups Using Edit Crew

Once you have imported or added crew groups, you can modify the details of a crew group. Modify crew information using the Edit Crew Group dialog box.

1. Click the **Edit Crew...** button on the toolbar to open the Edit Crew Group dialog box. The Edit Crew Group dialog box contains the same fields as the Add Crew Group dialog box. The fields are populated with data from the selected row of the Crew Information table.
2. Modify the crew as necessary and click **OK** to update the Crew Information table.
3. To apply the modifications, click the **Apply Crew Changes** button.

Editing Crew Groups within the Crew Information Table

You can also edit crews directly in the Crew Information table. To do this, complete these steps:

1. Click the cell of the row that you want to edit. Depending on the type of data in the cell, one of the following occurs:
 - A cursor appears within the cell.
 - A calendar dialog box opens for you to select a new date and/or time.
 - A Control Zone Selection dialog box opens.
 - A drop-down list opens.
2. Make changes by either editing the value in the cell or selecting from the dialog box or drop-down list. (In the Control Zone Selection dialog box, click on the zone you want and click **OK**. In the calendar dialog box, select a new date and/or use the spinners to set a new time.). The edited row becomes highlighted in cyan.
3. Click **Apply Crew Changes**. The following occurs:
 - Your edits are saved.
 - The row is no longer highlighted.
 - The changes are used during the next scheduled simulation iteration.

Deleting Crew Groups

To delete a crew group from the Crew Information table, complete these steps:

1. Select the crew group in the Crew Information table.
2. Click the **Delete Crew** button.
A message box opens, requesting confirmation that the selected crew group should be permanently deleted.
3. Click **Yes** to confirm the delete. The crew group disappears from the Crew Information table.

Note: The **No** button cancels the delete.

Moving Crew Groups to a Different Control Zone

Each crew group is assigned to a specific control zone when it is created. During your analysis, you may want to adjust your crew resource allocation by reassigning crews to different control zones. The Move Crew Group dialog box enables you to move all or part of the crews within a selected crew group to different control zones.

To open the Move Crew Group dialog box, select a crew group from the Crew Information Table and click the **Move Crew...** button. The Move Crew Group window contains the following fields and buttons:

- The **Company** field displays the name of the company that the crew group works for. This field is not editable.

- The **Crew Type** field displays the type of crew within the group. This indicates the type of work performed by the crews. It matches the crew types defined in the Web Trouble Crew Makeup window. This field is not editable.
- The **From Zone** field displays the current control zone of the selected crew group. This field is not editable.
- The **To Zone** is the control zone that the specified number of crews is moving to. The button on the right opens the Control Zone Selection dialog box. (In this dialog box, click on the zone you want and click **OK**.)
- The **# Crews** field allows you to specify the number of crews within the selected crew group to move to the new control zone. If you enter a number greater than the number of existing crews, an error will occur when you click **OK**.
- The **OK** button confirms the details of the move and closes the dialog box. If all of the crews in a group are being moved, the original crew group row now appears highlighted in cyan with the control zone modified. If only part of the crews is being moved from a crew group, the original group row is now highlighted in cyan with the number of crews decreased appropriately. A new crew group row appears highlighted in green with the number of specified crews to move and new control zone (all other fields in the row are the same as the original crew group).
- The **Cancel** button discards the details about the move and closes the dialog box without saving any information.

To move crews, complete these steps:

1. Select a crew group row in the Crew Information Table.
2. Click the **Move Crew...** button. The Move Crew Group dialog box opens.
3. Click the zone selection button on the right of the To Zone field. The Control Zone Selection dialog box opens.
4. Select the control zone you want to move the crews to and click **OK**. The Control Zone Selection dialog box closes, and the zone you selected populates the To Zone field.
5. If you only want to move part of the crews in the group, enter the number of crews you want to move in the # Crews field.
6. Click **OK**. The dialog box closes.

If all of the crews in a group are being moved, the original crew group row now appears highlighted in cyan with the control zone modified.

If only part of the crews is being moved from a crew group, the original group row is now highlighted in cyan with the number of crews decreased appropriately. A new crew group row appears highlighted in green with the number of specified crews to move and new control zone (all other fields in the row are the same as the original crew group).

7. Click the **Apply Crew Changes** button. The following occurs:
 - The crew groups are moved to their assigned control zones.
 - The modified rows are no longer highlighted.
 - The updated information is used during the next scheduled simulation iteration.

Moving Entire Crew Groups Using the Table Edit Features

You can also move a crew group by clicking directly in the Zone field of the crew group row and changing the control zone. To move a crew group in this way, complete these steps:

1. Click in the Zone field for the crew group you want to move. The row becomes selected, and the Control Zone Selection dialog box appears.
2. Select the zone you want to move the crew group to and click **OK**.

3. Click in a different field of the row. The Zone field updates to reflect the zone you just selected, and the row becomes highlighted in cyan.
4. Click **Apply Crew Changes**. The modified row moves to its new control zone and is no longer highlighted. The updated information is used during the next scheduled simulation iteration.

Moving Partial Crew Groups Using the Right-Click Context Menu

You can also move partial crew groups directly from the Crew Information table. To do this, complete these steps:

1. Select a crew group row in the Crew Information Table.
2. Copy the crew group by selecting the **Copy Crew** option from the context menu.
3. Paste the crew as a new row by selecting the **Paste Crew** option from the context menu.
4. Edit the Control Zone in the new row.
 - Click the **Zone** cell to select it and then click again to edit it.
 - Click the select zone button () to open the Control Zone Selection dialog box. Select the new control zone and click **OK**.
5. Edit the **# Crews** cell in the original row.
6. Edit the **# Crews** cell in the new row.
7. Click **Apply Crew Changes**. The following occurs:
 - The new row moves to its assigned control zone.
 - The modified rows are no longer highlighted.
 - The updated information is used during the next scheduled simulation iteration.

Using Study Mode

While in Storm Mode, you may enter study mode, which enables you to manipulate parameters that affect the estimate calculations, such as outage forecasting, manual overrides and crew information, without altering the current real-time calculations.

This section includes the following topics:

- [Entering Study Mode](#)
- [Calculating Crew Resources](#)
- [Importing Crews and Parameters](#)
- [Exporting Crews and Parameters](#)
- [Calculating Estimates in Study Mode](#)
- [Exiting Study Mode](#)

Entering Study Mode

To toggle between study mode and real-time mode, do one of the following:

- Select **Toggle Study Mode** from the Storm menu, or
- Click the **Toggle Study Mode** button on the toolbar.

You can only enter study mode from a control zone that is currently in storm mode.

The first time you enter a study session, several portions of the Storm Management window are not populated as they were in the real-time session:

- The Summary Information table's Est Assessed By and Est Restored By columns are empty.

- The Storm Report table's Total Time to Assess and Total Time to Restore columns display zeros.
- The Storm Report table's Estimated Assessed By and Estimated Restored By columns are empty.
- Outage forecasting parameters that existed in the real-time session are not applied.
- Manual overrides that existed in the real-time session are not applied.
- The Crew Information table is empty.
- The Last Update field of the status bar does not contain a time.

Once you create a study session, it remains active throughout the storm. You may find a need to toggle between study and real-time modes repeatedly during a storm. Each time you re-enter study mode, Storm Management loads the saved data saved from the most recent visit to the study session.

The status bar at the bottom of the Storm Management window identifies the current operating modes, as shown below for study, storm mode.

When in study mode, the window's refresh interval is disabled, and estimate calculations using the data in the study mode session must be triggered manually. However, the system does continue to make real-time estimate calculations for all control zones.

Calculating Crew Resources

In storm mode, Storm Management can calculate the approximate number of crews that the system requires to complete assessment and restoration in the currently selected control zone by a specified date. You can enter variables used in the calculation and see the results in the Calculate Crews dialog box.

To open the Calculate Crews dialog box, do one of the following:

- Select **Calculate Crews** from the Storm menu when in storm mode, or
- Click the **Calculate Crews...** button on the toolbar.

The Calculate Crews dialog box displays the following fields and buttons:

- The Assessment **Desired Date** field contains the assessment completion time you want to achieve. The button on the right of this field opens a calendar that enables you to select a date and time. You must select a date and time later than the current time. The value you enter (and the system uses) displays in the upper left corner above the Used Crews table after the results are calculated. You may leave this field blank if you wish to Calculate Crews for Repair only.
- The Assessment **Work Efficiency (%)** field contains the efficiency of the assessment crews as a percentage. This value affects the amount of work to be completed and is applied along with performance factor values associated with the crew type. You must specify the assessment work efficiency as a percentage between 1 and 100. The value you enter (and the system uses) displays to the right of the Estimated Assessed By date above the Used Crews table after the results are calculated.
- The Repair **Desired Date** field contains the repair completion time you want to achieve. The button on the right of this field opens a calendar that enables you to select a date and time. You must select a date and time later than the current time. The value you enter (and the system uses) displays to the left of the Repair Eff percentage above the Used Crews table after the results are calculated. You may leave this field blank if you wish to Calculate Crews for Assessment only.
- The Repair **Work Efficiency (%)** field contains the efficiency of the repair crews as a percentage. This value affects the amount of work to be completed and is applied along with performance factor values associated with the crew type. You must specify the assessment

work efficiency as a percentage between 1 and 100. The value you enter (and the system uses) displays above the right corner of the Used Crews table after the results are calculated.

- The **Hours** field contains the number of hours that equal one crew unit. The results are returned in crew units rounded to the next whole integer. The value entered and used by the calculation displays above the Available Crews table.
- The **Calculate Crews** button calculates the number of crews based on the specified data. It populates the Used Crews and Available Crews panels with the results.
- The **Reset** button resets the entries in the Assessment Desired Date and Work Efficiency, the Repair Desired Date and Work Efficiency, and the Crew Unit Hours fields back to their default values.
- The **Print...** button brings up the Print Preview dialog box, which allows you to print out the contents of the Calculate Crews dialog box.
- The **Cancel** button closes the dialog box.
- The **Outage Types** column contains the name of the Storm Management outage type category.
- The **Assessment Units Existing** column contains the number of existing assessment crews units that can assess each outage type by the specified date.
- The **Assessment Units Needed** column contains the number of additional assessment crew units needed to assess each outage type by the specified date.
- The **Assessment Units Total** column contains the total number of assessment crew units needed to assess each outage type by the specified date.
- The **Repair Units Existing** column contains the number of existing repair crews units that can repair each outage type by the specified date.
- The **Repair Units Needed** column contains the number of additional repair crew units needed to repair each outage type by the specified date.
- The **Repair Units Total** column contains the total number of repair crew units needed to repair each outage type by the specified date.
- The **Crew Type** column indicates the type of work performed by the crews. It matches the crew types defined in the Crew Makeup window of Oracle Utilities Network Management System.
- The **Unused Units** column contains the number excess crew units for each crew type that are found to exist by the calculation.
- The **Total Units** column contains the total number of units for each crew type that are found to exist by the calculation.

Calculating Crews Needed to Assess and Restore Outages by a Given Time

To calculate the number of crew units needed to assess and repair all events in the currently selected control zone by a specific time, complete these steps:

1. From a control zone in storm mode, do one of the following:
 - Select **Calculate Crews** option from the Storm menu, or
 - Click the **Calculate Crews...** button on the toolbar.
2. Click on the Assessment Desired Date calendar button.
3. From the calendar dialog box, select the date and time you want all assessment completed by and click **OK**.
4. Select the percentage in the Assessment Work Efficiency (%) field and type the percentage you want to use.

5. Click the **Repair Desired Date** calendar button.
6. From the calendar dialog box, select the date and time you want all repair completed by and click **OK**.
7. Select the percentage in the Repair Work Efficiency (%) field and type the percentage you want to use.
8. Click the **Calculate Crews** button. Storm Management estimates the number of crew units needed and available and displays the results in the Used Crews and Available Crews tables.

Printing Calculate Crews Results

To print the contents of the Calculate Crews dialog box, complete these steps:

1. Do one of the following:
 - Click the **Calculate Crews** button on the toolbar, or
 - Select **Calculate Crews...** option from the System menu. The Calculate Crews dialog box opens.
2. Click the **Print...** button. The Print Preview dialog box opens.
3. Adjust the scale, orientation, and page setup as desired.
4. Click the **Print** button to print the pages. The Print Preview dialog box disappears and the print output appears at your selected printer.

Importing Crews and Parameters

In study mode, the Import Crews dialog box has additional options not available in real-time mode. It enables you to import Web Trouble crew information, as well as the manual override/outage forecasting parameters of the currently selected control zone and any crew information from real-time mode into study mode.

Importing Real-Time Crews and Parameters into the Study Session

To open the Import Crews dialog box, click the **Import Crews...** button above the Crew Information table.

The following fields are only activated in study mode:

- The **Crew Groups** option, when checked, enables you to import the crew groups from the real-time session.
- The **Parameters** option, when checked, option enables you to import the outage forecasting and manual overrides from real-time mode for the selected control zone.
- The **Company** option is only enabled when the Real Crews Import Criteria option is not selected. It imports only the crews with the Company specified in the drop-down menu.

Once you click the **Import** button, Storm Management Crew Information panel looks and behaves as it does in real-time mode.

The window below shows how the Crew Information table would look if real-time crew groups are imported with no filters. All of the real-time crews are imported.

Importing Real-Time Session Information into the Study Session

To import crews, complete these steps:

1. Make sure the currently selected control zone is operating in study mode.
2. Click **Import Crews....**
3. Uncheck the Real Crews option under the Import Criteria section.
4. Check the Crew Groups option under the Import Criteria section.
5. Check the Parameters option under the Import Criteria section.

6. Click **Import**. The following occurs:
 - Any outage forecasting and manual override parameters that exist for this control zone in the real-time session are applied to the Storm Report table, but not yet saved.
 - The Save Changes button in the toolbar becomes sensitized.
 - The Crew Information table is now populated with the crew groups that exist for this control zone in the real-time session. If an imported crew is not an identical match to any existing crew group rows in the Crew Information table, then it's added to the table as a new row and highlighted in green. If an imported crew is an identical match to any existing crew group rows in the Crew Information table, then the number of crews in the existing crew group row is incremented and the row is highlighted in cyan.
7. Apply the outage forecasting and manual override changes by either:
 - Clicking the **Save Changes** button on the toolbar, or
 - Selecting Save Changes from the System menu.
8. Apply the Crew Info table changes by clicking **Apply Crew Changes**.

The Crew Information table updates to display only those crews belonging to the currently selected control zone. The crew groups that are removed from the current view are saved in the study session for their appropriate control zones. You can view them by selecting their control zone from the Zone Selection tree.

Resetting the Current Study Session to Match the Real-Time Session

In the course of working with the study session, the user may want to start over by resetting the state of the study session to the current state of the real-time session.

1. To reset the study session, do one of the following:
 - Click the **Reset Study Session** button on the toolbar, or
 - Select **Reset Study Session** from the Storm menu.

The Reset Study Session confirmation dialog box will appear.

2. Click the **Yes** button on the confirmation dialog box to proceed. The confirmation dialog box closes. The Crew Information table updates with the crews defined in the real-time session. Special Condition, Forecast mode and override information in the Storm Report table are also updated to match the real-time session.

Note: This operation affects all control zones, not just the currently selected zone.

Exporting Crews and Parameters

Once the user is satisfied with the simulation parameters in study mode, the parameters can be exported back into the real-time session.

To export the study session parameters, complete these steps:

1. Do one of the following:
 - Click the **Export Study Session** button on the toolbar, or
 - Select **Export Study Session** from the Storm menu.

The Export Study Session confirmation dialog box appears.

2. Click the **Yes** button on the confirmation dialog box to proceed. The confirmation dialog box closes. The contents of the Crew Information as well as Special Condition, Forecast mode and override information in the Storm Report table are copied into the real-time session.

Note: This operation affects all control zones in the real-time session, not just the currently selected zone.

Calculating Estimates in Study Mode

Because estimate calculations using the data in the study mode session must be triggered manually, you must use the **Force Simulation Run** button to calculate the results.

Note: While you are working in study mode, Storm Management continues to calculate restoration times for control zones operating in real-time.

To calculate estimates in study mode, do one of the following:

- Select **Force Simulation Run** option from the System menu, or
- Click the **Force Simulation Run** button on the toolbar.

The Summary Information table and Storm Report table update to display the estimates. The status bar indicates the time at which the forced simulation was last executed in the study session.

Note: Each time you make changes in the Storm Management window in study mode, you must press the **Force Simulation Run** button in order to view the results of the changes. Because every time you press the **Force Simulation Run** button causes Storm Management to completely re-analyze and calculate estimates for all events in the system, forcing a simulation could slow down system performance at times. It is recommended you keep forced simulations at a minimum.

When Storm Management completes a forced simulation in real-time mode, a confirmation message is displayed.

Note: Once you've found the optimal settings in your study session, you must manually re-enter them into real-time mode to apply them to the storm.

Exiting Study Mode

To exit study mode, do one of the following:

- Click the **Toggle Study Mode** button on the toolbar, or
- Select **Toggle Study Mode** from the Storm menu.

If there are unsaved changes, a dialog box opens prompting you for options to save the changes.

Note: You must exit study mode before you can exit storm mode.

Exiting Storm Mode

To exit storm mode for a selected control zone, do one of the following:

- Select the Toggle Storm Mode option from the System menu, or
- Click the **Toggle Storm Mode** button on the toolbar.

These options are only available if the currently selected control zone is operating in real-time mode and storm mode.

Define Storm Dialog

Once you press the Toggle Storm Mode, the Define Storm dialog box opens, prompting you for the End Date of the storm in this zone.

The Define Storm dialog box displays the following fields:

- The **Zone** field displays the name of the currently selected zone. This control zone and all of its children that aren't already in non-storm mode will be placed into non-storm mode, ending the storm in this zones. This field is not editable.
- The **Storm Name** field displays the name of the storm. This field is not editable.

- The **Special Condition** field displays a storm type that indicates a predefined condition existing with the storm. This condition may also dictate a different set of historical average values be used in the estimate calculations made by the system. This field is not editable.
- The **Storm Level** field displays the severity level for the storm. This value is recorded for information and reporting purposes only and has no effect on the estimate calculations. This field is not editable.
- The **Start Date** field displays the date time at which the storm started in this zone. This field is not editable.
- The **End Date** field contains the date and time at which the storm ended in this zone. When you uncheck the "Use current time" option, the button on the right of this field opens a calendar that lets you select the date and time. Valid dates and times are those prior to (and including) the current time. If your entry is invalid, an error message appears. Click **OK** to close the message and correct the error.
- The **Use Current Time** check box is selected by default. This option allows you to leave the End Date field blank and have the current system time on the server be used as the End Date of the storm in this zone. Deselecting this option enables the calendar button to the right of the End Date field.

Setting the Storm End Date

To set the storm's end date, complete these steps:

1. Select a date and time for the storm's end date. Either:
 - Leave the Use Current Time option checked.
 - Uncheck the Use Current Time option. Click on the End Date calendar button and select a date and time for the storm's end date. Click **OK**. The calendar closes, and the selected date and time populate the End Date field. Valid dates are those between the start date and time of the storm and the current date and time.
2. Click the **Ok** button on the Define Storm dialog box.
 - Storm Management returns to non-storm mode for the selected control zone.
 - If the control zone had any child zones in the same storm, the child zones are also returned to non-storm mode.

Note: The **Cancel** button discards the End Date without saving it. The Define Storm dialog box closes and the currently selected control zone stays in storm mode.

Storm Management View Only Environment

The Storm Management View Only environment is available for users who do not have a need to manipulate the various parameters on the Storm Management window, but rather need to monitor and analyze the information that is presented. To access the Storm Management View Only environment, login with View Only user type (See [Logging In](#) on page 5-2).



View Only Environment User Interface

View Only Menus

There are three menus on the View Only Storm Management menu bar: System, Storm, and Help.

Menu

The options in the System menu are available in both storm and non-storm modes. The following table describes the System Menu options and associated toolbar icons.

| Menu Option | Description | Toolbar Icon |
|-----------------|--|---|
| Retrieve Update | Refreshes the window with the most recent information from the system. |  |
| Print All... | Opens the Print Preview dialog box, which allows you to print out the Summary Information panel, Storm Report panel, Storm Information panel (if present), Crew Information panel (if present), and status bar information from the current Storm Management window. |  |
| Print Crews... | Opens the Print Preview dialog box, which allows you to print out the Crew Information panel from the current Storm Management window. This option is only available in storm mode. |  |

Storm Menu

The option in the Storm menu is only enabled when Storm Management is in storm mode for the selected control zone.

The following table describes the Storm Menu options.

| Menu Option | Description | Toolbar Icon |
|--------------------|---|---|
| Calculate Crews... | Opens the Calculate Crews dialog box, which is used to determine the approximate number of crews needed to complete assessment and repair by a specified date and time. |  |

View Only Help Menu

The Help menu options are Storm Management Help, which opens the online help content for Storm Management, and About Storm Management, which displays information regarding the version of the application and the Web Gateway.

View Only Toolbar

The Storm Management toolbar provides a shortcut to many of the options available from the Storm Management menus.

The View Only Storm Management toolbar displays the following buttons.

- The **Retrieve Update** button refreshes the window with the most recent information from the system. In most cases, the window refreshes itself on a periodic basis. But, if there are unsaved changes in the Storm Management window at the time the automatic refresh is due to occur, the window will not refresh. Instead, an alert appears in the status bar indicating that an update is available, and the Retrieve Update option must be invoked in order to refresh the window with the new update. This allows you to continue on with your changes and save them first before refreshing.
- The **Calculate Crews** button opens the Calculate Crews dialog box, which is used to determine the approximate number of crews needed to complete assessment and repair by a specified date. This option is only available in storm mode.

Storm Management Storm Administration Environment

Upon completion of a storm (that is, all of the control zones belonging to the storm have been transitioned back to the non-storm mode of operation), authorized users can change completed storm data with Storm Management's Administration window. Users can view completed storm records and make changes to the control zone, storm type, storm level, beginning and ending dates of the storm, and define an excludable period for the storm (portion of a storm that can be excluded when reporting reliability metrics).

You can open the Administration window by clicking the Storm Management icon found under the appropriate program group in your Windows Start Menu, or by double clicking the Storm Management icon on your desktop (depending upon how it was installed). The Storm Management Login window will appear.

Login with a User Type of "Storm Administration" to proceed to the Administration window.

Administration Environment User Interface Features



Administration Menus



The Storm Administration environment provides the following menus:

- [Administration System Menu](#)
- [Administration Help Menu](#)
- [Administration Logout Menu](#)

Administration System Menu

The options in the System menu are available at all times. The following table describes the System Menu options.

| Option | Description | Toolbar Icon |
|----------------|--|---|
| Revert Changes | Reloads the most recently saved records from the database. |  |
| Save | Saves any changes made to the table. |  |

| Option | Description | Toolbar Icon |
|----------------------|---|---|
| Excludable Period... | Opens the Excludable Period dialog box, which allows to specify excludable period for the selected record. |  |
| Print... | Opens the Print Preview dialog box, which allows you to print out the contents of the Storm Administration table. |  |

Administration Help Menu

The Help menu provides links to online help content for Storm Management and information about the application, including release version and the Web Gateway that the application is using.

Administration Logout Menu

Provides the User Logout option. If you try to exit the window while there are unsaved changes in the table, a dialog box prompts you to save changes. Click **Yes** to save the changes in the table and exits the window. Click **No** to discard the changes in the table and exits the window. The **Cancel** button closes the dialog box without altering the changes in the table or exiting the window.

Storm Administration Table

The Storm Administration table displays the following fields and buttons:

- The **Storm Name** column contains the name of the storm as defined in the Define Storm dialog box. This field is not editable.
- The **Zone** column contains the name of the control zone affected by this storm. Unless explicitly defined elsewhere in the table, all of the children of the control zone are considered part of this storm as well.
- The **Special Condition** column contains the storm type indicating a predefined condition of the storm, as defined in the Define Storm dialog box.
- The **Start Date** column contains the date and time when the storm began in the zone, as defined in the Define Storm dialog box.
- The **End Date** column contains the date and time when the storm ended in the zone, as defined in the Define Storm dialog box.
- The **Storm Level** column indicates the severity of the storm, as defined in the Define Storm dialog box.
- The Excludable Period Start Date column contains the start date and time of the portion of the storm that can be excluded when reporting reliability metrics.
- The Excludable Period End Date column contains the end date and time of the portion of the storm that can be excluded when reporting reliability metrics.
- The Excludable Period Comment column contains the comments for this excludable period.

Printing The Storm Administration Table

To print the contents of the Storm Administration table, complete these steps:

1. Do one of the following:
 - Click the **Print Preview** button on the toolbar, or
 - Select **Print...** option from the System menu. The Print Preview dialog box opens.
2. Adjust the scale, orientation, and page setup as desired.
3. Click the **Print** button to print the pages. The Print Preview dialog box disappears and the print output appears at your selected printer.

Editing Storm Records

The Storm Administration window has many of the same editing capabilities as Storm Management's Crew Information table. The behavior of the editable field depends on the type of data in the field. When you right-click in a row, the context menu provides the following options:

- The **Cut Row** option removes the selected row from the table. You can paste the removed row back into the table with the **Paste** option. The row stays available for pasting until a new row is copied or cut from the table.
- The **Copy Row** option copies the selected row, enabling you to paste it into the table with the **Paste** option. The selected row that was copied remains in the table.
- The **Paste Row** option inserts the copied or cut row into the table.
- The **Delete Row** option removes the selected row from the table. The removed row cannot be pasted back into the table. To undo a deletion, you must select the Revert Changes option from the **System** menu to restore the table to its last saved state.

Example

The steps below show an example of how you can add new data to the Storm Administration window:

1. Select the row in the table that pertains to the storm whose data you want to change.
2. Copy the row and paste it in the table using the right-click menu.
3. Click in the Zone, Start Date, or End Date column. A cursor appears and you can enter new data.
4. Click in the Special Condition or Storm Level column. A drop-down menu appears with a list of eligible choices for you to select from.
5. Click the **Save** button to keep the changes. Storm Management validates the entries. If any of the following conditions is true, an error dialog box appears and changes are not saved:
 - A storm has multiple entries for the same control zone.
 - An invalid Start Date or End Date is entered (that is, Start Date is later than End Date or End Date is earlier than Start Date).
 - A storm has both an entry for a parent control zone and child control zone where the parent zone's Start Date is earlier than the child zone's Start Date. (Having both a parent and child control zone entry for the same storm with different Start Dates would indicate that the child zone was placed into storm mode within Storm Management first, and then later the parent zone was placed into storm mode within Storm Management. The parent zone entry would have to be removed and replaced with entries for each child zone if it's desired to record that one of the children had a later Start Date than the rest of the zones within that parent.)
 - A storm has both an entry for a parent control zone and child control zone where the parent zone's End Date is earlier than the child zone's End Date. (Having both a parent and child control zone entry with different End Dates for the same storm would indicate that the child zone was placed back into non-storm mode within Storm Management first, and then later the parent zone was placed into non-storm mode within Storm Management. The parent zone entry would have to be removed and replaced with entries for each child zone if it's desired to record that one of the children had a later End Date than the rest of the zones within that parent.)

Excludable Period Dialog

Excludable Period Dialog allows you to set or clear excludable period for multiple records that are part of the same storm.

The excludable period is the portion of a storm that can be excluded when reporting reliability metrics.

- The **Period Start** date entry field allows you to enter the excludable period start date. When the dialog box is opened, this field is populated with the excludable period start date for the selected record. If excludable period is not set, the field is populated with the storm start date.
- The storm start date reset button resets the **Period Start** field to the storm start date.
- The **Period End** date entry field allows you to enter the excludable period end date. When the dialog box is opened, this field is populated with the excludable period end date for the selected record. If the excludable period is not set, the field is populated with the storm end date.
- The storm end date button resets the **Period End** field to the storm end date.
- The **Comment** text area allows you to enter an optional comment for the excludable period.
- The **Set** button sets the excludable period for the selected storm record and all the records in the child control zones for the same storm. The dialog box closes when this button is clicked.
- The **Clear** button clears the excludable period for the selected storm record and all the records in the child control zones for the same storm. The dialog box closes when this button is clicked and any data entered in the dialog box is discarded.
- The **Help...** button opens the help page for this dialog box.
- The **Cancel** button closes the dialog box without making any changes.

Understanding Storm Management Calculations

Storm Management enables you to analyze restoration times during high volume outage periods, such as those that occur during and following ice storms, thunderstorms, hurricanes, and other widespread disturbances. It can provide estimated assessment and restoration times for every outage in the system. It calculates estimates by periodically simulating the entire restoration process, taking into account the dynamically changing outage predictions and crew resource allocation. These restoration estimates can be used to manage workloads and prioritize crew assignments.

This section provides a detailed explanation of the algorithms and data Storm Management uses to create estimates. It includes the following topics:

- [How Storm Management Works](#)
- [Non-Storm Mode Algorithm](#)
- [Storm Mode Algorithm](#)

How Storm Management Works

Storm Management has two basic modes of operation – non-storm and storm mode. The estimate calculation algorithm for each mode is fundamentally the same. For example, both modes use historical averages and simulated restoration calculation/analysis of all unrestored events in the system for the estimate calculation algorithm. However, non-storm mode does not attempt to make crew backlog calculations, making its analysis much simpler.

Historical Averages

The estimate calculation algorithm uses the following historical average minutes data that applies to the different parts of the restoration process:

- **Average travel time for an assessment crew:** how long it takes a crew that is going out to assess the event to arrive onsite, once en route.
- **Average assessment time:** how long it takes a crew to assess the event, once onsite.
- **Average travel time for a repair crew:** how long it takes a crew that is going out to repair the event to arrive onsite, once en route.
- **Average repair time:** how long it takes a crew to repair/restore the event, once onsite.
- **Average cleanup time:** how long it takes before a crew is ready to move on to their next assignment, once the repair/restoration is complete.

The historical average minutes can be broken down by various factors for further granularity of data:

- **Control Zone.** The area the event is in (for example, urban versus rural) may have an affect on how long it takes crews to arrive, and thus you may use different travel times for different control zones.

Note: One of the levels in the control zone hierarchy is designated as the control zone level at which the historical average minutes data is associated. This control zone level is herein referred to as the *simulation level*. For example, if the second level in the control zone hierarchy – the Region level – was the designated simulation level, that would imply that each region would have its own, possibly unique, set of historical average minutes.

- **Outage Type.** The type of outage (for example, service outages, main breaks, and so on) dictates how long it is going to take for repair/restoration, so, consequently, you may use different repair/restore times for different types of outages.
- **Shift.** The time of day (for example, afternoon rush hour versus middle of the night) may have an affect on how long it takes crews to arrive, and/or perform the assessment or repair/restoration, and, therefore, you may use different travel, assessment, and repair/restore times for different shifts.
- **Day Type.** The type of day (weekday versus weekend versus holiday) may have an affect on how long it takes crews to arrive, and thus you may use different travel times for different day types.
- **Season.** The time of year (for example, winter versus summer) may have an affect on how long it takes crews to arrive, and/or perform the assessment or repair/restoration, and thus you may use different travel, assessment, and repair/restore times for seasons.
- **Storm Type.** Particular weather conditions (for example, ice) may have an affect on how long it takes crews to arrive, and/or perform the assessment or repair/restoration, and thus you may use different travel, assessment, and repair/restore times for different types of storms.

Simulation

To generate estimates, the trouble analysis engine periodically goes through a simulated restoration calculation/analysis of all unrestored events in the system. Any events eligible to be assigned an estimated assessment and restoration time by Storm Management (that is, the events are of a type that Storm Management is configured to recognize, and they have not been given a manually-entered estimated restoration time from a crew/dispatcher) are sorted in priority order (part of the Storm Management configuration). Then, starting at the top of that list, the simulation begins. The event at the top of the list is examined. The mode of operation that the control zone in which the event resides is checked in order to determine which version of the algorithm is being applied to calculate the Estimated Restoration Time (ERT). The appropriate set of historical average minutes for the event is looked up, using the various characteristics such as control zone, outage

type, storm type, and when the assessment and repair/restoration is projected to begin. Those historical averages are then used by the calculation of the appropriate algorithm to generate an estimated assessment time and estimated restoration time for the event.

The raw ERT value generated by the simulated restoration calculation can be further refined before becoming event's estimated restoration time.

If configuration rule 'ertAggregationPolicy' is set to *LATEST*, then all events estimated by Storm Management of the same type and at or under the same control zone at the aggregation level, are given the same ERT. That ERT is the latest Storm Management calculated ERT among these events. After aggregation, if configuration rule 'stormmanEstimateRounding' is enabled, the ERT value can be rounded.

Once an event has been given its estimates by the Storm Management simulation, it is removed from that priority-sorted list, and then the next event on the list is analyzed in the same manner, and the process continues until the last event on the list is removed. When the next simulation period occurs, the process starts over again. And when it does, the previously calculated estimates for many events may change, due to factors such as some previously unrestored events now being restored, new events of varying priority appearing, crews arriving onsite at various events, some events being given manually-entered estimated restoration times, no crew yet arriving onsite, or to various parameters on the Storm Management window being modified since the last iteration.

Storm Management Window

Because the engine that generates the estimated assessment and restoration times for each event is a separate process, you do not need to have a Storm Management window open in order for the estimates to be calculated. The main purpose of the Storm Management window is to enable you to monitor and analyze the estimates from overall control zone perspective, and to manipulate several of the parameters that are used to generate the estimates.

Given that it's not required to have a Storm Management window open to generate the estimates, after each periodic calculation of the estimates, the results are not pushed out to the Storm Management windows by the engine. Instead, each Storm Management window that's open has its own timer that it uses to periodically retrieve the latest information from the engine automatically.

Non-Storm Mode Algorithm

For an event that resides in a control zone that is operating under non-storm mode, the calculation of its estimated assessment and estimated restoration times is as follows:

- Look up the historical average values that pertain to an event with its characteristics.
- Verify whether or not an assessment has already been made for the event (if JOBS.ACT_ASSESS_TIME is non-null).

If assessment has been made:

- The repair time assessment provided (JOBS.EST_REPAIR_MINUTES) will be used in the calculation rather than the historical Repair average.
- Verify whether or not a crew is currently onsite for this event.
- If a crew is onsite:
 - Check the crew type to verify whether or not this type of crew is one that can repair this event.
 - If crew can repair:
 - It is assumed that the crew that's onsite is there to perform the repair. The historical Travel to Repair average will not be used in the calculation. The actual repair time assessment (JOBS.EST_REPAIR_MINUTES) is added to the time at which the crew arrived onsite to generate the estimated restoration time (ERT) for the event.

- If crew cannot repair:
 - It is assumed that the onsite crew is there to perform the assessment, and another crew must be sent out to perform the repair. The historical Travel to Repair average and the actual repair time assessment are added to the time at which the repair time assessment was provided (JOBS.ACT_ASSESS_TIME) to generate the estimated restoration time (ERT) for the event.
- If a crew is not onsite:
 - The historical Travel to Repair average and the actual repair time assessment are added to the time at which the repair time assessment was provided (JOBS.ACT_ASSESS_TIME) to generate the estimated restoration time (ERT) for the event.

If no assessment has yet been made:

- Verify whether or not a crew is currently onsite for this event.
- If a crew is onsite:
 - Check the crew type to verify whether or not this type of crew is one that can both assess and repair this event.
 - If the crew type cannot perform both tasks:
 - Verify if the crew type can repair this event.
 - If crew can repair:
 - It is assumed that the crew that's onsite is there to perform the repair. The historical Travel to Repair average will not be used in the calculation. The historical Repair average is added to the time at which the crew arrived onsite to generate the estimated restoration time (ERT) for the event.
 - If crew cannot repair:
 - It is assumed that the crew that's onsite is there to perform the assessment. The historical Assess average is added to the time at which the crew arrived onsite to generate the estimated Assessment time (EAT). The historical Travel to Repair and historical Repair averages are added to the estimated Assessment time to generate the estimated restoration time (ERT) for the event.
 - If crew type can perform both tasks:
 - Verify whether or not assessment is required for this event (if Travel to Assess and Assess averages are both 0, assessment is not required).
 - If assessment is not required:
 - It is assumed that the crew that's onsite is there to perform the repair. The historical Travel to Repair average will not be used in the calculation. The historical Repair average is added to the time at which the crew arrived onsite to generate the estimated restoration time (ERT) for the event.
 - If assessment is required:
 - It is assumed that the crew that's onsite is there to perform the assessment. The historical Assess average is added to the time at which the crew arrived onsite to generate the estimated assessment time (EAT). The historical Travel to Repair and historical Repair averages are added to the estimated assessment time to generate the estimated restoration time (ERT) for the event.
- If a crew is not onsite:
 - Verify whether or not assessment is required for this event (if Travel to Assess and Assess averages are both 0, assessment is not required).

- If assessment is not required:
 - No estimated assessment time (EAT) needs to be calculated. This historical Travel to Repair and historical Repair averages are added to the simulation to generate the estimated restoration time (ERT) for the event.
- If assessment is required:
 - The historical Travel to Assess and historical Assess averages are added to the simulation to generate the estimated assessment time (EAT) for the event. The historical Travel to Repair and historical Repair averages are added to the estimated assessment time to generate the estimated restoration time (ERT) for the event.

Non-Storm Mode Algorithm Flow Chart

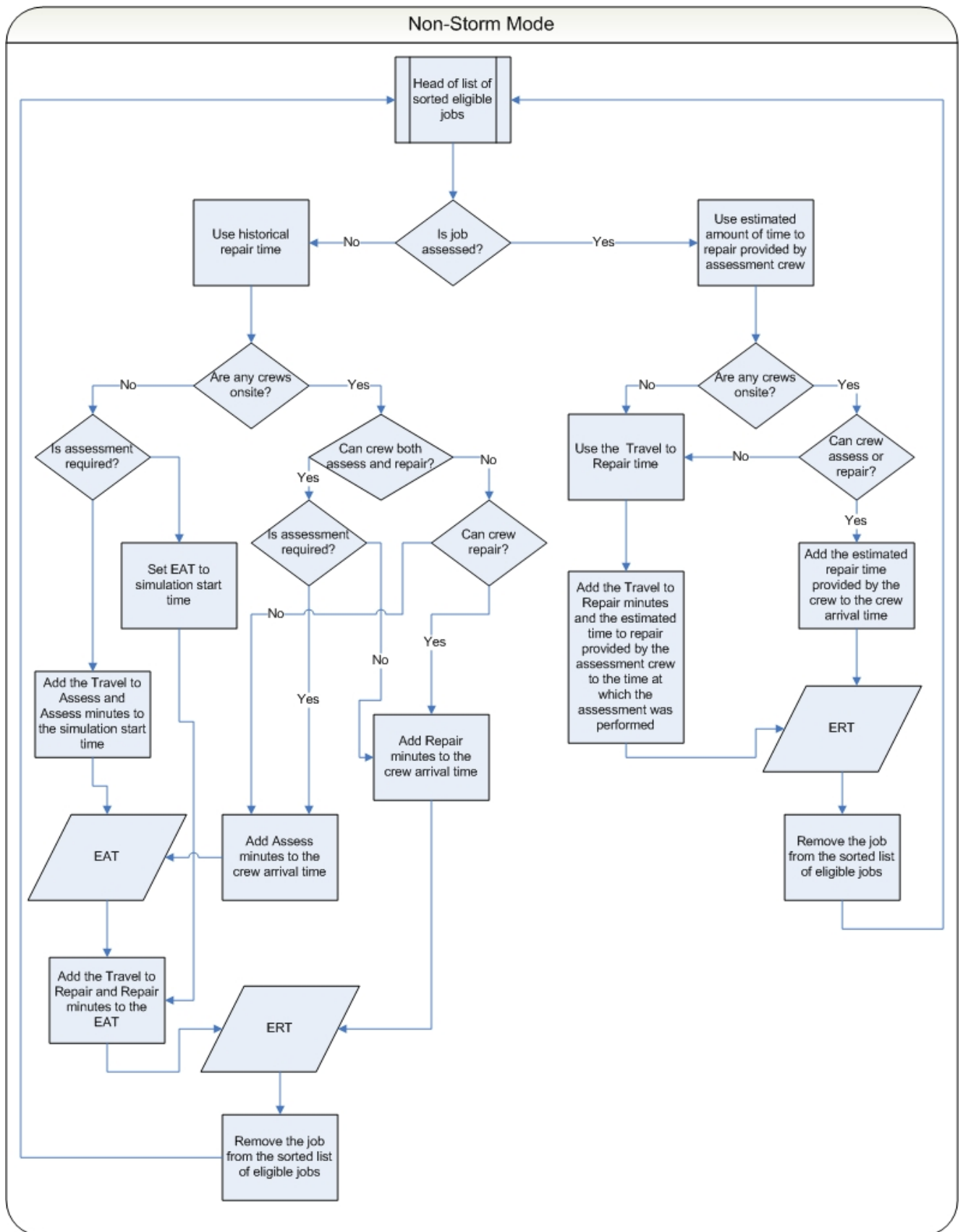

In summary, for an event that's in a control zone operating under non-storm mode:

- **Estimated assessment time** =
 - the time at which the simulation iteration started +
 - the historical average number of minutes it takes an assessment crew to arrive onsite +
 - the historical average number of minutes it takes a crew to perform assessment once onsite
- **Estimated restoration time** =
 - the estimated assessment time +
 - the historical average number of minutes it takes a repair crew to arrive onsite +
 - the historical average number of minutes it takes a crew to repair once onsite

Exceptions:

If a crew that can perform assessment is already onsite:

- **Estimated assessment time** =
 - The time at which the assessment crew arrived onsite +
 - the historical average number of minutes it takes a crew to perform assessment once onsite

If an event has an actual assessment provided and no repair crew is yet onsite:

- **Estimated restoration time** =
 - The time at which the actual assessment was provided +
 - the historical average number of minutes it takes a repair crew to arrive onsite +
 - the actual number of minutes it will take to repair, per the assessment

If an event has an actual assessment provided and a repair crew is already onsite:

- **Estimated restoration time** =
 - The time at which the repair crew arrived onsite +
 - the actual number of minutes it will take to repair, per the assessment =

If an event does not require assessment and no repair crew is yet onsite:

- **Estimated restoration time** =
 - The time at which the simulation iteration started +
 - the historical average number of minutes it takes a repair crew to arrive onsite +
 - the historical average number of minutes it takes a crew to repair once onsite

Note: When the historical averages are applied to the calculation, the average that applies to the conditions at the time the particular step is projected to begin is used, not the average that applies to the conditions at the time the simulation iteration began. For example, Shift A has a particular average value for repair, and Shift B has a different average value for repair. The simulation iteration is in Shift A, but the calculated estimated assessment time falls in Shift B. When calculating the estimated restoration time, the historical average value for repair that pertains to Shift B will be used, not that of Shift A, because the repair isn't projected to begin until sometime during Shift B.

Storm Mode Algorithm

The algorithm for estimate calculation in storm mode is similar to that of non-storm mode, except that in storm mode the data entered into the Crew Information table on the Storm Management window is taken into consideration and used as the known crew resource allocation. At the start of each simulation, the algorithm assembles a crew availability list from the Crew Information table and uses that to keep track of when the next available crews are projected to be ready as the calculation progresses.

For an event that resides in a control zone that is operating under storm mode, the calculation of its estimated assessment and estimated restoration times is as follows:

- Look up the historical average values that pertain to an event with its characteristics
- Verify whether or not an assessment has already been made for the event (if JOBS.ACT_ASSESS_TIME is non-null)

If assessment has been made:

- The repair time assessment provided (JOBS.EST_REPAIR_MINUTES) will be used in the calculation rather than the historical Repair average
- Verify whether or not a crew is currently onsite for this event
- If a crew is onsite:
 - Check the crew type to verify whether or not this type of crew is one that can repair this event
 - If crew can repair:
 - It is assumed that the crew that's onsite is there to perform the repair. The historical Travel to Repair average will not be used in the calculation. The actual repair time assessment (JOBS.EST_REPAIR_MINUTES) is added to the time at which the crew arrived onsite to generate the estimated restoration time (ERT) for the event
 - If crew cannot repair:
 - It is assumed that the onsite crew is there to perform the assessment, and another crew must be sent out to perform the repair. The historical Travel to Repair average and the actual repair time assessment are added to the time at which the first crew that is eligible to repair this event will become available to generate the estimated restoration time (ERT) for the event
- If a crew is not onsite:
 - The historical Travel to Repair average and the actual repair time assessment are added to the time at which the first crew that is eligible to repair this event will become available to generate the estimated restoration time (ERT) for the event. The historical Clean average is added to the ERT and used as the time at which that eligible crew is available to be used for another event in the simulation.

If no assessment has yet been made:

- Verify whether or not a crew is currently onsite for this event
- If a crew is onsite:
 - Check the crew type to verify whether or not this type of crew is one that can both assess and repair this event
 - If the crew type cannot perform both tasks:
 - Verify if the crew type can repair this event
 - If crew can repair:

- It is assumed that the crew that's onsite is there to perform the repair. The historical Travel to Repair average will not be used in the calculation. The historical Repair average is added to the time at which the crew arrived onsite to generate the estimated restoration time (ERT) for the event
- If crew cannot repair:
 - It is assumed that the crew that's onsite is there to perform the assessment. The historical Assess average is added to the time at which the crew arrived onsite to generate the estimated assessment time (EAT). The historical Travel to Repair and historical Repair averages are added to the time at which the first crew that is eligible to repair this event will become available to generate the estimated restoration time (ERT) for the event. The historical Clean average is added to the ERT and used as the time at which that eligible crew is available to be used for another event in the simulation.
- If crew type can perform both tasks:
 - Verify whether or not assessment is required for this event (if Travel to Assess and Assess averages are both 0, assessment is not required)
 - If assessment is not required:
 - It is assumed that the crew that's onsite is there to perform the repair. The historical Travel to Repair average will not be used in the calculation. The historical Repair average is added to the time at which the crew arrived onsite to generate the estimated restoration time (ERT) for the event
 - If assessment is required:
 - It is assumed that the crew that's onsite is there to perform the assessment. The historical Assess average is added to the time at which the crew arrived onsite to generate the estimated assessment time (EAT). The historical Travel to Repair and historical Repair averages are added to time at which the first crew that is eligible to repair this event will become available to generate the estimated restoration time (ERT) for the event
- If a crew is not onsite:
 - Verify whether or not assessment is required for this event (if Travel to Assess and Assess averages are both 0, assessment is not required)
 - If assessment is not required:
 - No estimated assessment time (EAT) needs to be calculated. The historical Travel to Repair and historical Repair averages are added to the time at which the first crew that is eligible to repair this event will become available to generate the estimated restoration time (ERT) for the event. The historical Clean average is added to the ERT and used as the time at which that eligible crew is available to be used for another event in the simulation.
 - If assessment is required:
 - The historical Travel to Assess and historical Assess averages are added to the time at which the first crew that is eligible to assess this event will become available to generate the estimated assessment time (EAT) for the event. The EAT is used as the time at which that eligible assessment crew is available to be used for another event in the simulation. The historical Travel to Repair and historical Repair averages are added to the time at which the first crew that is eligible to repair this event will become available to generate the estimated restoration time (ERT) for the event. The historical Clean average is added to the ERT and used as the time at which that eligible repair crew is available to be used for another event in the simulation.

Storm Mode Algorithm Flow Chart

The yellow boxes indicate where the storm mode algorithm differs from the non-storm mode algorithm.

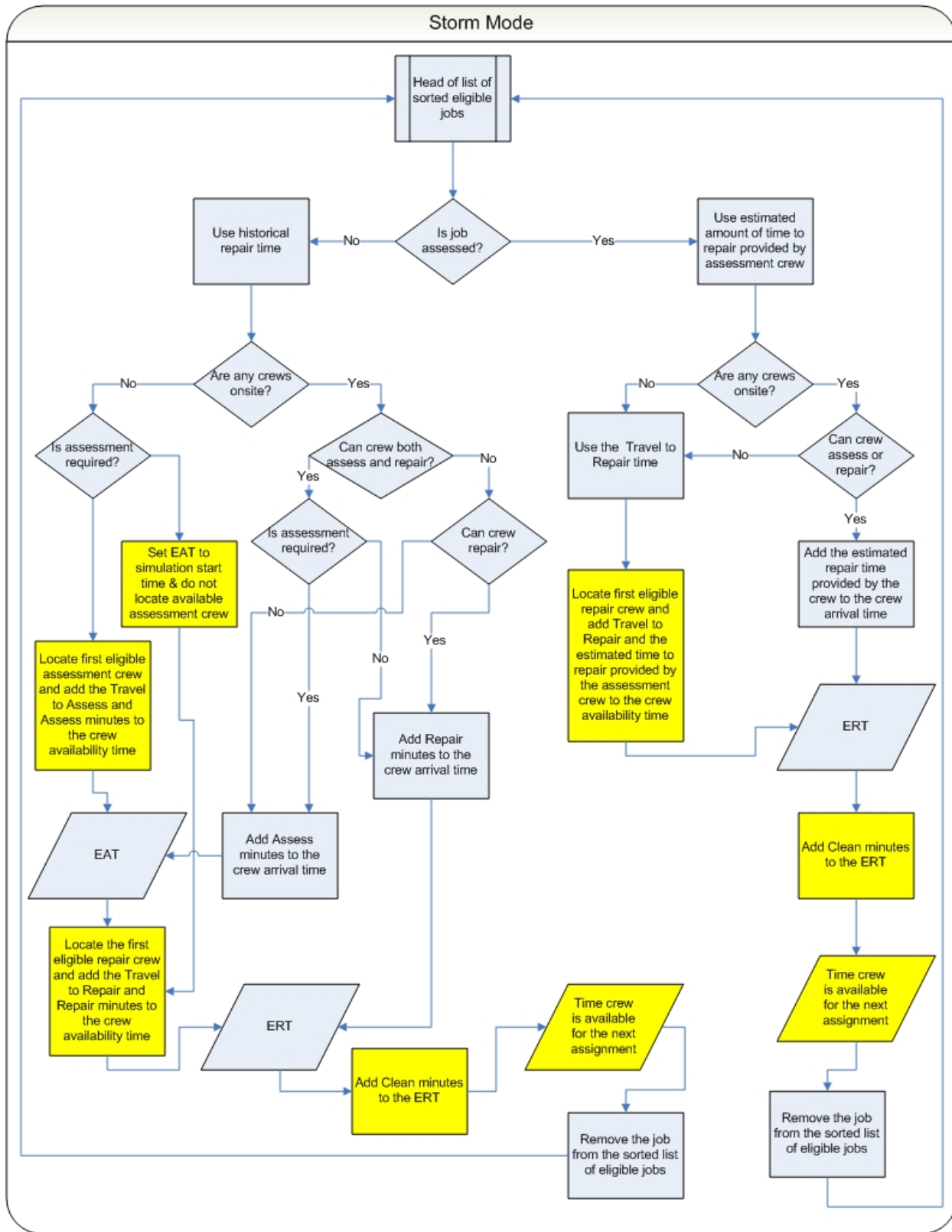

In summary, for an event that's in a control zone operating under storm mode:

Estimated assessment time =

- The time at which the first crew that's eligible to assess the event will become available +
- the historical average number of minutes it takes an assessment crew to arrive onsite +
- the historical average number of minutes it takes a crew to perform assessment once onsite

Estimated restoration time =

- The time at which the first crew that's eligible to repair the event will become available after the estimated assessment time +
- the historical average number of minutes it takes a repair crew to arrive onsite +
- the historical average number of minutes it takes a crew to repair once onsite =

Exceptions:

If a crew that can perform assessment is already onsite,

Estimated assessment time =

- The time at which the assessment crew arrived onsite +
- the historical average number of minutes it takes a crew to perform assessment once onsite

If an event has an actual assessment provided and no repair crew is yet onsite:

Estimated restoration time =

- The time at which the first crew that's eligible to repair the event will become available after the actual assessment time +
- the historical average number of minutes it takes a repair crew to arrive onsite +
- the actual number of minutes it will take to repair, per the assessment

Estimated restoration time =

- If an event has an actual assessment provided and a repair crew is already onsite,
- The time at which the repair crew arrived onsite +
- the actual number of minutes it will take to repair, per the assessment

If an event does not require assessment and no repair crew is yet onsite:

Estimated restoration time =

- The time at which the first crew that's eligible to repair the event will become available after the time at which the simulation iteration started +
- the historical average number of minutes it takes a repair crew to arrive onsite +
- the historical average number of minutes it takes a crew to repair once onsite

Notes:

- When the historical averages are applied to the calculation, the average that applies to the conditions at the time the particular step is projected to begin is used, not the average that applies to the conditions at the time the simulation iteration began. For example, Shift A has a particular average value for repair, and Shift B has a different average value for repair. The simulation iteration is in Shift A, but the calculated estimated assessment time falls in Shift B. When calculating the estimated restoration time, the historical average value for repair that pertains to Shift B will be used, not that of Shift A, because the repair isn't projected to begin until sometime during Shift B.
- If the algorithm finds that the calculated estimated assessment time or estimated restoration time would fall beyond the end of the shift of the first eligible crew by more than 60 minutes, it will go back and recalculate the estimate using a different crew other than the one that was originally chosen. The algorithm cannot split work for a single event between multiple shifts of the same crew or between multiple crews. As a consequence, if amount of work required for an event is more than the longest available shift of any crew capable of performing the work then the algorithm will not be able to provide a meaningful ERT for the event. At this point, the algorithm will use "default nominal crew" as a fall back mechanism in order to proceed. This is an artificial crew that can perform any work and not limited by shift restrictions. ERTs generated through use of "default nominal crew" are of no practical value and a warning is written into JMService log file each time this occurs.

Chapter 6

Service Alert Administration

This chapter describes the Oracle Utilities Network Management System - Service Alert Administration application. It covers the following topics:

- [Overview](#)
- [Logging In](#)
- [Using the Service Alert Administration Tool](#)

Overview

Oracle Utilities Network Management System - Service Alert Administration is an application that sends notifications to utility personnel via e-mail or text/SMS message. These notifications are triggered by "events" in Oracle Utilities Network Management System Web Trouble. For example, a notification could be used to alert a marketing staff member that an unplanned outage affects a critical customer. This would enable the marketing person to contact the customer to provide up to date information about the status of the outage. Similarly, an operations staff member could be notified about the outage while away from the office.

Note that Service Alerts for planned events use the Web Switching Management's Impacted Customers list from the corresponding switching sheet to determine which customers would be affected by a planned outage. The Impacted Customers list has to be generated for a switching sheet in order for Service Alert notifications to work. See [Using the Impacted Customers Tab](#) on page 8-52 for details on the Impacted Customer list.

As a notification engine, Service Alert provides for configurable delivery options through use of an administration tool, and dynamic message format control facilitated by XSL transformation of an XML-based message payload. This gives the administrator the ultimate power and flexibility in determining the routing and content of all notifications.

Service Alert Admin Login Window

The Login window is the first Service Alert Administration window you see. You must enter a valid user name and password, and then click the Validate button. Once your user name and password are validated, the system populates the option menu that allows you to select a user type.

The Login window displays the following fields and buttons:

- The **User ID** field allows you to enter the user name provided to you by the system administrator.
- The **Password** field allows you to enter the password provided to you by the system administrator.
- The **Validate** button verifies your login credentials. If the user name and password are not entered correctly, the system displays a warning dialog box.
- The **User Type** drop-down list contains the list of user types within your authority.
- The **Login** button allows you to complete the login process. Once you click the Login button, the Service Alert Administration window opens, based upon the User Type selected.
- The **Quit** button exits the Login window.

Logging In

To login to Service Alert Administration, complete these steps:

1. Depending on how your system was installed, either:
 - Click the **Service Alert** icon found under the appropriate program group in your Windows Start Menu, or
 - Double click the **Service Alert** icon on your desktop, or
 - Open a web browser and type the Service Alert URL in the browser's Address field. The Service Alert Administration Tool Login window displays.
2. Enter your user name.
3. Enter your password.
4. Click the **Validate** button. The bottom portion of the Service Alert Administration Tool Login window sensitizes.
5. Select the appropriate **User Type** from the drop-down list.
6. Click the **Login** button. The Service Alert Administration window opens.

Using the Service Alert Administration Tool

The **Service Alert Administration Tool** enables you to configure message delivery options. It provides the following features:

- [General Features](#)
- [Contact Manager](#)
- [Group Manager](#)
- [Parameter Manager](#)
- [Utility Customer Manager](#)
- [Attribute Manager](#)

General Features

User Menu

The User Menu provides options to set preferences and log out of Service Alerts

Preferences Menu

The **Preferences** menu allows you to control certain common features of the Web Workspace.

| Menu Option | Description |
|-------------------------------|---|
| Smaller Font | Decreases the font size in text and icons. Repeat to further decrease the font size. |
| Bigger Font | Increases the font size in text and icons. Repeat to further increase the font size. |
| Reset Font | The application will reset the text and icons to use their default font size. |
| Save Preferences | Saves the current column selection settings as the user's preference. Column selection is available in the Contact Manager , Parameter Manager , and Attribute Manager tabs. |
| Restore Preferences | Restores the default column selections. |
| Change Color Scheme... | Opens the Change Color Scheme dialog box, which allows you to select from different user interface coloring schemes. The options are a Light scheme, a Dark scheme, and the default High Definition scheme. Unlike other user preferences, these apply to all environments for the user on the machine. |

Help Menu

The options in the Help menu are available at all times. The following table describes the Help Menu options.

| Option | Description |
|---------------------------|--|
| Service Alert Help | Opens the Online Help content for Service Alert. |

| Option | Description |
|---------------------|---|
| Email Log Files... | Gathers the environment's log files and attaches them to a new email message using your default email client. The log files can then be sent to your support team or contact for further analysis. |
| Set Debug... | Launches the Set Debug dialog box allowing you to set debug on or off within your current environment. This is used for debugging and analysis purposes. See Setting Debug on page 10-33 for more information. |
| About Service Alert | Opens a dialog box that displays information regarding what version of the application is presently running, as well as version and other information about the Oracle Utilities Network Management System Web Gateway that the application is using. |

Contact Manager

The Contact Manager tab allows you to perform the following tasks:

- [Adding a Contact](#)
- [Editing a Contact](#)
- [Removing a Contact](#)

For a description of the fields and buttons on this tab, see the following topic.

Contact Manager Tab

The Contact Manager tab is used to add, edit, or remove contact information. The contact information contains identification information to associate each entry with an individual, as well as details regarding contacting the individual when a notification occurs. Note that an individual may have many contact entries. All contact entries in the system are listed in the Contacts table. Disabled contacts cannot receive notifications.







The Contact Manager tab displays the following fields and buttons:

- The **Contacts** panel lists company contacts that have been added through the Contact Manager. The table row colors correspond to whether a contact is active (white) or inactive (bluish gray). Rows in the table can be sorted in ascending or descending order by clicking on any column header.

The columns displayed are user selectable by right-clicking the table heading area and select or deselect the list of available columns in the **Select Columns to Display** dialog box. Once the columns have been chosen, you may save the choices for your subsequent sessions by selecting **Save Preferences** from the **Preferences** menu; if not saved, the default columns will be displayed when you log in again. See [Preferences Menu](#) on page 6-3 for details on saving and restoring column selections.

The default product configuration displays the following columns:

- The **Contact ID** column contains the contact's identification number.
- The **Name** column contains the contact's name.
- The **Email** column contains the contact's email address.
- The **Active** columns contains the **Y** or **N** Active status.
- The **Email** column contains the contact's email address.
- The **Text/SMS** column contains the contact's SMS number.

- The **Printer** column contains the contact's printer name.
- The **Script** column contains the script identifier used to deliver notifications to the contact.
- The **Add** button () activates the editable fields in the Contact Information panel, which allows you to add a new contact.
- The **Edit** button () allows the user to edit contact information for the contact selected in the Contacts table.
- The **Remove** button () removes the currently selected contact parameter from the system.
- The **Print** button () opens the Print Preview window that allows you to print the contact list.
- The **Contact Information** panel is where the details for a contact are entered and/or edited.
 - The **Name** field contains the contact's name. This field can be edited when in add/edit mode. For sorting purposes, it is recommended that names be entered in "Last name, First Name" type format.
 - The **Contact ID** field contains a unique identifier that is useful for identifying an individual, particularly when that individual has more than one contact entry. Sorting on the External ID allows for quick viewing of all an individual's contact entries. A work phone number (possibly concatenated with a phone extension) could be used, for example.
 - The **Current Groups** field contains the groups to which this contact belongs. This field is not editable by the user, although group memberships can be modified on the Group Manager panel.
 - The **Email** field contains the contact's email address. This field can be edited when in add/edit mode.
 - The **Printer** field contains the contact's printer name. This field can be edited when in add/edit mode.
 - The **Text/SMS** field contains the contact's SMS number. This field can be edited when in add/edit mode. This value will be the email alias for the contact's SMS device. The button next to the field allows the user to browse for a text messaging provider to assist in constructing the SMS device address string.
 - The **Search** button () opens the Select Text Message Provider dialog box. This dialog box provides a convenient means for select a text messaging provider used in constructing the email alias for an SMS device.
 - The **Script** drop-down list allows you to select a script that is used to deliver notifications to the contact.
 - The **Active** check box enables/disables the contact entry. Disabled contacts do not receive notifications.
- The **Save** button () saves the contact information currently being added/edited to the database.
- The **Cancel** button () cancels the current add/edit operation.

Adding a Contact

To add a contact, complete these steps:

1. Click the **Contact Manager** tab on the Service Alert Administration Tool.
2. Click the **Add** button. The appropriate fields in the Contact Information section become enabled.
3. Fill in the following fields: **Name**, **Contact ID**, **Email** (optional), **Text/SMS** (optional), **Printer** (optional), **Script** (optional), and **Active**. The **Save** button becomes enabled.
4. If necessary, select a text messaging provider. See the next section for instructions regarding selecting a text messaging provider.
5. Click the **Save** button to save the contact information.

At least one of the following fields needs to be populated: **Email**, **Text/SMS**, **Printer**, and/or **Script**.

Editing a Contact

To edit a contact, complete these steps:

1. Click the **Contact Manager** tab on the Service Alert Administration Tool.
2. Click on a row in the **Contacts** table. This row represents the contact to be edited.
3. Click the **Edit** button. The appropriate fields become enabled.
4. Modify one or more of the following fields: **Name**, **Contact ID**, **Email**, **Text/SMS**, **Printer**, and **Active**.
5. If necessary, select a text messaging provider. See [Selecting a Text Messaging Provider](#) on page 6-6 for instructions regarding selecting a text messaging provider.
6. Click the **Save** button to save the contact information.

Note: At least one of the following fields needs to be populated: **Email**, **Text/SMS**, **Printer**, and/or **Script**.

Selecting a Text Messaging Provider

To select a text messaging provider, complete these steps:

1. Click on the **Search** icon next to the **Text/SMS** field. The Select a Text Messaging Provider dialog box appears.
2. Click on a row in Text Message **Providers** table. This row represents the text messaging provider to be chosen. The Text Message Providers table contains the following columns:
 - **Provider** – The name of the text messaging provider company.
 - **Prefix** – A description of how an email alias for the SMS device is constructed. Typically, a sample prefix will be concatenated with the domain name.
 - **Domain Name** – The domain name used to construct the email alias for the SMS device.
3. Click **OK** to choose the selected text messaging provider, or **Cancel** to dismiss the dialog box without selecting a provider. The Select Text Message Provider dialog box closes.
4. Edit the **Text/SMS** field as appropriate.

Note: The text messaging provider table is populated during the system installation. If you need to add, edit, or modify text messaging provider information, then contact your system administrator.

Removing a Contact

To remove a contact, complete these steps:

1. Click the **Contact Manager** tab on the Service Alert Administration Tool.
2. Click on a row in the **Contacts** table. This row represents the contact to be removed.
3. Click the **Remove** button. The Remove Contact dialog box opens.
4. Click **Yes** to remove the contact from the system, or **No** to avoid removing the contact from the system.

Group Manager

The Group Manager tab on the Service Alert Administration Tool window is used to add, edit or remove contact groups, as well as specify the notification format for a group based on each notification type. A group is used in defining notification parameters. A notification parameter is the definition of a rule used to trigger a notification. Every parameter requires a group of contacts to be specified. This group specifies the intended recipients of a notification.

From the Group Manager tab, you can perform the following tasks:

- [Adding a Group](#)
- [Removing a Group](#)
- [Adding a Contact to a Group](#)
- [Removing a Contact from a Group](#)
- [Modifying the Message Transformation File](#)

For a description of the fields and buttons on this tab, see the following topic.

Group Manager Tab

The Group Manager tab contains the following information:

- The **Groups** panel displays a list of all groups in the system. A group does not need to contain any contacts, nor does it need to be associated with a notification parameter.
 - The **Add** button on the Groups panel opens the **Add Group** dialog box. This dialog box allows a new, empty group to be created. Each group must have a unique name.
 - The **Remove** button on the Groups panel deletes the group from the database. This will also delete all parameters associated with the group, but contacts that are members of the group are not deleted.
- The **Contacts** panel displays a list of the individual members in the selected group.
 - The **Add** button on the Contacts panel opens the **Add Contact** dialog box. This dialog box allows contacts to be added to the selected group.
 - The **Remove** button on the Contacts panel removes the selected contact from the selected group.
- The **Message Types** panel displays a list of the available notification message types that the selected group can receive.
- The **Message Formats** panel contains information regarding the transforms for the selected message type.
 - The **Email** field displays the transform, in the form of an XSL file, that will be applied to the notifications of the selected notification type bound for an email destination corresponding to members of the selected group.

- The **Text/SMS** field displays the transform, in the form of an XSL file, that will be applied to the notifications of the selected notification type bound for a Text/SMS destination corresponding to members of the selected group.
- The **Printer** field displays the transform, in the form of an XSL file, that will be applied to the notifications of the selected notification type bound for a printer destination corresponding to members of the selected group.
- The **Script** field displays the transform, in the form of an XSL file, that will be applied to the notifications of the selected notification type bound for a script destination corresponding to members of the selected group. Leaving the **Script** field empty would cause raw XML to be delivered to the script.
- The **Modify Transformation** button saves the XSL file information to the database for the selected group and notification type.

Note: You must verify that the specified XSL file is available in the designated location.

Adding a Group

To add a group, complete these steps:

1. Click the **Group Manager** tab on the Service Alert Administration Tool.
2. Click the **Add** button. The Add Group dialog box opens.
3. Enter a group name in the Group Name text field.
4. Click **OK** to create a group, or **Cancel** to avoid creating the group.

Removing a Group

To remove a group, complete these steps:

1. Click the **Group Manager** tab on the Service Alert Administration Tool.
2. Click on a group on the **Groups** list. The highlighted group is the group to be removed.
3. Click the **Remove** button. A confirmation dialog box opens.
4. Click **Yes** to remove the group, or **No** to avoid removing the group.

Adding a Contact to a Group

To add a contact to a group, complete these steps:

1. Click the **Group Manager** tab on the Service Alert Administration Tool.
2. Click on a group on the **Groups** list. The highlighted group is the group to which a contact will be added.
3. Click on the **Add** button. The Select Contact dialog box opens. The Contacts table in the Select Contact dialog box displays all the contacts in the system that do not belong to the selected group.
4. Click on a row in the Contacts table. The Contacts table contains the following columns:
 - **ID** – System assigned unique id for the contact.
 - **External ID** – A unique identifier that is useful for identifying an individual, particularly when that individual has more than one contact entry. Sorting on the External ID allows for quick viewing of all an individual's contact entries, for example, Employee ID.
 - **Name** – The contact's name.
 - **Email** – The contact's email address.
 - **Text/SMS** – The contact's SMS device address.

- **Active** – A flag to indicate whether or not the contact is enabled in the system. Disabled contacts cannot receive notifications. Note that the table row colors correspond to whether a contact is active (white) or inactive (light blue).
 - **Printer** – The contact's printer name.
5. Click **OK** to add the selected contact to the group, or **Cancel** to avoid adding the contact to the group.

Removing a Contact from a Group

To remove a contact from a group, complete these steps:

1. Click the **Group Manager** tab on the Service Alert Administration Tool.
2. Click on a group on the **Groups** list. The highlighted group is the group from which a contact will be removed. The Contacts list displays the contacts in the selected group.
3. Click on a contact on the **Contacts** list. This is the contact to be removed.
4. Click the **Remove** button. The Remove Contact From Group dialog box opens.
5. Click **Yes** to remove the contact from the group, or **No** to avoid removing the contact from the group.

Modifying the Message Transformation File

To modify the transform for a given group and notification type, complete these steps:

1. Click the **Group Manager** tab.
2. Select a group in the **Groups** list. The transformation filename will be modified for the selected group.
3. Click on a notification type in the **Message Type** list. The highlighted type will be the notification type for which the transformation filename will be modified. The Email, Text/SMS, Printer, and Script transformation filename fields display default values for each transformation.

Note: The available Message Formats are configured in the publisher_transformations table, which is populated by the ces_core_publisher.sql file.

4. Modify the filenames associated with each transform.
5. Click **Modify Transformation** to save the filenames to the database.

Parameter Manager

The Parameter Manager tab is used to add, edit, or remove notification triggering parameter information. A notification triggering parameter is the rule for defining a notification trigger within Service Alert. A parameter consists of a name, a threshold value, a group to notify when a violation occurs, and an associated control zone, asset, or customer. Inactive parameters cannot be violated, and therefore will never trigger a notification.

The Parameter Manager tab allows you to perform the following tasks:

- [Adding a Customer Count Parameter](#)
- [Adding a Specific Customer Parameter](#)
- [Adding a Frequency of Outages Parameter](#)
- [Adding a Storm Affecting Control Zone Parameter](#)
- [Editing a Parameter](#)
- [Removing a Parameter](#)

For a description of the fields and buttons on this tab, see the following topic.

Parameter Manager Tab

The Parameter Manager tab contains two panels:

- [Parameters Panel](#)
- [Parameter Information Panel](#)

Parameters Panel

The Parameters Panel displays the following fields and buttons:

- The **Parameters** panel lists all parameters in the system. Note that the table row colors correspond to whether a parameter is active (white) or inactive (bluish gray). For convenience, the rows in the table can be sorted in ascending or descending order by clicking on any column header.

The columns displayed are user selectable by right-clicking the table heading area and selecting or deselecting the list of available columns in the **Select Columns to Display** dialog box. Once the columns have been chosen, you may save the choices for your subsequent sessions by selecting **Save Preferences** from the **Preferences** menu; if not saved, the default columns will be displayed when you relogin. See [Preferences Menu](#) on page 6-3 for details on saving and restoring column selections.

The default product configuration displays the following columns:

- The **Name** column contains a descriptive name given to the parameter.
- The **Type** column contains the notification type on which the parameter is based.
- The **Value** column contains the threshold value used in determining if a parameter violation has occurred. The units for this value are based on the notification type. For example, the parameter value unit of for the "Outage" notification type is "number of customers out." The "Outage affecting critical customer(s)" notification parameter value unit is "number of critical customers out."
- The **Contact Groups** column contains the group of contacts to be notified when a parameter violation occurs.
- The **Control Zones** column contains the control zones to which the parameter applies.
- The **Asset Class(es)** column contains the types of assets to which the parameter applies, if applicable.

- The **# Assets** column contains the number of asset aliases associated with the parameter, if applicable.
Note: A parameter must specify either a control zone or a list of assets, but not both.
- The **# Accounts** column contains the count of customer account numbers associated with the parameter, if applicable.
- The **Duration** column contains the time interval associated with the parameter, if applicable. This is the minimum outage duration (in seconds) before the notification is triggered.
- The **Max ERT Notifications** column contains the maximum number of notifications that will be delivered when there are ERT updates.
- The **Event Types** column contains the names of the specific event types this notification will be triggered for.
- The **Event States** column contains the names of the specific event states that this notification will be triggered for. (Currently only used for Specific customer affected by unplanned outage notification.)
- The **Use Event States** column contains a flag to indicate whether the Event State trigger is active for the parameter.
- The **Customer Types** column contains the critical customer types used in calculations for the associated notification.
- The **Crew Types** column contains the names of the specific crew types the notification will be triggered for; this only applies when **Crew Action** trigger is selected.
- The **Crew States** column contains the names of the specific crew states (**Assigned, En-Route, Onsite, Suspended**) the notification will be triggered for; this only applies when **Crew Action** trigger is selected.
- The **Planned** column displays Y if notification should only be triggered for planned events.
- The **Disable During Storm** column contains a flag to indicate whether parameter violation should be suppressed when the associated control zone is in storm mode or the associated asset resides in a control zone that is in storm mode. Storm modes are defined as part of Web Trouble configuration (rule sets applied to a control zone in the Authority tool).
- The **Duration** column contains the minimum outage duration (in hh:mm:ss format) required for the outage to trigger a notification.
- The **Add** button activates the editable fields in the Parameter Information panel, which allows you to add a new parameter.
- The **Edit** button allows you to edit the currently selected parameter.
- The **Remove** button removes the currently selected parameter from the system.
- The **Export Table** button allows you to save the Parameter Information table data as a CSV file.

Parameter Information Panel

The Parameter Information Panel is where the details for a parameter are entered and/or edited. The Parameter Information Panel displays the following fields and buttons:

Note: The fields and buttons on this panel vary depending on the type of notification.

- The **Name** field displays the descriptive name given to the parameter. This value can be modified when in add/edit mode.
- The **Select Contact Groups...** button brings up the Select Contact Groups dialog box for selecting one or more groups to be notified when the parameter is violated. You can use the Control key in conjunction with the left mouse button to make multiple selections or deselect a group in the Select Contact Groups dialog box. This button is enabled when in add/edit mode.
- The **Type** field displays a list of enumerated notification types to which this parameter applies. This value can be selected when in add/edit mode.
 - Outage
 - Outage Affecting Critical Customer(s)
 - Outage Affecting Specific Customer(s)
 - Frequency of Outages on an Asset
 - Storm Affecting Control Zone
- The **Value** field displays the parameter threshold value. This value can be modified when in add/edit mode.
- The **Number of Selected Accounts** field displays the number of customer account numbers associated with the parameter, if applicable. This field is not editable.
- The **Select Accounts...** button displays the Select Accounts dialog box, allowing you to search for customer accounts to associate with the parameter, if applicable.
- The **Event Type** radio group allows you to select whether notification should be triggered by Planned or Unplanned events. This is only displayed for outage-type notifications.
 - The **Select Event Types...** button opens the Select Event Types dialog box that allows you to select one or more event types that will trigger the notification when the parameter is violated. When multiple event types are selected, a notification will only be triggered the first time one of the selected event types is met. This button is enabled in add/edit mode when Unplanned Event Type is selected.
- The **Trigger** group allows you to select the event status that will trigger the notification. This group may contain one or more of the following options:
 - **Scheduled** - This check box is enabled only for outage notifications where the Event Type is Planned. If this is checked, the system will generate a notification when a switching sheet reaches the scheduled state, provided that other notification conditions are met.
 - **Started/In-Progress** - This check box is enabled only for outage notifications. If this is checked, the system will generate a notification when a planned or unplanned outage is started, provided that other notification conditions are met.
 - **Restored** - This check box is enabled only for outage notifications. If this is checked, the system will generate a notification when a planned or unplanned outage is restored, provided that other notification conditions are met.
 - **Cancelled** - This check box is enabled only for outage notifications. If this is checked, the system will generate a notification when a switching sheet reaches cancelled state or

when an unplanned outage is cancelled, provided that other notification conditions are met.

- **ERT Updated** - If checked, the system will generate a notification when an ERT is manually updated for an outage, provided that other notification conditions are met.
- **Crew Action** - This check box is enabled only for outage notifications. If selected, the system will generate a notification when the specified crew type and crew state are met provided that other notification conditions are also met. The notification will be triggered only the first time an event has been observed to be in a particular crew state (for example, if a parameter specifies crew types of **Service** and **Trouble** and the crew state is **Assigned**, notification for a particular event will be generated only the first time a **Service** or **Trouble** crew is assigned to the event).
- **Storm Started** - This check box is enabled only if the notification type is **Storm Affecting Control Zone**. If this is checked, the system will generate notification when storm has been created in Storm Management tool.
- **Storm Updated** - This check box is enabled only if the notification type is **Storm Affecting Control Zone** and **Storm Started** check box is checked. If this is checked, the system will generate notification when information for an existing storm has been updated in Storm Management tool.
- **Storm Ended** - This check box is enabled only if the notification type is **Storm Affecting Control Zone**. If this is checked, the system will generate notification when storm has been marked as ended in Storm Management tool.
- The **Select Crew Types...** button displays the **Select Crew Types** dialog box, allowing you to select crew types to associate with the parameter; this is only available when **Crew Action** trigger is selected.
- The **Select Crew States...** button displays the **Select Crew States** dialog box, allowing you to select crew states to associate with the parameter; this is only available when **Crew Action** trigger is selected.
- The **Duration** field allows you to enter the minimum outage duration (in hh:mm:ss format) required to trigger a notification. If an outage meets all the conditions for notification, but does not have sufficient duration, the system will delay the notification until the required outage duration has been reached. Duration of 0 seconds means that notification should be generated regardless of the outage duration. This field is only available for notification types: **Outage**, **Outage Affecting Critical Customers**, and **Outage Affecting Specific Customers**. Duration check is not applicable to **Master Switching Jobs**.
- The **Max ERT Notifications** field allows you to enter the maximum number of ERT updated notifications to be triggered for an event.

Notes:

- The **Max ERT Notifications** field is only visible when **Outage**, **Outage affecting critical customers**, or **Outage affecting specific customer types** are selected.
- It is editable only when **ERT Updated** is selected in the Trigger pane.
- By default, it is populated with the *ertMaxUpdates* SRS configuration rule (see [Using the Event Management Rules Tab](#) on page 10-13 for details on configuring SRS rules).
- The **Number of Selected Assets** field displays the number of asset aliases associated with the parameter, if applicable. This is non-editable field.
- The **Select Assets...** button displays the **Select Assets** dialog box, allowing you to search for assets to associate with the parameter, if applicable.

- The **Asset Class(es)** field displays the classes or types of assets to which the parameter applies. This value can be modified when in add/edit mode, depending upon the type of notification selected.
 - The **Select Asset Classes...** button displays the Select **Asset** Classes dialog box, allowing you to select asset types to associate with the parameter, if applicable.
 - The **Clear** button clears the **Asset Class(es)** field.
- The **Control Zones** field displays the control zones of the asset to which the parameter applies. This value can be modified when in add/edit mode.
 - The **Select Control Zones...** button displays the Select Control Zones dialog box, allowing you to associate the parameter with a control zone, if applicable.
 - The **Clear** button clears the Control Zones field.

Note: A parameter must specify either control zone or an asset, but not both.
- Click the **Use Event States** check box if you want to select specific event states that will trigger the notification when the parameter is violated. If checked, the **Select Event States...** button is enabled.
 - The **Select Event States...** button brings up the Select Event States dialog box for selecting one or more event states. You can use the Control key in conjunction with the left mouse button to make multiple selections or deselect a group in the Select Event Types dialog box. This button is enabled when in add/edit mode.
- The **Time Interval** field displays the time interval value associated with the parameter. This value can be modified when in add/edit mode, depending upon the type of notification selected.
 - The **Specify Time Interval** button displays the Specify Time Interval dialog box, allowing you to specify what time interval should be used for the parameter, if applicable.
 - The **Clear** button to the right of the Specify Time Interval button clears the Time Interval field when pressed.
- The **Disable During Storm** check box allows you to enable/disable the parameter during storm mode.
- The **Active** check box allows you to enable/disable the parameter.
- The **Select Customer Types...** button allows you to select one or more customer types to be considered in the calculations for the notification. This button is displayed only for notifications that involve critical customers.

When you click this button, the Select Customer Type dialog box opens. Select the customer types to include, then click **OK**.

Note: If a customer belongs to more than one of the selected customer types, the customer is only counted once in the calculation.
- The **Save** button saves the parameter information.
- The **Cancel** button cancels an add/edit parameter operation.

About Parameter Values

A parameter must have certain required data specified before it may be saved. A parameter consists of a name, a threshold value, a group to notify when a violation occurs, and an associated control zone, asset, or customer. The parameter value has a different meaning in the context of each of the various notification types.

The following table gives the units for each notification type.

| Notification Type | Parameter Value Unit |
|-------------------------------------|---------------------------------------|
| Outage | Number of customers affected |
| Outage affecting critical customers | Number of critical customers affected |
| Outage affecting specific customer | N/A |
| Frequency of outages on an asset | Number of outages |
| Storm affecting control zone | N/A |

Note: A group must exist to save the parameter. Use the Group Manager tab to create a group if one does not already exist.

Different notification types have different additional data required. The following table lists the other required values for each notification type.

| Notification Type | Other Required Information |
|-------------------------------------|---|
| Outage | Event Type, Trigger, at least one asset alias or Control Zone, or Asset Class and Control Zone |
| Outage affecting critical customers | Event Type, Trigger, at least one asset alias or Control Zone, or Asset Class and Control Zone. |
| Outage affecting specific customer | Event Type, Trigger, at least one customer account number. |
| Frequency of outages on an asset | Time Interval, at least one asset alias, or Asset Class and Control Zone |
| Storm affecting control zone | Trigger, Control Zone |

Adding a Customer Count Parameter

To add either an Outage notification parameter or an Outage affecting critical customers notification parameter, complete these steps:

1. Click the **Parameter Manager** tab on the Service Alert Administration Tool.
2. Click the **Add** button. The appropriate fields on the Parameter Information panel become enabled.
3. Enter a descriptive name for the parameter into the **Name** field.
4. Click the **Select Contact Groups...** button. The Select Contact Groups dialog box appears.
5. Select one or more groups to be notified when the parameter is violated from the Select Contact Groups dialog box.
6. Click the **OK** button on the Select Contact Groups dialog box. The Select Contact Groups dialog box disappears.
7. Select either "1. Outage" or "2. Outage affecting critical customer(s)" from the **Type** context menu.
8. In the **Value** field, enter a number that represents the number of customers that must be out in order to trigger the notification.
9. Select either Unplanned or Planned from the **Event Type** options.
10. To limit the types of events that can trigger the notification, click the **Select Event Types...** button, then make your selection in the Select Event Types dialog box. If no selection is made, then the notification is triggered by all event types.
11. Select one or more check boxes in the **Trigger** section to specify when this notification should be triggered.
12. Either specify a list of assets or list of asset classes and a list of control zones for the parameter. This is used in conjunction with the Value in order to trigger the notification.
 - a. To specify an asset, do the following:
 - Click the **Select Assets...** button. The Select Assets dialog box opens.
 - Click the **Add** button to open the Asset Search dialog box. Enter your search criteria into the Search Text field.
 - Click the **Search** button. The search results are displayed in the table.
 - Select the desired assets from the table and click **OK**. The Select Assets dialog box is populated with rows for each selected asset.
 - Newly added rows have a green background.
 - Rows can be removed from the Select Assets dialog box using the **Remove Asset** button. Rows scheduled for removal have a red background.
 - The **Undo Changes** button reverts all changes made to the list of assets in the Select Assets dialog box.
 - Click **OK** to close the Select Assets dialog box. The Number of Selected Assets will be updated with the count of selected assets.

- b. To specify asset classes and control zones, do the following:
 - Select Asset Classes
 - Click the **Select Asset Classes...** button. The Select Asset Classes dialog box opens.
 - Select the asset classes in the tree pane. You may click Expand All to show all asset classes in the tree and click **OK**. The Select Asset Classes dialog box will close and the Asset Class(es) field will be populated with the selected asset class names.
 - Select Control Zones
 - Click the **Select Control Zones...** button. The Select Control Zones dialog box opens.
 - Select the desired control zones from the tree, and click **OK**. The Select Control Zones dialog box will close and the Control Zones field will be populated with the name of the selected control zones.
13. Select/deselect the **Use Event States**, **Disable During Storm**, and **Active** check boxes, as desired.
14. If the **Crew Action** trigger is selected, use the **Select Crew Types...** and **Select Crew States...** buttons to select the crew types and crew states that can trigger the notification.
15. Click the **Save** button to save the parameter.

Adding a Specific Customer Parameter

To add an Outage affecting a specific customer parameter, complete these steps:

1. Click the **Parameter Manager** tab on the Service Alert Administration Tool.
2. Click the **Add** button. The appropriate fields on the Parameter Information panel become enabled.
3. Enter a descriptive name for the parameter into the **Name** field.
4. Click the **Select Contact Groups...** button. The Select Contact Groups dialog box appears.
5. Select one or more groups to be notified when the parameter is violated from the **Select Contact Groups** dialog box and click **OK**. The Select Contact Groups dialog box disappears.
6. Select "3. Outage affecting specific customer notification" from the **Type** drop-down list.
7. Select either Unplanned or Planned from the **Event Type** radio group.
8. To limit the types of events that can trigger the notification, click the **Select Event Types...** button, then make your selection in the Select Event Types dialog box. If no selection is made, then the notification is triggered by all event types.
9. Select one or more check boxes in the **Trigger** section to specify when this notification should be triggered.
10. Click the **Select Accounts...** button to bring up the Select Accounts dialog box.
11. Click the **Add Account** button to bring up the Account Search dialog box.
12. Select a search criterion on the **Search Parameter** drop-down list.
13. Enter text into the **Search Text** field according to the search criterion selected in the previous step.
14. Click the **Search** button. The search results are displayed in the table.

15. Select the desired accounts from the table and click **OK**. The Account Search dialog box disappears and rows for the selected account numbers are added to the Select Accounts dialog box.
 - Newly added rows have a green background.
 - Rows can be removed from the Select Accounts dialog box using the **Remove Account** button. Rows scheduled for removal have a red background.
 - The **Undo Changes** button reverts all changes made to the list of account in the Select Accounts dialog box.

Once satisfied with the list of accounts click **OK**. The Select Accounts dialog box disappears, and the Number of Selected Accounts field is populated with the number of distinct account numbers from the Select Accounts dialog box.
16. Select/deselect the **Use Event States**, **Disable During Storm**, and **Active** check boxes as desired.
17. If the **Crew Action** trigger is selected, use the **Select Crew Types...** and **Select Crew States...** buttons to select the crew types and crew states that can trigger the notification.
18. Click the **Save** button to save the parameter.

Adding a Frequency of Outages Parameter

To add a Frequency of Outages on an Asset Notification parameter, complete these steps:

1. Click the **Parameter Manager** tab on the Service Alert Administration Tool.
2. Click the **Add** button. The appropriate fields on the Parameter Information panel become enabled.
3. Enter a descriptive name for the parameter into the **Name** field.
4. Click the **Select Contact Groups...** button. The Select Contact Groups dialog box appears.
5. Select one or more groups to be notified when the parameter is violated from the **Select Contact Groups** dialog box.
6. Click the **OK** button on the Select Contact Groups dialog box. The Select Contact Groups dialog box disappears.
7. Select "5. Frequency of outages on an asset notification" from the **Type** drop-down list.
8. Enter a number in the **Value** field that represents the number of outages there must be in order to trigger the notification.
9. If desired, click the **Select Event Types...** button to bring up the Select Event Types dialog box to limit the types of events that can trigger the notification. If no selection is made, then the default is all event types.
10. Click the **Specify Time Interval** button to bring up the Specify Time Interval dialog box. Specify a time interval either as a certain number of hours/days/weeks/years.

To specify the time interval as having a specific begin date, complete these steps:

- Select the **Begin Date** radio button on the Specify Time Interval dialog box. The Calendar button becomes enabled.
- Click on the **Calendar** button. The Calendar dialog box appears.
- Specify the desired begin date and time in the Calendar dialog box, then press the **OK** button. The Calendar dialog box disappears, and the selected date/time now appears in the field next to the Begin Date radio button.

To specify the time interval as a certain number of hours/days/weeks/years, complete these steps:

- Select the **Time Window** radio button. The text field and drop-down list become enabled.
 - Select the desired unit of time from the drop-down list and enter the desired number of units into the text field.
 - Click the **OK** button on the Specify Time Interval dialog box. The Specify Time Interval dialog box disappears, and the Time Interval field is populated with the interval that was specified.
11. Either specify a list of assets or a list of asset classes and list of control zones for the parameter. These are used in conjunction with the Value and Time Interval in order to trigger the notification.

To specify a list of assets, do the following:

- Click the **Select Assets...** button. The Select Assets dialog box opens.
- Click the Add button to open the Asset Search dialog box. Enter your search criteria into the Search Text field.
- Click the **Search** button. The search results are displayed in the table.
- Select the desired assets from the table and click **OK**. The Select Assets dialog box is populated with rows for each selected asset.
 - Newly added rows have a green background.
 - Rows can be removed from the Select Assets dialog box using the **Remove Asset** button. Rows scheduled for removal have a red background.
 - The **Undo Changes** button reverts all changes made to the list of assets in the Select Assets dialog box.
- Click **OK** to close the Select Assets dialog box. The Number of Selected Assets will be updated with the count of selected assets.

To specify a list of assets classes and a list of control zones, complete these steps:

- Click the **Select Asset Classes...** button. The Select Asset Class dialog box appears.
 - Select the desired asset classes from the tree and click **OK**. The Select Asset Classes dialog box disappears, and the Asset Class(es) field is populated with the names of the asset classes.
 - To specify a list of control zones, click the **Select Control Zones...** button. The Select Control Zones dialog box appears.
 - Select the list of control zones from the tree, and click **OK**. The Select Control Zones dialog box disappears, and the Control Zones field is populated with the name of the selected control zones.
12. Select/deselect the **Use Event States**, **Disable During Storm**, and **Active** check boxes as desired.
13. Click the **Save** button to save the parameter.

Adding a Storm Affecting Control Zone Parameter

To add a Storm Affecting Control Zone parameter, complete these steps:

1. Click the **Parameter Manager** tab on the Service Alert Administration Tool.
2. Click the **Add** button. The appropriate fields on the Parameter Information panel become enabled.
3. Enter a descriptive name for the parameter into the **Name** field.
4. Click the **Select Contact Groups...** button. The Select Contact Groups dialog box appears.
5. Select one or more groups to be notified when the parameter is violated from the **Select Contact Groups** dialog box.
6. Click the **OK** button on the Select Contact Groups dialog box. The Select Contact Groups dialog box disappears.
7. Select "6. Storm affecting control zone" from the Type drop-down list.
8. Check **Storm Started** and/or **Storm Ended** in the **Trigger**. If Storm Started is checked, Storm Updated will become available and can also be checked.
9. Click the **Select Control Zones...** button. The **Select Control Zone** dialog box appears.
10. Choose the desired control zones for the alert and click **OK**. The **Control Zones** field will be populated with your choice.
11. Click the **Save** button to save the parameter.

Editing a Parameter

To edit a parameter, complete these steps:

1. Click the **Parameter Manager** tab on the Service Alert Administration Tool.
2. Click on one of the existing parameters in the Parameters table. The **Edit** button becomes enabled.
3. Click the **Edit** button. The appropriate fields will become enabled.
4. Edit each field as desired.
5. Click **Save** to save the edited information, or click **Cancel** to avoid saving the edited information.

Removing a Parameter

To remove a parameter, complete these steps:

1. Click the **Parameter Manager** tab on the Service Alert Administration Tool.
2. Click on one of the existing parameters in the Parameters table. The **Remove** button becomes enabled.
3. Click the **Remove** button. The Remove Parameter dialog box opens.
4. Click **Yes** to remove the parameter or **No** to avoid removing the parameter.

Utility Customer Manager

The Utility Customers tab is used for designating customers as being "critical" within Service Alert and entering contact information for each critical customer. This information will display in the "Outage affecting critical customer(s)" notification. To "import" a customer into Service Alert, an "add" operation must be performed. Once the customer has been added, customer contacts can be associated with the account. Each customer contact can also have one or more phone entries, which indicate how the customer contact can be reached. To bring up contact information for an existing Service Alert Critical account, a "search" must be performed.

The Utility Customers tab allows you to perform the following tasks:

- [Adding an Account to Service Alert](#)
- [Searching for an Account](#)
- [Editing an Account](#)
- [Removing an Account](#)
- [Adding Customer Contact Information](#)
- [Searching for a Customer Contact](#)
- [Editing Customer Contact Information](#)
- [Removing Customer Contact Information](#)
- [Adding Customer Contact Phone Information](#)
- [Editing Customer Contact Phone Information](#)
- [Removing Customer Contact Phone Information](#)

For a description of the fields and buttons on this tab, see the following topic.

Utility Customers Tab

The Utility Customers tab displays the following fields and buttons:

- The header section contains details regarding a specific customer account.
 - The **Account Number** field displays the account number of the critical customer.
 - The **Name** field displays the name of the critical customer.
 - The **Address** field displays the address of the critical customer.
 - The **Client Type** menu allows you to specify a client type value for the critical customer. The available options are Undetermined, Office, Computer Data Center, Communications, Shelter, Command Center, Company Executives, and Business Leaders.
 - The **Add** button displays the Add Account dialog box. This dialog box allows you to add a critical customer into Service Alert. The main reason for doing this is to associate contact and contact phone information with the critical customer.
 - The **Edit** button places the header section into edit mode, allowing you to modify both the customer account name and the client type value.
 - The **Remove** button removes an account from Service Alert. This does not affect the customer's entries in the Oracle Utilities Network Management System tables.
 - The **Search** button displays the Search Account dialog box. This dialog box allows you to search for a critical customer that was previously added to Service Alert.
 - The **Save** button allows you to save any changes you made while the header section was in edit mode, and returns the section to non-editable mode.

- The **Cancel** button returns the section to non-editable mode without saving any changes.
- The **Customer Assets** panel displays a list of assets that are associated with the currently selected account.
 - The **Service Location ID** column contains the service location identification value for the asset.
 - The **Asset ID** column contains the identification value for the asset.
- The **Customer Contacts** panel contains the list of contacts for the currently selected account. For convenience, the rows in the table can be sorted in ascending or descending order by clicking on any column header.
 - The **ID** column contains the system assigned unique id for the customer contact entry.
 - The **Name** column contains the customer contact name.
 - The **Title** column contains the customer contact title, if applicable.
 - The **Instructions** column contains general instructions for contacting this individual.
 - The **Add** button displays the Add/Edit Customer Contact dialog box. This dialog box allows you to add a customer contact.
 - The **Edit** button displays the Add/Edit Customer Contact dialog box. This dialog box allows you to edit a customer contact.
 - The **Remove** button removes the contact from the critical customer contact listing.
 - The **Search...** button displays the Search Customer Contacts dialog box. This dialog box allows you to search for a customer contact that was previously added to Service Alert.
- The **Customer Contact Phones** panel displays phone information for the currently selected contact in the Customer Contacts table. For convenience, the rows in the table can be sorted in ascending or descending order by clicking on any column header.
 - The **ID** column contains the system assigned unique id for the customer contact phone entry.
 - The **Type** column contains the type of phone (Office, Home, Cell, and so on).
 - The **Number** column contains the phone number.
 - The **Ext** column contains the phone extension, if applicable.
 - The **Call Time** column contains the time of day to call the individual using this phone number (Anytime, Daytime, Nighttime, and so on).
 - The **Sequence** column contains the preferred calling order for reaching the customer contact.
 - The **Add** button displays the Add/Edit Customer Contact Phone dialog box. This dialog box allows you to add a customer contact phone entry.
 - The **Edit** button displays the Add/Edit Customer Contact Phone dialog box. This dialog box allows you to edit a customer contact phone entry.
 - The **Remove** button removes the contact phone entry from the selected contact's list of phone contact information.

Adding Accounts

The **Add Account** dialog box opens once you press the **Add** button on the Utility Customers tab. This dialog box allows you to add a critical customer into Service Alert.

The Add Account dialog box displays the following fields and buttons:

- The **Search Text** field displays the text used to search for a critical customer account. The text varies based on the search parameter.
- The **Search Parameter** field displays the current search parameter. The available parameters are Account Number, Account Name, Phone Number, Address, City State, and Zip Code.
- The **Search** button performs a critical customer search within the Oracle Utilities Network Management System database based upon the Search Text and Search Parameter.
- The **Clear** button clears the Search Text field and the search results table.
- The **Account Number** column displays the account number of the critical customer.
- The **Account Name** column displays the account name of the critical customer.
- The **Phone Number** column displays the phone number of the critical customer.
- The **Address** column displays the address of the critical customer.
- The **City State** column displays the city and state portion of the critical customer's address.
- The **Zip Code** column displays the zip code of the critical customer.
- The **Critical Types** column lists the customer's critical classification.
- The **OK** button adds the customer to Service Alert and closes the Add Account dialog box.
- The **Cancel** button closes the Add Account dialog box without adding the customer to Service Alert.

Adding an Account to Service Alert

To add an account to Service Alert, complete these steps:

1. Click the **Utility Customers** tab on the Service Alert Administration Tool.
2. Click the **Add** button. The **Add Account** dialog box opens.
3. Select a search criterion on the **Search Parameter** drop-down list.
4. Enter text into the **Search Text** field according to the search criterion selected in the previous step.
5. Click the **Search** button to perform a search for critical customers in the Oracle Utilities Network Management System database. The search result table populates with a set of customer data.
6. Select a customer by clicking on a row in the table. The **OK** button becomes enabled.
7. Click **OK** to add the customer to Service Alert, or **Cancel** to avoid adding the account.

Searching for an Account

The Search Account dialog box opens once you press the **Search** button on the header section of the Utility Customers tab in the Service Alert Administration Tool. This dialog box allows you to search for a critical customer that was previously added to Service Alert.

The Search Account dialog box contains the following information:

- The **Search Text** field displays the text used to search for a critical customer account within the Service Alert tables. The text varies based on the search parameter.
- The **Search Parameter** field displays the current search parameter. The available parameters are Account Number, Account Name, Phone Number, Address, City State, and Zip Code.
- The **Search** button performs a critical customer search within the Service Alert database based on the search text and search parameter. The search is executed against customers previously added to Service Alert by means of [Adding Accounts](#) functionality.
- The **Clear** button clears the Search Text field and the search results table.
- The **Account Number** column displays the account number of the critical customer.
- The **Account Name** column displays the account name of the critical customer.
- The **Phone Number** column displays the phone number of the critical customer.
- The **Address** column displays the address of the critical customer.
- The **City State** column displays the city and state portion of the critical customer's address.
- The **Zip Code** column displays the zip code of the critical customer.
- The **Critical Types** column lists the customer's critical classification.
- The **OK** button populates the Utility Customer panel with customer information, including contacts and contact phone entries, and closes the Search Account dialog box.
- The **Cancel** button closes the Search Account dialog box.

Searching for an Account in Service Alert

To search for an account, complete these steps:

1. Click the **Utility Customers** tab on the Service Alert Administration Tool.
2. Click the **Search** button. The Search Account dialog box opens.
3. Select a search criterion on the **Search Parameter** drop-down list.
4. Enter text into the **Search Text** field according to the search criterion selected in the previous step.
5. Click the **Search** button to perform a search for critical customers within Service Alert. The search result table populates with a set of customer data.
6. Select a customer by clicking on a row in the table. The **OK** button becomes enabled.
7. Click **OK** to display the customer data and contact information on the Utility Customer panel, or **Cancel** to avoid selecting the account.

Editing an Account

To edit an account, complete these steps:

1. Search for an Account. (Refer to the previous topic for instructions). The customer account information loads into the header section.
2. Click the **Edit** button. The Name and Client Type fields become editable.
3. Edit the **Name** field and change the selected **Client Type** as desired.
4. Click the **Save** button. The changes are saved and the header section returns to non-edit mode. In order to exit from edit mode without saving changes, click the **Cancel** button instead.

Removing an Account

To remove an account, complete these steps:

1. Search for an Account. (Refer to the previous topic for instructions). The **Remove** button becomes enabled.
2. Click the **Remove** button. The Remove Customer Account dialog box opens.
3. Click **Yes** to remove the account from the system, or **No** to avoid removing the account from the system.

Adding Customer Contact Information

To add customer contact information, complete these steps:

1. Add an account or search for an account, as described in the previous topics.
2. In the Customer Contacts section, click the **Add** button. The Add/Edit Contact dialog box opens.
3. Enter in a **Name** and **Title** for the customer contact. If applicable, enter in general instructions, or any other relevant information, regarding the contacting of the individual. The **OK** button becomes enabled.
4. Click **OK** to add the customer contact information to the database or **Cancel** to avoid adding the information.

Searching for a Customer Contact

The Search Customer Contacts dialog box opens once you press the Search button on the Customer Contacts section of the Utility Customers tab. This dialog box allows you to search for a customer contact that was previously added to Service Alert.

The Search Customer Contacts dialog box displays the following fields and buttons:

- The **Search Text** field displays the text used to search for a critical customer account within the Service Alert tables. The text varies based on the search parameter.
- The **Search Parameter** field displays the current search parameter. The available parameters are Contact Name, Contact ID, Contact Title, Account Name, and Account Number.
- The **Search** button performs a customer contact search within the Service Alert database based on the search text and search parameter. The search is executed against customer contacts previously added to Service Alert by means of the [Adding Customer Contact Information](#) on page 6-25 functionality.
- The **Clear** button clears the Search Text field and the search results table.
- The **Contact ID** field contains the system assigned unique id for the customer contact entry.
- The **Contact Name** column contains the customer contact name.
- The **Contact Title** column contains the customer contact title, if applicable.
- The **Account Name** column displays the account name of the critical customer the contact is already associated with.
- The **Account Number** column displays the account number of the critical customer the contact is already associated with.
- The **Add** button associates the selected contact with the currently displayed critical customer, including contacts and contact phone entries, adds a row for this contact to the Customer Contacts table, and closes the Search Customer Contacts dialog box.
- The **Cancel** button closes the Search Customer Contacts dialog box.

Searching for a Customer Contact in Service Alert

To search for a customer contact, complete these steps:

1. Add an account or search for an account.
2. Click the **Search** button. The Search Customer Contacts dialog box opens.
3. Select a search criterion on the **Search Parameter** drop-down list.
4. Enter text into the **Search Text** field according to the search criterion selected in the previous step.
5. Click the **Search** button to perform a search for customer contacts within Service Alert. The search result table populates with a set of customer data.
6. Select a customer contact by clicking on a row in the table.
7. Click **Add** to associate the customer contact with the critical customer currently displayed on the Utility Customer panel, or **Cancel** to avoid adding a contact.

Editing Customer Contact Information

To edit customer contact information, complete these steps:

1. Search for an account that has customer contacts associated with it.
2. In the Customer Contacts section, click the **Edit** button. The Add/Edit Contact dialog box opens.
3. Edit the **Name**, **Title**, and **Instructions** associated with the customer contact. The **OK** button becomes enabled.
4. Click **OK** to save the edited customer contact information to the database or **Cancel** to avoid saving the information.

Removing Customer Contact Information

To remove customer contact information, complete these steps:

1. Search for an account that has customer contacts associated with it.
2. Click on one of the existing contacts in the **Customer Contacts** table. The **Remove** button becomes enabled.
3. Click the **Remove** button. The Remove Contact dialog box opens.
4. Click **Yes** to remove the contact's association with this account, or **No** to avoid removing the contact association.

Adding Customer Contact Phone Information

To add customer contact phone information, complete these steps:

1. Add an account or search for an account.
2. If the account does not have any associated contacts, add a customer contact.
3. Click on one of the existing contacts in the **Customer Contacts** table. The **Add** button becomes enabled.
4. Click the **Add** button. The Add/Edit Customer Contact Phone dialog box opens.
5. Modify the phone type and call time from the **Type** and **Call Time** drop-down lists, respectively.
6. Enter a phone number in the **Number** field. If applicable, a phone extension can be entered in the text field to the right of the Number field.

7. Enter a non-negative value in the Sequence field. This number is used to indicate the priority of this phone entry relative to all other phone entries associated with the selected customer contact. The **OK** button becomes enabled.
8. Click **OK** to save the customer contact phone information to the database, or **Cancel** to avoid saving the phone information.

Editing Customer Contact Phone Information

To edit customer contact phone information, complete these steps:

1. Search for an account that has customer contacts associated with it.
2. Click on one of the existing contacts in the **Customer Contacts** table. The **Edit** button becomes enabled.
3. Click the **Edit** button. The Add/Edit Customer Contact Phone dialog box opens.
4. Modify the phone type and call time from the **Type** and **Call Time** drop-down lists, respectively.
5. Edit a phone number in the **Number** field. Edit the phone extension in the text field to the right of the **Number** field.
6. Edit value in the **Sequence** field.
7. Click **OK** to save the customer contact phone information to the database, or **Cancel** to avoid saving the phone information.

Removing Customer Contact Phone Information

To remove customer contact phone information, complete these steps:

1. Search for an account that has customer contacts associated with it.
2. Click on one of the existing contacts in the **Customer Contacts** table.
3. Click on one of the contact phone entries in the **Customer Contact Phones** table. The **Remove** button becomes enabled.
4. Click the **Remove** button. The Remove Phone dialog box opens.
5. Click **Yes** to remove the contact's selected phone entry, or **No** to avoid removing the entry.

Attribute Manager

The Attributes Manager tab is used to add, edit, or remove attribute information associated with specific assets. Attribute Information can be displayed on notifications trigger by the associated asset. An attribute consists of an Asset ID, Attribute ID, a name and a value. Inactive attributes cannot be violated, and therefore will never trigger a notification.

The Attributes Manager tab allows you to perform the following tasks:

- [Adding Attributes](#)
- [Editing a Attribute](#)
- [Removing a Attribute](#)

For a description of the fields and buttons on this tab, see the following topic.

Attributes Manager Tab

The Attributes Manager tab displays the following fields and buttons:

- The **Attributes** panel lists all attributes known to Service Alert. Note that the table row colors correspond to whether a attribute is active (white) or inactive (bluish gray). For convenience, the rows in the table can be sorted in ascending or descending order by clicking on any column header.

The columns displayed are user selectable by right-clicking the table heading area and selecting or deselecting the list of available columns in the **Select Columns to Display** dialog box. Once the columns have been chosen, you may save the choices for your subsequent sessions by selecting **Save Preferences** from the **Preferences** menu; if not saved, the default columns will be displayed when you log in again. See [Preferences Menu](#) on page 6-3 for details on saving and restoring column selections.

The default product configuration displays the following columns:

- The **Asset ID** column contains the asset to which the attribute applies.
- The **Attribute Name** column contains a descriptive name given to the attribute.
- The **Attribute Value** column contains a value given to the attribute.
- The **Add** button displays the Asset Search dialog box, allowing you to search for an asset to associate with the attribute.
- The **Edit** button allows you to edit the currently selected attribute.
- **Remove** button removes the currently selected attribute from the Service Alert.

The **Attribute Information** panel is where the details for an attribute are entered and/or edited.

- The **Asset ID** field displays the alias of the asset to which the attribute applies.
- The **Attribute ID** field displays the system assigned internal id for the attribute.
- The **Attribute Name** field displays the descriptive name given to the attribute. This value can be modified be when in add/edit mode.
- The **Attribute Value** field displays the value given to the attribute. This value can be modified be when in add/edit mode.
- The **Active** check box allows you to enable/disable the attribute.
- The **Save** button saves the attribute information.
- The **Cancel** button cancels an add/edit attribute operation.

Adding Attributes

An attribute consists of a name and a value associated to an asset or customer. The attribute information can be displayed on notifications triggered by the associated asset.

1. Click the **Attribute Manager** tab on the Service Alert Administration Tool.
2. Click the **Add** button to bring up the Asset Search dialog box.
3. Enter into the **Search Text** field your search criteria.
4. Click the **Search** button. The search results are displayed in the table.
5. Select the desired asset from the table, and then click the **OK** button. The Asset Search dialog box disappears, and the Asset ID field is populated with the name of the selected asset.
6. Enter a descriptive name for the attribute into the **Attribute Name** field.
7. Enter a value for the attribute into the **Attribute Value** field.
8. Select/deselect the **Active** check box as desired.
9. Click the **Save** button to save the attribute.

Editing a Attribute

To edit an attribute, complete these steps:

1. Click the **Attribute Manager** tab on the Service Alert Administration Tool.
2. Click on one of the existing attributes in the **Attributes** table. The **Edit** button becomes enabled.
3. Click on the **Edit** button. The appropriate fields will become enabled.
4. Edit each field as desired.
5. Click **Save** to save the edited information, or click **Cancel** to avoid saving the edited information.

Removing a Attribute

To remove an attribute, complete these steps:

1. Click the **Attribute Manager** tab on the Service Alert Administration Tool.
2. Click on one of the existing attributes in the **Attributes** table. The **Remove** button becomes enabled.
3. Click the **Remove** button. The Remove Attribute dialog box opens.
4. Click **Yes** to remove the attribute or **No** to avoid removing the attribute.

Chapter 7

SCADA Extensions

This chapter covers **Oracle Utilities Network Management System (NMS) – SCADA Extensions**, including the following topics:

- [Overview](#)
- [SCADA Measurements](#)
- [Using SCADA Features](#)
- [Using the SCADA Summary](#)
- [Understanding SCADA Information in the Viewer](#)
- [Remote SCADA Operation Warnings](#)
- [Using SCADA Control Tool Features](#)
- [Switching Management SCADA Integration](#)

Overview

SCADA Extensions offers extended functions that enhance the capabilities of the Work Agenda, Viewer, Control Tool, and Web Switching Management applications. It also provides SCADA Summary, a window to display information about mapped SCADA measurements. These extended functions incorporate real-time data from a Supervisory Control and Data Acquisition (SCADA) system.

SCADA Extensions is required in order to display any SCADA data in **NMS**, whether it is through the Oracle Utilities Network Management System – SCADA ICCP Block 1, 2, and 5 Adapter interface or a custom interface. The interface itself is a separate component from the **NMS** and **SCADA Extensions**.

There are two basic types of SCADA interfaces employed. A one-way interface provides **NMS** with real time values for SCADA digital and analog measurements as well as quality codes, tags, and alarms. A two-way interface also allows the remote control of SCADA assets from within **NMS**.

SCADA Measurements

There are three possible types of SCADA measurements that SCADA Extensions can display:

- **Analog** - Numeric measurements of the distribution system operating conditions at SCADA assets.
- **Status** - Binary values, such as OPEN/CLOSE and ON/OFF. Status values related to valves are mapped into the topological status of operable assets that affect the flow in the distribution model. Other status values are displayed as text pairs of symbols.
- **Digital** - Whole-integer value measurements indicating the state of the valve. The **NMS** SCADA ICCP Block 1, 2, and 5 Adapter does not currently support digital whole-integer measurements. However, these values can be available if converted through a custom adapter into values.

Quality Codes

Quality codes provide information about the quality of the measurement coming from the SCADA system. Examples may include held, suspect, not valid, telemetered, calculated, entered, estimated, abnormal, off scan, SCADA error, and tag on. Additionally there are quality codes that may be applied to a SCADA measurement from the **NMS** applications. These include alarm inhibited and manually overridden.

Quality codes that may be configured to be supplied by the Oracle Utilities Network Management System SCADA ICCP Block 1, 2, and 5 Adapter include held, suspect, not valid, telemetered, calculated, entered, estimated, and abnormal.

Using SCADA Features

There are six primary locations where SCADA information can be accessed in **NMS**:

- SCADA operations that result in customers out appear as real outage events on the trouble related views of the Work Agenda in the same manner as outages that were generated by call information except that they are automatically confirmed and appear immediately as real outages. These operations are also included on the Asset Operations List on the Work Agenda.
- The SCADA Summary provides the current values and qualities of all mapped SCADA measurements in **NMS**, including both analog and digital measurements. You can filter, sort, modify, and comment on the measurements in the SCADA Summary.
- The Viewer displays dynamically updated SCADA information at or near the corresponding asset on the distribution network map. The data may be displayed via text annotation or, in the case of status and digital values, symbol changes. SCADA information that may be displayed on the Viewer includes valve status and other status values, digital values, and analog values, all with quality codes.
- The Viewer also shows all SCADA analog and digital values in the balloon dialog box.
- The SCADA Alarms list is an extension of the Work Agenda window and may display various alarm messages that are sent from the SCADA system. You can modify, acknowledge, and comment on measurements on the SCADA Alarms list.
- Any SCADA status values that result in a valve being in its off-nominal state will cause the asset to appear in the Abnormal Asset Summary.
- Systems with a two-way interface let you perform remote operations (for example, open/close and tagging) on SCADA asset through an enhanced version of the Control Tool.

Using the SCADA Summary

The SCADA Summary provides the current values and qualities of all mapped SCADA measurements in Oracle Utilities Network Management System. Each row of this summary represents one measurement. There may be multiple unique measurements on one SCADA asset. SCADA information includes digital and analog measurements, along with the quality codes and any user comments for each measurement. You can use the summary to view measurement information, manually replace current SCADA values, and inhibit updates.

This section includes the following topics:

- [Using the SCADA Summary Window](#)
- [Toolbar and Menu Options](#)
- [Preventing Updates from SCADA](#)
- [Manual Entry and Override of SCADA Values](#)

Using the SCADA Summary Window

The SCADA Summary may be opened to view all SCADA measurements or for measurements related to an asset or pressure zone selected in the Viewer. The SCADA Summary displays the following fields and buttons:







- The **Pressure Zone** column contains the name of the pressure zone reporting the SCADA measurements.
- The **Lift Station** column contains the lift station name.
- The **Asset** column contains the name of the asset reporting the SCADA measurements.
- The **Value** column contains the last reported measurement value. The value can be status, digital, or analog. For status measurements, the values are displayed as a test pair, such as open/close, on/off, and so on. Analog and digital values are shown as floating point and integer values.
- The **Quality** column contains the Quality codes for the measurement that indicates the quality of the SCADA measurement (for example, out of scan, inhibited, manual override). Several quality codes can be listed.
- The **Point Name** column displays the name of the SCADA measurement, as used in the SCADA system.
- The **Attribute** column contains a description of the measurement type, as configured in the ATTRIBUTES.description column in the Oracle Utilities Network Management System database for the matching attribute.

Toolbar and Menu Options

File Menu

| Menu Option | Description | Toolbar Icon |
|-------------|---|---|
| Print... | Displays the Print Preview window, from which you can view and print the summary. |  |
| Exit | Closes the SCADA Summary window. | -- |

Actions Menu

| Menu Option | Description | Toolbar Icon |
|--------------------|---|---|
| Inhibit | Inhibit sets the <i>inhibit</i> quality code for the selected SCADA measurement. This suppresses any new updates from SCADA. |  |
| Cancel Inhibit | Cancel Inhibit removes the <i>inhibit</i> quality code from the selected SCADA measurement. This allows any new updates from SCADA to be displayed. |  |
| Manual Entry... | Manual Entry allows you to enter a new value for the selected SCADA measurement. When a changed SCADA value is received by the system, it replaces the manually entered value. |  |
| Manual Override... | Manual Override allows you to enter a new value for the selected SCADA measurement. When a new SCADA value is received by the system, the measurement is blocked and the manually entered value remains. |  |
| Cancel Override | Cancel Override cancels the manual override for the selected measurement and reverts the selected measurement to the last received value from the SCADA system. |  |
| Control Tool | Brings up the control tool for the selected measurement's asset. |  |
| View... | View focuses the Viewer on the asset. |  |
| Load Pressure Zone | Loads additional data for all SCADA measurements on a pressure zone when the SCADA Summary is displaying asset data. Note: This option is only available when the SCADA Summary is launched from the Control Tool. | |
| Load Lift Station | Loads additional data for all lift station measurements when the SCADA Summary is displaying asset or pressure zone data. Note: This option is only available when the SCADA Summary is launched from the Control Tool. | |

| Menu Option | Description | Toolbar Icon |
|--------------------|---|---|
| Load Adjacent Lift | Loads additional data for adjacent lift stations. Note: This option is only available when the SCADA Summary is launched from the Control Tool. | |
| Load All | Repopulates the SCADA Summary with all measurements. This clears any asset, pressure zone, or lift station filters; see Viewing SCADA Summary Data from a Selected Asset on page 7-6. |  |

Filter Menu

| Menu Option | Description | Toolbar Icon |
|------------------|--|--------------|
| Filter Dialog... | Displays the Filter dialog box. The Filter Dialog option on the Filter menu performs the same function. See Filtering on page 1-16 for more information. | -- |
| AMI Bellwether | Displays bellwether AMI rows. | -- |
| All Measurements | Displays all rows in the SCADA Summary table. All is the default view. | -- |
| Analogs | Displays rows with analog values. | -- |
| Digitals | Displays rows with digital values. | -- |
| Equipment | Displays rows with equipment values. | -- |
| Statuses | Displays rows with status value. | -- |

Help Menu

| Menu Option | Description | Toolbar Icon |
|--------------------|---|--------------|
| SCADA Summary Help | Opens the online help system to the SCADA Summary help content. | -- |

Viewing All SCADA Summary Data

To open the SCADA Summary for all measurements, select **SCADA Summary...** from the Web Workspace **Tools** menu.

Viewing SCADA Summary Data from a Selected Asset

To open the SCADA Summary for a specific asset, select the asset or pressure zone in the Viewer and launch the Control Tool. Click **SCADA Summary...** and select one of the options:

- **Asset...:** loads the SCADA Summary with the SCADA measurement data for the selected asset.
- **Pressure Zone...:** loads the SCADA Summary with SCADA measurement data for the selected asset's pressure zone.
- **Lift Station...:** loads the SCADA Summary with SCADA measurement data for the selected asset's lift station.

When the SCADA Summary is launched from the Control Tool, the data source is shown in the status bar at the bottom of the SCADA Summary window.

Note: If you select **Load All** from the SCADA Summary **Actions** menu, the table will be repopulated with all measurements and the status bar will be cleared.

Updating the SCADA Summary for Another Asset

Once the SCADA Summary has been opened (from the Control Tool), you can view data for a different asset by selecting it in the Viewer and then clicking the **Load** button in the SCADA Summary status bar.

Preventing Updates from SCADA

To prevent a SCADA measurement from accepting updates from SCADA, complete these steps:

1. Select **SCADA Summary...** from the Web Workspace **Tools** menu. The SCADA Summary window opens.
2. Select a row in the SCADA Summary list that belongs to the asset you want to inhibit.
3. Click the **Inhibit** button.

Manual Entry and Override of SCADA Values

Occasionally, you may need to manually enter a status, digital value, or analog value for a SCADA measurement.

If the value for the selected measurement is a valve status measurement (that is, open/close), you must choose **Show Control Tool...** from the context menu to manually operate the switch. Otherwise, use the following procedure to enter a value manually:

1. Select **SCADA Summary...** from the Web Workspace **Tools** menu. The SCADA Summary window opens.
2. Select the SCADA measurement row in the SCADA Summary list.
3. Click either the **Manual Entry** or **Manual Override** button.

Note: Manual Entry allows future SCADA value changes to replace the manually entered value. Manual Override prevents SCADA measurements received by the system from changing the manually entered value. Manual Override can be useful when testing specific assets or RTU communications offline, since the test operations can be prevented from creating outages in Oracle Utilities Network Management System by putting manual overrides on the appropriate status measurements.

If the value for the measurement is a multi-state digital, analog, or any type of measurement other than a valve status measurement (open/close), a dialog box opens, allowing you to enter a value.

Note: Multi-state digitals are not available through the Oracle Utilities Network Management System SCADA ICCP Block 1, 2, and 5 Adapter.

4. Select or enter the value you want to change the measurement to.
5. Click **OK**.

Note: Clicking on the Manual Override button "blocks" any new values coming from the SCADA measurement. It does not affect the physical SCADA asset, it only blocks the value reported by the SCADA asset to Oracle Utilities Network Management System.

Understanding SCADA Information in the Viewer

Oracle Utilities Network Management System SCADA Extensions provides SCADA information in the Viewer in several different ways. The following table describes how SCADA information may appear in the Viewer (depending on your system's configuration).

| Data | Description |
|----------------------|---|
| Valve Status | Valve status information (that is, open or closed) received from SCADA is dynamically updated in the Viewer. Status symbology is no different than that for typical assets, except that it is based on data received automatically from a SCADA measurement rather than user input. |
| Digital Measurements | Digital measurements received from SCADA are dynamically updated. These measurements are displayed as a letter code or symbol next to the SCADA asset. Several digital measurement indicators may be listed. |
| Analog Measurements | Analog measurements received from SCADA are dynamically updated. These measurements are displayed in the Viewer next to the associated SCADA asset. Several unique measurements can be listed. When a new measurement is received, it replaces the current measurement. |
| Quality Codes | Quality codes provide additional information about the quality of the measurement coming from the SCADA asset (for example, out of scan, inhibited, manual override). A quality code is displayed as a letter code following a symbol or measurement. Quality Code Values: <ul data-bbox="683 989 1127 1157" style="list-style-type: none"><li data-bbox="683 989 846 1018">• I: inhibited<li data-bbox="683 1037 1127 1066">• M: manually entered/overridden value<li data-bbox="683 1085 959 1115">• H: high limit violation<li data-bbox="683 1134 943 1163">• L: low limit violation |

Enabling/Disabling SCADA Measurements in the Viewer

You can enable or disable SCADA measurements in the Viewer using the Hide / Display dialog box.

Note: To access the Hide/Display dialog box in the Viewer, see [Hiding and Displaying Viewer Objects](#) on page 1-56.

The system displays a flag (**S**) to indicate that an asset has available SCADA measurements.

Displaying SCADA Measurements with Asset Details

If you select a SCADA asset in the Viewer, the Asset Details balloon displays a SCADA tab that lists the SCADA measurements for the selected asset.

- The **Attribute** column contains a description of the measurement type, as configured in the ATTRIBUTES.description column in the Oracle Utilities Network Management System database for the matching attribute.
- The **Value** column contains the last reported measurement value. The value can be status, digital, or analog. For status measurements, the values are displayed as a test pair, such as open/close, on/off, and so on. Analog and digital values are shown as floating point and integer values.
- The **Quality** column contains the Quality codes for the measurement that indicates the quality of the SCADA measurement (for example, out of scan, inhibited, manual override). Several quality codes can be listed.
- The **Source** column contains the source for the measurement, as configured in the ANALOG_MEASUREMENTS.source or DIGITAL_MEASUREMENTS.source column in the Oracle Utilities Network Management System database.

Remote SCADA Operation Warnings

When you perform a remote SCADA asset operation in a two-way system, Oracle Utilities Network Management System SCADA Extensions will run certain checks. There are three warnings that you might receive as a result of these checks.

Note: The Oracle Utilities Network Management System SCADA ICCP Block 1, 2, and 5 Adapter controls are limited to valve status direct operate request.

The following table describes the possible remote SCADA operations warnings.

| Warning | Description |
|-------------------------------|---|
| SCADA Confirmation | When you open or close a SCADA-controlled asset, the Look Ahead window opens providing information about the potential results of the operation (see Using the Look Ahead Dialog Box on page 1-76). After you view all the required information and choose to proceed, another message box opens, reminding you that a remote operation will take place and asking you to confirm the SCADA-controlled operation. |
| SCADA Control Action Time-Out | Once you have confirmed that you want to perform a SCADA-controlled asset operation, Oracle Utilities Network Management System SCADA Extensions starts a timer. This timer monitors the response to the operation, expecting a "change-of-state" of the asset (for example, open to close). If a change-of-state is not detected from the asset before a time-out occurs, Oracle Utilities Network Management System SCADA Extensions generates an alarm displayed in the SCADA Alarms List. |
| SCADA Error | If errors are detected between Oracle Utilities Network Management System and the SCADA interface, a message box opens informing you of the failed operation. You should report these errors to the system administrator or support personnel. |

Note: If you click **Cancel** in the Look Ahead window, Oracle Utilities Network Management System SCADA Extensions will not initiate the remote SCADA operation.

Using SCADA Control Tool Features

If your system has a one-way SCADA interface, you can only receive information about SCADA measurements. If it has a two-way SCADA interface, however, not only can you receive information, but you can also remotely control SCADA assets. The Oracle Utilities Network Management System SCADA ICCP Block 1, 2, and 5 Adapter remote control is limited to direct operate request of valve status.

Use the Control Tool to perform operations on SCADA assets in the same manner as you would on non-SCADA assets (see [Operating Assets](#) on page 1-73). When you accept the operation in the Look Ahead tool, the system will open the SCADA Manual Entry Request dialog box that allows you to submit a manual entry, submit the manual entry and inhibit further SCADA updates, or cancel the action. If the measurement is already inhibited, the dialog box will offer a **Manual and Un-Inhibit** option.

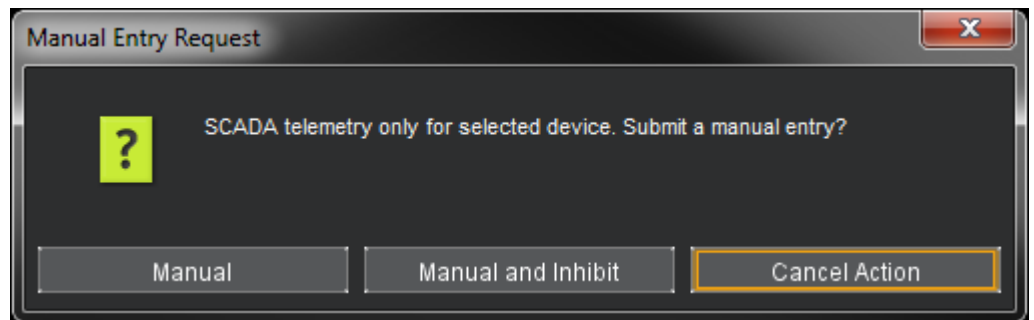

Switching Management SCADA Integration

If you have a two-way SCADA system, you can operate assets as a step when completing a switching plan. Just like a typical switching plan, you can open or close assets by selecting the switching step and clicking the **Complete** button. (See [Issuing a Switching Sheet](#) on page 8-44.) With a two-way SCADA system, however, the actual assets will be remotely operated. The Oracle Utilities Network Management System SCADA ICCP Block 1, 2, and 5 Adapter controls are limited to valve status.

For two-way SCADA, any instructed SCADA action will produce the SCADA Control Request dialog box asking if you would like to submit the request to SCADA or not. Clicking **Yes** will submit the request to SCADA while selecting **No** will not submit the request. Both options will cause a switching step to be placed into the SCADA Pending state. This is true whether the instruct action is initiated from the Control Tool or from Web Switching. The asset will also receive an Instruct condition. NMS will listen for SCADA telemetry and mark the action (step) as Completed once the action has been reported as being completed by SCADA. If SCADA does not report back a successful completion of the action, then the step will remain in the SCADA Pending state.

At any time, you may also choose to manually operate the SCADA asset locally without sending the action to SCADA. This is accomplished by selecting the non-instructed version of the action from the Control Tool or by clicking the **Complete** button for a step selected in Web Switching. When these non-instructed actions are initiated, a Manual Entry Request dialog box will ask you to select the **Manual**, **Manual and Inhibit**, or **Cancel** button options. Both the **Manual** and **Manual and Inhibit** options result in the recording or setting of a switching sheet step to the Completed state. The asset is also updated in the viewer.

If a SCADA action related step is in the SCADA Pending state, you can force the completion of the action prior to receiving any updates from SCADA by completing the instructed action from the Control Tool or from Web Switching. In this case, you will again get the Manual Entry Request

dialog box with options for **Manual**, **Manual and Inhibit**, or **Cancel**. Selecting either of the Manual options will force the step to the Completed state and will update the asset within NMS. This does not send a cancel request or any other type of message to SCADA. The Instruct condition will also be removed from the asset.

If any errors occur, Oracle Utilities Network Management System SCADA Extensions generates an alarm displayed in the SCADA Alarms List.

Chapter 8

Web Switching Management

This chapter describes Oracle Utilities Network Management System Web Switching Management. It includes the following topics:

- [Overview](#)
- [Understanding Web Switching Management Windows](#)
- [Planned Switching](#)
- [Emergency Switching](#)
- [Event Associations](#)
- [Crew Assignments](#)
- [Working with Safety Documents](#)
- [Outage Correction](#)
- [Using the Miscellaneous Log](#)
- [Viewing Global Overlaps](#)
- [Web Safety](#)

Overview

Web Switching Management allows you to create and implement *switching sheets* and *safety documents*. Switching Sheets allow you to track proposed switching actions, analyze the results, and implement the plan. Safety Documents provide an electronic representation of paper safety documents, which are used for switching operations to record the issuance and release of tags on assets.

Web Switching Management's full feature set is available through the **Web Workspace** environment for a **Full Operations plus Web Switching** user type (see [User Types](#) on page 1-2). **Web Switching Request** provides the Switching Request user type with a subset of the **Web Switching Management** tools related to creating and editing switching requests.

Operating Modes

Web Switching Management supports two operating modes:

- **Real-Time Mode** - Allows you to make real-time changes to the state of assets in the system. When you create an emergency switching sheet, the system automatically enables real-time mode. For planned sheets, you can switch to this mode when the sheet is ready to be worked.
- **Study Mode** - Allows you to make changes without affecting real-time data. You can apply the actions to the steps, but the actions are not applied to the real-time data. This mode is valid for all types of sheets. Study mode is the only valid mode for template and outage correction switching sheets.

Understanding Web Switching Management Windows

Overview

This section provides an overview of Switching Sheet windows. Unlike other docked NMS applications, such as Work Agenda or the Authority tool, switching sheets cannot be moved outside of the confines of the NMS workspace. The standard configuration opens a switching sheet in the lower right quadrant of the workspace, but it may be moved anywhere within the workspace or maximized to the full workspace dimensions.

Each open switching sheet has its own tabbed window, which is labeled with a combination of the switching sheet type, number, and pressure zone ID, if the pressure zone field is populated. Multiple switching sheets are typically docked together and displayed as a tab group.

Note: Double-click any tab (or the empty area to the right of the tabs) to maximize the tab group; double-click again to restore the size.

Right-click the switching sheet tabs to access the context menu, which provides the following options:

- **Maximize:** maximizes the sheet window.
- **Restore:** restores the maximized window to its original size and position.
- **New Tab Group:** displays the sheet separately.
- **Collapse Tab Groups:** regroups separate windows into tab groups.
- **Windows...:** opens a dialog box that lists all open sheets, which you can then:
 - Activate (that is, bring to front in a tab group) a single sheet.
 - Close selected sheets.
- **Close:** closes the sheet.
- **Close All:** closes all open sheets.
- **Close Others:** closes all open sheets except the sheet that was right-clicked.

Web Switching Sheets

Switching Sheet Types

Web Switching Management supports the following types of switching sheets.

- **Planned** - Used for switching sequences that are prepared ahead of time. In scheduled or planned switching, you can create, study, and approve switching steps in a Viewer in study mode prior to completing them in real-time. Planned switching sheets require information that is not needed for emergency switching sheets, such as a start and end date.

Note: When creating a switching sheet from an event in the Work Agenda or Event Details, the *Planned* switching sheet type is not available.

- **Emergency** - Used for switching sequences that are prepared and implemented in real-time when overloads or unplanned outages occur.

Notes:

- Emergency Switching Sheets cannot be created from Web Switching Request.

- **Template** - Used to record and store frequently performed switching step sequences that can be copied into a switching plan. A template is not used to perform actions, but rather to create and save ""pre-built"" sheets with step sequences. You can create a template from scratch or by copying an existing template, planned, or emergency switching sheet.

Note: When creating a switching sheet from an event in the Work Agenda or Event Details, the *Template* switching sheet type is not available.

- **ANMS Template** - Used to create ANMS scheme templates.
- **Outage Correction** - Used to correct outage information. Outage events are associated to this switching sheet type and then steps are recorded to reflect the actual events leading up to the outage. An option on the sheet then allows you to update the associated event, including customer counts associated to the outage.

Note: Outage Correction switching sheets cannot be created from Web Switching Request.

Additional or alternative sheet types can be configured for your project; see the *Oracle Utilities Network Management System Configuration Guide* for details on creating custom sheet types.

Switching Sheet States

A switching sheet passes through different phases during the creation and completion of the sheet. These phases are represented by "states" that follow a logical sequence and determine what you can do with a switching sheet at any time. Each sheet type has a unique set of state transitions. For example, planned switching sheets have more state transitions than emergency sheets.

| Normal Progression of Planned Sheet | Normal Progression of Emergency Sheet |
|-------------------------------------|---------------------------------------|
| 1. New | 1. New |
| 2. Requested | 2. In Progress |
| 3. Prepared | 3. Completed |
| 4. Checked | |
| 5. Approved (optional) | |
| 6. Scheduled | |
| 7. Issued | |
| 8. In Progress | |
| 9. Completed | |

See [Changing the Switching Sheet State](#) on page 8-17 for a complete description of each possible state and instructions for changing the sheet state.

Note: The state of the switching sheet should not be confused with the state of individual switching steps within the switching plan, which may also progress through a series of states. See [Switching Sheet Step States](#) on page 8-31.



Switching Sheet Window Components



- [Menu and Toolbar Features](#)
- [Switching Sheet Tabs](#)
- [Status Bar](#)

Menu and Toolbar Features

File Menu





The table below describes the options available on the **File** menu.

| Menu Option | Description | Toolbar Icon |
|------------------|---|---|
| Save Sheet | Saves the switching sheet. |  |
| Copy As... | Opens the Copy Switching Sheet As dialog box that allows you to copy the current sheet into a newly created sheet. The new sheet can be one of the following types: Planned, Emergency, Template, or Outage Correction. See Copying a Switching Sheet on page 8-67 for details. | -- |
| Print Preview... | Opens the Switching Report Content Selection dialog box that allows you to choose the criteria for previewing a switching report. |  |

| Menu Option | Description | Toolbar Icon |
|-----------------|---|---|
| Print... | Opens the Switching Report Content Selection dialog box that allows you to choose the criteria for printing a switching report. |  |
| Email... | Opens the Switching Report Content Selection dialog box that allows you to choose the criteria for emailing a switching report. |  |
| Exit | Closes the active switching sheet. | -- |

Actions Menu

The options available in the Actions menu are dependent on the sheet type. Actions available will typically also be available through the right-click context menu and/or toolbar. The following are always in the Actions menu

| Option | Description | Tab | Toolbar Button |
|---|---|---------|--|
| Check In/ Create New Version | <p>The Check In button allows you to check in and save a copy of the switching sheet. This is used for auditing purposes to determine differences between steps in two versions of a switching sheet.</p> <p>When you check in a sheet, this button changes to Create New Version, which manually increments the sheet's version number and sets the sheet to Editing mode. See Working with Switching Sheet Versions on page 8-49 for more information.</p> | All |  |
| Edit Mode/ View-Only Mode | <p>Edit and View-Only Modes</p> <p>When the sheet is in Edit mode, you are the only user who can edit it. When it is in View-Only mode, you cannot edit the sheet and it is available for editing by other users. The Edit/View-Only Indicator button toggles the sheet between Edit and View-Only modes.</p> <p>When you open a sheet for editing, the sheet is automatically placed into Edit mode and blocks other users from editing it. If you open a sheet that is currently being edited by another user, you are not allowed to make any changes.</p> | All |   |
| Refresh | Refreshes the data in a view-only sheet. The Refresh option is available when another user has locked and edited the sheet. | All |  |
| Update Asset-Related Fields | Updates the Lift Stations and Pressure Zone fields with values related to the switching sheet's asset and step asset values. The Location and Diameter values will be updated with values related to the sheet's asset value. If the sheet's asset value is invalid or empty and the steps have no asset related operations, then the fields will be cleared when this option is selected. | Request |  |
| Insert Blank Step | Inserts a blank step below the current step row. | Steps | |

| Option | Description | Tab | Toolbar Button |
|---|--|------------|-----------------------|
| Place Step Insertion Indicator | Adds a step insertion indicator icon to the row. | Steps | |
| Remove Step Insertion Indicator | Removes the step insertion icon. | Steps | |
| Link to Safety Document | Links the selected safety document to the currently selected step in switching sheet. This option is only visible when the switching sheet has active safety documents linked to it. | Steps | |
| Remove Links to Safety Documents | Disassociates the safety document that is linked to the step and updates the step. | Steps | |
| Add New Block Header | Isolate Fault Location Maintenance Restore Construction Custom... | Steps | |
| Rename Block Header | Isolate Fault Location Maintenance Restore Construction Custom... | Steps | |
| Load Safety Documents... | Display the safety documents linked to the highlighted steps. | Steps | |
| Clear Planned Time | Clear the Planned Date values for the highlighted steps. This option is only visible when at least one of the highlighted steps has an Planned Date value. | Steps | |
| Update Step Control Zone Data | Iterate through the selected steps and update their control zone related data. This may be required if the step's device has been recently moved to a new control zone. | Steps | |
| Clear Crews | Clear the Instructed To values for the highlighted steps. This option is only visible when at least one of the highlighted steps has an Instructed To value. | Steps | |

| Option | Description | Tab | Toolbar Button |
|-----------------------------------|--|-------|---|
| Model Verify | <p>This action is available if model changes have occurred that impact one or more assets in the switching sheet.</p> <p>The Web Switching service checks all the opened switching sheet steps after a model edit has occurred. If a step has an asset that matches an asset that was directly impacted by a model change, that step will be marked as needing verification. When the sheet is displayed, these steps will be highlighted in yellow. You can either check off each step in the sheet as they are verified or check off the entire sheet.</p> <p>Notes:</p> <ul style="list-style-type: none"> • Outage Correction sheets are not included in this processing. Outage Correction validates the assets when the correction is made. • While the sheet has verifications pending, step executions cannot be performed within the sheet. • Switching sheets in the Completed or Rework states are not included in this processing. | Steps |  |
| Move Crew | Move a crew to the asset associated with the selected step. This option is enabled when a single highlighted step is instructed to an en-route crew. | Steps | |
| Clear Condition Indexes | Removes the condition class and index associated to the selected step. An error dialog box will be displayed if the selected steps' condition handles cannot be cleared. The action is only available for steps that are not in a terminal state and that are not associated to safety documents. | Steps | |
| Update Instructed Dates... | Opens the Update Instructed Date dialog box, which allows you to enter a new Instructed Date for selected steps. Steps that have not been instructed will not be updated. | Steps | |
| Move Steps to Misc Log | <p>This action moves Real Time Completed, Aborted, Failed or Instructed steps to the Miscellaneous Log. SCADA Pending steps cannot be moved until they have transitioned to one of the states already stated. Steps associated to safety documents are also not allowed to be moved. Any step in a New or Uninstructed state will not be moved as the Miscellaneous Log only displays Real Time steps that are in a terminal or Instructed state. Any attempt to move an immovable step will result in an error dialog box and the steps will not be moved from the switching sheet's steps list.</p> <p>To move steps to the Miscellaneous Log, select one or more steps and select Move Steps to Misc Log from the Actions menu or from the right-click context menu.</p> | Steps | |
| Group Steps | Groups two or more contiguously selected steps. | Steps | |
| Ungroup Steps | Ungroups steps that have been grouped. | Steps | |

| Option | Description | Tab | Toolbar Button |
|--------------------------------|---|-------|----------------|
| Reset Operation Text... | Resets the text in the Operation field to its calculated value following a manual edit. This option is only visible once the step's Operation field has been manually edited. This is not possible for all types of steps and with Product configuration this is limited to non-operational steps. In other words, any step that does not actually impact the model, manipulate a condition, or interact with any other tools in the environment. | Steps | |
| Clear Clipboard | Clears copied steps from your computer clipboard. Alternatively, press the Escape (Esc) key. | Steps | |

Help Menu.

| Option | Description | Toolbar Button |
|---------------------------------------|---|----------------|
| Web Switching Management Help | Opens online help content for the switching sheet's active tab. For example, if the Request tab is active, the "Completing the Request Tab" will be returned. | -- |
| About Web Switching Management | Opens a window with environment and software information. | -- |

Switching Sheet Tabs

Each switching sheet tab displays a row of tabs that you can use to view and edit all of the information associated with the sheet. Some tabs, like the Steps tab, have their own toolbar with shortcuts for supported actions.





The following table describes the tabs displayed for each switching sheet.

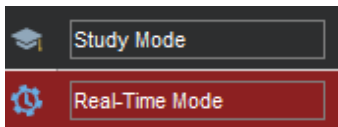

| Tab | Description |
|--------------------|---|
| Request | Use this to view and enter information about the user who requested the switching sheet, including phone number and contact, the sheet's owner, charge number, start and finish dates, pressure zone and diameter information. See Completing the Request Tab on page 8-15. |
| Steps | Use this to view, add, and edit switching steps. See Adding and Editing Steps on page 8-19. |
| Impacted Customers | Use this to view, print, email, and maintain the list of impacted customers. See Viewing Impacted Customers on page 8-51. |
| Overlaps | Use this view to identify overlaps that the sheet may have with other sheets in the system. The search criteria can include date/time, control zone, and affected assets. See Checking for Overlaps on page 8-55. |
| External Documents | Use this to attach external documents to the switching sheet. See Adding External Documents to a Switching Sheet on page 8-62. |

| Tab | Description |
|--------------------|---|
| View Areas | Use this to save and reload viewing areas from a Viewer window. See Saving and Loading View Areas on page 8-58. |
| Safety Documents | Use this to view, load, and delete safety documents that have been defined for this sheet. See Working with Safety Documents on page 8-77. |
| Tracking/Audit Log | Use this to view audit log entries associated with this sheet. See Viewing the Audit Log on page 8-60. You can also use this to view the current sheet state or transition to another state. See Changing the Switching Sheet State on page 8-17. |

Status Bar

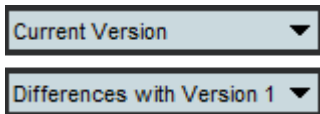
The switching sheet status bar provides several indicators about the switching sheet and related system status.

| Status Bar Indicator | Description |
|---|--|
| <p>1 Mode Indicator</p>  | <p>Indicates the current operating mode:</p> <ul style="list-style-type: none"> • Study Mode: Allows you to complete switching operations without affecting the real-time data model. You can apply the actions to the steps, but the actions are not applied to the real-time data. • Real-Time Mode: Allows you to apply real-time changes to the state of assets in the data model. |
| <p>2 Overlap Indicator</p>  | <p>Indicates whether the switching sheet will result in overlap of affected assets or control zones during the same time period. This icon is dynamically updated to when overlaps are created or resolved.</p> |
| <p>3 Impacted Customer Indicator</p>  | <p>Indicates whether the switching operations will impact customers. This icon is dynamically updated to reflect the results of generating the impacted customer list.</p> |
| <p>4 Recording Indicator</p>  | <p>Indicates whether recording is turned on or off. When recording is on, you can add steps by taking actions in the Viewer and Control Tool.</p> |
| <p>5 Version Indicator (Text)</p> | <p>Indicates the switching sheet version and whether or not your latest changes have been checked in. See Working with Switching Sheet Versions on page 8-49 for more information.</p> |
| <p>7 Version Menu</p>  | <p>Indicates the version currently displayed and allows you to select a previous version to compare against the current version. See Working with Switching Sheet Versions on page 8-49 for more information.</p> |

| Status Bar Indicator | Description |
|--|---|
| 8 Edit/View-Only Indicator  : Edit mode  : View-Only mode | Edit and View-Only Modes When the sheet is in Edit mode, you are the only user who can edit it. When it is in View-Only mode, you cannot edit the sheet and it is available for editing by other users. The Edit/View-Only Indicator button toggles the sheet between Edit and View-Only modes. When you open a sheet for editing, the sheet is automatically placed into Edit mode and blocks other users from editing it. If you open a sheet that is currently being edited by another user, you are not allowed to make any changes. You can override the lockout by stealing the other user's lock over the switching sheet. See Opening Locked Documents on page 8-73 for more details. |

Planned Switching

The sections that follow describe how to create and manage planned switching sheets. Planned switching sheets are used for switching sequences that are prepared ahead of time. In scheduled or planned switching, you can create, study, and approve switching steps in a Viewer in study mode prior to completing them in real-time mode.

This section contains the following topics:

- [Creating a Planned Switching Sheet](#)
- [Switching Sheet Requests](#)
- [Changing the Switching Sheet State](#)
- [Adding and Editing Steps](#)
- [Reviewing a Switching Sheet in Study Mode](#)
- [Replaying Steps](#)
- [Implementing a Planned Switching Sheet](#)
 - [Scheduling a Planned Master Event](#)
 - [Issuing a Switching Sheet \(includes associating a crew and printing the sheet\)](#)
 - [Instructing and Completing Switching Sheet Steps](#)
 - [Moving a Crew](#)
- [Working with Switching Sheet Versions](#)
- [Viewing Impacted Customers](#)
- [Checking for Overlaps](#)
- [Saving and Loading View Areas](#)
- [Emailing Switching Sheet Data](#)
- [Adding External Documents to a Switching Sheet](#)
- [Viewing the Audit Log](#)
- [Opening an Existing Switching Sheet](#)
- [Copying a Switching Sheet](#)
- [Deleting a Switching Sheet](#)

For information about emergency switching sheets, see [Emergency Switching](#) on page 8-68.

Creating a Planned Switching Sheet

You can create a new planned switching sheet by doing one of the following:

- Select **New** and then **Switching Sheet...** from the Web Workspace **File** menu.
- Click the new switching sheet button () on the Web Workspace toolbar.
- From the Switching Sheet List, select **New...** from the **File** menu.

The New Switching Sheet window is displayed.

New Switching Sheet Window

Use the New Switching Sheet window to create switching sheets. This window contains the following fields and buttons:

- The **Type** column displays the types of switching sheets you can create. Planned, Emergency, and Template are the base types.
- The **Description** column displays a description of the sheet type.

The **Pre-Created Switching Sheets** section displays a list of all existing switching sheets. It displays the following columns:

- **Status** displays the switching sheet state, such as New or Requested.
- **Type** displays the sheet type, such as Planned, Emergency, or Template.
- **Sheet #** is the number of the switching sheet. This number is automatically assigned by the system when the sheet is created.
- **User** is the ID of the user who created the sheet.
- **Pressure Zones** are the pressure zones associated with the sheet (as displayed on the Request tab).
- **Asset** is the asset associated with the sheet (as displayed on the Request tab).
- **Lift Station** are the lift stations associated with the sheet (as displayed on the Request tab).
- **Completed Date** is the completion date for the sheet.
- **Description** is the description of the sheet (as displayed on the Request tab).
- The **Create** button creates a new switching sheet of the selected type.
- The **Create a Copy** button creates a copy of the switching sheet selected in the **Pre-Created Switching Sheets** list. This button is not enabled unless a switching sheet and a sheet type are selected.

See Also:

- [Creating a Planned Switching Sheet](#)
- [Filtering the Switching Sheet List](#)
- [Sorting the Switching Sheet List](#)
- [Creating a Switching Sheet Template](#)
- [Creating a Switching Sheet from a Template](#)

Creating a Planned Switching Sheet

Follow these steps to create a planned switching sheet from the New Switching Sheet window:

- To create a new switching sheet from scratch, select **Planned** from the Switching Sheet Types section, and then click **Create**.
- To create a copy of an existing sheet, do the following:
 1. Select the sheet you want to copy from the Pre-Created Switching Sheets list.
 2. Select **Planned** from the Switching Sheet Types list.
 3. Click **Create a Copy**. (To search for a particular sheet, see [Filtering the Switching Sheet List](#) on page 8-13.)

Notes:



You can create a new sheet based on a sheet of a different type. For example, you can create a planned sheet based on an emergency sheet or create a template based on a planned sheet.

Although most fields are copied to the new sheet, some fields (such as Audit Log entries and step completion information) are cleared in the new sheet. If you copy a switching sheet that has one or more safety documents, copies of the safety documents are included with the new sheet.

Filtering the Switching Sheet List

Use the filter boxes at the top of each column to filter the list. Type all or part of the text you want to filter by. For example, to see only Planned sheets, type "Plan" in the Type filter box. The list is filtered to display only sheets where the Type column contains the characters "Plan." You can combine filter criteria by typing values in more than one column. As you type in each filter box, the list is filtered immediately based on entries in all boxes.

Sorting the Switching Sheet List

You can sort the list by clicking on a column header. A  or  icon indicates the column is being sorted in ascending or descending order, respectively.

Creating a Switching Sheet Template

Switching templates look like standard switching sheets, but they are used for creating and saving sheets that contain common information that is used repeatedly. The information may include:

- File attachments, which may be templates of other forms such as Excel Spreadsheets.
- Safety Documents
- View Areas.
- Pre-filled Request Tab Information.

Once you save the template, you can create a copy of it, and then edit the copy as needed. You can also copy individual steps from a template and paste them into another switching sheet. Templates can save you considerable time and effort when you are working with frequently performed switching sequences.

To create a template:

1. From the **File** menu, select **New**, and then select **Switching Sheet...** The New Switching Sheet window is displayed.
2. From the Switching Sheet Types section at the top of the window, select **Template**.

3. Do one of the following:
 - To create a new, blank template, click **Create**.
 - To create a template based on an existing sheet, select the sheet you want to copy from the Pre-Created Switching Sheets list, and then click **Create a Copy**. To search for a particular sheet, see [Filtering the Switching Sheet List](#) on page 8-13.

Note: Although most fields are copied to the new sheet, some fields (such as Audit Log entries and step completion information) are cleared in the new sheet.

Creating a Switching Sheet from a Template

After a switching template has been created and saved, you can use the template as the basis for another switching sheet.

To create a new planned sheet from a template:

1. From the **File** menu, select **New**, and then select **Switching Sheet...** The New Switching Sheet window is displayed.
2. From the Switching Sheet Types section at the top of the window, select **Planned**.
3. From the Pre-Created Switching Sheets list, select the template to use.
4. Click **Create a Copy**.
5. Edit the sheet as needed (see the instructions in the remainder of this guide) and save when you are done.

Switching Sheet Requests

Someone other than the person who prepares the switching sheet usually initiates switching sheet requests. The requester may be someone in the construction/maintenance department, while the preparer is typically an operations user assigned to look for and prepare new requests. Typically, the requester is a Switching Request user type.

Capabilities of the Switching Request User Type

Switching Request users do not have full access to all switching sheet information and operations. Specifically, Switching Request users are limited to the following capabilities:

- Creating and viewing "Planned" switching sheets only. All other types of switching sheets are not available to Switching Request users.
- Creating copies of existing switching sheets.
- Loading, printing, and emailing existing sheets. Only the information contained in the Request, Steps, Tracking/Audit Log, and External Documents tabs can be viewed, printed, or emailed.
- Performing the following operations on switching sheets that are in the New or Request Rejected state only:
 - Completing the fields on the Request tab.
 - Adding, removing, modifying, cutting, copying and pasting steps within the current sheet's Steps list. Steps can be added by using the Manual Step Addition panel (See [Adding Steps Manually](#) on page 8-33) or by adding Comment steps. Note that cut, copy and paste operations are only supported for sheets that are in the New or Request Rejected states.
 - Adding, removing, and viewing attachments on the External Documents tab.
 - Adding comment entries to the audit log on the Tracking/Audit Log tab.

- Incrementing and checking in versions of a switching sheet. This is done by selecting the Check-in button on the switching sheet toolbar.

Once a sheet has transitioned to (or beyond) the Prepared state, Switching Request users are limited to view-only mode.





Completing the Request Tab



Follow the steps in the previous sections to start a new planned switching sheet. Then use the Request tab to enter basic information about the switching sheet before you begin adding steps. When a new sheet is created, the user ID of the person who created it is automatically displayed in the Requested By field. You should complete as much of the information on this tab as possible.

When you have completed the information on the Request tab (fields described below), update the sheet state to **Requested** on the Tracking/Audit Log tab. See [Changing the Switching Sheet State](#) on page 8-17 more information.

Note: The switching sheet is automatically saved after a state change, and an entry is added to the audit log.

The Request tab contains the following fields:

- **Owner** displays the current owner of the switching sheet. See [Taking Ownership](#) on page 8-16 for more information.
- **Requested By** displays the person who requested the switching order. This field is initially populated with the ID of the user who created the switching sheet and can be updated. A value is required prior to submitting the request.
- **Phone Number** displays the phone number of the person requesting the switching order.
- **Email Address** displays the email address of the requester.
- **Customer Name** displays the name of the customer requesting the interruption.
- **Phone Number** displays the phone number of the customer requesting the interruption.
- **Email Address** displays the email address of the customer requesting the interruption.
- **Charge Number** allows you to enter charge numbers that can then be executed and/or used by the switching sheet preparer.
- **Office** displays the office responsible for the switching sheet.
- **Location** displays the street address or specific location for the switching operation.
- **Lift Stations** displays the lift stations where the switching operation takes place. The **Update** button () is used to update the **Lift Stations** field based on a distinct list of lift stations as identified by the asset populated in the **Asset** field and assets listed in steps.
- **Asset** displays the asset being worked on (not necessarily the asset being switched). This asset is given to the master event associated to the switching sheet after the switching sheet has been scheduled. The following buttons are displayed to the right of the **Asset** field:
 - The **Asset Lookup** button () is used to search for and select an asset.
 - The **Link Asset** button () to link an asset selected from the Viewer to this switching sheet. First, select the asset in the Viewer, then click this button. The **Asset** field is populated with the selected asset name. If the Link **Asset** button is selected when the Location, Lift Station, Pressure Zones, and/or Diameter fields are already populated, then a confirmation dialog box will be displayed asking if the user wishes to replace those values. This is similar to selecting the Update **Asset-Related Fields** option from the **Actions** menu.
 - The **Unlink Asset** button () is used to clear the asset field.

- The **Focus** button () is used to locate this asset in the Viewer.
- **Description of Work** displays a general description about what the switching sheet should try to accomplish.
- **Start Date** displays the date and time the switching work is scheduled to begin. This is required when scheduling a switching sheet. This is the Start Date given to the master event associated to the switching sheet after it has been scheduled. This is also used to generate the Impacted Customers list if no Planned Date is specified for a step. Enter the time in military time format (for example, 13:00 = 1 P.M.).
- **Alt. Start Date** displays the alternate date and time the switching work could begin. Enter the time in military time format (for example, 13:00 = 1 P.M.). The alternate start date must be later than the start date.
- **Finish Date** displays the date and time the switching work is scheduled to end. This field is required when scheduling a switching sheet. This date is the Estimated Restore Time (ERT) given to the master event associated to the switching sheet after it has been scheduled. The finish date must be later than the start date, and you must enter the finish time for the date to be valid. Enter the time in military time format (for example, 13:00 = 1 P.M.).
 - Use the  **Update ERT** button to update the ERT for the master event associated to the switching sheet. This option is only available after the sheet has been scheduled. This button is displayed next to both the Finish Date and Alt. Finish Date fields. The button is grayed if no date has been entered yet for the field.
- **Alt. Finish Date** displays the alternate date and time the switching work could end. The alternate finish date must be later than the alternate start date. Enter the time in military time format (for example, 13:00 = 1 P.M.).
- **Pressure Zones** displays pressure zones that are relevant to the switching sheet. This is a text entry field and is not auto-populated. The **Update** button () is used to update the **Pressure Zones** field based on a distinct list of pressure zones as identified by the assets populated in the Asset field and assets listed in steps.
- **Diameter** displays the asset diameter.
- The **Crew Will Switch** check box allows you to indicate whether the requesting crew will perform the switching activities.
- The **Crew Will Restore** check box allows you to indicate whether the requesting crew will restore the outage associated with the switching activities.

Taking Ownership

You can take ownership of a switching sheet to indicate that you are currently working the sheet. Once you take ownership, no other user is allowed to execute steps for the sheet or edit restricted fields. Other users can still view, lock, and edit certain fields on the sheet.

To take ownership of a plan, click the  **Take Ownership** button next to the Owner field on the Request tab. Your user ID is displayed in the Owner field. You can also use this button to take over ownership of a switching sheet that is currently owned by another user. This is useful if there is a shift change and the original user does not relinquish ownership before logging off.

To relinquish ownership, click the  **Relinquish Ownership** button.

An entry is recorded in the audit log whenever ownership of a sheet changes.

Changing the Switching Sheet State

A switching sheet passes through different phases during the creation and completion of the plan. These phases are represented by "states" that follow a logical sequence and determine what you can do with a switching sheet.

Note: The state of the switching sheet should not be confused with the status of individual switching steps within the switching sheet.

A switching sheet's current state is displayed on the Tracking/Audit Log tab. This tab also displays a button () for each valid state to which the sheet can transition and allows you to enter a comment associated with the state transition.

To change the state of a switching sheet, click the appropriate state change button on the Tracking/Audit Log tab. It is helpful to provide comments or a reason for the state change.

The Audit Log table on the Tracking/Audit Log tab shows a history of all state transitions for the sheet, including the ID of the user who updated the state and the timestamp of the change. See [Viewing the Audit Log](#) on page 8-60 for details.

Rework

The rework state is used to make updates to a previously completed switching sheet. The rework state allows numerous changes to be made to the switching sheet including, but not limited to:

- Adding, removing, and updating switching sheet steps. Any modifications made to the steps while in the Rework state will force the sheet to increment its version number by one.
- Updating the Request with further details.
- Updating the Impacted Customers list.
- Altering External Documents
- Manipulating associated safety documents.

While in the Rework state, special processing functions allow real-time completed steps to be deleted. The steps will remain linked to the switching sheet, but will be marked as deleted. If you change your view of the steps to view differences between another state where the step is present, then that step will show up in the Completed state, but will be marked with a red background and strike-through text. You will not be allowed to delete real-time completed steps that are linked to events or safety documents (an error dialog box will open if you attempt to do this).

The Rework state also allows the switching sheet's linked events to be corrected using Outage Correction. All of the rules that apply to standard Outage Correction switching sheets also apply to a switching sheet when it is in the Rework state. Any date related updates should be applied to the step's **Completed Date** column. See [Outage Correction](#) on page 8-96 for more details.

Switching sheets in the Rework state will not be flagged for model verification if any step asset has been altered by a model change. This is true for the Completed state as well.

When transitioning out of the Rework state and back into the Completed state, any step that is in the New or Uninstructed step will be automatically completed if you approve the change from the confirmation dialog box. If you do not approve the change, then the state transition will be canceled and it will be left to you to transition the incomplete steps to a terminal state.

Switching Sheet States

The following table describes the switching sheet states.

| State | Description |
|----------------|---|
| New | Indicates that the switching sheet is in the process of being created but has not yet been requested. When you create a switching sheet, its initial state is New. |
| Requested | Indicates that the sheet has been requested. A sheet transitions to this state when a user clicks the Submit Request button on the Tracking/Audit Log tab. This state is valid for planned switching sheets only. From this state, a sheet can progress to either the Rejected or Prepared state. |
| Rejected | Indicates that the request was rejected. A sheet transitions to this state when a user clicks the Reject button on the Tracking/Audit Log tab. The Reject button is grayed until you select a Reason. This state is valid for planned switching sheets only. From this state, a sheet can be requested again by clicking the Submit Request button on the Tracking/Audit Log tab. |
| Prepared | Indicates that the sheet has been prepared. A sheet transitions to this state when a user clicks the Prepare button on the Tracking/Audit Log tab. Although not required, all information for the switching sheet should be entered before you transition to this state. This state is valid for planned switching sheets only. From this state, a sheet can transition to the Checked state. |
| Checked | Indicates that the sheet has been checked. A sheet transitions to this state when a user clicks the Check button on the Tracking/Audit Log tab. All information for the switching sheet should be entered before you check the sheet. This state is valid for planned switching sheets only. From this state, a sheet can be approved, rejected, or scheduled. |
| Approved | Indicates that the sheet has been approved. A sheet transitions to this state when a user clicks the Approve button on the Tracking/Audit Log tab. All information for the switching sheet should be entered before you approve the sheet. This state is valid for planned switching sheets only. From this state, a sheet can be scheduled. |
| Check Rejected | Indicates that the sheet was rejected after being checked. A sheet transitions to this state when a user clicks the Reject button on the Tracking/Audit Log tab. The Reject button is grayed until you select a Reason. This state is valid for planned switching sheets only. From this state, the sheet can be prepared again. |
| Scheduled | Indicates that the sheet has been scheduled. A sheet transitions to this state when a user clicks the Schedule button on the Tracking/Audit Log tab. All information for the switching sheet should be entered prior to scheduling the sheet. This state is valid for planned switching sheets only. From this state, a sheet can be cancelled or issued. |

| State | Description |
|--------------|--|
| Canceled | Indicates that the sheet was cancelled. A sheet transitions to this state when a user clicks the Cancel button on the Tracking/Audit Log tab. The Cancel button is grayed until you select a Reason. This state is valid for planned switching sheets only. From this state, a sheet can be scheduled again. |
| Issued | Indicates that the sheet has been issued. A sheet transitions to this state when a user clicks the Issue button on the Tracking/Audit Log tab. All information for the switching sheet should be entered before issuing a sheet. This state is valid for planned switching sheets only. From this state, a sheet can transition to the Hold/Pending, In Progress (automatically), or Completed state. |
| In Progress | Indicates that at least one switching step in a planned or emergency switching sheet has been instructed or completed in real-time mode. From this state, a sheet can transition to the Hold/Pending or Complete state. |
| Hold/Pending | Indicates that the sheet is on hold. A sheet transitions to this state when a user clicks the Hold/Pending button on the Tracking/Audit Log tab. From this state, a sheet can progress to the In Progress (automatically) or Complete state. |
| Completed | Indicates that the sheet has been completed in real-time mode. A sheet transitions to this state when a user clicks the Complete button on the Tracking/Audit Log tab. A terminal action (Complete, Delete, Abort or Fail) must have been taken for each of the switching steps before a sheet can be completed. (See Switching Sheet Step States on page 8-31 for information about step states.) While the sheet is in the Completed state, it cannot be edited. This state applies to both planned and emergency switching sheets. |
| Rework | Indicates that the sheet has been previously completed and later placed into a rework state allowing further updates to be applied to the switching sheet. The Rework state is also used to enable Outage Correction for the events linked to the switching sheet. From this state, the sheet can again be transitioned to the Completed state. See Rework on page 8-17 for further details. |
| Deleted | Indicates that the sheet was deleted using the Delete button on the Tracking/Audit Log tab. The Delete button is grayed until you select a Reason. |

Adding and Editing Steps

This section describes how to add and edit steps in a switching sheet. It includes the following topics:

- [Steps Tab](#)
- [Switching Sheet Step States](#)
- [Adding Recorded Steps to a Switching Sheet](#)
- [Adding Comment Steps](#)
- [Copying and Pasting Steps](#)

- [Creating Go-Back Steps](#)
- [Working with Blocks](#)
- [Grouping and Ungrouping Steps](#)
- [Editing Existing Steps](#)
- [Finding and Replacing an Asset in the Steps](#)
- [Finding and Replacing Text in the Steps](#)
- [Focusing on an Asset in a Step](#)
- [Moving a Crew](#)

Steps Tab

Use the Steps tab to add, edit, record, instruct, and execute steps in a switching sheet.

Steps tab topics include:

- [Steps Tab Fields](#)
- [Steps Tab Toolbar and Context Menus](#)
- [Steps Tab Events and Crews Pane](#)

Steps Tab Fields

The steps table on the **Steps** tab displays the following fields:

- **Step #** displays the number of the step.
 - For a block header row, this column displays the block name.
 - For a step row, this column displays the step number (1 through n).
 - For a sub-step within an aggregate step, such as Open & Tag, this column displays the sub-step number (a-z). Blocks and aggregate steps can be expanded or collapsed by clicking the + or - sign.
 - If you are viewing the differences between this version and another version, this column uses outline numbering (1.1, 1.2, and so on) to identify steps that were added since the previous version. See [Working with Switching Sheet Versions](#) on page 8-49 for more information.
- **Version** displays the version number of the switching sheet when the step was added. See [Working with Switching Sheet Versions](#) on page 8-49 for more information.
- **Operation** displays the description of the switching action. When the switching action is associated to a safety document, then the safety document type and number will be displayed in this field after the switching description. This field is editable, but only if the step action is a non-operational action. In other words, if the action for this step does not impact the NMS model in any way and is not tied to another NMS tool or feature, then the text can be edited in this column. Edited text will show up with a yellow background color. To reset the value, see [Resetting Operation Text](#) on page 8-33.
- **Asset** displays the asset alias referenced in the step.
- **Details** displays information about the outcome of the switching step, such as:
 - Isolate a section.
 - Restore a section.
 - Make a loop.
 - Break a loop.
 - Make a parallel. (The pressure zones involved in the parallel will be listed.)

- Break a parallel. (The pressure zones involved in the parallel will be listed.)

This information is recorded into the step when the step is initially added to the switching sheet, but is not dynamically updated as changes are made to the sheet. You can enter text into this field to replace the text that is automatically inserted.

- **Status** displays the state of the switching sheet step. See [Switching Sheet Step States](#) on page 8-31 for information.
- **Planned Date** displays the proposed date/time when this step will be performed. The Planned Date is used to generate more accurate and detailed Impacted Customer lists **and** to specify the ERT for the generated Planned Events. This date must be within the Start and Finish Dates specified on the Request tab. This date is automatically updated when the switching sheet's Start and Finish Dates are updated. Thus, if the work is rescheduled, the planned date values do not have to be manually updated as well.
- **Executed By** displays the user ID of the person who completed the step in real-time mode. This field is automatically populated by the system.
- **Completed Date** displays the date the step was completed. If this field is blank when a step is completed, failed, or aborted in real-time mode, then the system populates this field automatically. If you enter a date in this field before executing a step, that date is used instead. This allows you to specify when an action actually occurred. (This field is similar to the date field on the Control Tool.) If you attempt to edit this date after the step has been completed in real-time, the system checks to see if the step affects any events. If it does, the system prompts you to confirm that you want to change the affected start date or restoration date, as applicable, based on the event association.
- **Instructed By** displays the user ID of the person who instructed the step in real-time mode. This field is automatically populated by the system.
- **Instructed To** displays the IDs of the crews to which the step was instructed. This field is automatically populated if crews are selected in the Crew List on the Steps tab header when you instruct a step. This field cannot be edited manually.
- **Instructed Date** displays the date and time the step was instructed. If this field is blank when the step is instructed, then the system populates this field automatically. If you enter a date in this field before instructing a step, that date is used instead.
- **Address** displays the address of the asset referenced in this step. This field is automatically populated if you record the step by initiating an action within the Viewer. This field is editable and can be used to update address values of future recorded steps. For more information, see [Save all asset addresses to the database](#) on page 8-22.
- **Comments** displays any additional information associated with this step. You can enter free-form text in this field.
- **Hidden Columns:** The following columns are hidden by default from view.
 - **Cond Cls** displays the step's associated condition handle class.
 - **Cond Idx** displays the step's associated condition handle index.

The Cond Cls and Cond Idx columns display the class and unique condition identifier, respectively, associated to the step. A condition handle is associated to a step when the step manipulates a condition, such as an Apply Condition step.







To display the Cond Cls and Cond Idx step columns, right-click the Steps table header row and select **Select Columns...** to open the Select Columns to Display dialog box. Select **Cond Cls** and **Cond Idx** and click **OK**.

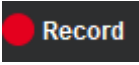

Steps Tab Toolbar and Context Menus

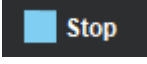
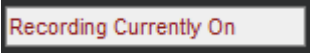

The Steps tab toolbar displays buttons for actions that you can perform. If a button is grayed, then that action is not currently permitted. For example, if you are currently in Study Mode, then the







Start Study Session button is grayed. Some toolbar buttons, such as the Cut and Paste options, are also available through a context menu that is displayed when you right-click a step row. The context menu contains some options that do not appear on the toolbar.







The following table describes all actions that can be performed on the Steps tab with toolbar buttons, keyboard shortcuts, and/or context menu items.





| To perform this action: | Comments |
|---|--|
| Turn record mode on Click  | Record mode must be on in order to record operations using the Viewer and Control tool. The status bar displays the recording mode status:  |
| Turn record mode off Click  | The status bar displays the recording mode status:  |
| Save all asset addresses to the database Click  | If you change one or more asset addresses in a switching sheet, this action updates the assets' addresses throughout the switching sheet and also updates the asset attribute table so that any new switching sheets referencing these assets will use the new addresses. |
| Focus the Viewer on the objects referenced in the currently selected list of steps Click  | The toolbar button, when used with single step selections, will focus on a single asset and set the environment's selected asset to the step's associated asset. When multiple steps are selected, the Focus button will force the viewer to display all of the step assets in one view. Note: If you have assets across many pressure zonesth, then many maps may need to be loaded to accommodate your request. This multi-asset option is similar to the Dynamic View area each switching sheet automatically has associated to it on the View Areas tab. |
| Instruct the selected steps Click  | This action is only permitted in real-time mode when the plan reaches Issued state. Note that step order execution rules apply when enabling this button (see Step Order Execution Rules on page 8-38 for details). When you select this button, the Instructed By and Instructed Date columns are populated. |
| Complete the selected steps Click  | Once the action is complete, the status of the step changes to <i>Completed</i> (see Switching Sheet Step States on page 8-31). If you are in real-time mode, the Completed Date column is also updated with the current date. Note that step order execution rules apply when enabling this button (see Step Order Execution Rules on page 8-38 for details). The Complete button is enabled in real-time mode when the plan reaches the Issued state. Note: To complete a step in real-time mode, you must have authority over the asset. |

| To perform this action: | Comments |
|--|---|
| Abort the selected steps Click  | Use this action if a step was never attempted. When you click this button, the status of the step changes to <i>Aborted</i> (see Switching Sheet Step States on page 8-31). If you are in real-time mode, the Completed Date column is updated with the current date. However, the switching action is not actually performed. |
| Mark the selected steps as failed Click  | Use this if a step was attempted but failed. When you click this button, the status of the step changes to <i>Action Failed</i> (see Switching Sheet Step States on page 8-31) and the Completed Date column is updated with the current date. However, the action is not actually performed against the real-time data model. |
| Uninstruct an instructed step Click  | Use this action to change the state of an instructed step to <i>Uninstructed</i> (see Switching Sheet Step States on page 8-31). If the step has an asset and an instruct condition on the asset, then the condition will be removed prior to the step transitioning to the <i>Uninstructed</i> state. Steps that are in the <i>Uninstructed</i> state can be instructed again or aborted, failed or completed. Notes: <ul style="list-style-type: none"> • The uninstruct action is not available for SCADA instructed actions. This option is not available for steps in the <i>SCADA Pending</i> state. • Uninstructed steps may be deleted. • If you are using version controls, uninstructed and deleted steps may be red-lined and not deleted from the database. See Working with Switching Sheet Versions on page 8-49 for more information. |

| To perform this action: | Comments |
|--|---|
| Verify steps after a model edit Click  | <p>This action is available if model changes have occurred that impact one or more assets in the switching sheet. The Web Switching service checks all the opened switching sheet steps after a model edit has occurred. If a step has an asset that matches an asset that was directly impacted by a model change, that step will be marked as needing verification. When the sheet is displayed, these steps will be highlighted in yellow. You can either check off each step in the sheet as they are verified or check off the entire sheet.</p> <p>Notes:</p> <ul style="list-style-type: none"> • Outage Correction sheets are not included in this processing. Outage Correction validates the assets when the correction is made. • While the sheet has verifications pending, step executions cannot be performed within the sheet. • Switching sheets in the Completed or Rework states are not included in this processing. <p>Individual Verification</p> <ul style="list-style-type: none"> • To check off each step individually, right-click the highlighted step and select Model Verify. <p>Whole Sheet Verification</p> <ul style="list-style-type: none"> • To check off all of the steps in a sheet, click  to Confirm all model changes. All highlighted steps will be marked as verified. <p>Once the steps have been verified, step execution can continue for the sheet.</p> |
| Reset study session and clear the status of the steps Click  | <p>This action is only available in Study Mode. When you click this button, you are prompted to select either Real-Time, Nominal, or the Save Case Management tool.</p> <ul style="list-style-type: none"> • Choose Real Time to replicate the real-time asset states. • Choose Nominal to reset all assets to their predefined normal state. <p>Note: The Real Time and Nominal options will immediately clear the status of the steps in the current sheet. They will also clear the study step statuses in any other open sheets.</p> <ul style="list-style-type: none"> • Choose Save Case Management... to display the Save Case Management tool, which allows you to reset to a save case. See Using the Save Case Management Tool on page 1-64 for more information. |

| To perform this action: | Comments |
|-------------------------------------|--|
| Switch to current Real-Time Mode | Click  This action is only available when you are in Study Mode. When you click this button, the status bar displays real-time mode in red and Viewer changes to real-time mode. |
| Switch to Study Mode | Click  This action is only available when you are in real-time mode. When you click this button, the status bar displays study mode in gray and Viewer changes to study mode. |
| Find and replace text | Click  Use this to find and replace all occurrences of an asset (see Finding and Replacing an Asset in the Steps on page 8-40) or text (see Finding and Replacing Text in the Steps on page 8-41) in the switching steps. |
| Cut steps to the clipboard | Click  Select one or more steps. The selected steps are marked as being cut and are placed on the clipboard. The steps will only be moved after they have been pasted to their new location. Use the Paste option to paste the steps. This option is disabled if the sheet is in view only mode or the sheet state is Completed. Alternatively, right-click and choose Cut from the context menu or press Control-X . |
| Move Steps to the Miscellaneous Log | -- This action moves Real Time Completed, Aborted, Failed or Instructed steps to the Miscellaneous Log. SCADA Pending steps cannot be moved until they have transitioned to one of the states already stated. Steps associated to safety documents are also not allowed to be moved. Any step in a New or Uninstructed state will not be moved as the Miscellaneous Log only displays Real Time steps that are in a terminal or Instructed state. Any attempt to move an immovable step will result in an error dialog box and the steps will not be moved from the switching sheet's steps list. To move steps to the Miscellaneous Log, select one or more steps and select Move Steps to Misc Log from the Actions menu or from the right-click context menu. |
| Copy steps to the clipboard | Click  You can select one or more steps. The selected steps are copied to the clipboard. Use the Paste option to paste the steps. Alternatively, right-click and choose Copy from the context menu or press Control-C . |
| Copy steps as go-back steps | Click  You can select one or more steps. Reverse steps are created for each selected step and copied to the clipboard. Use the Paste option to paste the steps. Alternatively, right-click and choose Copy as Go-Backs from the context menu or press Control-G . |

| To perform this action: | Comments |
|--|--|
| Paste steps from clipboard  | <p>Steps are pasted after the currently selected step. The operation pastes the steps that were placed in the clipboard during the last Cut, Copy, or Copy as Go-Backs operation. Once the steps have been pasted, the Paste button is no longer available and the contents of the clipboard are cleared. This option is disabled if the sheet is in view only mode or the sheet state is Completed.</p> <p>Alternatively, right-click and choose Paste from the context menu or press Control-V.</p> |
| Delete steps  | <p>Deletes the selected steps from the plan. This button is disabled if the sheet is in view only mode or if the step has transitioned beyond its initial state (No State).</p> <p>Alternatively, right-click and choose Delete from the context menu or press Control-D.</p> |
| Undo the last action  | <p>Allows you to undo the last action (Cut/Paste, Copy/Paste, Delete, Add Step). The Undo function returns an error (<i>Undo is not supported across multiple sheets.</i>) when:</p> <ul style="list-style-type: none"> attempting to undo pasting steps cut from another switching sheet the last action was not on the currently active sheet; for example, if you insert a step on Sheet A and then switch to Sheet B and click Undo. <p>Alternatively, right-click and choose Undo from the context menu or press Control-Z.</p> |
| Return to Nominal  | <p>The Return to Nominal function generates a block of switching sheet steps that contain all the steps needed to switch the affected assets back to nominal. They will be presented in a logic order, will not outage any customers, and are logically grouped.</p> <p>Note: The generated block of steps are not go-back steps.</p> |
| Add a Safety Document for a step  | <p>The Create Safety Document for Selected Step button creates a safety document for a selected step. If the system cannot determine the type of safety document to create for the step, the Select Safety Type dialog box will open so you may choose the type. If the step selected is not valid for safety documents, an error dialog box will be displayed. An error dialog box will also be displayed if any of the selected steps are already linked to a safety document.</p> <p>Once a safety document type has been determined or selected, the safety document dialog box opens. This option is disabled if the sheet is in view only mode or the sheet state is Completed. See Working with Safety Documents on page 8-77 for more detail.</p> |
| Create a Safety Document  | <p>The Create Safety Document button opens a context menu that allows you to choose a safety document type or open the Select Safety Type dialog box. See Working with Safety Documents on page 8-77 for more detail.</p> |

| To perform this action: | Comments | |
|---|---|---|
| Remove Links to Safety Documents | Click  <p>Unlinks (removes the association to) a step's asset from a safety document's asset list. First, select the step with the asset operation you want removed from the safety document, then click the button. See Linking and Unlinking a Step to Safety Document on page 8-38 for details. Alternatively, right-click and select Remove Links to Safety Documents from the context menu.</p> | |
| Complete all steps up to the selected step in 'silent' mode | Click  <p>Use this action to complete all steps up to and including the selected step in 'silent' mode, which means that the system will auto-complete the operations without displaying the Look Ahead window. This option is only available in Study mode if you select a single row that has not already been completed. This is useful if you need to get a study session back to a point where you previously left off.</p> <p>Alternatively, right-click and choose Complete to Here from the context menu.</p> | |
| Show or hide events and crews | Click  to show or hide the header | Shows or hides the Events and Crews pane, which displays crew and event associations. See Steps Tab Events and Crews Pane on page 8-29. |
| Show Manual Step Addition Form | Click  <p>Shows the Manual Step Addition pane, which allows you to add steps without using the Control Tool. See Adding Steps Manually on page 8-33.</p> | |
| Add a new block header | Right-click and choose Add New Block Header from the context menu, then select the block type | Inserts a new block header of the selected type: Isolate, Fault Location, Maintenance, Restore, Construction, or Custom. If you choose Custom, you are prompted to enter the block header name. See Adding a New Block Header for more information. This option is disabled if the sheet is in view only mode or the sheet state is Completed. |
| Rename an existing block header | Right-click and choose Rename Block Header from the context menu, then select the block type | Rename an existing block header to one of the following types: Isolate, Fault Location, Maintenance, Restore, Construction, or Custom. If you choose Custom, you are prompted to enter the new block header name. See Renaming a Block Header on page 8-35 for more information. This option is disabled if the sheet is in view only mode or the sheet state is Completed. |
| Change an instructed date | Right-click and choose Update Instructed Dates... from the context menu. | This option is used to update multiple Instructed Date step fields in one operation. When selected, this option will display the Update Instructed Date dialog box. From this dialog box you can enter in a new Instructed Date for the steps that are currently highlighted in the steps list. Any steps that have not been instructed will not be updated. |
| Clear the Planned Date field for this step | Right-click and choose Clear Planned Date from the context menu. | This action is only available if the step has a value in the Planned Date column. Click this button to remove the date and leave the Planned Date column blank. This option is disabled if the sheet is in view only mode or the sheet state is Completed. |

| To perform this action: | | Comments |
|--|--|--|
| Clear the Instructed To field for this step | Right-click and choose Clear Crews from the context menu. | This action is only available if the step has a value in the Instructed To column. Click this button to remove the crew and leaves the Instructed To column blank. This option is disabled if the sheet is in view only mode or the sheet state is Completed. |
| Clear the step's Condition Class and Index fields for this step. | Right-click and choose Clear Condition Indexes from the context menu. | The action will only happen for steps that are not in a terminal state and steps that are not associated to safety documents. Click this button to remove the condition class and index associated to the step. An error dialog box will be displayed if any of the selected steps' condition handles could not be cleared. |
| Group steps | Right-click and choose Group Steps from the context menu. | Groups the selected steps and draws a bracket around them in the Steps list. This allows steps to be completed in or out of order within the grouping depending on the switching sheet type. See Grouping Steps on page 8-37. This option is disabled if the sheet is in view only mode or the sheet state is Completed. |
| Ungroup steps | Right-click and choose Ungroup Steps from the context menu. | Ungroups the selected steps and revises or removes the group bracket. (If you ungroup the third of three steps, the first 2 remain grouped.) See Ungrouping Steps on page 8-37. This option is disabled if the sheet is in view only mode or the sheet state is Completed. |
| Insert a blank step | Right-click and choose Insert Blank Step from the context menu. | Inserts a new blank step after the currently selected step. This is useful for adding comment steps. See Adding Comment Steps on page 8-33 for more information. This option is disabled if the sheet is in view only mode or the sheet state is Completed. |
| Mark the location where steps should be inserted | Right-click and choose Place Step Insertion Indicator from the context menu. | Designates where newly recorded steps should be added. When you choose this option, a visible marker appears. The next recorded step is inserted after the marker. Each time you add a recorded step, the marker moves down to the newly recorded step, so that steps are added in the order in which they were recorded. This option is disabled if the sheet is in view only mode or the sheet state is Completed. |
| Remove step insertion indicator | Right-click and choose Remove Step Insertion Indicator from the context menu. | When you click this option, the indicator is removed and any newly recorded steps will be added to the end of the steps list. This action is only available when the step insertion indicator is showing. |
| Link to Safety Document | Right-click and choose Link to Safety Document from the context menu. | When you click this option, all safety documents associated with the switching sheet will be displayed. On selecting any of the safety documents in the sub-menu, the selected safety document will be associated to the currently selected step. See Linking and Unlinking a Step to Safety Document on page 8-38 for details. |
| Load the associated safety documents | Right-click and choose Load Safety Documents... from the context menu. | If any of the selected steps are associated to a safety document, then that document will be loaded for each step. The document type and number appear in the Operation column of the step when there is an association. |
| Move the crew symbol to a new asset in the Viewer | Right-click and choose Move Crew from the context menu. | When this option is selected for a step with a crew instruction, the crew symbol within the Viewer is moved to the asset specified in that step. This feature is only used to move the crew symbol within the viewer. |

| To perform this action: | Comments | |
|---------------------------------|---|---|
| Move a column in the Steps list | Click the column heading and drag it to the desired position. | This allows you to rearrange the order in which columns are displayed. For example, if you want each step's status to display in the first column, click the Status column header and drag it to the left of the Step # column. |

Steps Tab Events and Crews Pane

The **Events and Crews** pane provides information on the events and crews associated with the sheet. Use the **Show Event and Crews** (▼) and **Hide Events and Crews** (▲) buttons on the Steps tab toolbar to expand and minimize the pane.

Events List

The **Events List** lists all events associated with the switching sheet. If you created a switching sheet from the Work Agenda Event List, the associated event is automatically displayed in the Events list. Use this list to view, add, and remove event associations and to view more information about the events. (For more information about associating events to switching sheets, see [Event Associations](#) on page 8-74.)

The Events List displays the following fields and buttons:







- The **Event** column displays the number of the associated event.
- The **Association** column displays the type of association. The list can have the following types of associations and will be listed in the order of Master, Planned, Forced, Manual and Canceled. Manual event associations are event associations that are added using the Add Event Association button on this window.
- The **# Out** column displays the number of customers outaged by this event.
- The **Status** column displays the status of the event, such as NEW, P-NEW (New Planned Event), or W-ASN (Master Switching Event).
- The **Asset** column displays the name of the asset.
- The **Add Event Association** button (+) opens a dialog box that allows you to enter an event number to associate with the switching plan. The event number can also be populated by selecting an event in the Work Agenda Event List. These events will show up as "Manual" associated events within the Events list. See [Event Associations](#) on page 8-74 for more information.
- The **Remove Event Association** button (🗑️) removes the selected event association from the switching plan. When an event is linked to a switching sheet step, an error dialog box will open indicating this and the removal will be canceled. To remove events that have linked steps, the steps have to be moved in order for the event to be removed. This option is disabled if the sheet is in view only mode or the sheet state is Completed.
- The **Event Details...** button (i) displays the Event Details window for the selected event.
- The **Call...** button (📞) displays the Event Details Trouble Info tab for the selected event.
- The **Highlight in Work Agenda** button (📅) selects the event within the Work Agenda Event List.
- The **Show in Viewer 1** button (🎯) focuses Viewer 1 on the associated asset.

Crews List

The Crews List displays crews that are associated to the switching sheet; they may be directly associated using Crews List **Select Crew...** function or by virtue of being assigned or en route to

an associated event. If you created a switching sheet from the Work Agenda Event List, any crew associations are automatically displayed in the Crews list on the Steps tab header.

The Crews List displays the following information:

- The **Crew ID** column contains the crew ID of the crew.
- The **Event** column contains the event number the crew is assigned or en route to.
- The **Contact** column contains the contact name for the crew.
- The **Mobile #** column contains the contact's mobile phone number.
- The **Pager #** column contains the contact's pager number.
- The **ASN/ENR Date** column contains the date and time of when the crew was assigned or placed en route to the event shown in the Event # column.
- The **Status** column indicates whether the crew is assigned or en route to the event shown in the Event # column.
- The **Type** column contains the crews' type (for example, Trouble).
- The **Crew Info** button () displays the Crew Info window for the selected crew. This button is enabled only if a crew is selected from the list. For more information, see [Associating Crews](#) on page 8-44.
- The **Update 'Instructed To' in Steps** button () updates the Instructed To column for the selected steps with this crew's ID. This option is disabled if the sheet is in view only mode or the sheet state is Completed. This action will only be applied to steps in the Instructed or Completed states. Any selected step in any other state will be ignored.
- The **Move Crew** button () allows you to move a crew to the asset associated with the selected step. This button is enabled only when the selected crew is en route or on-site to the associated event.
- The **Select Crew...** button () opens the Select Crew dialog box from which you may select crews or create contractor (foreign) crews to associate to the switch plan. For more information see [Assigning Crews to a Switching Sheet](#) on page 8-30.
- The **Remove Crew** button () removes the selected crew from the table if they were added with the **Select Crew...** () action and are not assigned, en route, or onsite.

Assigning Crews to a Switching Sheet

The Select Crew dialog box allows you to assign crews to the switching sheet. You may also create contractor crews on the **Contractors** tab.

Selecting Crews from the System Crews List

To assign a standard (system) crew to the switch sheet

1. Click the **Select Crew...** button () to open the Select Crew dialog box
2. On the **System Crews** tab, select one or more crew rows in the table.
3. Click **OK** to assign the crews and close the dialog box.

Note: Click **Apply** to assign the selected crews without closing the dialog box.



Creating and Assigning Contractor Crews from the Contractor Entry Form

You may add a new contractor crew using the Contractor Entry Form. The created crews are assigned to the current sheet and added to the Contractor Crew List from which they may be assigned to other switching sheets or safety documents.

The form contains the following fields:

- Crew ID: the crew name or identifier.
- Contact: the name of the crew contact person.
- Mobile #: the crew's mobile number.
- Pager #: the crew's pager number.
- Type: crew option menu that allows you to choose the crew type.
- Comments: text field for comments.

Actions

- **Create and Assign Crew** (): assigns the new crew entry to the switching sheet and adds them to the contractor crew list; the Select Crew dialog box closes when this button is clicked.
- **Clear Crew Fields** (): clears the entry form.

Using the Contractor Crew List



The Contractor Crew List allows you to assign existing contractor crews to the switch sheet or populate the Contractor Entry Form to reuse crew data when creating additional contractor crews.

Assigning an Existing Contractor Crew

1. Select the crew rows in the Contractor Crew List.
2. Click the **Create and Assign Crew** button () to assign the crews to the sheet.

Assigning a New Contractor Crew Using Existing Crew Data

To create an additional contractor crew using data from an existing crew, do the following

1. In the Contractor Crew List, select the row with the desired crew data.
2. Click the **Transfer Crew Data** button () to copy the data to the Contractor Entry Form.
3. Edit the data for the new crew.
4. Click the **Create and Assign Crew** button () to assign the new crew to the safety document and add them to the Contractor Crew List.

Switching Sheet Step States

Switching sheet steps go through stages or states, just like switching sheets. Step states are described below:

Note: The status of steps that are executed in Study mode is prefixed with a two-character text string. (The default prefix is "ST," but this is configurable during system implementation.) Thus, a step that was completed in real-time mode would display the status "Completed," while a step completed in Study mode would display "ST Completed."

- **No state** - No action is associated with the step.
- **Instructed** - The step was instructed.
- **Uninstructed** - The instructed step was uninstructed.
- **Completed** - The step was successfully completed.
- **Partially Completed** - This state applies only to parent aggregate steps and indicates that some but not all child steps were completed.
- **Previously Completed** - This state occurs when a step is completed, but the asset was already in the desired state.

- **SCADA Pending** - This state applies only to actions that the system identifies as SCADA actions (that is, actions on telemetry-controlled assets). It indicates that a SCADA action was instructed.

Note: If the system detects that the asset was operated as instructed, the step state is then changed from SCADA Pending to Completed. If an error or timeout occurs, the step remains in SCADA Pending state.

- **Deleted** - The step was deleted from the sheet.
- **Aborted** - The step was marked as aborted by the user. (A step transitions to this state when the user selects the **Abort** option on the Steps toolbar.)
- **Failed** - The step was marked as failed by the user. (A step transitions to this state when the user selects the **Fail** option on the Steps toolbar.)

Note that a terminal action (Complete, Delete, Abort or Fail) must have been taken for each of the switching steps before a sheet can be completed.

Adding Recorded Steps to a Switching Sheet

Follow these steps to add recorded steps to a switching sheet using the Viewer and the Control Tool.

Notes:

For information about adding steps to an emergency switching sheet, see [Emergency Switching](#) on page 8-68.

To record safety state transition steps (*that is*, steps that are associated to safety documents), see [Adding a Safety State Transition Step](#) on page 8-84.

1. Create or open a switching sheet (as described earlier) and display the **Steps** tab.
2. Select the step after which you want the recorded steps inserted. Right-click this step, then choose **Place Step Insertion Indicator** from the context menu. By default, steps are added to the end of the list.
3. If the Viewer is not displayed, open a Viewer by clicking the **Viewer 1** button on the Web Workspace toolbar or selecting **Viewer 1** from the Tools menu.
4. Verify that Web Switching Management is in Study Mode.
 - To enable Study Mode, click the **Switch to Study Mode** button on the Steps tab toolbar. The status bar should display "Study Mode."
5. Verify that Viewer is in Study Mode.
 - To enable Study Mode, select **Study** from the Viewer's **Options** menu.
6. Verify that recording is enabled.
 - To turn recording on, click the **Record** button on the toolbar. When recording is enabled, the toolbar displays **Stop**.
7. In the Viewer, search for the asset on which you want to perform an operation.
8. Double-click the asset. The Control Tool opens.
9. Select the action you want to perform. For example, to open an asset, click **Operate** and then select **Open** from the list of operations. To place a tag on an asset, click **Tag** and then select **Place Tag**.
10. If the step involves an asset operation, the Look Ahead window opens. Click **Open** or **Close** in the Look Ahead window to continue.



Note: The Look Ahead window informs you of the results of the operation, including the creation of parallels and loops, the number of critical customers affected, and related abnormal assets and conditions. You may be required to

view additional tabs, such as View Conditions, before you can close the Look Ahead window.

11. Click **Exit** on the Control Tool dialog box. The asset is updated in the Viewer and a step is added to the steps list. The new step is automatically selected.

Adding Steps Manually

The **Manual Step Addition** form allows you to add steps to a switching sheet without using the Control Tool. To add a step manually, complete the following steps:

1. Click the **Manual Step Addition** button () to display the Manual Step Addition form.
2. Add asset information to the **Asset** field using one of these methods:
 - Select the asset in the Viewer and click the **Set Asset** () button. The asset field will be populated with the asset alias of the selected asset.
Note: This method is not available to the Switching Request user type.
 - Enter a partial asset alias and search for it by clicking the **Search** () button to open the **Select Asset** dialog box. Select the asset and click **OK**.
 - Enter an asset alias directly. When you tab out of the field, the system will validate that the asset; if the asset is not valid, the field will be highlighted to indicate that it should be corrected.

Click the **Show in Viewer** button () to focus the Viewer on the selected asset.

3. Add the Operation. The operation is made up of two fields: a short operation code and an operation description. Click in either field and click the **Search** button () to open the **Select Operation** dialog box, which is filtered to only display operations (and the corresponding operation code) valid for the asset type. Select an operation and click **OK** to add the operation or click **Cancel** to close the dialog box without a selection.

Note: If you know the operation code, you may enter it directly. If the operation code is invalid, the background of both fields will be red and the second text field will be blank. If the operation code is valid, the background of both fields will be white and the second field will display the operation description corresponding to the typed in operation code.
4. Click the **Add Step** button () to add the manual step to the switching steps.

Adding Comment Steps

You can add comment steps that are not related to a specific asset or operation. To add a comment step, select the step after which you want the comment step inserted. Right-click this step, then choose **Insert Blank Step** from the context menu. With the row selected, click in the Operation column to enable adding a description of this step; the Details column is also available for descriptive text.

Note: You may enter text in the Operation, Details, Address, and/or Comments fields. You can also specify Date fields for the step. The other fields are populated automatically when you instruct and complete the step.

Resetting Operation Text

Operation text that has been manually entered may be reset to its original value by following the following steps:

- Right-click to select the row and open the option menu.

- Select **Reset Operation Text**. The **Reset Operation Text** dialog box will open to confirm that you want to change the Operation text back to its original value.
- Click **Yes** to reset the value.

Note: Click **No** to close the dialog box and leave the Operation text unchanged.

Copying and Pasting Steps

You can copy or cut steps and then paste them to another location within the step list or into another switching sheet. When you cut steps, they are marked as 'cut' in the steps list and are copied into the clipboard. When you copy steps, they are copied to the clipboard, but the original steps are not marked or removed from the list.

The in-order step execution rules are not enforced when cutting and pasting steps. Switching steps that were previously completed can later be cut and pasted into any location within the step list. This also pertains to cutting and pasting steps from one sheet to another.

If you cut and paste steps from one sheet to another, the system determines which events have associations with these steps and automatically moves the corresponding event/sheet associations from the old sheet to the new sheet. If you attempt to move some but not all of the steps for an event, the system displays a confirmation dialog box indicating the affected events. If you confirm the action, then both the old sheet and the new sheet will have an association to the affected events. Any step moves that affect event associations are recorded in the audit log for tracking purposes.

Follow these steps to use the cut, copy, and paste functions:

1. Select the steps you want to cut or copy.
2. Click the **Copy Steps** or **Cut Steps** button (or right-click the selected steps and choose **Copy** or **Cut** from the context menu).
3. Select the step after which you want the steps inserted and click the **Paste Steps** button (or right-click the step and choose **Paste** from the context menu). Any cut steps are moved, and copied steps are duplicated.

Note: Once the step has been pasted, the Paste button is no longer available and the contents of the clipboard are cleared.

Creating Go-Back Steps

When you are creating a switching sheet in Study Mode, you can automatically generate a sequence of switching steps to "go-back" to the original state. The Go-Back feature creates a new sequence of steps that reverses the existing sequence. For example, assume that Step 1 involves opening an asset. If you select this step and choose Copy as Go-Backs, the system creates a step to close that asset and copies the step to the clipboard. You can then paste the step in the appropriate location in the step list.

To create go-back steps for one or more steps, do the following:

1. Select the step or the range of steps you want to create reverse actions for.
2. Click the **Copy As Go-Backs** button (or choose **Copy as Go-Backs** from the context menu). Go-Back versions of the selected steps are copied to the clipboard.

Note: If you selected one or more steps that are part of an aggregate step, all steps within the aggregate are automatically selected and copied as go-back steps. (An aggregate step is an operation, such as Open and Tag, that comprises two or more sub-steps, numbered a through z.)

3. Select the step after which you want the go-back steps inserted and click the **Paste Steps** toolbar button (or choose **Paste** from the context menu). The steps are pasted after the selected step.

Working with Blocks

Blocks are used to organize steps based on stages of execution. A block is a series of contiguous steps that can include both single (ungrouped) steps and groups of steps. Note the following when working with blocks:

- When you create a new sheet, the system creates an empty block named "Default." When you add steps, they are added to this block by default. You can delete this block and create a new top-level block if you wish.
- The system provides several pre-configured block headers – Isolate, Fault Location, Maintenance, Restore, and Construction – or you can create your own custom header. The header is simply the block name that is displayed in the Steps list.
- To expand a block and display its steps, click the + symbol to the left of the block name. To collapse a block and hide its steps, click the - symbol.
- All steps within a block must be completed before a step within another block can be completed, unless the block names are the same and the blocks are adjacent (not separated by any blocks of different names). See the [Parallel Step Execution](#) on page 8-35 for more information about parallel execution of block steps.

Adding a New Block Header

To add a new block header to the steps list:

1. From the Steps tab, right-click the step after which you want to insert a block. An option menu appears.
2. Select **Add New Block Header**, then select a block header type: Isolate, Fault Location, Maintenance, Restore, Construction, or Custom.

Notes:

- If you choose Custom, you are prompted to enter the block header name.
- If the only step row in the steps list is the Default block header row and you add a new block header, then the Default block header row will be replaced with the newly added block header row. This is only the case if there are no other steps in the switching sheet.

A new block header row is added to the steps list.

Renaming a Block Header

To rename a block header in the steps list:

1. From the Steps tab, right-click the block step that you want to rename. An option menu appears.
2. Select **Rename Block Header**, then select a block header type: Isolate, Fault Location, Maintenance, Restore, Construction, or Custom.

Note: If you choose Custom, you are prompted to enter a new block header name.

The selected block header row is renamed.

Parallel Step Execution

Parallel execution allows an operator to direct one crew through a set of steps in one block and another crew through a set of steps in another block. This provides the operator more flexibility when executing switching steps and more closely correlates with their actual business process.

Blocks of steps with the same block names can be executed in parallel when in order step execution rules are enabled (see [Step Order Execution Rules](#) on page 8-38 for details). The blocks must be sequentially listed and cannot be separated by different blocks of steps. For example, parallel execution is allowed when blocks are ordered (for example, Isolate, Isolate, Restore,

Restore); parallel execution is not allowed if blocks are separated by different block names, such as Isolate, Restore, Isolate, Restore.

When executing switching steps, the system checks to see if the previous block step has the same name as the current block step. If it does, the system ignores any incomplete steps within these blocks, but requires that you complete the steps within each block in order. If steps are grouped within a block, normal grouping rules apply (see [Grouping and Ungrouping Steps](#) on page 8-36).

Below is an example of how you might create and execute a plan using parallel step execution:

1. Create a Planned switching sheet.
2. From the Steps list, right-click on the Default block step. Select **Add New Block Header** and then select the Isolate option.
3. Record one or more steps into the Isolate block for a single pressure zone.
4. Add another Isolate block at the end of the first block.
5. Record one or more steps into the second Isolate block for a different pressure zone.
6. Create two Restore blocks after the second Isolate block.
7. Create go-back steps for the first of the Isolate blocks. Paste the go-back steps into the first Restore block.
8. Repeat the previous steps to create and paste go-back steps into the second Restore block.
9. In Study mode, complete the first step in the first Isolate block. The step is completed.
10. Complete the first step in the second Isolate block. The step is completed.
11. Continue executing steps in parallel for both Isolate blocks and then both Restore blocks.

Note: Parallel execution is not required in this situation; it is simply available as an option.

Grouping and Ungrouping Steps

Step grouping allows a sheet type to enforce in or out of order step execution rules for the steps that are grouped. For Product configured switching sheets, grouped steps exhibit the opposite execution rules that non-grouped steps have. If non-grouped steps can be executed out of order, then the grouped steps have to be executed in order; the opposite is true as well. For more information on how these rules are configured for each sheet type, see [Step Order Execution Rules](#) on page 8-38.

The following rules apply when grouping and ungrouping steps:

- Step groupings cannot cross over Block boundaries.
- Step groupings can be removed and altered (ungrouping and regrouping) at any time. Note that this may impact which steps can be completed next based on step completion rules.

This section includes the following topics:

- [Grouping Steps](#)
- [Ungrouping Steps](#)
- [Adding Steps to an Existing Group](#)
- [Grouping Aggregate Steps](#)

Grouping Steps

To group steps:

1. Select two or more contiguous steps. Remember that the grouping cannot cross Block boundaries.
2. Right-click and select **Group Steps** from the context menu. A blue bracket appears in the step number column to visually indicate the newly formed grouping, as shown in the following figure:

| Step # | Version | Operation | Asset |
|---------|---------|-----------------------------------|-----------------------------|
| Default | 1 | | |
| 1 | 1 | Close InlineValve:59-10 | InlineValve:59-10 |
| 2 | 1 | Close <point_of_service_oh.19583> | <point_of_service_oh.19583> |
| 3 | 1 | Place Tag ServicePipe:67-64 | ServicePipe:67-64 |

Note: Groups cannot span more than one block. If you attempt to group steps that span two or more blocks, the system will create separate groups within each block.

Ungrouping Steps

You can ungroup some or all steps in a group. To ungroup steps:

1. Select one or more steps that are currently part of a group.
2. Click the right mouse button and select **Ungroup Steps** from the context menu.

The bracket is removed (if all steps were ungrouped) or redrawn to indicate the steps that remain grouped. If the selected steps were in the middle of a grouping, then two new groups are created, and the middle steps are no longer grouped.

Adding Steps to an Existing Group

You can add one or more steps to an existing group as follows:

1. Select the steps you want to add and include at least one step from the existing group.
2. Click the right mouse button and select **Group Steps**.

The selected steps that were previously ungrouped are added to the existing group.

Grouping Aggregate Steps

An aggregate step is an operation, such as Open and Tag, that comprises two or more sub-steps (numbered a through z). An aggregate step is treated as a single step when grouping and ungrouping steps:

- If you add any sub-step of an aggregate step to a group, then all sub-steps are added to the group.
- If you ungroup any sub-step, then all sub-steps are removed from the group.

Linking and Unlinking a Step to Safety Document

Linking Step(s) to a Safety Document

To link a step to safety document:

1. From the **Steps** tab, right-click to select the step that you want to associate with a safety document.
2. From the context menu, select **Link to Safety Document** and then select a safety document type from the list.
3. The step will be updated to indicate that it is linked to the selected safety document. The associated asset will be displayed in the **Tag Points** list of the selected safety document if the step action is part of the safety document's asset list filter. For instance, with the Product configuration, it is possible to link an Open step to a safety document. This linking will not cause the associated asset to show up in the safety document's **Tag Points** list. This linking has no functional purpose and is just there to allow the actions to be grouped with a particular safety document.

Note:

- If the selected step is already associated to a safety document, an error dialog box will be displayed that indicates which safety document the step is associated to.
- If the selected step type is not configured for the safety document type, then an error dialog box will be displayed indicating the highlighted step number is not valid for linking to the safety document type.

For a list of step types to valid safety document types, see [Mapping Step Types to Safety Document Types](#) on page 8-78.

- To link a safety document to multiple steps, select the steps from the steps list and follow the procedure above.

Removing Links Between Switching Sheet Steps and Safety Documents

1. From the Steps tab, right-click to select the step(s) that you want to remove a link to a safety document.
2. From the context menu, select **Remove Links to Safety Documents**. The step(s) will be updated to indicate that they are no longer linked to the safety document and the assets will also be removed from the safety document's **Tag Points** list.

Note: For safety documents that have been issued in real-time, the asset will be marked for removal, but the reference to the document will not be removed from the step. If the step was linked to the safety document when it was issued in real-time, then that linking cannot be broken from the step.

Step Order Execution Rules

Each of the switching sheet types have step execution rules that either require all the steps to be executed in order or executed out of order. Step grouping has been setup in each of the sheet types, except Outage Correction, to allow step executions to work in the opposite way of non-grouped steps (see [Grouping and Ungrouping Steps](#) on page 8-36). Outage Correction requires that the steps be validated in order, so out of order execution is not available for that sheet type.

When in-order execution rules are turned on, then the steps have to be instructed, executed, aborted or failed in the order that they are listed in the switching steps list. You cannot complete step 2 before step 1 has been completed, aborted, or failed. When out of order execution rules are turned on, then any step in a non-terminal state can be completed, aborted or failed at any time.

Each switching sheet type is configured with different rules for whether steps can be executed in or out of order normally and then also whether steps can be executed in or out of order when the steps are part of a grouping. The table below describes how each sheet type is configured.

| Sheet Type | Execution Rule | Group Execution Rule |
|-------------------|-------------------------------------|---|
| Planned | Steps have to be executed in order. | Grouped steps can be executed out of order. |
| Emergency | Steps can be executed out of order. | Grouped steps have to be executed in order. |
| Template | Steps have to be executed in order. | Grouped steps can be executed out of order. |
| Outage Correction | Steps have to be executed in order. | Grouping of steps is not available. |

Editing Existing Steps

You can rearrange, add, and delete switching steps using options found on the Steps toolbar or from the Steps context menu.

Notes on editing steps:

- You cannot edit steps while the switching sheet is in the Completed state. You will need to transition the switching sheet to the Rework state to edit the steps after the sheet has been completed.
- Some fields on the switching sheet are not editable after a plan has transitioned to a certain set of states. For example, the Instructed Date and Completed Date fields cannot be updated after the step has reached a terminal state (completed, aborted, or failed). Exceptions to this rule apply when the switching sheet is in the Rework state.
- Tabbing out of a cell can only be accomplished if the cell is not set up for word wrapping.
- The Operation, Details, and Comments columns are configured for word wrapping. Word wrapping means the cell height will grow if the text in the field is too long to be displayed within the confines of the cell width.

To edit switching steps, complete these steps:

1. Open the switching sheet and check the status bar to make sure that the switching sheet is in edit mode.
2. Click on the **Steps** tab.
3. Edit steps as follows:
 - To edit the fields in a step, select the row and click in the Operation (for comment or non-operational steps only), Details, Planned Date, Instructed Date, Completed Date, Comments or Address field and change the text.
 - To insert a blank step, place your cursor in the row after which you want to insert the step and select the right-click **Insert Blank Step** option.
 - To insert a recorded step, select the right-click **Place Step Insertion Indicator** option and then perform the action in the Viewer. Steps are inserted after the step that currently has the indicator. To record steps at the end of the steps list, remove the step insertion indicator first.

- To delete a step, select the row for the step you want to delete and click the **Delete** button. Attempting to delete a step that is in a terminal state will produce an error dialog indicating that the step cannot be deleted.
 - To rearrange steps, cut and paste the steps to the desired location.
 - You can cut, copy and paste steps from one plan to another. The ability to cut, copy or paste is governed by the sensitivity of the edit options. (The options are disabled if the edit operation is not allowed.)
4. Save the switching sheet by selecting **Save Sheet** from the File menu.

Finding and Replacing an Asset in the Steps

The **Asset** tab of the **Find and Replace** dialog box allows you to find and replace occurrences of an asset in the switching steps. This is helpful for finding an asset in a switching sheet that has many steps. You can also use this function if you are reviewing a switching sheet and find that the wrong asset was entered in a number of places.

To find occurrences of an asset within the Steps list, complete these steps:

1. Open the switching sheet.
2. Click on the **Steps** tab.
3. *(Optional)* Select a step with a valid asset name within the Steps list.
4. Click the **Find and Replace...** button on the Steps tab toolbar. The **Find and Replace** dialog box opens.
5. Click the **Asset** tab, if not already selected. The Find field displays the selected step's asset alias, if an optional step selection was made before displaying the Find and Replace dialog box. Otherwise, enter an asset ID in the Find field.
6. Click the **Find Next** button to navigate through the list of steps, highlighting each occurrence of that asset.

To replace an asset, complete these steps:

1. Open the switching sheet.
2. Click on the Steps tab.
3. *(Optional)* Select a step with an asset that you wish to replace.
4. Click the **Find and Replace...** button on the Steps tab toolbar. The Find and Replace dialog box opens. If an asset ID was not preselected above, enter an asset ID in the **Find** field.
5. Select an asset from the Viewer. The **Replace With** field is populated with the asset alias.
6. Click **Replace**.

Notes:

- If you attempt to replace an asset for a step when the step action is not valid for the newly selected asset, then you will receive a Step Edit Failed error message indicating that the action is not valid for the asset type selected. You either need to select an asset that is valid for the current step action or use a delete and insert operation to get the step replaced.
- If you are replacing an asset association on a step that has had its Operation text modified, a **Reset Operation Text** dialog box will open asking you if you want to reset the operation text. You will have three options:
 - Click **Reset** to reset the text;
 - Click **Continue** to keep the manually entered Operation text.
 - Click **Cancel** to cancel the asset replace.

For more information, see [Resetting Operation Text](#) on page 8-33.

Finding and Replacing Text in the Steps

The **Text** tab of the Find and Replace dialog box allows you to find and replace occurrences of text in editable fields within the switching steps.

Note: Not all editable fields allow Find and Replace; the project configuration determines what fields are editable. Base Product configuration allows you to find text in the step fields Operation, Asset, Details, Executed By, Instructed by, Instructed To, Address and Comments. However, you can only replace text in the editable fields Details, Address and Comments.

To find occurrences of an asset within the **Steps** list, complete these steps:

1. Open the switching sheet.
2. Click on the **Steps** tab.
3. Click the **Find and Replace...** button on the **Steps** tab toolbar. The Find and Replace dialog box opens.
4. Click the **Text** tab, if not already selected.
5. Enter the search term in the **Find** field.
6. Click the **Find Next** button to navigate through the list of steps, highlighting each occurrence of the entered search term.
7. To replace an instance of the search term, enter the replacement text in the **Replace with** field and click **Replace**. Repeat as necessary.

Note: If you attempt to replace text in a non-editable field, a message will notify you that it cannot be replaced.

Changing Start Date

The Change Start Date? dialog box appears when you edit the **Completed Date** of a step that is part of a partial restoration. The outage start times for the related events are not updated. The system does not have enough information to decide which steps should be updated without input.

The dialog box allows to select related steps that should also have their outage start time modified. Click **OK** to change execution time or click **Cancel** to abort the change.

Focusing on an Asset in a Step

When reviewing a switching sheet, you can focus on an asset in the Viewer window to better understand the conditions present in the area of the asset. To focus the Viewer window on the asset in a switching step, select a step on the **Steps** tab and then select the **Focus** button () on the **Steps** tab toolbar. The Viewer loads the appropriate map and focuses on the asset. The **Focus** button can also be used to focus the viewer on a group of assets. To focus the Viewer window on multiple assets, highlight multiple steps with different assets and click the **Focus** button. The Viewer will load the appropriate maps and highlights each asset in the viewer.

Example Return to Nominal Scenarios

The following scenarios shows using Return to Nominal for switching actions on the diagram to the right..

Example 1

Simple load balance planned switching action.

- The user creates a Planned Switching sheet to move load from one pressure zone to another:
 - Open **B** -- make a parallel
 - Close **A** -- break a parallel
 - Open **D** -- make a parallel
 - Close **C** -- break a parallel
- The user switches to Real Time mode and executes the steps.
- The user clicks the  button to generate *Return to Nominal* steps.
- The switching plan will add the following new steps to the bottom of the plan, in a new *Return To Nominal* block:
 - Open **C** -- make a parallel
 - Close **D** -- break a parallel
 - Open **A** -- make a parallel
 - Close **B** -- break a parallel

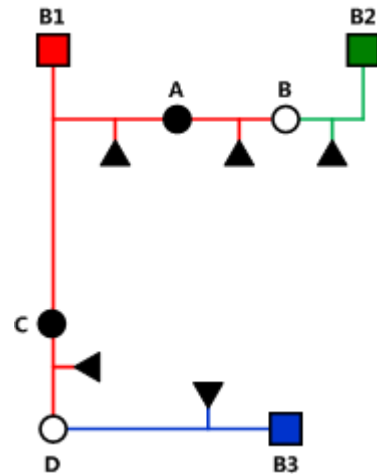

Reviewing a Switching Sheet in Study Mode

You can review the actions of a switching sheet in a Viewer window. With the Viewer and the switching sheet in Study Mode, you can complete steps by selecting a step and clicking the **Complete** button on the **Steps** tab toolbar.

As the steps are completed, each one takes effect in the Viewer window and the words "ST Completed" appear in the Status column in the steps section. Steps are completed starting with the first step and continuing sequentially; however, it is possible to complete steps out of order based on the type of switching sheet and whether the step is in a step grouping or not. (See [Step Order Execution Rules](#) on page 8-38 for more information.)

The Look Ahead window informs you of the results of the operation, including the creation of parallels and loops, the number of critical customers affected, and related abnormal assets and conditions.

Replaying Steps

You can replay steps in the Viewer window, allowing you to experiment with and make changes to a switching sheet. You can then add and delete switching steps and then select one of the three **Reset Study Session** options (see **Reset study session and clear the status of the steps** on page 8-24 for more information). After resetting your study session, you will be able to go through the steps again using the **Complete** button.

Implementing a Planned Switching Sheet

Once you have created, studied, and approved a switching sheet, you can implement the plan. Implementing involves the following steps:

- [Scheduling a Planned Master Event](#)
- [Issuing a Switching Sheet](#) (includes associating a crew and printing the sheet)
- [Instructing and Completing Switching Sheet Steps](#)

Scheduling a Planned Master Event

In order to schedule planned switching, you must have entries within the Start Date and Finish Date (ERT) fields on the **Request** tab. Note that if a Planned Event is partially restored, then the ERT is determined by taking the latest date from the restoration steps *Planned Date* values (see **Planned Date** on page 9-21). If only one of the restoration steps has a Planned Date value, then that value is used even if it is the first step to restore customers. The ERT of the Master event is only used when none of the restoration steps have Planned Date values.

Note: The calculated ERT is determined by using the Impacted Customer list, which must be generated for the functionality to work. If the list is not generated, then the ERT of the Master Event is used.

An optional asset alias can also be specified within the Asset field on the **Request** tab. Specifying an asset will cause the planned Master Event to conform to the regular zone authority rules. If you do not have authority over the zone that the asset resides in, then you will not see the planned Master Event that will be created when the switching sheet is scheduled.

To schedule a planned Master Event, complete these steps:

1. On the Request tab, fill in future dates and times within the Start Date and Finish Date entry fields.
2. To associate a particular asset and control zone, select the asset within the Viewer and click the **Link Asset** button on the Request tab. If an asset is not specified, then the Master Event will fall into the FUZZY control zone.
3. On the Tracking/Audit Log tab, click the button for the **Schedule** state. (If the Schedule button is not displayed, click through the available sheet state buttons until the Schedule button appears.) You can add a comment to each state transition if you wish.

At this point, a new planned Master Event has been created and associated to the switching sheet. This new event appears in the Events list as a Master Event. You can display the Event Details for the event from either the Work Agenda Events List or the Step tab's Events list.

Note

- The **Event Details** display is different for planned and Master events than for spontaneous outage events. For instance, you cannot update the ERT for a Master event from Event Details. That has to be done from the associated switching sheet's **Request** tab. For Planned events, the Event Details Event Began and Event Restored dates are populated through the Completed Date of the associated step in the Planned switching sheet. The Open step's Completed Date will be used for the Event Began time and the Close step's Completed Date will be used for the Event Restored date.

Updating the ERT in Event Details

You can update the ERT for an event to match the date and time specified in the **Finish Date** field on the **Request** tab. The new date will be visible in Event Details the next time you load the event. To update the ERT, complete these steps:

1. Select **Switching...** from the **Actions** menu in the Event Details window. The associated switching sheet is loaded and the steps are displayed.
2. Select the **Request** tab and enter in a new Finish Date (ERT) date and time.
3. Select the **Update ERT** button, which is displayed next to the Finish date and time entry fields. The Estimated Restoration Time (ERT) is changed for the associated Master Event within the Work Agenda Events List. The new date is displayed in the Event Details the next time it is loaded for that event.

Note: This option is only available after the sheet has been scheduled. This button is displayed next to both the Finish Date and Alt. Finish Date fields. The button is grayed if no date has been entered yet for the field.

Issuing a Switching Sheet

Once you have scheduled the plan, you should associate crews to the planned Master Event and then issue the switching sheet to the crew.

Associating Crews

1. On the Tracking/Audit Log tab, verify that the switching sheet is in Scheduled state.
2. Find the Master Event for a planned switching sheet. (Right-click on the Master Event within the **Steps** tab Events list and click the **Highlight in Work Agenda** toolbar button.)
3. From the **Work Agenda Events List**, select the event. (Even though the event is highlighted, you must click on the event in the Work Agenda Events List in order to assign and dispatch crews to events.)
4. From the **Crew Actions** list, select the crew and then click the appropriate option on the **Actions** menu: **Assign** or **En Route**. The Crew is listed in the Crew List on the Steps tab header, and the selected status is shown.

Releasing Crews from an Event

To release one or more crews from an event, select the master event in the **Work Agenda** and select **Release Crews...** from the **Actions** menu. The **Release Crews** window opens with a list of all crews assigned to the selected event. One or more crews may be selected:

- Click on a crew name to select one crew.
- Click, hold, and drag to select multiple adjacent crews.
- Control-click to select multiple non-adjacent crews.

Once the crews have been selected, click **Release** to release the crews from the event. The Release Crews window will close, the crew will no longer be associated with the event, and the crew symbology will disappear from the Viewer.

Pre-Assigning Steps to Crews (Optional)

You can pre-assign steps to crews before issuing the switching sheet. With pre-assigned switching steps, the crew is automatically highlighted in the Crew List as the steps are instructed and/or completed. To pre-assign steps to a crew, select the appropriate steps and then select the crew from the Crew List found on the Steps tab. (To select all the steps, select a single step and then press Control-A.) The Instructed To field for the selected steps is updated with the crew's ID.

Note: To clear (deselect) crew step assignments, select all the steps again, then press the Control key and click the crew in the Crew List. The Instructed To column is cleared for all steps that have not been instructed, aborted, failed or

completed. Alternatively, right-click the selected steps and choose **Clear Crews** from the context menu or select the option from the **Actions** menu.

The plan is now ready for the crews to work the steps.

Note: To pre-assign each step to multiple crews, simply select more than one crew in the Crew List before selecting your steps.

Changing the Sheet State to Issued

When the plan is issued to the crew, change the sheet state to **Issued** on the **Tracking/Audit Log** tab. The sheet can now be printed (see the following section) and handed to the crew or sent via email, depending on how your crew assignments are handled.

Adding and Removing Event Associations

Click the **Add Event Association** button () in the **Steps** tab header to associate an event with the switching plan. You can enter the event number or select an event in the Work Agenda Event List. The event will show up as a "Manual" associated event within the Events list.

Click the **Remove Event Association** button () to remove an event association from the switching plan.

See [Event Associations](#) on page 8-74 for more information.

Printing the Switching Sheet

To print the switching sheet:

1. Select **Print...** from the **File** menu (or click the **Print** () button on the main toolbar).
2. Select each section of the switching sheet you want to print:
 - Request
 - Events and Crews
 - Switching Steps
 - Impacted Customer List
 - External Documents
 - Safety Documents
 - Audit Log
3. Select the format for the print-out:
 - PDF
 - HTML
 - RTF
 - XML
4. Verify that your printer is selected and click **Print**.

Instructing and Completing Switching Sheet Steps

Once you have scheduled and issued a switching sheet, you are ready to instruct and complete the switching sheet steps. Instructing a step indicates that you have provided the step information to the individual performing the switching actions in the field.

Overview

Note the following key information about instructing and completing steps:

- Instructing steps is only permitted in real-time mode.
- In order to begin instructing switching sheet steps, the sheet has to be Issued first. The Instruct and Complete buttons become enabled in real-time mode when the plan reaches the Issued state.
- The order that steps can be instructed depends on the type of sheet the steps are found in and whether the steps are part of a step grouping or not. (See [Step Order Execution Rules](#) on page 8-38.)
- Steps are not required to be instructed before being completed. It is up to you to decide if the step should be instructed first.
- To complete a switching step, the switching sheet must be in real-time mode. (You can complete steps in Study Mode, but these actions do not affect the real-time data model.)
- Although a Viewer window does not need to be open to complete switching steps, it is helpful to view the step actions in a Viewer window. The Viewer must be in real-time mode as well.
- For steps involving asset operations, you must have authority over the zone where switching operations will take place, or the system will not allow you to complete the switching steps.
- If you attempt to operate an asset to its current state, such as closing an asset that is already closed, a dialog box informs you that the asset is already in its desired state. You can continue or cancel the operation. If you continue, the system marks the step as completed or instructed (depending on your action). If you cancel, no action is taken.

Instructing and Completing Steps

To instruct and complete steps:

1. Verify that the switching sheet and the Viewer are in real-time mode.
2. On the Tracking/Audit Log tab, verify that the status of the sheet is Issued, In Progress, or Hold/Pending.

Instructing the Step

3. Select the step you want to instruct.
4. If a crew was assigned to the switching plan and was not pre-assigned to any steps, then select the crew from the Crews List in the Steps tab header. (See the previous sections for instructions on associating crews to switching sheets and pre-assigning steps.)

Note: Automatic crew list selection is based on the crew specified in the Instructed To field of the selected step. If the step does not display a crew in this field, then no crew will be selected in the Crews List.

5. When you give the instruction to the crew, click the **Instruct** button on the Steps tab toolbar.
6. If the step involves an asset operation, the Look Ahead window opens. Click **Open** or **Close** in the Look Ahead window to continue with the step. (You may be required to view conditions associated with the operation before you can perform the operation.)

The status of the step changes to Instructed. The Instructed To column is populated with the assigned crew's ID, and the Instructed Date column is populated with the current date/time. An Instructed symbol appears on the asset in the Viewer.

If the step involves issuing a safety document to one or more crews, then the list of crews in the step's **Instructed To** field will be used to populate the **Assigned Crews** list within the safety document when the step is completed.

Notes on SCADA Actions:

If the step involves actions on a SCADA control, a confirmation dialog box displays the following text: "Do you wish to send this request to SCADA?" If you click **Yes**, the step is instructed to SCADA, the request is sent to SCADA, and the status of the step is set to SCADA Pending. If you click **No**, the request is not sent to SCADA and the step is set to SCADA Pending (it will wait for telemetry in order to complete the step). This may be the case if a crew were instructed to perform the operation instead of a SCADA system. If you click **Cancel Action**, the operation is cancelled.

If the SCADA interface reports that the asset was indeed opened, the step status is then updated to Completed. The switch opens in the Viewer and the instruct condition disappears.

If you select the Complete button before receiving information from SCADA, a confirmation dialog box displays the following text: "SCADA telemetry only for selected asset. Submit a manual entry?" If you click **Yes**, the status of the step is set to Completed, and the switch opens with status of M (for MANUAL entry) in the Viewer. If the SCADA interface reports that the asset was indeed opened, the MANUAL indicator disappears. If you click **No**, the action is cancelled.

For more information about SCADA, see [SCADA Extensions](#) on page 7-1.

Notes on the Look Ahead and its Errors and Warnings

When instructing a step, the Look Ahead and its associated errors and warnings display data as if the other instructed steps in the sheet were already completed. This allows you to instruct multiple steps, including go-backs of previous steps, without receiving errors about missing tags, incorrect statuses, and so on. This will also give you the correct customer count as if the other instructed steps were already executed.

This considers all instructed steps in the current sheet only and applies them to the model in the order that they were instructed (using the Instructed Date field.)

Completing the Step

7. After the crew reports that the step is complete, select the step and click **Complete**.

The Status is updated to *Completed*. The Completed Date column is populated and the asset status is updated in the Viewer window. If customers are impacted, then a new planned outage event is placed upon the asset as well. This event will also appear in the Events list on the **Steps** tab header.

8. If the step is a safety state transition step, then selecting **Complete** will cause the safety document dialog box to be displayed. Verify that the information on the safety document is correct and click the **Execute** button at the bottom of the display to complete the action. (For more information, see [Executing Safety State Transition Steps](#).)

Note: All safety documents must be completed before you can complete the switching sheet. Also, in order to complete an Issue Safety State transition step, a crew must be specified in the **Assigned Crews** list. You can specify a crew by doing one of the following:

- Select one or more crews within the Crew List on the **Steps** tab. Use these selections to populate the **Instructed To** field of the safety state transition step. Upon completing the step, the crews listed in the **Instruct To** field will also be listed in the safety document's **Assigned Crews** list.

- Click the **Select Crews...** button () found above the **Assigned Crews** list on the safety document and use the Select Safety Crew dialog box to populate the **Assigned Crews** list.
9. Repeat steps 3-8 for each switching step you want to instruct and complete.

Recording Additional Steps in Real Time

10. Additional steps may be added to the switching sheet in real time when it is in the 'Issued' state. Click the record button and proceed to record the actions as issued.

Completing the Switching Sheet

11. When all steps have been completed, click the **Tracking/Audit Log** tab and set the sheet state to *Completed* by clicking **Complete**. The **Confirm State Transition** dialog box will open; click **Yes** to confirm the completion or click **No** to close the dialog box without completing the sheet. The Finish Date may be updated, if necessary.

- *Optional:* add a comment in the text field to the right of the **Complete** button.

If any associated event has not been restored or if any safety document has not been completed, an error message is displayed indicating that the sheet cannot be completed.

Once the sheet is in the Completed state, any planned outage events are completed along with the planned master event. Any crews assigned or en route to the events are released as well.

Note: Once all the steps in a switching sheet are complete, the plan itself is considered complete. Setting the sheet state to Completed "locks" the switching sheet so that no further modifications may take place while it is in this state.

Moving a Crew

Crews are automatically relocated as steps are instructed to them. As steps are completed, crews are moved to the appropriate asset based on the remaining instructed and non-complete switching steps. If all steps have been completed, the crew is moved back to the master asset or the previously operated asset, depending on the configuration. (If configured to go back to the master asset and one is not given, then the crew disappears from the Viewer.)

You can manually move a crew to the asset associated to the selected switching step. This option is available only if the step is instructed and has been instructed to a crew. This option allows you to move a crew to a different asset when multiple steps have been instructed to a crew.

To move a crew to an asset, follow these steps:

1. Associate the crew to the planned switching sheet as described in [Associating Crews](#).
2. Transition the sheet to the Issued state, if it is not already.
3. Select the crew within the **Crew List** on the **Steps** tab header.
4. Instruct all steps in the sheet. Note that within the viewer, the crew initially moves from master asset to the first instructed asset and then to the next.
5. From the **Steps** tab, select an instructed step, right-click, and select **Move Crew** from the context menu. The crew moves to the asset associated to the selected step.

Working with Switching Sheet Versions

Switching sheets use a version control mechanism in order to keep operators and crews consistent with regards to which switching sheet they are viewing. The switching sheet as a whole has a version number, and steps can also have version numbers.

Each switching sheet version will go through a set of states.

- **Editing:** The current version of the sheet is being edited.
- **Checked In:** The current version of the sheet has been checked in. Any updates to the sheet other than instructing and completing steps will cause a new version to be created and that version will be in the Editing state.

The following describes how sheet version control works and presents examples of how the version and editing mode change as actions are taken on a switching sheet.

- When you first start a sheet, the sheet version is 1. The sheet's version number and editing state are displayed in the [Status Bar](#) at the bottom of the switching sheet. The new sheet's version is considered to be in an Editing state until it is checked in.

| Action | Resulting Version and Editing Mode |
|--------------------------|------------------------------------|
| Initial sheet is created | Version: 1 (Editing) |

- When the sheet transitions to Issued state or whenever a switching step is instructed or completed in real-time mode, the system automatically checks in the current version of the switching sheet, but the version number is not incremented until you make changes, which will create a new version.

| Action | Resulting Version and Editing Mode |
|--|------------------------------------|
| Sheet transitions to Issued State, triggering automatic check-in | Version: 1 (Checked In) |

- If you make switching step changes after the sheet has been checked in or change any field in the sheet, the system automatically creates a new version and increments the sheet's version number.

Note: Your system's configuration determines which fields trigger a version change when edited. By default, a new version is created when any field is changed.

| Action | Resulting Version and Editing Mode |
|--|------------------------------------|
| Steps are added, triggering version update | Version: 2 (Editing) |

- You can manually check in changes at any time. This creates a saved version of the sheet that you can refer back to later. It also makes the checked-in version available to other users who view the sheet. The **Check In** button is displayed in the sheet's toolbar; when you click the button, the current version is checked in, and the **Check In** button changes to **Create New Version**.

| Action | Resulting Version and Editing Mode |
|--|------------------------------------|
| User manually checks in version, using Check In Version option | Version: 2 (Checked In) |

- You can manually increment a sheet's version after the sheet has been checked in using the **Create New Version** button. When you manually increment the version, the system creates a new version of the sheet and places that version into an Editing state.

| Action | Resulting Version and Editing Mode |
|--|------------------------------------|
| User manually increments version using the Create New Version option | Version: 3 (Editing) |

- You cannot make changes to a switching sheet while it is in the Completed state. Once a sheet is completed, it will be placed into view-only mode. Further corrections can be applied to the Completed switching sheet by transitioning it to the Rework state. See [Rework](#) on page 8-17 for more details.

Step Versioning

Steps also have version numbers. The step version number is the version number of the sheet when the step was added. A step's version number is displayed on the **Steps** tab to the right of the step number.

- If you add steps to a checked-in switching sheet, the sheet version is automatically incremented and the newly added steps are associated to this new sheet version number. This allows you to easily distinguish between steps that were previously issued to a crew and newly added steps.
- To see the differences between the current version and a previous version, open the version drop-down on the status bar, then select the version to compare against.

When you select a version, the Step # column uses outline numbering (1.1, 1.2) to identify steps that were added since the previous version.

If you delete a step when the switching sheet version is checked-in or when an earlier version of the step exists, then the step is removed from the current version. If you view a previous

version in which the step existed, the deleted step is indicated with strikethrough text and is shaded red.

| Step # | Version | Operation | Device | Phases | De |
|--------------|--------------|-----------------------------|------------------|----------------|----|
| Isolate | 1 | | | | |
| 1 | 1 | 1 Check open S2981 | S2981 | ABC | |
| 1.1 | 2 | 2 Place CLEAR Tag | S2981 | ABC | |
| 2 | 4 | 4 Place HOLD Tag | S2984 | ABC | |
| 3 | 1 | 1 Open S3142 on phases ABC | S3142 | ABC | |
| 4 | 1 | 1 Place HOLD Tag | S3142 | ABC | |
| 5 | 1 | 1 Open S3140 on phases ABC | S3140 | ABC | |

Viewing Impacted Customers

The **Impacted Customers** tab displays a list of all customers affected by the switching step operations. It also shows the total number of customers in the interrupted, isolated, and restored states:

- **Interrupted:** customer had supply at the start of the switching operation, lost supply (at some point) during the operation, and had supply again at the end of the operation.
- **Isolated:** customer had supply at the beginning of the operation and had no supply at the end of the operation.
- **Restored:** customers who were without supply during the operation and had supply at the end of the operation.

Important Note:

Service Alerts for planned events are triggered by the Impacted Customers List. Alerts will not be sent if the Impacted Customers List is not generated.

Note: Customers marked as *Deleted* will not be included in the Interrupted, Isolated, or Restored total number counts.

The following rules apply to the Impacted Customer list:

- Whenever the system determines that a plan will impact customers, the Impacted Customers indicator is displayed on the status bar. If the sheet is later changed and customers are no longer impacted, then the indicator is removed.
- If a customer will be impacted multiple times during a sheet's execution, the customer is listed multiple times in the list.
- If no Planned Dates are specified for the asset operations relating to an item in the list, then the dates will come from the sheet's Start and Finish Dates, which are required to generate the impacted customer list. The only exception to this rule is when working with Outage Correction sheets, which require step control times.
- The list can only be regenerated in study mode, since it displays the list of customers that will be impacted when the plan is executed and it uses your study session to calculate that list. See [Generating the List](#) on page 8-53 for more details.
- The list is not affected by the Real-Time execution status of the steps. The Work Agenda, Event Details, and Event Log are the source for Real-Time outage data.



Using the Impacted Customers Tab







The Impacted Customers tab displays a list of impacted customers in a hierarchical, or tree, format -- just like Windows Explorer. The top level of the hierarchy is date/time the customer is impacted. Within date/time, the list displays each supply node along with the restore date/time. Within each supply node is a list of customers. You can expand or collapse any level of the hierarchy by clicking the + or - icon.

The Impacted Customer list displays the following fields and buttons:

- **# Interrupted** displays the number of customers who will be interrupted (Isolated and Restored) by the operations performed in this switching sheet.
- **# Isolated** displays the number of customers who will be isolated by the operations performed in this switching sheet.
- **# Restored** displays number of customers who will be restored by the operations performed in this switching sheet.
- **Name** displays different values depending on the type of row being displayed. There are three levels of information in the list:
 - **Impact Date** (level 1) displays the date the customers will be impacted. If the customers are not impacted by the switching steps in this switching sheet, but are being restored, then this date will be the start date of the switching sheet.
 - **Supply Node and Restore Date** (level 2) displays the supply point alias the customer is found on within the model, followed by the Restore Date. The Restore Date is based on the Planned Date for the asset or, if no Planned Date was specified, the Finish Date of the switching sheet. Isolated supply points display "No Restore Date".
 - **Customer Name** (level 3) displays the customer's name.
- **Account Number** displays the customer's account number.
- **Meter Number** displays the customer's meter number.
- **Critical** displays whether the customer is a critical customer or not.
- **Address** displays the customer's street address.
- **City** displays the customer's city.
- **Zip** displays the customer's zip code.
- **Phone** displays the customer's phone number.
- **Result** displays the result of the impact, such as Restored or Interrupted. If a delete operation is initiated against a customer in the list, then the **Result** field will have a value of Deleted.

Buttons

- The **Rebuild the Impacted Customer List** button () regenerates the list based on the most current information in the switching sheet. Each time you rebuild the list, it is saved to the database. The application uses your Study mode to apply the step actions and to determine the Impacted Customers. Your study model should be set up or reset appropriately before generating the list. This button is only enabled when the switching sheet is in Study mode.
- The **Move Customers to a Different Asset** button () initiates the Move Customers dialog box for selected customers. See [Moving Customers](#) on page 8-54 for information.
- **Mark Customers as Deleted** button () marks the customers selected in the table as deleted.

- The **Reset all Deleted Impacted Customers** button () resets all impacted customers that were previously marked as deleted in the list.
- The **Export Impacted Customers List** button () opens the Report Format dialog box, which allows you to select an output format. Options include CSV (comma separated values) and XML. Once the report is generated you will be asked where to save the file; select a location on your local PC and click the **Save** button.
- The **Print Preview** button () opens the Report Format dialog box, from which the output format can be selected. The output will include the switching sheet header information and the Impacted Customer list.
- The **Print** button () opens the Report Format dialog box, from which the output format can be selected. A hard copy of the switching sheet header information and the Impacted Customer list will be generated on the printer you select.
- The **Email** button () opens the Report Format dialog box, from which the output format can be selected. An email composition window is generated with attached impacted customers list file named **sheet-type_sheet-#_ImpactedCustomers.format** and subject Switching Sheet: <sheet-type> <sheet-#> (Impacted Customers).
For example:
Subject: Switching Sheet: Planned 1079 (Impacted Customers).
- The **Focus** button () focuses the primary Viewer on the selected asset.
- The **Show Critical Customers** button () filters the list to show only critical impacted customers; when toggled off, all impacted customers will again be shown.

Color Coding

Rows (customers) on the list are color-coded to show the status:

- Green - Restored
- Orange - Isolated
- Red - Deleted
- No background - Interrupted

Generating the List

To generate the Impacted Customer list, follow these steps:

Important Note:

Service Alerts for planned events are triggered by the Impacted Customers List. Alerts will not be sent if the Impacted Customers List is not generated.



1. On the Request tab, verify that a Start Date and Finish Date have been entered for the sheet. The system uses these fields to generate the Impacted Customer list and the estimated restoration time for each customer. The start of outage is the Start Date of the switching sheet, and the restoration time is the Finish Date.
Note: If a Planned Date is specified for a particular operation on the Steps tab, then the Planned Date, rather than the sheet's Start and Finish Date, is used to generate the impacted customer list for that operation.
2. Make sure that you have added all necessary steps to the switching sheet, and that the sheet is ready to be worked. The steps do not need to be completed to produce the list.
3. On the Steps tab, click the **Reset Study Session** button on the toolbar, then select **Real-Time** or **Nominal**. At this point, you can update your study session within the Study Viewer to depict what the model will be like when the work is carried out.

4. On the Impacted Customers tab, click the **Rebuild Impacted Customer List** button on the toolbar. The list is generated and displayed.

Notes:

- When the steps do not impact any customers, clicking this button will bring up an information dialog box stating that no customers will be impacted as a result of the operations in the current switching sheet.
- If you do not reset your study session as described in step 3, then the impacted customers list may end up with no results. This is due to the fact that the steps in the sheet, when traced through, will not actually impact any customers in your study session. This is why it is vital that you prepare your study session before attempting to generate the impacted customers list.

Sorting Impacted Customers List

The Impacted Customers list can sort by clicking on a column header. By default they are sorted by impacted date and customer name in ascending order. Click once to sort them in descending order. An icon on column header indicates the current sort column and sort direction; the up arrow  indicates ascending order; the down arrow  indicates descending order. Printed output, through print-preview and print options, use the default sort order.

Deleting and Restoring Customers from the List

To remove a customer from the list, right-click the customer and select **Delete** from the context menu. The row is highlighted in red.

Note: Removing the customer from the list does not remove the customer from the model; it simply marks the customer as deleted from the list. If you regenerate the list, the customer will still be marked as deleted. If the customer is impacted multiple times, then that customer will be marked as deleted in each of the lists.

To restore (un-delete) a customer, right-click the customer and select **Undelete** from the context menu.

To restore all previously deleted customers, click the **Reset all Deleted Impacted Customers** button. All red highlighting is removed.

Moving Customers

If you realize that customers have been incorrectly associated with an asset, you may need to move them from an asset that will be impacted to an asset that will not be impacted. To move customers from their current asset to another asset, complete these steps:

1. On the Impacted Customers tab, select the rows for the customers you want to move.

Note: The expandable folder nodes are not selectable; you must select customer names.

2. Right-click and select **Move Customers...** from the context menu. The Move Customers dialog box opens, displaying the customer names, addresses, and their original asset as defined by CIS.

Note: If you click the **Move Customers...** button without first selecting customer rows, you will receive an "Invalid Customer Selection" error with the message: Only customer rows selected are considered by the Move Customer feature. Any selected expandable folder nodes are ignored. Select at least one customer row to continue.

3. Click on the new asset in the Viewer. The New Asset field on the Move Customers dialog box is populated with the selected asset.
4. Click **OK**. The system determines whether or not the new asset is also an impacted asset.

If the new asset is not an impacted asset, the customers are moved to the new asset and are removed from the impacted customer list.

If the new asset is an impacted asset, a confirmation dialog box is displayed. Do one of the following:

- Click **Yes** to continue with the move. The customers are moved to the new asset within the Impacted Customers list. If the selected customers were previously moved to a new asset, another confirmation dialog box is displayed. Do one of the following:
 - Click **Yes** to continue with the move. The existing customers move record is overwritten.
 - Click **Cancel** to return to the Move Customers dialog box so you can select a different asset.
 - Click **No** to cancel the move and close both the confirmation dialog box and the Move Customers dialog box.
- Click **No** to return to the Move Customers dialog box so you can select a different asset.
- Click **Cancel** to cancel the move and close both the confirmation dialog box and the Move Customers dialog box.

Checking for Overlaps

Once you have created steps for a planned event, generated the Impacted Customers list, and saved the switching sheet, you can cross-check the switching sheet with other switching sheets for overlaps of time, control zone, or affected assets.

This allows planners to create a single planned event instead of two separate events and avoid visiting the same location twice or impacting the same customers twice within a short time frame. Planners can identify whether to change the current switching sheet in order to avoid affecting the same customers or same area multiple times in a certain time period.

Note: When an overlap occurs, the system does not prevent you from completing planned switching operations, but it does provide a warning indicating the overlap.



If the current plan has a time, control zone, or asset overlap with another plan, the Overlap indicator is displayed on the switching sheet [Status Bar](#). Use the Overlaps tab to view details about the overlaps.

Using the Overlaps Tab

The Overlaps tab displays the following fields and buttons:

- The **Update Overlaps** button () updates the Overlaps list based on the current settings.
- The **Range** drop-down allows you to specify how to use the From and To dates. Options are:
 - Sheet Start and Finish Dates
 - +/- 1 day
 - +/- 1 week
 - +/- 1 month
 - +/- 1 year

For example, if you select Sheet Start and Finish Dates, the system updates the From and To dates to match the sheet's Start and Finish dates entered on the Request tab. If you select +/- 1 week, the system displays overlaps that are one week before and after the sheet's Start and Finish dates. In other words, overlaps for a two week period plus the switching sheet's scheduled duration will be used to search for overlaps.

- The **From** and **To** fields specify the range of dates for which you want to view overlaps. These fields are automatically populated based on your selections in the Range field. If you manually enter values in the **From** and **To** fields, those values will override what was auto-populated by the Range selection.
- The **Filter By** drop-down allows you to specify the type of overlaps you want to view: Asset, Control Zones, or Time. See [Updating the Overlaps List](#) on page 8-57 for details.
- The **Open Selected Switching Sheet** button () will open the switching sheet selected in the overlaps list. Alternatively, you can right-click on the switching sheet and select **Open Switching Sheet** from the option menu.
- The **Export Table** button () is used to export a comma separated value list of the table contents to a file.
- The **Overlaps** table displays a row for each switching sheet that has an overlap with the active switching sheet (and meets the criteria specified above). The blank filter boxes at the top of each column allow you to filter the Overlaps list. See [Viewing an Overlapping Switching Sheet](#) on page 8-57 for details.
 - The **Overlap Type** column displays the type of overlap the sheets have with the switching sheet the list is being generated from. Values include Asset, Control Zone, Time. When looking for overlaps in the past, it is possible to also display sheets with overlap types of Past Asset, Past Control Zone, and Past Time. These "Past" types indicate switching sheets that have Finish dates that are in the past, but are still active.
 - The Status column displays the status of the switching sheet listed on that row.
 - The **Sheet #** displays the switching sheet number that contains the overlaps.
 - The **Type** column displays the type of switching sheet.
 - The **# Steps** column displays the total number of steps included in the switching sheet. This number basically matches up with the last step number in the sheet's Steps list and does not include child aggregate or Block steps.
 - The **# Assets** column displays the number of asset overlaps.
 - The **# Zones** column displays the number of overlapping control zones.
 - The **# Hours** column displays the number of hours the sheet overlaps with the current sheet. This value is based on the dates specified in the Start and Finish date fields on each of the switching sheets.
 - The **# Supply Nodes** column displays the number of impacted nodes shared by the two switching sheets. For this column to display a value, the impacted customers list will have had to have been generated for the current switching sheet and the one listed in the Overlaps list.
 - The **User** column displays the user ID of the requester of the switching sheet.
 - The **Start Date** column displays the start date of the switching sheet.
 - The **Finish Date** column displays the finish date of the switching sheet.
 - The **Pressure Zones** column is the Pressure Zone value as displayed on the **Request** tab of the switching sheet.
 - The **Description** column is the **Description** value as displayed on the **Request** tab of the switching sheet.

The list on the Overlaps tab supports [Quick Sorting](#) and [Dynamic Filtering](#).

Color Coding

Rows on the Overlaps tab are color coded to indicate the type of overlap. The **Overlap Type** column also describes the overlap type:

- **Dark Gray (Past):** the switching sheets have an overlap, but the overlapping times on the sheets are in the past. To distinguish between the types of past overlaps, the foreground coloring will be set to Red, Orange, or White based on the type of past overlap it is. These colors have the same meaning as the background colors used to define the type of overlap for future overlaps. See the following color definitions for more details.
- **Red (Asset):** The switching sheets have asset overlaps.
- **Orange (Control Zone):** The switching sheets have control zone overlaps.
- **White (Time):** The switching sheets overlap in time only.

Updating the Overlaps List

Use the fields at the top of the Overlaps tab to re-generate the Overlaps list for a different time period or to show different types of overlaps.

To update the Overlaps List:

1. Use the **Range** and **From/To** dates (for asset and control zone overlaps) to specify the time period for which to display overlaps.
2. From the **Filter By** drop-down, select the type of overlaps you want to list. For example, if you want to show only switching sheets that have asset overlaps within a specified date range, select **Assets** from the drop-down list.
3. Click the **Update Overlaps** button () to refresh the list based on your selections.
4. Standard filtering and sorting options are available for the results list.

Viewing an Overlapping Switching Sheet

To view an overlapping switching sheet, double-click on the entry within the Overlaps List. The switching sheet opens in a new tab. Alternatively, you can right-click on the entry and select **Open Switching Sheets...** from the context menu.

Saving and Loading View Areas







While working with a switching sheet, you may often want to return to the same area of the map. Web Workspace allows you to save an area of the map, called a view area, so that it can be loaded again later. This allows you to quickly focus the Viewer on a particular section of the model.

You can save multiple view areas for each Viewer. You can assign a description to each view area that identifies its contents and purpose. You can also select a saved view area to be loaded automatically into a Viewer when the switching sheet is opened.

Using the View Areas Tab



Use the **View Areas** tab to save and load view areas. The first row in the **View Areas** table contains a special *Dynamic View (All Assets)* that contains all assets associated with the switching sheet; as assets are added in steps, the dynamic view is automatically updated to include those assets.

The **View Areas** tab displays the following fields and buttons:

- The **Auto-Load in Viewer** drop-down allows you to assign a view area to a Viewer, which will then load that view whenever the sheet has focus. Note that the auto-load function does not open the Viewer so you must start the Viewer to see the view areas.
- **Description** is the description of the saved viewing area. The default description is "View Area #," where "#" is a uniquely generated ID number. You can change this description up until the associated switching sheet has reached the Completed state. The All Assets (Dynamic View) description is not editable.
- The  **1** toolbar button allows you to save the map area that is currently displayed in Viewer 1.
- The  **2** toolbar button allows you to save the map area that is currently displayed in Viewer 2.
- The  **1** toolbar button allows you to load the selected viewing area to Viewer 1.
- The  **2** toolbar button allows you to load the selected viewing area to Viewer 2.
- The  toolbar button allows you to delete the selected viewing area.
- The  toolbar button allows you to reload all viewing areas marked for auto-loading.

Saving a Viewing Area

To save a viewing area, complete these steps:

1. In the Viewer window, navigate to the area of the map that you want to save as a viewing area.
2. On the **View Areas** tab in the Web Switching Management window, click one of the **Save Map** buttons on the toolbar.
 - Click  **1** to save the map area that is currently displayed in Viewer 1.
 - Click  **2** to save the map area that is currently displayed in Viewer 2.

The new view area is added to the bottom of the list of saved views on the View Areas tab.



3. In the Description field, enter a meaningful name that describes the viewing area.
4. If you would like this viewing area to be loaded automatically the next time this switching sheet is opened, select the Viewer from the **Auto Load in Viewer** drop-down.

Note: The application will only allow you to select one saved viewing area to be auto-loaded for each Viewer.

Loading a Saved Viewing Area

After a viewing area has been saved for a switching sheet, you can quickly load the viewing area into the Viewer window.

To load a saved viewing area, complete these steps:

1. On the View Areas tab, select the viewing area you want to load.
2. Click the appropriate button to load the viewing area into the desired Viewer (or use the right-click context menu options):
 - Click  **1** to load the selected viewing area to Viewer 1.
 - Click  **2** to load the selected viewing area to Viewer 2.

The selected viewing area is displayed.

Note: If the Viewer you selected is not running, a message is displayed.

Reloading all Auto-Load Viewing Areas

Click the Reload All Viewers button () to reload all viewing areas marked for auto-loading. (The Auto Load in Viewer column indicates which viewing areas are specified for auto-loading in each Viewer.)

Note: If no Viewers are running, a message is displayed.

Deleting a Saved Viewing Area

To delete a saved viewing area that you no longer need, complete these steps:

1. On the View Areas tab, select the viewing area you want to delete.
2. Click the **Delete** button (or right-click and select **Delete View Area** from the context menu). The viewing area is removed from the list. The **All Assets** dynamic view area cannot be deleted from the list.

Viewing the Audit Log

The Tracking/Audit Log tab displays the current state of the switching sheet and allows you to transition to a different state. You can provide comments to explain the reason or circumstances around the transition in the Sheet State Tracking panel. See [Changing the Switching Sheet State](#) on page 8-17 for more information, including valid switching states.

The Audit Log table contains a list of status changes the sheet has gone through since it was created. An entry is added to the log whenever changes occur to the sheet state, including (but not limited to) status changes, sheet ownership changes, generation of the impacted customer list, and sheet version check-ins.

The Audit Log table contains the following fields and buttons:

- **Entry Date** displays the Date and Time when the change was made.
- **Sheet Version** displays the version of the sheet when the change was made.
- **Sheet State** displays the state of the sheet when the change was made. (See [Switching Sheet States](#) on page 8-18 for state descriptions.)
- **Entry By** displays the user who initiated the change.
- **Details** displays a brief description of the audit entry.

Note: You cannot change any information for existing entries in the audit log table.

As with other list displays, you can click and drag column headers to rearrange the order of columns. You can also re-sort the list by clicking on the Entry Date column header. By default, log entries are displayed in ascending chronological order.

Adding a Comment to the Audit Log

The Comment section of the Audit Log panel allows you to add a comment to the log.

1. Click in the Comment field and enter a comment. The **Add** button (+) will be enabled.
2. Click + to add the comment to the log.

Emailing Switching Sheet Data

At any time during the process of editing or viewing a switching sheet, you can email the switching sheet data to one or more recipients. The switching sheet data will be sent as an email attachment in a chosen file format.

Note: Your email client will be used for sending the email. Depending on your email client, some attachment behavior may be different than described. If you do not have an email client installed and set up on the PC from which you are running Web Workspace, you will not be able to email switching sheet data.

1. Click the **Email...** button (✉).
2. From the **Switching Report - Content Selection** dialog box, check the box for each section you want included in the email data:
 - Request
 - Events and Crews
 - Switching Steps
 - Impacted Customer List
 - External Documents
 - Safety Documents
 - Audit Log
3. Choose the email format: PDF, RTF, HTML, or XML.
4. Click **Email...**
 - The Subject field is automatically populated; you can edit this field if you wish.
 - The selected data is attached to the email.

Note: Depending on your configuration, you may be given the option to name the switching sheet data attachment prior to the file's attachment; the standard configuration will always name the file according to the sheet type and number (for example, Planned_1003.pdf).
5. (Optional) Enter any text you want to include with the message.
6. **Send** the message according to your email client's functionality.

Automatic Emails

Based on your system's configuration, emails can be automatically sent to an individual recipient or group and to the requesting user. Automatic emails are normally initiated after a switching sheet state change. For example, if a plan is rejected, the requesting user will be sent an email message indicating that the request was rejected and the reason for the rejection. Product configuration does not have this functionality enabled by default. Projects will be required to enable this feature in order to use it.





Adding External Documents to a Switching Sheet

Use the External Documents tab to attach supplemental documentation to the switching sheet. External Documents are stored in the database, so shared file systems are not needed.

Note: External Document files may be images (for example, jpg, png, bmp), documents (for example, doc, docx, odt), spreadsheets (for example, xls, xlsx, ods), and so on.

Using the External Documents Tab

The External Documents tab displays the following fields and buttons:

- **Name** is the name of the external file. This field cannot be changed.
- **Length** is the number of bytes in the file. This field cannot be changed.
- **Modified Date** is the date the file was last modified or saved. This field cannot be changed.
- **Status** is the status of the document. When you initially add an external document, its status is New; when you save the sheet, its status is cleared. If you delete an external document, its status is set to Deleted until you save the sheet. If you load and modify the document from this tab, then its status is set to Modified.
- **Description** is a user-defined description. You can enter up to 4000 characters in this field.
- The **Attach** button () allows you to attach an external document to the switching sheet. See [Adding an External Document](#) on page 8-62.
- The **Delete** button () deletes the selected external documents from the switching sheet. See [Removing an External Document](#) on page 8-62.
- The **Open** button () allows you to open the selected document. See [Opening and Editing an External Document](#) on page 8-63.
- The **Save As** button () allows you to rename and save a selected document to the directory of your choice. See [Saving an External Document to Another Location](#) on page 8-63.

Adding an External Document

To add an external document to the active switching sheet:

1. Click the **External Documents** tab.
2. From the toolbar, click .
3. From the Attach Files window, select the files you want to add to the sheet and click **Attach Files**. The External Documents tab displays the selected files in green. This indicates that the files have been selected, but have not yet been saved.
4. In the **Description** field, type a description of each file that will convey its contents and purpose.
5. Click the **Save Sheet** button to save the selected documents to the database. The documents are no longer displayed in green, indicating that the documents have been saved to the database, and their New status value is cleared.

Removing an External Document

To remove an external document from a switching sheet, do one of the following:

1. Click the **External Documents** tab.
2. Select the document in the table.

3. Click .

Note: Alternatively, right-click the document and choose **Delete** from the context menu.

The status of the selected document is set to Deleted, and the file is displayed in red.

4. Click the **Save Sheet** button to save your changes. The document list is updated and the file is removed from the database.

Note: The file is deleted from the database, but the local copy of the file on your PC is not removed.

Saving an External Document to Another Location

When you add a document to the external documents list, the system saves the document to the database. If you want to save a *copy* of the current version of the document on your PC, follow these steps:

1. From the **External Documents** tab, select the document and click the **Save As** button () or right-click and select **Save As....** The **Save File As** dialog box is displayed.
2. Browse to the directory where you wish to save the copy.
3. To change the file name, enter in a new name in the **File Name** field.

Note: There is no rule against changing the file type. If you alter the file extension in the File Name field, then be aware that the file name will be saved exactly as you have typed it.

4. Click **Save**. A copy of the current database version of the document is saved to the directory with the specified name.

Saving a Selection of External Documents to Another Location



When you add a document to the external documents list, the system saves the document to the database. If you want to save a copy of more than one document at once to your PC, follow these steps:

1. From the External Documents tab, select multiple document entries and click the **Save Files to Directory...** button () or right-click and select **Save Files to Directory....** The Save Files To Directory dialog box is displayed.

Note: The **Save Files to Directory...** button is only visible when more than one entry is selected in the External Documents list.

2. Browse to the directory where you wish to save the copy. Another option is to enter the directory path in the Directory text field.
3. Click **Save Files To Directory**. Copies of the current database versions of the documents are saved to the specified directory.

Opening and Editing an External Document

External Documents may be opened for inspection or to edit depending on the state of the switching plan. If the plan is in View-Only mode () , the document will be opened in read only mode; if the plan is in Edit mode () , the document will be opened with write permissions. See “Edit and View-Only Modes” on page 10.

Opening an External Document

To open an external document:

1. Click the **External Documents** tab.
2. Select the document you want to open and click the **Open** button (; or right-click the document and select **Open...**). The file is extracted to a local temporary directory and opened in the application associated with the file extension.

Notes: If the file extension, or type, is unknown or the application is not available, a message will be displayed indicating that the application is unknown.

Editing an External Document

External Documents opened from a sheet in Edit mode are available to edit.

1. Make changes to the document as necessary.
2. Save and *close* the document; the database will be updated with the changes made in the extracted (temporary) document the next time the switching sheet is saved.

Troubleshooting Issues with External Documents

It is best to close the document after it has been edited and saved due to conflicts that can occur if the local file is saved outside of the control of Switching Management.

When the an external document is opened from a switching sheet, the application attempts to extract the external document to the temporary folder and compares the date stamp of its version to the local copy. If the file in the temp directory is newer than the database version, it gives a warning that changes to the local file will not be saved (because the plan was switched to View-Only mode). Once you click **OK**, the application will overwrite the local changes with the saved version of the external document in the database.

If the extracted document is still open when the application attempts to restore the saved version, a file lock conflict will result in another warning to inform you that the system cannot extract the database version of the document to the temporary folder. If this conflict occurs, you will be requested to take action to remove the conflict.

To remove the conflict, perform the following steps:

- On the warning dialog box, click **OK**.
- Close the external document.

Opening an Existing Switching Sheet

Depending on how a switching sheet is being worked, there are a number of ways for you to load an existing switching sheet.

Note: Web Switching is configured to limit you from having more than 15 switching sheets loaded at one time. Attempts to surpass the limit will result in an error.

- [Open a Switching Sheet Window from Switching Sheet List](#)
- [From the Work Agenda](#)
- [From the Event Details](#)
- [From Crew Actions](#)
- [From the Control Tool](#)

Note: If a step was highlighted when the sheet was closed, it will open with that step highlighted and centered in the steps list.

Open a Switching Sheet Window from Switching Sheet List

To open a switching sheet from the Switching Sheet List:

1. From the **File** menu, select **Switching Sheet...** from the **Open** option. The Switching Sheet List opens. Existing switching sheets are listed in the tabular view; the rows are color-coded to reflect switching sheet status:
 - **Green:** In Progress
 - **Red:** New
 - **Bright Yellow:** Scheduled, Checked, or Approved
 - **Pale Yellow:** Prepared
 - **Orange:** Requested
 - **Gray:** Completed or Rework
 - **White:** Hold/Pending
2. Select one or more sheets to open. To open multiple sheets, do one of the following:
 - Click, hold, and drag to select multiple adjacent rows.
 - Control-click to select multiple non-adjacent rows.
 - Use Dynamic Filtering to select sheets in the table and select all results by pressing Control+A.

This window also supports standard filtering and sorting. (See [Sorting](#) on page 1-15 and [Filtering](#) on page 1-16.) The Switching Sheet List will be filtered based on your subscribed control zones. To determine the control zone that a sheet is associated with, the sheet's **Asset**, as entered on switching sheet's **Request** tab, will be used. If no asset has been entered, then the sheet will fall within the FUZZY zone.

Notes:

- For **Switching Request** users, the list will be filtered to display only Planned sheets. The Switching Request user is not limited to any particular control zone since they do not take authority over control zones.
- The sheet will be loaded with the last highlighted step, if any were highlighted when the sheet was last closed, centered in the middle of the steps list.

Open Switching Sheet using Switching Sheet Search

To search for an existing Switching Sheet:

1. From the **File** menu, select **Switching Sheet Search...** from the **Open** option.
2. In the Search Switching Sheet dialog box, enter the desired text to search and press **Enter** or click the **Search** () button.

Notes:

- For Product configuration only the switching sheet number and the sheet's Description field value will be used to match search criteria.
- The search results will be filtered based on the sheet's master asset NCG and your subscribed zones of authority. The filtering of the results, based on NCG, will not apply to Administration and Switching Request user types.

From the Work Agenda

1. Select an event from one of the Events Lists that has a switching sheet associated to it. This can be determined by checking to see whether a switching sheet number is displayed within the Plan # column for the selected event.
2. Select the **Switching...** option from the **Tools** menu. The Open or Create New Switching Sheet dialog box is displayed.
3. Select the sheet you want to load from the Pre-Created Switching Sheets list and click **Open**. (You can start a new sheet by selecting a sheet type and clicking **Create**.)

From the Event Details

1. Select **Switching...** from the **Actions** menu. The Open or Create New Switching Sheet dialog box is displayed.
2. Select the sheet you want to load from the Pre-Created Switching Sheets list and click **Open**. (You can start a new sheet by selecting a sheet type and clicking **Create**.)

From Crew Actions

1. If a crew has been placed en route to a Master switching sheet event, then select the crew in the crew list.
2. Select **Switching...** from the Actions menu. If only one sheet is associated with the crew, it is displayed in the Web Switching Management window. If multiple sheets are associated with the crew, the Crew to Sheet Selection List displays all associated sheets. If no sheets are associated with the crew, an error message appears.
3. Select a sheet and click **Open**.

From the Control Tool

1. From a Viewer, double-click an asset that is involved in a switching sheet to open the Control Tool.
2. Click the **Switching Plans...** button.
 - If the asset is associated to one switching sheet (that is, it is listed in the **Asset** field on the switching sheet's **Request** tab) **or** if it is included in one switching sheet step, that sheet will be opened in the Web Switching Management window.
 - If the asset is associated with multiple switching sheets **and/or** included in multiple switching sheet steps, the **Asset to Sheet Operation List** window will open. Each associated sheet **and/or** operation will be listed in a separate row. Select a row and click **Open**.

Note: The Asset to Sheet Operation List displays steps for active switching sheets and switching sheets that have been completed within the last 30 days. The switching sheet will be opened in the same mode that the Control Tool is in.

Copying a Switching Sheet

You can create a new switch plan that includes all of the steps in the open switching sheet by using the **Copy As** function. To copy an open switching sheet, do the following:

1. Select **Copy As...** from the Switching Sheet's File menu to open the **Copy Switching Sheet As** dialog box.
2. Select the new switching sheet's type:
 - Planned
 - Emergency
 - Template
 - Outage Correction
3. Click **Create a Copy** to create the new switching sheet.

Note: The switching sheet type will determine how the new sheet opens (for example, recording on or off, which tab is visible, and so on).

Deleting a Switching Sheet

You can mark a switching sheet as deleted if it is no longer being used. Deleted sheets are retained by the system and can be loaded in View-Only mode when hard-associated to a canceled event. Web Switching Management does not support full deletions of switching sheets from the database. A record of all activity for a switching sheet is always retained in the database.

Note the following rules regarding deleted switching sheets:

- The Delete option is only available for planned, template, outage correction, and emergency sheets that do not contain any real-time instructed or completed steps or any event associations other than canceled and manual events.
- You cannot delete a switching sheet once it has been scheduled. If you need to delete the sheet, you must Cancel it first.
- You cannot delete an outage correction sheet that has an event association.
- Deleted sheets do not appear in the Asset to Sheet Operation List. (This list is displayed from the Control Tool.)
- Safety documents associated with a deleted sheet do not appear in the Asset to Safety Document List. (This list is displayed from the Control Tool.)
- The Impacted Customer lists and External Document lists are cleared for deleted sheets.
- Deleted sheets are ignored by the Model Verify functionality.

To delete a switching sheet, follow these steps:

1. Click the Tracking/Audit Log tab.
2. Enter the reasons for the deletion in the Reason field to the right of the grayed Delete button. (The Delete button is not enabled until you enter text in the Reason field.)
3. Click the **Delete** button.

Emergency Switching

Emergency Switching includes any unplanned switching operations that occur due to events during storms, equipment failures, or even planned switching actions that fail or are incorrect. Unlike planned switching where the switching sheet is created and studied before it is issued, in emergency switching the switching sheet is created as the operations take place in real-time. Essentially, a switching sheet is created and implemented simultaneously. Steps are recorded on the Steps tab as the Control Tool actions are being performed, and each step is considered complete as it is being recorded.

Emergency switching operates just like planned switching, except that the Web Switching Management window and Viewer must both be in real-time mode. Whenever switching steps are recorded in a switching sheet using the real-time Control Tool, the operation is considered emergency switching. The switching sheet provides a record of the switching operation.

This section includes the following topics:

- [Creating an Emergency Switching Sheet](#)
- [Recording Emergency Operations](#)

Creating an Emergency Switching Sheet

Emergency switching sheets are typically created from the Work Agenda, Create Event, or Event Details window. When you create an emergency sheet from either of these applications, the sheet is automatically associated to the event and saved to the database. The associated actions pertaining to the event, including the Open and Close step operations, will be included in the new sheet. The sheet cannot be deleted and will always remain associated to the originating event.

To create an emergency switching sheet, do one of the following:

- With an event selected in the Work Agenda, select **Switching...** from the **Tools** menu.
- From the Event Details Window, select **Switching...** from the **Actions** menu.
- From the Create Event window, select the Restored Real Outage event type and complete the required fields. Select the **Create Switching Sheet** check box and then click **OK**.

Open or Create New Switching Sheet

The **Open or Create New Switching Sheet** dialog box will open with the options of creating a new Emergency or Outage Correction switching sheet (from the Switching Sheet Types pane) or opening an existing switching sheet that is associated to the event from the Pre-Created Switching Sheets pane.

Create New Sheet

1. Select the Emergency sheet type from the Switching Sheet Types pane. The **Create** button is enabled.
2. Click the **Create** button.
3. The Web Switching Management window displays the new emergency sheet.

Open an Existing Sheet

1. Select an existing sheet from the Pre-Created Switching Sheets list. The **Open** button is enabled.
2. Click the **Open** button.
3. The Web Switching Management window will load the selected switching sheet.

Alternative Method of Creating an Emergency Switching Sheet

- From the **File** menu, select **New** and then select **Switching Sheet...** to display the New Switching Sheet window. Select **Emergency** as the sheet type and click **Create**.

Note: An emergency switching sheet created this way will not be associated with an event.

Recording Emergency Operations

The new emergency sheet is automatically populated with Start and Finish dates. The Start date is the current date/time; the Finish date is defined as the Start date plus a predefined standard event duration.

Note: The duration is set to four hours in the product environment.

The sheet opens with the **Steps** tab active, real-time mode enabled, and recording on. If the Viewer is open, it transitions to real-time mode also. You can begin recording steps as described in the next section.

To record emergency switching operations, complete these steps:

- Start a new emergency sheet as described in the previous section.
- Create the steps by selecting assets in the Viewer window and selecting operations from the Control Tool. The process of adding recorded steps for emergency sheets is the same as for planned sheets in real-time mode. See [Adding Recorded Steps to a Switching Sheet](#) on page 8-32 for details.

Once an action is completed in the Control Tool, the following occurs:

- The status of the recorded step is set to Completed.
 - The Executed By field is populated with your user ID.
 - The Completed Date field is populated with the date and time shown on the Control Tool or the current time if a Control Tool date/time value is not specified.
 - Instructed actions use the date/time specified from the Control Tool to populate the Instructed Date field. If no Control Tool date/time value is specified, then the current time is used to populate the Instructed Date field.
 - Any outages created by completing steps in Real Time that are associated to an Emergency switching sheet will be classified as Real Outages and not Planned Outages. These Real Time step completions can occur from the Control Tool or from Web Switching Management.
- When you have completed all emergency steps, click the **Tracking/Audit Log** tab and set the sheet state to *Completed* by clicking the **Complete** button. The **Confirm State Transition** dialog box will open; click **Yes** to confirm the completion or click **No** to close the dialog box without completing the sheet. The Finish Date may be updated, if necessary.
 - Optional:* Add a comment in the text field to the right of the **Complete** button.

Note: Changes can no longer be made to the switching sheet while it is in the Completed state.

Switching Sheet List

The Switching Sheet List is a tool used to manage active switching sheets and any switching sheet completed in the last 30 days. To load switching sheets older than 30 days, use the Search Switching Sheet window. The Switching Sheet List is not dynamically updated once it is displayed. If you keep the window pinned and visible, you can update the list using the Refresh button. If the list is closed and then reopened, the list will automatically refresh with the latest data.







The Switching Sheet List serves as the primary mechanism for loading switching sheets. You can either double click a single entry or highlight multiple entries and click the **Open...**  toolbar option. A right-click **Open...** menu option is also available. When loading multiple switching sheets, a progress bar will be displayed at the bottom of the window. Once an open request has been initiated, it cannot be cancelled, but the system does restrict you from having more than 15 switching sheets open at any one time.

Menu and Toolbar Features

This section lists and describes the menu options and toolbar icons available in the Switching Sheet List.

File Menu

The table below describes the options available on the File menu.

| Menu Option | Description | Toolbar Icon |
|---|--|---|
| New... | Opens the New Switching Sheet tool that allows you to create a new switching sheet based on the switching type (for example, planned or emergency). |  |
| Open... | Opens the selected switching sheets. If the window is not pinned or docked, the window will be closed once the sheets are loaded. Note: If the sheet is locked by another user, the Failed to Establish User Lock dialog box will be displayed; see Opening Locked Documents on page 8-73 for information. |  |
| Copy Steps | Copies the selected switching sheet's steps without opening it. The copied steps may then be pasted into another switching sheet. |  |
| Export Table... | Opens a dialog box to allow you to save the current table view data to a comma separated value (csv) file. |  |
| Print List... | Displays the Print Preview dialog box so you can view or print the list. |  |
| Print Preview Selected Sheets... | Displays the Content Selection dialog box so that you can choose which sections of each highlighted sheet to include in the generated documents. By default, PDF documents will be created for each of the highlighted switching sheets. |  |
| Email Selected Sheets... | Displays the Content Selection dialog box so that you can choose which sections of each highlighted sheet to include in the generated documents. By default, PDF documents will be created for each of the highlighted switching sheets. |  |

| Menu Option | Description | Toolbar Icon |
|---------------------------------|---|---|
| Print Selected Sheets... | Displays the Content Selection dialog box so that you can choose which sections of each highlighted sheet to include in the generated documents. By default, PDF generated documents will be printed for each of the highlighted switching sheets. The Content Selection dialog box also includes the target print service. Your default printer will be the default option selected in the combo box list. |  |
| Exit | Closes the Switching List window. | -- |

Sort Menu

The table below describes the options available on the Sort menu.

| Menu Option | Description | Toolbar Icon |
|-----------------------|--|--------------|
| Sort Dialog... | Opens the Sort Dialog, allowing you to create, modify, apply, and save user-defined sorts. See Using the Sort Dialog on page 1-15. | -- |
| Sheet # | Applies the default sort, which is the sheet # in descending order. | -- |

Filter Menu

The table below describes the options available on the Filter menu.



| Menu Option | Description | Toolbar Icon |
|-------------------------|---|--------------|
| Filter Dialog... | Opens the Filter Dialog where you can create, modify, apply, and save user-defined filters. See Filtering on page 1-16. | -- |
| Active | Displays all the active switching sheets (switching sheets NOT in the Status New, Completed, Deleted, Cancelled, or Training-Completed). | -- |
| All | Displays all non-complete switching sheets and completed switching sheets from the last 30 days. - No Icon Completed - Displays switching sheets that have been completed in the last 30 days. | -- |
| Completed | Displays switching sheets that have been completed in the last 30 days. | -- |
| In Progress | Displays all switching sheets in the In Progress state. | -- |
| My Sheets | This displays all sheets that were created or are owned by the current user. | -- |
| New | Displays all switching sheets in the New state. | -- |

| Menu Option | Description | Toolbar Icon |
|-----------------------------|---|--------------|
| Require Verification | Displays the switching sheets that require verification after model change. | |
| Today | Display switching sheets that are scheduled or are being worked on Today. | -- |
| Tomorrow | Display switching sheets that are scheduled for Tomorrow. | -- |

Note: The Today and Tomorrow Switching Sheets List filters are based on the Start and Finish dates of the switching sheets. If tomorrow's or today's date falls within that time period, then the sheet will be included in the list. If the sheet has a Start date that is before today's date and has no Finish date, then the sheet will be included in the list.

Actions Menu

The table below describes the options available on the Actions menu.

| Menu Option | Description | Toolbar Icon |
|----------------|---|---|
| Refresh | Refresh the switching sheet list with the latest data from the database. |  |
| Pin | Pin the window so that it will not close after an open switching sheet request. Note: The icon shows the current state (that is, unpinned). |  |
| Unpin | Unpin the window so that it will close after an open switching sheet request. Note: The icon shows the current state (that is, pinned). |  |
| Dock | Dock the window into the NMS environment window. The tool will be docked next to the Work Agenda list. | -- |
| Undock | Undock the window out from within the NMS environment window. | -- |

Help Menu

The table below describes the options available on the Help menu.

| Menu Option | Description | Toolbar Icon |
|----------------------------------|--|--------------|
| Switching Sheet List Help | Opens the online help system to the Switching Sheet List help content. | -- |

Switching Sheet List Data Fields

The Switching Sheet List provides a tabular view of the switching sheets. The sort and filter criteria are displayed above the table.

- The **Status** column displays the status of the switching sheet. See [Switching Sheet States](#) on page 8-18 for a complete list of switching sheet states.
- The **Type** column displays the switching sheet's type.
- The **Sheet #** column displays the switching sheet's number.
- The **Pressure Zone, Asset, Lift Station, Description, Owner, Charge Number, Start Date, Finish Date** columns display the values from the sheet's **Request** tab.
- The **#Steps** column displays the number of steps in the switching sheet.
- The **User** column displays the user that created the switching sheet.
- The **Owner** column displays the current owner of the switching sheet as shown in the Owner field of the switching sheet's **Request** tab.
- The **Charge Number** column displays the Charge Number as shown in the first Charge Number field of the switching sheet on the sheet's **Request** tab.
- The **Start** and **Finish** Date fields display the switching sheet's Start and Finish Date values as shown on the switching sheet's **Request** tab.
- The **Completed Date** is the date the switching sheet was completed.
- The **Verify** column displays Yes when the switching sheet involved any model changes and require verification.

Opening Locked Documents

The Failed to Establish User Lock dialog box appears when opening switching sheets or safety documents locked by another user. The Previously Established Lock List pane displays the details of the locked sheet or safety document:

- **Fields**
 - **Object Type:** the sheet/safety document type; for example, a planned switching sheet or a HOLD safety document.
 - **Object #:** the number of the sheet/safety document.
 - **User:** the user who has the sheet/safety document locked.
 - **Date:** the date when the sheet/safety document was locked.
- **Buttons**
 - **OK:** closes the dialog box.
 - **Steal Locks...:** opens the Steal Locks dialog box, which allows you to steal the lock to enable editing the sheet or safety document.

Click **OK** to dismiss the dialog box or select one or more rows and click **Steal Locks...** to take the locks from the current owner.

Stealing Locks

When you click the **Steal Locks...** button on the Failed to Establish Locks dialog box, the Steal Locks confirmation dialog box appears. Enter a reason for stealing the lock and click **OK** to take ownership of the selected objects from the current user. The user who had the lock will then be presented with a Stolen Object Locks dialog box that lists the object type, object number, user who stole the lock, and the date when the lock was stolen.

Notes:

- If you attempt to steal locks on a sheet controlled by the system, you will get a Steal Locks Exemption dialog box and will not receive control of the sheet. Click **OK** to dismiss the dialog box.
- These actions are also added to the Audit Log of the sheet or safety document.

Event Associations

Event associations are used to associate events to switching sheets. Associated events are displayed in the Events List on the Steps tab header. (See [Events List](#) on page 8-29.)

Events can be associated to switching sheets in two ways:

- **Hard Associations** are automatic associations that are normally made as you perform actions within Web Switching Management or perform actions from the Control Tool that are recorded into the switching sheet. An event can only have one hard association to a switching sheet. Hard associations cannot be broken once the association has been established; however, the association can be moved to a new switching sheet if the steps that created the event are moved.
- **Soft Associations** are associations that are normally added manually from the [Events List](#) in Web Switching Management. An event can be softly associated to an unlimited number of switching sheets. This type of association can be manually removed up until the associated switching sheet has reached the Completed state.

Note: Event associations do not occur when the event causing action is recorded into the Miscellaneous Log.

Hard Associations

Hard associations can also be further classified by type. There are four types of hard association relation types:

- **Master** is the relationship type made between a Planned switching sheet and its active master switching event. There can only be one Master Event associated to any single switching sheet.
- **Canceled** is the relationship type made between a Planned switching sheet and a canceled master switching event. There can be any number of Canceled event associations to a single switching sheet. These Canceled events were originally classified as Master Events for the plan.
- **Planned** is the relationship type made between a Planned switching sheet and a planned outage. A planned outage is an outage that was generated from a planned switching sheet after the completion of an action recorded in the Steps section of the plan.
- **Forced** is the relationship type made between an Emergency switching sheet and an unplanned outage or non-outage event. A Forced relationship will be made when recording real-time actions into an Emergency switching sheet. The relationship can also be made when creating an Emergency plan for an event from the Work Agenda Events List or the event's Event Details display.

Soft Associations

Soft associations only have one classification type:

- **Manual** is the relationship type made between a switching sheet and a manually associated event. Manual associations are also made between plans if an outage is hard associated to one plan and the outage is restored with another switching sheet. The plan that recorded the restoration step will have the event automatically associated to it with a classification type of Manual. Grouped events can also cause switching sheets to be manually associated. Partially restoring an outage or adding customers to an outage will create a manual association between the switching sheet and the event, if no association (hard or soft) already exists.

Rules for Grouping Event Associations

When resolving outages in the network, it is common for events to be grouped together. When events are grouped, the associations will adhere to the following set of rules:

- If an event with no hard association consumes another event with no hard association, then the resulting event will have no hard association, and its manual associations will be a combined list of both events' manual associations.
- If an event with a hard association consumes an event with no hard association, then the resulting event will have the surviving event's hard association and a combined list of both events' manual associations.
- If an event with no hard association consumes an event with a hard association, then the resulting event will have the consumed event's hard association and a combined list of both events' manual associations.
- If an event with a hard association consumes another event with a hard association, then the resulting event will have the surviving event's hard association. The consumed event's hard association will be listed as a manual association along with the combined list of both events' manual associations.
- If an event consumes another event with an association to the same switching sheet, then the above rules will apply, but the plan will only be listed once in the event's association list. An event can only have one association to a specific switching sheet.

Crew Assignments

Normally when working a switching sheet, the crews are automatically associated to the sheet when the event the crew is assigned to is associated to the sheet. These crews show up in the Crews list just above the steps on the Steps tab. When crews need to be added to the list that will not be assigned or cannot be assigned to events, then the Select Crew dialog box must be used.

The Select Crew dialog box is initiated from the Crews list **Select Crews...** toolbar button (). The dialog box has two tabs for selecting the type of crew you wish to associate to the switching sheet.

System Crews

System crews are the same crews that are available to you from the Crew Actions list. Only available crews will show up in this list. The System Crews list shows the crew's ID, Type, Contact, Shift Status and Job Status. Table column filter fields are available to filter the list down to a specific crew entry. Once an entry is found, the **OK** or **Apply** buttons can be used to assign crews to the switching sheet. Selecting the **OK** button will assign the crews and close the Select Crew dialog box. The Cancel button will cancel any existing selections and close the Select Crew dialog box.

Contractors

The Contractors tab gives you the capability to create contractor crews on the fly. Contractors are crews that are not system crews and do not exist in the NMS proper crew list. The crews available from the Contractor Crew List are only available for selection from Web Switching sheets and Web Safety documents. These crews will not be generally available throughout the NMS environment.

Working with Safety Documents

Oracle Utilities Network Management System Safety Documents, which are an electronic representation of paper safety documents used for switching operations, provide information about a particular operation and record the issuance and release of tags on assets. For switching operations, safety tags are first physically placed on assets, and then the safety document is issued; note that the safety tag must match the safety document type (for example, Hold tags are used with Hold safety documents). Issuing the safety document effectively gives the crew permission to begin work. When the work is completed, the safety document is released, warning the crew that they must stay clear. Once the safety document is released, safety tags may be removed from the assets and the switches may then be closed.

This section includes the following topics:

- [Understanding Safety Document Types](#)
- [Mapping Step Types to Safety Document Types](#)
- [Using Safety Documents in Switching Plans](#)
- [Opening Existing Safety Documents](#)
- [Completing Safety Documents](#)
- [Aborting Safety Documents](#)

Understanding Safety Document Types

Oracle Utilities Network Management System Web Switching Management includes a group of safety documents that represent common utility safety document types. These standard forms may be used to represent established safety documents in your organization.

- **Clearance** - indicates that clearance for work on an asset or in an area has been obtained from the proper authority. The proper authority might be a control center supervisor or a regional dispatcher. Clearance documents imply that the assets or area that requires work has been made safe to work on or in.
- **Delegated Control** - safety document (DCZ) allows users to identify a section of the network that has been turned over to the field for operation. The operator is no longer in control of the section of the network. It is the responsibility of the crew to operate in a safe and secure manner and document actions taken. See [Delegating Control of a Network Area](#) on page 8-89 for more information.
- **Hold** - indicates that the tagged assets should not be operated (for example, if the assets is open, it should remain open). Hold safety documents are used when the asset is to be held open or closed in order to complete work in an area of the distribution system. The purpose of the Hold safety document is to protect crew members and prevent injury to human life. Hold safety documents are placed and removed by individuals who have authority over a specific area or operation and serve to restrict the operation of an asset.
- **Information Note** - provides some pertinent information about the assets. Information Note safety documents are for informational purposes only. These safety documents do not restrict operation of the asset, but provide information that a crew member or utility employee should be aware of when working on the assets.
- **Warning Tag** - provides warning information about the tagged assets. Like Information Note safety documents, Warning Tags are for informational purposes only. These safety documents do not restrict operation of the assets, but provide information that a crew member or utility employee should be aware of when working on the tagged assets.

While safety document names and features may vary, understanding these types will help you understand the general use of most safety documents. Crews typically "own" safety documents and must authorize their release when they are finished working in an area or on an asset.

Mapping Step Types to Safety Document Types

Safety document types are associated with certain types of steps. These step-to-safety document mappings are configurable. The following list shows what types of steps each safety document type is pre-configured to accept.

- **Clearance:**
 - Place Clearance Tag
 - Remove Clearance Tag
 -
- **Delegated Control (DCZ)**
 - Place DCZ Tag
 - Remove DCZ Tag
- **Hold:**
 - Place Hold Tag
 - Remove Hold Tag
- **Informational Note:**
 - Place INFO Tag
 - Remove INFO Tag
- **Warning Tag:**
 - Place WARN Tag
 - Remove WARN Tag

Using Safety Documents in Switching Plans







Understanding the Safety Documents Tab

The Switching Sheet Safety Documents tab displays a list of all safety documents associated with a switching sheet. The Safety Documents tab displays the following fields and menu bar buttons:

Fields

- **Type** displays the type of safety document. (See [Understanding Safety Document Types](#) on page 8-77.)
- **Doc #** displays the safety document number.
- **Status** displays the status of the safety document. Valid statuses are: New, Issued, Released, Unissued, Aborted, Deleted, and Completed.
- **Crews** displays the crews assigned to this safety document.
- **Description** displays a description of the safety document.











Menu Bar Buttons

- The **Refresh** button () refreshes the safety document list.
- The **Create a Safety Document** button () opens a context menu that allows you to choose a safety document type or open the Select Safety Type dialog box.
- The **Open** button () opens the selected safety document. (Alternatively, you can double-click the document in the list.)
- The **Associate** button () displays the Switching Sheet Association dialog box. From the dialog box you can associate the safety document to a different switching sheet. See [Switching Sheet Associations](#) on page 8-95 for more details.
- The **Disassociate** button (), when pressed, displays a confirmation dialog box pertaining to the disassociation of the safety document. Confirming the action will cause the safety document to be disassociated from the switching sheet. Once disassociated, the document is converted into a stand alone safety document.
- The **Delete** button () deletes the selected safety document. Safety documents can only be deleted if there are no steps associated to the document. Deleted safety documents are not removed from the database.

Safety Document Dialog Overview

The Safety Documents associated to switching sheets are displayed as detached windows. When working with Web Safety, when there is no originating switching sheet, the document takes on a slightly different behavior and look. For more information on Stand Alone Safety Documents see [Web Safety](#) on page 8-101.

Toolbar Icons

- The **Save** button () saves your changes to the safety document.
- The **Print Preview** button () allows you to select a report format and then preview the safety document in the selected format.
- The **Print** button () allows you to select a printer and then print a hard copy of the safety document to the selected printer.
- The **Email** button () allows you to email a version of safety document. You will be prompted to select a report format (PDF, HTML, RTF, or XML); click **Email...** to generate the file, which will be attached to a new message launched from your default email application.
- The **Validate** button () , which is available on the DCZ safety documents, is used to determine whether the listed assets potentially isolate an area of the network. If the list of assets is not sufficient, a dialog will suggest the first missing asset needed, provide an option to add it, and re-validate the new list.
- The **Issue** button () adds a step for issuing the selected safety document. The step is added to the end of the steps list or after the step insertion indicator (if one has been placed). This button is enabled when a document is in the New and Released states so the document may be issued and released multiple times. If any of the assets in the Tag Points list are not associated to steps, then the appropriate conditions will be placed on those assets when the document is transitioned to the Issued state.
- The **Unissue** button () is used to place an Issued safety document or a Released safety document into an Unissued (edit) state where the asset lists can be altered. While in the Unissued state, you can add assets to the lists and mark assets already in the list for removal. Only when the safety document transitions back to the Issued state will the changes be applied.
- The **Release** button () adds a step for releasing the selected safety document. The step is added to the end of the steps list or after the step insertion indicator (if one has been placed). This button is only enabled if the safety document has been issued. Selecting this button will cause the Complete button to be enabled.
- The **Complete** button () adds a step for completing the selected safety document. The step is added to the end of the steps list or after the step insertion indicator (if one has been placed). If any of the assets in the Tag Points list are not associated to steps, then the appropriate conditions will be removed from those assets when the document is transitioned to the Completed state.
- The **Abort** button () allows you to set the status of the safety document to Aborted. The system prompts you to confirm the action before aborting. This button is only available in real-time mode and only for safety documents that are in the New state.
- The **Associate** button () displays the Switching Sheet Association dialog box. From the dialog box you can associate the safety document to a different switching sheet. See [Switching Sheet Associations](#) on page 8-95 for more details.



- The **Disassociate** button () , when pressed, displays a confirmation dialog box pertaining to the disassociation of the safety document. Confirming the action will cause the safety document to be disassociated from the switching sheet. Once disassociated, the document is converted into a stand alone safety document.

Safety Document Panes











The safety document dialog box displays the following panes:





- **Tag Points** display the assets that the safety document is associated with.

Table Columns

- **Edit State (untitled):** an iconic representation of the edited state of the asset in the Unissued state. The edits will be applied when the document is issued. When working in Study mode, the edit state indicators will remain visible until the document is issued in real time.
 - : The asset has been marked for removal.
 - : The asset has been added to the asset list and will be used as a boundary point the next time the document is issued.
- **Asset:** the asset used to define the area or point of coverage of the safety document.

Toolbar Buttons

-  **Record** /  **Stop** : Toggles recording of assets off or on. The Tag Points list allows users to record assets via selections from the Viewer. To enable this feature, simply turn on recording and select assets in the Viewer.
- The **Add Asset...** button () allows you to manually add an asset to the list.
- The **Undo Asset Edit** button () allows you to undo an addition or removal of an asset from the list. This option is only available when making asset modifications in the Unissued state.
- The **Remove Asset** button () allows you to remove a selected asset from the Tag Points asset list.
- The **Object Focus** button () focuses the Viewer 1 window on the selected asset.
-  **Record** /  **Stop** **Pressure Zones** displays the value found in the **Pressure Zones** field of the originating switching sheet. To alter this value, simply enter your new value into the field.
 - The **Update** button () is used to populate the **Pressure Zones** field with the list of **Pressure Zones** associated to the linked switching sheet step assets and the assets listed on the safety document.
 - The **Reset Pressure Zone Value** button () is used to replace the safety document's current pressure zone value with the associated switching sheet **Pressure Zones** field value when the safety document was created. The switching sheet's **Pressure Zones** field is found on the **Request** tab.
- **Assigned Crews** displays a table list of the Crew IDs of the crews that the safety document has been issued to, as well as each crew's mobile number, pager number, and crew type. The crew IDs are auto-populated with the value from the **Instructed To** field in the safety state transition switching step. A crew is required in this list before an Issue safety state transition step can be completed in real-time.

- To select a crew to assign to this safety document, click the **Select Crew...** () button to open the Select Safety Crew dialog box. See [Assigning Crews to a Safety Document](#) on page 8-83.
- To display the selected crew information, click the **Crew Info...** () button.
- To indicate whether the crew is issued or clear of the zone defined by the safety document, click the **Crew Issued/Clear** () button and select either **Issued** or **Clear**. The Position column will be updated with the status.
- To delete crews from this list, click the crews and then click the **Remove Crews** button (). At least one crew must remain assigned while the document is in the Issued state.
- **Description** is a text field that allows you to enter notes for the safety document.
- **Audit Log** contains the following information:
 - **Table Fields:**
 - **Date:** the date and time of each entry.
 - **Description:** a description of the state change or asset operation.
 - **Asset:** the asset associated with the step.
 - **User:** the name of the user who recorded the action.
 - **Crews:** the crew identifiers pertaining to the audit log entry.
 - The **Comment** section of the Audit Log panel allows you to add a comment to the log.
- **Edit Log** tracks the changes made to the entry fields of the document. It contains the following information:
 - **Date:** the date and time of each entry.
 - **User:** the name of the user who recorded the action.
 - **State:** the state of the safety document when the entry was added.
 - **Field:** The name of the field that was updated.
 - **Previous Value:** The previous value of the field before the update.

Creating a Safety Document from a Switching Sheet

Assets may be added automatically to a Safety Document by creating a safety document from step selections within the Steps list of the originating switching sheet. You may create a safety document in two ways:

1. Create a Safety Document for a Selected Step:

- On the Steps tab, select the steps to which you want the safety document associated. For instance, select Hold Tag steps to create Hold safety documents. These steps then define the isolation points for the safety document.
- Click the **Create Safety Document for Selected Step** toolbar button ().
 - If the selected step maps to multiple types of safety documents, the Select Safety Type dialog box prompts you to select the document type.

Your selected step must conform or map to at least one safety document type. If a selected step does not map to a safety document type, the system will return an error message in the Invalid Step Selection dialog box. Click **OK** to close the dialog box.
 - Select the safety document type and click **OK**.

Note: For a list of step types to safety document types, see [Mapping Step Types to Safety Document Types](#) on page 8-78. The steps in the sheet will also be updated with an additional entry in the Operation text indicating which safety document the step is associated to.

2. Create a Safety Document Without Selecting a Step:

- To create a safety document without selecting a step, click the **Create Safety Document** () button, which provides a context menu allowing you to select a specific safety document type or open the Select Safety Document Type dialog box.
- If you select a safety document type, the new safety document will be created. If you select **Select Safety Type Dialog...**, the Select Safety Type dialog box will open allowing you to choose the document type. Select the safety document type, and click **OK**.

Assigning Crews to a Safety Document

The Select Safety Crew dialog box allows you to assign crews to the safety document. You may also create contractor crews from the **Contractors** tab. By default, the dialog box will open showing the crews listed on the parent switching sheet's Crews list. The **Switching Sheet Crews** tab will only be visible for safety documents associated to switching sheets.

Populating Crews from the Switching Sheet

Crews are automatically assigned to safety documents when the safety document is created from a switching sheet where the switching sheet has crews listed in the **Crews** list. If a subset of the switching sheet's crews should be used to populate the safety document's Crews list, then simply select the crews prior to creating the safety document from the switching sheet.

1. Add a list of crews to the switching sheet's **Crews** list.
2. Click the switching sheet's **Create Safety Document** button and select the desired safety document type.

The safety document will be created with a list of assigned crews matching the crews listed in the parent switching sheet. If **none** or **all** of the crews were highlighted in the switching sheet, then all of these crews will be assigned to the safety document. If a subset of the crews were highlighted in the switching sheet, then only those crews will be assigned to the safety document when it is created.

Selecting Crews from the System Crews List

To assign a standard (system) crew to the safety document:

1. Click the **Select Crew...** button () to open the Select Safety Crew dialog box
2. On the **System Crews** tab, select one or more crew rows in the table.

Note: You may **Shift+Click** to select multiple adjacent rows or **Control+Click** to select non-adjacent rows.

3. Click **OK** to assign the crews and close the dialog box.

Note: Click **Apply** to assign the selected crews without closing the dialog box. Crews will appear in the "Unknown" position.

Creating and Assigning Contractor Crews from the Contractor Entry Form

You may add a new contractor crew using the Contractor Entry Form. The created crews are assigned to the current safety document and added to the Contractor Crew List from which they may be assigned to other safety documents or switching sheets.

The form contains the following fields:

- Crew ID: the crew name or identifier.

- Contact: the name of the crew contact person.
- Mobile #: the crew's mobile number.
- Pager #: the crew's pager number.
- Type: crew option menu that allows you to choose the crew type.
- Comments: text field for comments.

Actions

- **Create and Assign Crew** (): assigns the new crew entry to the safety document and adds them to the contractor crew list.





Note: The Select Safety Crew dialog box closes once the add button () is clicked.

- **Clear Crew Fields** (): clears the entry form.

Using the Contractor Crew List

The Contractor Crew List allows you to assign existing contractor crews to the safety document or populate the Contractor Entry Form to reuse crew data when creating additional contractor crews.

The form contains the following toolbar buttons:



- **Refresh Crew List** (): refreshes the contractor crew list with the full list of active contractors found in the database.
- **Assign Crew** (): assigns crews to the safety document.
- **Transfer Crew Data** (): transfers the selected crew's data up to the Contractor Entry Form fields. This allows contractors to be copied with minimal effort.
- **Obsolete Crew** (): obsoletes a crew so that it no longer shows up in the Contractor Crew List. If the crew is still part of an active safety document or switching sheet, an error will be generated. The crew is not deleted from the system as it is still needed for auditing purposes in completed switching sheets and safety documents.

Assigning an Existing Contractor Crew

1. Select the crew rows in the Contractor Crew List.
2. Click the **Assign Crew** button () to assign the crews to the sheet.

Assigning a New Contractor Crew Using Existing Crew Data

To create an additional contractor crew using data from an existing crew, do the following

1. In the Contractor Crew List, select the row with the desired crew data.
2. Click the **Transfer Crew Data** button () to copy the data to the Contractor Entry Form.
3. Edit the data for the new crew.
4. Click the **Create and Assign Crew** button () to assign the new crew to the safety document and add them to the Contractor Crew List.

Adding a Safety State Transition Step

Each safety state transition step performs a single action, such as issuing or releasing a safety document. To add safety state transition steps, do the following:

1. From a switching, create a new safety document. See [Creating a Safety Document from a Switching Sheet](#) on page 8-82 for more information.
2. Validate that step recording is still turned on in the Steps tab.
3. Click the **Issue** button () on the safety document. A new safety state transition step is recorded into the switching sheet steps list. The Operation column of the step indicates the type of operation being performed.

Notes:

Conditions associated to the assets in the Tag Points list has to be on the assets for the document to be issued. If the conditions are not on the assets, an error dialog box will be displayed with the list of conditions that could not be found. The switching steps associated to those conditions will be highlighted in the switching sheet. This is mode specific, so when in study mode, the conditions have to be on the assets in your study session. Conditions are not required when only the Other Assets field is filled out.

When recording the safety state transition steps in Real-Time, the safety document must have an assigned crew before it can be issued. This is not a requirement when in Study mode.

4. Select the **Release** and **Complete** buttons on the safety document. New safety state transition steps are recorded into the Steps list for the Release and Complete operations.
5. Close the safety document.

Note: If you changed the Other Assets or Description field, you will be asked to save the changes. All other fields are automatically saved within the associated switching steps.

For instructions on executing safety state transition steps, see [Executing Safety State Transition Steps](#) on page 8-87.

Safety State Transition Failed Dialog Box

When a safety document is issued the conditions (tags) associated with it are locked. If some of the expected conditions are missing or fail to lock, the Safety Transition Failed dialog box is displayed. The Failed Safety Actions table contains the list of switching steps associated with the safety document, that caused the failure.

The switching steps placing those conditions will be highlighted on the Steps tab. Affected rows in the Tag Points list in the safety document will also be highlighted.

Editing the Asset List

The **Tag Points** lists on the Hold, Clearance, Delegated Control, Information, and Warning safety documents may only be altered when in the *New* or *Unissued* states.

Adding Assets to a Non-Execute Safety Document

You can add additional assets to a safety document through one of three ways.

- The first method involves associated steps with assets to the safety document. The second method allows you to added assets directly to the safety document through asset selections in the Viewer. The third method uses the Add Asset dialog box, from which you can enter or search for an asset to be added to the list.

Step Association Method

The step association method is accomplished by doing the following:

1. Open a non-execute version of a safety document. (A non-execute version is loaded from the Safety Lists and the Control Tool. It displays a toolbar at the top of the dialog box and no Execute button at the bottom.)

From the associated switching sheet steps list, select the step with the asset operation you want added to the safety document. For example, if you select an Add or Remove Tag step, the assets is added to the Tag Points list on the safety document dialog box.

2. Click the **Link Switching Step Asset** button () on the safety document dialog box. The new asset is added to the appropriate asset list.

Notes:

- If the selected step is already associated to a safety document, then an error dialog box indicates which safety document the step is already associated to.
- If the select step type is not configured for the safety document type, then an error will be displayed indicating the step that does not conform to the configured step to safety document type rules. For a list of step types to safety document types, see [Mapping Step Types to Safety Document Types](#) on page 8-78.



Asset Recording Method

The asset recording method is accomplished by doing the following:

1. Open a non-execute version of a safety document. (A non-execute version is loaded from the Safety Lists and the Control Tool. It displays a toolbar at the top of the dialog box without an **Execute** button.)
2. Click the **Record** button on the Tag Points toolbar to turn recording on for that asset list.
3. In the Viewer, select assets that should be added to the Tag Points asset list.

Safety Document Add Asset Dialog Method

Using the Safety Document Add Asset dialog box, assets can be added to the Tag Points list by doing the following:

1. Open a non-execute version of a safety document. (A non-execute version is loaded from the Safety Lists and the Control Tool. It displays a toolbar at the top of the dialog box without an **Execute** button.)
2. Click the **Add Asset...** button () found on the Tag Points toolbar. The Safety Document Add Asset dialog box is displayed.
3. From the dialog box, enter part or all of an asset alias. The search button () can be used to find an asset from a partial asset id.
4. Click **Add Asset** (). The asset will be added to the Tag Points list.
5. Continue to add assets and when completed, click **Close**.

Removing Assets

You can remove assets from an asset list in two ways.

Option 1:

1. Open a non-execute version of a safety document. (A non-execute version is loaded from the Safety Lists and the Control Tool. It displays a toolbar at the top of the dialog box without an **Execute** button.)
2. Select the asset you would like to remove from the Tag Points list.
3. Click the **Remove Asset** button () from the appropriate asset list toolbar. The asset is removed from the list if the document is in the New state or is marked for removal if the document is in the Unissued state

Option 2:

1. From the associated switching sheet steps list, select the step with the asset operation that you want removed from the safety document. For instance, if you select an Add or Remove tag step, the asset will be removed from the Tag Points list.
2. Click the **Unlink From a Safety Document** button () on the **Steps** tab toolbar. The asset is removed from the safety document's asset list if the document is in the New state or is marked for removal if the document is in the Unissued state.

Note: The **Unlink From a Safety Document** button can only be used for assets in the safety document that are associated to steps. Assets added without step associations will have to be removed using Option 1 described above.

Adding a Comment to the Audit Log

The Comment section of the Audit Log panel allows you to add a comment to the log. Select the Comment field and enter a comment; click the **Add** button () to add the comment to the Audit Log.

Executing Safety State Transition Steps

Once a safety state transition step has been recorded, executing (completing) the step causes the Execute Safety Step dialog box to be displayed. This dialog box looks just like the original safety document dialog box except that it has no toolbar and it displays two buttons: **Execute** and **Cancel**. Use this dialog box to verify that the safety document information is correct, and then click **Execute** to execute the step.

When a tag step with an associated safety document is executed, the Control Tool executes placement of the appropriate tag (Hold, Clearance, and so on) on the asset. The symbol on the asset indicates that a condition exists on the asset, that the area has not been issued to the crew, and is not yet isolated. After the safety document has been issued, the symbol on the asset changes to indicate that the tag is under the control of the safety document. For example, if configured in your project, a Hold tag may change to indicate Hold with a small lock symbol next to it. When a tag changes to a locked state, the safety document must be released before the tags can be removed using the Control Tool. Likewise, when the safety document is transitioned to the Unissued state, the tag symbols on the assets will change to indicate that they are still part of an active safety document, but are in a state to where they can be removed; they are allowed to be removed so that the zone of coverage for the safety document can be altered while in the Unissued state.

For more information, see one of the following topics:

- [Issuing Safety Documents While Executing Steps](#)
- [Releasing Safety Documents While Executing Steps](#)

Issuing Safety Documents

Safety documents are issued when an Issue safety document switching step is completed and the **Execute** button is clicked on the safety document.

Note: The appropriate tag type must be placed on the asset prior to the safety document being issued. For example, to issue a Hold document, you must place a Hold tag on the asset before the safety document can be issued. This only pertains to assets associated to switching steps. Assets not associated to steps will automatically have conditions placed on them when the document is issued.

When a safety document is transitioned from the Unissued state to the Issued state, all of the pending asset list changes will be applied. If the transition is initiated in real-time mode, then any

assets marked for removal will be removed from the list and related audit log entries will be created for each asset change.

Once a safety document is issued:

- Crews are transitioned to the "Issued" position.
- You cannot complete, delete, or reissue the safety document. The asset lists cannot be altered while in the Issued state.
- The only state related button options available on the safety document dialog box are **Unissue** and **Release**.
- The Viewer displays a symbol on all assets that are specified in the safety document to indicate that the safety document has been issued.

Issuing Safety Documents Manually

To issue a safety document manually:

1. Open the safety document (if it is not already open) by selecting the document on the Safety Documents tab and clicking the **Open** button.
2. Click **Issue** on the open safety document. A symbol appears on all assets that are specified in the safety document to indicate that the safety document has been issued.

Note: If you manually Issue a safety document in real-time mode, a safety state transition step is automatically recorded to the Steps list, regardless of whether step recording is turned on. This is the audit of the safety documents transitions.

Issuing Safety Documents While Executing Steps

To issue a safety document through step execution:

1. From the Steps List, select the Issue safety state transition step and click the **Complete** button. The Execute Safety Step dialog box opens, and the **Execute** and **Cancel** buttons are enabled.

Note: When instructing safety state transition steps in real-time mode, the safety document dialog box is not displayed. It is only displayed when the step is completed.

2. Click the **Execute** button. A symbol appears on all assets in the Viewer that are specified in the safety document to indicate that the safety document has been issued. The safety state transition step is also marked as Completed.

If any of the assets in the Tag Points list were not associated to switching steps, then conditions will be applied to the assets first. After all the conditions are on the assets, then the conditions will be changed to indicate that they are under the control of the safety document.

Releasing Safety Documents

Safety documents are released when switching steps associated to a releasing safety document are completed and the safety document's **Execute** button is clicked. The symbol for the safety document is removed from the asset in the Viewer and the original tag symbols are placed back onto the asset. At this point the Safety Document can either be reissued to a different crew or completed.

Note: Safety Documents cannot be released if any crews are still in the "Issued" position. Crews need to be "Clear" to proceed.

Releasing Safety Documents Manually

To release a safety document manually:

Note: The document must already be issued before it can be released.

1. Open the safety document (if it is not already open) by selecting the document on the Safety Documents tab and click **Open**.
2. In the safety document, click **Release**. The symbol for the safety document is removed from the asset and the original tag symbols are placed on the asset.

Note: If you manually release a safety document in real-time mode, a safety state transition step is automatically recorded to the Steps list, regardless of whether step recording is turned on. This is the audit of the safety documents transitions.

Releasing Safety Documents While Executing Steps

To release a safety document through step execution:

1. From the Steps List, select the Release safety state transition step and click **Complete**. The Execute Safety Step dialog box opens, and the **Execute** and **Cancel** buttons are enabled.

Note: When instructing safety state transition steps in real-time mode, the safety document dialog box is not displayed. It is only displayed when the step is completed.

2. Click **Execute**. The symbol for the safety document is removed from the assets and the original tag symbols are placed on the assets. The safety state transition step is also marked as Completed.

Deleting a Safety Document

Safety documents can be marked as Deleted from the associated switching sheets Safety Documents tab. Safety documents can only transition to the Deleted state when they do not have safety state transition steps linked to them in the switching sheet's Steps list. Attempting to mark a safety document as Deleted with linked safety state transition steps will result in an error dialog box. You will need to delete the safety state transition steps before the safety document can be marked as Deleted.

To mark a safety document as Deleted:

1. Navigate to the associated switching sheets **Safety Documents** tab.
2. From the safety documents list, select the document entry, and click **Delete**. The document will be marked as Deleted. Safety documents can only be marked as Deleted when in the New state.

Delegating Control of a Network Area

When you issue a DCZ Safety document, the system delegates the segment of the network bounded by the listed assets. No operations are allowed on any assets in the segment until the document is released.

Your assets must completely bound an area to be considered adequate for Delegated Control. That is, there should be no alternate way to supply any of the assets in the area.

Safety Document List

The Safety Document List is a tool used to manage active safety documents and any safety documents associated to switching sheets that have been completed in the last 30 days. To load safety documents no longer available in the Safety Document List, use the Search Safety Document window.

Note: The Safety Document List is not dynamically updated once it is displayed. If you keep the window pinned and visible, then you will need to click **Refresh** to update the list. If the list is closed and remapped, then the list will be automatically refreshed with the latest data.

The Safety Document List serves as the primary mechanism from which to load safety documents outside or not associated to switching sheets. You can either double click on a single entry or highlight multiple entries and click the **Open...** toolbar option.

Note: When loading multiple safety documents, a progress bar will be displayed at the bottom of the window.

Once an open request has been initiated, it cannot be cancelled, but the system does restrict you from having more than 15 switching sheets open at any one time. Each safety document is linked to a switching sheet.



The Safety Document List will be filtered based on the control zones you are subscribed to. The asset listed on the parent sheet's **Request** tab determines the control zone that a safety document is associated with; however, if no asset is entered, then the safety document will fall within the FUZZY zone.

Menu and Toolbar Features

This section lists and describes the menu options and toolbar icons available in the Safety Document List.

File Menu

The table below describes the options available on the File menu.

| Menu Option | Description | Icon |
|------------------------|--|---|
| Export Table... | Opens a dialog box to allow you to save the current table view data to a comma separated value (csv) file. |  |
| Print | Displays the Print Preview dialog box so you can view or print the list. |  |
| Exit | Closes the Safety Document List window. | -- |

Sort Menu

The table below describes the options available on the Sort menu.

| Menu Option | Description | Icon |
|-----------------------|--|------|
| Sort Dialog... | Opens the Sort dialog, allowing you to create, modify, apply, and save user-defined sorts. See Using the Sort Dialog on page 1-15. | -- |
| Doc # | Applies the default sort, which is the doc # in descending order. | -- |





Filter Menu

The table below describes the options available on the Filter menu.

| Menu Option | Description | Icon |
|-------------------------|---|------|
| Filter Dialog... | Opens the Filter dialog box where you can create, modify, apply, and save user-defined filters. See Filtering on page 1-16. | -- |
| Active | Displays all the active safety documents (safety documents with statuses of Issued, Unissued, and Released). | -- |
| All | Displays all safety documents and safety documents associated to completed switching sheets from the last 30 days. | -- |
| Completed | Displays safety documents that are in the Completed state that are not associated to a switching sheet that has been completed longer than 30 days. | |
| Issued | Displays all safety documents in the Issued state. | -- |
| New | Displays all safety documents in the New state. | |

Actions Menu

The table below describes the options available on the **Actions** menu.

| Menu Option | Description | Toolbar Icon |
|----------------|---|---|
| Open... | Opens the selected safety documents and their associated switching sheets. If the window is not pinned or docked, the window will be closed once the safety documents are loaded. Note: If the safety is locked by another user, the Failed to Establish User Lock dialog box will be displayed; see Opening Locked Documents on page 8-73 for information. |  |
| Refresh | Refresh the safety document list with the latest data from the database. |  |
| Pin | Pin the window so that it will not close after an open safety document request. Note: The icon shows the current state (that is, unpinned). |  |
| Unpin | Unpin the window so that it will close after an open safety document request. Note: The icon shows the current state (that is, pinned). |  |
| Dock | Dock the window into the NMS environment window. The tool will be docked next to the Work Agenda list. | -- |

| Menu Option | Description | Toolbar Icon |
|-------------|---|--------------|
| Undock | Undock the window out from within the NMS environment window. | -- |

Help Menu - The table below describes the options available on the Help menu.

| Menu Option | Description | Toolbar Icon |
|---------------------------|--|--------------|
| Safety Document List Help | Opens the online help system to the Safety Document List help content. | -- |

Safety Document List Data Fields

The Safety Document List provides a tabular view of the safety document. The sort and filter criteria are displayed above the table.

- The **Status** column displays the status of the safety document.
- The **Type** column displays the safety document type.
- The **Doc #** column displays the safety document number.
- The **Sheet #** column displays the switching sheet the document is associated to.
- The **Pressure Zone** column displays pressure zone values as displayed on the safety document.
- The **Issued Date** column displays the date the document was last issued.
- The **Crews** column displays the crews the document was issued to.
- The **Description** is the description of the safety document as entered on the document.
- The **Released Date** displays the date the document was last released.
- The **Completed Date** displays the date the document was completed.

Opening Existing Safety Documents

Note: If the sheet is locked by another user, the Failed to Establish User Lock dialog box will be displayed; see [Opening Locked Documents](#) on page 8-73 for information.

To open an existing safety document, complete these steps:

From the Web Workspace File menu:

1. Select **Open** and then **Safety Documents...** The Safety Documents List appears.
2. Select the safety document you want to open and click the **Open** button or double-click on the document in the list. The safety document is opened. If the safety document is associated with a switching sheet, the switching sheet will also open.

From the Web Workspace Search Safety Document Dialog

To search for an existing safety document:

1. From the Web Workspace **File** menu, select **Safety Document Search...** from the **Open** option.

2. In the Search Safety Document dialog box, enter the desired text to search and press **Enter** or click the **Search** (🔍) button.

Note: The search results will be filtered based on the parent sheet's master asset NCG and your subscribed zones of authority. The NCG for stand alone safety documents will be determined by the asset populated in the safety document's **Asset** field. The filtering of the results, based on NCG, will not apply to the Administration user type.

Open a Safety Document from an Open Switching Sheet

1. Click the Safety Documents tab.
2. Select the safety document you want to open and click the **Open** button or double-click the document in the list. The safety document dialog box is displayed.

Open a Safety Document from a Switching Step on the Steps Tab

1. Right-click on one or more steps that have safety document associations, then select **Load Safety Documents...** from the context menu. The safety document dialog boxes are displayed.

Note: Steps with associated safety documents display the document type and number displayed in the Operation step column.

Open a Safety Document from the Control Tool

1. For active safety documents, double-click an asset in the Viewer.
2. From the Control Tool, click **Safety Documents...** and then select **Open Safety Documents...** from the sub-menu.
 - If only one safety document is currently active on this asset, then the safety document dialog box is displayed.
 - If multiple safety documents are active, the Asset to Safety Document List displays a list of safety documents for the asset. The list includes only safety documents that are part of an active sheet and documents that were completed in the last 30 days. Select the safety document you want to load from this list.

The safety document and the associated switching sheet are opened. The safety document will be opened in the same mode that the Control Tool is in.

Completing Safety Documents

When you have completed all steps in a switching sheet, you should complete all safety documents associated with the sheet.

To complete a safety document, use either of the following methods:

Option 1

1. Follow the steps described above to open the safety document.
2. Click the **Complete** button on the safety document dialog box.

Note: Once completed, the document is locked from further editing. When manually completing a safety document in real-time mode, the action is automatically recorded in the associated switching sheet's Steps list.

Any assets in the Tag Points list, that were not associated to steps, will have their conditions removed.

3. Repeat these steps for all safety documents associated with the switching sheet.

Option 2

Record a Complete safety state transition step (as described in the previous sections) and use that step to complete the safety document. Repeat for all safety documents associated with the switching sheet.

Aborting Safety Documents

If a switching sheet is aborted, you will need to abort any associated safety documents before you can complete the switching sheet.

Note: The Abort option is only available in real-time mode when the safety document is in the New state.

To abort a safety document, follow these steps:

1. Click the Safety Documents tab.
2. Double-click the safety document you want to abort.
3. Click the **Abort** button on the toolbar.
4. When prompted, confirm your action.

Switching Sheet Associations

Safety documents can be associated to different switching sheets and even disassociated and converted into a stand alone safety document. Safety documents can only be associated to different sheets or disassociated if the safety document does not have any switching sheet step links. An error will be issued to you if you attempt to disassociate or move a safety document that has linked switching sheet steps. A safety document's type and number will be displayed in the step's Operation column if a link exists.

When disassociating a safety document from a switching sheet, a confirmation dialog box will be displayed to you. You must confirm the operation before the disassociation will proceed. When the document is disassociated, it will be converted into a stand alone safety document. The audit log of the switching sheet and the safety document will indicate when and who initiated the operation.

Safety document associations originate from the Switching Sheet Association dialog box. This dialog box allows you to select a sheet from a list of switching sheets you already have loaded or you can search for a particular switching sheet in the system. Completed switching sheets and switching sheets that cannot accept safety document associations will be filtered out of the list. Safety document association changes will result in audit log entries in the original switching sheet along with the target switching sheet and the safety document.

Outage Correction

Web Switching Management can be used for outage correction. After an outage is completed, you can either correct the associated outages by transitioning the plan to the Rework state and clicking the Correct Outage button, or you can create a new Outage Correction sheet and re-record steps to replace a single selected outage.

Correcting Outages in a Rework Sheet

When you transition your sheet to the Rework state, a Correct Outage button () will appear on the Steps tab. Change step times or use the Find/Replace dialog box to change assets, then click the Correct Outage button to update the event with the new customer counts.

Due to the complicated nature of the grouping algorithm, the steps and event relationships need to remain unchanged. That is, if step 6 originally restored the outage created in step 2, then step 6 needs to continue to restore the outage created in step 2. The **Events** column appears when the sheet is in Rework mode to help clarify this situation.

Using Outage Correction Sheets

After you create a new Outage Correction sheet, you will re-record the outage restoration sequence in study mode. Although the scenario is recorded in study mode, the corrections will be made to the real-time outage. Study mode is used so that the model can be altered to resemble the real conditions when the outage was created.

Note: In order to use Outage Correction, you will need to have access to an available study session.

Re-Recording the Outage Restoration Sequence in Study Mode

To re-record the correct outage restoration sequence, follow these steps:

1. In your study mode Viewer, manipulate the model to represent what the conditions were when the outage was created. This will be used as your template to record a new scenario into the Outage Correction sheet.
2. Open Event Details for the completed event, click the **Switching...** button. The Open Or Create New Switch Sheet dialog box is displayed. Select the **Outage Correction** sheet type and then click the **Create** button. An Outage Correction switching sheet is created for the event.
3. In the Outage Correction switching sheet, turn recording on.
4. Record the entire set of corrected outage and restoration steps in the Viewer, using the Control Tool's date/time selector to set the correct operation times.
5. Manipulate the model back to the baseline, as in step 1. This is important because the algorithm plays the steps against the current study network to determine the customers affected. Use the Impacted Customers tab to verify that the correct number of customers will be impacted by the new set of steps.
6. Click the **Correct Outage** button on the Steps tab toolbar. A confirmation dialog box appears.
7. Click **OK**. The system validates the plan and, if successful, replaces all affected customer data for the related outage and updates the new outage time, customer count, and outage asset. The Event Details, when re-loaded, will reflect any partial restoration changes as well.

Note: If you are replacing an outage that was involved in a partial restoration scenario, you will need to either update the other related outages or mark them so that they are not reported and calculated in your indices.

Outage Correction Error Codes

The **Correct Outage** button performs a number of validation actions that can result in errors and warnings.

- Outage Correction sheets must be associated with an event.
- The chosen event must be in the completed state.
- The outage time must be at least one second before the restore time .
- All customers outaged by the new steps must also be restored.
- Original customer calls must be affected by the new steps and must fit within their outage and restoration times.
- Customers who called in the original event are no longer in the model.
- Devices used in the new steps were not valid at the time of the original event.

Using the Miscellaneous Log

The Miscellaneous Log automatically records all real-time switching actions that are not recorded in any switching sheet. The miscellaneous log does not need to be open for steps to be recorded; the system automatically detects steps performed in real-time that are not being recorded in a switching sheet. You can use the miscellaneous log rather than creating emergency switching sheets.











This section includes the following topics:

- [Displaying the Miscellaneous Log](#)
- [Filtering the Log](#)
- [Editing the Miscellaneous Log Steps](#)



Displaying the Miscellaneous Log

To view the Miscellaneous Log, select **Miscellaneous Log...** from the **Tools** menu. The Miscellaneous Log displays the same columns as a switching sheet Steps tab with the addition of an Events column. The steps list does not have a Version column as miscellaneous logs do not have versioning capabilities. See [Steps Tab](#) on page 8-20 for column descriptions.

The following fields and buttons are displayed at the top of the Miscellaneous Log tab.

- The **From** date picker, **Range** drop-down, and the **All Users** check box set the log's filter criteria. Note that the **From** date picker only includes dates, but not specific times.
- The **Fetch** button () is used to get records from the database.
- The **Previous** () and **Next** () buttons allow you to view the log entries for the previous or following period. For example, if the number of days drop-down is set to 1 week, then clicking the Previous button displays the previous week's log entries.
- The **Complete** button () completes the selected instructed steps. The status of the step changes to *Completed*.
- The **Abort** button () sets the status of an instructed step to *Aborted*. Use this if the step was never attempted.
- The **Fail** button () sets the status of an instructed step to *Failed*. Use this if the step was attempted but failed.
- The **Uninstruct** button () will remove the instruct condition from the asset and delete the instructed step that was recorded into the Miscellaneous Log.
- The **Focus** button () focuses the Viewer on the selected asset.
- The **Cut** button () allows you to cut one or more steps from the miscellaneous log. You can then paste the steps into another switching sheet.
- The **Print Preview** button () allows you to generate and view the Miscellaneous Log report based on any applied filters. The output will include the date range for the steps included in the log, the user, and finally the list of steps. You will be prompted to select a report format (PDF, HTML, RTF, or XML); click **Preview...** to generate the file, which will open in an application that is associated with that file type (for example, Adobe Reader for PDFs or your default web browser for HTML). You may save the generated file.

Note: The filters will be refreshed when the report is generated so they will always contain current data regardless of what steps are displayed at the time the button was clicked.

- The **Print** button () allows you to print the Miscellaneous Log report based on any applied filters (see **Note** for **Print Preview**, above). You will be prompted to select a report format (PDF, HTML, RTF, or XML) and your printer; click **Print**.
- The **Email** button () allows you to email the Miscellaneous Log report based on any applied filters (see **Note** for **Print Preview**, above). You will be prompted to select a report format (PDF, HTML, RTF, or XML); click **Email...** to generate the file, which will be attached to a new message launched from your default email application.
- The **Help** button () displays help for the Miscellaneous Log tab.

Filtering the Log

Use the fields at the top of the Miscellaneous Log tab to filter the list as follows:

1. Select a starting date from the **From** date picker.
2. From the drop-down, select the number of days from that starting date for which you want to see log entries.
3. Check or uncheck the **All Users** check box. (When **All Users** is checked, the log shows steps that were executed by all users; when unchecked, the log shows only steps that were executed by you.)
4. Use the fields at the top of the tab to filter the log.
5. Click the **Fetch** button to refresh the list based on your entries.

Editing the Miscellaneous Log Steps

The **Operation**, **Details**, and **Comments** step columns are the only columns in the Miscellaneous Log that can be edited. The edits are automatically submitted to the database when cell focus is lost. Cell focus occurs when you press **Enter** or when you tab out of the field. The cell edit will also be submitted to the database if you navigate to another tab within the Oracle Utilities Network Management System environment. Step field edits within the Miscellaneous Log cannot be undone. If you wish to cancel what you are doing in the Comments field, then press the **Esc** key. Note that editing the **Operation** step column can only occur for No-Op steps just as it is in switching sheet steps. Once edited, the background color for the step will turn yellow to indicate that the default Operation text has been altered.

Viewing Global Overlaps

The Global Overlaps list allows you to identify overlaps of date/time, control zone and affected assets within a specific time period for all active switching sheets.

To display the Global Overlaps list, choose **Switching Overlaps...** from the **Tools** menu.

The fields, buttons, and options on this tab are nearly identical to the Overlaps tab that is displayed for individual switching sheets. See [Using the Overlaps Tab](#) on page 8-55 for more information. The global overlaps Range options will only include options that will add to the specified From date. Switching sheet overlaps include Range options that are before and after the sheet's start and finish dates. The table column labels will be followed by a 1 or 2 depending on which switching sheet the value is for.

The Global Overlaps list will initially display overlaps for the next day and any overlaps that occur over time. Use the Overlap Type column in the list to determine overlaps that have been scheduled for the same asset and/or control zone. The Asset and Control Zone overlaps will be listed at the top of the list.

To open the overlapping switching sheets, double click the entry in the list or use the right-click context menu to select options for opening Sheet #1, Sheet #2, or both sheets.

Click the Help button (?) to display help for the Global Overlaps tab.

Web Safety

Web Safety provides *Stand Alone Safety Documents* for recording tagging operations outside of a switching plan. **Web Safety** is not a substitute for safety documents created in switching plans and, therefore, does not support the use of aggregate actions when recording tag points. **Web Safety** limits asset associations to those not involved in *Open* and *Close* operations.

Understanding the Stand Alone Safety Document Window

Stand Alone Safety Documents windows share many features and behaviors of switching sheet windows. Like switching sheets, Stand Alone Safety Documents cannot be moved outside of the confines of the NMS workspace. Stand Alone Switching Document windows open in the lower right quadrant of the workspace, but may be moved anywhere within the workspace or maximized to the full workspace dimensions.

Each open safety document has its own tabbed window, which is labeled with a combination of the safety document type and the number. Multiple safety documents and switching sheets are typically docked together and displayed as a tab group. Double-click any tab (or the empty area to the right of the tabs) to maximize the tab group; double-click again to restore the size.

Right-click a tab to access the context menu, which provides the following:

Note: For simplicity, the term *sheet* will be used to mean either a stand alone safety document or switching sheet.





- **Maximize:** maximizes the window.
- **Restore:** restores the maximized window to its original size and position.
- **New Tab Group:** displays the sheet separately.
- **Collapse Tab Groups:** regroups separate windows into tab groups.
- **Windows...:** opens a dialog box that lists all open sheets, which you can then:
 - Activate (that is, bring to front in a tab group) a single sheet.
 - Close selected sheets.
- **Close:** closes the sheet.
- **Close All:** closes all open sheets.
- **Close Others:** closes all open sheets except the sheet that was right-clicked.

Menu and Toolbar Features

File Menu

The table below describes the options available on the **File** menu.







| Menu Option | Description | Toolbar Icon |
|-------------|--|---|
| Save | Saves the Safety Document. |  |
| Copy As... | Opens the Safety Document Types dialog box that allows you to create a new safety document with the current document's data. See Copying a Safety Document on page 8-109 for more details. | -- |

| Menu Option | Description | Toolbar Icon |
|-------------------------|---|---|
| Associate... | Display the Switching Sheet Association dialog box. From the dialog box you can associate the safety document to a switching sheet. See Switching Sheet Associations on page 8-95 for more details. Once the safety document is associated, it is no longer a stand alone safety document and when viewed the document takes on the look of a switching sheet associated safety document. |  |
| Delete | Transition the document to the Deleted state and remove it from any of the safety document lists. This option is only available while the document is in the New state. | -- |
| Print Preview... | Opens the Report Format dialog box that allows you to choose the criteria for previewing a safety document report. |  |
| Print... | Opens the Report Format dialog box that allows you to choose the criteria for printing a safety document report. |  |
| Email... | Opens the Report Format dialog box that allows you to choose the criteria for emailing a safety document report. |  |
| Exit | Closes the active safety document. | -- |





Help Menu.

| Option | Description | Toolbar Icon |
|-------------------------|---|--------------|
| Web Safety Help | Opens online help content for safety documents. | -- |
| About Web Safety | Opens a window with environment and software information. | -- |

Toolbar Buttons

- The  **Record** /  **Stop** buttons allow you to toggle Control Tool related recording on or off, respectively.
- The **Paste** button () allows you to add a step cut from the Miscellaneous Log or copied from another Safety document. See [Adding Assets to a Non-Execute Safety Document](#) on page 8-85 for more information.
- The **Place Condition** button () is used to apply conditions when the condition actions were recorded in study mode through the Control Tool.
- The **Issue** button () issues the selected safety document. A record of the transition is added to the Audit Log. Selecting this button will cause the **Unissue** and **Release** buttons to be enabled.
- The **Unissue** button () is used to place an Issued safety document or a Released safety document into an Unissued (edit) state where the asset lists can be altered. While in the Unissued state, you can add assets to the lists and mark assets already in the list for removal.

Only when the safety document transitions back to the Issued state will the changes be applied. Selecting this button will cause the **Issue** button to be enabled.

- The **Release** button () releases the selected safety document. This button is only enabled if the safety document has been issued. Selecting this button will cause the **Issue** and **Complete** button to be enabled.
- The **Complete** button () completes the selected safety document.
- The **Abort** button () allows you to set the status of the safety document to Aborted. The system prompts you to confirm the action before aborting. This button is only available in real-time mode and only for safety documents that are in the New state.
- The **Confirm Model Changes** button () becomes available when model changes have occurred that impact one or more assets in the safety document.

The Web Switching service checks all the active safety documents after a model edit has occurred. If a safety document has an asset that matches an asset that was directly impacted by a model change, that asset will be marked as needing verification. When the safety document is displayed, these assets will be highlighted in yellow. You can either verify each asset in the document or verify the entire document.

Note: While the safety document has verifications pending, safety state transitions cannot be performed within the document.





Individual Verification

To check off each asset individually, right-click the highlighted asset and select **Model Verify**.

Whole Safety Document Verification

To verify all of the assets in a sheet, click the verify (check mark) button () to confirm all model changes. All highlighted assets will be marked as verified.









Once the assets have been verified, safety state transitions can continue for the document.









- The **Reset Study Session** () allows you reset your study session to a copy of either Real Time or Nominal conditions.
- The **Real Time** button () switches the document to real time mode.
- The **Study Session** button () switches the document to study mode.
- The **Step Actions** button () toggles the actions view at the bottom of the safety document. The actions are identical to switching steps found in switching sheets. The actions list includes the tag and safety state transition actions associated to the document.

Safety Document Fields

The Stand Alone Safety Document dialog box displays the following fields:

- **Tag Points** display the assets that the safety document is associated with.
 - **Table Columns**
 - **Edit State:** an iconic representation of the edited state of the asset in the Unissued state. The edits will be applied when the document is issued. When working in Study mode, the edit state indicators will remain visible until the document is issued in real time.
 - : The asset has been marked for removal.

- : The asset has been added to the asset list and will be used as a boundary point the next time the document is issued.
 - **Asset**: the asset used to define the area or point of coverage of the safety document.
- **Toolbar Buttons**
 - The  /  buttons allow you to toggle recording of assets on or off, respectively. The Tag Points list allows you to record assets by selecting them in the Viewer. To enable this feature, turn on recording and select assets in the Viewer.
 - The **Add Asset...** button () allows you to manually add an asset to the list.
 - The **Undo Asset Edit** button () allows you to undo an addition or removal of an asset from the list. This option is only available when making asset modifications in the Unissued state.
 - The **Remove Asset** button () allows you to remove a selected asset from the Tag Points asset list.
 - The **Object Focus** button () focuses the Viewer 1 window on the selected asset.
-  **Other Assets** is a text field that allows you to enter a list of non-modeled assets.

Note: An entry is required in at least one of these fields: Tag Points, or the Other Assets.
- **Pressure Zones** field allows you to enter pressure zone values. The following button is displayed to the right of the Pressure Zones field:
 - The **Update** button () is used to populate the **Pressure Zones** field with the list of pressure zones associated with assets listed on the safety document.
- **Asset** displays the asset being worked on (not necessarily the asset being switched). This asset is also used to identify what control zone the document is found in. If you do not have authority over the zone the document is associated to the document will not show up in the Open Safety Document list. The following buttons are displayed to the right of the **Asset** field:
 - The **Assets Lookup** button () is used to search for and select an asset.
 - The **Link Asset** button () to link an asset selected from the Viewer to the switching sheet. Select the asset in the Viewer, and then click the **Link Asset** button (). The **Asset** field is populated with the selected asset's name.
 - The **Unlink Asset** button () clear a linked asset from the **Asset** field.
 - The **Object Focus** button () focuses the Viewer 1 window on the selected asset.
- **Assigned Crews** displays a table list of the Crew IDs of the crews that the safety document has been issued to, as well as each crew's mobile number, pager number, and crew type. A crew is required in this list before the document can be issued.
 - To select a crew to assign to this safety document, click the **Select Crew...** () button to open the Select Safety Crew dialog box. See [Assigning Crews to a Safety Document](#) on page 8-83.
 - To change a crews position, click the **Crew Issued/Clear** () button and select either **Issued** or **Clear** from the context menu.

- To delete crews from this list, click the crews and then click the **Clear Crews** button (). When the document is in the Issued state, all but the last crew can be cleared from the list. At least one crew must remain assigned while the document is in the Issued state.
- **Description** is a text field that allows you to enter notes for the safety document.
- **Audit Log** contains the following information:
 - **Table Fields:**
 - **Date:** the date and time of each entry.
 - **Description:** a description of the state change or asset operation.
 - **Asset:** the asset associated with the step.
 - **User:** the name of the user who recorded the action.
 - **Crews:** the crew identifiers pertaining to the audit log entry.
 - The **Comment** section of the Audit Log panel allows you to add a comment to the log.
- The **Edit Log** tracks the changes made to the entry fields of the document. It contains the following information:
 - **Date:** the date and time of each entry.
 - **User:** the name of the user who recorded the action.
 - **State:** the state of the safety document when the entry was added.
 - **Field:** The name of the field that was updated.
 - **Previous Value:** The previous value of the field before the update.
- The **Steps** section contains all of the step actions associated with the safety document.

Creating New Stand Alone Safety Documents

From the Web Workspace

To create a new Stand Alone Safety Document from the Web Workspace, from the **File** menu, select **New**, and then select **Safety Document...** The *New Safety Document* window will open.

Note: You may click the toolbar button () rather than the File menu.

From the New Safety Document window, you may create a safety document based on a blank template or from a pre-existing safety document.

Create a New Blank Safety Document

To create a blank safety document from the New Safety Document dialog box, do the following:

1. Select a safety document type from the Safety Document Type list.
2. Click **Create**; the new safety document will open.

Note: You may create a blank safety document from the Control Tool's **Safety Documents...** button. See [Create a New Safety Document from the Control Tool](#) on page 8-106.

Create a New Safety Document with Existing Safety Document Data

You may want to create a new safety document with data from an existing safety document; for example, creating multiple safety documents types to be used in a multi-step switching operation.

1. Select a safety document type from the Safety Document Type table.
2. From the Pre-Created Safety Documents table, select an existing safety document that has the data you need for the new document.
3. Click **Create a Copy**; the new safety document will open and be populated with asset data from the pre-created safety document. The **Create a Copy** button will only be visible after you have selected a safety document type and a safety document within the pre-created safety document list.

Create a New Safety Document from the Control Tool

To create a new Stand Alone Safety Document from the Control Tool, do the following:

1. Make sure the Viewer is in Real Time mode. The safety document creation options are only available in Real-Time mode.
2. Open the Control Tool for the asset to be associated with a new safety document.
3. Click the **Safety Documents...** button and then select the option to create the new safety document type:
 - Create HOLD Document
 - Create Clearance Document
 - Create Information Document
 - Create Warning Document
 - Create Delegated Control Document

A new safety document will be created with the Tag Points list automatically populated with the originating asset's id and full set of phases. The safety document's **Asset** field will be automatically populated with the source asset used to bring up the Control Tool.

Using Stand Alone Safety Documents

Record Tag Operations

1. Create a new stand-alone safety document.

Note: The new document will open in Real-Time mode with Control Tool action and Viewer asset selection recording on.

2. Turn Tag Points Viewer asset selection recording off.
3. Double-click an asset in the Viewer to launch its Control Tool.
4. Click **Tag...** and choose a place tag operation associated to that document type. (For example, select **Place HOLD Tag** for a HOLD document.)

The asset is displayed in the Tag Points list.

5. Click the **Step Actions** toggle button () and note that the operations are recorded there as well. This is the source list and this list feeds the Asset list found on the document's main form.

Record Ground Operations

1. Create a stand-alone safety document.
2. Turn Tag Points Viewer asset selection recording off.
3. In real-time mode, with Control Tool action recording on, select an asset in the Viewer and Place Tag operation associated to that document type. (For example, select a **Place HOLD** for a HOLD document.) The asset is displayed in the Tag Points list.
4. Click the **Step Actions** toggle button () and note that the operations are recorded there as well. This is the source list and this list feeds the Asset list found on the document's main form.

Remove an Asset from a Safety Document

1. Create a stand-alone safety document.
2. Record tagging operations in real-time.
3. Select one of the assets in the Tag Points list and click  to remove the asset.

Note: The *Remove* option is only available when the document is in the New or Unissued state.
4. Open the Miscellaneous Log and note that it now lists the Place Tag operation step that was removed from the safety document.

The associated action step will only show up in the Miscellaneous Log, after being removed, if the action was recorded from the Real-Time Control Tool. If the asset was recorded as a selection from the Viewer, then the asset will simply be removed and no action steps will be moved to the Miscellaneous Log.

Issuing, Releasing, and Completing a Safety Document

1. Create a stand-alone safety document.
2. Record some tagging operations in Real Time.
3. From the document, assign a crew to the document.
4. Issue the document. The conditions in the Viewer will change to indicate that they are under the control of a safety document by displaying a padlock symbol on top of the condition symbol. The status of the document is updated in the status bar, which is found at the bottom of the document. An audit log entry is created for the state transition.
5. Release the document. The conditions in the Viewer will change to indicate that they are no longer under the control of the safety document. The status of the document is updated in the status bar, which is found at the bottom of the document. An audit log entry is created for the state transition.
6. From the Viewer, remove the tagging operations while recording is on in the safety document. The actions are recorded in the Audit Log of the safety document.
7. Complete the document. The safety document status is updated and unlocked and placed into View Only mode. All the toolbar options are desensitized except **Copy As...**, **Print**, **Email**, **Help**, **Exit**, and **Focus**.

Loading a Safety Document

1. From the Open Safety Document list, load a safety document not associated to a switching sheet.

Deleting a Safety Document

1. Create a stand-alone safety document.
2. From the document's **File** menu, select **Delete**. The document will be marked as Deleted and will no longer be listed in the Safety Document List. Safety documents can only be deleted when no Real-Time tags are associated and listed in the Tag Points list.

Copying a Safety Document



First Option

1. From the New Safety Document dialog box, refresh the pre-created safety document list.
2. Select a pre-created safety document and a target document type.
3. Click **Create a Copy**. A new safety document is created. This new document will have the same list of asset as the original document. The Audit Log of the new document will have one entry describing when the document was created.



Second Option

1. From the stand alone safety document's **File** menu, select **Copy As...**
2. Select a document type from the list.
3. Click **Create a Copy**. A new safety document is created. This new document will have the same list of assets as the original document. The Audit Log of the new document will have one entry describing when the document was created.

Create a Safety Document in Study Mode

1. From the New Safety Document dialog box, select a safety document type and click **Create**. The new document is created and by default goes into Real-Time mode.
2. Click .
3. Verify that Control Tool action recording is on and Viewer asset selection recording is off.
4. Open the Viewer in Study Mode.
5. Add appropriate tags to assets. As the actions are recorded by the safety document, the assets show up in the Tag Points lists.
6. Once all of the tags have been applied, issue the safety document, and release it to test in Study mode.
7. Reset the study session from the safety document.
8. Select the Tag Points and place the tag points in the model. This can be done by selecting the asset and clicking the **Place Condition** button ().
9. Click the **Focus** button (). The Viewer will display the appropriate conditions on the assets.
10. Issue the safety document. The conditions displayed in the Viewer will change to indicate that they are under the control of a safety document. This is indicated by displaying a padlock symbol on top of the condition symbol in the Viewer. The status of the document is updated in the status bar, which is found at the bottom of the document.

Associate an Existing Place Tag Action to a Safety Document

1. With no switching sheet or safety document in record mode, find an asset that can have a HOLD condition.
2. Double-click the asset to launch the Control Tool.
3. Select **Place Hold Tag** from the **Tag...** menu's **Hold Tags** sub-menu. A Hold Tag step is recorded into the Miscellaneous Log.
4. Create a HOLD safety document.
5. Load the Miscellaneous Log and refresh the list so that the Place Hold Tag step is displayed.
6. Select the Place Hold Tag step. Click the **Cut Step** button () to cut the step.
7. Go back to the newly created Hold Safety document and click the Paste button (). The asset associated to the Place Hold Tag step is displayed in the safety document's Tag Points list. The safety document can now be issued.

Note: If you attempt to add a step action association that is not valid for the safety document type, an error message will be displayed. For example, you would get an error if you attempted to add a step action for a Place Hold Tag into a Clearance document.

Chapter 9

Model Management

This chapter describes how to manage changes to your system data model.

Note: For complete information about configuring, validating, and testing the data model, see *Building the System Data Model* in the *Oracle Utilities Network Management System Configuration Guide*.

This chapter includes the following topics:

- [Overview](#)
- [Logging In](#)
- [Using the Model Management Window](#)
- [Model Management Actions](#)

Overview

Model Management is a tool for managing changes to your system model. The process of extracting updates from the GIS and updating the model is unique for each company. Typically, model updates are handled by a set of scripts that run automatically on a regular schedule. If there are problems in the update process, the model administrator can use the Model Management tool to identify and resolve the problems and then re-apply the model updates.

The following describes the model update process and introduces several terms that are used in this chapter:

- **GIS Data Extraction** is the customer-specific process by which data is extracted from the GIS to Oracle's vendor-neutral model preprocessor (*.mp) file format.
- *.mp files must be **preprocessed** before they can be built into the model. Preprocessing converts the *.mp files into the *.mb file format required by the Model Builder.
- A set of transactions (*.mb files), collectively referred to as a **patch**, are submitted to the Model Builder for processing. Patches are applied to or built into the core operations model.
- The **Model Builder (MBSservice)** processes the *.mb files, saves the information to the Oracle Utilities Network Management System Operations Model RDBMS, and writes out a set of **maps**, which are used by the Viewer to display portions of the system model.

- If any problems arise during preprocessing or model building, you can use the Model Management tool to perform the following tasks:
 - Identify maps that need to be built (referred to as pending maps)
 - View a list of recent patches and their statuses
 - Display all patches that were applied to a particular map
 - Rebuild individual maps or run a full model build
 - Run the post process script
 - View the Preprocessor Log, the Patch Build Log, and the Patch Build Report
 - Enable or disable model build reporting
 - Delete an import file to be rebuilt.

Logging In

To log in to Model Management, complete these steps:

1. Depending on how your system was installed, do one of the following:
 - Click the **Model Management** icon found under the appropriate program group in your Windows Start Menu.
 - Double-click the **Model Management** icon on your desktop.
 - Open a web browser and type the Model Management URL in the browser's address field.

The Model Management Login window displays.

2. Enter your user name in the **User Name** field.
3. Enter your password in the **Password** field.
4. Click the **Validate** button. The bottom portion of the Login window sensitizes.
5. Select the appropriate **User Type** from the drop-down menu.
6. Click the **Login** button. Upon successful login, the Model Management window opens.

Using the Model Management Window

The Model Management window displays the following information:

- Menu and Toolbar Options
- Pending Map Section
- Patches Section
- Menu and Toolbar Options
- Status Bar

Model Management actions include:

- Displaying Map History
- Displaying the Preprocessor Log
- Building Maps
- Rebuilding a Patch
- Displaying the Patch Build Log
- Displaying the Patch Build Report
- Enabling and Disabling Model Building



Menu and Toolbar Options



The Model Management menu and toolbar provide access to commonly used functions. Most of the functions in the Actions menu are also available on the toolbar.

File Menu

| Menu Option | Description | Toolbar Icon |
|-------------|--|---|
| Print... | Opens the Print Preview dialog box, which allows you to print the contents of the Model Management window. |  |

Actions Menu

| Menu Option | Description | Toolbar Icon |
|--------------------|---|---|
| Refresh | Refreshes both the Pending Maps and Patches lists. |  |
| Halt Model Build | Stops all model build activity. See Enabling and Disabling Model Building on page 9-9 for more information. |  |
| Enable Model Build | Enables model building activity that was previously halted. |  |

| Menu Option | Description | Toolbar Icon |
|-------------------------------------|---|---|
| Run Full Model Build | Rebuilds the entire system model, not just individual maps. | -- |
| Run Post Process | Runs the post-processing script. Post processing takes place after maps are built. The default post-processing script performs a recompute and recache of the control zones in DDService, but this can be modified to perform various tasks, such as generating control zones or computing EE details from the model. |  |
| Enable Model Build Reporting | Enables or disables model build reporting. The Model Build Report lists all objects that were modified when a particular patch was applied. If enabled, a checkmark appears next to the menu option. | -- |
| Build Map | Prompts you to enter one or more map names and then rebuilds the specified maps. If you are entering multiple map names, separate names with spaces, as shown below: Landbase_49132336 Primary_49132336 |  |

User Menu

The User Menu provides options to set preferences and log out of Model Management.

Preferences Menu

| Menu Option | Description |
|-------------------------------|---|
| Smaller Font | Decreases the font size in text and icons. Repeat to further decrease the font size. |
| Bigger Font | Increases the font size in text and icons. Repeat to further increase the font size. |
| Reset Font | The application will reset the text and icons to use their default font size. |
| Change Color Scheme... | Opens the Change Color Scheme dialog box, which allows you to select from different user interface coloring schemes. The options are a Light scheme, a Dark scheme, and the default High Definition scheme. Unlike other user preferences, these apply to all environments for the user on the machine. |

Help Menu

| Menu Option | Description |
|------------------------|--|
| Model Management Help | Launches the online help system and loads the Model Management content. |
| Email Log Files... | Gathers the environment's log files and attaches them to a new email message using your default email client. The log files can then be sent to your support team or contact for further analysis. |
| Set Debug... | Launches the Set Debug dialog box allowing you to set debug on or off within your current environment. This is used for debugging and analysis purposes. See Setting Debug on page 10-33 for more information. |
| About Model Management | Opens a window with environment and software information. |

Pending Map Section

The **Pending Maps** section lists all maps that need to be built. This section displays the following columns:

- **Order** displays the order that the maps will be built. The value is returned by the `<project>_maps_to_build.ces` script.
- **Map Name** displays the name of the model map.
- The **Pending Actions** column displays one of the following:
 - **To be preprocessed:** The `*.mp` files have not been preprocessed into `*.mb` files, which is necessary before they can be built into the model.
 - **To be committed:** The `*.mp` were preprocessed into `*.mb` files, but have not been committed (built into the model).
- The **Last Build Status** displays the status of the last attempt to build the map. Statuses are:
 - **New:** No attempt has yet been made to complete the pending action.
 - **Failed submit:** The patch was submitted to the Model Builder but the map could not be built. See [Rebuilding a Patch](#) on page 9-9 for details on correcting this problem.
 - **Failed commit:** The patch was submitted to the Model Builder but the map could not be committed due to a dynamic data error. See [Rebuilding a Patch](#) on page 9-9 for details on correcting this problem.
 - **In progress:** The pending action is currently in progress.

Pending Map Actions

With a map selected in the Pending Maps section, right-click to view the context menu. The options, listed below, are dependent on the state of the file selected.

- **Map History...** - see [Displaying Map History](#) on page 9-8 for information.
- **Preprocessor Log...** - see [Displaying the Preprocessor Log](#) on page 9-8 for information.

- **Delete...** - allows you to delete processed .mb or .mbd files and to be preprocessed *.mp files that you do not want to build or commit to the model.
- **Build Maps** - see [Building Maps](#) on page 9-8 for information.

Patches Section



The **Patches** section lists all patches for the last 24 hours. To see patches for another time period, change the beginning and ending dates above the list as desired, then click the **Refresh** button.

The Patches section displays the following columns:

- The **Patch** column displays the patch number. The system assigns a number to a patch when it is submitted.
- **Map Names** displays the name of the model maps.
- **Creation Date** displays the date the patch was created.
- **Commit Date** displays the date the patch was submitted to the Model Builder.
- **Build Status** displays the status of the patch submission. Statuses are:
 - **Successful** - The patch was successfully applied and the model was updated.
 - **Failed Submit** - The patch was submitted to the Model Builder, but the map could not be built. See [Rebuilding a Patch](#) on page 9-9 for details on correcting this problem.
 - **Failed commit** - The patch was submitted to the Model Builder, but the map could not be committed due to a dynamic data error. See [Rebuilding a Patch](#) on page 9-9 for details on correcting this problem.
 - **In Progress** - The patch is currently being processed by the Model Builder. The map files are either being parsed, being applied, or being committed to the database.

Status Bar

The status bar displays the following information:

- **Maps to Build** - The total number of maps that need to be built. These maps are displayed in the Pending Maps section of the screen.
- **Failed Map** - The total number of maps that could not be built (were submitted and failed).
- **Model Build Status:**
 - **Enabled** - Model building is currently enabled. To disable, click the **Halt Model Build** button ().
 - **Halted** - Model building has been halted. To re-enable, click the **Enable Model Build** button ().
 - **In Progress** - A model build is currently in progress.

Model Management Actions

You can perform the following actions from the Model Management window:

- [Displaying Map History](#)
- [Displaying the Preprocessor Log](#)
- [Building Maps](#)
- [Rebuilding a Patch](#)
- [Displaying the Patch Build Log](#)
- [Displaying the Patch Build Report](#)
- [Enabling and Disabling Model Building](#)

Displaying Map History

To view a list of all patches that affect a particular map, follow these steps:

1. Select a map from the Pending Maps list on the Model Management window.
2. Right-click and select **Map History** from the context menu. The Map History dialog box opens. The columns on this dialog box match the columns in the Patches list on the Model Management window.
3. Filter the list as desired by typing the target text in the filter boxes at the top of each column.
4. To take action on an item in the list, right-click the item and then select one of the following options from the context menu:
 - **Rebuild Patch**
 - **Patch Build Log**
 - **Patch Build Report**

Displaying the Preprocessor Log

The preprocessor log displays information and warnings generated during preprocessing. Follow these steps to display the preprocessor log file associated with a map:

1. Select a map from the Pending Maps list on the Model Management window.
2. Right-click and select **Preprocessor Log** from the context menu. The preprocessor log opens.

Building Maps

To build one or more pending maps, follow these steps:

1. Select the map you want to build from the Pending Maps list on the Model Management window.
2. Right-click and select **Build Maps** from the context menu. The system builds the selected map and displays the results in the Result dialog box.
3. Review the results and then click **Close**.
4. Click the **Refresh** button on the toolbar. If the build was successful, the map is removed from the Pending Maps list and a new row is displayed in the Patches list for this map.

Rebuilding a Patch

To rebuild a patch, follow these steps:

1. Select a patch from the Patches list on the Model Management window.
2. Right-click and select **Rebuild Patch** from the context menu. The results of the rebuild process are displayed in the Results dialog box.
3. Review the results, and then click **Close**.
4. Click the **Refresh** button on the toolbar. A new row is displayed in the Patches list for this patch.

Displaying the Patch Build Log

The Patch Build Log displays information and warnings generated during the build process. To display the log for a specific a patch build, follow these steps:

1. Select a patch from the Patches list on the Model Management window.
2. Right-click and select **Patch Build Log...** from the context menu. The log entries are displayed in the Patch Build Log dialog box.
3. Click **Close** to exit.

Displaying the Patch Build Report

The Patch Build Report contains a list of all objects that were modified when a particular patch was built.

Note: The Patch Build Report is only generated if Model Build Reporting is enabled at the time the patch was built. Use the **Enable Model Build Reporting** option on the Actions menu to enable or disable Model Build Reporting.

To display the build report associated with a patch, follow these steps:

1. Select a patch from the Patches list on the Model Management window.
2. Right-click and select **Patch Build Report...** from the context menu. The Patch Build Report dialog box is displayed.
3. Review the report, and then click **Close**.

Enabling and Disabling Model Building

You can temporarily suspend all model building activity if needed. This is useful if, for example, a major storm causes widespread outages. By halting model builds, you can lighten the load on the system while it manages the outages. When storm damage has been repaired, you can resume model building.

To stop model building, select **Halt Model Build** from the **Actions** menu or click the **Halt Model Build** button (.

To resume model building, select **Enable Model Build** from the **Actions** menu or click the **Enable Model Build** button (.

Chapter 10

Configuration Assistant

Oracle Utilities Network Management System Configuration Assistant provides a graphical view of the Oracle Utilities Network Management System configuration options and allows the user to add, edit, and store configuration changes.

This chapter includes the following topics:

- [Getting Started with the Configuration Assistant](#)
- [Using Common Configuration Assistant Features](#)
- [Using the User Administration Tab](#)
- [Using the Mobile User Administration Tab](#)
- [Using the Event Management Rules Tab](#)
- [Using the Event Details Options Tab](#)
- [Using the Work Agenda Predefined Filters Tab](#)
- [OptimizationOptimizationUsing the State Transitions Tab](#)
- [Using the Default Restoration Times Tab](#)
- [Using the Customer Administration Tab](#)

Getting Started with the Configuration Assistant

This section includes the following topics:

- [Accessing Configuration Assistant](#)
- [Logging In](#)
- [Using Common Configuration Assistant Features](#)

Accessing Configuration Assistant

Depending on your system installation, the Oracle Utilities Network Management System Configuration Assistant is typically accessed by an URL (provided by your Oracle Utilities Network Management System implementation team) or through shortcuts installed on your desktop or in your application menu (such as the Microsoft Windows **Start** menu or Linux **Applications** menu). Use the installed shortcuts, if applicable, or open the URL in a web browser to launch the application. The Oracle Utilities Network Management System will begin downloading *Java* components of the Configuration Assistant to your computer. The Configuration Assistant Login window will open.

Logging In

1. To log in, enter the following information in the Login window:

User ID: enter the user name provided to you by your system administrator.

Password: enter the password provided to you by your system administrator.

Validate: click the **Validate** button to verify your login credentials.

Note: If your user name and password are not entered correctly, the system will display a *Login Error* message.

Once you have entered your user name and password, the **Validate** button will become activated.

2. Click **Validate** (or press **Enter** while in the password field) to validate your credentials.
3. Click the **Login** button to complete the login process and open the Configuration Assistant.
Note: If two-factor authentication is enabled, the Two Factor Authentication dialog box will open. To request an authentication code, select a delivery method from the drop-down list, and then click **Request Code**. Once you receive the code, enter it in the **Code** field, and click **OK**.
4. The **Quit** button closes the Login window and exits the Configuration Assistant.



Using Common Configuration Assistant Features

This section describes the common options available from the Configuration Assistant.

Configuration Assistant Menus and Toolbar

This section describes the menu and toolbar options available with the Configuration Assistant.

File Menu.

| Menu Option | Description | Toolbar Icon |
|---------------------------------|---|---|
| Export Configuration ... | Generates SQL statements for the current state of the configuration associated with every tab on the application. Once generated, the SQL statements are displayed in a window with options to save or print the information. |  |
| Print Preview | Opens the Print Preview dialog box, which allows you to print out the User Administration tab, Event Management Rules tab, Event Details Options tab, and Work Agenda Predefined Filter tab information from the current Configuration Assistant window. See Printing on page 1-20 for details on using Print Preview. |  |

Actions Menu

The **Actions** menu can vary by tab. See the tab descriptions for **Actions** menu option differences.

| Menu Option | Description |
|-----------------------------------|--|
| Create Client Installer... | Launches the client installer application. See the <i>Oracle Utilities Network Management System Installation Guide</i> for details on creating the installer and installing local copies of the Oracle Utilities Network Management System client applications. This menu item is available on all tabs. |

User Menu

The User Menu provides options to set preferences and log out of the Configuration Assistant.

Preferences Menu

The **Preferences** menu allows you to control certain common features of the Configuration Assistant.

| Menu Option | Description |
|-------------------------------|---|
| Smaller Font | Decreases the font size in text and icons. Repeat to further decrease the font size. |
| Bigger Font | Increases the font size in text and icons. Repeat to further increase the font size. |
| Reset Font | The application will reset the text and icons to use their default font size. |
| Save Preferences | Saves the current settings as the user's preference. See Saving Workspace Preferences on page 1-12 for details. |
| Restore Preferences | Restores the environment preferences to the default settings. See Restoring Default Preferences on page 1-12 for information. |
| Change Color Scheme... | Opens the Change Color Scheme dialog box, which allows you to select from different user interface coloring schemes. The options are a Light scheme, a Dark scheme, and the default High Definition scheme. Unlike other user preferences, these apply to all environments for the user on the machine. |

Help Menu

| Menu Option | Description |
|--------------------------------------|--|
| Configuration Assistant Help | Opens the Configuration Assistant online help file. |
| Email Log Files... | Gathers the environment's log files and attaches them to a new email message using your default email client. The log files can then be sent to your support team or contact for further analysis. |
| Set Debug... | Launches the Set Debug dialog box allowing you to set debug on or off within all client environments. As a Configuration Assistant user type, the dialog box also allows you to set debug within the services (JMService, MTService, etc). This is used for debugging and analysis purposes. See Setting Debug on page 10-33 for more information. |
| About Configuration Assistant | Opens a dialog box that displays information regarding what version of the application is presently running, as well as version and other information about the Oracle Utilities Network Management System Web Gateway that the application is using. |

Using the User Administration Tab

The Configuration Assistant User Administration tab allows an administrator to add and remove users, modify user types associated with users, and view user login activity. The User Administration tab contains the following panels:

- [Understanding the Current Users Panel](#)
- [Understanding the User Type Memberships Panel](#)
- [Understanding the User Log Panel](#)

From this tab, you can perform the following tasks:







- [Adding a User](#)
- [Editing a User](#)
- [Removing a User](#)
- [Saving an Exported User Configuration](#)
- [Changing User Type Memberships](#)
- [Reorder Current User Types](#)
- [Resetting a User Login](#)

Understanding the Current Users Panel

The Current Users panel lists all of the users currently configured to use one or more modules of Oracle Utilities Network Management System, and allows you to add, edit, and remove users.

Each time you select a row in the Current Users table, the User Type Memberships and User Log panels populate with information that pertains to the selected user.

The Current Users Panel displays the following fields and buttons:

- The **Username** column contains the Oracle Utilities Network Management System login name of the user.
- The **Full Name** column contains the full name of the user.
- The **Last Logon** column contains the date and time the user last logged on.
- The **Last Logoff** column contains the date and time the user was last logged off.
- The  **Add** button allows you to create a new user.
- The  **Remove** button allows you to remove an existing user.
- The  **Edit** button allows you to modify the Username and Full Name of the user.
- The  **Refresh** button refreshes the table with the current contents of the database.
- The  **Service Recache** button causes the Oracle Utilities Network Management System services to recache with the changes you made in the Configuration Assistant window. If you do not do this, your changes will not be recognized until Oracle Utilities Network Management System services are restarted.
- The  **Export Configuration...** button generates SQL statements for the current state of the configuration associated with the **User Administration** tab. These SQL statements may then be saved to a file and/or printed.

Adding a User

To add a new user to Oracle Utilities Network Management System, complete these steps:

1. Click  **Add** in the Current Users panel. The Add / Edit User Information dialog box appears.
2. Enter the user information in the data fields:
 - **Username:** the new user's system login name.
 - **Full Name:** the user's full name.
 - **Default Zone Set:** optionally, add the name of the control zone set that the user will be automatically subscribed to when they log in to the system.
 - **Excluded Zone Set:** optionally, enter a zone set that the user cannot subscribe to.

Note: Once you select a zone in either the Default Zone or the Excluded Zone, that zone will be removed as a choice from the other.
3. Select the user's account setting:
 - **Active User:** designates an active user account; required to login to NMS.
 - **Priority User:** used for callback processing, which sends priority customer callback notifications to users with the Priority User account setting selected.
 - **External User:** designates an external system user agent that connects to NMS via an interface, such as Web Callbacks or IVR.

Note: Temporarily Inactivating a User



When a user will be inactive for a period of time, you may wish to set their user status to inactive by deselecting the Active User option. This will keep them from logging into the system, but allows for simple reinstatement when they become available.

4. Click  **Save**. The new user is added to the Current Users table.

Note: If the entered **Username** already exists, an error will appear and you will have to modify the username.

Editing a User

To edit the name information for an Oracle Utilities Network Management System user, complete these steps:

1. Select the user you wish to edit in the Current Users table.
2. Click  **Edit**. The Add / Edit User Information dialog box appears.
3. Modify any of the enabled fields, as desired.
4. Click  **Save**. The user information is updated in the Current Users table.

Note: If the modified Username already exists, an error will appear and you will have to modify the username.



Removing a User

To remove a user from Oracle Utilities Network Management System, complete these steps:

1. Select the user you wish to remove in the Current Users table.
2. Click  **Remove**. A confirmation dialog box appears.
3. Click **Yes** to remove the user or **No** to cancel the removal.

Saving Exported User Configuration

To generate and save SQL statements for the current state of the configuration associated with the User Administration tab, complete the following steps:

1. Click  **Export Configuration...** beneath the Current Users table. A dialog box appears indicating that the configuration is being generated.
2. Once the generation is finished, the Generated Configuration dialog box appears.
 - To save the generated SQL statements to a file, click  **Save**. The Save Configuration File dialog box appears. Type a name for the file into the File name field. The Save Configuration File dialog box disappears.
 - To print the generated SQL statements, click  **Print**. The Print Preview dialog box appears.
 - Click **Cancel** to close the Generated Configuration dialog box.

Understanding the User Type Memberships Panel

The User Type Memberships Panel allows you to assign a selected user to Oracle Utilities Network Management System applications and set their permissions by user type (see also [User Types](#) on page 1-2) for each.

The **User Type Membership Panel** displays the following fields and buttons:

- The **Products** column lists the Oracle Utilities Network Management System component applications.
- The **Remaining User Types** column lists the available user types for the selected product that the selected user does not have access to.

Product-User Type Matrix



| User Type | Configuration Assistant | Model Management | Service Alert | Storm Management | Web Call Entry | Web Callbacks | Web Workspace |
|--------------------------------|-------------------------|------------------|---------------|------------------|----------------|---------------|---------------|
| Administration | X | | X | | | | X |
| Crew Operations | | | | | | | X |
| Full Operations | | | | X | | X | X |
| Full Operations Plus Switching | | | | | | | X |
| Model Validation | | X | | | | | |
| Storm Administration | | | | X | | | |
| Switching Request | | | | | | | X |
| Trouble Maintenance | | | | | | | X |
| View Only | | | | X | | | X |
| Web Call Entry | | | | | X | | |

Note: To see what tools each user type has access to (depending on product licensing), see [Appendix D- Tool to User Type Matrix](#).

- The **Current User Types** column lists the user types for the selected product that the selected user has access to.
- The **+ Add Selected User Types** button allows you to grant access to a selected user type from the Remaining User Types column to the selected user.
- The **Remove Selected User Types** button allows you to remove access to a selected user type from the Current User Types column from the selected user.

Changing User Type Memberships





To modify the user type memberships for a user, complete the following steps:

1. Select the user whose memberships you wish to modify in the Current Users table. The User Type Memberships table populates with the current user type information.
2. Select the desired product from the Products column. The Remaining User Types and Current User Types columns populate with the user type information for that product for the selected user.
 - To add a user type for a selected product, select user types from the **Remaining User Types** column.
 - Click  **Add Selected User Types**. The selected user type will move to the Current User Types column
 - To remove a user type for a selected product:
 - Select the user type from the Current User Types column. Click  **Remove Selected User Types**. The selected user type will move to the Remaining User Types column.

Note: See the *Oracle Utilities Network Management System Configuration Guide* for details on adding and configuring user types.

Reorder Current User Types

To change the order of the configured user types on the login window, complete the following steps:

1. Select the user whose memberships you wish to modify in the Current Users table. The User Type Memberships table populates with the current user type information for the selected user.
2. Select a user type in the Current User Types column that you wish to move in the list. The arrows to the right of the column are now sensitized.
3. Click the appropriate arrow to change the user type order:
 - Click  to move the selected user type up to the top of the list.
 - Click  to move the selected user type up one position in the list.
 - Click  to move the selected user type down one position in the list.
 - Click  to move the selected user type down to the bottom of the list.

Understanding the User Log Panel

The User Log panel displays the login history for the selected user. From this panel you may also fix log entries for a user that is unable to login because the system thinks the user is already logged in from elsewhere (for example, a system error of some sort prevented the database from being updated with the correct information).

The User Log panel displays the following fields and buttons:

- The **Host** column displays the name of the host machine that the user was logged in from.
- The **Display** column displays the name of the display machine that was being used.
- The **Product** column displays the name of the product the user was logged in to.
- The **User Type** column displays the name of the user type the user was logged in as.
- The **Login Date** displays the date and time of the user login.
- The **Login Status** displays the status of the user login (for example, Successful).
- The **Logout Date** displays the date and time of the user logout.
- The **Logout Status** displays the status of the user logout (for example, Successful).
- The **Export Table...** button opens a dialog box to allow you to save the user log table view data to a comma separated value (csv) file.
- The **Reset Login** button allows you to force a logout entry into the database for a user that is still logged in per the User Log information. This is useful in cases where a user's client may have crashed for some reason and the user's loss of client is not recorded in the database as a logout. The system also unsubscribes the user from any zones to which they were subscribed.

Resetting a User Login

To reset a user login, complete the following steps:

1. Select the user whose login you wish to reset in the Current Users table. The User Log table populates with the login history for the selected user.
2. Select the rows in the User Log table that pertains to the logins you wish to reset. The **Reset Login** button sensitizes.

Note: The **Reset Login** button is only available for rows where the Logout Date, Logout Status, and Logout Method columns are blank.

3. Click the **Reset Login** button. The User Log table updates the selected rows with the current date and time for the Logout Date, Forced for the Logout Status, and System for the Logout Method.





Using the Mobile User Administration Tab

The Mobile User Administration tab allows you to configure users and permissions for the Oracle Utilities Operations Mobile Application.

Mobile Users

This contains the current user accounts, which can be added, removed, or edited. The available columns are:

- **Username:** The username of the user that is used to log into the application.
- **First Name:** The first name of the user.
- **Last Name:** The last name of the user
- **Creation Key:** The key that was used to create a user, if one was used.
- **Company:** The company that was created.
- **Permission Set:** The permission sets of the user.
- **Crew:** The current crew of the user.
- **Password:** The password of the user

The  **Add**,  **Remove**,  **Edit**,  **Refresh**, and  **Export Configuration...** buttons operate the same way as in the User Administration tab; see [Using the User Administration Tab](#) on page 10-5 for details.

Current Keys

Key: The key that can be given to a crew to create a user account. The key should be sufficiently complex so that it could not be guessed.

Crew Prefix: A required user name prefix for user names created using this key. For example, "OMA_" would require any user name creation request to have this prefix.

Permission Set: The permission set that the created user will be a member of.

Crew Type: If a crew type is listed, then a crew of that type will be created automatically when this key is used to create a user. If it is left blank, then the user will choose an existing crew from a list when the user logs on.

Available: The number of user accounts that can be created using the key. It is decremented each time it is used.

Permission Sets

This contains the list of permission sets, which is a group of permissions that can be used to define what access a user has to the system.

Changing Permission Sets

To modify the permissions for a permission step, do the following:

1. Select the set you wish to modify.
2. To add a permission, select from the Available Permissions column. Click Add Selected Permission. The selected user type will move to the Current Permissions column
3. To remove a permission, select the permission from the Current Permissions Column and click Remove. The selected permission will move to the Available Permissions column.

Permissions

Permissions define what a user has access to, and can also be used to customize the gui for a particular subset of users. There are certain permissions that the system uses to automatically limit access to certain functionality:

- **Change Crew:** This access allows a user to change the crew. If it is not assigned to a user then the user will be locked to their existing crew.
- **Allow Non MDT Crew:** This allows the user to select a Non MDT crew. If not enabled, then only MDT crews are available to the user.

Other permissions can be defined which can be accessed by the mobile application itself. However, using permissions in that manner should not be used for security purposes, because only the above permissions are integrated into the server's permissions.

Using the Event Management Rules Tab

The Event Management Rules tab allows an administrator to add, edit, remove, update, and activate Event Management Rules in the Oracle Utilities Network Management System. These rules govern the behavior and output of Web Trouble in various situations, such as outage prediction, crew behavior, and so on.

This section contains the following information:

- [Event Management Rules Components](#)
- [Working with Rules](#)

Event Management Rules Components

The Event Management Rules tabs contains three panels:

- [Rule Categories Panel](#)
- [Currently Configured Rules Panel](#)
- [Documentation Panel](#)

Rule Categories Panel

The Rule Categories panel on the Event Management Rules tab lists all of the Event Management Rules available for configuration, organized by functional category. The search function at the top of the panel allows you to search for rules.

The Rule Categories may be expanded or collapsed using the buttons below the Categories tree:

- **Expand All:** expands all of the rule category folders to display their contents.
- **Collapse All:** collapses all of the rule category folders.

Selecting a Category to View

When you select a category folder from the Rule Categories panel, the folder expands to display the names of the Event Management Rules within that category. Some of the categories may also have sub-categories.

When an individual rule is displayed in the list, a symbol appears to the left of the rule. The bullet (●) symbol indicates that the rule is already configured in at least one rule set. The red circle with an X (⊗) symbol indicates that the rule is not presently configured in any rule set.

When you select an individual rule (or certain categories) in the list, the Documentation panel on the Event Management Rules tab populates with documentation for the selected rule.

Resizing the Rule Categories Panel

You can resize the Rule Categories panel by dragging the right side of the panel to the left or right. You can also quickly expand or collapse it by clicking the directional arrows next to the upper right corner of the rules categories panel.

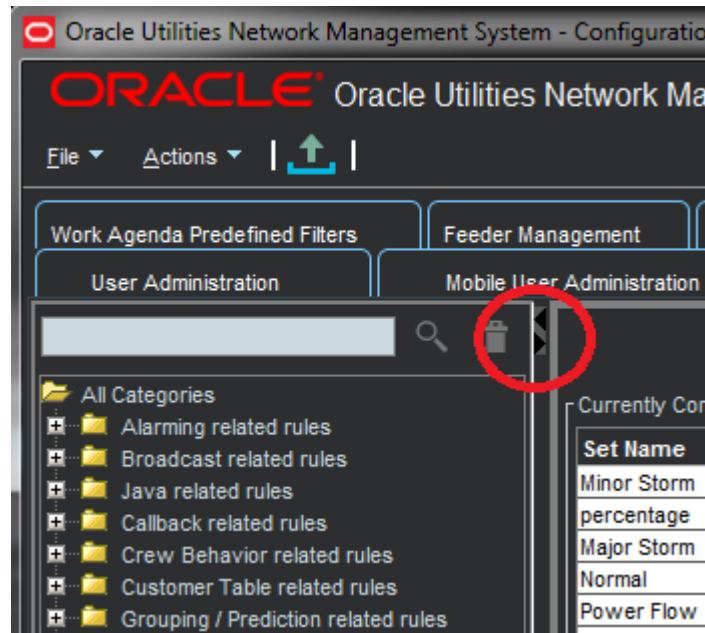

Searching for a Rule

You may filter the rules by adding a search term to the search field and clicking the search (🔍) button.

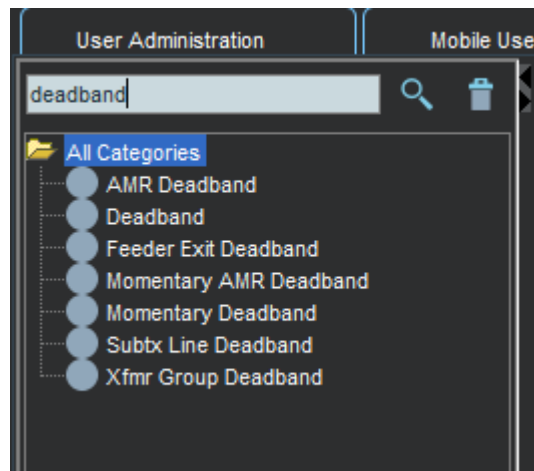







To clear the search, click the 🗑️ button.

Currently Configured Rules Panel

The Currently Configured Rules panel on the [Using the Event Management Rules Tab](#) tab lists the SRS rules configured for Oracle Utilities Network Management System. It allows you to add, edit, and remove rules.

Note: The table uses *friendly* names for readability. For example, one SCADA data related rule has a friendly **Rule Name** of **Allow Calculated Points**, but the code rule name is `RT_CALCULATED_POINTS`. See [Documentation Panel](#) on page 10-16 for more information.

Action Buttons

- The  **Add** button allows you to add a rule to the configuration.
- The  **Remove** button allows you to remove a selected rule from the configuration.
- The  **Edit** button allows you to edit the selected rule in the configuration.
- The  **Refresh** button refreshes the table with the current contents of the database.
- The  **Service Recache** button causes the Oracle Utilities Network Management System services to recache with the changes you made in the Configuration Assistant window. If you do not do this, your changes will not be recognized until Oracle Utilities Network Management System services are restarted.
- The  **Export Configuration...** button generates SQL statements for the current state of the configuration associated with the Event Management Rules tab. These SQL statements may then be saved to a file and/or printed.

Currently Configured Rules Table

The Currently Configured Rules panel displays the following fields and buttons:

- The **Set Name** column displays the friendly Set Name that the rule is configured in.
- The **Incident Type** column displays the configured Incident Type value of the rule.
- The **Rule Name** column displays the rule name.
- The **Rule Value 1** column displays the configured Rule Value 1 value of the rule.
- The **Rule Value 2** column displays the configured Rule Value 2 value of the rule.
- The **NCG Class** column displays the configured ncg class value of the rule.
- The **NCG Index** column displays the configured ncg index value of the rule.
- The **Rule Value Integer 1** column displays the configured Rule Value Integer 1 value of the rule.
- The **Rule Value Integer 2** column displays the configured Rule Value Integer 2 value of the rule.
- The **Rule Value Integer 3** column displays the configured Rule Value Integer 3 value of the rule.
- The **Rule Value Integer 4** column displays the configured Rule Value Integer 4 value of the rule.
- The **Rule Value Integer 5** column displays the configured Rule Value Integer 5 value of the rule.

Filtering the Currently Configured Rules Table

To filter the Currently Configured Rules table based upon a selected column value, complete these steps:

1. Click a cell that contains the value you want to filter the table by. The row will be highlighted and the cell that was clicked will have a border indicating that it is selected.
2. Right-click and choose **Toggle Auto Filter** from the context menu to filter the table by the selected column/cell value combination.

To remove filtering, right-click anywhere in the table and select **Toggle Auto Filter**. The filter will be removed and all table rows will appear.

Documentation Panel

When you select an individual rule and certain categories from the list in the Rule Categories panel, the Documentation panel populates with documentation for the selected rule. For categories, the information is usually descriptive, but the individual rules documentation has the database names for the rule, its attributes, and valid values. If there are related rules, the related rule will be included and will link to the documentation content for that rule.

Example

If you select the **Broadcast related rules** category, the Documentation panel populates with:

These rules control how calls and events get broadcast, including which calls appear in the viewer.

If you select the **Broadcast Clues** rule, the Documentation panel will update with documentation for broadcastClues (the database name). Part of the broadcastClues description includes a link to the documentation page for the related broadcastIncidents rule, which broadcastClues is normally used with.

The friendly names in the Currently Configured Rules panel correspond to the database names as follows:

| Friendly Name | Database Name | Database Description |
|----------------------|----------------------|--|
| Set Name | set_name | A name used to identify what set a rule should belong to. |
| Incident Type | incident_type | See each individual rule description for valid value for this column. |
| Rule Name | rule_name | The name of the rule. |
| Rule Value 1 | rule_value_1 | A character string. See each individual rule description for valid and default values, if applicable. |
| Rule Value 2 | rule_value_2 | An integer value. See each individual rule description for valid and default values, if applicable. |
| NCG CLS | ncg_cls | Used in conjunction with the ncg_idx value to narrow the application of a rule to a specific control zone. |
| NCG Index | ncg_idx | Used in conjunction with the ncg_cls value to narrow the application of a rule to a specific control zone. |
| Rule Value Integer 1 | rule_value_integer_1 | An integer value. See each individual rule description for valid and default values. |
| Rule Value Integer 2 | rule_value_integer_2 | An integer value. See each individual rule description for valid and default values. |
| Rule Value Integer 3 | rule_value_integer_3 | An integer value. See each individual rule description for valid and default values. |

| Friendly Name | Database Name | Database Description |
|----------------------|----------------------|---|
| Rule Value Integer 4 | rule_value_integer_4 | An integer value. See each individual rule description for valid and default values. |
| Rule Value Integer 5 | rule_value_integer_5 | An integer value. See each individual rule description for valid and default values, if applicable. |

Working with Rules

Add a Rule to the Configuration

To add a rule to the configuration, complete these steps:

- Click  **Add** to open the Event Management Rule Fields dialog box.

Note: If you had first selected a row in the Currently Configured Rules table, the dialog box will be initialized with the values from that row.
- Select the name of the rule you wish to add from the **Rule Name** drop-down menu.
- Select the name of the rule set you wish to add the rule to from the **Ruleset** drop-down menu.
- Indicate whether or not you want the rule to be activated in the rule set by checking (or unchecking) the **Active** check box.
- Enter the desired configuration values for the remainder of the fields.

Note: See the Documentation Panel for valid values for the fields.
- Click  **Save** to save the newly added rule.
- If the newly added rule already exists in the specified rule set, a conformation dialog box appears.
 - Clicking **Yes** overwrites the existing rule configuration with the new configuration.
 - Clicking **No** will not add the new rule and you will be returned to the Event Management Rule Fields dialog box.

Note: This is the only validation currently performed when adding a rule. Please refer to the individual rule documentation in the Documentation Panel for further information regarding valid values.

Edit a Rule in the Configuration

To edit a rule in the configuration, complete these steps:

- Select the rule you wish to edit in the Currently Configured Rules table.
- Click  **Edit**. The Event Management Rule Fields dialog box appears.
- Modify the rule fields as desired.

Note: See the Documentation Panel for valid field values.
- Click  **Save**. The rule information is updated in the Currently Configured Rules table.

Note: If you modify a rule's rule set to have values that already exists in that other rule set, an error dialog box appears. Clicking **Yes** will overwrite the existing rule configuration with the new configuration that you specified. Clicking **No** will preserve the existing rule.

For example, you select a **Crew Incident Alarm** rule that is in the Major Storm rule set and then select **Minor Storm** from the **Ruleset** options. If the rule already exists in the Minor Storm rule set, you will get the error.

This is the only validation currently performed when editing a rule. Please refer to the individual rule documentation for further information regarding what the valid values are for a particular rule.



Remove a Rule from the Configuration

To remove a rule from the configuration, complete these steps:

1. Select the rule you wish to remove in the Currently Configured Rules table.
2. Click  **Remove**. A confirmation dialog box appears.
3. Click **Yes** to remove the rule or **No** to cancel.

Export Configuration

To generate and save SQL statements for the current state of the configuration associated with the Event Management Rules tab, complete the following steps:

1. Click the  **Export Configuration...** button beneath the Currently Configured Rules table. A dialog box appears indicating that the configuration is being generated.
2. Once the generation is finished, the Generated Configuration dialog box appears.
 - To save the generated SQL statements to a file, click  **Save**. The Save Configuration File dialog box appears. Type a name for the file into the File name field. The Save Configuration File dialog box disappears.
 - To print out the generated SQL statements, click  **Print**. The Print Preview dialog box appears.
 - Click the **Cancel** button to close the Generated Configuration dialog box.

Using the Event Details Options Tab

The Event Details Options tab allows an administrator to configure the contents of each of the option menus that reside Event Details windows. (See [Managing Crews with Web TroubleEvent Details](#) on page 2-2 for more information.)

This tab contains one panel:

- Event Details Options Panel





Use this tab to perform the following tasks:

- Adding an Options Panel Submenu
- Adding an Option
- Removing an Option
- Editing an Option
- Saving Exported Event Details Configuration
- Reordering Options

Event Details Options Panel



The Event Details Options panel allows you to add, edit, remove, and reorder the contents of each of the option menus that reside on the Event Details windows (see [Managing Crews with Web TroubleEvent Details](#) on page 2-2 for details).

The Event Details Options panel displays the following fields and buttons:

- The **Event Type** allows you specify which event type configuration you want to modify the options of (for example, Outage, Non Outage, Planned Event, Switching Event).
- The **Event Details Option Menus** selection menu contains a list of the option menus that exist for the selected Event Type.
- The **Options for Currently Selected Menu** table populates with the currently configured options for the selected option menu and event types.
- The  **Add** button allows you to add a new option or submenu to the selected option menu for the selected event type.
- The  **Remove** button allows you to remove the selected option.
- The  **Edit** button allows you to edit the selected option.
- The  **Refresh** button refreshes the table with the current contents of the database.
- The  **Export Configuration...** button generates SQL statements for the current state of the configuration associated with the Event Details Options tab. These SQL statements may then be saved to a file and/or printed.

Adding an Options Panel Submenu

Sub-menus allow you to create cascading groups of Event Details options that provide logical categories for the user to drill down to make their selection. To add a submenu to an option menu, complete the following steps:

1. Select the **Event Type** whose option menu you wish to change.
2. Select the option menu you wish to change from the **Event Details Option Menus** drop-down list.
3. Click  **Add**. The Add/Edit Option dialog box appears.
4. Enter the new option name in the **Option Name** field.
5. Enter the same name in the **Display Menu** field.
6. If the new submenu is being added to another submenu, enter the name of the parent submenu in the **Submenu** field.
7. Click  **Save**. The Options for Currently Selected Menu table updates with the new option.

Note: When changing an existing event details option to use cascading drop down menus, a configuration change to an Event Details XML file (that is, `EVENTDETAILS_PNL_ACTIONS.inc`) is also needed. You will need to edit the `ComboBoxBehavior` element by adding the `display_menu` and `submenu` attributes. For more information, see the Event Details Configuration section of the *Oracle Utilities Network Management System Configuration Guide*.

Adding an Option

To add a new option to an option menu, complete the following steps:

1. Select the **Event Type** whose option menu you wish to change.
2. Select the option menu you wish to change from the **Event Details Option Menus** drop-down list.
3. Click  **Add**. The Add/Edit Option dialog box appears.
4. Enter the new option name in the **Option Name** field.
5. Leave the **Display Menu** field blank.
6. If the option is being added to a submenu, enter the name of the submenu in the **Submenu** field.
7. Click **Save**. The Options for Currently Selected Menu table updates with the new option.

Note: If the option name already exists, an error will appear and you will have to modify the name.



Removing an Option

To remove an option from an option menu, complete the following steps:

1. Display the Event Details Options tab on the Configuration Assistant window.
2. Select the Event Type whose option menu you wish to change.
3. Select the option menu you wish to change from the Event Details Option Menus drop-down list.
4. Select the option you wish to remove from the Options for Currently Selected Menu table.
5. Click the  **Remove** button. A confirmation dialog box appears.
6. Click **Yes** to go ahead and remove the option. Click **No** to cancel the removal.

Editing an Option



To edit an existing option, complete the following steps:

1. Display the Event Details Options tab on the Configuration Assistant window.
2. Select the Event Type whose option menu you wish to change.
3. Select the option menu you wish to change from the Event Details Option Menus drop-down list.
4. Select the option you wish to edit from the Options for Currently Selected Menu table.
5. Click the  **Edit** button. The Add/Edit Option dialog box appears.
6. Make the desired changes.
7. Click  **Save** to save the new option. The Options for Currently Selected Menu table updates with the edited option.

Note: If you enter the name of an option that already exists, an error dialog box appears.





Saving Exported Event Details Configuration

To generate and save SQL statements for the current state of the configuration associated with the Event Details Options tab, complete the following steps:

1. Display the Event Details Options tab on the Configuration Assistant window.
2. Click the  **Export Configuration...** button beneath the Options for Currently Selected Menu table. A dialog box appears indicating that the configuration is being generated.
3. Once the generation is finished, the Generated Configuration dialog box appears.
 - To save the generated SQL statements to a file, click  **Save**. The Save Configuration File dialog box appears. Type a name for the file into the File name field. The Save Configuration File dialog box disappears.
 - To print out the generated SQL statements, click  **Print**. The Print Preview dialog box appears.
 - Click the **Cancel** button to close the Generated Configuration dialog box.

Reordering Options

To change the order of the options on an option menu, complete the following steps:



1. Select the Event Type whose option menu you wish to change.
2. Select the option menu you wish to change from the Event Details Option Menus drop-down list. The Options for Currently Selected Menu table populates with the options for the selected option menu and event type.
3. Select an option in the table that you wish to move in the list. The arrows to the right of the column are now sensitized.
4. Use the arrow buttons to rearrange options:
 - Click  to move the selected user type up to the top of the list.
 - Click  to move the selected user type up one position in the list.
 - Click  to move the selected user type down one position in the list.
 - Click  to move the selected user type to the bottom of the list.



Using the Work Agenda Predefined Filters Tab

The Work Agenda Predefined Filters tab on the Configuration Assistant window allows you to add, modify, and delete predefined filters for the Work Agenda. These predefined filters are used to remove (hide) specified rows from the Work Agenda list so that only the desired events are shown. Use this tab to perform the following tasks:

- [Adding a Filter](#)
- [Editing a Filter](#)
- [Deleting a Filter](#)



The Work Agenda Predefined Filters tab displays the following fields and buttons:

- The **Current Filter** drop-down displays the name of the currently displayed filter and allows you to select an existing predefined filter.
- The **Filter Option Table** contains the following columns:
 - The **Column Name** column displays all columns by which you can filter.
 - The **Filter Type** column displays the available filter types:
 - **Any** - No filter is applied. All values for this column are included. This is the default.
 - **Match** - When this filter type is selected, the Work Agenda will include only items where the value of the column specified in the Column Name field matches the value specified in the Value field.
 - **Like** - When this filter type is selected, the Work Agenda will include only items where the value of the column specified in the Column Name field includes the value specified in the Value field.
 - **Not Like** - When this filter type is selected, the Work Agenda will include only items where the value of the column specified in the Column Name field does not include the value specified in the Value field.
 - **Multi-Match** - When this filter type is selected, the Work Agenda will include only items where the value of column specified in the Column Name field matches any of the values specified in the Value field.
 - **Not** - When this filter type is selected, the Work Agenda will include only items where the value of the column specified in the Column Name field does not match the value specified in the Value field.
 - **Multi-not** - When this filter type is selected, the Work Agenda will include only items where the value of the column specified in the Column Name field does not match any of the values specified in the Value field.
 - **>** - When this filter type is selected, the Work Agenda will include only items where the value of the column specified in the Column Name field is greater than the value specified in the Value field.
 - **<** - When this filter type is selected, the Work Agenda will include only items where the value of the column specified in the Column Name field is less than the value specified in the Value field.
 - The **Value** column allows you to enter the filter value.
- The  **Add** button allows you to add a new filter.
- The  **Save** button allows you to save a new filter or edit an existing filter.
- The  **Delete** button allows you to remove the selected filter.

- The  **Refresh** button refreshes the table with the current contents of the database.
- The  **Export Configuration...** button generates SQL statements for the current state of the configuration associated with the Work Agenda Predefined Filter tab. These SQL statements may then be saved to a file and/or printed.

Adding a Filter

To add a new filter, follow these steps:

1. Click  **Add** on the Work Agenda Predefined Filters tab. The Add Filter Name dialog box is displayed.
2. Enter a meaningful name for the filter and click **OK**. The new filter name is displayed in the Current Filter box. The Filter Options table displays a list of columns by which you can filter the Work Agenda. By default, the Filter Type for all columns is Any, indicating that no filter is currently applied.
3. To apply a filter to a particular column, select the desired Filter Type (described in the previous section) and enter the filter Value. For example, to filter the Work Agenda by restore date, locate the Restore Date column, then select '>' from the Filter Type drop-down, and enter a date in the Value column. The filter will display only events with a Restore Date greater than the date you entered.
4. Repeat step 3 for each column you want to filter by.
5. Click  **Save** to save the new filter criteria.

Note: To make the new filter criteria available in the Work Agenda, the name of the new filter needs to be added to the OTHER_FILTERS column in the DYNTABLE_VIEWS table for the desired Work Agenda view.

Editing a Filter

To edit an existing filter, follow these steps:

1. From the Current Filters combo box, select the filter you want to edit.
2. Modify the filter settings as needed. To remove a filter, select **Any** from the Filter Type drop-down for that column. To filter by a particular column, select the desired Filter Type and enter a filter Value.
3. Click  **Save**. The filter is updated and will be available from the Work Agenda.



Deleting a Filter

To delete an existing filter, follow these steps:

1. From the Current Filters combo box, select the filter you want to delete.
2. Click  **Delete**. A confirmation dialog box is displayed.
3. Click **OK** to confirm the deletion. The filter is deleted and will no longer be available from the Work Agenda.

Saving an Exported User Configuration

To generate and save SQL statements for the current state of the configuration associated with the Work Agenda Predefine Filter tab, complete the following steps:

1. Click the  **Export Configuration...** button beneath the Current Filter table.
2. Once the generation is finished, the Generated Configuration dialog box appears.
 - To save the generated SQL statements to a file, click  **Save**. The Save Configuration File dialog box appears. Type a name for the file into the File name field. The Save Configuration File dialog box disappears.
 - To print out the generated SQL statements, click  **Print**. The Print Preview dialog box appears.
 - Click the **Cancel** button to close the Generated Configuration dialog box.

OptimizationOptimization Using the State Transitions Tab

In Oracle Utilities Network Management System, events, switching sheets, safety documents, and damage assessment pass through different phases over their lifecycle. These phases are represented by *states*. Transitions between states are known as state transitions. A transition between any two states happens when certain actions are performed by a user or the system.

The State Transitions tab allows you to view the state transitions of events, switching sheets, safety documents, and damage assessment in tabular and graphical views. The tab is divided into 3 panes:



1. Selection Pane

State transitions in NMS are divided logically into multiple groups. The highest level division is based on the application (**APP**); the second level is based on sub-categorizations of the applications into groups (**Group**); the last level are states applicable to the application group.

Filter Options Menus

- **App:** the application type option menu lists codes for the NMS applications with state transitions:
 - DA - Damage Assessment
 - SF - Safety
 - TE - Trouble Events (generic for events)
 - WSW - Web Switching
- **Group:** the group selection lists the available groups for the selected application. For example, if the application is TE, you may select OUT for outage events.
- **States:** the states selection lists the available states for the chosen app-group combination. In addition to the specific states selection, you may choose **All States** to see all state transitions for the app-group combination.

Buttons

-  **View:** Based on the selection of different combo boxes, on clicking this button, it will display the filtered set of transitions in table and graphical view.
-  **Refresh:** refreshes the data by reading from the database table, but retains previously selected filters by user.

2. Tabular Section

The table displays transitions in tabular view and contains following columns:

- **APP:** Application name
- **TRANS_KEY:** unique key of transitions
- **TRANS_GROUP_KEY:** transition type (OUTAGE/MEET).
- **FROM_STATE_KEY:** unique value for state (from).
- **TO_STATE_KEY:** unique value for state (to).
- **TRANS_ACT_KEY:** unique value for action.
- **DESCRIPTION:** description of this state transition.

3. Graphical Section:

The transitions from the table are displayed in a hierarchical view in this section. States are displayed as rectangular boxes labeled with the state name. Transitions are displayed with arrow symbols beginning at the *from state* and ending at the *end state* with the action name of the transition on top of the edge. When you select an arrow in the graphical view, the corresponding table row will be highlighted.

Viewing State Transitions

To view state transitions, do the following:

1. Select the application from the **App** options menu.
2. Select the group from the **Group** options menu.
3. Select a specific state from the **State** options menu.
4. Click  **View**.

The table and graph will be updated for the state transitions applicable to your selection.

Example: New Damage Assessments State Transitions

1. Select **DA** from the **App** menu.
2. Select **Damage Assessment** from the **Group** menu.
3. Select **New** from the **State** menu.
4. Click the arrow that starts at the **New** box and ends at the **Assessed** box.

| ... | T... | TRANS... | FROM_ST... | TO_STAT... | TRANS_ACT_KEY | DESCRIPTION |
|-----|------|----------|------------|------------|---------------|----------------------|
| DA | 100 | 100 | 100 | 200 | 100 | New -> Assessed |
| DA | 110 | 100 | 100 | 300 | 200 | New -> Complete |
| DA | 120 | 100 | 100 | 400 | 300 | New -> Obsolete |
| DA | 130 | 100 | 200 | 300 | 200 | Assessed -> Complete |
| DA | 140 | 100 | 200 | 400 | 300 | Assessed -> Obsolete |
| DA | 150 | 100 | 300 | 400 | 300 | Complete -> Obsolete |

Using the Default Restoration Times Tab

The Default Restoration Times tab on the Configuration Assistant window displays the current default restoration time configuration and allows you to modify the ERT values for each asset class by control zone.

Note: To change the system-wide default restoration time, see [Setting the System-Wide Estimated Restoration Time](#) on page 2-31.





Asset/Zone Default Restoration Times Pane

The Asset/Zone Default Restoration Times pane provides a tabular view that provides the relationship between a control zone, an asset, and the default restoration time that has been set for them.

Columns

- The **Control Zone** column displays the control zone name.
- The **Asset Class** column displays the asset class name.
- The **User** column lists the user who configured the default restoration time.
- The **Default Restoration Times (minutes)** column displays the number of minutes to be used for the default restoration time for this control zone-asset class combination.

Buttons



- The  **Add** button opens the Add Default Restoration Time dialog box.
- The  **Remove** button marks the selected default restoration time for deletion.
- The  **Save** button saves any changes you have made.
- The  **Refresh** button refreshes the screen. If you have any unsaved changes, the system asks if you want to save them.
- The  **Export Configuration** button opens the Generated Configuration window, which displays the SQL statements used to generate the current configuration.

Row Highlighting

The table uses row highlighting to indicate changes that have not been saved. Red indicates that the row is marked for removal, green indicates the row has been edited, and light blue indicates that the row has been added.

Adding an Asset/Zone-Based Default Restoration Time

To add a default restoration time for a specific asset class-control zone combination, follow these steps:

1. Click  **Add**. The Add Default Restoration Time window appears.
2. Click the **Control Zone Selection** button to display a list of control zones.
3. Select a Control Zone and click **OK**.
4. Click the **Select** button to display a list of asset classes.
5. Select an asset class and click **OK**.
6. Modify the Restore Time (minutes) field, as necessary.
7. Click **OK**. The Asset/Zone Default Restoration Times pane refreshes with a new row, which is highlighted in light blue to show the addition.
8. Click  **Save** to commit the addition.

Note: If you decide against adding the new Default Restoration Time, click

 **Refresh**. The system will prompt you to save changes; click **No**.

Modifying an Asset/Zone-Based Default Restoration Time



To edit an existing default restoration time, do the following:

1. Double-click the Default Restoration Time cell to open it for editing.
2. Edit the value.
3. Click anywhere outside the cell to finish the edit. The row will be highlighted in green to indicate the pending change.
4. Click  **Save** to commit the change.

Note: If you decide not to save changes, click  **Refresh**. The system will prompt you to save changes; click **No**.

Deleting an Asset/Zone-Based Default Restoration Time



To edit an existing default restoration time, do the following:

1. Select the row to be removed.
2. The  **Remove**. The row will be marked for removal pending saving changes. The row will be highlighted in red to indicate the pending change.
3. Click  **Save** to commit the change.

Note: If you decide against deleting the row, click  **Refresh**. The system will prompt you to save changes; click **No** to confirm the refresh.

Saving an Exported Default Restoration Time Configuration

To generate and save SQL statements for the current state of the configuration associated with the Default Restoration Times tab, complete the following steps:

1. Click the  **Export Configuration...** button beneath the Asset/Zone Default Restoration Times table.
2. Once the generation is finished, the Generated Configuration dialog box appears.
 - To save the generated SQL statements to a file, click  **Save**. The Save Configuration File dialog box appears. Type a name for the file into the File name field. The Save Configuration File dialog box disappears.
 - To print out the generated SQL statements, click  **Print**. The Print Preview dialog box appears.
 - Click the **Cancel** button to close the Generated Configuration dialog box.



Using the Customer Administration Tab

The Customer Administration tab allows you to define a weighted priority for a customer. The weighted priority may be used for sorting events in the Work Agenda or viewed in the Trouble Info Customers view.

Menus and Toolbar

When the Customer Administration tab is active, the Configuration Assistant's **Actions** menu and toolbar change to provide functions for Customer Administration. The **Options** menu provides search methods.

Actions Menu

| Menu Option | Description | Icon |
|-------------------------|--|--|
| Customer Search | Initiates a search when criteria has been added to the Searchable Information table in the Customer Weighted Priority Editor pane. |  |
| Save | Saves information entered in the Customer Weighted Priority Editor. |  |
| Reset to default | Used to reset a Customer weighted priority to the default value. | -- |
| Clear Form | Clears all data from the Customer Weighted Priority Editor pane. |  |

Options Menu

| Menu Option | Description |
|---|---|
| Set Wild Card Searching | Options for setting a wild card searches: Before, After, or Both. Note that you do not have to add a wild card character (*). |
| <ul style="list-style-type: none"> • Before • After • Both | <p>Example: using the "After" wild card search. Name: <i>Mary S</i> returns:</p> <ul style="list-style-type: none"> • Mary S Abbott • ... • Mary Szbrinski |

| Menu Option | Description |
|---------------------------|---|
| Use Sound Search | Returns searches with "sounds like" matches. Example: Use Sound Search Name: <i>Fredric</i> returns: <ul style="list-style-type: none"> • Fredric • Fredrick • Frederick • Fred • Freda |
| Use Exact Match Search | Returns only exact matches. |
| Set Max Searching Results | Opens the Set Maximum Searching Result dialog box where you can set the limit for matches to return. The system will display a message when a search returns over 200 results, which is the maximum allowed by default. |

Setting Debug

The Set Debug dialog box is initiated from the Help menu of all the NMS Environments. In some cases, issues cannot be properly diagnosed with only a list of actions the users partakes within the environment. In those cases, additional debug is required. The Set Debug dialog box should be used to turn debug categories on and off within an environment. When the dialog box is initiated from the Configuration Assistant user type, then additional options are available allowing the user to manage debug on all the clients and also within the Oracle Utilities Network Management System services.

Columns

- The **Name** column displays the name of the debug category. In some cases this is the fully qualified class name.
- The **On/Off Toggle** column displays and allows you to set whether the debug for that row is on or off.
- The **Level** column displays whether the debug is on or off.
- The **Application** column displays the application that the debug pertains to. If it is a generic debug category, then it will have an Application value of *All*. Other examples include, but are not limited to Web Switching, Authority, Call Entry, and so on.
- The **Destination** column displays where the debug setting will be set. For Java clients, the value will be Clients. Other values include, but are not limited to WebLogic, PFService, publisher, and so on.

Note: This column is only visible if you are viewing the dialog box as a Configuration Assistant user. All other users will be limited to viewing debug pertaining to their client environment. Only a Configuration Assistant user can set debug levels on other clients, within WebLogic or within the Oracle Utilities Network Management System services.

- The **Description** column displays the documented description for the debug entry. Not all debug entries will have a description as some entries will be determined dynamically based on what the client has access to.

Manual Debug Entry

The Manual Debug Entry form is used to enter settings for debug that is not available in the table list or may require a level setting other than on or off.

Note: Only Oracle Utilities Network Management System services can accept debug number values greater than 1. Any value greater than 1 that is sent to a Java based destination will be viewed as an *on* request for the debug specified.

- The Name field allows you to enter a debug name that may not be available from the table list.
- The Destination field defines where the debug setting should be applied. If you have a custom adapter that has debug capabilities, then you can manually enter the registered name of this adapter in this field.

Note: This field is only visible if you are viewing the dialog box as a Configuration Assistant user. All other users will be limited to setting debug on their client environment.

- The **Level** field is used to define what level of debug you would like to define for the name that was entered. The field can take manual entries as well in case the list of levels do not include the debug level you wish to send to your specified Destination. If you are not a Configuration Assistant user, then the only levels you should use are on and off.
- The **Set** button sets the debug level within the current client environment or sends it to the Destination indicated if you are running this as the Configuration Assistant user.

The **Help...** button opens the online help window for this section.

The **OK** button closes the dialog box.

Using the Customer Administration Weighted Priority Editor

The Customer Weighted Priority Editor is divided into two panes: **Searchable Information** and **Additional Customer Information**. As the name suggests, the **Searchable Information** pane is used to search for and load customer information. Once the customer is found and selected, the **Additional Customer Information** is populated with current information and the **New Weighted Priority** field becomes editable.

Note: The Configuration Assistant Customer Administration search functions are much like Web Call Entry's search behavior.

Searching for a Customer

To set a weighted priority for a customer, perform the following steps:

1. Set your search option; see [Options Menu](#) on page 10-32 for more information on search options.
2. Enter Search Criteria. You can search for a customer based on any of the fields in the Searchable Information pane:
 - Account Number
 - Telephone Number
 - Name

- Address
 - City
3. Press Enter (or click the  search toolbar button).
 - If the search does not return a value, the system will return *"No customers matched your search criteria."* Click **OK** to dismiss the message.
 - If the search returns more than 200 records (or your defined Max Searching Results value), the system will return the "Too Many Customers Found" message, which will remind you of the option to set a higher maximum searching results. Click **OK** to dismiss the message. The Customer Selection dialog box opens listing the search results up to the maximum searching results value.
 4. Select the customer to edit and click **OK**.

Editing a Customer Weighted Priority

Once you have selected a customer from the search results, the customer account information is loaded into the Customer Weighted Priority Editor. The **New Weighted Priority** field, which is at the bottom of the Additional Customer Information pane, is the only editable field.

1. Enter an integer value in the **New Weighted Priority** field. Notice that the  **Save** button becomes enabled.

Note: If you decide against editing the selected customer, click  to reset the form.

2. Click .

Resetting Weighted Priority

If you need to set a customer's weighted priority back to its original value, perform the following steps:

1. Search for the customer to load their data into the Customer Weighted Priority Editor.
2. From the Actions menu, select **Reset to default**. The **New Weighted Priority** field will be populated with the customer's original weighted priority value.
3. Click .

Appendix A

Acronyms

This appendix lists acronyms found in the Oracle Utilities Network Management System and its documentation.

| Acronym | Description |
|----------------|--|
| AMI | Advanced Metering Infrastructure |
| ACT | Active |
| ADMS | Advanced Distribution Management System |
| AMR | Automated Meter Reading |
| API | Application Programming Interface |
| App | Application (typically mobile or tablet based) |
| AVL | Automatic Vehicle Location |
| CCB | Oracle Utilities Customer Care and Billing |
| CIS | Customer Information System |
| CMI | Customer Minutes Interrupted |
| CSS | Oracle Utilities Customer Self Service |
| CSV | Comma Separated Values |
| DA | Distribution Automation / Damage Assessment |
| DCZ | Delegated Control Zone |
| DMS | Distribution Management System |
| DNP | Distributed Network Protocol |
| EAT | Estimated Assessment Time |
| EMR | Emergency |
| ERT | Estimated Restoration Time |
| GIS | Geographic Information System |
| GPS | Global Positioning System |

| Acronym | Description |
|----------------|--|
| GRP | Group |
| HSB | Hue/Saturation/Brightness |
| HTML | Hypertext Markup Language |
| ICCP | Inter-Control Center Communications Protocol |
| IVR | Interactive Voice Response |
| JDBC | Java Database Connectivity API |
| JNDI | Java Naming and Directory Interface |
| MDM | Oracle Utilities Meter Data Management System |
| MDT | Mobile Data Terminal |
| MED | Medical |
| MWM | Oracle Utilities Mobile Workforce Management |
| NCG | Network Control Group |
| NMS | Oracle Utilities Network Management System |
| NTS | NMS Training Simulator |
| ODM | Oracle Utilities Operational Device Management |
| OMS | Outage Management System |
| OPT | Optimization |
| ORS | Oracle Real-Time Scheduler |
| OS | Operating System |
| OUA | Oracle Utilities Analytics |
| PDF | Portable Document Format |
| RDBMS | Relational Database Management System |
| RGB | Red/Green/Blue |
| ROW | Right of Way |
| RTF | Rich Text Format |
| RTU | Remote Terminal Unit |
| SA | Service Alert |
| SCADA | Supervisory Control and Data Acquisition |
| SDK | Software Development Kit |
| SGG | Oracle Utilities Smart Grid Gateway |
| SMS | Short Message Service |
| SMTP | Simple Mail Transfer Protocol |
| SQL | Structured Query Language |

| Acronym | Description |
|----------------|--|
| STD | Standard |
| TBG | To Be Grouped |
| TBU | To Be Ungrouped |
| TTL | Time-to-Live |
| URI | Uniform Resource Identifier |
| URL | Uniform Resource Locator (Internet Address) |
| WAM | Oracle Utilities Work and Asset Management |
| WCB | Web Callbacks |
| WCE | Web Call Entry |
| WLS | Oracle WebLogic Server |
| WMS | Work Management System |
| WS | Web Service |
| WW | Web Workspace |
| XML | Extensible Markup Language |
| XSL | Extensible Stylesheet Language |
| XSLT | Extensible Stylesheet Language Transformations |

Appendix B







Event Status and Event Type Codes













This appendix lists and describes coded information that appears in Oracle Utilities Network Management System screens, including:















- [Event Status Codes](#)
- [Event Type Codes](#)

Event Status Codes

Work Agenda displays the current status of each event listed. The event status is also displayed on the Call Information window. The following table provides the event status codes, their descriptions, and the associated icons used in the Work Agenda and associated tools.:

| Status Code | Description | Icon |
|-------------|---|---|
| ASN | Crew is assigned to the event. |  |
| CMP | Event has been completed (event and event details are complete). |  |
| CNL | Event has been cancelled by a user (using the Cancel Event button in the Work Agenda window). |  |
| CRT | Acknowledged critical meet. | -- |
| ENR | Crew is en route to the event. |  |
| INC | Event has been completed, but information needs to be entered in the Event Details window. |  |
| MADE-SAFE | The event has been made safe. | |
| MNP | Maintenance pending. |  |
| NEW | New unacknowledged event. | -- |
| NFY | Notify alarm. |  |
| O-NEW | New unacknowledged Optimization event. | |

| Status Code | Description | Icon |
|-------------|--|---|
| O-CMP | Optimization event has been completed. | |
| O-CNL | Optimization event has been cancelled. | |
| O-INC | Optimization event has been completed, but information must be added to the event. | |
| ONS | Crew is onsite at the event. |  |
| P-CMP | Planned event has been completed (event and event details are complete). |  |
| P-INC | Planned event has been completed, but information needs to be entered in the Event Details window. |  |
| P-NEW | New unacknowledged planned event. | -- |
| P-RCVD | Planned event was received by mobile system and receipt was acknowledged by the MQ adapter. | -- |
| P-SNT | Unassigned (acknowledged) planned event manually sent to the mobile system. |  |
| P-UAS | Unassigned (acknowledged) planned event. |  |
| RCVD | Order was received by mobile system and receipt was acknowledged by the MQ adapter. |  |
| RED | New critical meet. | -- |
| RSCH | Rescheduled meet. | -- |
| RST | Event has been restored and a crew is still associated with the event. |  |
| S-ASN | Crew is assigned to the SCADA event. |  |
| S-CMP | SCADA event has been completed (event and event details are complete). |  |
| S-CNL | SCADA event has been cancelled from the Work Agenda. | |
| S-ENR | Crew is en route to the SCADA event. |  |
| S-INC | SCADA event has been completed, but information needs to be entered in the Event Details window. |  |
| S-MNP | Maintenance pending (SCADA event). |  |
| S-NEW | New unacknowledged SCADA event. | -- |
| S-ONS | Crew is onsite at the SCADA event. |  |

| Status Code | Description | Icon |
|-------------|--|---|
| S-RCVD | SCADA event was received by mobile system and receipt was acknowledged by the MQ adapter. | -- |
| S-RST | SCADA event has been restored and a crew is still associated with the event. |  |
| S-SNT | Unassigned (acknowledged) SCADA event manually sent to the mobile system. |  |
| S-SUS | Crew has been re-dispatched to another event, but is still assigned to this SCADA event. |  |
| S-UAS | Unassigned (acknowledged) SCADA event. |  |
| SNT | Unassigned (acknowledged) event manually sent to the mobile system. |  |
| SUS | Crew has been re-dispatched to another event, but is still assigned to this one. |  |
| UAS | Unassigned (acknowledged) event. |  |
| VFY | A probable service outage is in this state if the system reports that the meter at the outage location has service. This state provides an indication for the operator to verify that the customer indeed is out of power. | -- |
| W-ASN | Crew is assigned to the switching event. |  |
| W-CMP | Switching event has been completed (the corresponding switching plan has been completed). |  |
| W-CNL | Switching event has been cancelled (the corresponding switching plan has been rescheduled). |  |
| W-ENR | Crew is en route to the switching event. |  |
| W-ONS | Crew is onsite at the switching event. |  |
| W-RCVD | Switching event was received by mobile system and receipt was acknowledged by the MQ adapter. | -- |
| W-SNT | Unassigned (acknowledged) switching event manually sent to the mobile system. |  |
| W-SUS | Crew has been re-dispatched to another event, but is still assigned to this switching event. |  |
| W-UAS | Unassigned (acknowledged) switching event. |  |

Event Type Codes

Event Type codes are displayed on the Trouble Call Entry Lists. Below is a complete list of event type codes and their descriptions:

| Event Type Code | Description |
|------------------------|--------------------------|
| CSVO | confirmed service outage |
| FUZZY | fuzzy event |
| MEET | meet |
| NFY | notify alarm |
| NON | non-outage |
| PDO | probable asset outage |
| PLAN | planned outage |
| PSO | probable service outage |
| RDO | real asset outage |
| SWP | switching event |

Appendix C

Color Coding

This appendix lists and describes color coding that appears in Oracle Utilities Network Management System screens, including:

- [Crew Status](#)
- [Event Status](#)
- [Callback Status](#)
- [Callback Status](#)

Note: All color coding is configurable and your site may use different colors than those shown in this appendix.

Crew Status

The table below describes the color coding used on the Crew Actions and Crew List windows to indicate crew status when cell coloring is enabled in the Web Workspace **Preferences** menu (see [Color Coding Options](#) on page 1-9). These colors are also used for AVL crew symbols in the Viewer.

| Color | Crew Status |
|------------|--|
| Green | En Route |
| Dark Green | Onsite |
| Yellow | Unavailable |
| Cyan | Assigned |
| Orange | Suspended |
| Brown | Crew has no control zone (that is, the crew's assigned control zone has been removed from the control zone hierarchy). |
| White | Available |

Event Status

The table below identifies the color coding used on the Work Agenda list to indicate the event status when cell or row coloring is enabled in the Web Workspace **Preferences** menu (see [Color Coding Options](#) on page 1-9).

| Row Color | Event Status |
|-------------------------------------|--------------|
| White text on dark red background | NEW |
| White text on red-orange background | P-NEW |
| White text on red background | S-NEW |
| White text on bright red background | RED |
| Red text on white background | NFY |
| Black text on yellow background | SNT |
| | UAS |
| Black text on gold background | P-SNT |
| | P-UAS |
| | W-SNT |
| | W-UAS |
| Black text on dark gold background | S-SNT |
| | S-UAS |
| Black text on cyan background | ASN |
| | S-ASN |
| | W-ASN |
| Black text on green background | ENR |
| | S-ENR |
| | W-ENR |
| Black text on dark green background | ONS |
| | S-ONS |
| | W-ONS |
| White text on blue background | RST |
| | S-RST |

| Row Color | Event Status |
|--------------------------------------|--------------|
| Black text on gray background | CMP |
| | P-CMP |
| | W-CMP |
| | S-CMP |
| Black text on orange background | SUS |
| | S-SUS |
| | W-SUS |
| White text on purple background | INC |
| White text on orchid background | P-INC |
| Black text on plum background | S-INC |
| White text on violet background | M-INC |
| Black text on white background | MNP |
| | S-MNP |
| Black text on light green background | C-CNL |
| White text on brown background | CNL |
| | S-CNL |
| | W-CNL |

Pipe Symbology

In the Viewer, pipe symbology changes color and line style (*e.g.*, pattern, thickness) for different types of pipes and topology states. Pipe symbology is configurable. The following table shows the default color coding used for pipe symbology:

| Line Style | Color | Description |
|------------|--------------------|---|
| Dashed | Black and white | Isolated |
| Thick | Light blue overlay | In Trace mode, indicates a pipe that is part of the path from a selected asset. |
| Thick | Magenta overlay | Loop, bi-directional flow |
| Thick | Purple overlay | Parallel |
| Solid | Varies | Standard pipe |

Callback Status

The Callback Status field on the Perform Callbacks List Window and the Perform Next Callback window is color-coded to indicate whether a callback attempt has been made and the result of the last attempt. The following table shows the default color coding used for callback status:

| Color | Description |
|-------|---|
| White | Not Called - indicates you have not yet called the customer (default). The callback remains in the callbacks list. |
| Blue | Restored - indicates the customer confirmed their service was restored. The callback is considered complete and is removed from the callbacks list the next time it is brought up. |
| Red | Not Restored - indicates you called the customer, and the customer indicated that service was not restored. The callback is considered complete and is removed from the callbacks list the next time it is brought up. The call is re-introduced into the Oracle Utilities Network Management System for re-analysis and restoration and a new callback will be generated when that event is restored. |
| Green | Indicates one of the following: No Answer - indicates you attempted to reach the customer, but nobody answered the telephone. The callback remains in the callbacks list. Busy - indicates you attempted to reach the customer, but the line was busy. The callback remains in the callbacks list. |
| Brown | Cancel - cancels the callback. The callback is considered complete and is removed from the callbacks list the next time it is brought up. |

Appendix D

Tool to User Type Matrix

This appendix lists the Oracle Utilities Network Management System tools that are available to each user type in the following environments:

- [Web Workspace](#)
- [Storm Management](#)

Web Workspace

| Tool (license) | Full Operations plus Switching | Full Operations | Trouble Maintenance | Crew Operations | View Only | Administration | Switching Request | Trainer |
|-------------------------|--------------------------------|-----------------|---------------------|-----------------|-----------|----------------|-------------------|---------|
| Alarms and Assets Lists | X | X | X | | X | X | | X |
| AMI Requests (amr) | X | X | | | | X | | X |
| Attributes | X | X | X | X | X | X | | X |
| Authority | X | X | X | X | X | X | | X |
| Call Entry | | | | | | | | X |
| Condition Summaries | X | X | X | | X | X | | X |
| Configuration Assistant | | | | | | X | | X |
| Control | X | X | X | X | X | X | | X |
| Crew Actions | X | X | X | X | X | X | | X |
| Damage Assessment | X | X | X | | | X | | X |
| Damage Reports | X | X | X | | | X | | X |
| Event Details | X | X | X | X | X | X | | X |

| Tool (license) | Full Operations plus Switching | Full Operations | Trouble Maintenance | Crew Operations | View Only | Administration | Switching Request | Trainer |
|-----------------------|---------------------------------------|------------------------|----------------------------|------------------------|------------------|-----------------------|--------------------------|----------------|
| Event Log | X | X | X | X | | X | | X |
| Manage Documents | X | X | | | | X | | X |
| Safety (switching) | X | | | | X | X | | X |
| SCADA Summary | X | X | X | | | X | | X |
| Switching (switching) | X | | | | X | X | X | X |
| Trouble Info | X | X | X | X | X | X | | X |
| Trouble Summary | X | X | X | | X | X | | X |
| User Log | X | X | | | | X | | X |
| Viewer | X | X | X | X | X | X | | X |
| Work Agenda | X | X | X | X | X | X | | X |

Storm Management

| Tool | Full Operations | View Only | Storm Administration |
|-----------------------|------------------------|------------------|-----------------------------|
| Calculate Crews | | X | |
| ERT Override | X | | |
| Forecast Profiles | X | | |
| Force Simulation | X | | |
| Storm List | | | X |
| Storm Report | X | X | |
| Study Session Control | X | | |
| Summary Information | X | X | |
| Toggle Storm Mode | X | | |
| Zone Selection | X | X | |

