

**Oracle Utilities  
Customer to Meter**

Administrative User Guide

Release 2.7.0

**E98918-01**

September 2018

Oracle Utilities Customer to Meter Administrative User Guide

Release 2.7.0

E98918-01

September 2018

Documentation build: 8.31.2018 16:28:32 [X1\_1535750912000]

Copyright © 2018, Oracle and/or its affiliates. All rights reserved.

This software and related documentation are provided under a license agreement containing restrictions on use and disclosure and are protected by intellectual property laws. Except as expressly permitted in your license agreement or allowed by law, you may not use, copy, reproduce, translate, broadcast, modify, license, transmit, distribute, exhibit, perform, publish, or display any part, in any form, or by any means. Reverse engineering, disassembly, or decompilation of this software, unless required by law for interoperability, is prohibited.

The information contained herein is subject to change without notice and is not warranted to be error-free. If you find any errors, please report them to us in writing.

If this is software or related documentation that is delivered to the U.S. Government or anyone licensing it on behalf of the U.S. Government, then the following notice is applicable:

U.S. GOVERNMENT END USERS: Oracle programs, including any operating system, integrated software, any programs installed on the hardware, and/or documentation, delivered to U.S. Government end users are "commercial computer software" pursuant to the applicable Federal Acquisition Regulation and agency-specific supplemental regulations. As such, use, duplication, disclosure, modification, and adaptation of the programs, including any operating system, integrated software, any programs installed on the hardware, and/or documentation, shall be subject to license terms and license restrictions applicable to the programs. No other rights are granted to the U.S. Government.

This software or hardware is developed for general use in a variety of information management applications. It is not developed or intended for use in any inherently dangerous applications, including applications that may create a risk of personal injury. If you use this software or hardware in dangerous applications, then you shall be responsible to take all appropriate fail-safe, backup, redundancy, and other measures to ensure its safe use. Oracle Corporation and its affiliates disclaim any liability for any damages caused by use of this software or hardware in dangerous applications.

Oracle and Java are registered trademarks of Oracle and/or its affiliates. Other names may be trademarks of their respective owners. Intel and Intel Xeon are trademarks or registered trademarks of Intel Corporation. All SPARC trademarks are used under license and are trademarks or registered trademarks of SPARC International, Inc. AMD, Opteron, the AMD logo, and the AMD Opteron logo are trademarks or registered trademarks of Advanced Micro Devices. UNIX is a registered trademark of The Open Group.

This software or hardware and documentation may provide access to or information about content, products, and services from third parties. Oracle Corporation and its affiliates are not responsible for and expressly disclaim all warranties of any kind with respect to third-party content, products, and services unless otherwise set forth in an applicable agreement between you and Oracle. Oracle Corporation and its affiliates will not be responsible for any loss, costs, or damages incurred due to your access to or use of third-party content, products, or services, except as set forth in an applicable agreement between you and Oracle.

# Contents

<b>Administrative User Guides.....</b>	<b>25</b>
Framework Administrative User Guide.....	25
Defining General Options.....	25
Defining Installation Options.....	25
Installation Options - Main.....	25
Installation Options - Messages.....	26
Installation Options - Algorithms.....	26
Installation Options - Accessible Modules.....	28
Installation Options - Installed Products.....	28
Support For Different Languages.....	29
User Language.....	29
Customer Language.....	30
Defining Languages.....	30
Defining Countries.....	31
Country - Main.....	31
Country - States.....	32
Defining Currency Codes.....	32
Defining Time Zones.....	32
Designing Time Zones.....	32
Setting Up Time Zones.....	33
Setting Up Seasonal Time Shift.....	34
Defining Geographic Types.....	34
Defining Work Calendar.....	34
Defining Display Profiles.....	35
Additional Hijri Date Configuration.....	37
Defining Phone Types.....	37
Setting Up Characteristic Types & Values.....	37
There Are Four Types Of Characteristics.....	38
Searching By Characteristic Values.....	39
Characteristic Type - Main.....	39
Characteristic Type - Characteristic Entities.....	40
Setting Up Foreign Key Reference Information.....	40
Information Description Is Dynamically Derived.....	41
Navigation Information Is Dynamically Derived.....	41
Search Options.....	42
Foreign Key Reference - Main.....	42
Defining Feature Configurations.....	43
Feature Configuration - Main.....	44
Feature Configuration - Messages.....	44
Defining Master Configurations.....	44
Defining Security & User Options.....	45
The Big Picture of Application Security.....	46
Application Security.....	46
Action Level Security.....	47
Field Level Security.....	48
Encryption and Masking.....	48
The Base Package Controls One User, One User Group, And Many Application Services.....	55
Importing Security Configuration from an External Source.....	56
The Big Picture of Row Security.....	56
Defining Application Services.....	57
Application Service - Main.....	57
Application Service - Application Security.....	57
Defining Security Types.....	57
Security Type - Main.....	58
Defining User Groups.....	58
User Group - Main.....	58
User Group - Application Services.....	59
User Group - Users.....	59

Defining Access Groups.....	60
Defining Data Access Roles.....	60
Data Access Role - Main.....	60
Data Access Role - Access Group.....	61
Defining Users.....	61
Data Privacy.....	61
The Approach to Implementing Object Erasure.....	61
Cryptography Keys.....	64
Understanding Key Rings.....	64
Defining Key Rings.....	65
User Interface Tools.....	65
Defining Menu Options.....	65
Menu - Main.....	66
Menu - Menu Items.....	67
The Big Picture of System Messages.....	68
Defining System Messages.....	68
The Big Picture of Portals and Zones.....	70
There Are Three Types of Portals.....	70
Common Characteristics of All Portals.....	70
Common Characteristics of Stand-Alone Portals.....	72
Custom Look and Feel Options.....	73
User Interface.....	73
UI Map Help.....	73
Setting Up Portals and Zones.....	74
Defining Zone Types.....	74
Defining Zones.....	75
Defining Context-Sensitive Zones.....	98
Defining Portals.....	99
Defining Display Icons.....	100
Defining Navigation Keys.....	101
Navigation Key Types.....	101
Navigation Key vs. Navigation Option.....	101
The Flexibility of Navigation Keys.....	102
Linking to External Locations.....	102
Overriding Navigation Keys.....	102
Maintaining Navigation Keys.....	102
Defining Navigation Options.....	103
Navigation Option - Main.....	104
Navigation Option - Tree.....	106
Database Tools.....	106
Defining Table Options.....	106
Table - Main.....	106
Table - Table Field.....	108
Table - Constraints.....	109
Table - Referred by Constraints.....	110
Defining Field Options.....	111
Field - Main.....	111
Field - Tables Using Field.....	112
Defining Maintenance Object Options.....	112
Maintenance Object - Main.....	112
Maintenance Object - Options.....	113
Maintenance Object - Algorithms.....	113
Maintenance Object - Maintenance Object Tree.....	115
Defining Valid Values.....	115
Defining Lookup Options.....	116
Defining Extendable Lookups.....	118
The Big Picture Of Audit Trails.....	120
Captured Information.....	120
How Auditing Works.....	120
The Audit Trail File.....	121
How To Enable Auditing.....	121
Audit Queries.....	122
Bundling.....	124
About Bundling.....	124



Configuring Maintenance Objects for Bundling.....	125
Working with Bundles.....	128
Revision Control.....	130
About Revision Control.....	130
Working with the Revision Control Zones.....	131
Working with the Revision Control Portal.....	133
Information Lifecycle Management .....	134
The Approach to Implementing Information Lifecycle Management.....	135
Enabling ILM for Supported Maintenance Objects.....	137
Ongoing ILM Tasks.....	138
Archived Foreign Keys.....	138
Configuration Tools.....	139
Business Objects.....	139
The Big Picture of Business Objects.....	139
Defining Business Objects.....	154
Advanced BO Tips and Techniques.....	161
Defining Status Reasons.....	162
Business Services.....	162
Service Program.....	162
Defining Business Services.....	163
User Interface (UI) Maps.....	167
Defining UI Maps.....	169
Ensuring Unique Element IDs for UI Maps.....	240
Process Flows.....	241
Understanding Process Flows.....	241
Designing Process Flows.....	243
Defining Process Flow Types.....	244
Maintaining Managed Content.....	245
Managed Content - Main.....	245
Managed Content - Schema.....	245
Data Areas.....	245
Defining Data Areas.....	246
Advanced Schema Topics.....	247
Schema Nodes and Attributes.....	247
UI Hint Syntax.....	266
Schema Designer.....	274
Schema Viewer.....	276
Business Event Log.....	276
Miscellaneous Topics.....	277
Module Configuration.....	277
Global Context Overview.....	278
System Data Naming Convention.....	278
Referencing URIs.....	279
Caching Overview.....	281
Expression Parser.....	283
Debug Mode.....	285
System Override Date.....	286
Advanced Search Options.....	286
To Do Lists.....	286
The Big Picture of To Do Lists.....	286
To Do Entries Reference A To Do Type.....	286
To Do Entries Reference A Role.....	287
To Do Entries Can Be Rerouted (Or Suppressed) Based On Message Number.....	288
The Priority Of A To Do Entry.....	288
Working On A To Do Entry.....	289
Monitoring A To Do Entry.....	289
Launching Scripts When A To Do Is Selected.....	289
To Do Entries Have Logs.....	289
How Are To Do Entries Created?.....	290
The Lifecycle Of A To Do Entry.....	292
Linking Additional Information To A To Do Entry.....	293
Implementing Additional To Do Entry Business Rules.....	294
To Do Entries May Be Routed Out Of The System.....	294
Periodically Purging To Do Entries.....	294

Setting Up To Do Options.....	294
Installation Options.....	294
Messages.....	295
Feature Configuration.....	295
Defining To Do Roles.....	296
Defining To Do Types.....	297
List of System To Do Types.....	301
Implementing The To Do Entries.....	301
Background Processes.....	301
Understanding Background Processes.....	301
Background Processing Overview.....	302
Parallel Background Processes.....	303
Parameters Supplied To Background Processes.....	304
Processing Errors.....	307
Error Post-Processing Logic.....	307
Post-Processing Logic.....	307
Timed Batch Processes.....	308
Monitor Background Processes.....	308
Plug-in Driven Background Processes.....	309
How to Re-extract Information.....	313
How to Submit Batch Jobs.....	313
How to Track Batch Jobs.....	313
How to Restart Failed Jobs and Processes.....	314
Assessing Level of Service.....	314
System Background Processes.....	314
Defining Batch Controls.....	314
Batch Control - Algorithms.....	317
On-Line Batch Submission.....	318
Batch Submission Creates a Batch Run.....	318
Jobs Submitted in the Background.....	318
Email Notification.....	318
Running Multi-Threaded Processes.....	319
Batch Jobs May End in Error.....	319
Submitting Jobs in the Future.....	319
Lifecycle of a Batch Job Submission.....	319
Granting Access To Batch Submission.....	320
Batch Job Submission - Main.....	320
Tracking Batch Processes.....	322
Batch Run Tree - Main.....	322
Batch Run Tree - Run Control.....	323
Service Health Check.....	323
The Big Picture of Requests.....	324
Request Type Defines Parameters.....	324
Previewing and Submitting a Request .....	324
To Do Summary Email.....	325
Exploring Request Data Relationships.....	325
Defining a New Request.....	325
Setting Up Request Types.....	326
Maintaining Requests.....	326
Defining Algorithms.....	326
The Big Picture Of Algorithms.....	327
Algorithm Type Versus Algorithm.....	327
How To Add A New Algorithm.....	327
Minimizing The Impact Of Future Upgrades.....	328
Setting Up Algorithm Types.....	328
List of Algorithm Types.....	329
Setting Up Algorithms.....	329
Defining Script Options.....	330
The Big Picture Of Scripts.....	330
Scripts Are Business Process-Oriented.....	330
A Script Is Composed Of Steps.....	331
A Script May Declare Data Areas.....	331
Securing Script Execution.....	331
The Big Picture Of BPA Scripts.....	331

How To Invoke Scripts.....	332
Developing and Debugging Your BPA Scripts.....	332
Launching A Script From A Menu.....	333
Launching A Script When Starting The System.....	333
Executing A Script When A To Do Entry Is Selected.....	334
The Big Picture Of Script Eligibility Rules.....	335
The Big Picture Of Server-Based Scripts.....	339
Additional Coding Options For Server Scripts.....	339
Plug-In Scripts.....	340
Service Scripts.....	342
Groovy Library Scripts.....	342
Debugging Server-Based Scripts.....	343
Maintaining Scripts.....	343
Script - Main.....	343
Script - Step.....	344
Script - Data Area.....	384
Script - Schema.....	385
Script - Eligibility.....	385
Merging Scripts.....	387
Script Merge.....	388
Maintaining Functions.....	390
Function - Main.....	391
Function - Send Fields.....	391
Function - Receive Fields.....	392
Mobile Application.....	393
Understanding Mobile Devices.....	393
Mobile Platform.....	393
Mobile Device Terminals (MDT).....	393
Registration.....	393
Managing Attachments.....	394
Device Data Encryption.....	394
Understanding Mobile Application Files.....	394
Oracle Utilities Mobile Library (OUML).....	395
Business Logic Resides in Mobile Components.....	395
Packaged by a Batch Process.....	396
Testing.....	397
Understanding Deployments.....	399
Deployment Types.....	400
Deployment Parts.....	400
Deployment.....	400
Out of Date Deployments.....	401
Downloading Deployments.....	401
Setting Up Deployments.....	401
Mobile Application Versioning.....	402
Configuring Mobile Devices.....	402
Defining MDT Types.....	402
Defining MDTs.....	403
Configuring Deployment Options.....	403
Defining Deployment Parts.....	404
Defining Deployment Types.....	404
Maintaining Deployments.....	404
Defining Mobile Components.....	405
Mobile Application Master Configuration.....	405
Attachments.....	405
Attachment Overview.....	405
Configuring Your System for Attachments.....	406
Maintaining Attachments.....	408
Adding Attachments.....	408
Application Viewer.....	408
Application Viewer Toolbar.....	408
Data Dictionary Button.....	409
Physical and Logical Buttons.....	409
Collapse Button.....	409
Attributes and Schema Button.....	409

Maintenance Object Button.....	410
Algorithm Button.....	410
Batch Control Button.....	410
To Do Type Button.....	410
Description and Code Buttons.....	410
Service XML Button.....	410
Select Service Button.....	411
Java Docs Button.....	411
Groovy Java Docs Button.....	411
Classic Button.....	411
Preferences Button.....	411
Help Button.....	412
About Button.....	412
Slider Icon.....	412
Data Dictionary.....	412
Using the Data Dictionary List Panel.....	413
Using the Data Dictionary Detail Panel.....	413
Maintenance Object Viewer.....	415
Using the Maintenance Object List Panel.....	415
Using the Maintenance Object Detail Panel.....	415
Algorithm Viewer.....	415
Using the Algorithm Viewer List Panel.....	415
Using the Algorithm Plug-In Spot Detail Panel.....	416
Using the Algorithm Type Detail Panel.....	416
Using the Algorithm Detail Panel.....	416
Batch Control Viewer.....	416
Using the Batch Control Viewer List Panel.....	416
Using the Batch Control Detail Panel.....	416
To Do Type Viewer.....	416
Using the To Do Type Viewer List Panel.....	417
Using the To Do Type Detail Panel.....	417
Service XML Viewer.....	417
Using the Service XML Viewer Overview Panel.....	417
Using the Service XML Viewer Detail Panel.....	417
Java Docs Viewer.....	418
Using the Java Docs Viewer List Panel.....	418
Using the Java Package Detail Panel.....	418
Using the Java Interface / Class Detail Panel.....	418
Groovy Java Docs Viewer.....	419
Application Viewer Preferences.....	419
Application Viewer Stand-Alone Operation.....	419
Stand-Alone Configuration Options.....	419
Example Application Viewer Configuration.....	420
Application Viewer Generation.....	420
Reporting and Analytics Tools.....	421
Reporting Tool Integration.....	421
The Big Picture Of Reports.....	421
Configuring The System To Enable Reports.....	423
Sample Reports Supplied with the Product.....	425
How To Define A New Report.....	426
Measuring Performance.....	429
About Performance Targets.....	429
Setting Up Performance Target Configuration.....	432
Maintaining Performance Targets.....	433
Capturing Statistics.....	433
About Statistics.....	433
Configuring Your System for Statistics.....	434
Creating Cube Views.....	434
About Cube Viewer.....	435
Configuring Cube Types.....	439
External Messages.....	440
Incoming Messages.....	441
Inbound Web Services.....	441
Guaranteed Delivery.....	448

Outgoing Messages.....	448
Outbound Messages.....	449
Web Service Adapters.....	464
Sending Email.....	466
Web Service Category.....	467
Defining Web Service Categories.....	467
JMS Message Browser.....	468
Oracle Integration Cloud Catalog.....	468
Web Service Catalog Configuration.....	469
Mobile Remote Messages.....	470
About Remote Messages.....	470
Maintaining Remote Messages.....	470
XAI Documentation Note.....	471
Integrations.....	471
LDAP Integration.....	471
LDAP Integration Overview.....	471
Configuring LDAP Integration.....	472
Oracle Identity Manager Integration.....	475
Batch Scheduler Integration.....	477
Data Synchronization.....	477
About Data Synchronization.....	478
Maintaining Sync Requests.....	479
Analytics Integration.....	479
About Analytics Integration.....	479
Maintaining Bucket Configurations.....	480
ETL Mapping Control.....	481
Business Flags.....	481
About Business Flags.....	482
Setting Up Business Flag Configuration.....	485
Maintaining Business Flags.....	486
Configuration Migration Assistant (CMA).....	486
Understanding CMA.....	486
The CMA Process Flow.....	487
Migration Assumptions, Restrictions and Recommendations.....	489
CMA Configuration.....	491
Master Configuration - Migration Assistant.....	491
Migration Plans.....	492
Defining a Migration Request.....	495
Wholesale and Targeted Migrations.....	496
Identifying Tables to Exclude From Migrations.....	497
Configuring Custom Objects for Migration.....	497
The CMA Execution Process.....	498
Exporting a Migration.....	499
Importing and Applying a Migration.....	501
Running Batch Jobs.....	517
CMA Reference.....	518
Framework-Provided Migration Configuration.....	518
Configuring Facts.....	520
Fact Is A Generic Entity.....	520
Fact's Business Object Controls Everything.....	521
Fact Supports A Log.....	521
Cloud Service Foundation.....	521
Process Automation Tool.....	521
Creating an Infrastructure Process.....	522
Executing an Infrastructure Process.....	523
Monitoring Infrastructure Process Progress.....	524
Process Automation Tool Setup.....	526
Configuring New Infrastructure Processes.....	527
CMA Migration Infrastructure Process Types.....	528
Integration Configuration (SOA) Infrastructure Process Types.....	530
Data Conversion Support for Cloud Implementations.....	531
Data Conversion Overview.....	531
Configuring Conversion.....	536
Input Data Files.....	540

Conversion Orchestration.....	545
Security Setup for Conversion.....	548
Conversion Reconciliation Reports.....	548
Customer to Meter Administrative User Guide.....	549
Customer to Meter Overview.....	549
Customer to Meter Overview.....	549
Meter Data Management Best Practices.....	550
Performance Recommendations.....	550
Referencing Master Data by Identifiers.....	552
Recommendations for Creating a Production Environment.....	553
Additional Resources.....	553
How to Get Support.....	554
Knowledge Base Articles.....	554
Support Hot Topic Emails.....	554
Embedded Help.....	555
Leveraging Demonstration Data.....	555
Customer User Groups.....	555
Customer To Meter Configuration.....	556
Customer To Meter Master Configuration.....	556
Customer to Meter Consolidated Maintenance and Data Mapping.....	557
Merged Maintenance.....	557
Customer To Meter Master Data Synchronization.....	558
Lookup Value Mapping.....	566
Data Audit Maintenance.....	567
Transactional Data Mapping.....	568
Customer To Meter Table Setup Sequence.....	569
Customer Care and Billing Control Table Setup Sequence.....	569
Meter Data Management Table Setup Sequence.....	585
Operational Device Management Table Setup Sequence.....	587
Customer To Meter Batch Processing.....	588
Batch Process Dependencies.....	588
Defining General Options.....	595
Defining Installation Options.....	595
Installation Options - Main.....	595
Installation Options - Person.....	597
Installation Options - Account.....	597
Installation Options - Billing.....	598
Installation Options - C&C.....	599
Installation Options - Financial Transaction.....	600
Installation Options Framework - Algorithms.....	600
Defining Customer Languages.....	607
Defining Accounting Calendars.....	607
Defining General Ledger Divisions.....	608
Defining Banks & Bank Accounts.....	609
Bank - Main.....	609
Bank - Bank Account.....	609
Defining Issuing Centers.....	609
Actions.....	610
Issuing Center List.....	610
Issuing Center.....	610
Issuing Center Log.....	610
Defining Service Tasks Options.....	610
About Service Tasks.....	610
About Service Task Types.....	611
Defining Service Task Types.....	611
Base Package Service Task Types.....	612
System-wide Options.....	614
Installation Options - Framework.....	614
Configuring Installation Options - Framework.....	614
Feature Configurations.....	615
Configuring Feature Configurations.....	615
Time Zones.....	616
Configuring Time Zones.....	616
Configuring Multi-time Zone Support.....	616

Defining Financial Transaction Options.....	617
The Financial Big Picture.....	617
Bills, Payments & Adjustments.....	617
Bill Details.....	618
Payment Details.....	619
Adjustment Details.....	620
Current Amount versus Payoff Amount.....	621
Financial Transactions Created Between Bills.....	624
Financial Transactions And Aged Debt.....	626
Preventing SA Balances And The GL From Being Impacted Until Bill Completion.....	626
Forcing The Freeze Date To Be Used As The Accounting Date.....	628
How Late Payment Charges Get Calculated.....	629
Service Agreement Type Controls Everything.....	630
Understanding CIS Divisions.....	631
Setting Up CIS Divisions.....	634
Setting Up Revenue Classes.....	635
Setting Up Distribution Codes.....	635
Setting Up Billable Charge Templates.....	636
Designing and Defining Bill Segment Types.....	639
Designing and Defining Deposit Classes.....	644
Setting Up Payment Segment Types.....	648
Designing And Defining Adjustment Types.....	649
Designing and Defining Budget Plans.....	662
The Financial Impact Of Budget Plans.....	662
What Do Budget Plans Do?.....	663
Designing Your Budget Plans.....	663
Setting Up Budget Plans.....	664
Tender Management.....	665
Setting Up Tender Types.....	665
Setting Up Tender Sources.....	666
Automatic Payment Options.....	668
Setting Up Auto Pay Route Types.....	669
Setting Up Auto Pay Source Codes.....	669
SEPA Payments.....	670
Third Party Payment Processing Options.....	672
Define Service Task Types.....	673
Define Auto Pay Sources and Auto Pay Route Types.....	673
Define Tender Cancel Reason.....	673
Third Party Processing DateTime.....	673
Third Party Payment Processing Master Configuration.....	674
Payment Advices.....	674
What Is A Payment Advice?.....	674
Payment Advice vs. Direct Debit.....	674
Setting Up The System To Enable Payment Advices.....	675
Credit Card Payments.....	675
Configuring the System for Tender Authorization.....	675
Non CIS Payments.....	676
Setting Up Payment Templates.....	677
Alternate Currency Payments.....	677
What Is An Alternate Currency Payment?.....	677
Configuring the System for Alternate Currency Payments.....	678
Payment Event Distribution.....	678
Making Payments Using Distribution Rules.....	679
Setting Up The System To Use Distribution Rules.....	679
Cancel Reasons.....	681
Setting Up Bill (Segment) Cancellation Reasons.....	681
Setting Up Payment Cancellation Reasons.....	681
Setting Up Adjustment Cancellation Reasons.....	682
Miscellaneous Financial Controls.....	682
A/P Check Request.....	682
Billable Charge Line Type.....	683
Payables Cash Accounting.....	683
Accrual versus Cash Accounting Example.....	684
Distribution Code Controls Cash Accounting For A GL Account.....	685

Bill Segments and Cash Accounting.....	685
Payment Segments and Cash Accounting.....	686
Write Down Adjustment.....	695
Write-Offs.....	695
Deferred Accrual Accounting.....	696
Deferred Accrual Accounting Examples.....	696
Payment Cancellations and Deferred Accrual Accounting.....	699
Open Item Accounting.....	699
Open-Item Versus Balance-Forward Accounting.....	700
Accounting Method Defined On Your Customer Classes.....	701
Match Events.....	701
Disputing Items.....	706
Pay Plans.....	707
Over Payments.....	708
Setting Up The System To Enable Open Item Accounting.....	709
Setting Up Match Types.....	711
Setting Up Match Event Cancellation Reasons.....	711
Fund Accounting.....	712
Fund Accounting Overview.....	712
Accounting Method Is Defined On The Installation Options.....	715
Fund Controls Fund-Balancing Entries.....	715
Building Fund-Balancing GL Details.....	716
Setting Up The System To Enable Fund Accounting.....	717
Bill Taxation Threshold.....	718
Taxation Threshold Examples.....	718
Billing and Taxation Thresholds.....	720
Setting Up The System For Bill Taxation Thresholds.....	721
Other Financial Transaction Topics.....	723
The Source Of GL Accounts On Financial Transactions.....	723
Defining Customer Options.....	724
Customer Overview.....	725
A Simple Example Of Two Customers.....	725
Persons.....	725
Accounts.....	726
Service Agreements.....	727
Setting Up Person Options.....	728
Setting Up Identifier Types.....	728
Setting Up Person Relationship Types.....	729
Setting Up Contact Routings.....	729
Setting Up Person Contact Status.....	729
Setting Up Person Contact Type Algorithms.....	730
Setting Up Person Contact Types.....	730
Person Contact Type Portal.....	730
Choosing to Use Person Contact or Person Phone.....	731
Person Contact Status Can Be Controlled By A Process.....	731
Maintaining Person Contact via Person Phone.....	733
Setting Up Statement Construct Options.....	734
Setting Up Statement Route Types.....	734
Setting Up Account Options.....	735
Setting Up Account Management Groups.....	735
Setting Up Account Relationship Codes.....	735
Setting Up Alert Types.....	736
Setting Up Bill Messages.....	736
Setting Up Bill Route Types.....	736
Setting Up Bill Cycles.....	737
Setting Up Customer Classes.....	737
Setting Up Collection Classes.....	744
Setting Up Customer Information Options.....	744
Setting Up Customer Contact Options.....	745
Setting Up Customer Contact Classes.....	745
Setting Up Customer Contact Types.....	745
Setting Up Notification Preference Options.....	746
Notification Preferences Overview.....	746
Push vs. Subscription Notification Types.....	747



Parent vs. Individual Push Notification Types.....	747
Delivery Type.....	747
Enabling Opt-In for a Delivery Type .....	748
Some Notification Types Use Service Task.....	748
Designing Notification Types.....	749
Setting Up Notification Type Algorithms.....	750
Setting Up Delivery Types.....	751
Setting Up Notification Types.....	751
Notification Type Portal.....	751
Setting Up the Outbound Message Type.....	752
Setting Up the Message Sender.....	752
Setting Up the External System and Configure the Messages.....	752
Setting Up Notification Preferences Master Configuration.....	752
Other Edge Application Notification.....	752
Setting Up Service Agreement Options.....	752
Setting Up Standard Industry Codes (SIC).....	752
Setting Up Tax Exempt Types.....	753
Setting Up Contract Quantity Types.....	753
SA Type Controls Everything.....	753
Financial Controls.....	753
Setting Up Order Options.....	754
Setting Up Column References.....	754
Setting Up Order Cancellation Reasons.....	754
Setting Up Order Hold Reasons.....	755
Setting Up Order Feature Configurations.....	755
Setting Up Program Management Options.....	755
Designing Initiative Eligibility Criteria.....	755
Designing Related Object Criteria.....	757
Setting Up Lead Event Types.....	758
Overriding Initiative Sign Up Options.....	759
Program Management Master Configuration.....	759
Setting Up Letter Templates.....	759
Defining Service Order Options.....	760
Service Orders.....	760
Service Order Overview.....	760
Understanding Service Order Management.....	761
Supported Service Order Processes.....	762
Defining Disconnect Locations.....	765
Defining Field Activity Profiles and Types.....	765
How Does A Field Activity Type Profile Get Used?.....	765
Designing Field Activity Type Profiles.....	766
Designing Field Activity Types.....	766
Setting Up Field Activity Types.....	766
Field Activity Type - Main.....	766
Field Activity Type - FA Characteristics.....	767
Field Activity Type - FA Completion Control.....	768
Field Activity Type - SP Type Review.....	768
Setting Up Field Activity Type Profiles.....	768
Field Activity Type Profile - Main.....	768
Field Activity Type Profile - Template.....	769
Field Activity Requests Initiated To Start Service.....	769
Field Activity Requests Initiated To Stop Service.....	769
Field Activity Requests Initiated For Back-to-Back Service.....	770
Field Activity Requests Initiated To Cut Service Due To Non-Payment.....	770
Field Activity Requests Initiated To Place A Disconnect Warning At A Service Point.....	770
Field Activity Requests Initiated To Reconnect Service At A Service Point.....	771
Field Activity Requests Initiated To Reread A Meter At A Service Point.....	771
Defining A Profile's Valid Field Activity Types.....	771
Setting Up Fieldwork Cancellation Reasons.....	771
Setting Up Field Activity Remarks.....	772
Defining Outage Call Options.....	772
Outage Call Type List.....	773
Outage Call Type.....	773
Service Order Management External Applications.....	773

Setting Up Service Order Activities.....	774
Understanding Service Order Activities.....	774
Service Order Activity Processing.....	775
Service Order Activity Algorithm Types.....	777
Understanding Service Order Field Activity Types.....	782
Configuring Service Order Activity Types.....	783
Setting Up Service Order Field Activities.....	783
Understanding Service Order Field Activities.....	783
How Do Service Order Field Activities Work?.....	784
Service Order Field Activity Processing.....	785
Service Order Field Activity Communication.....	789
Unrelated Pickup Orders.....	793
Setting Up Service Order Field Activity Types.....	793
Understanding Service Order Field Activity Types.....	793
Configuring Service Order Field Activity Types.....	793
Setting Up Field Task Types.....	794
Understanding Field Task Types.....	794
Configuring Field Task Types.....	795
Defining Credit & Collections Options.....	796
The Big Picture Of Credit & Collections.....	796
Collection Criteria vs. Severance Criteria vs. Write Off Criteria.....	796
The C&C Monitors.....	799
The Big Picture Of Collection Processes.....	801
The Big Picture Of Collection Events.....	808
The Big Picture Of Severance Process Cancellation.....	811
The Big Picture Of Severance Events.....	813
The Big Picture Of Write Off Processing.....	817
The Big Picture Of Write-off Events.....	824
Calendar vs. Work Days.....	827
The Big Picture Of Payment Arrangements and Pay Plans.....	828
Creating Collection, Severance & Write-Off Procedures.....	838
Designing Your Collection Procedures.....	839
Setting Up Collection Procedures.....	845
Designing Your Severance Procedures.....	850
Designing Your Reconnection Procedures.....	853
Setting Up Severance Procedures.....	855
Designing Your Write-Off Procedures.....	857
Setting Up Write-Off Procedures.....	860
Setting Up Feature Configuration.....	865
How To.....	865
How To Nominate A Single Service To Sever (Rather Than Sever Everything That's In Arrears).....	866
Defining Asset Options.....	867
Asset Types.....	867
Understanding Asset Types.....	867
Defining Asset Types.....	867
Service History Types.....	868
Understanding Service History Types.....	868
Defining Service History Types.....	868
Configuration Types.....	869
Understanding Configuration Types.....	869
Defining Configuration Types.....	869
Configurations.....	870
Understanding Configurations.....	870
Defining Configurations.....	870
Configuration Reports.....	870
Understanding Configuration Reports.....	870
Defining Configuration Reports.....	871
Defining Asset Location Options.....	871
Asset Location Types.....	871
Understanding Asset Location Types.....	872
Defining Asset Location Types.....	872
Organization Types.....	872
Understanding Organization Types.....	872
Defining Organization Types.....	873

Organizations.....	873
Understanding Organizations.....	873
Defining Organizations.....	873
Out of Service Location Types.....	874
Understanding Out of Service Location Types.....	874
Defining Out of Service Location Types.....	874
Out of Service Locations.....	874
Understanding Out of Service Locations.....	874
Defining Out of Service Locations.....	875
Defining Device Options.....	875
Command Sets.....	875
Understanding Command Sets.....	875
Configuring Command Sets.....	876
Head End Systems.....	876
Understanding Head End Systems.....	876
Understanding Processing Methods.....	876
Understanding SGG Adapter Configuration.....	878
Configuring Head End Systems.....	879
Manufacturers.....	879
Understanding Manufacturers.....	879
Configuring Manufacturers.....	880
Measuring Component Types.....	880
Understanding Measuring Component Types.....	880
Configuring Measuring Component Types.....	885
Measuring Component Comparison Types.....	885
Understanding Measuring Component Comparison Types.....	885
Configuring Measuring Component Comparison Types.....	886
Device Configuration Types.....	886
Understanding Device Configuration Types.....	886
Configuring Device Types.....	886
Device Types.....	887
Understanding Device Types.....	887
Configuring Device Types.....	888
Defining Device Installation Options.....	888
Service Point Types.....	888
Understanding Service Point Types.....	888
Configuring Service Point Types.....	889
Service Point Quantity Types.....	889
Understanding Service Point Quantity Types.....	889
Configuring Service Point Quantity Types.....	889
Measurement Cycles.....	890
Understanding Measurement Cycles.....	890
Configuring Measurement Cycles.....	890
Measurement Cycle and Bill Determinants.....	890
Measurement Cycle Schedules.....	891
Understanding Measurement Cycle Schedules.....	891
Configuring Measurement Cycle Schedules.....	891
Setting Up Metered Premise Options.....	892
Setting Up Meter Read Instructions.....	892
Setting Up Meter Read Warnings.....	892
Setting Up Consumption Estimation Parameters.....	892
Defining Device Measurement Options.....	893
Units of Measure.....	893
Understanding Units of Measure.....	893
Configuring Units of Measure.....	893
Service Quantity Identifiers.....	893
Understanding Service Quantity Identifiers.....	894
Configuring Service Quantity Identifiers.....	894
Time of Use.....	894
Understanding Time of Use.....	894
Configuring Time of Use.....	894
Service Types.....	895
Understanding Service Types.....	895
Configuring Service Types.....	895

Factors.....	895
Understanding Factors.....	895
Configuring Factors.....	896
Processing Timetable Types.....	896
Understanding Processing Timetable Types.....	896
Configuring Processing Timetable Types.....	897
Initial Measurement Data.....	897
Configuring the Initial Measurement Algorithms.....	897
Configuring Measurement Logging.....	898
Defining VEE Options.....	898
Exception Types.....	899
Understanding Exception Types.....	899
Configuring Exception Types.....	899
VEE Groups.....	899
Understanding VEE Groups.....	899
Configuring VEE Groups.....	900
VEE Rules.....	900
Understanding VEE Rules.....	900
Configuring VEE Rules.....	901
Measuring Component Statistics.....	928
Understanding Measuring Component Statistics.....	928
Configuring Measuring Component Statistics.....	930
Defining Usage Options.....	931
The Big Picture of Usage Requests.....	931
Requesting Bill Determinants.....	931
Usage Request Lifecycle.....	931
Summary Billed Accounts and Usage Requests.....	932
Corrected Read Notifications.....	933
Configuring The System For Usage Request Integration.....	933
Start and End Times for Billing.....	933
The Big Picture of Time of Use Mapping and Pricing.....	933
Mapping to Time of Use (TOU) Periods.....	934
Grouping of TOU Codes for TOU Mapping.....	934
Time of Use (TOU) Mapping and Pricing.....	935
Designing Your Time of Use (TOU) Mapping and Pricing Options.....	937
Setting Up Time of Use (TOU) Mapping and Pricing Control Tables.....	939
Usage Subscription Types.....	940
Understanding Usage Subscription Types.....	941
Configuring Usage Subscription Types.....	941
Integrating Usage Transactions.....	941
Requesting Usage Transactions from External Systems.....	941
Processing and Sending Usage Transactions to External Systems.....	942
Generating Usage Transactions in Oracle Utilities Meter Data Management.....	943
Usage Transaction Exception Types.....	943
Understanding Usage Transaction Exception Types.....	943
Configuring Usage Transaction Exception Types.....	943
Usage Calculation Groups.....	944
Understanding Usage Calculation Groups.....	944
Configuring Usage Calculation Groups.....	944
Usage Calculation Rules.....	944
Understanding Usage Calculation Rules.....	945
Configuring Usage Calculation Rules.....	945
Detailed Configuration Examples.....	958
Usage Calculation Types.....	959
Understanding Usage Calculation Types.....	959
Configuring Usage Calculation Types.....	960
Dynamic Option Types.....	960
Understanding Dynamic Option Types.....	960
Configuring Dynamic Option Types.....	960
Bill Cycle.....	961
Understanding Bill Cycles.....	961
Configuring Bill Cycles.....	961
Defining Time of Use Options.....	961
Time of Use Groups.....	961

Understanding Time of Use Groups.....	962
Configuring Time of Use Groups.....	962
Time of Use Map Templates.....	962
Understanding Time of Use Map Templates.....	962
Configuring Time of Use Map Templates.....	963
Time of Use Map Types.....	964
Understanding Time of Use Map Types.....	964
Configuring Time of Use Map Types.....	965
Defining Premise and Service Point Options.....	965
An Illustration Of A Premise.....	965
Setting Up Premise Options.....	967
Defining Premise Types.....	967
Implementing Address Validation .....	967
Setting Up Generic Service Point Options.....	968
Setting Up Service Point Types.....	968
Setting Up Premise & Service Point Postal Defaults.....	968
Postal Defaults - Main.....	968
Postal Defaults - Service Default.....	969
Designing SP Types.....	969
Service Segmentation.....	970
Device Segmentation.....	970
SA Type Segmentation.....	970
Defining Bill and Measurement Cycles.....	971
Defining Bill and Measurement Cycles.....	971
The Big Picture of Bill Cycles, Measurement Cycles, and Bill Periods.....	971
Bill Cycles.....	975
Designing Bill Periods.....	978
Setting Up Bill Cycles.....	980
Setting Up Service Cycles And Measurement Cycle Schedules.....	980
Setting Up Measurement Cycle Schedules.....	980
Setting Up Bill Periods.....	981
Defining Statement Cycles.....	982
The Big Picture Of Statement Cycles.....	982
Setting Up Statement Cycles.....	983
Defining Service Agreement Type (SA Types).....	983
Designing SA Types For Service Agreements With Service Points.....	984
CIS Division Segmentation.....	984
Service Segmentation.....	984
Receivable Segmentation.....	985
Revenue Segmentation.....	985
Rate Segmentation.....	986
Service Point (SP) Type Segmentation.....	987
Company Usage Segmentation.....	988
Debt Class Segmentation.....	989
Budget Billing Segmentation.....	990
Designing SA Types For SAs Without Service Points.....	991
Overpayment Segmentation.....	991
Write Off Segmentation.....	992
Connection Charge Segmentation.....	993
Charitable Contribution Segmentation.....	994
Payment Arrangement Segmentation.....	995
Merchandise Segmentation - Installment Billing.....	996
Deposit Segmentation - Installment Billing.....	996
Billable Charge Segmentation.....	997
Over/Under Cash Drawer Segmentation.....	999
Payment Upload Error Segmentation.....	999
CIAC Segmentation.....	1000
Loan Segmentation.....	1001
Non-Billed Budget Segmentation.....	1001
Designing SA Type For Other Segmentations.....	1001
Cash Distribution Segmentation.....	1002
Adjustment Profile Segmentation.....	1002
Late Payment Charge Segmentation.....	1002
Debt Classification Segmentation.....	1002

Allow Estimates Segmentation.....	1002
Severance Criteria Segmentation.....	1003
Deposit Class Segmentation.....	1003
Sub SA Types.....	1003
Financial Settlement SA Types.....	1004
Usage Request SA Types.....	1004
Initial Consumption Period Considerations.....	1004
Processing Sequence Considerations.....	1006
Designing Prepayment Billing Options.....	1006
SA Types And The Financial Design.....	1008
Setting Up SA Types.....	1009
SA Type - Main Information.....	1009
SA Type - Detail.....	1011
SA Type - Billing.....	1014
SA Type - Rate.....	1018
SA Type - SP Type.....	1019
SA Type - Adjustment Profiles.....	1020
SA Type - C&C.....	1020
SA Type - Billable Charge Template.....	1021
SA Type - Characteristics.....	1022
SA Type - Algorithms.....	1022
SA Type - Billable Charge Overrides.....	1030
SA Type - Contract Option Type.....	1031
SA Type - NBB Recommendation Rule.....	1031
Setting Up Start Options.....	1031
Start Option Merge.....	1038
Defining SA Relationship Options.....	1040
The Big Picture of SA Relationships and Service Providers.....	1041
Persons and Service Providers.....	1041
Service Providers Are Linked To Service Agreements.....	1042
Service Providers May Change Over Time.....	1043
How To Set Up SA Relationships On A Customer's Service Agreement.....	1044
When Your Company Is A Service Provider.....	1044
Service Providers Have To Communicate About Customers.....	1046
Relationships Between Service Providers.....	1046
A Service Agreement Can Have Many Types Of Relationships.....	1047
Billing Relationships.....	1049
Consumption Relationships.....	1065
Deposits Issues.....	1068
Credit and Collection Issues.....	1069
An Object-Oriented Perspective Of Service Providers.....	1071
How Do You Communicate With Service Providers?.....	1071
Off Cycle Switch.....	1072
Designing Your SA Relationship Types and Service Providers.....	1073
Designing SA Relationship Types.....	1073
Designing Service Providers.....	1074
Designing Your SA Types And Start Options For Sub SAs.....	1080
Reference Send Consumption Algorithm On Master SA Types.....	1082
Reference TBFU Algorithm On Master SA Types.....	1082
Designing SA Types For Service Provider Financial Settlements.....	1082
Setting Up SA Relationship Information.....	1083
Setting Up SA Relationship Types.....	1083
Setting Up Service Providers.....	1083
Setting Up SA Types and Start Options For Sub SAs.....	1085
Setting Up SA Types For Financial Settlements.....	1086
Update Master SA Types With FT Freeze and Bill Completion Algorithms.....	1086
Setting Up SA Relationships For SA Types.....	1086
Negotiated Terms.....	1087
Examples Of Special Discounts.....	1088
Setting Up The System To Enable Negotiated Terms.....	1089
Defining Service Credit Options.....	1091
The Big Picture Of Service Credits.....	1091
Service Credit Membership.....	1091
Designing Your Service Credit Options.....	1094

Designing Your Membership Types.....	1094
Designing Your Service Credit Event Types.....	1097
How Are Service Credit Events Created?.....	1100
Setting Up Service Credit Options.....	1101
Setting Up Credit Units.....	1101
Setting Up SC Membership Inactive Reasons.....	1101
Setting Up Service Credit Membership Types.....	1102
Setting Up Service Credit Event Types.....	1104
Service Credit Examples.....	1104
Defining Control Tables for a Refundable Fee.....	1104
Defining Control Tables for a Nonrefundable Fee.....	1105
Defining an SA Type for Miscellaneous Transactions.....	1106
Using Campaigns/Packages to Set Up Membership.....	1106
Defining Another Person for Your Account.....	1109
Service Credits Earned When Starting Service.....	1112
Service Credits Earned Through Billing.....	1112
Service Credits Redeemed Through Billing.....	1112
Designing Your Rate Options for Capital Credits.....	1113
Partial Retirement.....	1116
Interface Membership Information to a Third Party.....	1116
Defining Loan Options.....	1117
The Terms Of A Loan Are Stored On A Service Agreement.....	1117
Payoff Balance and Current Balance for Loans.....	1117
Booking The Principal Amount Using An Adjustment.....	1118
Loan Amortization Schedule Calculation.....	1119
Billing For Loans And Interest Calculation.....	1119
Paying What Is Owed.....	1121
Overpayments On Loans.....	1122
Adjusting Loan Amounts.....	1124
Writing Off Loans.....	1124
Distribution Codes for Loans.....	1126
Setting Up The System To Enable Loans.....	1126
Distribution Code.....	1127
Adjustment Types.....	1127
Adjustment Type Profile.....	1127
Algorithms.....	1127
Bill Factor.....	1128
Customer Class.....	1128
Bill Segment Type.....	1128
Frequency.....	1128
Bill Period.....	1128
Bill Cycle Schedule.....	1129
Collection, Severance and Write Off Processes.....	1129
SA Type.....	1129
Start Options.....	1131
Defining Non-Billed Budget Options.....	1131
What Is A Non-Billed Budget?.....	1131
The Financial Impact Of Non-Billed Budgets.....	1132
Current Amount For SAs Covered By A Non-Billed Budget.....	1132
Scheduled And Actual Payments On The Non-Billed Budget.....	1133
Overpayments for Non-Billed Budgets.....	1133
Underpayments For Non-Billed Budgets.....	1134
Billing For SAs Covered By The Non-Billed Budget.....	1135
Distributing Non-Billed Budget Credit.....	1136
Stopping an SA Covered By a Non-Billed Budget.....	1137
Financial Transactions For Unmonitored Non-Billed Budgets.....	1138
Distributing Payments for Unmonitored Non-Billed Budgets.....	1139
Transferring Credit from Unmonitored Non-Billed Budgets.....	1140
Designing Non-Billed Budgets.....	1140
Making SAs Eligible For Non-Billed Budgets.....	1140
Designing Recommendation Rules.....	1140
Non-Billed Budget Recommendation Rule.....	1147
Setting Up The System To Enable Non-Billed Budgets.....	1147
NBB Distribution Codes.....	1148

NBB Adjustment Types.....	1148
NBB Adjustment Type Profiles.....	1148
NBB Characteristic Types.....	1149
NBB Customer Contact Class And Types.....	1149
NBB Algorithms.....	1149
NBB Debt Class And Collection Process.....	1150
SA Types for SAs Covered by NBBs.....	1150
NBB Recommendation Rules.....	1151
Non-Billed Budget SA Types.....	1151
NBB Background Processes.....	1153
Defining Quotation Options.....	1153
Setting Up SA Types For Quotes.....	1153
Enabling The Automatic Generation Of Billing Scenarios.....	1153
Enabling The Generation Of Simulated Bill Segments.....	1154
Enabling The Creation Of A Real SA When A Quote Detail Is Accepted.....	1154
Setting Up Quote Route Types.....	1154
Setting Up Terms and Conditions.....	1155
Setting Up Decline Reasons.....	1155
Setting Up Customer Classes For Quotes.....	1155
Defining Case Management Options.....	1155
The Big Picture Of Cases.....	1156
Case Type Controls Everything.....	1156
Scripts and Cases.....	1163
To Do's and Cases.....	1164
Examples of Case Types.....	1166
Setting Up Case Management Options.....	1175
Installation Options.....	1175
Setting Up Application Services.....	1176
Setting Up Scripts.....	1176
Setting Up To Do Types.....	1176
Setting Up Characteristic Types.....	1177
Setting Up Case Types.....	1177
Defining Umbrella Agreement Options.....	1181
The Big Picture Of Umbrella Agreements.....	1182
Renewable Umbrella Agreements.....	1182
Terms Of Service Covered Entities.....	1182
Overriding Rate Terms.....	1183
Setting Up Umbrella Agreement Options.....	1185
Configure SA Types for Umbrella Agreements.....	1185
Configure Bill Factors for Umbrella Agreements.....	1185
Configure A Campaign To Link An SA To A Terms Of Service.....	1185
Setting Up Umbrella Agreement Types.....	1186
Setting Up Terms Of Service Types.....	1187
Setting Up Terms of Service Cancel Reasons.....	1188
Umbrella Agreements Configuration Examples.....	1188
Linking A Service Agreement To A TOS Through Orders.....	1188
Reports Addendum.....	1189
Configuring the System to Invoke Oracle BI Publisher Enterprise Real-Time.....	1189
Specify Reporting Tool Options.....	1189
Reporting Tool Algorithm.....	1190
Interface with Oracle BI Publisher Enterprise Batch Scheduler.....	1190
Configuring the System for Batch Bill Print.....	1190
Configure Oracle BI Publisher for Batch Bill Print.....	1190
Configure Oracle Utilities Customer Care and Billing for Batch Bill Print.....	1190
Description of Sample Reports.....	1191
Active Severance Processes - CI_ACSVPR.....	1191
Bill Print in BI Publisher - CI_BILLPR.....	1192
Billed Revenues by Rate - CI_BILREV.....	1199
Case Statistics By Case Type - CI_CSESTS.....	1200
Case Statistics for a Given Status - CI_CSESGS.....	1200
Collection Summary - CI_CLLSUM.....	1201
Customer Contacts by Type - CI_CUSTCN.....	1201
Customers with Life-Support / Sensitive-Load - CI_PMLSSL.....	1202
GL Accounting Summary - CI_GLACSM.....	1203



Letter Print - BI Publisher Sample Welcome Letters - CI_LTRGN_ENG REPORT.....	1203
Open Cases By Type - CI_CSEOPN.....	1204
Payments Balance - CI_PMTBAL.....	1205
Receivables Aging - CI_RCVAGA.....	1205
Tax Payables Analysis - CI_TXPYBL.....	1206
To Do Entries - CI_TDENTR.....	1207
Umbrella Agreement Summary - CI_UASUMM.....	1207
Unbilled Revenues - CI_UBLREV.....	1208
Defining Overdue Processing Options.....	1209
Case Study - Collecting On Overdue Bills.....	1210
Monitoring Overdue Bills.....	1210
Cutting Service Agreements.....	1212
How Does The Overdue Monitor Work?.....	1214
Different Overdue Rules For Different Customers.....	1214
Overdue Rules Are Embodied In Algorithms.....	1215
When Is An Account Monitored?.....	1215
Collection Class Defines If And How Accounts Are Monitored.....	1216
The Big Picture Of Overdue Processes.....	1216
How Are Overdue Processes Created?.....	1216
The Components Of An Overdue Process.....	1216
Experimenting With Alternative Overdue Process Templates.....	1217
Overdue Process Information Is Overridable.....	1218
Original and Unpaid Amounts.....	1219
Overdue Processes Are Highlighted Elsewhere.....	1219
How Are Overdue Processes Cancelled?.....	1219
Overdue Processes Are Created From Templates.....	1220
The Big Picture Of Overdue Events.....	1220
The Big Picture Of Cut Processes.....	1223
Cut Events Are Like Overdue Events.....	1225
Write Offs Are Implemented Using Overdue Events.....	1226
Calendar vs. Work Days.....	1226
Bill-Oriented Collection - Advanced Topics.....	1227
Miscellaneous Bill-Oriented Collection Topics.....	1227
Writing Off Bills.....	1228
Bill-Oriented Payment Arrangements.....	1231
Creating Overdue and Cut Procedures.....	1234
Designing Your Overdue Procedures.....	1234
Set Up Tasks.....	1240
Setting Up Overdue Processing.....	1244
Defining Prepaid Metering Options.....	1251
The Big Picture of Prepaid Metering.....	1251
How Does Prepaid Metering Work?.....	1251
Debit Meter vs. Credit Meter.....	1251
Prepaid Metering Transactions Result in Adjustments.....	1252
Interfacing Prepaid Transactions.....	1252
Prepaid Transactions Can Go Into Suspense.....	1252
Setting Up The System To Enable Prepaid Metering.....	1252
Meter Types.....	1252
Characteristic Types.....	1253
Algorithms.....	1253
Rate.....	1255
Adjustment Types.....	1255
Adjustment Type Profiles.....	1256
Service Agreement Types.....	1256
Bill Cycle.....	1256
Vendor Information.....	1256
Defining Conservation Program Options.....	1256
The Big Picture of Conservation Programs.....	1256
Conservation Program Maintenance Object.....	1257
Conservation Program Rebate Definition Maintenance Object.....	1257
Rebate Claim Maintenance Object.....	1257
Rebate Claim Line Maintenance Object.....	1258
GL Accounting Example.....	1258
Setting Up Conservation Programs.....	1259

Conservation Program List Zone.....	1259
Conservation Program Zone.....	1260
Rebate Definition Zone.....	1262
Rebate Claim Statistics Zone.....	1263
Defining Market Options.....	1264
Markets.....	1264
Understanding Markets.....	1264
Configuring Markets.....	1264
Market Participants.....	1265
Understanding Market Participants.....	1265
Configuring Market Participants.....	1265
Configuration.....	1265
Configuring Zones.....	1265
Configuring Timeline Zones.....	1266
Configuration Migration Assistant (CMA) Addendum.....	1267
Base Package Migration Plans.....	1267
Base Package Migration Request.....	1267
Wholesale and Piecemeal Migrations.....	1268
Processing Notes for Specific Objects.....	1269
To Do Lists Addendum.....	1269
Assigning A To Do Role.....	1269
System To Do Types.....	1270
Background Processes Addendum.....	1270
How To Set Up A New Extract Processes.....	1270
Choosing Which Records Are Selected.....	1271
The Big Picture of Sample & Submit.....	1272
Security Addendum.....	1275
Implementing Account Security.....	1275
Masking Sensitive Data.....	1283
Encrypting Sensitive Data.....	1283
Data Privacy Addendum.....	1285
Defining Converted COBOL Program Options.....	1290
Converted COBOL Program - Main.....	1290
Advanced Search Options.....	1290
Integration.....	1291
CTI-IVR Integration.....	1291
CTI-IVR Integration Configuration.....	1291
Launching The System From an External Application.....	1291
Receiving the Next Caller in the Queue.....	1291
Initiating an External Call.....	1292
Analytics Integration Overview.....	1293
Analytics Configuration.....	1293
Self-Service Integration.....	1295
About Self-Service Tasks.....	1295
Setting Up Self-Service Task Configuration.....	1296
Maintaining Self-Service Tasks.....	1296
Configuring Rate Compare Usage Adjustment Profiles.....	1296
Defining DataConnect Options.....	1301
DataConnect Data Extracts.....	1301
Master Data Extracts.....	1302
Billing Data Extracts.....	1304
Consumption Data Extracts.....	1307
Extract Flat File Formats.....	1310
Business Flags.....	1310
Understanding Business Flags.....	1310
Business Flag Available Actions.....	1311
Business Flag Can Prevent Bills from Freezing.....	1312
Field Activities Can Determine Business Flag Confidence.....	1312
Configuring Business Flags.....	1312
Business Flags Can Require Analysis.....	1312
Configuring Business Flag Integration.....	1313
A Field Activity Can Determine Business Flag Confidence.....	1313
Business Flags Can Create Alerts.....	1314
Customer Relationship Management Integration.....	1314

About Customer Relationship Requests.....	1314
Setting Up Customer Relationship Request Configuration.....	1315
Maintaining Customer Relationship Requests.....	1315
RightNow Knowledge Integration.....	1316
Displaying Frequently Asked Questions.....	1316
RightNow Knowledge Integration Configuration.....	1316
External Applications.....	1316
Understanding External Applications.....	1316
Configuring External Applications.....	1317
Configuring Master Data Synchronization.....	1317
Oracle Utilities Operational Device Management.....	1317
Overview.....	1317
Configuring Master Data Synchronization.....	1318
Oracle DataRaker.....	1319
Business Flag Integration.....	1319
Usage and Event Integration.....	1320
Oracle Utilities Network Management System.....	1321
Outage Care Integration.....	1322
The Big Picture of Outage Care Integration.....	1322
Customer Information Integration.....	1322
Interfacing Outage Calls.....	1322
Outage Inquiry.....	1322
Setting Up The System To Enable Outage Integration.....	1323
Message Formats.....	1327
Data Import - Message Driven Bean Configuration.....	1327
Overview.....	1327
JMS Configuration.....	1327
Message Driven Bean Configuration.....	1328
Notification Queue Configuration.....	1330
The Conversion Tool.....	1330
Introduction.....	1330
Conversion Tool Steps.....	1332
Map Legacy Data Into Staging Tables.....	1332
Validate Information In The Staging Tables.....	1333
Tidy Balances.....	1336
Balance Control (a).....	1338
Clear FT Balance Control.....	1338
Allocate Production Keys.....	1338
Insert Production Data.....	1341
Run Balance Control Against Production.....	1342
Validate Production.....	1342
The Validation User Interface.....	1342
Validation Error Summary.....	1342
Validation Error Detail.....	1343
FK Validation Summary.....	1343
FK Validation Detail.....	1343
The Staging Tables.....	1344
A Note About Programs in the Table Names Matrices.....	1344
Master Data.....	1345
Transaction Data.....	1358
Program Dependencies.....	1382
Appendix A - Entity Relationship Diagramming Standards.....	1383
Relationships.....	1384
Entity.....	1384
Color Coding.....	1384
Appendix B - Multiple Owners In A Single Database.....	1385
Appendix C - Known Oddities.....	1387
Defining Communication Options.....	1387
Device Event Types.....	1387
Understanding Device Event Types.....	1387
Configuring Device Event Types.....	1389
Activity Types.....	1389
Understanding Activity Types.....	1390
Configuring Activity Types.....	1391

Communication Types.....	1392
Understanding Communication Types.....	1392
Configuring Communication Types.....	1392
Service Task Types.....	1392
Understanding Service Task Types.....	1393
Configuring Service Task Types.....	1393
Defining Data Extract Options.....	1393
Analytics Configuration.....	1393
Consumption Extract Type.....	1394
Understanding Consumption Extract Type.....	1394
Configuring Consumption Extract Type.....	1394
Defining Aggregation Options.....	1395
Standard Aggregation.....	1395
Configuring an Out-of-the-box Aggregation.....	1395
Understanding an Example Out-of-the-box Aggregation.....	1395
Creating a New Custom Aggregation.....	1396
Dynamic Aggregation.....	1397
Dynamic Aggregation Configuration Overview.....	1397
Aggregation Master Configuration.....	1397
Data Sources.....	1397
Dynamic Aggregation Measuring Component Types.....	1399
Aggregation Groups.....	1400
Measuring Component Sets.....	1402
Configuration Step-by-Step.....	1403
Extending Dynamic Aggregation.....	1404
Defining Consumption Synchronization Options.....	1405
Configuring Consumption Synchronization.....	1406
Defining Dashboard Options.....	1409
Configuring the MDM Operational Dashboard.....	1409
Configuring the Customer Operational Dashboard.....	1410
Configuring the Service Order Operational Dashboard.....	1410
Configuring the Service Order Trends Dashboard.....	1410
Defining Measurement Reprocessing Options.....	1411
Configuring Measurement Reprocessing.....	1411
Information Lifecycle Management (ILM).....	1411
Understanding Information Lifecycle Management (ILM).....	1412
Configuring Information Lifecycle Management (ILM).....	1417
Defining Outage Storm Mode Options.....	1420
Configuring Outage Storm Mode.....	1420
Detailed Examples of Outage Storm Mode.....	1421

# Chapter 1

---

## Administrative User Guides

---

### Framework Administrative User Guide

---

The topics in this section describe how to administer the Oracle Utilities Application Framework.

#### Defining General Options

This section describes control tables that are used throughout your product.

#### Defining Installation Options

The topics in this section describe the various installation options that control various aspects of the system.

#### Installation Options - Main

Select **Admin > General > Installation Options - Framework** to define system wide installation options.

##### Description of Page

The **Environment ID** is a unique universal identifier of this instance of the system. When the system is installed, the environment id is populated with a six digit random number. While it is highly unlikely that multiple installs of the system at a given implementation would have the same environment ID, it is the obligation of the implementers to ensure that the environment ID is unique across all installed product environments.

**System Owner** will be **Customer Modification**.

The **Admin Menu Order** controls how the various control tables are grouped on Admin.

- If you choose **Functional**, each control table appears under a menu item that corresponds with its functional area. Note, the [menu](#) that is used when this option is chosen is the one identified with a menu type of **Admin**.

- If you choose **Alphabetical**, each control table appears under a menu item that corresponds with its first letter, using a Roman alphabet. For example, the Language control table will appear under the L menu item entry.

---

**NOTE:** The **Alphabetical** option only supports the Roman alphabet. For languages that do not use the Roman alphabet, the recommendation is to configure the system for the **Functional** setting.

---

**CAUTION:** In order to improve response times, installation options are cached the first time they are used after a web server is started. If you change the Admin Menu Order and you don't want to wait for the cache to rebuild, you must clear the cached information so it will be immediately rebuilt using current information. Refer to [Caching Overview](#) for information on how to clear the system login cache (this is the cache in which installation options are stored).

---

The **Language** should be set to the primary language used by the installation. Note that if multiple languages are supported, each user may define their preferred language.

The **Currency Code** is the default currency code for transactions in the product.

If your product supports effective dated characteristics on any of its objects, define the date to be used as the **Characteristic Default Date** on objects without an implicit start date. The date you enter in this field will default when new characteristics are added to these objects (and the default date can be overridden by the user).

**Active Owner** displays the owner of newly added system data (system data is data like algorithm types, zones, To Do types, etc.). This will be **Customer Modification** unless you are working within a development region.

**Country** and **Time Zone** represent the default country and time zone that should be used throughout the application.

---

**CAUTION:** In most implementations, the time zone defined here matches the database time zone. However, if there is some reason that the database time zone does not match the installation time zone, an implementation may configure a setting in the properties file to automatically convert data from the database time zone to the time zone defined here when displaying dates. Note that when this property setting is defined, changes to the installation time zone will require the server and the thread pool workers to be restarted in order for the changes to take effect.

---

Turn on **Seasonal Time Shift** if your company requires seasonal time shift information to be defined. Note that this is currently only applicable to Oracle Customer Care and Billing > Interval Billing functionality.

## Installation Options - Messages

Select **Admin > General > Installation Options - Framework** and the **Messages** tab to review or enter messages that will appear throughout the application when a given event occurs.

The **Message** collection contains messages that are used in various parts of the system. For each message, define the **Installation Message Type** and **Installation Message Text**. The following table describes the **Message Types** provided by the framework product and how they are used in the system. Your specific product may have introduced addition message types.

Message Type	How The Message Is Used
Company Title for Reports	This message appears as a title line on the <a href="#">sample reports</a> provided with the system. Generally it is your company name. It is only used if you have installed reporting functionality and are using the sample reports (or have designed your reports to use this message).

---

## Installation Options - Algorithms

Select **Admin > General > Installation Options - Framework** and the **Algorithms** tab to review or enter the algorithms that should be evoked when a given event occurs.

The grid contains **Algorithms** that control important functions in the system. You must define the following for each algorithm:

- Specify the **System Event** with which the algorithm is associated (see the table that follows for a description of all possible events).
- Specify the **Sequence Number** and **Algorithm** for each system event. You can set the **Sequence Number** to 10 unless you have a **System Event** that has multiple **Algorithms**. In this case, you need to tell the system the **Sequence** in which they should execute.

---

**CAUTION:** These algorithms are typically significant processes. The absence of an algorithm might prevent the system from operating correctly.

---

The following table describes each **System Event**.

<b>System Event</b>	<b>Optional / Required</b>	<b>Description</b>
<b>Validate Email Attachment</b>	Optional	Algorithms of this type are used to validate the attachments for size and total count while sending attachments using the Email service. Refer to <a href="#">Sending Email</a> for more information  Click <a href="#">here</a> to see the algorithm types available for this system event.
<b>Address Geocoding</b>	Optional	Algorithms of this type use Oracle Locator to retrieve latitude and longitude coordinates using address information.  Click <a href="#">here</a> to see the algorithm types available for this system event.
<b>Global Context</b>	Optional	Algorithms of this type are called whenever the value of one of the global context fields is changed. Algorithms of this type are responsible for populating other global context values based on the new value of the field that was changed.  Refer to <a href="#">Global Context Overview</a> for more information.  Click <a href="#">here</a> to see the algorithm types available for this system event.
<b>Guaranteed Delivery</b>	Optional	Algorithms of this type may be called by processes that receive incoming messages that should 'guarantee delivery'. Refer to <a href="#">Guaranteed Delivery</a> for more information. The business service <b>F1-GuaranteedDelivery</b> may be used to invoke this plug-in spot.  Click <a href="#">here</a> to see the algorithm types available for this system event.
<b>Ldap Import</b>	Optional	Algorithms of this type are called for operations on users, groups, and group memberships after they have been processed.  Click <a href="#">here</a> to see the algorithm types available for this system event.
<b>Ldap Import Preprocess</b>	Optional	Algorithms of this type are called to preprocess data retrieved from LDAP.  Click <a href="#">here</a> to see the algorithm types available for this system event.
<b>Next To Do Assignment</b>	Optional	This type of algorithm is used to find the next <a href="#">To Do entry</a> a user should work on. It is called from the <a href="#">Current To Do</a> dashboard zone when the user ask for the next assignment.  Click <a href="#">here</a> to see the algorithm types available for this system event.

System Event	Optional / Required	Description
Reporting Tool	Optional	<p>If your installation has integrated with a third party reporting tool, you may wish to allow your users to submit reports on-line using <a href="#">report submission</a> or to review <a href="#">report history</a> online. This algorithm is used by the two on-line reporting pages to properly invoke the reporting tool from within the system.</p> <p>Click <a href="#">here</a> to see the algorithm types available for this system event.</p>
SMS Receive	Optional	<p>This type of algorithm is used to provide SMS receive service. Only one algorithm of this type should be plugged in.</p> <p>Click <a href="#">here</a> to see the algorithm types available for this system event.</p>
SMS Send	Optional	<p>This type of algorithm is used to provide SMS send service. If your installation uses the base algorithm that uses BPEL, you will need to create a feature configuration with the SMS Send Configuration feature type to define your Oracle BPEL server and service call details. If your installation has integrated with a third-party SMS service, you may want to override this algorithm type with your own implementation. Only one algorithm of this type should be plugged in.</p> <p>Click <a href="#">here</a> to see the algorithm types available for this system event.</p>
To Do Information	Optional	<p>We use the term To Do information to describe the basic information that appears throughout the system to describe a <a href="#">To Do entry</a>.</p> <p>Plug an algorithm into this spot to override the system default "To Do information".</p> <p>Click <a href="#">here</a> to see the algorithm types available for this system event.</p>
To Do Pre-creation	Optional	<p>These types of algorithms are called when a <a href="#">To Do entry</a> is being added.</p> <p>Click <a href="#">here</a> to see the algorithm types available for this system event.</p>

## Installation Options - Accessible Modules

Select **Admin > General > Installation Options - Framework** and the **Accessible Modules** tab to view the list of accessible modules.

### Description of Page

This page displays the full list of the application's function modules. A **Turned Off** indication appears adjacent to a module that is not accessible based on your system's module configuration setup.

---

**FASTPATH:** Refer to [Module Configuration](#) for more information on function modules and how to turn off modules that are not applicable to your organization.

---

## Installation Options - Installed Products

Select **Admin > General > Installation Options - Framework** and the **Installed Products** tab to view a read only summary of the products that are installed in the application version that you are logged into.

### Description of Page



The **Product Name** indicates the name of the "products" that are installed. The collection should include **Framework**, an entry for your specific product and an entry for **Customer Release**.

**Release ID** shows the current release of the application that is installed. This field is used by the system to ensure that the software that executes on your application server is consistent with the release level of the database. If your implementation of the product has developed implementation-specific transactions, you can populate the Release Id for the **Customer Release** entry to define the latest release of implementation-specific logic that has been applied to this environment. In order for this to work, your implementation team should populate this field as part of their upgrade scripts.

The **Release ID Suffix**, **Build Number** and **Patch Number** further describe the details of your specific product release.

The **Display** column indicates the product whose name and release information should be displayed in the title bar. Only one product sets this value to **Yes**.

**Owner** indicates if this entry is owned by the base package or by your implementation (**Customer Modification**).

**Product Type** indicates if the product is a Parallel Application. A parallel application is one that is independent of, and does not conflict with, other parallel applications. Multiple parallel applications can be installed in the same database and application server.

---

**NOTE: About Information.** The information on this tab is used to populate the information displayed in the [About](#) information for your product.

---

## Support For Different Languages

### User Language

The system provides support for multiple languages in a single environment. System users can use the system in their preferred language, as long as a translation into that language has been provided. A user sees the system in the language defined on their [user record](#). If enabled, users can use the [Switch Language](#) zone to switch to another supported language real time.

---

**NOTE:** Normally, setting up the system for another language is an implementation issue, not an administrative setup issue. However, there are several online administrative features that are used to set up a new language, and these are described here.

---

The following steps are required to support a new language:

- 1. Define a language code and indicate that it is enabled.** For details on this procedure, see [Defining Languages](#).
- 2. Copy descriptions of all language-enabled tables from an existing translation (e.g., English).** The copied values act merely as placeholders while the strings are translated into the new language. It is necessary to do this as a first step in order to create records using the new language code created in the previous step. Language-based descriptions can be copied using a supplied batch process, [FI-LANG](#). The batch copies all English labels in the system.
- 3. Apply the language pack.** If the product supplies a language pack with translations for the system metadata descriptions, follow the instructions provided with the language pack to add the translated text.
- 4. Translate additional content.** Translatable descriptions and labels for implementation data may be updated / entered in the application. First the user record must be updated to reference the new language. This may be done in one of the following ways:
  - a.** Switch to the new language using the [Switch Language](#) zone.
  - b.** If that zone is not available, navigate to the user page, assign the new language code to your User ID, sign out, and sign back in again.

Any online functions that you access will use your new language code. You can change the language code for all users who plan to use/modify the new language.

---

**NOTE:** The language pack updates all language entries for base owned system data. If your implementation updates base owned labels and descriptions prior to applying the language pack, they will be overwritten. Note that most user facing labels and messages support defining an Override Label or Override Description. This information is not updated by the base product and should be utilized if your implementation desires a specific label or description.

---

## Customer Language

Your specific product may also support capturing the language of a customer. Such that correspondence sent from the product may be produced in a language set on a customer record. Refer to your specific product's documentation for more information about additional language support.

## Defining Languages

Your product may support multiple languages. For example, the field labels, input text, and even outputs and reports can be configured to appear in a localized language. A language code for every potential language exists in the system to supply this information in various languages.

Select **Admin > General > Language** to define a language.

### Description of Page

Enter a unique **Language Code**. If you are applying a language pack provided by the product, use the language code designed by the language pack.

Enter the **Description** for the language. Typically this should be the name of the language in that language.

Turn on **Language Enable** if the system should add a row for this language whenever a row is added in another language. For example, if you add a new currency code, the system will create language specific record for each language that has been enabled. You would only enable multiple languages if you have users who work in multiple languages. Languages that are configured as enabled, appear in the [Switch Language](#) dashboard zone. In addition, the login page for the application displays all the languages that are enabled, allowing the user to toggle the login instructions in that language.

---

**NOTE:** The list of enabled languages is captured on the server at startup time. If a new language is enabled, contact your server administrator to refresh the server in order to see the new language displayed in the login page.

---

The following two fields control how the contents of grids and search results are sorted by the Java virtual machine (JVM) on your web server:

- The **Locale** is a string containing three portions:
  - ISO language code (lower case, required)
  - ISO country code (upper case, optional)
  - Variant (optional).
- Underscores separate the various portions, and the variant can include further underscores to designate multiple variants. The specific JVM in use by your particular hardware/OS configuration constrains the available **Locales**. Validating the **Locale** against the JVM is outside the scope of this transaction. This means you are responsible for choosing valid **Locales**.

The following are examples of valid locales:

Locale	Comments
en_US	American English

Locale	Comments
en_AU	Australian English
pt_BR	Brazilian Portuguese
fr_FR_EURO	European French
ja_JP	Japanese

In addition, the Java collation API can take a **Collator Strength** parameter. This parameter controls whether, for example, upper and lower-case characters are considered equivalent, or how accented characters are sorted. Valid values for collator strength are **PRIMARY**, **SECONDARY**, **TERTIARY**, and **IDENTICAL**. If you leave this field blank, Java will use its default value for the language. We'd like to stress that the impact of each value depends on the language.

Please see <https://docs.oracle.com/javase/7/docs/api/java/text/Collator.html> for more information about the collator strength for your language.

**Display Order** indicates if this language is written **Left to Right** or **Right to Left**.

**Owner** indicates if this language is owned by the base package or by your implementation (**Customer Modification**). The system sets the owner to **Customer Modification** when you add a language. This information is display-only.

### Where Used

Follow this link to open the data dictionary where you can view the tables that reference [CI\\_LANGUAGE](#).

Note that all administrative control tables and system metadata that contain language-specific columns (e.g., a description) reference a language code.

In addition, other tables may reference the language as a specific column. For example, on the User record you indicate the preferred language of the user.

## Defining Countries

The topics in this section describe how to maintain countries.

### Country - Main

To add or review Country definitions choose **Admin > General > Country**.

The **Main** page is used to customize the fields and field descriptions that will be displayed everywhere addresses are used in the system. This ensures that the all addresses conform to the customary address format and conventions of the particular country you have defined.

#### Description of Page

Enter a unique **Country** and **Description** for the country.

The address fields that appear in the **Main** page are localization options that are used to customize address formats so that they conform to address requirements around the world. By indicating that an address field is **Optional**, you make that field available everywhere addresses for this country are used in the system. You can enter your own descriptions for the labels. These labels will appear wherever addresses are maintained in the system.

---

**NOTE:** Your specific product may also add the ability to mark an address field as **Required**. If that is available, then the product is also supplying appropriate validation in all places where a user defines an address.

---

**NOTE:** For any country where the **State** is enabled, the valid states for the country must be entered on the **Country - State** tab. When entering address constituents on a record that captures this detail, the value for State is verified against the data in the State table. For any country where there is a component of the address that represents a "state" but your implementation does not want to populate the valid states for that country, choose a different field such as County for

this constituent (and define an appropriate label). When entering address constituents on a record that captures this detail, no validation is done for the County column.

---

### Where Used

Follow this link to open the data dictionary where you can view the tables that reference [CI\\_COUNTRY](#).

## Country - States

To maintain the states located in a country, choose **Admin > Country > Search** and navigate to the **State** page.

### Description of Page

For any country where you have enabled the State switch, use the **State** collection to define the valid states in the **Country**.

- Enter the standard postal abbreviation for the **State** or province.
- Enter a **Description** for this state or province.

## Defining Currency Codes

The currency page allows you to define display options related to currency codes that are used by your system. Use **Admin > General > Currency** to define the currency codes in which financial information is denominated.

### Description of Page

Enter a unique **Currency** and **Description** for the currency.

Use Currency **Symbol** to define the character that prefixes currency amounts in the system (e.g., \$ for U.S. dollars).

Enter the number of **Decimals** that will appear in the notation for the currency.

---

**NOTE:** Please contact your specific product to verify whether it supports a currency with more than 2 decimals.

---

The **Currency Position** indicates whether the currency symbol should be displayed as a **Prefix** or a **Suffix** to the currency amount.

### Where Used

Follow this link to open the data dictionary where you can view the tables that reference [CI\\_CURRENCY\\_CD](#).

## Defining Time Zones

The following topics describe how to design and set up time zones.

## Designing Time Zones

---

**NOTE:** Oracle Utilities Customer Care and Billing - Interval Billing applications customers should consult the topic *Time Issues* (search the Help index for "time issues") for specific information relating to that product's interval billing time related functionality.

---

It is recommended that all time sensitive data is stored in the standard time (also called 'physical time') of the base time zone as defined on the installation options. This will prevent any confusion when analyzing data and will ensure that your algorithms do not have to perform any shifting of data that may be stored in different time zones.

The Time Zone entity is used to define all the time zones where your customers may operate. Each time zone should define an appropriate Time Zone Name. This is a reference to an external source that defines time zones, their relationship to Greenwich Mean Time, whether the time zone follows any shifting for summer / winter time (daylight savings time) and when this shift occurs.

When designing your time zones, the first thing to determine is the base time zone. You may choose the time zone where the company's main office resides. Once this is done you can link the time zone code to the installation option as the base time zone. Refer to [Installation Options - Main](#) for more information.

---

**NOTE:** An attribute in the system properties file may be configured to indicate that the DB session time zone should be synchronized with the value defined on the Installation Options. Refer to the *Server Administration Guide* for more information.

---

If your company does business beyond your main office's time zone, define the other time zones where you may have customers or other systems with which you exchange data. At this point, your specific product may include configuration tables to capture default time zones, for example based on a postal code or geographic location.

---

**NOTE: Date and time in business object schemas.** When defining date / time fields in a BO schema, schema attributes can be used to define whether or not data should be stored in standard time for the base time zone or if it should be stored in the standard time of another time zone (related to the data). In addition, schema attributes can be used to indicate if the display of the time should be shifted to represent the "local time". This is used to adjust for seasonal time differences. For example, if the data is stored in the appropriate time zone, but currently daylight savings time is being observed, the data will be shifted and shown in the "local" time. In addition, if the data is stored in the base time zone but the data is related to a different time zone, the data will be shown in the time zone appropriate for the data (including the appropriate seasonal adjustment). Refer to [Schema Nodes and Attributes- Standard Time Considerations](#) for more information.

---

## Setting Up Time Zones

Refer to [Designing Time Zones](#) for background information about defining time zones.

Open **Admin > General > Time Zone > Search** to define the time zones and their relation to the base time.

### Description of Page

Enter a unique **Time Zone** and **Description** for the time zone.

Select the **Time Zone Name** from the list of Olson time zone values. This value is a reference to an external definition that allows the system to know how the time zone relates to Greenwich Mean Time and information about whether the time zone shifts for summer / winter time and when.

Indicate the **Shift in Minutes** that this time zone differs from the base time zone defined on the Installation Options. This is only applicable for the *Oracle Utility Customer Care and Billing - Interval Billing* application.

Indicate the **Seasonal Time Shift** applicable for this time zone. This is only applicable for the *Oracle Utility Customer Care and Billing - Interval Billing* application.

**Default Time Zone Label** and **Shifted Time Zone Label** are used for data that is sensitive to time zones and time shifting. It indicates whether the data displayed or data to be input is related to the "standard" time or the "shifted" time. For example, on a day when clocks are turned back one hour, a time entry of 1:30 a.m. needs to be labeled as either 1:30 a.m. standard time or 1:30 a.m. daylight savings time.

### Where Used

Follow this link to open the data dictionary where you can view the tables that reference [CI\\_TIME\\_ZONE](#).

## Setting Up Seasonal Time Shift

---

**NOTE:** The information in this topic applies only to Oracle Utilities Customer Care and Billing - Interval Billing applications.

---

Open **Admin > General > Seasonal Time Shift > Search** to define the seasonal time shift schedule.

### Description of Page

Enter a unique **Seasonal Time Shift** code and **Description** for the seasonal time shift.

The Collection defines the **Effective Date/Time** (in standard time) that a time zone may shift in and out of standard time. If time is changed from standard time on the effective date/time, enter the **Shift in Minutes** that the time changes from standard time (usually **60**). If the time is changed back to standard time on the effective date/time, enter a **Shift in Minutes** of **0**.

### Where Used

Follow this link to open the data dictionary where you can view the tables that reference [CL\\_SEAS\\_TM\\_SHIFT](#).

## Defining Geographic Types

If your company uses geographic coordinates for dispatching or geographic information system integration, you need to setup a geographic (coordinate) type for each type of geographic coordinate you capture on your premises and/or service points (geographic coordinates can be defined on both premises and service points).

To define geographic types, open **Admin > Geographic > Geographic Type**.

---

**NOTE: Product specific.** There is no framework functionality that uses this information. Refer to your specific product documentation to verify how this table is used in your specific product. In addition, use the data dictionary link below to determine if this object is a foreign key on any tables specific to your product.

---

### Description of Page

Enter an easily recognizable **Geographic Type** code and **Description**.

Define the algorithm used to validate the **Validation Format Algorithm**. If an algorithm is specified, the system will validate that the geographic location entered on the premise and/or service point for the geographic type is in the format as defined in the algorithm. If you require validation, you must set up this [algorithm](#) in the system.

Click [here](#) to see the algorithm types available for this plug-in spot.

### Where Used

Follow this link to open the data dictionary where you can view the tables that reference [CL\\_GEO\\_TYPE](#).

## Defining Work Calendar

Workday calendars are used to ensure system-calculated dates fall on a workday. Select **Admin > General > Work Calendar > Search** to define a workday calendar.

### Description of Page

The information on this transaction is used to define the days of the week on which your organization works.

Enter a unique **Work Calendar** and **Description**.

Turn on (check) the days of the week that are considered normal business days for your organization.

Use the collection to define the **Holiday Date**, **Holiday Start Date**, **Holiday End Date**, and **Holiday Name** for each company holiday. Holiday Start Date and Holiday End Date define the date and time that the holiday begins and ends. For example, your organization might begin a holiday at 5:00 p.m. on the day before the actual holiday.

### Where Used

Follow this link to open the data dictionary where you can view the tables that reference [CI\\_CAL\\_WORK](#).

## Defining Display Profiles

When you set up your [users](#), you reference a display profile. A user's display profile controls how dates, times, and numbers displayed. Choose **Admin > General > Display Profile > Search** to maintain display profiles.

### Description of Page

Enter a unique **Display Profile ID** and **Description** to identify the profile.

Enter a **Date Format**. This affects how users view dates and how entered dates are parsed. The following table highlights standard supported date mnemonics and what is displayed at runtime.

Mnemonic	Comments
dd	Day of the month.
d	Day of the month, suppressing the leading 0.
MM	Month number.
M	Month number, suppressing the leading 0.
yyyy	The 4-digit year.
yy	The 2-digit year.
y	Allows entry in either 2 or 4-digit form and is displayed in 2-digit form.

Other characters are displayed as entered. Typically, these other characters should be separators, such as "-", ".", or "/". Separators are optional; a blank space cannot be use.

Examples:

Configuration Format	Sample Output
MM-dd-yyyy	04-09-2001
d/M/yyyy	9/4/2001
yy.MM.dd	01.04.09
MM-dd-y	04-09-01 - In this case you could also enter the date as 04-09-2001

**NOTE:** For centuries, the default pivot for 2-digit years is **80**. Entry of a 2-digit year greater than or equal to **80** results in the year being interpreted as 19xx. Entry of a 2-digit year less than **80** results in the year being interpreted as 20xx.

In addition, the following date localization functionality is supported. Note that in every case, the date is stored in the database using the Gregorian format. The settings below result in a conversion of the date for the user interface.

- **Hijri Dates**

Entering **iiii** for the year is interpreted as a year entered and displayed in Hijri format. For example, the Gregorian date 2014–05–30 may be entered / displayed as 1435/07/30 for a user whose display profile date format is **iiii/MM/dd**. Note that this functionality relies on date mapping to be defined in the Hijri to Gregorian Date Mapping [master configuration](#). entry. Refer to [Additional Hijri Date Configuration](#) for more information.

- **Taiwanese Dates**

Entering **tttt** for the year is interpreted as a year entered and displayed in Taiwanese format where year 1911 is considered year 0000. For example, if the Gregorian date is 01-01-2005, it is displayed as 01-01-0094 for a user whose display profile date format is **dd-mm-tttt**.

- **Japanese Dates**

There are two options available for configuring Japanese Era date support. The setting **Gyy** for the year is interpreted as a year entered and displayed using an English character for the era followed by the era number. The letter 'T' is used for dates that fall within the *Taisho* era. The letter 'S' is used for dates that fall within the *Showa* era and the letter 'H' is used for dates that fall within the *Heisei* era. For example, for a user whose display profile date format is **Gyy/mm/dd** the Gregorian date 2008/01/01 is shown as **H20/01/01**; the Gregorian date 1986/03/15 is shown as **S61/03/15**. The setting **GGGGyy** is interpreted as a year entered and displayed using Japanese characters for the era followed by the era number.

Japanese date limitations are as follows:

- The years 1912 through the current date are supported.
- Any functionality that displays Month and Year does not support Japanese Era dates. These dates are shown in Gregorian format.
- Graphs that display dates do not support the **GGGGyy** format.

Enter a **Time Format**. The following table highlights standard supported date mnemonics.

Mnemonic	Comments
hh	The hour 1-12.
h	The hour 1-12, suppressing the leading 0.
HH	The hour 0-23.
H	The hour 0-23, suppressing the leading 0.
KK	The hour 0-11.
K	The hour 0-11, suppressing the leading 0.
kk	The hour 1-24.
k	The hour 1-24, suppressing the leading 0.
mm	Minutes.
m	Minutes, suppressing the leading 0.
ss	Seconds.
s	Seconds, suppressing the leading 0.
a	Indicates to include <b>am</b> or <b>pm</b> . This is only needed for 12 hour formats, not 24 hour formats. ( <b>hh</b> , <b>h</b> , <b>KK</b> , <b>K</b> ). If an <b>am</b> or <b>pm</b> is not entered, it defaults to <b>am</b> .

Examples:

Configuration Format	Sample Output
hh:mma	09:34PM (can be entered as 09:34p)
hh:mm:ss	21:34:00
h:m:s	9:34:0

There are several options for displaying Numbers.

**Decimal Symbol** defines the separator between the integer and decimal parts of a number. Valid values are "." (a period) or "," (a comma).

**Group Symbol** defines the means to separate groups of bigger numbers. Valid values are as follows:

- A comma (","). Large numbers group by threes separated by a comma, for example 1,000,000.
- A period ("."). Large numbers group by threes separated by a period, for example 1.000.000.
- **None**. Large numbers do not have any separator, for example 1000000.
- **South Asian**. This option uses a comma for its separator but will group large numbers as follows: the first comma is used for the thousands separation and numbers over 9,999 are grouped with 2 units, for example 10,00,000.
- **Space**. Large numbers group by threes separated by a space, for example 1 000 000.



**Negative Format** defines how negative values are displayed. Valid values are **-9.9**, **(9.9)**, or **9.9-**.

**Currency** values can have a different **Negative Format** from other numbers. Valid values are **-S9.9**, **(S9.9)**, or **S9.9-**, where the "S" represents the currency symbol.

#### Where Used

Follow this link to open the data dictionary where you can view the tables that reference [CI\\_DISP\\_PROF](#).

## Additional Hijri Date Configuration

For implementations that wish to support displaying dates according to the Hijri calendar, besides appropriate configuration in the [Display Profile](#), the mapping between the Hijri dates and the Gregorian dates must be entered. This mapping is defined in the [Hijri to Gregorian Date Mappingmaster configuration](#) record.

The mapping record contains a collection of entries for each year in the Islamic calendar.

For each year, clicking the Expand Zone icon shows the mapping collection with the first date of each month of the Hijri calendar. The corresponding date in the Gregorian calendar should be entered for each row.

## Defining Phone Types

Phone types define the format for entering and displaying phone numbers.

To add or review phone types, choose **Admin > General > Phone Type**.

#### Description of Page

Enter a unique **Phone Type** and **Description** for each type of phone number you support.

Select an appropriate **Phone Number Format Algorithm** for each **Phone Type**. This algorithm controls the format for entry and display of phone numbers. Click [here](#) to see the algorithm types available for this plug-in spot.

Use **Phone Type Flag** to define if this type of phone number is a **Fax** number. Defining which phone type is used for facsimile transmittal is only pertinent if your product supports routing of information via fax. For example, in Oracle Utilities Customer Care and Billing, the system may be configured to fax a bill to a customer.

#### Where Used

Follow this link to open the data dictionary where you can view the tables that reference [CI\\_PHONE\\_TYPE](#).

## Setting Up Characteristic Types & Values

Many objects in the system support a collection of Characteristics, which are used to capture additional fields for the object that are not already supported by the object's provided attributes. Each characteristic is associated with a characteristic type, which defines attributes of the field you wish to capture.

All characteristics are captured as a list. However, the user interface for characteristics differ based on the type of page that is used to maintain the object.

- For portal based pages the business object drives the display and maintenance of an object. For these types of pages, it is recommended that characteristics are defined as part of the business object schema allowing the user interface to display the characteristic as if it is another field. However, the display / maintenance of the characteristic is determined by the business object's user interface design.
- There are some fixed pages in the system that do not support customization of the user interface. For these objects, the characteristics are displayed / maintained as a generic list.

The topics in this section describe how to setup a characteristic type.

## There Are Four Types Of Characteristics

Every characteristic referenced on an object references a characteristic type. The characteristic type controls the validity of the information entered by a user when they enter the characteristic's values. For example, if you have a characteristic type on user called "skills", the information you setup on this characteristic type controls the valid values that may be specified by a user when defining another user's skills.

When you setup a characteristic type, you must classify it as one of the following categories:

- **Predefined value.** When you setup a characteristic of this type, you define the individual valid values that may be entered by a user. A good example of such a characteristic type would be one on User to define one or more predefined skills for that user. The valid values for this characteristic type would be defined in a discreet list.
- **Ad hoc value.** Characteristics of this type do not have their valid values defined in a discreet list because the possible values are infinite. Good examples of such a characteristic type would be ones used to define a user's birth date or their mother's maiden name. Optionally, you can plug-in an algorithm on such a characteristic type to validate the value entered by the user. For example, you can plug-in an algorithm on a characteristic type to ensure the value entered is a date.
- **Foreign key value.** Characteristics of this type have their valid values defined in another table. For example perhaps you want to link a user to a table where User is not already a foreign key. Valid values for this type of characteristic would be defined on the user table. Please be aware of the following in respect of characteristics of this type:
  - Before you can create a characteristic of this type, information about the table that contains the valid values must be defined on the [foreign key reference table](#).
  - The referenced table does not have to be a table within the system.
  - Not all entities that support characteristics support foreign key characteristics. Refer to the data dictionary to identify the entities that include the foreign key characteristic columns.
  - As described in [Search Options](#), there are two different searching metaphors supported on FK reference. If the object that a characteristic is being linked to is defined on a fixed page, it will display a search icon if the characteristic type's FK reference defines a navigation key based search. If the object is maintained on a portal based page, it will display a search icon if the characteristic type's FK reference defines a search zone.
- **File Location.** Characteristics of this type contain a URL. The URL can point to a file or any web site. Characteristics of this type might be useful to hold references to documentation / images associated with a given entity. For example, the image of a letter sent to you by one of your customers could be referenced as a file location characteristic on a customer contact entry. When such a characteristic is defined on an entity, a button can be used to open the URL in a separate browser window.

File location characteristic values must be entered in a "non-relative" format. For example, if you want to define a characteristic value of *www.msn.com*, enter the characteristic value as `http://www.msn.com`. If you omit the `http://` prefix, the system will suffix the characteristic value to the current URL in your browser and attempt to navigate to this location when the launch button is pressed. This may or may not be the desired result.

---

**NOTE:**

Due to browser security restrictions, opening URLs using the file protocol ("file:///") from pages retrieved using http does not work. If the file protocol is used, the browser either does not return properly or an error is thrown (e.g., "Access Denied", which usually results from cross site scripting features added for security reasons). This issue has no known workaround. To comply with browser security standards, the recommendation is to move the target files to an FTP or HTTP server location to avoid protocols that are subject to browser security restrictions.

Also note that the functionality described in the topics for [Referencing URIs](#) do not apply to this value given that the browser is responsible for connecting to the URI and does not go via server logic.

---

For references to a file, the recommendation is to use the Attachment functionality to link a file to an object rather than a characteristic type of File Location. Refer to [Attachment Overview](#) for more information. The documentation related to file location remains for upgrade purposes.

## Searching By Characteristic Values

For certain entities in the system that have characteristics, you may search for a record linked to a given characteristic value. The search may be done in one of the following ways:

- Some base searches provide an option to search for an object by entering Characteristic Type and Characteristic Value.
- Your implementation may define a customized search for an entity by a characteristic value for a specific characteristic type using a query data explorer.
- Your implementation may require a business service to find a record via a given characteristic value. For example, maybe an upload of user information attempts to find the user via an Employee ID, defined as a characteristic.

Not all entities that support characteristics support searching by characteristics. Refer to the data dictionary to identify the characteristic collections that include the search characteristic column.

---

**CAUTION:** For ad-hoc characteristics, only the first 50 bytes are searchable. For foreign key characteristics, the search value is populated by concatenating the values of each foreign key column to a maximum of 50 bytes.

---

For the base searches that provide a generic option to search by characteristic type and value, you can restrict the characteristic types that can be used to search for an entity. For example, imagine you use a characteristic to define a "jurisdiction" associated with a To Do for reporting purposes. If your company operates within a very small number of jurisdictions, you wouldn't want to allow searching for a To Do by jurisdiction, as a large number of To Do entries would be returned.

A flag on the [characteristic type](#) allows an administrator to indicate if searching by this characteristic type is **allowed** or **not allowed**.

## Characteristic Type - Main

To define a characteristic type, open **Admin > General > Characteristic Type**.

### Description of Page

Enter an easily recognizable **Characteristic Type** and **Description** for the characteristic type. **Owner** indicates if this characteristic type is owned by the base package or by your implementation (**Customer Modification**).

---

**CAUTION:** Important! If you introduce a new characteristic type, carefully consider its naming convention. Refer to [System Data Naming Convention](#) for more information.

---

Use **Type of Char Value** to classify this characteristic type using one of the following options (refer to [There Are Four Types Of Characteristics](#) for more information):

- **Predefined value.** Characteristics of this type have their valid values defined in the **Characteristic Value** scroll, below. For each valid value, enter an easily recognizable **Characteristic Value** and **Description**.
- **Ad hoc value.** Characteristics of this type capture free form text. If you use this option, you can optionally define the **Validation Rule** used to validate the user-entered characteristic value. Click [here](#) to see the algorithm types available for this plug-in spot.
- **File location value.** Characteristics of this type contain a URI. The URI can point to a file or any web site. Refer to [There Are Four Types Of Characteristics](#) for limitations associated with this type of characteristic value.

- **Foreign key reference.** Characteristics of this type have their valid values defined in another table. If you choose this option, you must use **FK Reference** to define the table that controls the valid values of this characteristic type. Refer to [Setting Up Foreign Key References](#) for more information.

Use the **Allow Search by Char Val** to indicate if searching for an entity by this characteristic type is **Allowed** or **Not Allowed**. Refer to [Searching by Characteristic Values](#) for more information.

The **Custom** switch is only applicable to **Predefined value** types. It indicates whether or not an implementation is allowed to add values for a characteristic type whose owner is not **Customer Modification**

- If this switch is turned on, an implementation may add characteristic values to the grid for system owned characteristic types.
- If this switch is turned off, an implementation may not add characteristic values to the grid for system owned characteristic types.

---

**NOTE:** Regardless of the value of the Custom switch, an implementation may not update or remove system owned characteristic values.

---

The **Characteristic Value** grid defines the valid values for a **Predefined value** type of characteristic.

The **Characteristic Value** is the unique identifier of the value.

**Description** is the text that is visible in the dropdowns and display when viewing this characteristic value.

**Owner** indicates if this characteristic value is owned by the system or by your implementation (**Customer Modification**). The system sets the owner to **Customer Modification** when you add characteristic values to a characteristic type. This information is display-only.

#### Where Used

Follow this link to open the data dictionary where you can view the tables that reference [CI\\_CHAR\\_TYPE](#) in the data dictionary schema viewer.

## Characteristic Type - Characteristic Entities

To define the entities (objects) on which a given characteristic type can be defined, open **Admin > General > Characteristic Type** and navigate to the **Characteristic Entities** tab.

#### Description of Page

Use the **Characteristic Entity** collection to define the entities on which the characteristic type can be used. **Owner** indicates if this is owned by the base package or by your implementation (**Customer Modification**).

---

**NOTE:** The values for this field are customizable using the Lookup table. This field name is **CHAR\_ENTITY\_FLG**.

---

**NOTE:** For some entities in the system, the valid characteristics for a record are defined on a related "type" entity. For example, the To Do type defines valid characteristics for manually created To Do entries of that type. When configuring your system, in addition to defining the appropriate entity for a characteristic type, you may also need to link the characteristic type to an appropriate entity "type". This technique is typically not followed for business object driven maintenance objects, where the business objects can be configured with the appropriate "flattened" characteristic types in the schema.

---

## Setting Up Foreign Key Reference Information

A Foreign Key Reference defines the necessary information needed to reference an entity in certain table.

You need to set up this control table if you need to validate a foreign key value against a corresponding table. For example, if a schema element is associated with an FK Reference the system validates the element's value against the corresponding

table. Refer to [Configuration Tools](#) to learn more about schema-based objects. Another example is characteristics whose valid values are defined in another table (i.e., you use "foreign key reference" characteristic types). Refer to [There Are Four Types Of Characteristics](#) for a description of characteristics of this type.

A FK Reference is used not just for validation purposes. It also used to display the standard information description of the reference entity as well as provide navigation information to its maintenance transaction. Info descriptions appear throughout the UI, for example, whenever an account is displayed on a page, a description of the account appears. The product provides base product FK references for many of its entities as they are used for validation and display of elements in both fixed page user interfaces as well as portal based user interfaces.

An implementation may also see the need to define a foreign key reference. The following points describe what you should know before you can setup a foreign key reference for a table.

- The physical name of the table. Typically this is the primary table of a maintenance object.
- The program used by default to construct the referenced entity's info description. Refer to [Information Description Is Dynamically Derived](#) for more information on how this is used.
- The transaction used to maintain the referenced entity. This is where the user navigates to when using the "go to" button or hyperlink associated with the entity. Refer to [Navigation Information Is Dynamically Derived](#) for more information on how this is used.
- The name of the search page used to look for a valid entity. Refer to [Search Options](#) for more information.

## Information Description Is Dynamically Derived

Typically a FK Reference is defined for a maintenance object's primary table. In this case the system dynamically derives the standard information associated with a specific referenced entity as follows:

- Attempt to determine the business object associated with the referenced entity. Refer to the [Determine BO](#) maintenance object algorithm system event for more information. If a business object has been determined, the system lets the business object's [Information](#) plug-in, if any, format the description.
- If a business object has not been determined or the business object has no such plug-in, the system lets the maintenance object's [information](#) plug-in, if any, format the description.
- If the maintenance object has no such plug-in, the system uses the info program specified on the FK Reference to format the information.

---

**NOTE: Technical note.** The class that returns the information displayed adjacent to the referenced entity is generated specifically for use as an info routine. Please speak to your support group if you need to generate such a class.

---

**NOTE: Generic routine.** The system provides a generic information routine that returns the description of control table objects from its associated language table. By "control table" we mean a table with an associated language table that contains a **DESCR** field. Refer to [Defining Table Options](#) for more information on tables and fields. The java class is `com.splwg.base.domain.common.foreignKeyReference.DescriptionRetriever`.

---

## Navigation Information Is Dynamically Derived

Typically a FK Reference is defined for a maintenance object's primary table. In this case the system dynamically derives the actual transaction to navigate to for a given referenced entity as follows:

- Attempt to determine the business object associated with the referenced entity. Refer to the [Determine BO](#) maintenance object algorithm system event for more information. If a business object has been determined, use the maintenance portal defined as its **Portal Navigation Option** business object option.
- If a business object has not been determined or the business object defines no such option, the system uses the transaction specified on the FK Reference.

## Search Options

The product provides two main metaphors for implementing a user interface. For input fields that are foreign keys, search options are dependent on the metaphor used by the page in question.

- A [portal based](#) user interface is a more flexible user interface where an implementation has more options for customizing the look and feel. The base product uses UI maps or automatic UI rendering to display input fields. Elements that are foreign keys may display a search icon if the FK reference defines a Search Zone.

---

**NOTE: Defining search zones directly.** It's possible for elements on a UI map to define a specific search zone directly in the HTML, rather than using the search zone defined on an FK reference. Refer to the UI map tips for more information on implementing searches using zones.

---

- A [fixed maintenance page](#) user interface is a page supplied by the base product where only minor enhancements, if any, can be introduced by implementations. The foreign key reference may be used in one of two ways.
  - The based product may use an FK reference to define a base element on one of these pages. If a search is available for such elements, the FK reference's Search Navigation Key is used to implement the search.
  - Entities that support characteristics typically include a generic characteristic collection UI metaphor on these types of pages. In this metaphor, a foreign key characteristic displays a search icon if the FK Reference has configured a Search Navigation Key.

---

**NOTE:** Not every FK reference provided with the product is configured with both search options. Specifically, objects that are maintained in a portal based page typically do not provide a navigation key based search. It means that if linking this type of object as a characteristic to an object that is maintained on a fixed page, a search will not be available.

---

## Foreign Key Reference - Main

To setup a foreign key reference, open **Admin > Database > FK Reference**.

---

**CAUTION:** Important! If you introduce a new foreign key reference, carefully consider its naming convention. Refer to [System Data Naming Convention](#) for more information.

---

### Description of Page

Enter an easily recognizable **FK** (foreign key) **Reference** code and **Description** for the record.

Enter the name of the **Table** whose primary key is referenced. After selecting a **Table**, the columns in the table's primary key are displayed adjacent to **Table PK Sequence**.

Use **Navigation Option** to define the page to which the user will be transferred when they press the go to button or hyperlink associated with the referenced entity. Refer to [Navigation Information Is Dynamically Derived](#) for more information on how this is used.

The **Info Program Type** indicates whether the default program that returns the standard information description is **Java** or **Java (Converted)**, meaning it was converted into Java.

---

**NOTE:** **Java (Converted)** program types are not applicable to all products.

---

Use **Info Program Name** to enter the Java class / program name.

Refer to [Information Description Is Dynamically Derived](#) for more information on the info program is used.

---

**NOTE: View the source.** If the program is shipped with the base package, you can use the adjacent button to display the source code of this program in the [Java docs viewer](#).

---

Use **Context Menu Name** to specify the context menu that appears to the left of the value.

---

**NOTE:** Context Menu Name is not applicable to user interface elements displaying a generic collection using a foreign key characteristic type. It is only applicable for pages utilizing the foreign key compound element type for fixed page user interface and for data displayed in a portal based user interface where the foreign key reference is defined as an attribute for an element. Report parameters that reference foreign key characteristics are an example of a user interface where a context menu is not displayed even if the foreign key reference defines one.

---

Use **Search Zone** to define the search zone that opens when a user searches for valid values when the foreign key reference is configured as an input field on a portal based page. Refer to [Search Options](#) for more information.

Use **Search Navigation Key** to define the search page that will be opened when a user searches for valid values on a user interface that is a fixed page. Refer to [Search Options](#) for more information.

Use **Search Type** to define the default set of search criteria used by the **Search Navigation Key**'s search page.

Use **Search Tooltip** to define a label that describes the **Search Navigation Key**'s search page.

---

**NOTE: Search Type and Search Tooltip.** These attributes are only applicable to user interface elements utilizing the foreign key compound element type on fixed page user interfaces. Report parameters that reference foreign key characteristics are an example of a user interface where this information is not used even if the foreign key reference defines them.

---

## Where Used

Follow this link to open the data dictionary where you can view the tables that reference [CI\\_FK\\_REF](#).

## Defining Feature Configurations

Some system features are configured by populating options on a "feature configuration". Because various options throughout the system may be controlled by settings in feature configuration, this section does not document all the disparate possible options. The topics below simply describe how to use this transaction in a generic way.

For information about specific features:

- Refer to the detailed description of each option type.
- Use the index in the online help and search for 'feature configuration' to find any specific topics describing feature options in the administration guide.

You can create options to control features that you develop for your implementation. To do this:

- Review the lookup values for the lookup field **EXT\_SYS\_TYP\_FLG**. If your new option can be logically categorized within an existing feature type, note the lookup value. If your new option warrants a new feature type, add a lookup value to this lookup field.
- Define the feature's option types. If you have identified an existing feature type to add the options to, find the lookup with the name **xxxx\_OPT\_TYP\_FLG** where **xxxx** is the lookup value of **EXT\_SYS\_TYP\_FLG** noted above. If you decided to create a new feature type (by adding a new lookup value to the **EXT\_SYS\_TYP\_FLG** lookup, you must create a new lookup with the name **xxxx\_OPT\_TYP\_FLG** where **xxxx** is the new value you defined above.
- Flush all caches.



## Feature Configuration - Main

To define your feature configuration, open **Admin > General > Feature Configuration**.

### Description of Page

Enter an easily recognizable **Feature Name** code.

Indicate the **Feature Type** for this configuration. For example, if you were setting up the options for the external messages, you'd select **External Messages**.

---

**NOTE: You can add new Feature Types.** Refer to the description of the page above for how you can add Feature Types to control features developed for your implementation.

---

**NOTE: Multiple Feature Configurations for a Feature Type.** Some Feature Types allow multiple feature configurations. The administration documentation for each feature will tell you when this is possible.

---

The **Options** grid allows you to configure the feature. To do this, select the **Option Type** and define its **Value**. Set the **Sequence** to **1** unless the option may have more than value. **Detailed Description** may display additional information on the option type.

---

**NOTE: Each option is documented elsewhere.** The administration documentation for each feature describes its options and whether an option supports multiple values. Use the index to look for 'feature configuration' to find the various types of feature options.

---

**NOTE: You can add new options to base-package features.** Your implementation may want to add additional options to one of the base-package's feature types. For example, your implementation may have plug-in driven logic that would benefit from a new option. To do this, display the lookup field that holds the desired feature's options. The lookup field's name is **xxxx\_OPT\_TYP\_FLG** where **xxxx** is the identifier of the feature on the **EXT\_SYS\_TYP\_FLG** lookup value. For example, to add new batch scheduler options, display the lookup field **BS\_OPT\_TYP\_FLG**.

---

## Feature Configuration - Messages

If the feature exists to interface with an external system, you can use this page to define the mapping between error and warning codes in the external system and our system.

Open this page using **Admin > General > Feature Configuration** and navigate to the **Messages** tab.

### Description of Page

For each message that may be received from an external system, define the **Feature Message Category** and **Feature Message Code** to identify the message.

A corresponding message must be defined in the [system message](#) tables. For each message identify the **Message Category** and **Message Number**. For each new message, the Message Category defaults to **90000** (because an implementation's messages should be added into this category or greater so as to avoid collisions during upgrades).

## Defining Master Configurations

A master configuration is an object that enables an implementation to define configuration for features in the system. It is an alternative to using feature configuration for defining options. A master configuration is defined using a business object. Only one master configuration may exist for a given business object.



## Overview / Initial Setup

The product provides one or more master configuration that may be used for configuration. Some examples of base master configuration business objects are as follows

- **Hijri to Gregorian Date Mapping.** This allows an implementation that uses Hijri dates to define the mapping between those dates and Gregorian dates.
- **ILM Configuration.** For implementations that use Information Lifecycle Management, the ILM configuration record defines some parameters used by the process.
- **Migration Assistant Configuration.** For implementations that use the configuration migration assistant (CMA), the configuration record defines some parameters used by the process.

For a list of all the master configuration records provided by the product, navigate to the master configuration page in the application. To find help topics related to functionality controlled by the master configuration records, use the keyword 'master configuration' in the index.

Implementations may configure the business objects to limit the ones that are visible to users if desired.

- If the master configuration does not apply to your implementation, navigate to the business object for this master configuration and update the Instance Control to **Do not allow new instances**. This ensures that the business object will not be visible to any user for the implementation.
- If a given master configuration record is only relevant for certain users in the system, application security may be used to limit the records visible by a given user. By default the base delivered business objects typically reference the Master Configuration MO application service. This may be overridden to link custom application services to the master configuration BOs to provide more granular security. Users will only see the master configurations that they have security for.

## Configuration

To set up a master configuration, open **Admin > General > Master Configuration**.

The topics in this section describe the base-package zones that appear on the Master Configuration portal.

### Master Configuration

The Master Configuration List zone lists every category of master configuration.

The following functions are available:

- If a master configuration record exists for a given master configuration business object, the broadcast icon may be used to view details information about the adjacent master configuration. In addition, an edit icon is visible to allow a user to update the record.
- If a master configuration record does not exist for a given master configuration business object, the add icon is visible to allow a user to define the record.

### Master Configuration Details

The Master Configuration Details zone contains display-only information about a master configuration.

This zone appears when a master configuration has been broadcast from the Master Configuration zone.

Please see the zone's help text for information about this zone's fields.

## Defining Security & User Options

The contents of this section describe how to maintain a user's access rights.

# The Big Picture of Application Security

The contents of this section provide background information about application security.

## Application Security

The system restricts access to transactions or explicit services using an [application service](#). The following points highlight what may be secured.

- The following points highlight security related to viewing and modifying individual records in the system:
  - All [maintenance objects](#) define an application service that includes the basic actions available, typically **Add**, **Change**, **Delete**, and **Inquire**. The base product supplies an application service for every maintenance object. Note that the application service for the maintenance object is defined on its related [service program](#).
  - For maintenance objects whose user interface page is not portal-based, the application service also controls whether the menu entry appears. If a user doesn't have access to the maintenance object's application service, the menu item that corresponds with the application service will not be visible.
  - For portal based user interfaces, each main (stand-alone) [portal](#) defines an explicit application service with the access mode **Inquire**, allowing the user interface to be secured independently of the underlying object security. If a user doesn't have access to the portal's application service, the menu item that corresponds with the application service will not be visible. The base product supplies an application service for every portal that is accessible from the menu. Note that the application service for the portal is defined on its related [service program](#), which is derived via its navigation option and navigation key.
  - [Menu items](#) may define an application service / access mode. Typically the security supplied for portals and maintenance objects provides enough granularity to suppress menu items that a user does not have access to. Linking an explicit application service / access mode will further suppress the menu item under one of the following scenarios:
    - Suppress a menu item if the underlying application security for the transaction does not provide enough fine grained control. For example, imagine your implementation creates a special BPA script to add a To Do Entry and would like users to use the special BPA rather than the base supplied Add dialogue for To Do Entry. The underlying security settings for To Do Entry should grant Add access to these users given that the special BPA will still add a record. To suppress the base Add dialogue, link a special application service and access mode for the base supplied menu item for To Do Entry Add. Then define a menu entry for the new special BPA for adding.
    - Suppress the add option if a user does not have add security for the object. By default the product does not suppress the add function if a user does not have add access to the object. Rather, the user is prevented from adding the record at the back-end. If your implementation would like to suppress the menu option, link the object's application service and the Add access mode to the Add menu item.

---

**NOTE:** The base product does not typically provide menu items with application services configured. Implementations may add this configuration if one of the above scenarios exist.

---

- [Zones](#) define an application service.
  - For zones linked to a portal, if a user doesn't have access to the zone's application service, the zone will not be visible on the portal. In most cases the zone is delivered with the same application service as its portal. In special cases, such as the zones on the Dashboard, the product supplies separate application services for each zone allowing implementations to determine at a more granular level which users should have access to which zones.
  - For query zones that are configured on a multi-query zone, if a user doesn't have access to the zone's application service, the zone will not be visible in the dropdown on the multi-query zone. In most cases all zones in a multi-query zone define the same application service as the multi-query zone. The product may supply a special

application service for one or more zones in a multi-query zone if the functionality is special to certain markets or jurisdictions and not applicable to all implementations.

- For zones that are used by business services to perform SQL queries, the product supplies a default application service. Security for these zones is not checked by the product as they are used for internal purposes.
- **Business objects** define an application service. If the business object defines a lifecycle, the application service must include access modes that correspond to each state. In addition, the standard maintenance object access modes of **Add, Change, Delete** and **Inquire** are included. The base product business objects are supplied with appropriate application services. In addition, implementations may override the configured application service if desired.
- **Batch controls** define an application service which provides the ability to secure submission of individual batch processes. The application service must include an access mode of **Execute**. The base product batch controls are supplied with appropriate application services. These services will typically have an ID that matches the batch control ID.
- **Report Definition** records define an application service. The application service must include an access mode of **Submit / View Report**.
- The following objects are securable but are typically executed via internal processes. The security is provided to ensure that any access to the objects from an external source is secured.
  - **BPA scripts** may define an application service with the access mode **Execute**. The base BPA scripts are typically not configured with any application service. An implementation may define one. Note that as mentioned above, a menu item may also be configured with an application service and access mode. This allows for a BPA that is invoked via a menu entry to be secured in more than one way.
  - **Business Services** and **Service Scripts** define an application service with the access mode **Execute**. This is needed for services that may be executed from an external system, for example via an inbound web service. Base business services and service scripts that are linked to an inbound web service are configured with special application service. All other business services and service scripts are delivered with a default application service, which may be overridden by an implementation.
  - **Service Programs** define an application service. As mentioned above, for Portals and Maintenance Objects, their application service is taken from the related service program. In base, specific application services are released for each of these types of service programs. All other service programs are typically delivered with a default application service, which may be overridden by an implementation. Note that for service programs linked to a Business Service, the application service on the business service takes precedence when invoking the business service.

Users are granted access to application services via **user groups**. For example, you may create a user group called Senior Management and give it access to senior manager-oriented pages and portals.

- When you grant a user group access to an application service with multiple access modes, you must also define the access modes that are allowed. Often the access modes correspond to an action on a user interface. For example, you may indicate a given user group has **inquire**-only access to an application service, whereas another user group has **add, change, cancel** and **complete** access to the same service. Refer to **action level security** for more information.
- If the application service has **field level security** enabled, you must also define the user group's security level for each secured field on the transaction.
- And finally, you link individual **users** to the user groups to which they belong. When you link a user to a user group, this user inherits all of the user group's access rights.

## Action Level Security

When you grant a user group access to an **application service**, you must indicate the actions to which they have access.

- For application services that only query the database, there is a single action to which you must provide access - this is called **Inquire**.

- For application services that can modify the database, you must define the actions that the user may perform. At a minimum, most maintenance transactions support **Add**, **Change**, and **Inquire** actions. Additional actions are available depending on the application service's functions.

---

**CAUTION:** Important! If an application service supports actions that modify the database other than **Add**, **Change**, and **Delete**; you must provide the user with **Change** access in addition to the other access rights. Consider a transaction that supports special actions in addition to **Add**, **Change**, and **Inquire** (e.g., **Freeze**, **Complete**, **Cancel**). If you want to give a user access to any of these special actions, you must also give the user access to the **Inquire** and **Change** actions.

---

## Field Level Security

Sometimes transaction and action security is not sufficient. There are situations where you may need to restrict access based on the values of data. For example, in Oracle Utilities Customer Care and Billing you might want to prevent certain users from completing a bill for more than \$10,000. This is referred to as "field level security".

Field level security can be complex and idiosyncratic. Implementing field level security always requires some programming by your implementation group. This programming involves the introduction of the specific field-level logic into the respective application service(s).

---

**NOTE:** **Field level security logic is added to user exits.** Refer to the Public API chapter of the Software Development Kit Developer Guide for more information on how to introduce field-level security logic into an application service's user exits.

---

Even though the validation of a user's field-level security rights requires programming, the definition of a user's access rights is performed using the same transactions used to define transaction / action level security. This is achieved as follows:

- Create a [security type](#) for each type of field-level security.
- Define the various access levels for each security type. For example, assume you have some users who can complete bills for less than \$300, and other users who can complete bills for less than \$1,000, and still other users who can complete bills for any value. In this scenario, you'd need 3 access levels on this security type:
  - Level 1 (lowest): May authorize bills <= \$300
  - Level 2 (medium): May authorize bills <= \$1,000
  - Level 3 (highest): May authorize all bills
- Link this security type to each [application service](#) where this type of field level security is implemented. This linkage is performed on the [security type](#) transaction.
- Defining each [user group's](#) access level for each security type (this is done for each application service on which the security type is applicable).

---

**NOTE:**

Highest value grants highest security. The system expects the highest authorization level value to represent highest security level. Moreover, authorization level is an alphanumeric field so care should be taken to ensure that it's set up correctly.

---

## Encryption and Masking

"Encryption" refers to encrypting data stored in the database using an encryption key. There are two different types of encryption described in the sections below. System encryption refers to columns in the system identified by the product to use encryption. Application encryptions refers to the ability for an implementation to configure fields and element that should be encrypted in the database.

"Masking" refers to overwriting all or part of an un-encrypted field value with a masking character. For example, perhaps only the last 4 digits of a credit card number are visible with the other digits changed to an asterisk. The system provides support for masking fields on the user interface that may be stored as plain text in the database. In addition, there are cases where encrypted fields are shown to the user interface using masked values rather than the encrypted value.

The following sections provide more information about each feature.

## System Encryption

The system automatically encrypts certain fields captured in various option tables or context tables. This is mainly used for passwords. For example, passwords captured in Message Sender context or password

In addition, batch control supports configuring a security option for parameters that capture sensitive information, such as a password. Refer to [Defining Batch Controls](#) for more information.

It is also possible to enable system encryption using the characteristic type **F1-PWD**. However, the maintenance object must include specific code to enable system encryption for characteristics of this type. In Oracle Utilities Application Framework, the only maintenance object that supports this is extendable lookup. Refer to [Extendable Lookup Advanced Topics](#) for more information.

## User Interface Masking

The functionality described in this section is used to take data that is stored in plain text in the database and mask the value before it is presented to a user (or an external system). This feature includes the ability to allow some users to view the data unmasked using security configuration. The system allows different masking rules to be applied to different fields. For example, a credit card number can be masked differently than a social security number.

The following topics describe how to mask field values.

### Identify the Data to be Masked

Identify the data that is stored as plain text, but should be masked for display to users. For example, imagine that you have identified that Credit Card Numbers and a person's federal ID number (for example, in the United States, the Social Security Number or SSN). Each field identified may be displayed and maintained in different user interfaces throughout the system, but the masking rules for a given field are probably uniform regardless of where the data is displayed.

**Primary keys cannot be masked.** A field defined as a unique identifier of a row cannot be configured for masking. Masking a field that is part of the primary key causes a problem when attempting to update the record. This restriction also applies to elements that are part of a "list" in an XML column on a maintenance object. One or more elements in the list must be defined as a primary identifier of the list. Be sure that primary key elements in the list are not ones that require masking.

**List members that contain different "types".** Consider a page with a list that contains a person's identification numbers. You can set up the system so that a person's social security number has different masking rules than their drivers license number. If your implementation has this type of requirement, the list of masked fields should contain an entry for each masking rule.

For each field, if there are some users that may see the data unmasked on one or more of the user interfaces, then security configuration is required. If the value of a field should be masked for all users across all pages in the application, then the security configuration is not needed.

### Security Configuration

Define a [security type](#) for each field with two authorization levels:

- 1 - Can only see the element masked
- 2 - Can only see the element unmasked

Link all of the security types to an [application service](#) of your choosing. We recommend linking every masking-oriented security type to a single application service (e.g., **CM\_MASK**) as it makes granting access easier.

For each security type, identify which users can see its data unmasked and which users can only see its data masked. If the masked and unmasked users fit into existing user groups, no additional user groups are necessary. Otherwise, create new user groups for the masked and unmasked users.

After the user groups for each security type are defined, [link each user group to the application service](#) defined above. When a user group is linked to the application service, you will define the authorization level for each security type linked to the application service. If a user group's users should see the security type's field values unmasked, set the authorization level to 2; otherwise set it to 1.

---

**NOTE:** Flush the cache. Remember that any time you change access rights you should [flush the security cache](#) (by entering `flushAll.jsp` on the URL of the application) if you want the change to take effect immediately.

---

## Configure a Masking Algorithm

A data masking algorithm must be created for each combination of masking rules and security type. These algorithms determine if a user has the rights to view a given field unmasked, and, if not, how the field should be masked.

The base package provides the algorithm type **FI-MASK** whose parameters are designed to handle most masking needs. If certain users may see the data unmasked, parameters capture the application service, security type and authorization level defined above used to evaluate this. In addition, parameters allow you to configure how much of the data to mask, what masking character to use. Refer to the algorithm type description for more information.

Click [here](#) for a list of all the algorithms supplied for this plug-in spot.

## Determine How the Fields are Displayed

The masking configuration differs based on how a field is retrieved for access to the user interface. So for the masking of one “logical” field (like a person’s SSN), there may be multiple configuration entries required to cover all the access methods. Review each user interface where a given field is displayed and create the following categories:

- The field is an element that is retrieved by invoking a business object, a business service, or a service script
- The field is displayed on a fixed maintenance page (and is therefore retrieved by invoking a page service)
- The field is displayed on a fixed search page (and is therefore retrieved by invoking a search service)
- The field is stored as an ad hoc characteristic

## Create a Feature Configuration for Each Masked Element

Create a feature configuration with a Feature Type of **Data Masking**. An option entry with option type of **Field Masking** is needed for every combination of field to mask and the method used to display the data. The value will contain mnemonics that reference the appropriate data masking algorithm along with configuration that differs depending on how the field is retrieved for display as described below.

## Schema Based Object Field Masking

For data that is accessed via a schema-based object call and displayed in a UI map, the field to be masked must reference a meta-data field name in its schema definition: **field="fld\_name", alg="algorithm name"**

If the element references an `mdField` in the schema, that is the field used to identify the masking rule. If there is no `mdField` reference but only a `mapField` reference, that is the field used to identify the masking rule. For example, if you want to mask a credit card number, let's assume that field is defined in the schema is the following:

```
<creditCard mdField="CCNBR" mapField="EXT_ACCT_ID"/>
```

In this case, the option value should be **field="CCNBR", alg="algorithm name"**. An option value of **field="EXT\_ACCT\_ID", alg="algorithm name"** would not result in masking.

A "where" clause may also be specified. This is useful for data that resides in a list where only data of a certain type needs to be masked: **field="fld\_name", alg="algorithm name", where="fld\_name='value'"**

For example, person can have a collection of IDs and only IDs of type 'SSN' (social security number) should be masked. If the person data including its collection of person IDs is displayed on a UI map via a business object call, let's assume the collection is defined in the following way:

```
<personIds type="list" mapChild=CI_PER_ID">
  <isPrimaryId mapField="PRIM_SW"/>
  <idType mapField="ID_TYPE_CD"/>
  <personIdNumber mapField="PER_ID_NBR"/>
</personIds>
```

The option value may look like this: **field="PER\_ID\_NBR", alg="algorithm name", where="ID\_TYPE\_CD='SSN'"**

Please note the following important points for schema based masking:

- **Limitation of 'where' field** Although the main use of a 'where' clause for schema oriented elements is to mask certain elements in a list based on a 'type', it is also possible to mask a single field in the schema based on the value of another field. For example, imagine that a customer submits a registration form that defines an ID type and ID value. Although this data is not in a list, the implementation may still want to only mask the ID value if the ID type is "SSN". The framework is only able to mask an element in the schema based on a 'where' clause if the element in the 'where' clause is a "sibling" in the schema.
  - If the element to be masked is in a list, the element in the 'where' clause must be in the same list.
  - If an element to be masked maps to a real column in a table, the element in the 'where' clause must also map to a real column in the table.
  - If an element to be masked maps to an XML column in the table as a single element, the element in the 'where' clause must map to the same XML column as a single element.
- **Multiple feature option entries for the same field.** It's possible that different schemas in the system have a similar type of data that may be masked based on different conditions. For example, imagine that an implementation has different schemas that captured or referenced person identifiers in different ways:

- One schema captures a single person ID without any corresponding "type" record and it should always be masked using Algorithm CM\_SSN\_MASK:

```
<personSSN mapXML=BO_DATA_AREA mdField=PER_ID_NBR/>
```

- One schema captures a person ID and a corresponding ID Type and it should be masked with Algorithm CM\_SSN\_MASK if the type is "SSN" and masked with algorithm CM\_FEIN\_MASK if the type is "FEIN".

```
<personIdType mapXML=BO_DATA_AREA mdField=ID_TYPE_CD/>
<personId mapXML=BO_DATA_AREA mdField=PER_ID_NBR/>
```

- One schema captures a person ID and a corresponding ID Type and it has the same masking rules as the previous schema, but a different field name is used for the ID Type code. (This scenario could happen if for example a different label is desired for ID Type on the user interface for this schema.)

```
<personIdType mapXML=BO_DATA_AREA mdField=CM_ID_TYPE/>
<personId mapXML=BO_DATA_AREA mdField=PER_ID_NBR/>
```

For this scenario, the feature options may look like this:

1. **field="PER\_ID\_NBR", alg="CM\_SSN\_MASK"**
2. **field="PER\_ID\_NBR", alg="CM\_SSN\_MASK", where="ID\_TYPE\_CD='SSN'"**
3. **field="PER\_ID\_NBR", alg="CM\_FEIN\_MASK", where="ID\_TYPE\_CD='FEIN'"**
4. **field="PER\_ID\_NBR", alg="CM\_SSN\_MASK", where="CM\_ID\_TYPE='SSN'"**
5. **field="PER\_ID\_NBR", alg="CM\_FEIN\_MASK", where="CM\_ID\_TYPE='FEIN'"**

For each schema, the system will first find whether the element applies to any masking option. It will find 5 masking options for the field PER\_ID\_NBR. Then it will determine if any sibling elements match the 'where' clause.

- If more than one sibling element matches a 'where' clause, a runtime error is issued. For example if a schema has an element that references "mdField=ID\_TYPE\_CD" and an element that references "mdField=CM\_ID\_TYPE", this is an error. Additionally, if multiple elements reference mdField=ID\_TYPE\_CD", this is an error.
- If one and only one sibling element matches a 'where' clause, the value of the element is compared to the values defined in the 'where' clause. If it finds a match on the value, the appropriate masking algorithm is applied. If no match is found (for example, the Person ID Type is "LICENSE") the element is displayed as is.
- If no sibling element matches a 'where' clause and a feature option exists with no 'where' clause (option 1 above), then the masking algorithm of the option with no 'where' clause is applied.
- **Changing the value in the 'where' clause.** If your implementation has some users that are allowed to change records where some data is masked based on a condition, it is recommended to design the user interface to reset the masked value when the value in the 'where' clause changes. For example, if a user is prevented from viewing a person's social security number, but the user is allowed to make updates to the person's record, changing the value of the Person ID Type should reset the Person ID Number. This would ensure that the user does not 'unmask' the social security number by simply changing the ID Type.

## Records Maintained Using Page Maintenance

For data that is accessed via a page maintenance service call, indicate the table name and the field name where the data resides: **table="table\_name", field="fld\_name", alg="algorithm name"**

For example if the Person record and its collection of identifiers are displayed and maintained using page maintenance, the option value should be **table="CI\_PER\_ID", field="PER\_ID\_NBR", alg="algorithm name"**

A "where" clause may also be specified: **table="table\_name", field="fld\_name", where="fld\_name='value'", alg="algorithm name"**

This is useful for data that resides in a child table where only data of a certain type needs to be masked. For the person ID example, **table="CI\_PER\_ID", field="PER\_ID\_NBR", alg="algorithm name", where="ID\_TYPE\_CD='SSN'"**

## Characteristic Data

For data that is stored as a characteristic, simply indicate the characteristic type: **CHAR\_TYPE\_CD='char type', alg="algorithm name"**

This needs to be defined only once regardless of which characteristic entity the char type may reside on. Note that only ad-hoc characteristics are supported.

## Masking Fields in Explorer Zones or Info Strings

In explorer zones data is often retrieved using SQL directly from the database. No masking is applied automatically in this case. If there is data in the explorer zone results that should be masked, the masking must be applied by calling a business service.

Similarly, an MO Info algorithm may not use BO interaction to get data. It may access data using SQL for efficiency purposes. No masking is applied when retrieving data via SQL. To apply masking to a string prior to including it in an info string, the masking must be applied by calling a business service.

The system supplies two business services to be called to determine if masking rules apply for a specific field.

- **F1-TableFieldMask.** Mask a Table field. This business service receives a table name, field name and one or more field values. If masking applies it returns the masked value.
- **F1-SchemaFieldMask.** Mask a Schema field. This business service receives a schema name and type, XPath and field value. If masking applies it returns the masked value.



## Search Service Results

For data that is displayed on a 'fixed' search page, it is retrieved via a search service call. Indicate the search name and the appropriate field to mask along with the masking algorithm. For example: **search="SearchServiceName", field="PER\_ID\_NBR", where="ID\_TYPE\_CD='SSN'", alg="algorithm name"**

To find the name of the search service, launch the search in question, right click in the filter area and choose View Source. Search for ServiceName. The service name is listed there. To find the field name to mask, go back to the search window and right click on the results area and choose View Source. Look for the Widget Info section and find the field name in the SEARCH RESULTS (do not include the \$). Note, the "where" statement can only apply to fields that are also part of the search results.

## Additional Masking Information

The following points provide additional information to assist in your masking configuration:

- If the demonstration database includes a **Data Masking** feature configuration, review the settings because it will probably contain masking rules that will match your own.
- On data input pages, a user might be able to enter or change masked data, such as a bank account number, but not be able to subsequently see what they added or changed.
- External systems can request information by performing a service call via a web service. Please keep in mind that some web service requests require data to be masked and some do not. For example, a request from an external system to synchronize person information needs the person's social security number unmasked; whereas a request from a web self service application to retrieve the same person information for display purposes needs the person's social security number masked. To implement this type of requirement, different users must be associated with each of the requests and these users must belong to separate user groups with different access rights.
- If a maintenance object (MO) contains a field that holds an XML document and a service call invokes the MO's service program directly, the system will mask individual XML elements in the field if a **Determine BO** algorithm has been plugged into the [maintenance object](#) and the element(s) in the respective BO schema have been secured as described above.

## Application Encryption

The functionality described in this section allows implementations to configure fields to encrypt when storing it in the database. This functionality is mutually exclusive from the User Interface Masking functionality described in the previous section. This feature supports encrypting specific elements stored within a CLOB or XML column.

The following points highlight the features of the encryption functionality:

- The encryption key is defined using a keystore, which must be set up in order to use this functionality. For details about setting up the keystore in the system, see the Installation Guide.
- When a field is configured to be encrypted, the encrypted data is stored in a special encryption field that is not the source field (the one exposed to the user on the user interface). The source field captures the data as masked. Because a special field is required to support encryption, the product must provide support for that field to be encrypted.
- For encrypted data that must allow searching, the system supports capturing a hash value in a special field. The product must provide support for this functionality. Besides providing a special field to capture the hash value, base search functionality for that data must also cater for this configuration.
- The system supports encrypting data that is captured as an element within an XML field. If the XML field is provided in a schema owned by the product, then the product must provide specific support for the capture of the encrypted data.

The following sections provide additional information about the support for encryption provided by the framework. Refer to the security chapter of the administration guide for your particular product for more information.

## Encrypting and Masking the Data

When a product enables encrypting for a given type of data, a special encryption field should be created to capture the encrypted value. Because encrypting is optional, the source field (the one exposed to the user) should not be this special encrypted field. If encryption is configured, the system will internally populate the encrypted field. The source field will be populated with asterisks by default. That way the masked data is what is shown to the user on page rather than the encrypted value.

The following points highlight how the system behaves when encryption is configured and when it is not. Assume as an example, the field is a credit card number. The user views and populates a field with the field name `CC_NBR`. The table also has a second field `ENCR_CC_NBR`. A user populates the credit card number:

- If encryption is not configured, `CC_NBR` will be updated with the entered credit card number and `ENCR_CC_NBR` will be empty. Note that in this case, an implementation may choose to configure [user interface masking](#).
- If encryption is configured, `CC_NBR` will be updated with `'*****'` and `ENCR_CC_NBR` will contain the encrypted value. The asterisks for the standard field will fill the full field size up to 50 characters.

If for some reason the standard masking using all asterisks is not desired, the system supports supplying an explicit masking algorithm using the same [Data Masking](#) plug-in spot used for [User Interface Masking](#).

---

**WARNING:** Unlike user interface masking, the masking of encrypted fields is not driven by security. The data stored in the source field for all encrypted data should be masked. Be sure not to configure security authorization logic in algorithms used for this type of masking.

---

## Feature Option Configuration

Create a feature configuration with a Feature Type of **Encryption**. For each source field you are encrypting, enter an option with option type of **Field Encryption**. The value will contain mnemonics that reference the appropriate encryption key alias defined in the keystore along with configuration related to the field and its table location. Unlike the user interface data masking, the configuration for data encryption is related to how the data is stored rather than how it is displayed. In addition, each entry may define an explicit masking algorithm to override the default and if supported, may also define a hash field and hash alias.

For data that is stored in a specific column on a table, an explicit field to capture the encrypted value must exist. Indicate the table name, source field name and encrypted field name along with the alias: **table='table\_name', field='fld\_name', encryptedField='encr\_fld\_name', alias='alias key'**

A "where" clause may also be specified when data resides in a child table and only data of a certain type needs to be encrypted.

Example, **table='CI\_PER\_ID', field='PER\_ID\_NBR', encryptedField='ENCR\_PER\_ID\_NBR', alias='key alias', where='ID\_TYPE\_CD='SSN''**

For data that is stored in an XML column in a record, the source field to be encrypted must reference a meta-data field name in its schema definition along with the element that captures the encrypted data and the alias: **field='field\_name', encryptedField='encr\_field\_name', alias='key alias'**

The syntax for adding a reference to a masking algorithm is **maskAlg='algorithm name'** .

The syntax for adding configuration for capturing a hash value for searching purposes is **hashAlias='hashAliasKey' hashField='HASH\_FLD\_NAME'**.

The following is an example of configuration that uses all the possible options (specific masking algorithm, where clause and hash field support):

**table='CI\_PER\_ID', field='PER\_ID\_NBR', alias='aliasKey', encryptedField='ENCR\_PER\_ID\_NBR', hashAlias='hashAliasKey' hashField='HASH\_PER\_ID\_NBR', where='ID\_TYPE\_CD=SSN', maskAlg='CM-PERIDMASK'**

## Searching by an Encrypted Value

If the product supports a hashed value for an encrypted field for searching purposes, the following points highlight explorer zone configuration for this purpose

- The user filter value should reference the source field and should include an additional **encrypt=** mnemonic. For example

```
type=STRING
label=PER_ID_NBR
encrypt=[CI_PER_ID,PER_ID_NBR, ID_TYPE_CD, F1]
```

Refer to [User Filters](#) for more information.

- The SQL should include the hashed value in the WHERE clause. Note that because encryption is optional, a product zone that includes searching by a field eligible for encryption will include finding a match for the filter in the source field (as plain text) or in the hashed field. For example:

```
WHERE
  [(F2) (ID.PER_ID_NBR = :F2 OR ID.HASH_PER_ID_NBR = :F2)]
```

## Customizing Encryption Algorithm

Although the encryption algorithm to use with a given key can be gleaned from the key in the keystore, there is sometimes extra information associated with an algorithm that might need to be used to encrypt or decrypt data.

The system provides a feature configuration option for the **Encryption** feature type using the option type **Algorithm Info** that can be used to adjust the behavior of the encryption.

- You can modify the default mode and padding of the encryption algorithm.
- If a key will be used to digitally sign anything, the signing algorithm can also be specified for the key.

For details about the syntax, refer to the feature option type's detailed description.

## The Base Package Controls One User, One User Group, And Many Application Services

When the system is initially installed, the following information is delivered:

- Application services for all secured transactions, maintenance objects, business objects, business services, scripts and zones in the base package.
- A user identified by the user id **SYSUSER**.
- A user group identified by the user group code **ALL\_SERVICES**. This user group is associated with all supported application services delivered with the base product. This user group is given access to all access modes for all application services (i.e., all actions on all transactions).
- The user **SYSUSER** is linked to the **ALL\_SERVICES** user group. This means that this user has access to all transactions and all actions.

You cannot change or remove the information delivered for **ALL\_SERVICES**. This information is owned by the base package. It is provided so that an "initial user" has access to the entire system and can setup user groups and users as per your organization's business requirements. It is not recommended to provide your own users with access to the **ALL\_SERVICES** user group. Rather, create user groups that are appropriate for the organization's business requirements and define user access to these user groups. If you introduce new transactions, configure them for the appropriate custom user groups.

In addition, **SYSUSER** is provided to allow for an initial user to define appropriate users in your implementation. Once proper administrative users have been defined, it is recommended that **SYSUSER** is updated to set the User Enable setting to Disabled.

When you receive an upgrade:

- New application services are delivered for the new transactions, business objects, zones introduced in the release. The release notes highlights the additions / changes.
- Existing application services are updated with changes in their access modes (e.g., if a new action is added to a transaction, its application service is updated accordingly).
- The **ALL\_SERVICES** user group is updated so it can access the new / changed application services.
- Implementations should review the release notes and determine which user groups created for your implementation should be updated with the additions, if applicable.

## Importing Security Configuration from an External Source

The product provides support for importing security information from an external source:

- If your organization uses Lightweight Directory Access Protocol (LDAP), you can import your existing LDAP users and groups into the system. Once imported, all user and group functions are available. You can import a user group, or a single user. You can resynchronize your LDAP users and groups at any time.

---

**FASTPATH:** For more information refer to [LDAP Integration](#).

---

- The system provides an integration with Oracle Identity Manager. When a user is created in the identity manager product, its information can automatically be interfaced to the product. Once the user is successfully created in the system, all functions are available.

---

**FASTPATH:** For more information refer to [Oracle Identity Manager Integration](#).

---

## The Big Picture of Row Security

Some products allow you to limit a user's access to specific rows. For example, in Oracle Utilities Customer Care and Billing, row level security prevents users without appropriate rights from accessing specific accounts.

A combination of framework configuration and configuration in your edge product is required for row level security. The following points describe the configuration:

- For each record that should be secured, associate it with an **Access Group**. Note that if your edge product supports row level security, that product is providing a link between the secure-able record and Access Group. Your access groups may be granular and only referenced by one secured record or they may be more broad and be referenced by multiple secured records that require the same type of security restriction.
- To define which users have access to the secured records, you define a **Data Access Role**. For each data access role, define which Access Groups the role has security clearance for. An access group may be linked to one or more data access roles. In addition, define the **Users** that have access rights to these secured records. When you grant a data access role rights to an access group, you are giving all users in the data access role rights to all secured records all the referenced access groups. A user may belong to many data access roles.

If your edge product supports row level security, it will include logic in the appropriate areas of the system to limit the secured rows that a user may view or maintain based on this configuration. For example, in Oracle Utilities Customer Care and Billing, throughout the system users are only able to view and maintain information about an account and any of its detail if the user is in a Data Access Role for the account's Access Group (or the account is not linked to an Access Group).

---

**FASTPATH:** Refer to your product's documentation for more information on row level security, if applicable.

---

## Defining Application Services

An application service exists for every transaction in the system. Please refer to [Application Security](#) for a description of how application services are used when you grant user groups access rights transactions.

---

**CAUTION:** Important! If you introduce a new application service, carefully consider its naming convention. Refer to [System Data Naming Convention](#) for more information.

---

### Application Service - Main

Select **Admin > Security > Application Service** to define an application service.

#### Description of Page

Enter a unique **Application Service** code and **Description** for the application service.

Indicate the application service's various **Access Modes** (i.e., actions). Refer to [Action Level Security](#) for more information about the significance of these fields.

#### Where Used

Follow this link to open the data dictionary where you can view the tables that reference [SC\\_APP\\_SERVICE](#).

### Application Service - Application Security

Use the Application Security portal to set up security for an application service.

Open this page using **Admin > Security > Application Service**, and then navigate to the **Application Security** tab.

This section describes the available zones on this page.

**Application Service Details** zone. This zone contains display-only information about the selected application service, including the Access Modes for the application service and its security type.

**Secured Objects** zone. This zone displays the object (or objects) that are secured by this application service. Refer to [Application Security](#) for details about the types of objects that may be secured.

**User Groups Linked** zone. This zone lists the user groups that currently have a link to the application service. Note that expired links are also included. The following actions are available:

- Click the **Description** link to navigate to the [User Group - Users](#) page for the adjacent user group. This allows you to add or remove users linked to the user group.
- Click **Deny Access** to remove the selected Application Service's link to this user group.

**User Groups not Linked** zone. This zone lists the user groups that do not have a link to the application service. The following actions are available:

- Click the **Description** link to navigate to the [User Group - Users](#) page for the adjacent user group.
- Click **Grant Access** to navigate to the [User Group - Application Services](#) page for the user group. The page is automatically positioned at the selected application service allowing you to set the access modes and the expiration date.

## Defining Security Types

Security types are used to define the types of [field level security](#).

---

**NOTE: Programming is required.** You cannot have field level security without introducing logic to user exits. Refer to [Field Level Security](#) for more information on how security types are used to define field level security.

---

## Security Type - Main

Select **Admin > Security > Security Type** to define your security types.

### Description of Page

Enter a unique **Security Type** and **Description**.

Use the **Authorization Level** grid to define the different authorization levels recognized for this security type. Enter an **Authorization Level Number** and its **Description**.

---

**NOTE: Programming is required.** Note that the values that you enter are not interpreted by the system itself, but by the user exit code used to implement the special security. Check with the developer of the user exit logic for the correct values. Refer to [Field Level Security](#) for more information on how security types are used to define field level security.

---

Use the **Application Services** grid to define the application service(s) to which this security type is applicable. If this application service is already associated with user groups, you must update each user group to define their respective security level. This is performed using [User Group - Application Service](#).

### Where Used

Follow this link to open the data dictionary where you can view the tables that reference [CI\\_SC\\_TYPE](#).

## Defining User Groups

A user group is a group of users who have the same degree of security access. Think of a user group as a "role"; associated with a role are:

- The users who play this role
- The application services to which the role's users have access (along with the actions they can execute for each service and their field level security authorization levels).

## User Group - Main

Select **Admin > Security > User Group** to view the application services to which a user has access.

---

**CAUTION:** Application services may not be changed or removed from the **ALL\_SERVICES** user group. Refer to [The Base Package Controls One User, One User Group, And Many Application Services](#) for an explanation.

---

### Description of Page

Enter a unique **User Group** code and **Description** for the user group.

**Owner** indicates if this user group is owned by the base package or by your implementation (**Customer Modification**). The system sets the owner to **Customer Modification** when you add a user group. This information is display-only.

The **Application Services** grid displays the various application services to which users in this group have access. Please note the following in respect of this grid:

- Use the **Application Service** search to restrict the application services displayed in the grid. For example, if you only want to see application services that start with the word "field", you can enter this word and press enter.
- To add additional application services to this user group, navigate to the [User Group - Application Services](#) page and click the add icon.

- To remove or change this user group's access to an application service, click the go to button adjacent to the respective application service. This will cause you to be transferred to the [User Group - Application Services](#) tab where you should click the - icon to remove the application service from the user group.
- Note, **Owner** indicates if this user group / application service relationship is owned by the base package or by your implementation (**Customer Modification**). The system sets the owner to **Customer Modification** when you add an application service to the user group. This information is display-only.

### Where Used

Follow this link to open the data dictionary where you can view the tables that reference [SC\\_USER\\_GROUP](#).

## User Group - Application Services

Select **Admin > Security > User Group** and navigate to the **Application Services** tab to maintain a user group's access rights to an application service.

---

**NOTE: Important!** When you grant a user group access rights to an application service, you are actually granting all users in the user group access rights to the application service.

---

### Description of Page

The **Application Service** scroll contains the application services to which the **User Group** has access.

---

**NOTE:** You can also use Main page to select the application service for which you wish to change the access privileges. To do this, simply click the go to button adjacent to the respective application service.

---

To add additional application services to this user group, click the + icon and specify the following:

- Enter the **Application Service ID** to which the group has access.
- Define the **Expiration Date** when the group's access to the application service expires.

Define the **Access Modes** that users in this group have to the **Application Service**. When a new application service is added, the system will default all potential **Access Modes** associate with the **Application Service**. You need only remove those modes that are not relevant for the **User Group**. Refer to [Action Level Security](#) for more information about access modes.

---

**CAUTION:** Important! If an application service supports actions that modify the database other than **Add, Change, and Delete**; you must provide the user with **Change** access in addition to the other access rights. Consider a transaction that supports actions in addition to **Add, Change, and Inquire** (e.g., **Freeze, Complete, Cancel**). If you want to give a user access to any of these additional actions, you must also give the user access to the **Inquire** and **Change** actions.

---

If you require additional security options, often referred to as "field level" security, then you use **Security Type Code** and assign an **Authorization Level** to each. When a new application service is added, the system will display a message indicating how many security types are associated with this application service. Use the search to define each Security Type Code and indicate the appropriate Authorization Level for this user group. Refer to [Field Level Security](#) for more information about security types.

## User Group - Users

Select **Admin > Security > User Group** and navigate to the **Users** tab to maintain the users in a user group.

### Description of Page

The scroll area contains the users who are part of this user group.



---

**NOTE:** Keep in mind that when you add a **User** to a **User Group**, you are granting this user access to all of the application services defined on the **Application Services** tab.

---

The following fields are included for each user:

- Enter the **User ID** of the user.
- Use **Expiration Date** to define when the user's membership in the group expires.
- **Owner** will be **Customer Modification**.

---

**NOTE:** You can also add a user to a user group using [User - Main](#).

---

## Defining Access Groups

---

**FASTPATH:** Refer to [The Big Picture of Row Security](#) for a description of how access groups are use to restrict access to specific objects.

---

Access groups control which groups of users (referred to as Data Access Roles) have rights to accounts (or other objects) associated with the access group. Select **Admin > Security > Access Group** to define your access groups.

### Description of Page

Enter a unique **Access Group** code and **Description** for the data access group.

Use the **Data Access Role** collection to define the data access roles whose users have access to the access group's accounts (or other objects). Keep in mind that when you add a **Data Access Role** to an **Access Group**, you are granting all users who belong to this role access to all of the accounts (or other objects) linked to the access groups.

---

**NOTE:** You can also use [Data Access Role - Access Group](#) to maintain a data access role's access groups.

---

### Where Used

Follow this link to open the data dictionary where you can view the tables that reference [CI\\_ACC\\_GRP](#).

## Defining Data Access Roles

---

**FASTPATH:** Refer to [The Big Picture of Row Security](#) for a description of how access groups are use to restrict access to specific objects.

---

The data access role transaction is used to define two things:

- The users who belong to the data access role.
- The access groups whose accounts (or other objects) may be accessed by these users.

### Data Access Role - Main

Select **Admin > Security > Data Access Role** to define the users who belong to a data access role.

#### Description of Page

Enter a unique **Data Access Role** code and **Description** for the data access role.

The scroll area contains the **Users** who belong to this role. A user's data access roles play a part in determining the accounts (or other objects) whose data they can access.



To add additional users to this data access role, press the add button, **+**, and specify the following:

- Enter the **User ID**. Keep in mind that when you add a **User** to a **Data Access Role**, you are granting this user access to all of the accounts (or other objects) linked to the data access role's access groups.
- Use **Expiration Date** to define when the user's membership in this data access role expires.

---

**NOTE:** Also maintained on the user page. You can also use [User - Access Security](#) to maintain a user's membership in data access roles.

---

### Where Used

Follow this link to open the data dictionary where you can view the tables that reference [CL\\_DAR](#).

## Data Access Role - Access Group

Select **Admin > Security > Data Access Role** and navigate to the **Access Groups** tab to define the access groups whose accounts (or other objects) may be accessed by the users in this data access role.

### Description of Page

Use the **Access Group** collection to define the access groups whose objects can be accessed by this role's users. Keep in mind that when you add an **Access Group** to a **Data Access Role**, you are granting all users who belong to this role access to all of the accounts (or other objects) linked to the access groups.

---

**NOTE:** You can also use [Access Group - Main](#) to maintain an access group's data access roles.

---

## Defining Users

The user maintenance transaction is used to define a user's user groups, data access roles, portal preferences, default values, and To Do roles. To access the user maintenance transaction, select **Admin > Security > User**.

The user maintenance transaction is the same transaction invoked when the user launches [Preferences](#).

## Data Privacy

Personally Identifiable Information (PII) is any information that identifies or could be used in combination with other information to identify an individual. Many countries have data privacy laws governing the use of such information. A key aspect of these laws is an organization's obligation to erase personal information when there is no compelling reason to retain it. This obligation can be fulfilled either by deleting data or altering the data in such a way that it is no longer possible to associate the data with the individual.

Organizations are likely to have other legal obligations that impact how long they retain personal data. For example, there could be financial audit requirements that oblige the organization to retain relevant information for a fixed number of years after termination of a contract.

Object Erasure is designed to address right to erasure issues, with a combination of configuration and processes that may be extended to implement the appropriate policies for the PII within your data.

## The Approach to Implementing Object Erasure

This section describes the product approach to implementing object erasure for its maintenance objects (MOs).

---

**NOTE:** The approach outlined is intended for managing erasure of master data objects. The assumption is that Information Lifecycle Management will be used for archiving any related transactional data.

---

Various events in the system may signal the need to erase data at some future date. For example, closing an account may indicate the need to erase both the account and person data once there is no longer a need to maintain related financial details. There may also be events that re-establish the business relationship with a person and signal that data marked for erasure should now be retained.

The Object Erasure Schedule is used to capture key details of objects with data that needs to be erased. Records in the schedule are monitored periodically to determine if the date for erasure has been reached and if so, execute the erasure logic. The system will create and maintain records in the schedule when specific events occur for an MO that is marked for erasure.

The system provides the ability to mark an MO as eligible for erasure via a number of MO configuration entries. Included in these is an option that defines the business object for the MO's erasure schedule records. In addition to defining the erasure record elements, this BO defines the monitoring process and the specific erasure logic for the MO.

The following sections provide more information about configuring and managing object erasure.

## Configuring a Maintenance Object for Erasure

There are three types of maintenance object configuration entries that define how to manage erasure:

- An option to define the business object for erasure schedule records.
- An option to define the period between the date on which the need for erasure is detected and the date on which erasure should occur. The common logic provided by the system to add or update erasure records uses this option to determine the erasure date.
- One or more entries in the MO algorithm collection for the algorithms that determine whether a record should be scheduled for erasure, according to the current state of the record, and create or update the erasure schedule entries.

Some MOs that would commonly be regarded as eligible for erasure will be installed with a base Erasure BO already configured. The expectation is that the corresponding Erasure Period option and the algorithm for the Manage Erasure Schedule plug-in spot will be set up by your implementation with the appropriate entries for your organization's business rules.

---

**NOTE:** The presence of an Erasure Period option is the signal to the system that your implementation has enabled an object for erasure.

---

It may not be necessary for all master data objects that contain personally identifiable information to manage their own erasure schedule. For example, the event which triggers erasure for a person record may also trigger the creation of erasure schedule entries for the person's other master data records. In this case, only the person maintenance object will need to be configured with a Manage Erasure algorithm (or algorithms). Refer to your product specific documentation for more information on the recommended approaches for your product's master data objects.

## Manage Erasure Schedule Algorithm

Algorithms of this type are responsible for determining a record's erasure status and creating or maintaining an entry in the Object Erasure Schedule for the record. They are triggered when certain events occur in the system for maintenance objects that are eligible for erasure. Multiple algorithms can be configured for the plug-in spot.

Depending on the determination made by the algorithm (or algorithms), a number of different actions may need to be taken. For example:

- A new schedule record may need to be added
- An existing schedule record may need to be updated with a new erasure date

- A pending record may need to be discarded if erasure is no longer applicable
- A discarded record may need to be reactivated if erasure now applies again

The base business service **F1-ManageErasureSchedule** performs the common logic to handle the possible actions and is recommended for use by these types of algorithms. The service can also optionally create a log entry for information purposes. Refer to the description of the business service for full details.

In certain circumstances, if one record is scheduled for erasure, other related records may need to be evaluated. The base business service **F1-ManageErasureScheduleDriver** performs the logic to execute an MO's Manage Erasure Schedule algorithms. It can be used to manage any related records from within another algorithm.

This type of algorithm is plugged into the [Maintenance Object — Algorithm](#) collection.

Your product may supply algorithms to manage the schedule for base MOs that are regarded as eligible for erasure. If your organization has special business rules that are evaluated to determine the erasure schedule for an MO, a custom algorithm can be created and applied by the implementation team.

## Monitoring the Schedule and Performing Erasure

The erasure schedule is managed using the lifecycle of the erasure record's business object. A deferred monitor process is used to periodically check for records that are due for erasure and transition them from the 'pending erasure' state to the 'erased' state. An enter plug in on the 'erased' state is responsible for performing the erasure logic.

The system provides a 'root' business object for the object erasure schedule (**F1-ErasureScheduleRoot**) which defines the lifecycle that erasure schedule business objects should follow. The system also provides a monitor process (**F1-OESMN**) which is configured on the 'pending erasure' state of the 'root' business object. This process is configured to monitor object erasure schedule records whose erasure date is on or before the batch business date.

Maintenance objects that are eligible for erasure should be configured with an erasure schedule business object that uses the 'root' business object as its parent. The algorithm that performs the erasure processing applicable to that maintenance object must be plugged in on the 'erased' state of the 'child' business object.

The system provides an erasure schedule business object (**F1-ErasureScheduleCommon**) which is designed to erase an object by deleting the main record and any child records. Your product may supply additional erasure schedule business objects for certain use cases. Refer to your product specific documentation for more information.

## Erasing User Information By Obfuscation

Some implementations consider the base User object to have personally identifiable information. Erasing user information by deleting the records is not advisable as it can cause referential integrity problems. The recommended approach is to obfuscate the data instead.

The system provides a user erasure business object (**F1-ErasureScheduleUser**) which is designed to support obfuscating a user's identifiable information by removing it or replacing it with a non-identifiable value if the field is required.

If the User maintenance object is configured to be eligible for erasure in your implementation, the manage erasure schedule algorithm for the record will be invoked whenever the **Enable** flag is changed for a record on the User maintenance page. The system provides a base algorithm (**F1-OBJERSUSR**) specifically for the User MO. This algorithm will add an entry to the object erasure schedule if the user record is disabled or deactivate an existing erasure schedule record if a disabled user record is enabled again.

## Viewing an Object's Erasure Status

The system provides a portal for viewing and editing an erasure schedule record. The portal is accessed from the **Object Erasure Schedule** dashboard zone. This is a context sensitive zone which only appears when accessing a record for a maintenance object that is configured to be eligible for erasure. It displays the information for the erasure schedule entry for the record in context, if applicable.

To add the zone to an eligible maintenance object:

- Navigate to [Context Sensitive Zone](#) and search for the navigation key for the maintenance object.
- Add the Object Erasure Schedule zone **F1-OBJESRSCD** to that navigation key.

## Viewing Erasure Configuration

The Erasure Configuration [All-in-One portal](#) provides the ability to view the maintenance objects that are marked as eligible for erasure and maintain their erasure configuration entries in a single place.

To view a list of the eligible MOs, open **Admin > Security > Erasure Configuration**.

Press the edit icon to open a window in which the configuration values for that row can be changed.

Refer to [The Approach to Implementing Object Erasure](#) for an overview of object erasure configuration.

## Archiving the Object Erasure Schedule

The system provides the ability to archive older records in the object erasure schedule using Information Lifecycle Management. The object erasure schedule maintenance object is configured with a base ILM eligibility algorithm and an ILM crawler batch control.

The base object erasure schedule BO is configured to set the ILM archive switch when an erasure schedule record enters a final state and to reset it if the record becomes active again.

Refer to [The Approach to Implementing Information Lifecycle Management](#) for more information on archiving functionality.

## Cryptography Keys

Often when communicating information with an external system, cryptography keys are used to exchange encrypted information or confirm that the two communicating parties recognize each other and the information being provided.

The following sections include information about the functionality provided to support this functionality.

## Understanding Key Rings

Cryptography keys may be used to provide a signature to a request so that the system recognizes that the request comes from a trusted party. Keys may also be used to encrypt or decrypt files shared between two parties.

In this release, support for a Signature type of key is provided to be able to access files stored in Oracle Cloud Object Storage. This support is only applicable for cloud customers.

The product supports the ability for the following:

- A pair of keys - public and private. For keys generated in the system, the private key is stored in an appropriate "secret store" and the public key is available to copy and share with a third party.
- Key rotation. For increased security, a new key pair should be generated periodically.

The Key Ring object is provided to reference the key pairs that are used over time for a given business use case. Only one key pair may be active at any given time.

The following sections include information about the functionality provided to support this functionality.

## Signature Keys

Oracle Cloud Object Storage is used by cloud customers to store any files that are needed by the system. Certain processes in the system may need to write files to or read files from cloud object storage. Cloud object storage has its own method for encrypting files and products using the framework application do not need to define additional configuration for that. However, when communicating with cloud object storage, the application is required to provide a signature key.

Refer to [External File Storage](#) for more information about configuring the system to connect to cloud object storage.

The product provides a Signature Key Ring business object that is available for cloud customers. This business object provides the following support

- Generating a key pair, for key rotation
- Viewing the public key, allowing a user to copy it to register it with cloud object storage.
- Activating the new key pair (to be done after registering the new public key)

## Defining Key Rings

Refer to [Understanding Key Rings](#) for an overview of key ring functionality.

To maintain the key rings applicable to your product or implementation, open **Admin > Security > Key Ring**.

This is a standard [All-in-One portal](#) and includes the standard List and display zones for a statistics control.

The information captured on the key ring depends on the business objects supported by your product or implementation. Refer to the embedded help text for more information.

### Key Pairs

The key pair zone provides information about the keys that are associated with the key ring. Actions available on the zone depend on the type of key. Refer to embedded help for more information.

## User Interface Tools

This section describes tools that impact many aspects of the user interface.

## Defining Menu Options

The contents of this section describe how you can add and change menus.

---

**CAUTION:** Updating menus requires technical knowledge of the system. This is an implementation and delivery issue and should not be attempted if you do not have previous experience with menus.

---

**NOTE: Security and menus.** Refer to [Application Security](#) for a discussion of how application security can prevent menu items (or an entire menu) from appearing.

---

**NOTE: Module configuration and menus.** Your [module configuration](#) can prevent menu items (or an entire menu) from appearing.

---

## Menu - Main

This transaction is used to define / change any menu in the system. Navigate to this page using **Admin > System > Menu**.

### Description of Page

Enter a meaningful, unique **Menu Name**.

**Owner** indicates if this menu line is owned by the base product or by your implementation (**Customer Modification**). The system sets the owner to **Customer Modification** when you add a menu line. This information is display-only.

The **Flush Menu** button is used to flush the cached menu items so you can see any modified or newly created menus. Refer to [Caching Overview](#) for more information.

**Menu Type** defines how the menu is used. You have the following options:

- **Admin** is one of the menus that appears in the Application Toolbar. It is a special type of menu because [admin menu](#) items can be grouped alphabetically or by functional group. Refer to the description of Admin Menu Order on [Installation Options - Framework](#) for more information about admin menu options.
- **Context** refers to a [context menu](#).
- **Main** is another menu that appears in the Application Toolbar that is simply titled [Menu](#).
- **Page Action Menu** defines buttons that appear in the [Page Title Area](#).
- **Submenu** defines a menu group that appears when an Application Toolbar menu is selected. for the Admin menu, this is only visible when it's organized functionally.
- Enter **User Menu** refers to the menu items that appear on the [user menu](#); for example, User Preferences.

**Description** provides a description of the menu. Note that this is not the text used when displaying a menu option.

**Sequence** is only enabled for the **Main** and **Admin** menu types.

The grid contains a summary of the menu's lines. Besides the standard add and delete icons available in a grid, the following information is displayed:

- **Menu Line ID** is the unique identifier of the line on the menu. This information is display-only. Before the menu line id is a Go To icon that allows a user to drill into the Menu Items for the displayed menu line.
- **Sequence** is the relative position of the line on the menu. Note, if two lines have the same **Sequence**, the system organizes the lines alphabetically (based on the **Long Label**, which is defined on the next tab).

---

**NOTE:** An implementation may override the sequence of a base product owned menu line. Also note that the sequence is defined on the menu line language table, allowing for different orders to be used for different languages (or to let the menu be sorted alphabetically in one language and in a specified order in a different one).

---

- **Navigation Option / Submenu** contains information about the line's items. If the line's item invokes a submenu, the submenu's unique identifier is displayed. If the line's item(s) invoke a transaction, the description of the first item's [navigation option](#) is displayed.
- **Long Label** is the verbiage that appears on the menu line.
- **Item Count** is the number of menu items on the line.
- **Owner** indicates if this menu line is owned by the base product or by your implementation (**Customer Modification**). The system sets the owner to **Customer Modification** when you add a menu line. This information is display-only.

---

**NOTE: Adding menu lines to base owned menus.** An implementation may choose to add custom menu lines along with its menu item (or items) to a base owned menu.

---

Refer to the description of [Menu Items](#) for how to add items to a menu line.

## Menu - Menu Items

Once a menu has lines (these are maintained on the main page), you use this page to maintain a menu line's items.

Each menu line can contain one or two menu items. The line's items control what happens when a user selects an option on the menu.

There are two types of menu lines that define a single menu item: one type causes a submenu to appear; the other type causes a transaction or script to be invoked when it's selected.

- The following is an example of a menu line with a single item that opens a submenu:

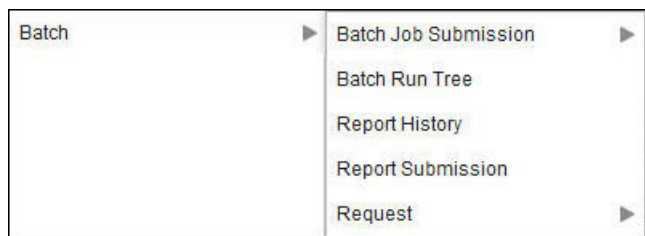

- The following is an example of a menu line with a single menu item that launches a transaction or script:

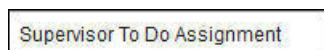

A menu line that defines two menu items is used to provide an Add option and a Search option for the same type of object. In this case each menu item defines a transaction or script to be launched. The menu is rendered with the Add and Search options displayed. The following is an example of a menu line with two menu items.



Navigate to this tab by clicking the Go To button adjacent to a menu line from the Main tab.

### Description of Page

**Menu Name** is the name of the menu on which the line appears. **Menu Line ID** is the unique identifier of the line on the menu. **Owner** indicates if this menu is owned by the base product or by your implementation (**Customer Modification**). This information is display-only.

The **Menu Line Items** scroll contains the line's menu items. The following points describe how to maintain a line's items:

- **Menu Item ID** is the system assigned unique identifier of the item.
- **Owner** indicates if this item is owned by the base product or by your implementation (**Customer Modification**).
- If the menu item should invoke a submenu:
  - Use **Sub-menu Name** to identify the menu that should appear when the line is selected
  - Use **Long Label** to define the verbiage that should appear on the menu line
  - Populate the **Override Label** to override the long label of a base product owned sub-menu.
- If the item should invoke a transaction or BPA script:
  - Use **Sequence** to define the order the item should appear in the menu line (we recommend this be set to **1** or **2** as a menu line can have a maximum of 2 menu items). The “search” menu item should be defined as sequence 1 and the “add” menu item as sequence 2 given that the label of the “search” menu item is used for the menu line’s label.
  - Use **Navigation Option** to define the transaction or script to open. Refer to [Defining Navigation Options](#) for more information.

- For a menu line that includes two items — one for Add and one for Search, if one of the items includes configuration for **Image GIF Location and Name**, the system assumes that this represents the Add. This functionality is a carryover from earlier releases where the Add function rendered in the menu with a “+” image, which also identified the item that represents the Add. If neither item includes Image configuration (because it is no longer needed for rendering the menu), the system relies on the order of the items as mentioned above. The first item is the “search” and the second item is the “add”.
- **Image Height, Image Width** and **Balloon Description** are not applicable at this time.
- Use the **Long Label** to define the text to appear on the menu entry. Note that when a menu line defines two menu items, the long label on the search entry is used to build the menu entry text. The label long on the menu line that defines the Add option is information only.
- The **Override Label** is provided in case you want to override the base-package's label.
- Use **Application Service** and **Access Mode** to easily suppress a menu item for one or more users. Refer to [Application Security](#) for more information.

## The Big Picture of System Messages

All error, warning and informational messages that are displayed in the system are maintained on the message table. Every message is identified by a combination of two fields:

- **Message category number.** Think of a message category as a library of messages related to a given functional area. For example, there is a message category for billing messages and another one for payment messages.
- **Message number.** A unique number identifies each message within a category.

Every message has two components: a brief text message and a long description. On the **Main** tab, you can only maintain the brief message. If you need to update a message's long description, you must display the message on the **Details** tab.

---

**NOTE: You cannot change the product's text.** If the message is "owned" by the product, you cannot change the product's message or detailed description. If you want your users to see a different message or detailed description other than that supplied by the product, display the message on the **Details** tab and enter your desired verbiage in the "customer specific" fields (and flush the [cache](#)).

---

## Defining System Messages

The contents of this section describe how to maintain messages that appear throughout the system. An implementation may introduce messages used in custom processes or may choose to override the text for messages delivered by the product.

### Message - Main

Select **Admin > System > Message** to maintain a message category and its messages.

#### Description of Page

To add a new message category, enter a **Message Category** number and **Description**.

---

**CAUTION:** Message category 80000 or greater must be used to define new messages introduced for a specific implementation of the system. Changes to other Message Text will be overwritten when you next upgrade. If you want to make a change to a Message, drill down on the message and specify Customer Specific Message Text. Note that even for message categories 80000 and higher, message numbers lower than 1000 are reserved for common base product messages.

---



---

**NOTE: Owner** indicates if this message category is owned by the base product or by your implementation (**Customer Modification**). The system sets the owner to **Customer Modification** when you add a category. This information is display-only.

---

To update a message, you must first display its **Message Category**. You can optionally start the message grid at a **Starting Message Number**.

To override the message text or detailed description of messages owned by the base product, click on the message's go to button. When clicked, the system takes you to the **Details** tab on which you can enter your implementation's override text.

The following points describe how to maintain messages owned by your implementation:

- Click the - button to delete a message.
- Click the + button to add a new message. After clicking this button, enter the following fields:
- Use **Message Number** to define the unique identifier of the message within the category.
- Use **Message Text** to define a basic message. You can use the %n notation within the message text to cause field values to be substituted into a message. For example, the message text **The %1 non-cash deposit for %2 expires on %3** will have the values of 3 fields merged into it before it is displayed to the user (%1 is the type of non-cash deposit, %2 is the name of the customer, and %3 is the expiration date of the non-cash deposit).

---

**NOTE:** The system merges whatever values are supplied to it. Therefore, if a programmer supplies a premise address as the second merge parameter in the above message, this address is merged into the message (rather than the customer's name).

---

- **Owner** indicates if this message number is owned by the base product or by your implementation (**Customer Modification**). The system sets the owner to **Customer Modification** when you add a message. This information is display-only.
- Click the go to button to enter a detailed description of the message. Clicking this button transfers you to the **Details** tab.

#### Where Used

Follow this link to open the data dictionary where you can view the tables that reference [CI\\_MSG](#). In addition, messages are used throughout the system for error messages and other system messages.

## Message - Details

Select **Admin > System > Message** and navigate to the **Details** tab to define detailed information about a message.

---

**NOTE: Drilling in from the Main tab.** Rather than scrolling through the messages, you can display a message by clicking the respective go to button in the grid on the main tab.

---

#### Description of Page

The **Message Collection** scroll contains an entry for every message in the grid on the Main tab. It's helpful to categorize messages into two categories when describing the fields on this page:

- Product messages
- Implementation-specific messages (i.e., a message added to **Message Category** 80000 or greater)

For product messages, you can use this page as follows:

- If you want to override a message, specify **Customer Specific Message Text**.
- You are limited to the same substitution values used in the original **Message Text**. For example, if the original **Message Text** is **The %1 non-cash deposit for %2 expires on %3** and %1 is the type of non-cash deposit, %2 is the name of the customer, and %3 is the expiration date of the non-cash deposit; your **Customer Specific Message Text** is limited to the

same three substitution variables. However, you don't have to use any substitution variable in your message and you can use the substitution variables in whatever order you please (e.g., %3 can be referenced before %1, and %2 can be left out altogether).

- If you want to override the detailed description of an error message, specify **Customer Specific Description**. Note that the system does not present detailed descriptions when warnings are shown to users. Therefore, it doesn't make sense to enter this information for a warning message.

For implementation-specific messages, you can use this page as follows:

- **Message Text** is the same Message Text displayed on the main tab.

---

**CAUTION:** If both **Message Text** and **Customer Specific Message Text** are specified, the system will only display the **Customer Specific Message Text** in the dialog presented to the user.

---

- Use **Detailed Description** to define additional information about an error message. Note that the system does not present detailed descriptions when warnings are shown to users. Therefore, it doesn't make sense to enter this information for a warning message.

---

**CAUTION:** If both **Detailed Description** and **Customer Specific Description** are specified, the system will only display the **Customer Specific Description** in the dialog presented to the user.

---

## The Big Picture of Portals and Zones

A portal is a page that is comprised of one or more information zones. The base product pages are built using either a fixed page metaphor or using portals and zones. The contents of this section describe general information about portals and zones.

### There Are Three Types of Portals

There are three broad classes of portals:

- **Standalone Portal.** Standalone portals are separate pages where the main tab of the page is built using a portal. These pages are opened using any of the standard methods (e.g., by selecting a menu item, by selecting a favorite link, etc.). Additional tabs for a stand-alone portal may be included using tab page portals.
- **Tab Page Portals.** These types of portals cannot be attached to a menu. They simply define the zones for a tab on either a standalone portal or on a “fixed” page. Please contact customer support if you need to add portals to existing transactions.
- **Dashboard Portal.** The dashboard portal is a portal that appears in the [Dashboard Area](#) on the user's desktop. Its zones contain tools and information that exist on the user's desktop regardless of the transaction.

There is only one dashboard portal. This portal and several zones are delivered as part of the base-package. Your implementation can add additional zones to this portal. Please contact customer support if you need to add zones to the dashboard portal.

### Common Characteristics of All Portals

The topics that follow describe characteristics common to all types of portals.

### Portals Are Made Up of Zones

A portal is a page that contains one or more zones, and each zone contains data of some sort.

All zones reference a **Zone Type**. The zone type controls the behavior of the zone and the parameters available to configure the zone.

## Configuring Zones for a Portal

The portal includes configuration of how the zones should appear on the portal by default. This includes the following options, all of which may be overridden by an implementation.

- The order in which the zone should appear. An implementation may configure an override sequence to change the order zones on a base delivered portal.
- Whether the zone is visible on the portal. Zones delivered in the base product should be configured to be visible. But an implementation may override this if desired.
- Whether the zone should display initially collapsed or not. A zone's data is only retrieved when it is expanded. As such, a zone may be configured to be initially collapsed when the data is not needed very often. A user can expand the zone when the information is required. Implementations may change the collapsed setting of a base product portal / zone.

---

**FASTPATH:** Refer to [Zones May Appear Initially Collapsed When a Page Opens](#) for more information.

---

**FASTPATH:** Refer to [Defining Portals](#) for more information about this configuration.

---

In addition, the portal includes configuration to indicate whether or not the portal should appear on a user's portal preferences. This is typically enabled for a portal that provides disparate information where not all zones are applicable to all users or where users may wish to adjust the order of the zones. An example of a portal enabled for portal preferences is the Dashboard portal. The user can override zone oriented configuration for the portal:

- Which zones appear on that portal
- The order in which the zones appear
- Whether the zones should be initially collapsed when the portal opens.
- The refresh seconds. This is applicable to zones displaying data that changes often.

An implementation can optionally configure the system to define portal preferences on one or more "template" users. When a template user is linked to a "real" user, the real user's preferences are inherited from the "template" user and the "real" user cannot change their preferences. Some implementations opt to work this way to enforce a standard look and feel for users in the same business area.

---

**FASTPATH:** Refer to [User — Portal Preferences](#) for more information about how users configure their zones.

---

## Granting Access to Zones

An [application service](#) is associated with each zone. A user must be granted access rights to the respective application service in order to see a zone on a portal.

---

**FASTPATH:** Refer to [The Big Picture Of Application Security](#) for information about granting users access rights to an application service.

---

Please note the following with respect to zone application security:

- For most base product portals, all the zones for all the portals reference the same application service that is used to grant access to the main (stand-alone) portal for the page. In other words, if the user has access to the page, then he has access to all the zones on all portals for the page. There may be exceptions to this rule for certain portals.
- For a base product multi-query zones, typically the individual query zones and the multi-query zone reference the same application service that is used to grant access to the main (stand-alone) portal for the page. However, there may be

individual query zones provided with a unique application service. This may occur when the query option is unusual and not applicable to all users or even to all implementations. If a user does not have security access to an individual query zone, that option will not be available in the dropdown.

- For base product portals that are configured to show on portal preferences, it is common that the portal contains different types of zones that may be applicable to different types of users. Typically these types of portals will deliver a unique application service for each zone so that an implementation may configure which user groups are allowed to view each zone. For these types of portals, please note the following:
  - A user's [Portal Preferences](#) page contains a row for a zone regardless of whether the user has access rights to the zone. Because of this, the system displays an indication of the user's access rights to each zone.
  - If a user's access rights to a zone are revoked, the zone will be suppressed when the user navigates to the respective portal.
  - Revoking a user's access rights does not change the user's [portal preferences](#) (i.e., a user can indicate they want to see a zone even if they don't have access to the zone - such a zone just won't appear when the respective portal appears).

---

**NOTE: If you don't need to use zone security.** When defining a zone, an application service is required. For zones that don't require special security, the product provides a "default" application service (F1-DFLTS) that may be used. The expectation is that all user groups are granted access to this application service.

---

## Common Characteristics of Stand-Alone Portals

The topics that follow describe additional characteristics specific to [stand-alone portals](#).

### Putting Portals on Menus

A stand-alone portal should appear as a menu item on one of your menus. The following points provide how to do this:

- Every stand-alone portal has an associated navigation option. You can see a portal's navigation option on the [Portal - Main](#) page.
- To add a portal to a menu, you must add a [menu item](#) to the desired menu. This menu item must reference the portal's navigation option. There are two ways to add a menu item:
- If the portal's navigation option doesn't currently exist on a menu, you can press the **Add To Menu** button on the [Portal - Main](#) page. When you press this button, you will be prompted for the menu. The system will then create a menu item on this menu that references the portal's navigation option.
- You can always use the [Menu](#) page to add, change and delete menu items.

---

**NOTE: No limit.** A portal's navigation option can appear on any number of menu items (i.e., you can create several menu items that reference the same portal).

---

---

**NOTE: Favorite links.** Your users can set up their preferences to include the portal's navigation option on their [Favorite Links](#). This way, they can easily navigate to the portal without going through menus.

---

### Granting Access to A Portal

An [application service](#) is associated with each [stand-alone portal](#). A user must be granted access rights to the respective application service in order to see a portal. Tab portals do not have separate security access. If a user has access to the main stand-alone portal, then the user will have security access to all its tabs. However, as mentioned in [Granting Access to Zones](#), in some scenarios, the individual zones on the portal may have different security access rights depending on the functionality.

---

**FASTPATH:** Refer to [The Big Picture Of Application Security](#) for information about granting users access rights to an application service.

---

**NOTE: Automatically created.** When you add a new stand-alone portal, the system automatically creates an application service behind the scenes. You'll need to know the name of this application service as this is what you use to grant access to the portal. The name of each stand-alone portal's application service is shown on the portal transaction.

---

Please note the following in respect of how application security impacts a user's portals:

- A user's [Portal Preferences](#) page only shows the portals configured to show on user preferences and where they have security access.
- The system's menus only show portals to which a user has security access.
- Users can set up favorite links to all portals, but they must have security rights to the portal's application service in order to invoke the favorite link.

## Custom Look and Feel Options

The default look and feel of the application can be customized via feature configuration and cascading style sheets. The base product is provided with a **Custom Look And Feel Feature Configuration** type. You may want to set up a feature configuration of this type to define style sheet and UI Map help options.

## User Interface

The base product allows for the conditional inclusion of custom style sheets into the system style set. Custom styles may override any style provided by the base product. The style sheet may also include new styles for use in customer zone definitions. Use the **Style Sheet** option on the **Custom Look And Feel Feature Configuration** to define your custom style sheet.

---

**NOTE:** Some styles cannot change if they are part of the HTML code.

---

**CAUTION:** Implementers must ensure that the customized user interface is stable and scalable. Changing font, alignment padding, border size, and other user interface parameters may cause presentation problems, like scrollbars appearing or disappearing, cursors not working as expected, and unanticipated look and feel alterations of some layouts.

---

## UI Map Help

A [tool tip](#) can be used to display additional help information to the user. This applies to section elements as well as individual elements on a map zone or UI Map. Refer to the tips context sensitive zone associated with the UI Map page for more information. The **Custom Look And Feel Feature Configuration** provides options to control the following:

- Whether UI Map Help functionality is turned on or off. By default it is turned on.
- Override the default help image with a custom image
- The location of the help image, either before or after the element.

---

**FASTPATH:** Refer to the feature configuration for a detailed description of each option.

---

## Setting Up Portals and Zones

The topics in this section describe how to set up portals and zones. Please refer to [The Big Picture of Portals and Zones](#) for background information.

### Defining Zone Types

A Zone Types represents a particular type of zone with a specific behavior. For example, a data explorer zone type is used to select data using a specific SQL statement and display the data based on parameter configuration. The zone type defines the Java Class that controls the behavior of the zone and defines the parameters that the Java Class supports. The base product supports many zone types used to build the portal / zone user interface. Implementations may introduce their own zone types.

---

**NOTE:** It is not very common for an implementation to introduce their own zone types.

---

Select **Admin > System > Zone Type** to maintain zone types.

#### Description of Page

Specify an easily recognizable **Zone Type** code and **Description**. Use the **Detailed Description** to describe in detail what the zone type does.

---

**CAUTION:** When adding new zone types, carefully consider its naming convention. Refer to [System Data Naming Convention](#) for more information.

---

**Owner** indicates if this zone type is owned by the base product or by your implementation (**Customer Modification**). The system sets the owner to **Customer Modification** when you add a zone type. This information is display-only.

**Java Class Name** is the Java class responsible for building the zone using the parameters defined below.

Two types of parameters are specified when defining a zone type:

- Parameter values that have a **Usage** of **Zone** are defined on the zones and control the functionality of each zone governed by the zone type. A **Usage** value of **Zone - Override Allowed** indicates that an implementation may override the parameter value for a base zone.
- Parameter values that have a **Usage** of **Zone Type** are defined directly on the zone type and control how the zone type operates (e.g., the name of the XSL template, the name of the application service). A **Usage** value of **Zone Type - Override Allowed** indicates that an implementation may override the parameter value for a base zone type.

The following points describe the fields that are defined for each parameter:

- **Sequence** defines the relative position of the parameter.
- **Parameter Name** is the name of the parameter.
- **Description** is a short description that allows you to easily identify the purpose of the parameter.
- **Comments** contain information that you must know about the parameter or its implementation. For parameters with a usage of **Zone** or **Zone — Override Allowed**, this information is visible to the user when viewing or defining this parameter for a zone of this type.
- **Usage** indicates whether the parameter value is defined in a **Zone** of this type or in the **Zone Type**. **Zone - Override Allowed** and **Zone Type - Override Allowed** indicate that override values for the parameters defined in a base zone or base zone type can be entered.
- **Required** is checked to indicate that a zone must define a value for the parameter. It is not checked if a value for the parameter is optional. This field is protected if the **Usage** is **Zone Type** or **Zone Type - Override Allowed**.

- **Parameter Value** is used to define the value of zone type parameters. This field is protected if the **Usage** is **Zone** or **Zone - Override Allowed**.
- **Owner** indicates if this parameter is owned by the base product or by your implementation (**Customer Modification**). The system sets the owner to **Customer Modification** when you add a parameter. This information is display-only.

#### Where Used

Follow this link to open the data dictionary where you can view the tables that reference [CI\\_ZONE\\_HDL](#).

## Zone Type Parameter Comments

For the product owned zone type parameters, the parameter's detailed description provides the detail needed for properly configuring the parameter. For the Action parameters (IMPLEMENTOR\_ACTION\_n), the parameter description is abbreviated. Additional detail about configuring this parameter may be found in the [Zone Action Parameter](#) detailed information. The same details apply.

## Defining Zones

The contents of this section describe how to maintain zones.

### Zone - Main

Implementations may use the zone page to define custom zones. In addition, an implementation may override descriptions or some parameter values for base product zones.

Select **Admin > System > Zone** to create or maintain a zone.

#### Description of Page

Specify an easily recognizable **Zone** identifier and **Description**. Note that if this zone appears on a portal, this description acts as the zone title.

**Override Description** is provided if your implementation wishes to override the description of the value provided by the product.

---

**CAUTION:** Important! When introducing a new zone, carefully consider its naming convention. Refer to [System Data Naming Convention](#) for more information.

---

**Owner** indicates if this zone is owned by the base product or by your implementation (**Customer Modification**). The system sets the owner to **Customer Modification** when you add a zone. This information is display-only.

**Zone Type** identifies the zone type that defines how the zone functions.

**Application Service** is the application service that is used to provide security for the zone. Refer to [Granting Access To Zones](#) for more information.

The **Width** defines if the zone occupies the **Full** width of the portal or only **Half**.

---

**NOTE:** Zones on the [dashboard portal](#) are always the width of the dashboard.

---

If the zone type supports help text, you can use **Zone Help Text** to describe the zone to the end-users. Note that for multi-query zones, if the multi-query zone has help text, that is displayed for any zone selected. If the multi-query zone does not have help text, but the selected zone has help text, the selected zone's help text is displayed. Please refer to the section on [zone help text](#) for more information on how you can use HTML and cascading style sheets to format the help text.

Use **Override Zone Help Text** to override the product provided help text for this zone.



---

**NOTE: Viewing Your Text.** You can press the **Test** button to see how the help text will look when it's displayed in the zone.

---

The grid contains the zone's parameter values. The Zone Type controls the list of parameters. The grid contains the following fields:

- **Description** describes the parameter. This is display-only. Note that if there is a detailed description on the zone type parameter, an **icon** appears next to the parameter's description. Click the icon to see details related to the parameter, including tips on how to populate the parameter value.

---

**NOTE: Additional Details for Some Parameters.** There are several parameter types that have a lot of detail related to the possible configuration that cannot easily fit into the detailed description. Refer to [Zone Parameter Details](#) for additional information about these parameters.

---

- **Parameter Value** is the value for the parameter.
- Use **Override Parameter Value** to override the existing value for this parameter. This field is enabled when the related zone type parameter value is **Zone - Override Allowed**, and the zone is owned by the base product.
- **Owner** indicates if this parameter is owned by the base product or by your implementation (**Customer Modification**). This information is display-only.

#### Where Used

Follow this link to open the data dictionary where you can view the tables that reference [CI\\_ZONE](#).

## Zone - Portal

Select **Admin > System > Zone** and navigate to the **Portal** tab to define the portals on which a zone appears.

#### Description of Page

The scroll area contains the portals on which the zone appears.

To add a zone to a portal, press the + button and specify the **Portal**.

---

**NOTE: Owner** indicates if this portal / zone relationship is owned by the base product or by your implementation (**Customer Modification**). This information is display-only.

---

---

**NOTE:** You can also add a zone to a portal using [Portal - Main](#). Additional configuration about how the zone appears on the portal is available only on the Portal.

---

## Zone Configuration Topics

The topics in this section provide additional information related to setting up your zones.

### Zone Help Text

Most zone types support a button that allows a user to see zone-specific help text, which is defined on the zone page.

You can use HTML tags in the zone help text. The following is an example of help text that contains a variety of HTML tags:

**This zone summarizes <font color=blue><b>revenue</b></font> in 4 periods:<br>**

The above would cause the word **revenue** to be bold and blue:

- **<b>** and **</b>** are the HTML tags used to indicate that the surrounded text should be bold



- `<font color=blue>` and `</font>` are the HTML tags used to indicate that the surrounded text should be blue.

The following are other useful HTML tags:

- `<br>` causes a line break in a text string. If you use `<br><br>` a blank line will appear.
- `<i>` causes the surrounded text to be italicized

Please refer to an HTML reference manual or website for more examples.

You can also use "spans" to customize the look of the contents of a text string. For example, your text string could be `<span style="font-family:Courier; font-size:large; font-weight:bold;">revenue</span>`. This would make the word "revenue" appear as large, bold, Courier text. Please refer to a Cascading Style Sheets (CSS) reference manual or website for more examples.

The following is an example of help text using a variety of HTML tags:

```
<font FACE="arial" size=2>
```

This zone summarizes `<font color=blue><b>revenue</b></font>` in 4 periods:`<br>`

- The `<b>1st period</b>` is under your control. You simply select the desired `<b>Period</b>`, above `<i>`(you may need to click the down arrow to expose the filter section)`</i><br>`
- The `<b>2nd period</b>` is the period before the 1st period`<br>`
- The `<b>3rd period</b>` is the same as the 1st period, but in the previous year`<br>`
- The `<b>4th period</b>` is the period before the 3rd period`<br>`

```
<br>
```

The traffic light's color is determined as follows:`<br>`

- The ratio of the 1st and 3rd period is calculated`<br>`
- If this value is between 80 and 100, `<font color=orange><b>yellow</b></font>` is shown`<br>`
- If this value is < 80, `<font color=red><b>red</b></font>` is shown`<br>`
- If this value is > 100, `<font color=green><b>green</b></font>` is shown`<br>`
- If the value of the 3rd period is 0, no color is shown`<br>`

```
</font>
```

---

**NOTE:** It is possible to associate tool tip help with individual HTML and UI map elements. For more information, see [UI Map Help](#).

---

## Zone Parameter Details

For most zone parameters, the embedded help for the parameter provides the detailed information needed for configuring the parameter values. For some parameters with very detailed descriptions, the embedded help is abbreviated and more detail is provided here.

## Zone Visibility Service Script

All zones support a visibility script that is used to determine if the zone should be displayed to the user or not based on conditions. The script may receive input parameters and is expected to return a Boolean value indicating if the zone should be displayed or not. The embedded help for the **Zone Visibility Service Script** parameter provides details related to the syntax.

The following table highlights some service scripts provided by the product that may be used if applicable to your zone's requirements. This is not an exhaustive list of visibility scripts. There may be others that are specific to a given zone.

Script Code	Description	Comments
F1-ShldShwZn	Zone Visibility - Display Zone in Portal	This script simply returns a value of 'true' and is used when the zone should always appear.
F1-CondShwZn	Zone Visibility - Display Zone in Portal Conditionally	This is used when the condition for showing the zone is based on the population of a context value. This is commonly used when one zone in the portal should only appear after a broadcast of a record from another zone in the portal.  For an example of a zone the uses this visibility script, refer to <b>F1-BSFTYPE</b> .
F1-RwCtShwZn	Zone Visibility - Based on Row Count	This is used when the condition for showing the zone is based on the existence of one or more rows that can be determined using SQL. This script accepts a zone code, user filters 1 through 25 and hidden filters 1 through 10. The script returns an indication of 'true' if at least one row count is returned by the zone.  To use this visibility script, a specific data explorer zone must be developed for the specific use case.  For an example of a zone the uses this visibility script, refer to <b>F1-MIGRREQEL</b> .

## SQL Statement

Data explorer zones are used to select data to display using one or more SQL statements. The SQL parameters are applicable to the following zone types

- Info Data Explorer - Single SQL (**F1-DE-SINGLE**). The parameter has the description **SQL Statement**.
- Info Data Explorer - Multiple SQLs (**F1-DE**). The parameters follow the description pattern of **SQL Statement x**.
- Query Data Explorer - Multiple SQLs (**F1-DE-QUERY**). The parameters follow the description pattern of **SQL Statement x**.

**NOTE:** If your implementation has been configured to restrict the functions that may be used when defining an SQL then an error is issued at runtime if there are functions found that are not in the whitelist. The whitelist may be viewed using the **View SQL function whitelist** link in the Tips zone on the zone maintenance page.

The following table provides a list of SQL substituted keywords that may be used in the SQL Statement parameters in explorer zones. At execution time, the system determines the database and substitutes the keyword with the database specific syntax:

Keyword	Description	Examples
@toCharacter()	Converts the input to Character data type.	select @toCharacter(batch_cd) as batchCode from ci_batch_ctrl
@toDate()	Converts the input to Date data type.	select @toDate(last_update_dttm) as lastUpdateDate from ci_batch_ctrl
@toNumber()	Converts the input to Number data type.	select @toNumber(next_batch_nbr) from ci_batch_ctrl
@currentDate	Fetches the current date.  <b>CAUTION:</b> The Oracle functions <b>SYSDATE</b> and <b>CURRENT_DATE</b> should not be used because they do not properly cater for adjusting dates from the database time zone to the installation time zone, if needed.	select batch_cd, @currentDate as today from ci_batch_ctrl
@currentTimestamp	Fetches the current date / time.	select batch_cd from ci_batch_ctrl where last_update_dttm > @currentTimestamp

Keyword	Description	Examples
	<p><b>CAUTION:</b> The Oracle functions <b>SYSTEMSTAMP</b> and <b>CURRENT_TIMESTAMP</b> should not be used because they do not properly cater for adjusting the date / time from the database time zone to the installation time zone, if needed.</p>	
<b>@concat</b>	Combines the result list of two or more columns.	select batch_cd <b>@concat</b> next_batch_nbr concatNbr from ci_batch_ctrl
<b>@substr(string, start)</b>	<p><b>String</b> is the input String that you are trying to get a substring of.</p> <p><b>Start</b> is the position of the character for the output results.</p>	<p>select batch_cd batchCode from ci_batch_ctrl Result: TESTCD</p> <p>select <b>@substr</b>(batch_cd,3) batchCode from ci_batch_ctrl Result: STCD</p>
<b>@substr(string, start, end)</b>	<p><b>String</b> is the input String that you are trying to get a substring of.</p> <p><b>Start</b> is the position of the character for the output results.</p> <p><b>End</b> is the number of characters required in the output from starting position.</p>	<p>Select batch_cd batchCode from ci_batch_ctrl Result: TESTCD</p> <p>select <b>@substr</b>(batch_cd,3,2) batchCode from ci_batch_ctrl Result: ST</p>
<b>@trim</b>	Trims the white spaces of the output on both sides.	select <b>@trim</b> (batch_cd) as batchCode from ci_batch_ctrl
<p>The following syntax is related to 'fuzzy' searching. It is only applicable if Oracle DB Text is enabled and a context text index has been created. Refer to <a href="#">Advanced Search Options</a> for more information.</p>		
<b>@fuzzy(string, score, numresult, 'weight')</b>	<p><b>String</b> is the input value for the search.</p> <p><b>Score</b> is the degree of 'fuzziness'. Valid values are between 1 - 80. The higher the number the more precise the search. Default is 60.</p> <p><b>Numresults</b> is the number of variations to consider for the string. Valid values are between 1 and 5000. Default is 100.</p> <p>Indicate '<b>weight</b>' to signal that the results are returned in order of weight. Leave this setting off to indicate that the results are returned in order of score.</p>	<p>Set score to 70, number results to 6, and specify weight.</p> <p>select user_id, last_name from sc_user where contains(last_name, <b>@fuzzy</b>(:F1,70, 6, 'weight')) &gt; 0</p>
<b>@fuzzy(string)</b>	This returns a string result from the fuzzy expansion operation where the default value of 60 is assumed for the <b>score</b> and the default value of 100 is assumed for the <b>numresult</b> .	<p>To use default values:</p> <p>select user_id, last_name from sc_user where contains(last_name, <b>@fuzzy</b>(:F1))&gt; 0</p>
<b>@fuzzy(string, score)</b>	This returns a string result from the fuzzy expansion operation with the <b>score</b> specified and the default value of 100 for the <b>numresult</b> .	<p>Set score to 70.</p> <p>select user_id, last_name from sc_user where contains(last_name, <b>@fuzzy</b>(:F1,70)) &gt; 0</p>
<b>@fuzzy(string, score, numresult)</b>	This returns a string resulted from the fuzzy expansion operation with the similarity score and the <b>numresults</b> specified.	<p>Set score to 70, number results to 6.</p> <p>select user_id, last_name from sc_user where contains(last_name, <b>@fuzzy</b>(:F1,70, 6)) &gt; 0</p>

## Column Parameters

Data explorer zones are used to select data to display using one or more SQL statements. For each SQL statement, the zone may configure up to 20 Columns that contain the formatting definition for displaying the output data.

These parameters are applicable to the zone types

- Info Data Explorer - Single SQL (**F1-DE-SINGLE**). The parameters follow the description pattern of **Column x**.
- Info Data Explorer - Multiple SQLs (**F1-DE**). The parameters follow the description pattern of **Column x for SQL y**.

- Query Data Explorer - Multiple SQLs (**F1-DE-QUERY**). The parameters follow the description pattern of **Column x for SQL y**.

The following sections describe the various types of mnemonics.

## Contents

- [Source Mnemonics](#)
- [Formatting Mnemonics](#)
- [Click Mnemonics](#)

## Source Mnemonics

This table describe the mnemonics that control how the data in a column is derived.

Mnemonic	Description	Valid Values	Comments
<b>source=</b>	Defines how the column's value is derived.	<b>SQLCOL</b>	Indicates that the source of the column's value comes from a column in the SQL statement. This type of column must also reference the <b>sqlcol=</b> mnemonic.
<b>BO</b>			Indicates that the source of the column's value comes from a <a href="#">business object</a> . This type of column must also reference the <b>bo=</b> , <b>input=</b> and <b>output=</b> mnemonics to define how to interact with the business object.
<b>BS</b>			Indicates that the source of the column's value comes from a <a href="#">business service</a> . This type of column must also reference the <b>bs=</b> , <b>input=</b> and <b>output=</b> mnemonics to define how to interact with the business service.
<b>SS</b>			Indicates that the source of the column's value comes from a <a href="#">service script</a> . This type of column must also reference the <b>ss=</b> , <b>input=</b> and <b>output=</b> mnemonics to define how to interact with the service script.
<b>FORMULA</b>			Indicates that the source of this column's value is calculated using a formula. This type of column must also reference the <b>formula=</b> mnemonic.
<b>SETFUNC</b>			Indicates that the source of this column's value is calculated using a superset of values from the rows in the SQL statement. This type of column must also reference the <b>setfunc=</b> mnemonic.
<b>ICON</b>			Indicates that the source of this column's value is a <a href="#">display icon</a> reference (meaning that an icon will be displayed in the column). This type of column must also reference the

Mnemonic	Description	Valid Values	Comments
			<p><b>icon=</b> mnemonic to define the icon reference.</p> <p><b>NOTE:</b> When using this source mnemonic, the <a href="#">formatting</a> <a href="#">mnemonic</a> is not applicable.</p>
		<b>FKREF</b>	<p>Indicates that the source of this column's value is an <a href="#">FK reference</a> (meaning that the FK reference's context menu and information string will be displayed in the column). This type of column must also reference the <b>fkref=</b> and <b>input=</b> mnemonics to define how the FK reference is called.</p> <p><b>NOTE:</b> When using this source mnemonic, the <a href="#">formatting</a> <a href="#">mnemonic</a> is not applicable.</p>
		<b>SPECIFIED</b>	<p>Indicates that the source of this column's value is specified by concatenating literals and other column values. This type of column must also reference the <b>spec=</b> mnemonic.</p>
		<b>MSG</b>	<p>Indicates that the source of this column is a message from the <a href="#">message</a> table (along with any substitution variables). This type of column must also reference the <b>msg=</b> mnemonic.</p>
<b>sqlcol=</b>	Defines the column in the SQL statement when <b>source=SQLCOL</b> .	COLUMN_NAME	Enter the name of a column that is retrieved in the SELECT statement. Note that if the select statement uses an alias for a column, then the alias should be referenced here.
		x	Where x is an integer value that references a column by its relative position in the SELECT statement. For example, <b>sqlcol=3</b> would display the 3rd column in the SELECT statement).
<b>bo=</b>	<p>Defines the business object to invoke when <b>source=BO</b>.</p> <p>This mnemonic must be used in conjunction with the <b>input=</b> and <b>output=</b> mnemonics to define how information is sent to / received from the business object.</p>	'Business Object Code'	
<b>bs=</b>	Defines the business service to invoke when <b>source=BS</b> .	'Business Service Code'	

Mnemonic	Description	Valid Values	Comments
	This mnemonic must be used in conjunction with the <b>input=</b> and <b>output=</b> mnemonics to define how information is sent to/received from the business service.		
<b>ss=</b>	Defines the service script to invoke when <b>source=SS</b> .  This mnemonic must be used in conjunction with the <b>input=</b> and <b>output=</b> mnemonics to define how information is sent to / received from the service script.	'Service Script Code'	
<b>fkref=</b>	Defines the FK reference used to retrieve the column's information when <b>source=FKREF</b> .  This mnemonic must be used in conjunction with the <b>input=</b> mnemonic to define how information is sent to the FK reference to build the information.	Cx  COLUMN_NAME  'FK Reference Code'	This means FK reference code is defined in an earlier column. For example, define <b>C1</b> if column 1 defines the FK reference value.  This means the FK reference was retrieved by the SELECT statement. The value should match the name defined in the SELECT clause.  This means the FK Reference is defined directly. For example 'F1-ROLE'.
<b>formula=</b>	Defines the formula to use when <b>source=FORMULA</b> .  Examples:  <ul style="list-style-type: none"> <li><b>formula=C1*.90/C2</b></li> <li><b>formula=(C1/C2)*100</b></li> </ul>	The formula can contain numeric constants, operators and column references.	For column references, use the format Cx where x represents the column number.  Refer to <a href="#">Expression Parser</a> for information about the functions supported.
<b>setfunc=</b>	Defines the function to apply to the rows of a given column when <b>source=SETFUNC</b> .	function(Cx)	Where Cx represents a column whose rows should have the function applied and the function is one of the following: <ul style="list-style-type: none"> <li><b>MAX</b>. This derives the maximum value of all rows in the column.</li> <li><b>MIN</b>. This derives the minimum value of all rows in the column.</li> <li><b>TOT</b>. This derives the sum (total value) of all rows in the column.</li> <li><b>ACC</b>. This derives the cumulative total of all rows up to an including the current row.</li> </ul>
<b>input=</b>	This is used to define one or more input fields and values passed to business objects, business services, service scripts, and FK references.	Cx  COLUMN_NAME	Where Cx represents the value of a previous column. If the value to pass is in the first column, reference C1.  This means the value to pass in was retrieved by the SELECT statement.

Mnemonic	Description	Valid Values	Comments
	<p>The syntax is as follows: [ELEMENT_NAME=ELEMENT_REF ELEMENT_NAME=ELEMENT_REF ...]</p> <p>In other words, the list of input values is surrounded by square brackets separated by a space. Each passed value first defines the ELEMENT_NAME, which is the name of the element / field in the target. ELEMENT_REF is the value passed in. The next column indicates the possible values for ELEMENT_REF.</p>	<p>'literal value'</p> <p><b>userTimeZone</b></p> <p><b>installationTimeZone</b></p> <p>Examples:</p> <ul style="list-style-type: none"> <li>• <b>input=[USER_ID=C1]</b></li> <li>• <b>input=[USER_ID=USER_ID]</b></li> <li>• <b>input=[input/targetTimeZone=userTimeZone]</b></li> </ul>	<p>The value should match the name defined in the SELECT clause.</p> <p>This means a literal value within the single quotes should be passed in.</p> <p>This means the current user's time zone should be passed in. This is typically used with the business service <b>F1-ShiftDateTime</b> to convert data in the storage time zone to the user's time zone for display.</p> <p>This means the installation time zone should be passed in. This is typically used with the business service <b>F1-ShiftDateTime</b> to convert data in the storage time zone to the installation time zone for display.</p>
<b>output=</b>	This is used to define the name of the element retrieved from the business object, business service or service script used to populate this column.	elementName	Example: <b>output=personInfo</b>
<b>pagingkey=</b>	<p>This mnemonic is only applicable when the <b>Enable Paging</b> parameter has been configured. It indicates that this column is one of the keys used by the SQL statement to orchestrate paging through results. This mnemonic can only be specified when the <b>source=SQLCOL</b>.</p> <p><b>FASTPATH:</b> Refer to <a href="#">Pagination Configuration</a> for more information.</p>	<p><b>Y</b></p> <p><b>N</b></p>	<p>This is the default, meaning that you don't need to indicate <b>pagingkey=N</b> at all to indicate that the column is not one of the paging keys.</p>

**NOTE:** If multiple columns are configured with the same source BO, BS or SS and the same input data, the system caches the output from the first call and reuses the results for subsequent columns.

## Formatting Mnemonics

This table describe the mnemonics that control how a column is formatted.

Mnemonic	Description	Valid Values	Comments
<b>type=</b>	Defines how the column's value is formatted.	<b>STRING</b>	Columns of this type capture a string. This is the default value.

Mnemonic	Description	Valid Values	Comments
	<p><b>NOTE: Icon and Foreign Key columns.</b> The <b>source=source mnemonic</b> may be used to indicate a column should be derived from an icon reference or a foreign key (FK) reference. If you use either of these sources, the <b>type=</b> mnemonic is not relevant as either an icon or a context menu / info string will appear in the column.</p>	<b>DATE</b>	Columns of this type capture a date and will be displayed using the user's <a href="#">display profile</a> .
		<b>TIME</b>	Columns of this type capture a time (in database format) and will be displayed using the user's <a href="#">display profile</a> .
		<b>DATE/TIME</b>	Columns of this type capture a date and time (in database format) and will be displayed using the user's <a href="#">display profile</a> .
		<b>MONEY</b>	Columns of this type capture a monetary field. This type of column may also reference the <b>cur=</b> mnemonic. If the cur mnemonic is not specified, the currency code on the installation record is used.
		<b>NUMBER</b>	Columns of this type capture a numeric field. This type of column may also reference the <b>dec=</b> mnemonic.
<b>label=</b>	<p>Defines the column's override label. The label appears in the column's heading and in the zone's drag and drop area.</p> <p>If this mnemonic is not defined, the system uses the column's default label. The source of a column's default label differs depending on the column's <a href="#">source</a>. Note that some sources don't have a default value and omitting this mnemonic will result in a blank label.</p>	FIELD_NAME	Enter a valid <a href="#">field</a> name whose label should be used for the column label. This should always be the option used if multiple languages are needed.
		'text'	Defines the text directly.
<b>cur=</b>	<p>Defines the <a href="#">currency code</a> applied when <b>type=MONEY</b> if the installation record's currency should not be used.</p>	Cx	This means currency code value is defined in an earlier column. For example, define <b>C1</b> if column 1 defines the currency code.
		COLUMN_NAME	This means the currency code was retrieved by the SELECT statement. The value should match the name defined in the SELECT clause.
		'Currency Code'	This means the currency code is defined directly. For example 'USD'.
<b>dec=</b>	<p>Defines the number of decimal places when <b>type=NUMBER</b>.</p> <p>It is optional. If provided it should be an integer. If not provided, the number of decimals will default to the number of decimal places defined on</p>	nR	Where n is the number of decimal places to show. Suffixing the number of decimal places with R means that the system should round up / down. Simply specifying n (without an R) means that decimal places should be truncated. For example, entering



Mnemonic	Description	Valid Values	Comments
	the currency code specified on the installation record.		<p><b>dec=4</b> will display 4 decimal places and truncate the remainder.</p> <p><b>NOTE: Formatting only.</b> This mnemonic is only used for formatting, it does not impact the precision used for subsequent calculations. For example, if a column retrieved from the database contains 6 significant digits and <b>dec=0</b>, the column will be shown with no decimal places (truncated), however any references to the column in subsequent calculations will use 6 decimal places. For example, if the column is referenced in a formula or set function, all 6 decimal places will be used.</p>
<b>char=</b>	This mnemonic applies special character(s) to the column's value.	'x[]x'	<p>Where x references the literal value to display and [ ] defines the relative position of the characters (before or after the value).</p> <p>You need only include the [ ] if you want to position characters in front of the value. For example, <b>char=%'</b> will place a percent sign after the value. If you want to position the word 'minutes' before a value, enter <b>char='minutes [ ]'</b>. If you want to output a value like <b>BUDGET \$123.12 (YTD)</b>, enter <b>char='BUDGET [ ] (YTD)'</b>.</p>
<b>suppress=</b>	<p>This is used to indicate a column should not be displayed.</p> <p>A column would be suppressed if it's only defined for use by subsequent columns, for example, if there is a formula that derives a column using two other columns. In this scenario, the columns referenced in the formula can be suppressed.</p>	<p><b>true</b></p> <hr/> <p><b>false</b></p>	<p>This is the default, meaning that you don't need to indicate <b>suppress=false</b> at all to indicate that the field should be shown.</p>
<b>suppressSearch=</b>	This is used to indicate a column should not be displayed when the zone is invoked in search mode only.	<p><b>true</b></p> <hr/> <p><b>false</b></p>	<p>This is the default, meaning that you don't need to indicate <b>suppressSearch=false</b> at all to indicate that the field should be shown.</p>
<b>suppressExport=</b>	This is used to indicate a column should not be downloaded to Excel.	<p><b>true</b></p> <hr/> <p><b>false</b></p>	<p>This is the default, meaning that you don't need to indicate <b>suppressExport=false</b> at all to</p>

Mnemonic	Description	Valid Values	Comments
			indicate that the field should be included in a download.
<b>width=</b>	This is used to override the width of a column (number of pixels). The default value is the maximum width of any cell in the column.	n	Where n is a number between 0 and 999.  <b>NOTE:</b> If there is no available breaking point in the data, the column will be longer than the specified number of pixels.  The length of the column's label (which appears in the column's heading) may also make the width wider than specified.
<b>color=</b>	This is used to override the column's text color.	A valid HTML "named" color  A valid RGB color model combination	For example <b>color=red</b> or <b>color=yellow</b> .  For example <b>color=#FF0000</b> or <b>color=#CCCCCC</b> . Note that the # is required.
<b>bgcolor=</b>	This is used to override the column's background color.	A valid HTML "named" color  A valid RGB color model combination	Similar to the <b>color=</b> mnemonic.  Similar to the <b>color=</b> mnemonic.
<b>order=</b>	Defines the column's default sort order.	<b>ASC</b>  <b>DESC</b>	Indicates that the order is ascending. This is the default meaning that it is not necessary to indicate <b>order=ASC</b> .  Indicates that the order is descending.

## Click Mnemonics

This table describe the mnemonics that define whether a column value may be clicked and if so, what should happen.

Mnemonic	Description	Valid Values	Comments
<b>navopt=</b>	Defines the navigation option that references the target transaction or script when the user clicks a column.  Note, this mnemonic should be used in conjunction with the <b>context=</b> mnemonic to define what information is sent to the navigation option's target transaction.  This mnemonic is ignored if <b>source=FKREF</b> because the FK reference code defines the hyperlink's destination.	Cx  COLUMN_NAME  'Navigation Option Code'	This means navigation option code is defined in an earlier column. For example, define <b>C1</b> if column 1 defines the navigation option.  This means the navigation option was retrieved by the SELECT statement. The value should match the name defined in the SELECT clause.  Example: <b>navopt=MAIN_PORTAL</b>  This means the navigation option code is defined directly. For example <b>navopt='userMaint'</b> .
<b>context=</b>	This is used to define one or more context fields and values passed to	Cx	Where Cx represents the value of a previous column. For example, if the

Mnemonic	Description	Valid Values	Comments
	<p>the target navigation option to go along with the <b>navopt=</b> mnemonic.</p> <p>The syntax is as follows: [FIELD_NAME=FIELD_REF FIELD_NAME=FIELD_REF ...]</p> <p>In other words, the list of input values is surrounded by square brackets separated by a space. Each passed value first defines the FIELD_NAME, which is the name of the context field in the navigation option. FIELD_REF is the value passed in. The next column indicates the possible values for FIELD_REF.</p>	<p>COLUMN_NAME</p> <p>'literal value'</p>	<p>value to pass is in the first column, reference <b>C1</b>.</p> <p>This means the value to pass in was retrieved by the SELECT statement. The value should match the name defined in the SELECT clause.</p> <p>This means a literal value within the single quotes should be passed in.</p>
<b>bpa=</b>	<p>Indicates that a BPA script should be executed with the user clicks the column and indicates the BPA to execute.</p> <p>Note, this mnemonic should be used in conjunction with the <b>tempstorage=</b> mnemonic to define the temporary storage values that will be initiated when the script is executed.</p> <p>This mnemonic is ignored if <b>source=FKREF</b> because the FK reference code defines the hyperlink's destination.</p>	<p>Cx</p> <p>COLUMN_NAME</p> <p>'BPA Script Code'</p>	<p>Indicates that the BPA script is defined in a previous column.</p> <p>This means the BPA script to execute was retrieved by the SELECT statement. The value should match the name defined in the SELECT clause.</p> <p>This means that the BPA script to execute is defined directly.</p>
<b>tempstorage=</b>	<p>This is used to define how temporary storage variables are initiated when the <b>bpa=</b> mnemonic is used.</p> <p>The syntax is as follows: [FIELD_NAME=FIELD_REF FIELD_NAME=FIELD_REF ...]</p> <p>In other words, the list of input values is surrounded by square brackets separated by a space. Each passed value first defines the FIELD_NAME, which is the name of the field in temporary storage. FIELD_REF is the value passed in. The next column indicates the possible values for FIELD_REF.</p>	<p>Cx</p> <p>COLUMN_NAME</p> <p>'literal value'</p>	<p>Where Cx represents the value of a previous column. For example, if the value to pass is in the first column, reference <b>C1</b>.</p> <p>This means the value to pass in was retrieved by the SELECT statement. The value should match the name defined in the SELECT clause.</p> <p>This means a literal value within the single quotes should be passed in.</p>
<b>list=</b>	<p>This is used to enable <a href="#">work list</a> capability for this column.</p> <p>You may optionally populate the <b>listdesc=</b> mnemonic to override the text that will be placed in the worklist zone.</p>	<b>true</b>	<p>Setting <b>list=true</b> will cause the work list icon to appear in the column's header. If a user clicks the column, it will populate all the rows in the output into the <a href="#">work list zone</a>.</p> <p><b>NOTE:</b> In the case of the zone type Info Data Explorer - Multiple</p>

Mnemonic	Description	Valid Values	Comments
			SQLs ( <b>F1–DE</b> ), the output may be showing a union of the results of multiple SQL statements. In this case, if some of the SQL statements configure a given column with <b>list=true</b> , but not all, only the data in the cells for the statements that configure this mnemonic are put into the work list when the user clicks the icon.
<b>listdesc=</b>	This is an optional mnemonic when using the <b>list=</b> mnemonic. It can be used to override the text that is placed in the work list zone.	Cx	Where Cx represents the value of a previous column. For example, if the text to use is in the first column, reference <b>C1</b> .
<b>listbroadcast=</b>	Indicates that the broadcast information for the column is also to be made available in the work list zone. This means that the work list can be used to broadcast information to a portal in the same manner as a data explorer.	<b>true</b>	Use this setting to turn on the feature.

## Zone Action

Most zone types provided by the product allow for one or more Zone Actions to be defined to appear in the zone header. An action can appear as a hyperlink, icon or button. The action can also be provided as an HTML string.

**NOTE:** Zone types also include parameters for actions defined at the zone type level using **IMPLEMENTOR\_ACTION\_n** (Action n) parameters. These are rarely used by the product zone types. The actions defined here override any actions defined on the zone type (if present). The details below apply to the zone type level actions as well.

A zone action is defined using the following mnemonics:

Mnemonic	Description	Valid Values	Comments
<b>type=</b>	This mnemonic defines the appearance of the action in the zone header.	<b>LINK</b>	Indicates that the action is shown as a textual hyperlink.
		<b>ICON</b>	Indicates that the action is shown as a graphical icon.
		<b>BUTTON</b>	Indicates that the action is shown as an HTML button.
		<b>ASIS</b>	Indicates that the parameter will provide the HTML to be used for the action.
<b>action=</b>	This mnemonic defines the action to take when the link/icon/button is clicked. This is ignored when the type=ASIS.	<b>NAVIGATION</b>	Indicates that the action is navigation to a page.
		<b>SCRIPT</b>	Indicates that the action is to run a BPA script.
<b>navopt=</b>	Defines the navigation option to use when the <b>action=NAVIGATION</b> .	'NAV_OPT_CD'	Enter a reference to a valid navigation option in single quotes.

Mnemonic	Description	Valid Values	Comments
<b>bpa=</b>	Defines the script to run when the <b>action=SCRIPT</b> .	'SCRIPT_CD'	Enter a reference to a valid BPA script in single quotes.
<b>icon=</b>	Indicates the icon to use when <b>type=ICON</b> .	DISP_ICON_CD	Enter a reference to a valid display icon.
		'path'	Enter an explicit path to the icon, for example 'images/gotoZone.gif'.
<b>asis=</b>	This is required when the <b>type=ASIS</b> . This provides the ability to precisely define the HTML you wish to have included in the header. All valid HTML is permitted including the use of "ora" css classes and JavaScript functions.	['HTML']	
<b>label=</b>	By default, the label or tooltip will come from the navigation option or BPA script description. Use this mnemonic to override that label.	FIELD_NAME	Enter a valid field name whose label should be used. This should always be the option used if multiple languages are needed.
		'text'	Enter the text directly in single quotes.
<b>context=[target1=source1 target2=source2]</b>	<p>This is used to pass context data when navigating to a page or executing a BPA script. The mnemonic supports passing multiple values.</p> <p>In each case the target context field or BPA script variable is defined first followed by an equal sign, followed by source data defined using one of the valid values defined in the next column.</p> <p>One or more values may be defined. Each context value is defined separated by spaces. The whole set of context values should be surrounded by square brackets.</p>	FIELD_NAME	Indicates that the value should be taken from the field with this name from portal context, global context or the page data model. The mnemonic sourceLoc is used for defining the source.
		xpath	Indicates that the value should be taken from a schema field, represented by the Xpath, displayed in this zone. This is valid when the zone is displaying a UI Map.
		'constant'	Indicates that the value defined in single quotes should be passed.
<b>sourceLoc=</b>	<p>This mnemonic defines the source of the FIELD_NAME's value in the context mnemonic.</p> <p>If this mnemonic is left blank, the default behavior is as follows:</p> <ul style="list-style-type: none"> <li>- The portal context is checked.</li> <li>- If no portal context value is found, the global context is checked.</li> <li>- If neither value is available, the field is ignored.</li> </ul>	<b>G</b>	Indicates that the field's value is retrieved from the global context.
		<b>P</b>	Indicates that the field's value is retrieved from the portal context.
		<b>D</b>	Indicates that the field's value is retrieved from the page data model.
<b>class=</b>	Use this mnemonic to override the look and feel of the link / icon / button using a different CSS style.	'className1' 'className2'	Enter one or more classes in single quotes. Multiple class names may be provided.
<b>style=</b>	Use this mnemonic to override the look and feel of the action	Standard style= format.	All allowed css style definitions may be used.

Mnemonic	Description	Valid Values	Comments
----------	-------------	--------------	----------

element using the indicated css style.

Examples:

- `type=BUTTON action=SCRIPT bpa='F1-SET-USER' context=[USER_ID=USER_ID] label=UPDATE_LBL`
- `type=LINK action=NAVIGATION navopt='gotoUser' context=[USER_ID=path(schema/userId)]`
- `type=ASIS asis=['<A class="oraLink" href="www.google.com">Search</a>']`

**NOTE:** If the zone type has actions defined and there is a desire to simply remove the zone type actions, the Zone Action can be set with the following configuration: `type=ASIS asis=[]`

## User Filters

Data explorer zones include the ability to define User filters to allow a user to enter data to restrict the zone's rows and / or columns. The filters may be defined individually using User Filter parameters 1–25. Alternatively, a UI map may be defined for capturing filters. In this case, the map's input fields must be associated with the zone's filters by specifying the `xpath=` mnemonic on the respective User Filter parameters.

These parameters are applicable to the zone types

- Info Data Explorer - Multiple SQLs (**F1-DE**)
- Query Data Explorer - Multiple SQLs (**F1-DE-QUERY**)
- Info Data Explorer - Single SQL (**F1-DE-SINGLE**)

A user filter is defined using the following mnemonics:

Mnemonic	Description	Valid Values	Comments
<code>name=</code>	This mnemonic is used if the zone's filter should be pre-populated with a value from global context, portal context or broadcast from another zone.	MD Field Name	
<code>datasource=</code>	This mnemonic defines the source of the filter's pre-populated value defined in the name mnemonic. If this mnemonic is left blank, the default behavior is as follows: - If the field has been broadcast from another zone, the broadcast value is used. - If no value is broadcast, the portal context is checked to determine if this field exists (if so, its value is taken). - If still no value, the global context is checked. - If still no value, no default value is shown.	<b>G</b> <b>P</b> <b>D</b>	Indicates that the zone should look for the filter value in global context. Indicates that the zone should look for the filter value in portal context. Indicates that the zone should look for the filter value in the page data model.
<code>type=</code>	Defines the visual metaphor used to capture the filter values.	<b>DATE</b> <b>DATE/TIME</b> <b>STRING</b> <b>MONEY</b> <b>NUMBER</b>	Filters of this type capture a date. Filters of this type capture a date and time. Filters of this type capture a string Filters of this type capture a monetary field. This type of filter must also reference the cur mnemonic. Filters of this type capture a numeric field. This type of filter may also reference the decimals mnemonic.

Mnemonic	Description	Valid Values	Comments
		<b>LOOKUP</b>	Filters of this type capture a lookup value. This type of filter must also reference the lookup mnemonic.
		<b>TABLE</b>	Filters of this type capture an administrative table's value (code and description). This type of filter must also reference the table mnemonic.
		<b>CHARTYPE</b>	Filters of this type capture predefined characteristic values for a characteristic type (code and description). This type of filter must also reference the chartype mnemonic.
		<b>ASIS</b>	Filters of this type capture a list of values to be referenced within an 'IN' clause within the SQL statement.
<b>label=</b>	Defines the filter's label that appears in the zone's description bar and in the input area.	MD Field Name	Enter a valid field name whose label should be used for the filter label. This should always be the option used if multiple languages are needed.
		'text'	Defines the text directly.
<b>cur=</b>	Defines the currency code applied when <b>type=MONEY</b> .	Currency Code	Enter a reference to a valid currency code.
<b>dec=</b>	Defines the number of decimal places when <b>type=NUMBER</b> .	Valid number	It is optional. If provided it should be an integer. If not provided, the number of decimals will default to the number of decimal places defined on the currency code specified on the installation record.
<b>lookup=</b>	Defines the lookup flag whose values appear when <b>type=LOOKUP</b> .	Lookup Field Name	Enter a reference to a valid lookup field name.
<b>table=</b>	Defines the admin table whose values appear when <b>type=TABLE</b> .	Table Name	Enter a reference to a valid control table name.
<b>chartype=</b>	Defines the characteristic type code whose values appear when <b>type=CHARTYPE</b> .	Char Type code	Enter a reference to a valid characteristic type code.
<b>xpath=</b>	This mnemonic is used in conjunction with a Filter Area UI Map. For each filter, you must specify the XPath to the corresponding UI map schema element.	XPath	The <b>type=</b> mnemonic must also be appropriate for the map's input field, otherwise the query's SQL could fail.
<b>likeable=</b>	This mnemonic defines if a likeable search is performed on the entered value when <b>type=STRING</b> .	<b>S</b>	The query will add % to the suffix of the filter value.
		<b>P</b>	The query will add % to the prefix of the filter value.
		<b>PS</b>	The query will add % to the prefix and suffix of the filter value.
<b>divide=</b>	The mnemonic controls if a divider line appears above and/or below the filter.  Note, you can specify this parameter twice if you want divider lines placed above and below a filter, e.g., <b>divide=above divide=below</b> .	<b>above</b>	This results in a divider line placed above the filter.
		<b>below</b>	This results in a divider line placed below the filter.
<b>searchField=</b>	This mnemonic controls the initial population of the filter when the zone is launched as a search from a UI map.	MD Field Name	Enter the field name that exactly matches the searchField name specified in the oraSearchField HTML element in the UI map.
<b>encrypt=</b>	This mnemonic defines if the user filter is <b>encrypted</b> and needs to be searched by hashed value.	[TBL_NAME,FLD_NAME,WHERE_FLD,WHERE_VALUE]  <b>NOTE:</b> The field name referenced here should be the source value of	A valid table name and field name are required.  The WHERE_FLD and WHERE_VALUE are optional, but if entered,

Mnemonic	Description	Valid Values	Comments
		the field. However, the SQL should use the hashed value in its filter.	both are required. Use this to only encrypt the field if another field has a certain value. The following is an example.  <b>encrypt=[CI_PERSON,PER_ID_NBR,ID_TYPE_NBR,SSN]</b> . The WHERE_VALUE may also reference another filter. The following is an example.  <b>encrypt=[CI_PERSON,PER_ID_NBR,ID_TYPE_NBR,F1]</b> .

Examples:

- **label=F1\_NBR\_DAYS type=NUMBER**
- **label=F1\_SHOW\_ALL\_REQ\_FLG type=LOOKUP lookup=F1\_SHOW\_ALL\_REQ\_FLG**
- Filter value where a Filter UI Map is defined and Description is one of the filters. **type=STRING xpath=description likeable=S**
  - **type=STRING label=DESCR likeable=S divide=below**
  - **label=REQ\_TYPE\_CD type=TABLE table=F1\_REQ\_TYPE**

## Hidden Filters

Data explorer zones include the ability to define Hidden filters to restrict the rows and / or columns that appear in the zone. The following are the potential sources of a hidden filter's value:

- The global area contains the fields whose values are maintained in [global context](#).
- The portal area contains the fields describing the object currently displayed in a portal.
- Other zones on a portal can broadcast information to the portal area, which can then in turn be used by the zone as a hidden filter.

These parameters are applicable to the zone types

- Info Data Explorer - Multiple SQLs (**F1-DE**)
- Query Data Explorer - Multiple SQLs (**F1-DE-QUERY**)
- Info Data Explorer - Single SQL (**F1-DE-SINGLE**)

A hidden filter is defined using the following mnemonics:

Mnemonic	Description	Valid Values	Comments
<b>name=</b>	This mnemonic defines the name of the field that needs to be broadcast from other zones or populated in the portal context	FIELD_NAME	
<b>datasource=</b>	This mnemonic defines the source of the hidden filter's value.  If this mnemonic is left blank, the default behavior is as follows:  - If the field has been broadcast from another zone, the broadcast value is used.  - If no value is broadcast, the portal context is checked to determine if this field exists (if so, its value is taken).  - If still no value, the global context is checked.	<b>G</b>  <b>P</b>  <b>D</b>	Indicates that the zone should look for the filter value in global context.  Indicates that the zone should look for the filter value in portal context.  Indicates that the zone should look for the filter value in the page data model.



Mnemonic	Description	Valid Values	Comments
	- If still no value, the zone appears as per the poprule mnemonic.		
<b>poprule=</b>	This mnemonic controls what happens if the hidden filter is not present.	<b>R</b>	Indicates that a value for the filter is required. The zone will be set to the "empty state" and the "please broadcast" message will appear in the zone. This is the default value.
		<b>O</b>	Indicates that the value is optional. If no value is required, the zone is still built without that value.
<b>type=</b>	Defines the visual metaphor used to capture the filter values.	<b>DATE</b>	Filters of this type capture a date.
		<b>DATE/TIME</b>	Filters of this type capture a date and time.
		<b>STRING</b>	Filters of this type capture a string
		<b>MONEY</b>	Filters of this type capture a monetary field. This type of filter must also reference the cur mnemonic.
		<b>NUMBER</b>	Filters of this type capture a numeric field. This type of filter may also reference the decimals mnemonic.
		<b>LOOKUP</b>	Filters of this type capture a lookup value. This type of filter must also reference the lookup mnemonic.
		<b>TABLE</b>	Filters of this type capture an administrative table's value (code and description). This type of filter must also reference the table mnemonic.
		<b>CHARTYPE</b>	Filters of this type capture predefined characteristic values for a characteristic type (code and description). This type of filter must also reference the chartype mnemonic.
<b>label=</b>	Defines the filter's label that appears in the zone's description bar.	<b>FIELD_NAME</b>	Enter a valid field name whose label should be used. This should always be the option used if multiple languages are needed.
		'text'	Defines the text directly.
<b>cur=</b>	Defines the currency code applied when <b>type=MONEY</b> .	<b>CURRENCY_CD</b>	Enter a reference to a valid currency code.
<b>dec=</b>	Defines the number of decimal places when <b>type=NUMBER</b> .	<b>N</b>	It is optional. If provided it should be an integer. If not provided, the number of decimals will default to the number of decimal places defined on the currency code specified on the installation record.
<b>lookup=</b>	Defines the lookup flag whose values appear when <b>type=LOOKUP</b> .	<b>LOOKUP_FIELD_NAME</b>	Enter a reference to a valid lookup field name.
<b>table=</b>	Defines the admin table whose values appear when <b>type=TABLE</b> .	<b>TABLE_NAME</b>	Enter a reference to a valid admin table name.
<b>chartype=</b>	Defines the characteristic type code whose values appear when <b>type=CHARTYPE</b> .	<b>CHAR_TYPE_CD</b>	Enter a reference to a valid characteristic type code.

Mnemonic	Description	Valid Values	Comments
<b>searchField=</b>	This mnemonic controls the initial population of the filter when the zone is launched as a search from a UI map.	FIELD_NAME	Enter the field name that exactly matches the searchField name specified in the oraSearchField html element in the UI map.

## Multi-Select Action

This parameter defines an action to be included in the action area for multi-selection processing. Note that a multi-selection action can only be used if the Multi Select parameter has been set to YES, which causes a checkbox to appear on each row displayed. The action defined here will trigger against all rows selected by the user via the checkbox.

These parameters are applicable to the zone types

- Info Data Explorer - Multiple SQLs (**F1-DE**)
- Query Data Explorer - Multiple SQLs (**F1-DE-QUERY**)
- Info Data Explorer - Single SQL (**F1-DE-SINGLE**)

A multi select action has the following mnemonics:

Mnemonic	Description	Valid Values	Comments
<b>script=</b>	This mnemonic defines the script to be invoked when the action is clicked. This is required.	SCR_CD	Enter a reference to a valid BPA script or Service Script.
<b>type=</b>	This mnemonic defines how the action should be rendered.	<b>BUTTON</b>	The action is rendered as a button. This is the default.
		<b>LINK</b>	The action is rendered as hypertext.
		<b>ICON</b>	The action is rendered as a graphic icon. For this option, the icon mnemonic is required.
<b>icon=</b>	This mnemonic defines the icon to display when <b>type=ICON</b> .	DISPLAY_ICON_CD	Enter a reference to a valid display icon code.
<b>refresh=</b>	This mnemonic indicates how and if a refresh should occur after the script completes.	<b>NO</b>	Indicates that no refresh is performed. This is the default.
		<b>ZONE</b>	Indicates that a refresh of the zone is performed.
		<b>PORTAL</b>	Indicates that a refresh of the entire portal is performed.
<b>label=</b>	By default, the button label, link text or icon tooltip will come from the script description. Use this mnemonic to override that label.	FIELD_NAME	Enter a valid field name whose label should be used. This should always be the option used if multiple languages are needed.
		'text'	Enter the text directly in single quotes.
<b>list=</b>	When executing the script, the framework builds an XML list containing information from each row selected. This list	listElementName	Enter a valid list element name from the script schema.

Mnemonic	Description	Valid Values	Comments
	must be defined in the script's schema and referenced in this mnemonic.		
<b>context</b> =[elementName1=rowData1 elementName2=rowData2]	<p>This mnemonic is used to populate the list with the appropriate information from each selected row. The mnemonic supports passing multiple values.</p> <p>In each case the element in the schema list is defined first followed by an equal sign, followed by information about the data used to populate the element defined using one of the valid values defined in the next column.</p> <p>One or more values may be defined. Each context value is defined separated by spaces. The whole set of context values should be surrounded by square brackets.</p> <p>Example of a schema:</p> <pre>&lt;schema&gt;   &lt;accountInfo type="list"&gt;     &lt;accountId/&gt;     &lt;name/&gt;     &lt;amount/&gt;     &lt;process/&gt;   &lt;/accountInfo&gt; &lt;/schema&gt;</pre> <p>Example of list and context mnemonics.</p> <p><b>list=accountInfo</b>  <b>context=[accountId=ACCT_  ID name=C2  amount=P3  process='O']</b></p>	<p>Cx</p> <hr/> <p>Px</p> <hr/> <p>COLUMN_NAME</p> <hr/> <p>'constant'</p>	<p>Indicates that the element should be populated with a value in the referenced column parameter.</p> <hr/> <p>Indicates that the element should be populated with a value in the referenced post processing parameter.</p> <hr/> <p>Indicates that the element should be populated with a value from a column in the SQL statement.</p> <hr/> <p>Indicates that the value defined in single quotes should be passed.</p>
<b>class=</b>	Use this mnemonic to override the look and feel of the action using a different CSS style.	'className1' 'className2'	Enter one or more classes in single quotes to be appended to the standard class(es). Multiple class names may be provided.
<b>style=</b>	Use this mnemonic to override the look and feel of the action element using the indicated css style.	Standard style= format.	All allowed css style definitions may be used.

## Pagination Configuration

The various data explorer zones in the product support the ability to configure pagination so that a user can 'page through' a large set of results using "previous" and "next" buttons or links.

There are several zone parameters that are impacted when attempting to configure this functionality. The following steps highlight the configuration.

- The **Enable Pagination** parameter must be configured to define the basic setup for pagination for the zone. This parameter defines whether the "previous" and "next" actions are defined as buttons, links or icons and indicates the location of the actions. It also allows an indication as to whether the additional rows are simply appended, rather than shown in a new "page". Refer to the parameter's embedded help for information about the specific syntax.
- It is recommended that the zone is configured with record count and page information by properly configuring the **Record Count Display** parameter. Refer to the parameter's embedded help for information about the specific syntax.
- Configure the **Number of Rows to Retrieve for SQL** parameter to define the number of records displayed per page. If this parameter is not specified the value in the **Number of Rows to Display** parameter is used.
- Configure the key that will be used for paging so that the system can keep track of the 'page break'. The data must be sorted by the paging key; as a result, the decision for identifying the paging key must take into account the design for the zone and the data being displayed. In addition, the paging key must be unique to ensure that the page breaks occur correctly. See below for configuration examples.
  - The **SQL Statement** must include additional clauses **PAGENEXT** and **PAGEPREV** based on the paging key. In addition, as mentioned above, the paging key must be used in the ORDER BY clause.
  - The **SQL Column** parameters must define the paging key mnemonic to be used in conjunction with the SQL statement paging clauses.
  - It is recommended to configure the **SQL Display Column** parameter to show the data in the same order as the ORDER BY clause.

The following zone types support this capability:

- Info Data Explorer - Single SQL (**F1-DE-SINGLE**).
- Info Data Explorer - Multiple SQLs (**F1-DE**). Note that zones of this type support a union of the results of all the SQL statements. As a result, pagination may only be enabled for zones of this type if a single SQL is used. The system is not able to keep track of the pagination across disparate SQL statements.
- Query Data Explorer - Multiple SQLs (**F1-DE-QUERY**).
- Multi Query Data Explorer (**F1-DE-MULQRY**). Zones of this type do not include configuration for SQL statements or column display. However, they do include configuration for the **Enable Pagination**. This parameter must be configured in order for pagination on the individual zones to work.

---

**NOTE: Zones used for a Business Service.** Note that pagination is ignored when invoking a data explorer zone via a business service. In this scenario, the zone will return the first "chunk" of rows as defined by the Number of Rows parameters.

---

## Examples

### Simple Paging Key

In this example, the Extendable Lookup Value is defined as Column 1 (C1) and is marked as the paging key. This field is unique for the table and works well as a simple paging key.

```
SELECT A.F1_EXT_LOOKUP_VALUE,A.BUS_OBJ_CD
FROM
  F1_EXT_LOOKUP_VAL A,
  F1_EXT_LOOKUP_VAL_L B
WHERE
A.BUS_OBJ_CD = :H1
AND A.BUS_OBJ_CD = B.BUS_OBJ_CD
AND A.F1_EXT_LOOKUP_VALUE = B.F1_EXT_LOOKUP_VALUE
AND B.LANGUAGE_CD = :LANGUAGE
[(F1) AND UPPER(A.F1_EXT_LOOKUP_VALUE) like UPPER(:F1)]
[(F2) AND ((UPPER(B.DESCR_OVRD) like UPPER(:F2))
OR (B.DESCR_OVRD = ' ' AND UPPER(B.DESCR) like UPPER(:F2)))]
[(PAGENEXT) AND A.F1_EXT_LOOKUP_VALUE > :C1]
```

```
[ (PAGEPREV) AND A.F1_EXT_LOOKUP_VALUE < :C1 ]
ORDER BY A.F1_EXT_LOOKUP_VALUE
```

## Complex Paging Key

Most queries however do not sort by a unique value. In this case, the paging key needs to be set based on the sorting of the query and should include a unique field, such as the primary key, as the last paging key. In this example, the query is showing results sorted by To Do Type, Role and User. All fields, including the To Do Entry ID (the primary key) are marked as paging keys.

```
SELECT TD_TYPE_CD, ROLE_ID, ASSIGNED_TO, ASSIGNED_DTTM, TD_PRIORITY_FLG, TD_ENTRY_ID
FROM CI_TD_ENTRY
WHERE
ENTRY_STATUS_FLG IN ('O', 'W')
[(F1) and TD_TYPE_CD = :F1]
[(F2) AND ASSIGNED_TO = :F2]
[(F3) AND ROLE_ID = :F3]
[(PAGENEXT) and ((TD_TYPE_CD>:C1) or (TD_TYPE_CD=:C1 and ROLE_ID>:C2) or (TD_TYPE_CD=:C1 and ROLE_ID=:C2
and ASSIGNED_TO>:C3) or (TD_TYPE_CD=:C1 and ROLE_ID=:C2 and ASSIGNED_TO=:C3 AND TD_ENTRY_ID>:C4))]
[(PAGEPREV) and ((TD_TYPE_CD<:C1) or (TD_TYPE_CD=:C1 and ROLE_ID<:C2) or (TD_TYPE_CD=:C1 and ROLE_ID=:C2
and ASSIGNED_TO<:C3) or (TD_TYPE_CD=:C1 and ROLE_ID=:C2 and ASSIGNED_TO=:C3 AND TD_ENTRY_ID<:C4))]
ORDER BY TD_TYPE_CD, ROLE_ID, ASSIGNED_TO, TD_ENTRY_ID
```

## Use Data Explorer for Derived Data

There are times when a design warrants displaying data in a data explorer zone that is not accessible via SQL. For example, perhaps the data is from another system and it requires a web service call. The [JMS Message Browser](#) is another example.

The product provides functionality in the data explorer that allows you to call a script after the user filters are populated but before the SQL is executed. The script can retrieve the data as appropriate, store the data in table format so that the SQL can retrieve the data from the table.

The following points provide more detail:

- Create a service script that retrieves the data as needed. This script should store the retrieved data in a temporary table.
  - The product provides a table that may be used. It is called F1\_GENERIC\_GTT (Generic Global Temporary Table). There is a business service — Create Global Temporary Table Records (**F1-InsertGTTRecords**) that the service script may call to insert the records.
  - Note that if the data is accessed via a web service call, it may be appropriate to execute the web service in a separate session using the business service F1-ExecuteScriptInNewSession to trap errors that may be issued by the web service call and provide a better error.
- In the data explorer zone use this service script in the zone's pre-processing script parameter. If any user or hidden filters should be passed into the script, the parameter supports mnemonics for this purpose. Refer to the parameter's embedded help for the supported syntax.
- The SQL for the data explorer should access the temporary table that was populated by the service script.

## Configuring Timeline Zones

This topic highlights information related to configuring a [timeline zone](#). The zone type is **F1-TIMELINE**. A timeline zone contains one or more "lines" where each line shows when significant events have occurred. The output of each line is driven by an algorithm configured on a timeline zone. Each algorithm is responsible for retrieving a single type of data. For example, one algorithm may retrieve bills for an account in a given time period whereas another algorithm may retrieve payments for that account for the same time period.

The algorithms to configure for a timeline zone use the **Zone — Timeline** plug-in spot. Please note the following details about the behavior for algorithms for this plug-in spot.

- The timeline algorithm receives all the global context values currently populated. In addition, it receives a start and end date from the zone, based on the time period chosen by the user, along with the maximum number of events that can be

reasonably display for the chosen time period. The algorithm should use this information to retrieve data for a given type of transaction related to one or more of the input context values for the provided time period.

- For each event found, the algorithm returns information about the event along with many options that assist the user in getting more detail about each event or acting on an event.
  - Event date
  - Primary key of the record (key / value pairs)
  - FK Reference. With this information, the timeline zone will display the appropriate info string to display in the zone's info area when clicking on the event. In addition, the FK reference identifies the appropriate navigation option to use when a user clicks the info string hypertext to view the record on its maintenance page.
  - Background Color and Text Color to use for the event. (Optional). The algorithm may be configured to provide one color for all events or it may be configured to return different colors for different events based on other factors such as status or priority.
  - Icon use for the event. (Optional). The algorithm may be configured to provide an icon to display adjacent to the event.
  - [BPA script](#) to launch when a user clicks on an event. (Optional). The algorithm may return one or more BPA scripts that a user may launch to act on an event. For example, for an event that has a status of **Error**, perhaps a BPA is provided to walk a user through resolving the error.

When a script is initiated from a timeline, the system puts the prime key of the event into a field in the page data model. The name of the field is the column name(s) of the event's prime key. For example, when a script associated with a payment event is kicked off, the system populates a field called PAY\_ID with the prime-key of the selected payment.

Note that your specific edge application may supply algorithm types for a timeline zone as part of the base product. Click [here](#) to see the algorithm types available for this plug-in spot. Although algorithm types may be provided, typically the product does not deliver algorithms because the parameters for the algorithms are driven by a particular implementation's business rules and preferences. As a result, the product will also not deliver pre-configured timeline zones. Please refer to your edge application's documentation for more information about what timeline algorithm types are delivered, if any and recommendations for configuration.

## Defining Context-Sensitive Zones

A context-sensitive zone allows you to associate a zone with a specific user-interface transaction. A context-sensitive zone appears at the top of the Dashboard when a user accesses a page for which the zone is specified as the context. For example, when viewing a business object, additional zones are visible that are specific to the business object page.

---

**CAUTION:** Make sure that the zone is appropriate for the transaction on which you are specifying it. For example, if your zone requires a business object ID as one of its keys, it should not be displayed on the To Do entry transaction.

---

Select **Admin > Context Sensitive Zone** to maintain context-sensitive zones.

### Description of Page

The **Navigation Key** is a unique identifier of a tab page within the system. **Owner** indicates if this navigation key is owned by the base product or by your implementation (**Customer Modification**).

---

**CAUTION:** Important! When introducing a new context sensitive zone, carefully consider its naming convention. Refer to [System Data Naming Convention](#) for more information.

---

The grid contains the list of context-sensitive zones and the sequence in which they appear in the dashboard for the selected navigation key. The grid contains the following fields:

- **Zone** is the name of the zone to display in the Dashboard.

- **Sequence** is the sequence in which the zone is displayed (if multiple context-sensitive zones are defined).
- **Owner** indicates if this context sensitive zone is owned by the base product or by your implementation (**Customer Modification**).

### Where Used

A context-sensitive zone displays at the top of the Dashboard whenever a user accesses the transaction for with the zone is specified.

## Defining Portals

This transaction is used to define / change portals. An implementation may define their own portals. In addition, an implementation may override some of the settings for base product provided portals.

### Portal - Main

Navigate to this page using **Admin > System > Portal**.

#### Description of Page

Enter a meaningful and unique **Portal** code and **Description**. Please be aware that for [stand-alone portals](#), the Description is the portal's title (i.e., the end-users will see this title whenever they open the portal).

---

**CAUTION:** Important! When introducing a new portal, carefully consider its naming convention. Refer to [System Data Naming Convention](#) for more information.

---

**Owner** indicates if this portal is owned by the base product or by your implementation (**Customer Modification**). The system sets the owner to **Customer Modification** when you add a portal. This information is display-only.

**Type** flag indicates whether the portal is a **Standalone Portal**, a **Tab Page Portal** or the **Dashboard**. Refer to [There Are Three Types of Portals](#) for more information.

The following fields are only enabled for **Standalone Portals**:

- **Navigation Option** defines the navigation option that is used to navigate to this portal from menus, scripts and your favorite links. The navigation option is automatically created when a **Standalone Portal** is added.
- You'll find an **Add To Menu** button adjacent. This field is only enabled if the navigation option is not referenced on a menu. When you click this button, a pop-up appears where you define a menu. If you subsequently press **OK**, a menu item is added to the selected menu. This menu item references the portal's navigation option. You can reposition the menu item on the menu by navigating to the [Menu page](#). Refer to [Putting Portals on Menus](#) for more information.
- **Application Services** defines the service used to secure this portal. The application service is automatically created when a **Standalone Portal** is added. Please note that only users with access to this application service will be able to view this portal and its zones. Refer to [Granting Access to A Portal](#) for more information.
- **Show on Portal Preferences** indicates if a user is allowed to have individual control of the zones on this portal. The portal will not appear in the accordion on the user's Portal Preferences page if this value is set to No. Note that an implementation may change this value for a product delivered portal.

The grid contains a list of zones that are available in the portal. Click + to add a new zone to the portal. Click - to remove a zone from the portal. The grid displays the following fields:

- **Zone** is the name of the zone as defined on the Zone page.
- **Description** is a description of the zone as defined on the Zone page.
- **Display** controls whether or not the zone is visible in the portal. For portals that are configured to Show on Portal Preferences, users may override this value for their view of the portal.

- **Initially Collapsed** controls whether or not the zone is initially collapsed in the portal. For portals that are configured to Show on Portal Preferences, users may override this value for their view of the portal.

---

**NOTE: Recommendation.** It is recommended that zones that have information that is always needed when users first display a portal be set up to be initially collapsed. That way the data in the zone is only built when the user expands the zone. This improves response times.

---

- **Default Sequence** is the default sequence number for the zone within the portal. It does not need to be unique within the portal. Note that a sequence of zero will appear last, not first, in the portal. For portals that are configured to Show on Portal Preferences, users may override this value for their view of the portal.
- **Override Sequence** can be used by an implementation team to override the Default Sequence value that is set in the base product.
- **Refresh Seconds** defines in seconds how often the zone is automatically refreshed. The minimum valid value is 15. The maximum valid value is 3600 (1 hour). A value of 0 indicates no automatic refresh. Implementers can change this value as needed.
- **Owner** indicates if this portal / zone relationship is owned by the base product or by your implementation (**Customer Modification**). This information is display-only.

---

**NOTE: Removing zones from a portal.** You cannot remove a base product zone from a base product portal. An implementation may override the Display setting to prevent a zone from displaying on the portal. In addition, you cannot remove a zone if a user has enabled it on their Portal Preferences. To remove a zone from the portal list, first make sure that no user has it enabled in their portal preferences.

---

## Where Used

Follow this link to open the data dictionary where you can view the tables that reference [CI\\_PORTAL](#).

## Portal - Options

Use this page to maintain a portal's options. Open this page using **Admin > System > Portal** and then navigate to the **Options** page.

### Description of Page

The options grid allows you to configure the options that provide additional information related to the portal.

Select the **Option Type** dropdown to define its **Value**. **Detailed Description** may display additional information on the option type.

Set the **Sequence** to a unique value within a given option type.

**Owner** indicates if this is owned by the base product or by your implementation (**Customer Modification**).

---

**NOTE: You can add new option types.** Your implementation may want to add additional portal option types. To do that, add your new values to the customizable lookup field **PORTAL\_OPT\_FLG**.

---

## Defining Display Icons

Icons are used to assist users in identifying different types of objects or instructions. A limited number of control tables allow administrative users to select an icon when they are configuring the system. Select **Admin > System > Display Icon Reference** to maintain the population of icons available for selection.

### Description of Page

Each icon requires the following information:



- **Display Icon** is a code that uniquely identifies the icon.
- **Icon Type** defines how big the icon is (in pixels). The permissible values are: **30 x 21**, **21 x 21**, and **20 x 14**. Note that only icons that are **20 x 14** can be used on base product instructions.
- **Description** contains a brief description of the icon.
- **URL** describes where the icon is located. Your icons can be located on the product's web server or on an external web server.
- To add a new icon to the product web server, place it under the **/cm/images** directory under the **DefaultWebApp**. Then, in the **URL** field, specify the relative address of the icon. For example, if the icon's file name is **myIcon.gif**, the **URL** would be **/cm/images/myIcon.gif**.
  - If the icon resides on an external web server, the **URL** must be fully qualified (for example, **http://myWebServer/images/myIcon.gif**).
  - **Owner** indicates if this icon is owned by the base product or by your implementation (**Customer Modification**). This information is display-only.

### Where Used

Follow this link to open the data dictionary where you can view the tables that reference [CL\\_DISP\\_ICON](#).

## Defining Navigation Keys

Each location to which a user can navigate (e.g., transactions, tab pages, tab menus, online help links, etc.) is identified by a navigation key. A navigation key is a logical identifier for a URL.

### Navigation Key Types

There are three types of navigation keys:

- **System navigation keys** define locations where the target for the navigation is a transaction or portal within the system. The navigation keys define the program component that identifies the page to navigate to.
- **External navigation keys** define a URL that identifies the target location. External URLs can be specified as relative to the product web server or fully qualified. External navigation keys always launch in a new instance of a browser window. Examples of external navigation keys include application viewer links and URLs to external systems.
- **Help navigation keys** define a online help topic that identifies the specific page within the online help to launch. Help navigation keys may be related to a program component when the help is related to a specific page in system.

### Navigation Key vs. Navigation Option

The system has two entities that work in conjunction with each other to specify how navigation works:

- **Navigation Key** defines a unique location to which a user can navigate. For example, each page in the system has a unique navigation key. Navigation keys can also define locations that are "outside" of the system. For example, you can create a navigation key that references an external URL. Think of a navigation key as defining "where to go".
- **Navigation Option** defines how a page is opened when a user wants to navigate someplace. For example, you might have a navigation key that identifies a specific page. This navigation key can then be referenced on two navigation options; the first navigation option may allow users to navigate to the page with no context included, while the second navigates to the page with context data provided to automatically display information related to that context.
- Please note that a wide variety of options can be defined on a navigation option. In addition to defining if data is passed to the page, it could also define search options. In addition, there are some navigation options that do not reference a navigation key but rather refer to a BPA script that should be launched.

## The Flexibility of Navigation Keys

Navigation keys provide a great deal of functionality to your users. Use navigation keys to:

- Allow users to navigate to new pages or search programs
- Allow users to transfer to an external system or web page. After setting up this data, your users may be able to access this external URL from a menu, a context menu, their favorite links, etc. Refer to [Linking to External Locations](#) for more information.

Refer to the Tool Suite Guide for more information on developing program components.

---

**NOTE: Replacing Base-Package Pages or Searches.** If your new page or search has been designed to replace a module in the base-package, the navigation key must indicate that it is [overriding an existing navigation key](#).

---

## Linking to External Locations

If you want to include links to external systems or locations from within the system, you need to:

- Define a [navigation key](#) that specifies the URL of the location. For example, define an external navigation key that as a URL of <http://www.oracle.com/>.
- Define a [navigation option](#) that specifies from where in the system a user can go to your external location. For example, define a navigation option with a usage of **Favorites** or with a usage of **Menu**. Your navigation option points to the navigation key you defined above.
- Add your navigation option to the appropriate location within the system. For example, have users add the navigation option to their [Favorite Links](#) or add the navigation option as an item on a [menu](#).

## Overriding Navigation Keys

Your implementation may choose to design a program component (e.g., a maintenance transaction or search page) to replace a component provided by the system. When doing this, the new navigation key must indicate that it is overriding the system navigation key. As a result, any menu entry or navigation options that reference this overridden navigation key automatically navigates to the custom component.

For example, if you have a custom On-line Batch Submission page and would like users to use this page rather than the one provided by the system, setting up an override navigation key ensures that if a user chooses to navigate to the On-line Batch Submission from Menu or a context menu, the user is brought to the custom On-line Batch Submission page.

To create an override navigation key, you need to:

- Define a [navigation key](#) using an appropriate [naming convention](#).
- If the Navigation Key Type of the navigation key being overridden is **External**, specify a Navigation Key Type of **Override (Other)** and define the appropriate URL Component.
- If the Navigation Key Type of navigation key being overridden is **System**, specify a Navigation Key Type of **Override (System)** and populate the Program Component ID with your custom program component ID.
- Specify the navigation key that you are overriding in the **Overridden Navigation Key** field.

Refer to the Tool Suite Guide for more information about developing your own program components.

## Maintaining Navigation Keys

Select **Admin > System > Navigation Key** to maintain navigation keys.

---

**CAUTION:** Important! When introducing a new navigation key, carefully consider its naming convention. Refer to [System Data Naming Convention](#) for more information.

---

### Description of Page

The **Navigation Key** is a unique name of the navigation key for internal use.

**Owner** indicates if this navigation key is owned by the base product or by your implementation (**Customer Modification**). This information is display-only.

**Navigation Key Type** includes the following possible values:

- **External** indicates that the location is specified in the **URL Component** field.
- **Help** indicates that the navigation key is used to launch online help where the specific help topic is defined in the **URL Component** field.
- **Override (Other)** indicates that the navigation key overrides another navigation key of type **External** or **Help**. For this option, the name of the navigation key being overridden is populated in the **Overridden Navigation Key** field.
- **Override (System)** indicates that the navigation key overrides a system navigation key. For this option, the name of the navigation key being overridden is populated in the **Overridden Navigation Key** field.
- **System** indicates that the navigation key refers to a transaction in the system identified by its program component.

---

**FASTPATH:** Refer to [Navigation Key Types](#) for more information about navigation key types.

---

**FASTPATH:** Refer to [Overriding Navigation Keys](#) for more information about settings required to override a system navigation key.

---

**Program Component ID** is the name of the program component identified by the key (for system navigation keys). The program component ID can also be used to specify the transaction with which an online help link is associated.

**Overridden Navigation Key** is the name of the navigation key that the current navigation key is overriding (if **Override (Other)** or **Override (System)** is selected for the **Navigation Key Type**). Refer to [Overriding Navigation Keys](#) for more information.

**URL Component** is the specific URL or portion of the URL for the navigation key (external and help navigation keys only). The URL can be relative to the product web server or fully qualified.

**Open Window Options** allows you to specify options (e.g., width and height) for opening a browser window for an external navigation key. (External navigation keys always launch in a new browser window.) You can use any valid features available in the `Window.open()` JavaScript method. The string should be formatted the same way that it would be for the features argument (e.g., **height=600,width=800,resizeable=yes,scrollbars=yes,toolbar=no**). Refer to a JavaScript reference book for a complete list of available features.

**Application Service** is the application service that is used to secure access to transactions associated with **External** navigation keys. If a user has access to the specified application service, the user can navigate to the URL defined on the navigation key. Refer to [The Big Picture of Application Security](#) for more information.

The grid displays menu items that reference the navigation key (actually, it shows menu items that reference navigation options that, in turn, reference the navigation key).

### Where Used

Follow this link to open the data dictionary where you can view the tables that reference [CI\\_MD\\_NAV](#).

## Defining Navigation Options

Every time a user navigates to a transaction, the system retrieves a navigation option to determine which transaction should open. For example:

- A navigation option is associated with every menu item. When a user selects a menu item, the system retrieves the related navigation option to determine which transaction to open.
- A navigation option is associated with every [favorite link](#). When a user selects a favorite link, the system retrieves the related navigation option to determine which transaction to open.
- A navigation option is associated with every node in the various trees. When a user clicks a node in a tree, the system retrieves the related navigation option to determine which transaction to open.
- Etc.

Many navigation options are shipped with the base product and cannot be modified as these options support core functionality. As part of your implementation, you may add additional navigation options to support your specific business processes.

Navigation options may also be used to launch a BPA script.

The topics in this section describe how to maintain navigation options.

---

**CAUTION:** In order to improve response times, navigation options are cached the first time they are used after a web server is started. If you change a navigation option and you don't want to wait for the cache to rebuild, you must clear the cached information so it will be immediately rebuilt using current information. A special button has been provided on the Main tab of the navigation option transaction that performs this function. Please refer to [Caching Overview](#) for information on the various caches.

---

## Navigation Option - Main

Select **Admin > System > Navigation Option** to maintain a navigation option.

### Description of Page

Enter a unique **Navigation Option** code and **Description**.

---

**CAUTION:** When introducing a new navigation option, carefully consider its naming convention. Refer to [System Data Naming Convention](#) for more information.

---

The **Flush System Login Info** button is used to flush the cached navigation options so you can use any modified navigation options. Refer to [Caching Overview](#) for more information.

**Owner** indicates if this navigation option is owned by the base product or by your implementation (**Customer Modification**). This field is display-only. The system sets the owner to **Customer Modification** when you add a navigation option.

---

**NOTE:** You may not change navigation options that are owned by the base product.

---

Use **Navigation Option Type** to define if the navigation option navigates to a **Transaction**, launches a BPA **Script** or opens an **Attachment**.

---

**NOTE:** The **Attachment** option type is only applicable to navigation options that are used to launch a file attached to a record in the Attachment maintenance object.

---

For navigation option types of **script**, indicate the **Script** to launch. You can use the **Context Fields** at the bottom of the page if you want to transfer the contents of specific fields to temporary storage variables available to the script. The script engine creates temporary storage variables with names that match the Context Field names.

For navigation option types of **transaction**, define the **Target Transaction** (navigation key) and optionally a specific **Tab Page** (also a navigation key) if a specific tab on the transaction (other than the Main tab) should be opened when navigating to that transaction.

---

**NOTE: Finding transaction navigation keys.** When populating the **Target Transaction** and **Tab Page** you are populating an appropriate navigation key. Because the system has a large number of transactions, we recommend using the "%" metaphor when you search for the transaction identifier. For example, if you want to find the currency maintenance transaction, enter "%currency" in the search criteria.

---

The additional information depends on whether the target transaction is a fixed page or a portal-based page:

- For portal-based pages:
  - **Navigation Mode** is not applicable and should just be set to **Add Mode**.
  - If navigating to a query portal, by default the query portal will open with the default search option defined. If the navigation should open a different search option, define the **Multi-Query Zone** for that query portal and indicate the **Sub-Query Zone** to open by default. Note that for this configuration, it is common to define **Context Fields** to pre-populate search criteria in the target query zone. When using this configuration, be sure that the target query zone's user filters are defined to populate data from context.
- For fixed pages:
  - **Navigation Mode** indicates if the **Target Transaction** should be opened in **Add Mode** or **Change Mode**.
  - **Add Mode** should be used if the option is used to navigate to a transaction ready to add a new object. You can use the **Context Fields** at the bottom of the page if you want to transfer the contents of specific fields to the transaction when it opens.
  - **Change Mode** is only applicable for fixed pages and should be used if the option is used to navigate to a transaction ready to update an object. You have two ways to define the object to be changed:
    - Define the name of the fields that make up the unique identifier of the object in the **Context Fields** (and make sure to turn on **Key Field** for each such field).
    - Define the **Search Transaction** (navigation key) if you want to open a search window to retrieve an object before the target transaction opens. Select the appropriate **Search Type** to define which search method should be used. The options in the drop down correspond with the sections in the search (where **Main** is the first section, **Alternate** is the 2<sup>nd</sup> section, **Alternate 2** is the 3<sup>rd</sup> section, etc.). You should execute the search window in order to determine what each section does.

When you select a **Search Type**, define appropriate **Context Fields** so that the system will try to pre-populate the search transaction with these field values when the search first opens. Keep in mind that if a search is populated with field values the search is automatically triggered and, if only one object is found that matches the search criteria, it is selected and the search window closes.

  - **Search Group** is only visible if the **Development Tools** module is **not turned off**. It is used to define the correlation between fields on the search page and the tab page. You can view a tab page's **Search Groups** by viewing the HTML source and scanning for **allFieldPairs**.

The **Go To Tooltip** is used to specify the label associated with the tool tip that appears when hovering over a **Go To** object. Refer to the **Usage** grid below.

The **Usage** grid defines the objects on which this navigation option is used:

- Choose **Favorites** if the navigation option can be used as a [favorite link](#).
- Choose **Menus** if the navigation option can be used as a user's [home page](#) or as a menu or context menu item.
- Choose **Script** if the navigation option can be used in a [script](#).
- Choose **Foreign Key** if the navigation option can be used as a [foreign key reference](#).
- Choose **Go To** if the navigation option can be used as a "go to" destination ("go to" destinations are used on Go To buttons, tree nodes, and hyperlinks).
- If your product supports marketing campaigns, you can choose **Campaign** if the navigation option can be used as a "post completion" transaction on a campaign. For more information refer to that product's documentation for campaigns.

The **Context Fields** grid contains the names of the fields whose contents will be passed to the **Target Transaction** or **Script** or used to launch an **Attachment**. The system retrieves the values of these fields from the "current" page and transfers them to the target transaction or to the script's temporary storage. Turn on **Key Field** for each context field that makes up the unique identifier when navigating to a transaction in **Change Mode**.

---

**NOTE:** For an **Attachment**, the grid should contain the Attachment ID.

---

**NOTE: Navigating from a Menu.** The standard followed for many base main **menu** navigation options for fixed transactions is that navigation options launched from the Menu dropdown are configured with no context.

---

### Where Used

Follow this link to open the data dictionary where you can view the tables that reference [CL\\_NAV\\_OPT](#).

## Navigation Option - Tree

This page contains a tree that shows how a navigation option is used. Select **Admin > System > Navigation Option** and navigate to the **Tree** tab to view this page.

### Description of Page

The tree shows every menu item, favorite link, and tree node that references the navigation option. This information is provided to make you aware of the ramifications of changing a navigation option.

## Database Tools

This section describes a variety of database tools that are supplied with the your product.

## Defining Table Options

The topics in this section describe the transaction that allows you to define metadata for the application's tables.

### Table - Main

Navigate using **Admin > Database > Table**.

#### Description of Page

**Table Name** is the identifier of this table.

**Description** contains a brief description of the table.

**System Table** defines if the table includes rows that are owned by the base product.

**Enable Referential Integrity** defines if the system performs referential integrity validation when rows in this table are deleted.

**Data Group ID** is used for internal purposes.

**Enable Data Dictionary** defines if the table is to be included in the [Data Dictionary](#) application viewer.

**Table Type** defines if the table is an **External Table**, a **View** or a physical **Table**.

**Date / Time Data Type** defines if the system shows times on this table in **Local Legal Time** or in **Local Standard Time**. Local Legal Time is the time as adjusted for daylight savings / summer time.

**Table Classification Type** specifies the category of data the table will hold. This is for information purposes only and is not used by any system processing. Valid values are **Admin System Table**, **Admin Non System Table**, **Master Table**, **Transaction Table**, and **Unclassified**.

**Table Volume Type** specifies the expected amount of data the table will hold. This is for information purposes only and is not used by any system processing. Valid values are **High Volume**, **Low Volume**, **Medium Volume**, and **Unclassified**. The volume of data in a particular table in the system may differ greatly from one implementation to another based on unique business requirements. The values populated for base product tables are set to volumes that are typical but may not be true for a given implementation. The value may be updated to reflect the situation for a given implementation.

**Audit Table** is the name of the table on which this table's audit logs are stored if using the legacy table / field audit technique. Refer to [The Audit Trail File](#) for more information.

Use **Audit Program Type** to define if the audit program is written in **Java** or **Java (Converted)**, meaning it was converted into Java.

---

**NOTE: Java (Converted)** program types are not applicable to all products.

---

**Audit Program** is the name of the program that is executed to store an audit log. Refer to [Turn On Auditing For a Table](#) for more information.

---

**NOTE: View the source.** If the program is shipped with the base package, you can use the adjacent button to display the source code of this program in the [Java docs viewer](#).

---

**Upgrade** controls what happens to the rows in this table when the system is upgraded to a new release:

- **Keep** means that the rows on this table are not touched during an upgrade
- **Merge** means that the rows on this table are merged with rows owned by the base product
- **Refresh** means that the rows on this table are deleted and refreshed with rows owned by the base product.

**Data Conversion Role** controls if / how the table is used by the conversion tool:

- **Convert (Retain PK)** means that the table's rows are populated from the conversion schema and the prime key in the conversion schema is used when the rows are converted. A new key is not assigned by the system.
- **Convert (New PK)** means that the table's rows are populated from the conversion schema and the prime key is reassigned by the system during conversion.
- **Not Converted** means that the table's rows are not managed by the conversion tool.
- **View of Production** means that the conversion tool uses a view of the table in production when accessing the rows in the table. This is commonly used for administrative tables.

A **Language Table** is specified when fields containing descriptions are kept in a child table. The child table keeps a separate record for each language for which a description is translated.

A **Characteristic Entity** is populated if this table is used to capture characteristics and indicates the associated characteristic entity lookup value for this table. When defining characteristic types, you indicate the characteristic entities where that characteristic type is applicable / valid.

A **Key Table** is specified when the prime-key is assigned by the system. This table holds the identity of the prime keys allocated to both live and archived rows.

**Type of Key** specifies how prime key values are generated when records are added to the table:

- **Other** means a foreign-system allocates the table's prime-key.
- **Sequential** means a sequence number is incremented whenever a record is added to the table. The next number in the sequence determines the key value.
- **System-generated** means a program generates a random key for the record when it is added. If the record's table is the child of another table, it may inherit a portion of the random number from its parent's key.



- **User-defined** means the user specifies the key when a record is added.

**Inherited Key Prefix Length** defines the number of most significant digits used from a parent record's primary key value to be used as the prefix for a child record's key value. This is only specified when the Type of Key is **System-generated** and the high-order values of the table's key is inherited from the parent table.

---

**NOTE:** In general, randomly generated system keys are used to attempt to evenly distribute records across a full range of possible IDs. Batch programs that use multiple threads will typically divide the threads using ID ranges and evenly distributed keys will help spread out the work. The reason for inherited keys for child records further extends the performance benefit. When considering partitioning, the recommendation for DBAs is to range partition data based on the primary key so that different batch threads operate on different partitions which reduces contention for hot blocks. Ideally the number of batch threads will be an exact multiple of the number of partitions. Batch programs that insert child data (for example batch Billing creation) also benefit from this design especially when the child tables are partitioned in the same way. The parent is often the driver of the batch process. If this is multi-threaded, then each thread is processing a set of parent records in a given ID range and all child records are being inserted into the same ID range.

---

**Java Table Name.** This field is used to identify the entity/Java class name of the class that represents the table in the Java code. It should contain a short "camelCased" name to be used as the name of the entity within the system. It must also be a valid Java name, and must be unique across the system. This name is used as follows:

- As the short class name on all classes in the Java hierarchy for the class: the Impl class, the Gen, and the interface.
- In HQL queries, it is used to identify the hibernate entity being selected.

**Caching Regime** determines if the table's values should be cached when they are accessed by a batch process. The default value is **Not Cached**. You should select **Cached for Batch** if you know the values in the table will not change during the course of a batch job. For example, currency codes will not change during a batch process. Caching a table's values will reduce unnecessary SQL calls and improve performance.

**Key Validation** determines if and when keys are checked for uniqueness. The default value is **Always Check Uniqueness**. Select **Check Uniqueness Online Only** when the database constructs the keys in the table, such as in log tables. Select **Never Perform Uniqueness Checking** when you know that the database constructs the keys in the table and that users cannot add rows directly to the table, such as in log parameter tables. This will reduce unnecessary SQL calls and improve performance.

**Help URL** is the link to the user documentation that describes this table.

**Help Text** contains additional information about the table.

**Extract for Translation** is only visible in a development environment. It indicates whether or not the table includes strings that are eligible for product translation.

**Translation Context** is only visible in a development environment. It is used to provide information to a translator about the nature and purpose of rows in the table.

---

**NOTE: Changes to base owned tables.** Only the following attributes of tables that are owned by the product are modifiable: Audit Table, Audit Program Type, Audit Program, Caching Regime, Key Validation and Table Volume Type.

---

The grid contains an entry for every field on the table. Drilling down on the field takes you to the [Table Field](#) tab where you may modify certain attributes. The following fields may also be modified from the grid: **Description, Override Label, Audit Delete, Audit Insert** and **Audit Update**. Refer to the Table Field tab for descriptions of these fields.

## Table - Table Field

Navigate using **Admin > Database > Table** and click the **Table Field** tab.

### Description of Page

**Field Name** is the name of the field. It is followed by its **Java Field Name**.



**Field Help Text** displays the help text listed for this field on the Field page, if populated.

**Nullable, Required** and **Validate** are for internal use.

Turn on **Audit Delete** if an audit record should be stored for this field when a row is deleted. Refer to [How To Enable Auditing](#) for more information.

Turn on **Audit Insert** if an audit record should be stored for this field when a row is added. Refer to [How To Enable Auditing](#) for more information.

Turn on **Audit Update** if an audit record should be stored for this field when it is changed. Refer to [How To Enable Auditing](#) for more information.

The **Allow Customization** is only applicable if the table is an Admin System Table. It indicates fields that an implementation is allowed to change for a base owned record. Changes to the field value of one of these types of fields by an implementation are maintained when upgrading to a new version of the product.

**Standard Time Type** is only enabled if the Table indicates that the Date/Time Data Type is **Local Standard Time**. Each field that represent date/time should define if it uses **Logical Standard Time**, **Physical Standard Time** or uses a **Referenced Time Zone**.

**Sequence** is a unique sequence of this field with respect to other fields on the table.

The **Label** column is used to define a special label for this field when it relates to this table if it should be different from the field's label. Note that this only impacts the label on a fixed page user interface. Labels on portal based user interfaces do not use this information.

The **Override Label** is provided if an implementation wants to override the base-product label.

---

**NOTE:** If you want the Override Label to be shown in the [data dictionary](#), you must regenerate the data dictionary.

---

**Help Text** contains any additional information about the field with respect to its use on this table.

**Extract for Translation** is only visible in a development environment. For tables marked to extract for translation, each translatable field on the table should indicate **Yes**.

**Translation Context** is only visible in a development environment. It is used to provide information to a translator about the nature and purpose of the data in this field on this table.

---

**NOTE: Changes to base owned table / fields.** Only the following attributes of table / fields that are owned by the product are modifiable: Audit Delete, Audit Insert, Audit Update, Override Label.

---

## Table - Constraints

Select **Admin > Database > Table** and navigate to the **Constraints** tab to view the constraints defined on the table.

### Description of Page

The fields on this page are protected as only the product development group may change them.

This page represents a collection of constraints defined for the table. A constraint is a field (or set of fields) that represents the unique identifier of a given record stored in the table or a field (or set of fields) that represents a given record's relationship to another record in the system.

**Constraint ID** is a unique identifier of the constraint.

**Owner** indicates if this is owned by the base package or by your implementation (**Customer Modification**)

**Constraint Type Flag** defines how the constraint is used in the system:

- **Primary Key** represents the field or set of fields that represent the unique identifier of a record stored in a table.
- **Logical Key** represents an alternate unique identifier of a record based on a different set of fields than the Primary key.

- **Foreign Key** represents a field or set of fields that specifies identifying and non-identifying relationships to other tables in the application. A foreign key constraint references the primary key constraint of another table.
- **Conditional Foreign Key** represents rare relationships between tables where a single field (or set of fields) may reference multiple primary key constraints of other tables within the application as a foreign key.

When **Enable Referential Integrity** is checked, the system validates the integrity of the constraint when a row in the table is modified.

**Referring Constraint Owner** indicates if this is owned by the base package or by your implementation (**Customer Modification**).

**Referring Constraint ID** is the **Primary Key** constraint of another table whose records are referenced by records stored in this table.

**Referring Constraint Table** displays the table on which the Referring Constraint ID is defined. You can use the adjacent go-to button to open the table.

**Additional Conditional SQL Text** is only specified when the constraint is a **Conditional Foreign Key**. The SQL represents the condition under which the foreign key represents a relationship to the referring constraint table.

---

**NOTE: Additional Conditional SQL Syntax.** When specifying additional conditional SQL text, all table names are prefixed with a pound (#) sign.

---

The Constraint Field grid at the bottom of the page is for maintaining the field or set of fields that make up this constraint.

**Field** is the name of the table's field that is a component of the constraint.

**Sequence** The rank of the field as a component of the constraint.

The Referring Constraint Field grid at the bottom of the page displays the field or set of fields that make up the **Primary key** constraint of the referring constraint.

**Field** is the name of the table's field that is a component of the referring constraint.

**Sequence** is the rank of the field as a component of the referring constraint.

## Table - Referred by Constraints

Select **Admin > Database > Table** and navigate to the **Referred By Constraints** tab to view the constraints defined on other tables that reference the **Primary Key** constraint of this table.

### Description of Page

This page is used to display the collection of constraints defined on other tables that reference the table.

**Referred By Constraint Id** is the unique identifier of the constraint defined on another table.

**Referred By Constraint Owner** indicates if this constraint is owned by the base package or by your implementation (**Customer Modification**).

**Prime Key Constraint Id** is the **Primary Key** constraint of the current table.

**Prime Key Owner** indicates if this prime key is owned by the base package or by your implementation (**Customer Modification**).

**Referred By Constraint Table** is the table on which Referred By Constraint ID is defined.

When **Enable Referential Integrity** is checked, the system validates the integrity of the constraint when a row in the table is modified.

The grid at the bottom of the page displays the **Field** and **Sequence** for the fields that make up the constraint defined on the other table.

## Defining Field Options

The topics in this section describe the transaction that can be used to view information about a field and to change the name of a field on the various pages in the system.

### Field - Main

Open this page using **Admin > Database > Field**.

#### Description of Page

**Field Name** uniquely identifies this field.

---

**CAUTION:** As described in [System Data Naming Convention](#) for most system data tables, the base product follows a specific naming convention. However, this is not true for the Field table. If you introduce new fields, you must prefix the field with **CM**. If you do not do this, there is a possibility that a future release of the application could introduce a new field with the name you allocated.

---

**Owner** indicates if this field is owned by the base package or by your implementation (**Customer Modification**). The system sets the owner to **Customer Modification** when you add a field.

**Base Field** indicates that the field inherits some of its definitions from another field.

**Data Type** indicates if the type of data the field will hold. Valid values are **Character, Character Large Object, Date, DateTime, Number, Time, Varchar2** and **XML Type**. This field is protected if the field refers to a Base Field.

**Ext Data Type** or Extended Data Type is used to further define the type of data for certain data types. Valid values are **Currency Source, Day of Month, Duration, Money, Month of Year, Flag, Switch** and **URI**. This field is protected if the field refers to a Base Field.

**Precision** defines the length of the field. In the case of variable length fields, it is the maximum length possible. For number fields that include decimal values, the precision includes the decimal values. This field is protected if the field refers to a Base Field.

**Scale** is only applicable for number fields. It indicates the number of decimal places supported by the field. This field is protected if the field refers to a Base Field.

**Sign** is only applicable for numbers. It indicates if the data may contain positive or negative numbers.

**Value List** is only visible for products that had at one point included COBOL. It defines the copybook that includes the list of valid values for the field.

**Description** contains the label of the field. This is the label of the field that appears on the various pages on which the field is displayed. Note, the field's label can be overridden for a specific table by specifying an Override Label on the [table / field](#) information. However, this override is not used in portal based user interfaces. It is only applicable if the field is displayed on fixed page user interfaces.

**Java Field Name** is the reference to this field used in Java code.

**Override Label** is used if an implementation would like to override the label that appear on user interfaces in the system.

---

**CAUTION:** For fixed pages, if the field's label is overridden for a specific table, that override takes precedence. In this is the case the override on the [table / field](#) page should be used.

---

**Work Field** indicates that the field does not represent a database table column.

**Help Text** is used to provide field level embedded help to this field. If the field is displayed on a user interface that supports display of embedded help, this text may be displayed.

Use **Override Help Text** to override the existing embedded help text for this field.

**Extract for Translation** is only visible in a development environment. It indicates whether or not the field and its description should be included in an extract of translatable strings when doing a product translation. This flag may be set to "No" for work fields whose label is not visible to a user on any user interface.

**Translation Context** is only visible in a development environment. It is used to provide information to a translator about the use of the field's label so that an appropriate translation can be provided.

## Field - Tables Using Field

Select **Admin > Database > Field** and navigate to the **Tables Using Field** tab to view the tables that contain a field.

### Description of Page

The grid on this page contains the **Tables** that reference the **Field**. You can use the adjacent go to button to open the [Table Maintenance](#) transaction.

## Defining Maintenance Object Options

A maintenance object defines the configuration of a given "entity" in the system. It includes the definition of the tables that together capture the physical data for the entity. In addition, the maintenance object includes options that define important information related to the maintenance object that may be accessed for logic throughout the system. Several algorithm plug-in spots are also defined on the maintenance object, allowing for business rules that govern all records for this maintenance object.

Many maintenance objects in the system support the use of business objects to further define configuration and business rules for a given record. Refer to [The Big Picture of Business Objects](#) for more information.

## Maintenance Object - Main

Select **Admin > Database > Maintenance Object** to view information about a maintenance object.

### Description of Page

Most maintenance objects are provided with the base package. An implementation can introduce custom maintenance objects when needed. Most fields may not be changed if owned by the base package.

Enter a unique **Maintenance Object** name and **Description**. **Owner** indicates if this business object is owned by the base package or by your implementation (**Customer Modification**).

---

**IMPORTANT:** If you introduce a new maintenance object, carefully consider its naming convention. Refer to [System Data Naming Convention](#) for more information.

---

**Service Name** is the name of the internal service associated with the maintenance object.

Click the **View XML** hyperlink to view the XML document associated with the maintenance object service in the [Service XML Viewer](#).

Click the **View MO** hyperlink to view the definition of the maintenance object in the [Maintenance Object Viewer](#).

The grid displays the following for each table defined under the maintenance object:

- **Table** is the name of a given table maintained as part of the maintenance object.
- **Table Role** defines the table's place in the maintenance object hierarchy. Only one **Primary** table may be specified within a maintenance object, but the maintenance object may contain many **Child** tables.
- **Parent Constraint ID** specifies the [constraint](#) used to link the table to its parent table within the maintenance object table hierarchy.
- **Owner** indicates if this is owned by the base package or by your implementation (**Customer Modification**).

## Maintenance Object - Options

Use this page to maintain a maintenance object's options. Open this page using **Admin > Database > Maintenance Object** and then navigate to the **Options** tab.

### Description of Page

The options grid allows you to configure the maintenance object to support extensible options.

Select the **Option Type** drop-down to define its **Value**. **Detailed Description** may display additional information on the option type.

Set the **Sequence** to **1** unless the option can have more than one value.

**Owner** indicates if this is owned by the base package or by your implementation (**Customer Modification**).

---

**NOTE: You can add new option types.** Your implementation may want to add additional maintenance option types. For example, your implementation may have plug-in driven logic that would benefit from a new type of option. To do that, add your new values to the customizable lookup field **MAINT\_OBJ\_OPT\_FLG**.

---

## Maintenance Object - Algorithms

Use this page to maintain a maintenance object's algorithms. Open this page using **Admin > Database > Maintenance Object** and then navigate to the **Algorithms** tab.

### Description of Page

The **Algorithms** grid contains algorithms that control important functions for instances of this maintenance object. You must define the following for each algorithm:

- Specify the **System Event** with which the algorithm is associated (see the table that follows for a description of all possible events).
- Specify the **Sequence Number** and **Algorithm** for each system event. You can set the **Sequence Number** to 10 unless you have a **System Event** that has multiple **Algorithms**. In this case, you need to tell the system the **Sequence** in which they should execute.
- If the algorithm is implemented as a script, a link to the **Script** is provided. Refer to [Plug-in Scripts](#) for more information.
- **Owner** indicates if this is owned by the base package or by your implementation (**Customer Modification**).

The following table describes each **System Event**.

System Event	Optional / Required	Description
Audit	Optional	Algorithms of this type are called to notify of any changes to the maintenance object's set of tables. These algorithms are invoked just before the commit at the end of a logical transaction. The system keeps track of what records are added or changed in the course of a transaction and all MO audit algorithms are executed in order of when each record was first added or updated.  Click <a href="#">here</a> to see the algorithm types available for this system event.
Determine BO	Optional	Algorithm of this type is used to determine the Business Object associated with an instance of the maintenance object. It is necessary to plug in such an algorithm on a Maintenance Object to enable the business object rules functionality.

System Event	Optional / Required	Description
ILM Eligibility	Optional	<p>The system invokes a single algorithm of this type. If more than one algorithm is plugged-in the system invokes the one with the greatest sequence number.</p> <p>Click <a href="#">here</a> to see the algorithm types available for this system event.</p>
Information	Optional	<p>Algorithms of this type are used for maintenance objects that are enabled for object erasure for <a href="#">Information Lifecycle Management</a>. They are used to review records that have reached the maximum retention days and evaluate if they are ready to be archived.</p> <p>The system invokes a single algorithm of this type. If more than one algorithm is plugged-in the system invokes the one with the greatest sequence number.</p> <p>Click <a href="#">here</a> to see the algorithm types available for this system event.</p>
Manage Erasure Schedule	Optional	<p>We use the term "Maintenance Object Information" to describe the basic information that appears throughout the system to describe an instance of the maintenance object. The data that appears in this information description is constructed using this algorithm.</p> <p>The system invokes a single algorithm of this type. If more than one algorithm is plugged-in the system invokes the one with the greatest sequence number.</p> <p>Click <a href="#">here</a> to see the algorithm types available for this system event.</p>
Revision Control	Optional	<p>Algorithms of this type are used for maintenance objects that are enabled for object erasure, which is a measure to protect <a href="#">Data Privacy</a>. They are triggered when certain system events occur for those objects. The algorithms are used to determine if the record needs to be scheduled for erasure and, if so, create or maintain an entry for the record in the Object Erasure Schedule.</p> <p>Click <a href="#">here</a> to see the algorithm types available for this system event.</p>
Transition	Optional	<p>An algorithm of this type is used to enforce revision control rules when an object is added, changed or deleted. The maintenance object service calls the plug-in once before the object is processed and once more after applying all business object rules. This allows revision rules to take place in proper revision timings.</p> <p>Click <a href="#">here</a> to see the algorithm types available for this system event.</p> <p>The system calls algorithms of this type upon each successful state transition of a business object as well as when it is first created. These are typically used to record the transition on the maintenance object's log.</p> <p>Note that most base maintenance objects are already shipped with an automatic logging of state transitions. In this case you may use these algorithms to override the base logging functionality with your own. Refer to <a href="#">State Transitions are Audited</a> for more information.</p>

System Event	Optional / Required	Description
		Click <a href="#">here</a> to see the algorithm types available for this system event.
Transition Error	Optional	<p>The system calls this type of algorithm when a state transition fails and the business object should be saved in its latest successful <a href="#">state</a>. The algorithm is responsible for logging the transition error somewhere, typically on the maintenance object's log.</p> <p>Notice that in this case, the caller does NOT get an error back but rather the call ends successfully and the exception is recorded somewhere, as per the plug-in logic.</p> <p>The system invokes a single algorithm of this type. If more than one algorithm is plugged-in the system invokes the one with the greatest sequence number.</p> <p>Click <a href="#">here</a> to see the algorithm types available for this system event.</p>

**NOTE: You can inactivate algorithms on Maintenance Objects.** Your implementation may want to inactivate one or more algorithms plugged into the base maintenance object. To do that, go to the options grid on Maintenance Object - Options and add a new option, setting the option type to **Inactive Algorithm** and setting the option value to the algorithm code.

## Maintenance Object - Maintenance Object Tree

You can navigate to the **Maintenance Object Tree** to see an overview of the tables and table relationships associated with the maintenance objects.

### Description of Page

This page is dedicated to a [tree](#) that shows the maintenance object's tables as well as [business objects](#), if you have defined any. You can use this tree to both view high-level information about these objects and to transfer to the respective page in which an object is maintained.

## Defining Valid Values

The product provides several options for defining valid values for a column on a table:

- Lookup
- Extendable Lookup
- Control Table

The following provides more information about the functionality of each of the options available for defining valid values for a column.

### Lookup

The simplest mechanism for defining valid values for a column on a table is via the Lookup table. This is sometimes referred to as a “simple” lookup to distinguish it from an extendable lookup (described below). Using the lookup table, you can define valid values and their descriptions. When choosing a valid value that is defined by a lookup, a dropdown UI metaphor is used.

The following highlights functionality related to lookups:

- Lookups are associated with a [Field](#). The field is defined as a character data type with an extended data type of **Flag**. The field's label serves as the description for the prompt to select the valid value.

- The lookup code is limited to four characters and must be all uppercase. If there is any functionality where a valid value in the application must match valid values in an external system, the lookup table may not be the appropriate choice.
- The lookup table does not support additional attributes to be defined for each value. This option is only appropriate when a simple code and description pair is needed.
- The product may also use Lookups to define valid values for functionality unrelated to a column on a table. For example, an algorithm plug-in spot may define an input parameter that supports one or more valid values. The plug-in spot may define the valid values using a lookup, allowing for a simple way to validate the value supplied when invoking the algorithm and to document the valid values.

---

**FASTPATH:** For more information, refer to [Defining Lookup Options](#).

---

## Extendable Lookup

The extendable lookup provides a way of defining valid values for a column with additional capabilities that are not supported using the Lookup table. When choosing a valid value that is defined by an extendable lookup, a dropdown UI metaphor is used.

The following highlights functionality related to extendable lookups:

- Each Extendable Lookups is defined using a business object.
- A field should be defined for the extendable lookup code. The field defines the label for the lookup code and defines the size of the lookup code. The size is determined based on the business use case. In addition, there are standard fields included in all extendable lookups, including a description, detailed description and an override description (so that implementations can override the description of base delivered values).
- The extendable lookup may define additional information for each value if warranted by the business requirement. See [Additional Attributes](#) for technical information about additional attributes.

---

**FASTPATH:** For more information, refer to [Defining Extendable Lookups](#).

---

## Control Table

There may be scenarios where a list of valid values warrants a standalone maintenance object, which is considered an administrative or control table object. When choosing a valid value that is defined by a control, either a dropdown UI metaphor or a search metaphor is used, depending on how it has been designed.

The following points highlight some reasons why this option may be chosen:

- The records require a lifecycle such that BO status is warranted.
- The additional attributes are sophisticated enough that they warrant their own column definition rather than relying on using CLOB or flattened characteristic. For example, if a list of information needs to be captured with several attributes in the list and the information in the list needs to be searchable.

In this situation, if a product has provided a control table for this type of functionality, it will be documented fully in the appropriate functional area. If an implementation determines that a custom control table is warranted, all the standard functionality for a maintenance object is required: database tables, maintenance object metadata, appropriate Java maintenance classes, portals, zones, etc. Refer to the Software Development Kit for more information. No further information is provided in this section for this option.

## Defining Lookup Options

Lookup fields may be used to define valid values for a column in a table or for other types of values like parameters to an algorithm.



---

**FASTPATH:** Refer to [Defining Valid Values](#) for some background information.

---

The base product provides many different lookup fields and their values as part of the product. The following points highlight some functionality related to base-package lookups.

- Fields that are owned by the product will typically provide base lookup values. Implementations are not permitted to remove base delivered lookup values. Implementations may be able to add custom values to base owned lookups. This is controlled with the Custom switch on lookup.
- When the custom switch is unchecked, it means that there is functionality controlled by the base values and an implementation may not extend or customize this functionality. An example of this type of lookup is the Data Type field on the [Field](#) table. The system supports a distinct list of data types and an implementation may not add additional values.
- When the custom switch is checked, it means that there is base functionality supplied for the base values but that an implementation can extend the functionality by supplying their own values. An example of this type of lookup is the Access Mode on [Application Service](#). The product provides many values for the access mode lookup, representing various actions a user may perform. Implementations may add their own values to this lookup. Documentation should indicate when functionality may be extended and should highlight the lookup value that can be extended.

---

**CAUTION:** Important! If you introduce new lookup values, you must prefix the lookup value code with **X** or **Y**. If you do not do this, there is a possibility that a future release of the application could introduce a new lookup value with the name you allocated.

---

- There may be some scenarios where the product supplies a base field and base lookup field with no base lookup values supplied. This occurs when the product doesn't have any base functionality driven by the lookup values. Typically this type of lookup is for information or categorization purposes. The configuration guide for the functional area associated with the lookup should include a configuration step regarding defining values for this type of lookup.
- The description of base delivered values may be overridden by an implementation.

An implementation may also identify the need for defining a new lookup field with its values.

## Lookup - Main

Select **Admin > Database > Lookup** to maintain lookup values.

### Description of Page

**Field Name** is the name of the field whose lookup values are maintained in the grid. If you need to add a new lookup field, you must first add the lookup field here, then navigate to the [Field](#) page to create a field with a data type of **Character** and an extended data type of **Flag**.

**Owner** indicates if this lookup field is owned by the base package or by your implementation (**Customer Modification**). This information is display-only.

**Custom** switch is used to indicate whether you are allowed to add valid values for a lookup field whose owner is not **Customer Modification**.

- If this switch is turned on, you may add new values to the grid for system owned lookup fields.
- If this switch is turned off, you may not add, remove or change any of the values for system owned lookup fields, with the exception of the override description.

This field is always protected for system owned lookup fields because you may not change a field from customizable to non-customizable (or vice versa).

**Java Field Name** indicates the name of the field as it is referenced in Java code.

The grid contains the lookup values for a specific field. The following fields are visible:

**Field Value** is the unique identifier of the lookup value. If you add a new value, it must begin with an **X** or **Y** (in order to allow future upgrades to differentiate between your implementation-specific values and base-package values).

**Description** is the name of the lookup value that appears on the various transactions in the system

**Java Value Name** indicates the unique identifier of the lookup value as it is referenced in Java code.

**Status** indicates if the value is **Active** or **Inactive**. The system does not allow **Inactive** values to be used (the reason we allow **Inactive** values is to support historical data that references a value that is no longer valid).

**Detailed Description** is the detailed description for a lookup value, which is provided in certain cases.

**Override Description** is provided if your implementation wishes to override the description of the value provided by the product.

---

**NOTE:** If you wish the override descriptions of your lookup values to appear in the application viewer, you must [regenerate](#) the data dictionary application viewer background process.

---

**Owner** indicates if this lookup value is owned by the base package or by your implementation (**Customer Modification**). The system sets the owner to **Customer Modification** when you add lookup values to a field. This information is display-only.

## Defining Extendable Lookups

Extendable lookups are a way of defining valid values that are more sophisticated than simple lookups.

---

**FASTPATH:** Refer to [Defining Valid Values](#) for some background information.

---

The base product provides extendable lookups as part of the product. The following points highlight some functionality related to base-package extendable lookups.

- The base product may supply base extendable lookup values. Implementations are not permitted to remove base delivered extendable lookup values. It is also possible that implementations may be able to add custom values to base owned lookups. If an implementation is not permitted to add lookup values to the base extendable lookup, the extendable lookup's business object will include validation to prevent this. There is no equivalent of the Custom switch that is on the [lookup](#) field.
- There may be some scenarios where the product supplies a base extendable lookup with no base lookup values supplied. This occurs when the product doesn't have any base functionality driven by the extendable lookup values. The configuration guide for the functional area associated with the extendable lookup should include a configuration step regarding defining values for this type of extendable lookup.
- The description of base delivered values may be overridden by an implementation.

Open this page using **Admin > General > Extendable Lookup**.

You are brought to the **Extendable Lookup Query** where you need to search for the extendable lookup object (i.e., its business object).

Once you have found the appropriate extendable lookup, select the value and you are brought to a standard [All-in-One](#) portal that lists the existing lookup values for the extendable lookup. The standard actions for an All-in-One portal are available here.

## Extendable Lookup Advanced Topics

This section provides some addition technical information about extendable lookup attributes

## Defining Additional Attributes

The product provides a few different ways to define additional values for an extendable lookup. Some of the methods are only relevant for base delivered lookup values as they may impact whether or not an implementation can update the values.

The following table highlights the options available and some summary information about what the option provides.

Option	Brief Description	Extendable Lookup Value Searchable by this Attribute?	Base Delivered Value Modifiable?
Element mapped to BO_DATA_AREA	The element is mapped to a CLOB field that allows for base delivered values to be modified.	No	Yes
Element mapped to BASE_BO_DATA_AREA	The element is mapped to a CLOB field that does not allow for base delivered values to be modified.	No	No
Flattened characteristic	The element is defined using the flattened characteristic mechanism.	Yes	No

The following points highlight information from the table above:

- The decision of defining an additional attribute using a CLOB mapping or a flattened characteristic will depend on whether the functionality expects that the lookup value is known when the attribute is needed (in which case a CLOB mapping is appropriate) or if the functionality expects to determine the lookup value based on the attribute (in which case, a flattened characteristic is appropriate).
- When the base product defines an extendable lookup with additional attributes and intends to provide base extendable lookup values, it needs to determine whether or not implementations may update the additional attribute or not.
  - If no and the value is mapped to a CLOB, it will map the value to the BASE\_BO\_DATA\_AREA column. This means that implementations will receive an owner mismatch error when attempting to change the value. In addition, upgrading to a new release will replace the value with the base value.
  - If yes and the value is mapped to a CLOB, it will map the value to the BO\_DATA\_AREA column. This means that implementations will be able to change the value for a base owned record. In addition, upgrading to a new release will not make any changes to the value.
  - For values mapped to a characteristic, the product does not support an implementation changing the value of a base delivered record. If the product would like to support an implementation overriding this type of value, the business object will need to be designed with a corresponding "override" element (also a flattened characteristic), similar to how the product supplies an Override Description field to support an implementation overriding the base product delivered description for a base value. This element will not be delivered with any value and will allow an implementation to populate that value.

---

**NOTE:** Note that in this situation, the product functionality that uses this value must cater for the override value.

---

- All of this detail is only relevant for base provided extendable lookup values. If an implementation adds custom values for a base supplied extendable lookup, all the additional attributes may be populated as appropriate.
- If an implementation defines a custom extendable lookup business object and wants to define an additional attribute using a CLOB, it doesn't matter which CLOB column is used. Both BO\_DATA\_AREA and BASE\_BO\_DATA\_AREA provide the same functionality for custom business objects.

## Capturing a Password

If an extendable lookup includes configuration of a password for some functionality, the system supports automatic encryption of the password value if the schema maps the password to a characteristic using the characteristic type **F1-PWD**. Refer to the business object **F1-FileStorage** for an example of such a configuration.

## The Big Picture Of Audit Trails

The topics in this section describe one way of auditing changes in the system. Note that this technique has limitations and may not be the best option for all situations.

- This functionality is configured at the table and field level. Many base maintenance objects use an XML or CLOB field to capture one or more elements using XML format, configured using a BO schema. This auditing technique is not able to capture changes to individual elements. It can only capture overall changes to the single field. The BO Audit plug-in is a better option for auditing changes to individual elements with the CLOB / XML field.
- The base table provided for supporting audits limits the field size of the before and after values to 254 bytes.
- Auditing is captured for each field. In some cases it is preferred to capture a before and after image for several fields at once. For example, if an address is changed, it's more user friendly to capture the before and after for the full address rather than the individual address components. The BO Audit plug-in allows for capturing a single audit record for multiple elements rather than granular changes for each element.

The subsequent topics highlight how to enable auditing for fields, and describe the auditing queries that you can use to view audit records.

## Captured Information

When auditing is enabled for a field, the following information is recorded when the field is changed, added and/or deleted (depending on the actions that you are auditing for that field):

- User ID
- Date and time
- Table name
- Row's prime key value
- Field name
- Before image (blank when a row is added)
- After image (blank when a row is deleted)
- Row action (add, change, delete)

## How Auditing Works

You enable auditing on a table in the table's meta-data by specifying the name of the table in which to insert the audit information (the audit table) and the name of the program responsible for inserting the data (the audit trail insert program). Then you define the fields you want to audit by turning on each field's audit switch in the table's field meta-data. You can audit fields for delete, insert and update actions.

Once auditing is enabled for fields in a table, the respective row maintenance program for the table assembles the list of changed fields and calls the audit trail insert program. If any of the changed fields are marked for audit, the audit program inserts audit rows into the audit table.

---

**NOTE: Customizing Audit Information.** You may want to maintain audit information other than what is described in [Captured Information](#) or you may want to maintain it in a different format. For example, you may want to maintain audit information for an entire row instead of a field. If so, your implementation team can use the base audit program and base audit tables as examples when creating your own audit trail insert program and audit table structures.

---

## The Audit Trail File

Audit log records are inserted in the audit tables you define. The base product contains a single such table (called [CI\\_AUDIT](#)). However, the base audit insert program is designed to allow you to use multiple audit tables.

If you want to segregate audit information into multiple tables, you must create these tables. Use the following guidelines when creating new audit tables (that use the base delivered audit insert program):

- The new audit tables must look identical to the base table ([CI\\_AUDIT](#)).
- The new tables must be prefixed with **CM** (e.g., **CM\_AUDIT\_A**, **CM\_AUDIT\_B**, etc.). An appropriate java table name must be defined and an \*\_impl.java program for that java table name must be defined.
- The name of the new table must be referenced on the various tables whose changes should be logged in the new table.

---

**NOTE:** It's important to note if you use your own tables (as opposed to using the base package table called **CI\_AUDIT**), the SQL used to insert and access audit trail records in the base delivered audit program is dynamic. Otherwise, if the base package's table is used, the SQL is static.

---

## How To Enable Auditing

Enabling audits is a two-step process:

- First, you must turn on auditing for a table by specifying an audit table and an audit trail insert program.
- Second, you must specify the fields and actions to be audited for the table.

The following topics describe this process.

## Turn On Auditing For a Table

In order to tell the system which fields to audit, you must know the name of the table on which the field is located. You must specify the audit table and the audit trail insert program for a table in the table's meta-data.

---

**NOTE:** Most of the system's table names are fairly intuitive. For example, the user table is called [SC\\_USER](#), the navigation option table is called [CI\\_NAV\\_OPT](#), etc. If you cannot find the table using the search facility on the [Table Maintenance](#) page, try using the [Data Dictionary](#). If you still cannot find the name of the table, please contact customer support.

---

To enable auditing for a table:

- Navigate to the [Table maintenance](#) page and find the table associated with the field(s) for which you want to capture audit information.
- Specify the name of the **Audit Table**.

---

**NOTE: Specifying the Audit Table.** You can use the audit table that comes supplied with the base package ( **CI\_AUDIT**) to audit multiple tables and fields. All the audit logs are combined in a single table ( **CI\_AUDIT**). However, you can also have a separate audit table for each audited table. Refer to [The Audit Trail File](#) for more information.

---

- Specify the name of the **Audit Program** . The product provides two programs. **com.splwg.base.domain.common.audit.DefaultTableAuditor** is a standard table audit program. In addition **com.splwg.base.domain.common.audit.ModifiedTableAuditor** is supplied as an alternative. This program does not audit inserts or deletes of empty string data.

---

**CAUTION:** By default, none of a table's fields are marked for audit. Even though you have enabled auditing for a table, you must still specify the fields and actions on those fields to be audited (see below).

---

## Specify The Fields and Actions To Be Audited

The system only audits actions (insert, update and delete) made to fields that you want audited.

To specify the fields and actions to be audited:

- Navigate to the [Table - Table Field maintenance](#) page for a table on which you have enabled auditing.
- For each field you want to audit, specify the actions you want to audit by turning on the **Audit Delete**, **Audit Insert** and **Audit Update** switches as appropriate.

---

**NOTE:** You can also turn on the audit switches using the Field grid at the bottom of the [Table maintenance page](#).

---

**CAUTION:** Audit Program Caching! The audit program from the table meta-data is read into a program cache on the application server whenever the date changes or when the server starts. If you implement new auditing on a table, your audit trail does not become effective until this program cache is reloaded. In other words, new audits on tables where the audit program was not previously specified do not become effective until the next day (or the next restart of the application server). However, if you change the fields to be audited for a table where the audit program is already in the cache, your changes are effective immediately.

---

## Audit Queries

There are two queries that can be used to access the audit information.

### Audit Query by User

This transaction is used to view changes made by a user that are stored on a given [Audit Trail File](#).

---

**CAUTION:** The system only audits changes that you've told it to audit. Refer to [The Big Picture Of Audit Trails](#) for more information.

---

Navigate to this page by selecting **Admin > Database > Audit Query By User**.

#### Description of Page

To use this transaction:

- Enter the **User ID** of the user whose changes you wish to view.
- Enter the name of the table on which the audit trail information is stored in **Audit Table**. Refer to [The Audit Trail File](#) for more information about this field.

---

**NOTE: Default Note.** If only one audit table is used to store audit trail information, that table is defaulted.

---

- Specify a date and time range in **Created between** to restrict the records that result from the query.

---

**NOTE: Default Note.** The current date is defaulted.

---

- Click the search button to display all changes recorded on a specific audit table associated with a given user.

Information on this query is initially displayed in reverse chronological order.

The following information is displayed in the grid:

- **Row Creation Date** is the date and time that the change was made.
- **Audited Table Name** contains the name of the table whose contents were changed.
- **Primary Key** is the prime key of the row in the **Audited Table** whose contents were changed.
- **Audited Field Name** is the name of the field that was changed.
- **Audit Action** indicates whether the row action was **Add**, **Change** or **Delete**.
- **Field Value Before Update** contains the content of the field before the change. This column is blank if information was **Added**.
- **Field Value After Update** contains the content of the field after the change. This column is blank if information was **Deleted**.

## Audit Query by Table / Field / Key

This transaction is used to view audited changes made to a given table.

---

**CAUTION:** The system only audits changes that you've told it to audit. Refer to [The Big Picture Of Audit Trails](#) for more information.

---

This transaction can be used in several different ways:

- You can view all audited changes to a table. To do this, enter the **Audited Table Name** and leave the other input fields blank.
- You can view all audited changes to a given row in a table (e.g., all changes made to a given user). To do this, enter the **Audited Table Name** and row's prime key (the row's prime key is entered in the field(s) beneath **Audited Field Name**).
- You can view all audited changes to a given field in a table (e.g., all changes made to all customers' rates). To do this, enter the **Audited Table Name** and the **Audited Field Name**.
- You can view all audited changes to a given field on a specific row. To do this, enter the **Audited Table Name**, the **Audited Field Name**, and row's prime key (the row's prime key is entered in the field(s) beneath **Audited Field Name**).

Navigate to this page by selecting **Admin > Database > Audit Query By Table/Field/Key**.

### Description of Page

To use this transaction:

- Enter the name of the table whose changes you wish to view in **Audited Table Name**.
- If you wish to restrict the audit trail to changes made to a specific field, enter the **Audited Field Name**.
- If you wish to restrict the audit trail to changes made to a given row, enter the row's prime key (the row's prime key is entered in the field(s) beneath **Audited Field Name**). These fields are dynamic based on the **Audited Table Name**.
- Specify a date and time range in **Created between** to restrict the records that result from the query.

---

**NOTE:** The current date is defaulted.

---

- Click the search button to display all changes made to this data.

Information on this query is initially displayed in reverse chronological order by field.

The following information is displayed in the grid:

- **Create Date/Time** is the date / time that the change was made.
- **User Name** is the name of the person who changed the information.
- **Primary Key** is the prime key of the row in the **Audited Table** whose contents were changed.
- **Audited Field Name** is the name of the field that was changed.
- **Audit Action** indicates whether the row action was **Add**, **Change** or **Delete**.
- **Value Before Update** contains the content of the field before the change. This column is blank if information was **Added**.
- **Value After Update** contains the content of the field after the change. This column is blank if information was **Deleted**.

## Bundling

The topics in this section describe the bundling features in the application.

### About Bundling

Bundling is the process of grouping entities for export or import from one environment to another.

For example, you might export a set of business objects and service scripts from a development environment and import them into a QA environment for testing. The group of entities is referred to as a bundle. You create export bundles in the source environment; you create import bundles in the target environment.

Working with bundles involves the following tasks:

- Configuring entities for bundling if they are not preconfigured
- Creating an export bundle, which contains a list of entities to be exported from the source environment
- Creating an import bundle to import those entities to the target environment
- Applying the import bundle, which adds or updates the bundled entities to the target environment

### Sequencing of Objects in a Bundle

Bundle entities are added or updated to the target environment in the sequence defined in the bundle

Typically, the sequence of entities does not matter. However, sequence is important in the following situations:

- Entities that are referenced as foreign keys should be at the top of the sequence, before the entities that reference them. Specify zones last, as they typically contain numerous foreign key references.
- When importing a business object, specify the business object first, then its plug-in scripts, then the algorithms that reference the scripts, and then the algorithm types that reference the algorithms.
- When importing a portal and its zones, specify the portal first and then its zones.
- When importing a multi-query zone, specify the referenced zones first and then the multi-query zone.
- Always specify algorithm types before algorithms.

You can specify the sequence when you define the export bundle or when you import the bundle to the target environment.



## Recursive Key References

Recursive foreign keys result when one object has a foreign key reference to another object that in turn has a foreign key reference to the first object.

For example, a zone has foreign keys to its portals, which have foreign keys to their zones. If the objects you want to bundle have recursive relationships, you must create a 'bundling add' business object that has only the minimal number of elements needed to add the entity. A bundling add business object for a zone contains only the zone code and description, with no references to its portals. In the same way, a bundling add business object for a portal defines only its code and description.

When you apply the bundle, the system initially adds the maintenance object based on the elements defined in the bundling add business object. Before committing the bundle, the system updates the maintenance object with the complete set of elements based on its physical business object.

Note that use of the bundling add BO also benefits records that have optional foreign keys or foreign keys that are part of a child table. That way the person creating the bundle does not have to worry about the sequence of the records. For example, an FK Reference may optionally reference a zone for searching. If a new FK Reference and its search zone are bundled together to copy to another region, the bundling add BO for FK Reference (which doesn't include the Zone) ensures that the FK reference could be added before the zone without getting any validation errors.

## Owner Flags on Bundled Entities

The owner flag of the entities in an import bundle must match the owner flag of the target environment.

If you need to import objects that your source environment does not own, you must replace the owner flag in the import bundle with the owner flag of the target environment.

## Configuring Maintenance Objects for Bundling

All base package meta-data objects are pre-configured to support bundling. All other objects must be manually configured.

If a base package maintenance object is pre-configured for bundling, the **Eligible For Bundling** option will be set to "Y" on the Options tab for the maintenance object.

To configure other objects for bundling, review the configuration tasks below and complete all those that apply:

Configuration Task	Scope of Task
Make maintenance objects eligible for bundling	All objects to be included in the bundle.
Add a foreign key reference	All objects to be included in the bundle.
Create a physical business object	All objects to be included in the bundle.
Create a bundling add business object	Only needed if there are objects with <a href="#">recursive or optional foreign key references</a> .
Add the Current Bundle zone	All objects, if you want the Current Bundle zone to appear on the maintenance object's dashboard. This is not required by the bundling process.
Create a custom Entity Search zone and add it to the Bundle Export portal	All objects, if you want them to be searchable in the Bundle Export portal. This is not required by the bundling process.

## Making Maintenance Objects Eligible for Bundling

The "Eligible For Bundling" maintenance object option must be set to "Y" for all bundled objects.

To make maintenance objects eligible for bundling:

1. Go to the [Maintenance Object](#) page and search for the maintenance object.

2. On the Options tab, add a new option with the type **Eligible For Bundling**.
3. Set the value to "Y" and click **Save**.

## Adding a Foreign Key Reference

Each maintenance object in a bundle must have a foreign key reference. Bundling zones use the foreign key reference to display the standard information string for the maintenance object.

To add a foreign key reference to the maintenance object:

1. Navigate to [FK Reference](#) and set up a foreign key reference for the primary table of the maintenance object.
2. Navigate to [Maintenance Object](#) and search for the maintenance object.
3. On the **Option** tab, add a new option with the type **Foreign Key Reference**. The value is the name of the foreign key reference you just created.

## Creating a Physical Business Object

Each maintenance object in a bundle must have a physical business object. The physical business object's schema represents the complete physical structure of the maintenance object, and includes elements for all fields in the maintenance object's tables. The bundling process uses this schema to generate the XML for the import bundle.

To create a physical business object for the maintenance object:

1. Navigate to [Business Object](#) and specify the maintenance object.
2. Click **Generate** in the **BO Schema** dashboard zone to generate a schema that looks like the physical structure of the maintenance object.
3. Save the physical business object.
4. Navigate to [Maintenance Object](#) and search for the maintenance object.
5. On the **Option** tab, add a new option with the type **Physical Business Object**. The value is the name of the physical business you just created.

## Creating a Bundling Add Business Object

If the objects to be bundled have recursive foreign key references, optional foreign key references or child tables that include foreign key references, create a bundling add business object to avoid problems with referential integrity.

To create a bundling add business object:

1. Navigate to [Business Object](#) and specify the maintenance object.
2. Click **Generate** in the **BO Schema** dashboard zone to generate a schema that looks like the physical structure of the maintenance object.
3. Remove all child tables and all elements that are not required.
4. Save the business object.
5. Navigate to [Maintenance Object](#) and search for the maintenance object you want to bundle.
6. On the **Option** tab, add a new option with the type **Bundling Add BO**. The value is the name of the bundling add business object you just created.

## Adding the Current Bundle Zone

If you want the Current Bundle zone to appear on the maintenance object's dashboard, you must add the Current Bundle zone as a context-sensitive zone for the maintenance object.

To add the Current Bundle zone to the maintenance object:

1. Navigate to [Context Sensitive Zone](#) and search for the navigation key for the maintenance object.
2. Add the Current Bundle zone F1-BNDLCTXT, to that navigation key.

## Adding a Customized Entity Search Query Zone to the Bundle Export Portal

If you want the maintenance object to be searchable in the Bundle Export portal, you must first create an entity-specific query zone to search for the maintenance object. Then you must create a customized entity search zone that references this new query zone. Finally, you must add the customized entity search zone to the Bundle Export portal.

To make the maintenance object searchable:

1. Create an entity-specific query zone to search for the maintenance object:
  - a) Navigate to [Zone](#) and search for one of the base query zones, such as the Algorithm Search zone F1-BNALGS.
  - b) Click the **Duplicate** button in the page actions toolbar.
  - c) Enter a name for the new zone.
  - d) Click **Save**.
  - e) Locate the **User Filter** parameter in the parameter list. Add SQL to search for the maintenance object(s) you want to appear in the zone.
  - f) Save the query zone.
2. Create a customized entity search zone:

This step only needs to be done once. If you already have a customized search zone in the Bundle Export portal go to step 3

  - a) Navigate to [Zone](#) and search for the F1-BNDLENTQ Entity Search zone.
  - b) Duplicate this zone (as described above).
  - c) Remove any references to base query zones.
3. Add the new entity-specific query zone to the customized entity search zone:
  - a) Locate the customized entity search zone for your Bundle Export portal. This is the zone created in Step 2.
  - b) Locate the Query Zone parameter in the parameter list. Add the name of the query zone you created in Step 1.
  - c) Save the entity search zone.
4. Add the customized entity search zone to the Bundle Export portal:

This step needs to be done only once.

  - a) Navigate to [Portal](#) and search for the Bundle Export portal, F1BNDLEM.
  - b) In the zone list, add the entity search zone you created in Step 2. (Add the new zone after the base entity search zone).
  - c) Save the portal.

## Working with Bundles

Use the Bundle Export portal to create an export bundle. The export bundle contains a list of entities to be exported from the source environment. When you are ready to import the objects, use the Bundle Import portal to import the objects to the target environment.

### Creating Export Bundles

An export bundle contains a list of entities that can be imported into another environment.

To create an export bundle:

1. Log on to the source environment from which objects will be exported.
2. Select **Admin > Implementation Tools > Bundle Export > Add**.
3. Complete the fields in the Main section to define the bundle's basic properties.

---

**NOTE:** You can use the Entities section to add bundle entities now, or save the bundle and then add entities as described in step 5.

---

4. Click **Save** to exit the Edit dialog. The export bundle status is set to Pending.
5. While an export bundle is in Pending state, use any of the following methods to add entities to the bundle:
  - a) Use the **Entity Search** zone on the Bundle Export portal to search for entities and add them to the bundle. If an entity is already in the bundle, you can remove it.
  - b) To import entities from a .CSV file, click **Edit** on the Bundle Export portal, and then click **CSV File to Upload**. Specify the file name and location of the .CSV file containing the list of entities. Click **Submit** to upload the file, and then click **Save** to save the changes.
  - c) Use the **Current Bundle** zone in the dashboard of the entity you want to add. (All entities that are configured to support bundling display a Current Bundle zone). This zone displays a list of all pending export bundles to which you can add the entity.
  - d) When you check an entity into revision control, specify the export bundle on the **Revision Info** dialog.
6. When you have added all entities, click **Bundle** in the Bundle Actions zone on the Bundle Export portal. The export bundle state is set to Bundled and the Bundle Details zone displays the XML representation of every entity in the bundle.

---

**NOTE:** The owner flags of the entities in the bundle must match the owner flag of the bundle itself. If the owner flags do not match, the system displays a warning message. Click **OK** to continue or **Cancel** to abort the bundle. If you click OK, you will need to resolve the owner flag discrepancy before you import the bundle to the target environment.

---

7. Copy the XML from the **Bundle Detail** zone to the clipboard (or to a text file). You can now create an import bundle and apply it to the target environment.

---

**NOTE:** If you need to make additional changes to the bundle, you must change the bundle state by selecting the **Back to Pending** button in the **Bundle Actions** zone.

---

## Creating and Applying Import Bundles

Import bundles define a group of entities to be added or updated in the target environment.

Before you create an import bundle, you must have already created an export bundle, added entities, and set the bundle's state to **Bundled**.

To create an import bundle and apply it to the target environment:

1. If you have not already copied the XML from the export bundle, do so now:
  - a) Select **Admin > Implementation Tools > Bundle Export** and search for the bundle.
  - b) Copy the XML from the **Bundle Detail** zone to the clipboard (or to a text file).
2. Log on to the target environment.
3. Select **Admin > Implementation Tools > Bundle Import > Add**.
4. In the **Bundle Actions** zone, click **Edit XML**.
5. Paste the contents of the clipboard (or text file if you created one) into the **Bundle Detail** zone.
6. Make any necessary changes to the XML and click **Save**. The status of the import bundle is set to **Pending**.

---

**NOTE:** Use caution when editing the XML to avoid validation errors.

---

7. To remove entities from the import bundle or change their sequence, click **Edit**. Enter your changes and click **Save** to exit the Edit dialog.
8. When you are ready to apply the bundle, click **Apply**. The import bundle state is set to **Applied** and the entities are added or updated in the target environment.

## Editing Export Bundles

You can add or remove entities from an export bundle when it is in **Pending** state. You can also change the sequence of entities.

To edit to an export bundle that has already been bundled, you must change the bundle state by selecting the **Back to Pending** button on the Bundle Export portal.

To edit a pending export bundle:

1. Open the bundle in edit mode.
2. Click **Edit** on the Export Bundle portal.
3. Make any necessary changes on the edit dialog and then click **Save**.

## Editing Import Bundles

You can remove entities from an import when it is in **Pending** state. You can also change the sequence of entities and edit the generated XML.

To edit a pending import bundle:

1. Open the bundle in edit mode.
2. To edit the XML snapshot, click **Edit XML**. Edit the XML code as needed, then click **Save**.

---

**NOTE:** Use caution when editing the XML to avoid validation errors.

---

3. To remove entities or change their sequence, click **Edit**. Make any necessary changes and click **Save**.

## Revision Control

The topics in this section describe the revision control features in the application.

### About Revision Control

Revision control is a tool provided for the development phase of a project to allow a user to check out an object that is being worked on. In addition, it captures the version of the maintenance object when users check in an update, maintaining a history of the changes to the object.

If revision control is enabled for an object you must check out the object to change it. While the object is checked out no one else can work on it. You can revert all changes made since checking out an object, reinstate an older version of an object, recover a deleted object, and force a check in of an object if someone else has it checked out.

---

**NOTE:** Revision control does not keep your work separate from the environment. Because the metadata for maintenance objects is in the central database, any changes you make to an object while it is checked out will be visible to others and may impact their work.

---

Many of the maintenance objects used as configuration tools are already configured for revision control, but it is turned off by default. For example, business objects, algorithms, data areas, UI maps, and scripts are pre-configured for revision control.

### Turning On Revision Control

Revision control is turned off by default for maintenance objects that are configured for revision control.

To turn on revision control:

1. Add the base package **Checked Out** zone to the Dashboard portal.
  - a) Navigate to [Portal](#).
  - b) Search for the portal CI\_DASHBOARD.
  - c) In the zone list for the **Dashboard** portal, add the zone F1-USRCHKOUT.
2. Set up application security.

For users to have access to revision control, they must belong to a user group that has access to the application service F1-OBJREVBOAS.
3. Add the revision control algorithm to the maintenance object that you want to have revision control.

This step must be repeated for each maintenance object that you want to have revision control.

  - a) Go to the [Maintenance Object](#) page and search for the maintenance object that you want to have revision control.
  - b) On the **Algorithms** tab of the maintenance object, add the revision control algorithm F1-REVCTL.

## Configuring Maintenance Objects for Revision Control

Most configuration tool maintenance objects are pre-configured for revision control. You can configure other maintenance objects for revision control, as well.

To configure other objects for revision control:

### 1. Create a physical business object for the maintenance object.

A physical business object is one that has a schema with elements for all of the fields for the tables in the maintenance object. Follow these steps to create a physical business object:

- a) Navigate to [Business Object](#) and specify the maintenance object.
- b) Use the **BO Schema** dashboard zone to generate a schema that looks like the physical structure of the maintenance object.
- c) Save the physical business object.
- d) Go to the [Maintenance Object](#) page and search for the maintenance object for which you want to enable revision control.
- e) On the **Options** tab of the maintenance object add a new option with the type **Physical Business Object**. The value is the name of the physical business object that you just created.

### 2. Add a foreign key reference to the maintenance object.

The revision control zones will display the standard information string for the object based on the foreign key reference. Follow these steps to create a foreign key reference:

- a) Navigate to [FK Reference](#) and set up a foreign key reference for the primary table of the maintenance object.
- b) Go to the [Maintenance Object](#) page and search for the maintenance object.
- c) On the **Options** tab of the maintenance object, add a new option with the type **Foreign Key Reference**. The value is the name of the foreign key reference that you just created.

### 3. Add the **Revision Control** zone to the maintenance object.

- a) Navigate to [Context Sensitive Zone](#) and search for the navigation key for the maintenance object.
- b) Add the Revision Control zone, F1-OBJREVCTL, to that navigation key.

### 4. Add the revision control algorithm to the maintenance object.

- a) Go to the [Maintenance Object](#) page and search for the maintenance object that you want to have revision control.
- b) On the **Algorithms** tab of the maintenance object, add the revision control algorithm F1-REVCTL.

## Working with the Revision Control Zones

You use two zones in the dashboard to work with revision controlled objects when revision control is turned on.

The **Revision Control** zone gives you several options for managing the revision of the currently displayed object. This zone also shows when the object was last revised and by whom. This information is linked to the **Revision Control Search** portal which lists all of the versions of the object.

Using the Revision Control zone you can:

- Check out an object in order to change it.
- Check in an object so others will be able to work on it.
- Revert the object back to where it was at the last checkout.
- Force a check in of an object that is checked out by someone else. You need special access rights to force a check in.

- Delete an object.

The **Checked Out** zone lists all of the objects that you currently have checked out. Clicking on an object listed in this zone will take you to the page for that object. The zone is collapsed if you have no objects checked out.

See [Revision Control Search](#) for more information about Check In, Force Check In, and Check Out one or more records simultaneously.

## Checking Out an Object

You must check out a revision controlled object in order to change it.

An object must have revision control turned on before you can check it out.

---

**NOTE:** When you first create or update an object a dialog box informs you that the object is under revision control. You can select **OK** to check out the object and save your changes, or **Cancel** to stop the update.

---

1. Go to the object that you want to work on.
2. Select **Check Out** in the **Revision Control** dashboard zone.

## Checking In an Object

You must check in a revision controlled object in order to create a new version of it. Checking in an object also allows others to check it out.

1. Select a link in the **Checked Out** dashboard zone to go to the object that you want to check in.
2. Select **Check In** in the **Revision Control** dashboard zone.
3. Provide details about the version:
  - In the **External References** field state the bug number, enhancement number, or a reason for the revision.
  - In the **Detailed Description** field provide additional details regarding the revision.
  - In the **Keep Checked Out** box specify if you want to keep the object checked out. If you keep the object checked out then your revision is a new version that you can restore later.
  - In the **Add To Bundle** box specify if the object belongs to a bundle.
4. Select **OK** to check in the object.

## Reverting Changes

Reverting changes will undo any changes you made since you checked out an object.

To revert changes:

1. Go to the object that you want to revert.
2. Select **Revert** in the **Revision Control** dashboard zone.
3. In the confirmation dialog box select **OK** to confirm the action or **Cancel** to return to the object page.

Once reverted, the object can be checked out by another user.

## Forcing a Check In or Restore

You can force a check in if an object is checked out by another user and that person is not available to check it in.



You must have proper access rights to force a check in or restore.

To force a check in or restore:

1. Go to the object that is checked out by another user.
2. Select **Force Check In** or **Force Restore** in the Revision Control zone.

The **Force Check In** option is the same as a regular check in. The **Force Restore** option checks in the object and restores it to the previously checked in version.

## Deleting an Object

If revision control is turned on for an object, you must use the **Revision Control** zone to delete it.

The object must be checked in before it can be deleted.

To delete a revision controlled object:

1. Go to the object that you want to delete.
2. Select **Delete** in the **Revision Control** zone.
3. Provide details regarding the deletion.
4. Select **OK** to delete the object.

The system creates a revision record before the object is deleted so that the deleted object can be restored.

## Restoring an Object

You can restore an older version of either a current object or a deleted object.

An object must be checked in before an older version can be restored.

To restore an object:

1. Go to the **Revision History** portal for the object.  
If the object was deleted you must search for it by going to **Admin > Implementation Tools > Revision Control**.
2. Select the desired entity by clicking the hyperlink in the **Details** column.
3. Locate the row in the version history that has the version that you want to restore and click **Restore**.
4. In the confirmation dialog box select **OK** to confirm the action or **Cancel** to return to the object page.

## Working with the Revision Control Portal

The **Revision Control** portal lists information about each version of a revision controlled object.

You can navigate to the **Revision Control** portal from either a link in the **Revision Control** dashboard zone or by going to **Revision Control** portal through **Admin**.

If you want to find the Revision History entry for an earlier version or deleted object, you must search for the object using the **Revision Control Search** portal. Once you select the desired entry, you can restore a previous version of the object clicking **Restore** in the row for the version that you want to restore. You can also see the details of each version by clicking the broadcast icon for that version.

See [Working with Revision Control Zones](#) for more information about tasks that can be performed through Revision Control.

## Revision Control Search

The **Revision Control Search** portal allows users to search for entities that have a revision history. The **Search By** dropdown provides additional functionality so that users can search for revisions that are associated to theirs or other's user ID. Users can also **Check In**, **Force Check In**, or **Check Out** one or more entities through this portal.

### Zone Options

- **Revision History Search** allows the user to query for revised entities based on a combination of criteria.
  - In the **User ID** field, enter the user ID that is associated with a revision.
  - In the **External Reference** field, enter an ID from an external system and is associated with a revision.
  - In the **Maintenance Object** dropdown menu, select the Maintenance Object that is associated with a revision. The options in this list are populated by the Maintenance Objects that are active to track revision.
  - In the **Key 1**, **Key 2**, **Key 3**, **Key 4**, **Key 5** fields, enter the primary identifier(s) for the revised entity. Typically, the entity only requires a single key, but some entities require more than one (for example, Oracle Utilities Customer Care and Billing SA Type require CIS Division and SA Type).
  - In the **Status** dropdown menu, select the entity status for your search.
- **Check In** allows the user to search for entities currently checked out to the logged in user ID and a combination of criteria. Once the search results are returned, the user has the option to select one or more entities and check them in.
  - In the **Maintenance Object** dropdown menu, select the Maintenance Object that is associated with a revision. The options in this list are populated by the Maintenance Objects that are active to track revision.
  - In the **Key** field, enter the primary identifier(s) for the revised entity.
- **Force Check In** allows the user to search for entities that are currently checked out by other user IDs (excluding the logged in user ID) based on a combination of criteria. Once the search results are returned, the user has the option to select one or more entities and check them in.
  - In the **Checked Out By User** field, enter the user ID that has the entity in a Checked Out status.
  - In the **Maintenance Object** dropdown menu, select the Maintenance Object that is associated with a revision. The options in this list are populated by the Maintenance Objects that are active to track revision.
  - In the **Key** field, enter the primary identifier(s) for the revised entity.
- **Check Out** allows the user to search for entities currently checked in user ID and a combination of criteria. Once the search results are returned, the user has the option to select one or more entities and check them out.
  - In the **Maintenance Object** dropdown menu, select the Maintenance Object that is associated with a revision. The options in this list are populated by the Maintenance Objects that are active to track revision.
  - In the **Key** field, enter the primary identifier(s) for the revised entity.

Please see [Working with Revision Control Zones](#) for more information about working with individual entities.

## Information Lifecycle Management

Information Lifecycle Management (ILM) is designed to address data management issues, with a combination of processes and policies so that the appropriate solution can be applied to each phase of the data's lifecycle.

Data lifecycle typically refers to the fact that the most recent data is active in the system. As time progresses, the same data becomes old and unused. Older data becomes overhead to the application not only in terms of storage, but also in terms of performance. This older data's impact can be reduced by using advanced compression techniques, and can be put into slower and cheaper storage media. Depending on how often it's accessed, it can be removed from the system to make an

overall savings of cost and performance. The target tables for ILM are transactional tables that have the potential to grow and become voluminous over time.

## The Approach to Implementing Information Lifecycle Management

This section describes the product approach to implementing ILM for its maintenance objects (MOs).

---

**NOTE:** The term archiving is used to cover any of the possible steps an implementation may take in their data management strategy, including compression, moving to cheaper storage, and removing the data altogether.

---

Age is the starting point of the ILM product implementation for some of its high volume data. In general "old" records are considered eligible to be archived. In the product solution, maintenance objects (MOs) that are enabled for ILM have an ILM Date on the primary table and the date is typically set to the record's creation date. (An MO may have special business rules for setting this date, in which case, a different date may be used to set the initial ILM Date). For implementations that want to use ILM to manage the records in the MO, the ILM date is used for defining partitions for the primary table.

There are cases where a record's age is not the only factor in determining whether or not it is eligible to be archived. There may be some MOs where an old record is still 'in progress' or 'active' and should not be archived. There may be other MOs where certain records should never be archived. To evaluate archive eligibility using information other than the ILM Date, the ILM enabled MOs include an ILM Archive switch that is used to explicitly mark records that have been evaluated and should be archived. This allows DBAs to monitor partitions based on age and the value of this switch to evaluate data that may be ready to be archived.

Evaluating records to determine their archive eligibility should still occur on "old" records. The expectation is that a large percentage of the old records will be eligible for archiving. The small number that may be ineligible could be updated with a more recent ILM date. This may cause the records to move into a different partition and can delay any further evaluation of those records until more time has passed.

For each MO enabled for ILM, the product provides a batch process to review "old" records and an ILM eligibility algorithm that contains business logic to evaluate the record and mark it eligible for archiving or not. The following sections provide more information about the batch process and algorithm functionality.

### Batch Processes

There are two main types of batch processes that manage data for ILM in the application: ILM Crawler Initiator and individual ILM Crawlers (one for each MO that is configured for ILM).

- **ILM Crawler Initiator: (F1-ILMIN)** - The ILM Crawler Initiator is a *driver* batch process that starts the individual ILM Crawler batch control as defined by the MO's options.

**Restartable:** In case of server failure, the ILM Crawler Initiator process can be restarted, which will also restart the ILM Crawler processes.

- **ILM Crawler:** Each maintenance object that is configured for ILM defines an ILM Crawler. These are *child* batch processes that can be started either by the ILM Crawler Initiator or by a standalone batch submission.

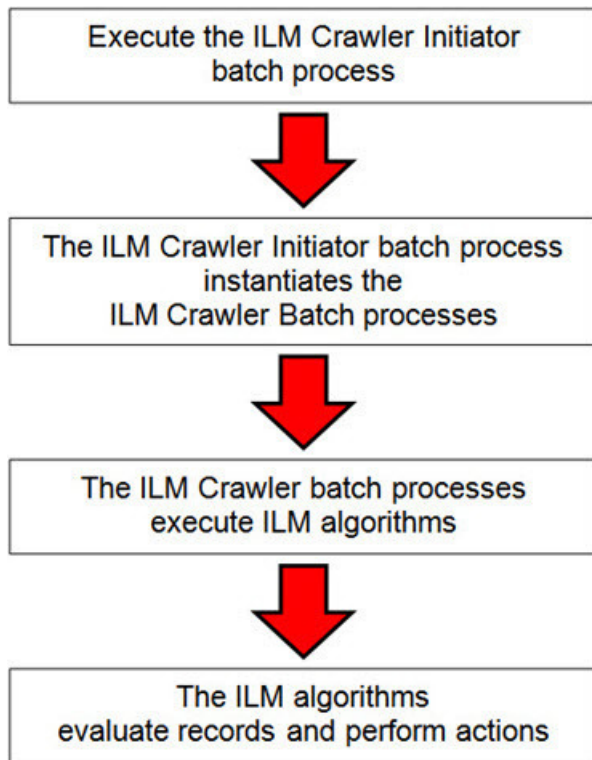

The ILM Crawler batch process selects records whose retention period has elapsed and invokes the MO's ILM eligibility algorithm to determine if the record is ready to be archived or not. The ILM eligibility algorithm is responsible for setting the record's ILM archive switch to 'Y' and updating the ILM date, if necessary.

The retention period defines the period that records are considered active. It spans the system date and cutoff date (calculated as system date - retention days).

The retention days of an MO is derived as follows:

- If the ILM Retention Days MO option is defined, that is used.
- Otherwise, the Default Retention Days from the ILM Master Configuration record is used.

An error is issued if no retention period is found.

The crawler calculates the cutoff date and selects all records whose ILM archive switch is 'N' and whose ILM date is prior to the cutoff date. Each record returned is subject to ILM eligibility.

If the Override Cutoff Date parameter is supplied, it will be used instead of the calculated cutoff date. An error is issued if the override cutoff date is later than the calculated cutoff date. This parameter is useful if an object has many years of historic data eligible for archiving. Setting this parameter allows for widening the retention period and therefore limiting the process to a shorter period for initial processing

---

**NOTE:** ILM Crawler batch processes are designed not to interfere with current online or batch processing. Because of this, these batch processes can run throughout the day.

---

**NOTE:** Before passing the cut-off date to the algorithm, the ILM crawler ensures that the number of days calculated (System Date – override cut-off date) is more than the retention period specified in the MO option or the Master Configuration. If the number of days calculated is **less than** the retention period specified on the MO option or the Master Configuration, then it throws an error.

---

## Eligibility Algorithm

Algorithms are triggered by the ILM batch crawler for the maintenance object. The key responsibility of the ILM algorithm is to determine whether a record can be marked as ready to be archived or not. If a record is determined to be ready for archive, the algorithm should set the ILM Archive switch to Y. If not, the algorithm leaves the switch set to N and may decide to update the ILM Date to something more recent (like the System Date) to ensure that the record does not get evaluated again until the future.

This algorithm is plugged into the [Maintenance Object — Algorithm](#) collection.

Oracle Utilities Application Framework provides the algorithm **ILM Eligibility Based on Status (F1-ILMELIG)** to support the ILM batch crawler. Refer to the algorithm type description for details about how this algorithm works. If a maintenance object has special business rules that are evaluated to determine the eligibility for ILM, a custom algorithm can be created and applied by the implementation team.

## Enabling ILM for Supported Maintenance Objects

In order to enable ILM for one or more maintenance objects, several steps are needed in both the configuration and in the database. This section describes some configuration enabled by default and some steps that must be taken in order to fully implement ILM.

There is some configuration enabled by default, but it won't be used unless ILM is fully configured. Each maintenance object that the product has configured for ILM has the following provided out of the box:

- **Special Table Columns:** Maintenance objects that support ILM include two specific columns: ILM Archive Switch (**ILM\_ARCH\_SW**) and ILM Date (**ILM\_DT**).
- **Crawler Batch Process:** A "crawler" batch process is provided for each maintenance object that supports ILM and it is plugged into the MO as an option. Refer to [Batch Processes](#) for more information.
- **ILM Eligibility Algorithm:** Each maintenance object that is configured for ILM defines an [eligibility algorithm](#) that executes the logic to set the ILM Archive switch appropriately. This is plugged in to the MO algorithm collection.

If an implementation decides to implement ILM, there are steps that need to be followed, which are highlighted below.

### Create the Master Configuration Record

The first step when enabling ILM is to create the **ILM Configuration**[master configuration](#) record.

The master configuration for ILM Configuration defines global parameters for all ILM eligible maintenance objects. For example, the Default Retention Period. In addition, your product may implement additional configuration. Refer to the embedded help for specific details about the information supported for your product's ILM configuration.

In addition, the user interface for this master configuration record displays summary information about all the maintenance objects that are configured to use ILM.

### Confirm the Maintenance Objects to Enable

In viewing the list of maintenance objects that support ILM in the ILM master configuration page, your implementation may choose to enable ILM for only a subset of the supported maintenance objects. For example, some of the maintenance objects may not be relevant for your implementation. Or perhaps, the functionality provided by the maintenance object is used, but your implementation does not expect a high volume of data.

For each maintenance object that your implementation has confirmed for ILM, the following steps should be taken:

- Determine if the maintenance object should have a different default retention days than the system wide value defined on the master configuration. If so, use the MO option **ILM Retention Period in Days** to enter an override option for this maintenance object.

- Review the functionality of the ILM Eligibility algorithm provided by the product for this maintenance object. Each algorithm may support additional configuration based on business needs. If your organization has special business rules that aren't satisfied by the algorithm provided by the product, a custom algorithm may be provided to override the base algorithm.

For each maintenance object that your implementation does not want to enable for ILM, inactivate the eligibility algorithm. This will ensure that the ILM Crawler Initiator background process does not submit the crawler batch job for the maintenance object in question.

- Go to the [Maintenance Object - Algorithm](#) tab for each maintenance object and take note of the **ILM Eligibility** algorithm code.
- Go to the [Maintenance Object - Option](#) tab for the same maintenance object and add an option with an option type of **Inactivate Algorithm** and the value set to the ILM eligibility algorithm noted in the previous step.

## Database Administrator Tasks

In order to implement ILM for each of the maintenance objects determined above, your database administrator must perform several steps in the database for the tables related to each MO. The following points are a summary of those steps. More detail can be found in the Information Lifecycle Management section of your product's *Database Administration Guide*.

- **Initializing ILM Date:** Your existing tables that are enabled for ILM may not have the ILM Date and ILM Archive switch initialized on all existing records. When choosing to enable ILM, a first step is to initialize this data based on recommendations provided in the DBA guide.
- **Referential Integrity:** The recommended partitioning strategy for child tables in a maintenance object is referential partitioning. In order to implement this, database referential integrity features must be enabled.
- **Partitioning:** This provides a way in which the data can segregate into multiple table partitions and will help in better management of the lifecycle of the data.

## Schedule the ILM Crawler Initiator

The final step of enabling the system for ILM is to schedule the ILM crawler initiator **F1-ILMIN** regularly based on your implementation's need. It is recommended to only schedule this batch process once all the required database activities are complete.

## Ongoing ILM Tasks

For an environment where ILM is enabled, besides the periodic execution of the ILM crawler batch processes to review and mark records, your database administrator has ongoing tasks.

The DBA reviews and maintains partitions and identifies partitions that may warrant some type of archiving step. The Information Lifecycle Management section of your product's *Database Administration Guide* provides more information for your DBA.

## Archived Foreign Keys

If your DBA chooses to archive a partition, there may be records in the system that refer to one of the archived records as a foreign key.

When a user attempts to view a record using a hyperlink or drill down mechanism, if the implementation of the navigation uses FK Reference functionality, the system will first check if the record exists. If not, it will display a message to the user indicating that the record has been archived.

# Configuration Tools

This section describes tools to facilitate detailed business configuration. The configuration tools allow you to extend both the front-end user interface as well as create and define specialized back-end services.

## Business Objects

A [maintenance object](#) defines the physical tables that are used to capture all the possible details for an entity in the system. A business object is tool provided to further define business rules for a maintenance object.

This section provides an overview of business objects and describes how to maintain them.

## The Big Picture of Business Objects

The topics in this section describe background topics relevant to business objects.

### What Is A Business Object?

A business object (BO) is a powerful tool used throughout the system. For many maintenance objects, a BO is a key attribute of the record used to define the data it captures, its user interface behavior and its business rules. Some business objects support the definition of a lifecycle, capturing different states that a record may go through, allowing for different business rules to be executed along the way. This type of business object is considered the “identifying” or “governing” business object. We will see later that other types of BOs exist that are different from the “identifying” business object.

The use of business objects allows for extensibility and customization of product delivered maintenance objects. There are many options to adjust the behavior of base delivered business objects. In addition, implementations may introduce their own business objects if the base product delivered objects do not meet their business needs.

---

**NOTE:** Not all maintenance objects in the product support business objects as a “identifying” or “governing” tool. This is the standard going forward for new maintenance objects. However, there are some maintenance objects created before this became a standard.

---

### A Business Object Has a Schema

A business object has elements. The elements are a logical view of fields and columns in one of the maintenance object’s tables. The structure of a business object is defined using an XML schema. The main purpose of the schema is to identify all the elements from the maintenance object that are included in the business object and map them to the corresponding maintenance object fields. Every element in the BO schema must be stored somewhere in the maintenance object. The BO may not define elements that are derived.

When defining elements for the primary table or the language table (for an administrative object) there is no need to define the name of the physical table in the schema. The system infers this information. The following is a snippet of a schema:

```
<schema>
  <migrationPlan mapField="MIGR_PLAN_CD" suppress="true" isPrimeKey="true"/>
  <bo mapField="BUS_OBJ_CD" fkRef="F1-BUSOB"/>
  <customizationOwner mapField="OWNER_FLG" suppress="input"/>
  <version mapField="VERSION" suppress="true"/>
  <description mapField="DESCR"/>
  <longDescription mapField="DESCRLONG"/>
  ...
```

Many maintenance objects have child table collections (e.g., a collection of names for a person, or a collection of persons on an account). Depending on the requirements, the business object may define the full collection such that the user will

maintain the information in a grid. However, the schema also supports “flattening” records in a child table so that they can be treated as if they were singular elements. The following are examples of each:

**Example** of a child table. This is a snippet of the Instructions collection on the migration plan business object. You can see that the list attribute defines the child table and all elements within it map to the appropriate column in that table.

```
<migrationPlanInstruction type="list" mapChild="F1_MIGR_PLAN_INSTR">
  <migrationPlan mapField="MIGR_PLAN_CD" suppress="true"/>
  <sequence mapField="PLAN_INSTR_SEQ" suppress="true"/>
  <instructionSequence mapField="INSTR_SEQ"/>
  <instructionType mapField="INSTR_TYPE_FLG"/>
  <parentInstructionSequence mapField="PARENT_INSTR_SEQ"/>
  <businessObject mapField="BUS_OBJ_CD" fkRef="F1-BOMO"/>
...

```

**Example** of a simple “flattened” field. The business object for Status Reason includes an element called Usage, which maps to a pre-defined characteristic of type **F1-SRUSG**. The “row” defines which child table is being flattened and the attributes of the row in that child that uniquely identify it.

```
<usage mdField="STATUS_RSN_USAGE" mapField="CHAR_VAL">
  <row mapChild="F1_BUS_OBJ_STATUS_RSN_CHAR">
    <CHAR_TYPE_CD is="F1-SRUSG"/>
    <SEQ_NUM is="1"/>
  </row>
</usage>

```

**Example** of a “flattened row”. This business object for Account includes a single row for the Person collection where only the “financially responsible, main” customer is defined. The “accountPerson” attribute defines one field from that row (the Person Id) and includes the ‘flattening’ criteria in the “row” information. In addition, a second field from that same row (“accountRelType”) is defined. Instead of having to repeat the flattening criteria, the “rowRef” attribute identifies the element that includes the flattening.

```
<accountPerson mapField="PER_ID">
  <row mapChild="CI_ACCT_PER">
    <MAIN_CUST_SW is="true"/>
    <FIN_RESP_SW default="true"/>
  </row>
</accountPerson>
<accountRelType mapField="ACCT_REL_TYPE_CD" rowRef="accountPerson" dataType="string"/>

```

**Example** of a “flattened list”. The business object for Tax Bill Type includes an list of valid algorithms for “bill completion”. The Sequence and the Algorithm are presented in a list. The list element identifies the child table and the ‘rowFilter’ identifies the information about the list that is common.

```
<taxBillCompletion type="list" mapChild="C1_TAX_BILL_TYPE_ALG">
  <rowFilter suppress="true" private="true">
    <TAX_BILL_TYPE_SEVT_FLG is="C1BC"/>
  </rowFilter>
  <sequence mapField="SEQ_NUM"/>
  <algorithm mapField="ALG_CD" fkRef="F1-ALG"/>
</taxBillCompletion>

```

In addition, many maintenance objects support an XML structure field within the entity. These fields may be of data type CLOB or XML. One or more business object elements may be mapped to the MO's XML structure field. These elements may be defined in different logical places in the business object schema based on what makes sense for the business rules. When updating the MO, the system builds a type of XML document that includes all the elements mapped to the XML structure and stores it in one column. The following is an example of elements mapped to an XML column:

```
<filePath mdField="F1_FILE_PATH" mapXML="MST_CONFIG_DATA" required="true"/>
<characterEncoding mdField="F1_CHAR_ENCODING" mapXML="MST_CONFIG_DATA"/>

```

**NOTE:** If the MO's XML structure field is of the data type XML, the database will allow searching for records based on that data, assuming appropriate indexes are defined. If the MO's XML structure field is of the data type CLOB, indexing or joining to elements in this column via an SQL statement is not typically supported. Note that most MOs are currently using the CLOB data type for the XML structure column, if provided.



Some business objects may have child tables that allow data to be stored in an XML structure field. The schema language supports defining elements from those fields in your schema as well.

Besides including information about the physical “mapping” of the element to its appropriate table / field location in the maintenance object, the schema supports additional syntax to provide the ability to define basic validation and data manipulation rules, including:

- Identifying the primary key of the record or the primary key of the a row in a list.
- Identifying which elements are required when adding or changing a record.
- Default values when no data is supplied on an Add.
- For elements that are lookup values, the lookup may be specified to validate that the value of the element is a valid lookup value.
- For elements that are foreign keys to another table, the FK Reference may be specified to validate the data.

The system will check the validity of the data based on the schema definition obviating the need for any special algorithm to check this validation.

In addition, the schema language may include some attributes that are used to auto-render the view of the record on the user interface, such as the **suppress** attribute. Refer to [BO Defines its User Interface](#) for more information.

---

**NOTE:** Refer to [Schema Syntax](#) for the complete list of the XML nodes and attributes available to you when you construct a schema.

---

A business object’s schema may include a subset of the fields and tables defined in the maintenance object. There are two reasons for this:

- The fields or tables may not be applicable to the type of record the business object is governing. For example, a field that is specific to gas may not be included on a Device business object that is specific to electric meters.
- The information is not maintained through the business object, but rather maintained separately. For example, many BO based maintenance objects include a Log table. The records in the log table are typically not included the BO because they are viewed and maintained separately from the business object.

## A Business Object May Define Business Rules

A business object may define business rules that govern the behavior of entities of this type.

- Simple element-level validation is supported by schema attributes. Note that element-level validation is executed before any maintenance object processing. For more sophisticated rules you create **Validation** algorithms and associate them with your business object. BO validation algorithms are only executed after "core validation" held in the MO is passed.
- A **Pre-Processing** algorithm may be used to "massage" a business object's elements prior to any maintenance object processing. For example, although simple element-level defaulting is supported by schema attributes. you may use this type of algorithm to default element values that are more sophisticated.
- A **Post-Processing** algorithm may be used to perform additional steps such as creating a To Do Entry or add a log record as part of the business object logical transaction. These plug-ins are executed after all the validation rules are executed.
- An **Audit** algorithm may be used to audit changes made to entities of this type. Any time a business entity is added, changed or deleted, the system detects and summarizes the list of changes that took place in that transaction and hands it over to **Audit** plug-ins associated with the business object. These plug-ins are executed after all the post-processing rules are executed. It is the responsibility of such algorithms to log the changes if and where appropriate, for example as a log entry or an entry in an audit trail table or an entry in the [business event log](#)

By default all elements of the business object are subject to auditing. You can however mark certain elements to be excluded from the auditing process using the **noAudit** schema attribute. Marking an element as not auditable will prevent it from ever appearing as a changed element in the business object's audit plug-in spot. In addition, if the only elements

that changed in a BO are ones marked to not audit, the audit algorithm is not even called. Refer to [Schema Syntax](#) for more information on this attribute.

Refer to [Business Object - Algorithms](#) for more information on the various types of algorithms.

The system applies business object rules (schema based and algorithms) whenever a business object instance is added, changed or deleted. This is only possible when the call is made via the maintenance object service. For example, when made via business object interaction ("invoke BO"), the MO's maintenance page or inbound web services that reference the BO. In addition the system must be able to [determine the identifying business object](#) associated with the actual object being processed. If the business object cannot be determined for a maintenance object instance business object rules are not applied.

---

**NOTE:**

**Pre-Processing is special.** The pre-processing algorithm plug-in spot is unique in that it only applies during a BO interaction. It is executed prior to any maintenance object processing. It means that when performing add, change or delete via the maintenance object service, the pre-processing plug-in is not executed.

---

**CAUTION:** Direct entity updates bypass business rules! As mentioned above, it is the maintenance object service layer that applies business object rules. Processes that directly update entities not via the maintenance object service bypass any business object rules you may have configured.

---

**FASTPATH:** Refer to [BO Algorithm Execution Order](#) for a summary of when these algorithms are executed with respect to lifecycle algorithms.

---

The plug-in spots described above are available for all business objects and they are executed by the system when processing adds or updates to the business object. It is possible for a specific maintenance object to define a special plug-in spot for business objects of that MO. When this happens, the maintenance object identifies the special algorithm entity lookup value as an [MO option: Valid BO System Event](#), causing the BO Algorithm collection to include that system event in its list.

## A Business Object Defines its User Interface

One of the responsibilities of an identifying business object is to define its user interface rules for viewing and maintenance of its record. The standard implementation for maintaining a business object is that a [maintenance portal](#) is used to display a record. This portal includes a "map" zone that displays the information about the business object. To add or make changes to a record, the user clicks a button that launches a maintenance BPA script which displays a maintenance "map".

The display and maintenance "maps" are driven by the business object. The BO may define a full [UI map](#) where all the information is displayed based on the map's HTML. Note that for a child BO, the maps may be [inherited](#) by a parent BO (or any BO "up the chain").

The standard going forward is to use schema definition and UI Hints to define user interface behavior so that a full UI map is not needed but rather the HTML is derived. The schema language includes some basic display attributes such as **label** and **suppress**. UI hints provide many additional tags and elements that allow dynamic generation of formatted UI Maps. For more complex behavior in the user interface, for example where javascript is needed, UI map fragments may be defined within the schema via UI hints. In this way only complex UI behavior warrants small snippets of javascript and HTML. However the rendering of standard fields can be dynamically rendered. UI map fragments also allow for derived fields to be included in the user interface.

A business object schema may include [data areas](#) for segments of its schema definition to allow for reusable components. In this case the data area would also include schema attributes and UI hints for the elements that it is including.

---

**NOTE:** Refer to [UI Hint Syntax](#) for detailed information about the supported syntax.

---

As mentioned in [Business Object Inheritance](#), schemas are not inherited on a child business object. As such, when using UI hints for automatic UI rendering, the child BO must define the full schema with all the definitions. A good business object hierarchy will be designed for reuse meaning that the child BO will include the parent BO schema or alternatively, the BO schemas will include reusable data areas.

## Invoking A Business Object

We have talked about defining a business object. This section describes how business objects are used throughout the system to view, add and update records.

- Various parameters for zones that are used to display data in the system include support for retrieving data by referencing a business object. The zone code will "invoke" the BO, meaning that the record will be retrieved using the referenced BO.
- The system's [scripting](#) language includes a step type to "invoke BO". This allows for BPA scripts, service scripts and plug-in scripts to retrieve information and add or update records using BO interaction.
- [Inbound web services](#) may reference a business object in its operations collection. This allows external systems to add or update records in our product via web service interaction.

Often when configuring a zone or writing a script, the BO to use in the "invoke BO" statement should be the identifying BO of the record. As such, often the script will include steps prior to the "invoke BO" step to "[determine the identifying BO of the record](#)" and once the identifying BO is found, the script step will invoke that BO. Note that zones and inbound web services reference a BO directly. In each case, if the BO to use should be dynamic, then the zone / inbound web service should reference a service script that can perform the steps to identify the BO and then invoke that BO.

It should be noted however that the BO used in an "invoke BO" statement (or referenced in an inbound web service) **does not have to match** the identifying BO for the record. Here are some examples of where this may be true:

- A script may only require a subset of elements for a record and not the entire record. In this case, it is better for performance purposes to define a special BO (sometimes called a "lite" BO or a "mini" BO) that only defines the needed elements. When the system retrieves the data, it will only access the tables that are included in the BO's schema definition. In addition, if there are no elements that map to an XML structure field, the system will skip any parsing of that column. Similarly, if a script is **updating** a subset of elements on a record, it may be beneficial to use a "mini" BO to do the updates.

---

**NOTE:** Please note the following with respect to using a mini BO. This BO is only used for its schema. This type of BO would not define algorithms or a lifecycle. Because the BO is special, it often should not be able to be used as any record's identifying BO. To control that, these BOs are often configured to not allow new instances. Refer to [Determine the Identifying BO](#) for more information.

---

- The maintenance object to be added or updated in a script may not support business objects as "identifying BOs". For example, Batch Control maintenance object does not have an identifying BO. However, scripts may still wish to retrieve data (or make updates) to these types of records. An easy way to achieve that goal is to define a business object and use "invoke BO" to access the data.

---

**NOTE:** Not all maintenance objects support being maintained through a business object interaction. This is true in a small number of older objects where the underlying maintenance service includes additional functionality besides simply updating the database tables. These maintenance objects are identified via the [MO option](#) **BO Maintenance**, set to **N**.

---

- Some functionality may be trying to add or update records for a maintenance object in a 'physical' manner and do not want or need to use the object's identifying BO. Or the MO may not have an identifying BO. For example, revision control takes a snapshot of a record for audit purpose and to be able to restore a previous version. In this case, the system wants to capture a full "physical" view of the record. To do this, a special "physical" BO may be created that includes all (or most of) the columns and the child tables.

---

**NOTE:** Like the mini BO, the physical BO would not define algorithms or a lifecycle and should not be able to be used as any record's identifying BO. To control that, these BOs are often configured to not allow new instances. Refer to [Determine the Identifying BO](#) for more information.

---

**NOTE:** To reiterate, the BO referenced in the "invoke BO" statement or referenced in an inbound web service does not have to match the identifying BO and does not have to be configured to "allow new instances".

---

## Determine the Identifying BO

As mentioned in other topics, the identifying BO is the business object that governs the business rules for a record. This is the business object that the record will be validated against when any additions or changes are made to the record as long as updates are made via the maintenance service. This includes using "invoke BO" for add or update, using inbound web service interaction and for access to the maintenance page service (via an old style fixed page or via a business service).

How does the system determine the identifying BO? An algorithm plugged into the maintenance object (the **Determine BO** plug-in spot) is responsible for this. If the maintenance object is not configured with an algorithm for this plug-in spot, or no BO is found by the algorithm, no BO business rules are applied.

Most maintenance objects in the system capture the record's identifying BO directly on the record. However, it is possible to define the identifying BO somewhere else. For example, there may be some maintenance objects that are master or transaction objects with an associated "type" object where the identifying BO is defined on its "type" object. Note that the standard Determine BO algorithm plugged into most maintenance objects (**F1-STD-DTMBO - Determine Standard Business Object**) checks for these two conditions.

There may also be cases where a single identifying BO is used for all BOs for a given MO. This may be an option used for some older maintenance object created prior to the business object functionality when implementations wish to introduce custom business rules that are common for all records of that MO. The product provides a base algorithm type (**F1-MOBO - Determine Specific Business Object**) that captures the BO as a parameter.

## Base Business Objects

For each maintenance object (MO) that supports an "identifying" business object, the type of business object provided by the product depends on the functionality and expected use by implementations. The following are some common patterns.

- There are MOs where the product provides base BOs that implementations may use if applicable for their business rules. In addition, it is expected that implementation will define custom BOs to support their business needs. Good examples of this type of MO are any of the various "rule" MOs. For example, calculation rule in Oracle Utilities Customer Care and Billing or the usage rule in Oracle Utilities Meter Data Management or the form rule in Oracle Public Sector Revenue Management. The product provides business objects for common rules but each implementation could have special rules that they need to implement and will need to create custom business objects.
- There are MOs where the product provides base BOs that supply common behavior for an object. Implementations may find that supplied the business objects match their business requirements and use the BOs as is. It is expected, however that for many implementations, their business rules will require additional elements to be captured or have special rules to apply. In this case the base business objects may be extended. This scenario may apply to 'master' data objects in various products such as the Device or Meter or Tax Role.
- There are MOs where the product may deliver a base BO that is not expected to satisfy most implementations because different jurisdictions or different implementations will typically have their own rules. In this case the base delivered BO can be used as a template or starting point for custom defined BOs. Some examples of this are Rebate Claim in Oracle Utilities Customer Care and Billing or the Appeal object in Oracle Public Sector Revenue Management.
- There are MOs where the expectation is that every implementation will have different requirements for the type of data to capture and the product will not supply base BOs that can be used as the "identifying" BO. However, it may supply a "parent" BO that defines the lifecycle and many of the business rules that it expects all records to follow. In these

scenarios, the implementations will create “child” BOs that will serve as the “identifying” BOs and refer to the base “parent” BO for many of its rules through [inheritance](#). Some examples of the are Tax Form in Oracle Public Sector Revenue Management or Activity in Oracle Utilities Mobile Workforce Management.

- There are some scenarios where the base product provides business objects and the expectation is that implementations will use the business objects as delivered with little or no customization. This is a case where the system used business objects to implement product functionality, not because there is an expectation that the implementers will extend the functionality, but because the business object model is the favored development tool even for the product. The objects delivered for Configuration Migration Assistant are an example.

---

**NOTE:** Not all maintenance objects in the product support business objects as a “identifying” or “governing” tool. This is the standard going forward for new maintenance objects. However, there are some maintenance objects created before this became a standard.

---

For all maintenance objects, the base product may provide additional BOs that are not meant to be “identifying” BOs, but instead are provided to support functionality to interact with the MO using the BO as a tool as described in [Invoking a BO](#).

- One or more “mini” or “lite” BOs may be supplied for a maintenance object. This may be found when the product has functionality to retrieve a subset of elements for the maintenance object via scripting or via a user interface.
- A “physical” BO may be supplied. This a BO that typically includes all tables and all fields of the maintenance object in there “physical” form. In other words, there is no “flattening” of child tables and any XML structure fields are defined as a single field. Physical BOs are used in system processing where the full record needs to be captured as is. Some functionality that uses a physical BO includes [bundling](#), [revision control](#) and the pre-compare algorithm for CMA to [adjust data prior to comparing](#).
- A “bundling add” BO may be supplied. Refer to [Recursive Key References](#) for more information as to why this type of BO may be supplied.

## Business Object Inheritance

A business object may inherit business rules from another business object by referencing the latter as its parent. A child business object can also have children, and so on. A parent's rules automatically apply to all of its children (no compilation - it's immediate). A child business object can always introduce rules of its own but never remove or bypass an inherited rule.

The following is an illustration of multiple levels of business object inheritance.

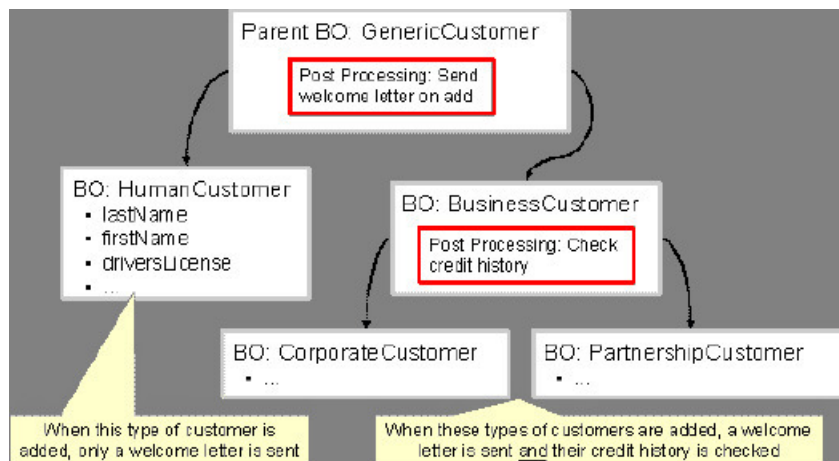

Notice how the "Business Customer" business object extends its parent rules to also enforce a credit history check on all types of customers associated with its child business objects.

Most types of business object system events allows for multiple algorithms to be executed. For example, you can have multiple **Validation** algorithms defined for a business object. For these, the system executes all algorithms at all levels in the inheritance chain starting from the highest-level parent business object moving on to lower levels.

Other types of system events allows for a single algorithm to be executed. For example, you can only have one **Information** algorithm to format the standard description of a business object instance. For these, the system executes the one at the level nearest to the business object currently being processed.

---

**NOTE:** The parent and its children must reference the same maintenance object.

---

**NOTE: Data structures are not inherited.** While you can declare schemas on parent business objects, their children will not inherit them. A good practice is to design child business object schemas to **include** their parent business object's schema.

---

**NOTE: User interface maps are inherited.** When determining if the business object has a UI map to use for UI rendering, the system looks for display and maintenance maps linked to the BO as options. If the identifying BO does not have maps defined, the system follows “up the chain” of inheritance until it finds a map to use. This allows for a child BO to be used to extend business rules of a parent BO but inherit its user interface behavior. Refer to [Business Object Defines its User Interface](#) for more information.

---

**NOTE: Use Inheritance Wisely.** While it is intellectually attractive to abstract behavior into parent BOs to avoid redundant logic and simplify maintenance, before doing this weigh the reuse benefits against the cost in transparency, as it is not easy to maintain a complex hierarchy of business objects.

---

## Each Business Object Can Have A Different Lifecycle

Many maintenance objects have a status column that holds the business entity's current state within its lifecycle. Rules that govern lifecycle state transition (e.g., what is its initial state, when can it transition to another state, etc.) and the behavior associated with each state are referred to as lifecycle rules. Older Maintenance Objects, such as To Do Entry, have predefined lifecycles whose rules are governed by the base-package and cannot be changed. The lifecycle of newer Maintenance Objects exists in business object meta-data and as such considered softly defined. This allows you to have completely different lifecycle rules for business objects belonging to the same maintenance object.

Here are examples of two business objects with different lifecycles that belong to the same maintenance object.

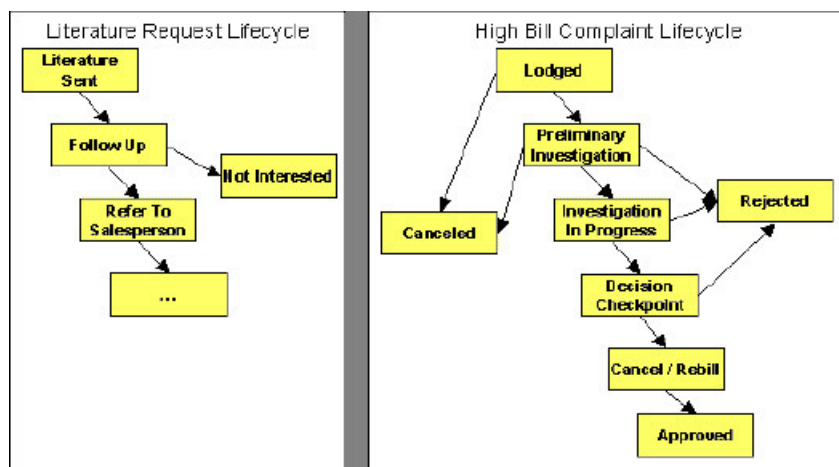

---

**NOTE:** A Maintenance Object supports soft lifecycle rules if it is defined with a **Status Field Maintenance Object** option.

---



The topics that follow describe important lifecycle oriented concepts.

## Valid States versus State Transition Rules

The boxes in the above diagram show the potential valid states a business entity of the above business object can be in. The lines between the boxes indicate the state transition rules. These rules govern the states it can move to while in a given state. For example, the above diagram indicates a high bill complaint that's in the **Lodged** state can be either **Canceled** or moved into the **Preliminary Investigation** state.

When you set up a business object, you define both its valid states and the state transition rules.

## One Initial State and Multiple Final States

When you set up lifecycle states, you must pick one as the initial state. The initial state is the state assigned to new entities associated with the business object. For example, the above high-bill complaint business object defines an initial state of **Lodged**, whereas the literature request one defines an initial state of **Literature Sent**.

You must also define which statuses are considered to be "final". Typically when an entity reaches a "final" state, its lifecycle is considered complete and no further processing is necessary.

---

**NOTE: Allowing An Entity To Be "Reopened".** You can set up your state transition rules to allow a business entity to be "reopened" (i.e., to be moved from a final state to a non-final state). Neither of the above examples allows this, but it is possible if you configure your business object accordingly.

---

## State-Specific Business Rules

For each state in a business object's lifecycle, you can define the following types of business rules.

---

**FASTPATH:** Refer to [BO Algorithm Execution Order](#) for a summary of when these lifecycle algorithms are executed with respect to BO level algorithms.

---

## Logic To Take Place When Entering A State

You can define algorithms that execute before a business entity enters a given state. For example, you could develop an algorithm that requires a cancellation reason before an entity is allowed to enter the **Canceled** state.

You can also incorporate state auto-transitioning logic within this type of algorithms. Refer to [auto-transition](#) for more information.

Also note that when a record is processed by the monitor batch program, by default the BO Post Processing, BO Audit and MO Audit algorithms are not executed. However, it is possible for an enter algorithm to indicate that the other algorithms should be executed by the batch process by setting the "force post processing" indicator to true.

## Logic To Take Place When Exiting A State

You can define algorithms that execute when a business entity exists a given state. For example, you could develop an algorithm that clears out error messages when a given entity exits the **Error** state.

Also note that when a record is processed by the monitor batch program, by default the BO Post Processing, BO Audit and MO Audit algorithms are not executed. However, it is possible for an exit algorithm to indicate that the other algorithms should be executed by the batch process by setting the "force post processing" indicator to true.

## Monitor Rules

You can define algorithms to monitor a business entity while it is in a given state. This type of logic is typically used to check if the conditions necessary to [transition](#) the entity to another state exist (and, if so, transition it). For example, transition an entity to the **Canceled** state if it's been in the **Error** state too long. Another common use is to perform ancillary work while an entity is in a given state. For example, update statistics held on the object while it's in the **Active** state.

Monitor algorithms are invoked when a business entity first enters a state and periodically after that in [batch](#). You have the option to defer the monitoring of a specific state until a specific monitoring batch job runs. You do so by associating the state with a specific monitoring process. In this case the system will only execute the monitoring rules of this state when that specific batch process runs. This is useful when processing one type of record typically creates another type of record. You may want the processing of the second set of records to be deferred to a later time.

A monitor algorithm can carry out any business logic. In addition it can optionally tell the system to do either of the following:

- Stop monitoring and transition to another state. The system will not call any further monitoring algorithm plugged in on the state and attempt to transition the entity to the requested new state.
- Stop monitoring. Same as above except that no transition takes place. You may want to use this option to prevent transitions while some condition is true.

If none of the above is requested the system keeps executing subsequent monitoring algorithms.

Also note that when a record is processed by the monitor batch program, by default the BO Post Processing, BO Audit and MO Audit algorithms are not executed. However, it is possible for a monitor algorithm to indicate that the other algorithms should be executed by the batch process by setting the “force post processing” indicator to true.

---

**FASTPATH:** Refer to [Business Object - Lifecycle](#) for more information on how to set up state-specific algorithms.

---

## Inheriting Lifecycle

If a business object references a parent business object, it always [inherits](#) its lifecycle from the highest-level business object in the hierarchy. In other words, only the highest-level parent business object can define the lifecycle and the valid state transitions for each state. Child business objects, in all levels, may still extend the business rules for a given state by introducing their own state-specific algorithms.

The system executes all state-specific algorithms at all levels in the inheritance chain starting from the highest-level parent business object moving on to lower levels.

## Auto-Transition

In a single transition from one state to another, the system first executes the **Exit** algorithms of the current state, transitions the entity to the new state, executes the **Enter** algorithms of the new state followed by its **Monitor** algorithms. At this point if a **Monitor** algorithm determines that the entity should be further automatically transitioned to another state the remaining monitoring algorithm defined for the current state are not executed and the system initiates yet another transition cycle.

Notice that an **Enter** algorithm can also tell the system to automatically transition the entity to another state. In this case the remaining **Enter** algorithm as well as all **Monitor** algorithms defined for the current state are not executed.

The following illustration provides an example of an auto-transition chain of events.

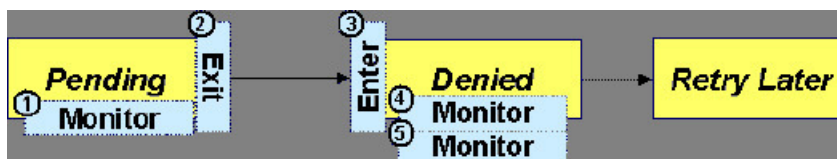



In this example a business entity is in a Pending state. While in that state a **Monitor** algorithm determines to auto-transition it to the Denied state. At this point the following takes place:

- No further **Monitor** algorithms of the Pending state are executed
- Pending state **Exit** algorithms are executed
- The system transitions the entity to the Denied state
- Denied state **Enter** algorithms are executed. No further auto-transition is requested.
- Denied state **Monitor** algorithms are executed. No further auto-transition is requested.

## Keeping An Entity In Its Last Successful State

By default, any error encountered while transitioning a business entity from one state to another rolls back all changes leaving the entity in its original state.

When applicable, the Maintenance Object can be configured to always keep an entity in its last successful state rather than rolling all the way back to the original state. This practice is often referred to as "taking save-points". In case of an error, the entity is rolled back to the last successfully entered state and the error is logged on the [maintenance object's log](#). Notice that with this approach no error is returned to the calling process, the error is just logged.

The logic to properly log the error is in a **Transition ErrorMaintenance Object plug-in**. The system considers a maintenance object to practice "save-points" when such an algorithm is plugged into it.

Even if the maintenance object practices "save-points", in case of an error the system will not keep an entity in the last successfully entered state if that state is either marked as [transitory](#) or one of its **Enter** algorithms has determined that the entity should proceed to a next state. The system will roll back to the first previous state that does not match these conditions.

## Monitoring Batch Processes

A monitor batch process may be used to transition a business object into its next state by executing the monitor algorithms associated with the current state of the entity. The use cases for performing the monitor logic in batch are as follows:

- The record may be waiting for something else to occur before transitioning. The monitor algorithm may be coded to determine if the condition is satisfied and initiate the transition then. For example perhaps when entering a state, a field activity is generated and the record should exit the state when the field activity is complete. The monitor algorithm can check the status of the field activity.
- Perhaps a record is added or updated manually and the next step in the BO lifecycle includes a large amount of processing such that the logic should occur in batch. In this case the BO status is configured with an explicit reference to a batch control (called a "deferred" batch control), which indicates to the system that the monitor algorithms should not be performed automatically (but should be deferred to batch). Later when the batch process runs, it selects all the records to process to progress the records.

---

**NOTE:** When a status includes a deferred batch control, it may also be configured to allow a user to manually transition the record to the next state rather than waiting for batch. When a user manually transitions a record that includes monitor algorithms, those algorithms are not executed.

---

- Perhaps a record is added or updated in batch, but a subsequent step in the overall lifecycle should be processed later. This may be accomplished by ensuring that the batch control linked to the state to process later does not match the batch control that added or updated the record.
- Monitor processes may also be used to periodically perform some logic related to the record without actually transitioning the record.

Note that only the parent business object may refer to a deferred monitor batch process. However, any business object in the "[inheritance](#)" chain may be configured with monitor algorithms, which will all be executed.

The base package provides a periodic monitoring batch process for each maintenance object that supports a configurable BO lifecycle. The process periodically executes the monitoring algorithms associated with the current state of an entity, excluding states explicitly referencing a deferred monitoring batch process that is for a different batch control.

A deferred monitoring process works in the same way except that it considers entities whose current state references this particular batch control as their monitor process in addition to records that don't refer to any batch controls as their monitor process. Deferred monitoring is only needed when a given state should not execute its monitor algorithms immediately upon entering the state, but rather when the batch process is specifically executed.

---

**NOTE: MO option configuration.** The maintenance object includes options to indicate the batch controls delivered for periodic and deferred monitor batch controls.

---

Your business rules will dictate the execution frequency of each monitoring process and the order in which they should be scheduled. Refer to [Monitor Background Processes](#) in the background process chapter for more information about the parameters supported for this type of batch process.

---

**NOTE: Updates to the business object.** When the monitor algorithms indicate that the business object should transition, the monitor batch processes are responsible for ensuring the business object is transitioned appropriately and that the appropriate exit, enter and monitor algorithms are executed. Please note that the business object is not updated using a call to the maintenance object service and therefore by default the [business rules](#) plugged in to the business object are not executed. However, it is possible for an Enter algorithm, Exit algorithm or Monitor algorithm to indicate that the other algorithms should be executed by the batch process. If the "force post processing" indicator is set to true, then the batch process invokes the BO Post Processing, BO Audit and MO Audit algorithms.

---

## Transitory States

You can define a state as **Transitory** if you do not wish the business entity to ever exist in that particular state.

The following illustrates a lifecycle with a transitory Validate state.

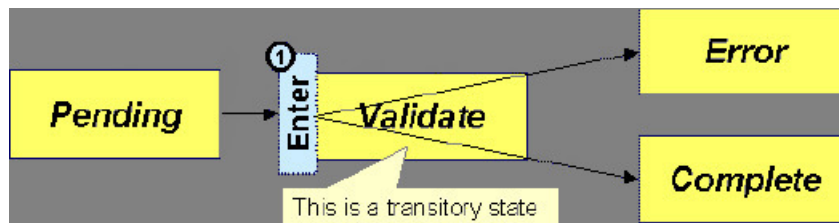

In this example, the business entity is saved still not validated in the Pending state. At some point, the user is ready to submit the entity for validation and transitions it into a transitory state Validate whose **Enter** rules contain the validation logic. The responsibility of the transitory state's **Enter** algorithms is to decide if the entity is valid or in error and then transitions it into the appropriate final state. In this scenario, you may not ever want the business entity to exist in the Validate state.

Let's also assume that the maintenance object in this example is practicing "[save-points](#)" and requires the entity to be kept in its last successful state. If an error were to occur during the transition from **Validate** to the next state, the system would roll back the entity back to Pending, and not Validate even though the entity has successfully entered the Validate state. Refer to the [Auto Transition](#) section for more information.

## State Transitions Are Audited

Most Maintenance Objects that support soft lifecycle definition also have a log to hold significant events throughout a business entity's lifecycle. For example, log entries are created to record:

- When the business entity is created (and who created it)
- When its status changes (and who changed it)

- If a transition error occurred (and the error message)
- References to other objects created throughout the entity's lifecycle. For example, if a To Do entry is created as part of processing the entity, the To Do Entry is referenced in the log.
- Manual entries added by a user (think of these as "diary" entries)

When a business entity is first created and when it transitions into a new state the system calls **Transition** algorithm(s) plugged in on the [Maintenance Object](#) to record these events. If the maintenance object supports a log these events can be captured as log entries.

---

**NOTE:** Most base package maintenance objects supporting a log may already provide state transition logging as part of their core logic. In this case you only need to provide a **Transition** plug-in if you wish to override base logging logic with your own.

---

## Required Elements Before Entering A State

You can define additional elements that are required before a business entity can enter a given state. For example, let's assume that a Cancel Reason must be defined before an object can enter the *Canceled* state. You do this by indicating that element as a **Required Element** [state-specific option](#) on the appropriate state on the business object.

## Capturing a Reason for Entering a State

Some business objects support configuring certain states to allow or require a status reason when an object enters the state. The product provides a centralized status reason table that may be used to define the valid BO status reasons for various business objects and various states. The status reasons are defined using the [Status Reason](#) portal.

The following sections provide additional information about the BO status reason functionality.

## Maintenance Object Must Support Status Reason

In order for a business object to use the centralized status reason table to define reasons, the maintenance object must first support the status reason. MOs that support status reason have the following characteristics:

- The primary table includes a column for Status Reason. This represents the status reason for the record's current status, if applicable.
- The log table includes a column for Status Reason. The standard logic for capturing a log record when entering a state also captures the status reason, if applicable. This allows a user to review the history of the changes in status and the status reason captured for a previous state transition, if applicable.
- The maintenance object option collection includes an option that defines the Status Reason field. This setting is a trigger for business objects of this MO to be able to configure states to allow or require status reason.

## Business Object State Indicates if Reasons are Applicable

Once the MO is configured to support status reason, configuration on the business object is required to indicate the states where a reason is applicable. States may be configured to require status reasons, allow status reasons as optional or not allow status reasons. With this configuration, the framework will automatically get the list of valid reasons for a state that allows or requires them and then prompt the user for a status reason when a manual state transition occurs for that state. It also automatically triggers an error if the state requires a status reason and no reason is provided.

---

**NOTE:** The status reason configuration on the business object state is customizable. That means that for a product owned business object, an implementation may opt to change the delivered configuration.

---

Status reasons are defined for the parent (or "lifecycle") business object. All business objects in the hierarchy of the parent business object have the same valid reasons for their states.

The status reason code must be unique for the centralized status reason table. Business object and status are required fields, so it is not possible to share a common reason `code` (like “Not applicable”) across multiple business objects or states. If multiple BOs / states want to support a reason “Not applicable” then each must define a unique record for it. This point should be considered when planning for your status reasons.

## Selectable vs. Not Selectable

When defining a status reason, you may indicate whether it’s **Selectable** or **Not Selectable**. When a manual transition is performed and a user is prompted for a status reason, only the **Selectable** reasons are presented. The **Not Selectable** reasons may be defined to support transitions that occur via algorithm processing.

---

**NOTE:** The Selectable setting is customizable. That means that if a product provides a base owned status reason for a business object state, an implementation may opt to change whether it is selectable or not. Careful consideration should be made before changing a base delivered status reason from **Not Selectable** to **Selectable** as this may affect base provided algorithm functionality that could be relying on the setting of **Not Selectable**.

---

## Status Reason Business Object

The status reason maintenance object, as with many maintenance objects in the product, references a business object used to define attributes and behavior related to defining status reasons. The framework provides a business object for status reason (**F1-BOStatusReason**). For the business objects that have states that require a status reason (let’s call these “transactional BOs”), if there is some special logic required for defining the status reasons, it is possible to define a different status reason BO. In this situation, the override status reason BO to use for capturing status reasons should be defined as a BO option on the transactional BO using the **Status Reason Business Object** option type. If a transactional BO does not define any status reason BO option, then the **F1-BOStatusReason** is used when adding a status reason.

## Defining a Usage

The base product status reason BO provides the ability to define a “usage” value. This is useful for algorithms that perform state transitions where a status reason is needed and where the algorithm is usable by more than one business object. In this case, the status reason to use cannot be provided as a parameter because each business object must define its own set of status reasons for each state. The Usage value can be used instead. Each business object can configure the status reason to use in the algorithm and set the appropriate usage value. The algorithm can reference the usage value and retrieve the correct status reason to use based on the record’s transactional BO.

The status reason business object provided with the framework product (**F1-BOStatusReason**) supports capturing a usage. The valid usage values are defined in the **Status Reason Usage** characteristic type.

## Alternatives for Defining Reasons

There may be business objects in the system that capture reasons that are defined somewhere besides the BO status reason table. For example, some objects may have an explicit administrative table for status reasons. Some objects may use a Lookup or an Extendable Lookup to capture reasons. Refer to the business object description for information about how valid reasons are defined, if applicable.

If a business object supports a reason that is not related to a state transition (such as a creation reason), the BO status reason would not be used. One of the alternate methods for defining a reason, described above, would be used.

## Opening UI Maps Before Entering A State

You can define a UI Map to capture additional elements before a business entity can enter a given state. You do this by configuring the **State Transition UI Map** [state-specific option](#) on the appropriate state on the business object.

There may be circumstances in which the status pre-processing logic can determine the value of the elements, in which case it is not necessary to invoke the map. The system provides a data area (**F1-StateTransitionCommon**) which contains a boolean element to indicate if the state transition map can be skipped. This data area can be included in your pre-processing

script to allow the element to be set according to your business logic. The base maintenance script (**F1-MainProc**) references this element to determine whether to open the state transition map.

## BO Algorithm Execution Summary

This table highlights the processing steps that occur when adding or changing a record that is governed by a business object.

Invoke BO	
Event	Comments
BO Pre-processing algorithms executed	These algorithms are only executed when Invoke BO is used. The business object in the Invoke BO is the one whose rules are executed.
MO Processing	
Event	Comments
Determine if status has changed.	The system keeps a note of the new status value but initially proceeds with the old value.
MO Processing.	Standard MO processing, including MO validation is executed.
Determine BO algorithm executed.	The MO level algorithm is executed to <a href="#">determine the identifying BO</a> .
BO Validation algorithms executed.	
<a href="#">State transition rules</a> are performed if the status has changed.	BO Status Exit algorithms for the “old” status executed. Status updated to the new value. BO Status Enter algorithms for the “new” status executed. If no error — MO Transition algorithms are executed.  <b>FASTPATH:</b> Refer to <a href="#">State Transitions are Audited</a> for more information.  If error and there are “save points” the MO Transition Error algorithms are executed.  <b>FASTPATH:</b> Refer to <a href="#">Keeping An Entity In Its Last Successful State</a> for more information.  Otherwise, the error is reported.
BO Status Monitor algorithms are executed.	If the record transitions again, the prior step (State transition rule step) is repeated for the new transition.
BO Post-processing algorithms are executed.	
BO Audit algorithms are executed.	These algorithms are only executed if the system detects a change in elements that are not marked with “no audit”.

**NOTE:** To emphasize, the steps in the MO Processing table are only executed when the maintenance object service is invoked. Any add or update initiated by an “invoke BO” statement will invoke the MO service. This is also true for web service that invoke the business object. The [Monitor Batch Process](#) does not invoke the maintenance service. By default the monitor batch process only executes the monitor algorithms and the state transition rules (if the monitor algorithms indicate that a status change should occur). However, it is possible for an Enter algorithm, Exit algorithm or Monitor algorithm to indicate that the other algorithms should be executed by the batch process. If the “force post processing” indicator is set to true, then the batch process invokes the BO Post Processing, BO Audit and MO Audit algorithms.

**NOTE:** For records that do not have a status, the state transition rules and the monitor rules are not applicable.

## Granting Access To Business Objects

Every business object must reference an [application service](#). When you link a business object to an application service, you are granting all users in the group access to its instances. You can prevent users from transitioning a business object into

specific states by correlating each business object status with each application service action (and then don't give the user group rights to the related action).

---

**FASTPATH:** Refer to [The Big Picture Of Application Security](#) for information about granting users access rights to an application service.

---

The system checks if a user has access rights each time the application is invoked to add, change, delete, read, or transition a business object. However, if a business object invokes another business object, we assume that access was controlled by the initial business object invocation and we do not check access for other business objects that it invokes. In other words, access rights are only checked for the initial business object invoked in a service call.

In order to apply business object security the system must be able to determine the business object associated with the actual object being processed. To do that the Maintenance Object itself has to have a **Determine BO** algorithm [plugged in](#). If this algorithm is not plugged in or it cannot determine the BO on the MO, the system will not invoke any BO rules. If the business object cannot be determined for a maintenance object instance, business object security is not checked. In this case the system checks the user's access rights using standard maintenance object security.

---

**NOTE: Parent business objects are ignored.** If a child business object exists, a user need only have access to the child business object's application service (not to every application service in the business object hierarchy).

---

## Defining Business Objects

The topics in this section describe how to maintain business objects.

Note that several context sensitive dashboard zones appear on this page and are visible on all tabs.

- **Schema Tips.** This zone provides several links to launch help topics related to valid schema syntax and UI Hint syntax in one click.
- **View UI Rendering.** This zone provides buttons to view the automatic rendering of the Display map or Input map based on the attributes defined in the schema, including UI hints.
- **Generate Schema.** This zone includes a button that can be used to generate a “physical” schema based on the maintenance object definition. The element names are taken from the Java field name for each column. Once generated, adjust the schema as desired.
- **Create a BO Algorithm.** This zone includes a button to create a script based algorithm related to this business object. You are then prompted for information regarding the plug-in spot (BO or BO Status) and the system event, the name, description, etc. Once all the information is provided, the system creates an algorithm type, algorithm, links the algorithm to the business object, creates the script and brings you to the script step to start defining the logic for the plug-in script.
- **BOs Linked to the MO.** This zone displays other business objects for the same maintenance object as the BO currently displayed. You may drill into any of the other BOs by clicking its description.

## Business Object - Main

Use this page to define basic information about a business object. Open this page using **Admin > System > Business Object**

### Description of Page

Enter a unique **Business Object** name and **Description**. Use the **Detailed Description** to describe the purpose of this business object in detail. **Owner** indicates if this business object is owned by the base package or by your implementation (**Customer Modification**).



---

**CAUTION:** Important! If you introduce a new business object, carefully consider its naming convention. Refer to [System Data Naming Convention](#) for more information.

---

Enter the **Maintenance Object** that is used to maintain objects of this type.

Enter a **Parent Business Object** from which to [inherit](#) business rules.

**Lifecycle Business Object** is only displayed for child business objects, i.e. those that reference a parent business object. It displays the highest-level business object in the inheritance hierarchy. Refer to [Inheriting Lifecycle](#) for more information.

**Application Service** is the application service that is used to provide security for the business object. Refer to [Granting Access To Business Objects](#) for more information. The application service on the child business object must have the same valid actions as the application service on the parent business object.

Use **Instance Control** to allow or prevent new entities from referencing the business object. Typically only the [identifying BOs](#) are marked to allow new instances.

Click the **View Schema** hyperlink to view the business object's expanded schema definition. Doing this opens the [schema viewer](#) window.

Click the **View XSD** hyperlink to view the business object's expanded schema definition in XSD format.

Click the **View MO** hyperlink to view the maintenance object in the [Maintenance Object Viewer](#). You may find it useful to leave the application viewer window open while defining your business object schema.

The options grid allows you to configure the business object to support extensible options. Select the **Option Type** dropdown to define its **Value**. **Detailed Description** may display additional information on the option type. Set the **Sequence** to **1** unless the option can have more than one value. **Owner** indicates if this option is owned by the base package or by your implementation (**Customer Modification**).

---

**NOTE:** You can add new options types. Your implementation may want to add additional option types. For example, your implementation may have plug-in driven logic that would benefit from a new option. To do that, add your new values to the customizable lookup field **BUS\_OBJ\_OPT\_FLG**. If you add a new option type for a business option, you must update its maintenance object to declare this new option type. Otherwise, it won't appear on the option type dropdown. You do that by referencing the new option type as a **Valid BO Option Type**[maintenance object option](#).

---

## Where Used

Follow this link to open the data dictionary to view the tables that reference [F1\\_BUS\\_OBJ](#).

## Business Object - Schema

Use this page to maintain a business object's schema. Open this page using **Admin > System > Business Object** and then navigate to the **Schema** tab.

### Description of Page

The contents of this section describe the zones that are available on this portal.

The **General Information** zone displays main attributes of the business object.

Click the **View Schema** hyperlink to view the business object's expanded schema definition. Doing this opens the [schema viewer](#) window.

Click the **View XSD** hyperlink to view the business object's expanded schema definition in XSD format.

The [Schema Designer](#) zone allows you to edit the business object's schema. The purpose of the schema is to describe the business object's properties and map them to corresponding maintenance object fields.

---

**FASTPATH:** Refer to [Schema Syntax](#) and [UI Hint syntax](#) for a complete list of the XML nodes and attributes available to you when you construct a schema. Also note that the **Schema Tips** zone in the dashboard provides links to launch these help topics directly.

---

**NOTE: Generating a Schema** A context sensitive "Generate Schema" zone is associated with this page. The zone provides a button that allows the user to generate a basic schema that includes all the fields for all the tables for the BO's maintenance object. Note that each maintenance object has an underlying service and it's possible that some of the child tables in the maintenance object are not included in the service definition. If that is the case, a message is issued and the generated schema would need to be adjusted to remove that child table.

---

**NOTE: View UI Rendering.** A context sensitive "View UI Rendering" zone is associated with this page. The zone is useful for [business objects that define the user interface detail](#) using schema attributes and UI Hints. The buttons allow you to view the automatically rendered display and input maps.

---

The **Schema Usage Tree** zone summarizes all cross-references to this schema. These may be other schemas, scripts, and web services. For each type of referencing entity, the [tree](#) displays a summary node showing a total count of referencing items. The summary node appears if at least one referencing item exists. Expand the node to list the referencing items and use their description to navigate to their corresponding pages.

## Business Object - Algorithms

Use this page to maintain a business object's algorithms. Open this page using **Admin > System > Business Object** and then navigate to the **Algorithms** tab.

### Description of Page

The **Algorithms** grid contains algorithms that control important functions for entities defined by this business object. You must define the following for each algorithm:

- Specify the **System Event** with which the algorithm is associated (see the table that follows for a description of all possible events).
- Specify the **Sequence Number** and **Algorithm** for each system event. You can set the **Sequence Number** to 10 unless you have a **System Event** that has multiple **Algorithms**. In this case, you need to tell the system the **Sequence** in which they should execute.
- If the algorithm is implemented as a script, a link to the **Script** is provided. Refer to [Plug-In Scripts](#) for more information.
- **Owner** indicates if this is owned by the base package or by your implementation (**Customer Modification**).

The following table describes each **System Event**. Refer to [A Business Object May Define Business Rules](#) for more information about these system events.

System Event	Optional / Required	Description
Audit	Optional	<p>Algorithms of this type may be used to audit certain changes made to business object instances.</p> <p>The system hands over to the algorithms a summary of all the elements that were changed throughout a specific call to update an object. Excluded from this processing are elements explicitly marked on the schema as requiring no audit. For each element its original value before the change as well as its new value are provided.</p> <p>It is the responsibility of the algorithms to record corresponding audit information.</p>



System Event	Optional / Required	Description
		<p>The system invokes all algorithms of this type defined on the business object's inheritance hierarchy. Refer to <a href="#">Business Object inheritance</a> for more information.</p> <p>Click <a href="#">here</a> to see the algorithm types available for this system event.</p>
Information	Optional	<p>We use the term "Business Object Information" to describe the basic information that appears throughout the system to describe an entity defined by the business object. The data that appears in this information description is constructed using this algorithm.</p> <p>The system invokes a single algorithm of this type. If more than one algorithm is plugged-in the system invokes the one with the greatest sequence number found on the business object closest to the current business object in the inheritance hierarchy. Refer to <a href="#">Business Object inheritance</a> for more information.</p> <p>Click <a href="#">here</a> to see the algorithm types available for this system event.</p>
Post-Processing	Optional	<p>Algorithms of this type may be used to perform additional business logic after a business object instance has been processed.</p> <p>The system invokes all algorithms of this type defined on the business object's inheritance hierarchy. Refer to <a href="#">Business Object inheritance</a> for more information.</p> <p>Click <a href="#">here</a> to see the algorithm types available for this system event.</p>
Pre-Processing	Optional	<p>Algorithms of this type further populates a request to maintain a business object instance right before it is processed.</p> <p>The system invokes all algorithms of this type defined on the business object's inheritance hierarchy. Refer to <a href="#">Business Object inheritance</a> for more information.</p> <p>Click <a href="#">here</a> to see the algorithm types available for this system event.</p>
Validation	Optional	<p>Algorithms of this type may be used to validate a business object instance when added, updated or deleted.</p> <p>The system invokes all algorithms of this type defined on the business object's inheritance hierarchy. Refer to <a href="#">Business Object inheritance</a> for more information.</p> <p>Click <a href="#">here</a> to see the algorithm types available for this system event.</p>

**FASTPATH:** Refer to [BO Algorithm Execution Summary](#) for more information about how these algorithms fit within the business object processing.

**NOTE: Generate Algorithm.** A context sensitive "Generate a BO Algorithm" zone is associated with this page. Refer to [Defining Business Objects](#) for more information about this zone.

**NOTE: You can add new system events.** Your implementation may want to add additional business object oriented system events. For example, your implementation may have plug-in driven logic that would benefit from a new system event. To do that, add your new values to the customizable lookup field **BO\_SEVT\_FLG**. If you add a new business object system event, you must update the maintenance object to declare this new system event. Otherwise, it won't

appear on the system event dropdown. You do that by referencing the new system event as a **Valid BO System Event maintenance object option**.

---

**NOTE: You can inactivate algorithms on base Business Objects.** Your implementation may want to use a business object provided by the base product, but may want to inactivate one or more algorithms provided by the base business object. To do that, on the business object where this algorithm is referenced, go to the options grid on Business Object - Main and add a new option, setting the option type to **Inactive Algorithm** and setting the option value to the algorithm code.

---

## Business Object - Lifecycle

Use this page to maintain a business object's lifecycle oriented business rules and options. Open this page using **Admin > System > Business Object** and then navigate to the **Lifecycle** tab.

### Description of Page

The **Status** accordion contains an entry for every status in the object's [lifecycle](#). The entry appears differently for a child business object as it can only extend its inherited lifecycle by introducing algorithms and options of its own.

Use **Status** to define the unique identifier of the status. This is not the status's description, it is simply the unique identifier used by the system. Only the highest-level business object can define lifecycle statuses. For a child business object the inherited status description is displayed allowing navigation to the corresponding entry on the business object defining the lifecycle.

Use **Description** to define the label of the status. This field is hidden for a child business object.

Use **Access Mode** to define the action associated with this status. Refer to [Access Rights](#) for the details of how to use this field to restrict which users can transition a business entity into this state. This field is hidden for a child business object.

Enter a **Monitor Process** to defer the monitoring of entities in this state until the specific batch process runs. Refer to [Monitor Rules](#) for more information. This field is hidden for a child business object.

The **Status Reason** dropdown indicates if users should be prompted to provide a specific reason when the business object enters this state. This field appears only if the Status Reason Field is configured as an option on the business object's maintenance object. Valid values are blank, **Optional**, and **Required**. The default value is blank (users are not prompted to provide a status reason). See [Configuring Status Reasons](#) for more information about status reasons.

Use **Status Condition** to define if this status is an **Initial**, **Interim** or **Final** state. Refer to [One Initial State and Multiple Final States](#) for more information about how this field is used. This field is hidden for a child business object.

Use **Transitory State** to indicate whether a business entity should ever exist in this state. Only **Initial** or **Interim** states can have a transitory state value of **No**. Refer to [transitory states](#) for more information. This field is hidden for a child business object.

Use **Alert Flag** to indicate that being in this state warrants an application alert. This may be used by custom logic to provide an alert to a user that entities exist in this state. This field is hidden for a child business object.

Use **Display Sequence** to define the relative order of this status for display purposes. For example when displayed on the status accordion and on the summary tab page. This field is hidden for a child business object.

### Algorithms

The **Algorithms** grid contains algorithms that control important functions for a given status. You must define the following for each algorithm:

- Specify the **System Event** with which the algorithm is associated (see the table that follows for a description of all possible events).
- Specify the **Sequence Number** and **Algorithm** for each system event. You can set the **Sequence Number** to 10 unless you have a **System Event** that has multiple **Algorithms**. In this case, you need to tell the system the **Sequence** in which they should execute.

- If the algorithm is implemented as a script, a link to the **Script** is provided. Refer to [Plug-In Scripts](#) for more information.
- **Owner** indicates if this is owned by the base package or by your implementation (**Customer Modification**).

The following table describes each **System Event**.

<b>System Event</b>	<b>Optional / Required</b>	<b>Description</b>
<b>Enter</b>	Optional	<p>Algorithms of this type apply business rules when a business object instance enters a given state.</p> <p>The system invokes all algorithms of this type defined on the business object's inheritance hierarchy. Refer to <a href="#">Business Object Inheritance</a> for more information.</p> <p>Click <a href="#">here</a> to see the algorithm types available for this system event.</p>
<b>Exit</b>	Optional	<p>Algorithms of this type apply business rules when a business object instance exits a given state.</p> <p>The system invokes all algorithms of this type defined on the business object's inheritance hierarchy. Refer to <a href="#">Business Object Inheritance</a> for more information.</p> <p>Click <a href="#">here</a> to see the algorithm types available for this system event.</p>
<b>Monitor</b>	Optional	<p>Algorithms of this type monitor a business object instance while in a given state. Typically these are used to auto-transition it to another state.</p> <p>The system invokes all algorithms of this type defined on the business object's inheritance hierarchy. Refer to <a href="#">Business Object Inheritance</a> for more information.</p> <p>Click <a href="#">here</a> to see the algorithm types available for this system event.</p>

**FASTPATH:** Refer to [BO Algorithm Execution Summary](#) for more information about how these algorithms fit within other business object algorithms.

**NOTE: Generate Algorithm.** A context sensitive "Generate a BO Algorithm" zone is associated with this page. Refer to [Defining Business Objects](#) for more information about this zone.

**NOTE: You can inactivate status level algorithms on base Business Objects.** Your implementation may want to use a business object provided by the base product, but may want to inactivate one or more of the status oriented algorithms provided by the base business object. To do that, on the business object and status where this algorithm is referenced, go to the options grid and add a new option, setting the option type to **Inactive Algorithm** and setting the option value to the algorithm code.

### Next Statuses

Use the **Next Statuses** grid to define the valid statuses a business entity can transition into while it's in this state. This section is hidden for a child business object. Refer to [Valid States versus State Transition Rules](#) for more information. Please note the following about this grid:

- **Status** shows the statuses for the top-level business object, the **Status Code**, the **Lifecycle BO description**, and the **Status description** for each status.
- Use **Action Label** to indicate the verbiage to display on the button used to transition to this status.

- **Sequence** controls the relative order of one status compared to others for display purposes. This information may be used to control the order in which buttons are presented on a user interface.
- **Default** controls which next state (if any) is the default one. This information may be used by an **Enter** or **Monitor** algorithm to determine an auto-transition to the default state. It may also be used to also mark the associated button as the default one on a user interface.
- **Transition Condition** may be configured to identify a common transition path from the current state. By associating a given "next status" with a transition condition value, you can design your auto-transition rules to utilize those flag values without specifying a status particular to a given business object. Thus, similar logic may be used across a range of business objects to transition a business entity into, for example, the next **Ok** state for its current state. You'll need to add your values to the customizable lookup field **BO\_TR\_COND\_FLG**.
- **Transition Role** controls whether only the **System** or both **System and User** have the ability to transition a business entity into a given "next status".
- When you initially set up a business object lifecycle, none of the statuses will reside on the database and therefore you can't use the search to define a "next status". We recommend working as follows to facilitate the definition of this information:
  - Leave the Next Statuses grid blank when you initially define a business object's statuses
  - After all statuses have been saved on the database, update each status to define its Next Statuses (this way, you can use the search to select the status).

### Options

The options grid allows you to configure the business object status to support extensible options. Select the **Option Type** drop-down to define its **Value**. **Detailed Description** may display additional information on the option type. Set the **Sequence** to **1** unless the option can have more than one value. **Owner** indicates if this option is owned by the base package or by your implementation (**Customer Modification**).

---

**NOTE: You can add new options types.** Your implementation may want to add additional option types. For example, your implementation may have plug-in driven logic that would benefit from a new option. To do that, add your new values to the customizable lookup field **BO\_OPT\_FLG**. If you add a new option type for a status, you must update the business object's maintenance object to declare this new option type. Otherwise, it won't appear on the option type dropdown. You do that by referencing the new option type as a **Valid BO Status Option Type** [maintenance object option](#).

---

## Business Object - Summary

This page summarizes business object information in a high level. Open this page using **Admin > System > Business Object > Search** and then navigate to the **Summary** tab.

### Description of Page

The contents of this section describe the zones that are available on this portal.

The **General Information** zone displays main attributes of the business object.

Click the **View Schema** hyperlink to view the business object's expanded schema definition. Doing this opens the [schema viewer](#) window.

Click the **View XSD** hyperlink to view the business object's expanded schema definition in XSD format.

The **Business Object Hierarchy** zone displays in a tree view format the [hierarchy](#) of child business object associated with the current business object. It also shows the current business object's immediate parent business object.

For business objects with a lifecycle, the **Lifecycle Display** zone shows a graphical depiction of the lifecycle. Refer to the embedded help of that zone for more information.

The **Options** zone summarizes business object and state specific options throughout the [inheritance](#) chain.

The **Rules** zone summarizes business object and state specific rules throughout the [inheritance](#) chain.

## Advanced BO Tips and Techniques

The topics in this section describe some advanced tips and techniques for configuring business objects.

### Managing To Do Entries

The product provides several base algorithm types that may be used to manage To Do entries through status changes for a given record via BO lifecycle plug-ins.

#### Create To Do Entry

The product supplies a BO status Enter algorithm type **Generic To Do Creation (F1-TDCREATE)** that creates a To Do entry based on parameter configuration. Refer to the algorithm type description for more information about how it determines the To Do type or To Do role and how to populate the appropriate message text onto the To Do. This algorithm may be used in conjunction with the Retry Logic (below).

If your implementation has a business rule that requires a To Do entry to be created when entering a given BO status and the logic provided by the algorithm type meets the needs of the business rule, this algorithm type may be used. Create an algorithm for the algorithm type, populate the algorithm parameters according to the business rules and plug the new algorithm into the appropriate business object status as an Enter algorithm.

#### Retry Logic

The algorithm type **Retry for To Dos (F1-TODORETRY)** is supplied for a special use case. It is a BO status monitor plug-in and may be used for a state that is a type of ‘error’ or ‘waiting’ state. It relies on the To Do entry creation logic to set a Retry Frequency. The algorithm transitions to the originating state to retry the logic. The idea is that the condition that caused the record to enter the ‘error’ or ‘waiting’ state may be resolved after some period of time has passed, allowing the record to progress in its lifecycle. Refer to the algorithm type description for more information about its logic.

To use this functionality, create an algorithm for this algorithm type, populate the algorithm parameters according to the business rules and plug the new algorithm into the appropriate business object status as a Monitor algorithm. The state should also have an algorithm for the **Generic To Do Creation** algorithm type plugged in as an Enter algorithm (or something equivalent) that sets the appropriate Retry Frequency.

#### To Do Completion

It is common that one or more To Do entries associate with a given record should be completed when exiting a state (if it is not already completed). The system supplies the algorithm type **Generic To Do Completion (F1-TODOCOMPL)** that may be used for this purpose. Note that the algorithm type functionality is not tied to any To Do creation logic. It may be used for any use case where To Do entries should be completed on exiting a state. Refer to the algorithm type description for more information about its functionality and how to prevent certain To Do entries from being automatically completed.

To use this functionality, create an algorithm for this algorithm type, populate the algorithm parameters according to the business rules and plug the new algorithm into the appropriate business object status as an Exit algorithm.

### Submitting a Batch Job

The product provides a base algorithm type that submits a batch job when entering a BO state. This functionality allows for “event driven” batch submission where the event is the lifecycle transition for a certain record.

The algorithm type is **Create Batch Job Submission Entry for Batch Control (F1-SCHEDJOB)**. The batch control code is a parameter for the algorithm. Refer to the algorithm type description for more information about its logic.

To use this functionality, create an algorithm for this algorithm type, populate the algorithm parameter with the batch control that should be submitted and plug the new algorithm into the appropriate business object status as an Enter algorithm.

## Defining Status Reasons

Status Reasons are used to provide more information about why a business object transitioned to a given state. The status reason table provides a centralized place where status reasons can be defined across many different business objects and states.

---

**NOTE:** Refer to [Defining Reasons for Entering a State](#) for overview information.

---

If a business object has one or more states that are configured to capture a status reason, you may configure the valid reasons by navigating to the status reason portal using **Admin > System > Status Reason**.

The topics in this section describe the base-package zones that appear on the Status Reason portal.

### Business Objects with Status Reason List

This zone displays the business objects that have one or more status values that allow status reasons to be defined.

Click the broadcast icon to open other zones that contain more information about the business object's status reasons.

### Status Reasons

The **Status Reasons** zone contains a list of the existing status reasons for the broadcasted business object.

## Business Services

A business service is used to expose a back-end service so that it may be invoked by a script or a zone or a map to retrieve information or perform functions, depending on the related service.

As with the business object, the business service's interface to the internal service is defined using its schema. The schema maps the business service's elements to the corresponding elements in the internal service program's XML document. Just as a business object can simplify the schema of its maintenance object by only defining elements that it needs and "flattening" entries in a child collection to be defined as a singular element, a business service schema may simplify its service XML in a similar way.

---

**FASTPATH:** Refer to [Schema Syntax](#) for a complete list of the XML nodes and attributes available to you when you construct a schema.

---

[Inbound web services](#) and [scripts](#) support interaction with business services. You can also invoke a business service from a Java class.

## Service Program

This transaction defines services available in the system. These include user interface services as well as stand-alone services that perform a specific function. A service may be referenced by a business service. Use this transaction to view existing service and introduce a new stand-alone service to be made available to a Business Service.

Select **Admin > System > Service Program** to maintain service programs.

### Description of Page

**Service Name** is the unique identifier of the service.

---

**CAUTION:** Important! When adding new service programs, carefully consider its naming convention. Refer to [System Data Naming Convention](#) for more information.

---

**Owner** indicates if this service is owned by the base package or by your implementation (**Customer Modification**). The system sets the owner to **Customer Modification** when you add a service. This information is display-only.

**Description** describes the service.

**Application Service** is the application service that is used to provide [security](#) for the service. If the service is related to a maintenance object, the access modes for the application service should be the standard **Add, Change, Delete** and **Inquire**. For other services, the application service should have the **Execute** access mode.

**Service Type** indicates whether the service is a **Java Based Service** or a **Java (Converted) Service**.

This **Program Component** grid shows the list of program user interface components associated with the service. For a stand-alone service, this list is typically not applicable.

#### Where Used

Follow this link to open the data dictionary where you can view the tables that reference [CI\\_MD\\_SVC](#).

## Defining Business Services

The topics in this section describe how to maintain business services.

Note that several context sensitive dashboard zones appear on this page and are visible on all tabs.

- **Schema Tips.** This zone provides several links to launch help topics related to valid schema syntax.
- **Generate Schema.** This zone includes a button that can be used to generate the schema based on the XML of its related Service. Once generated, adjust the schema as desired.

## Business Service - Main

Use this page to define basic information about a Business Service. Open this page using **Admin > System > Business Service**

#### Description of Page

Enter a unique **Business Service** name and **Description**. Use the **Detailed Description** to describe the purpose of this business service in detail. **Owner** indicates if the business service is owned by the base package or by your implementation (**Customer Modification**).

---

**CAUTION:** Important! If you introduce a new business service, carefully consider its naming convention. Refer to [System Data Naming Convention](#) for more information.

---

Enter the internal **Service Name** being called when this business service is invoked.

Enter the **Application Service** that is used to provide security for the business service. The application service must have an Access Mode of Execute.

Click the **View Schema** to view the business service's expanded schema definition. Doing this opens the [schema viewer](#) window.

Click the **View XSD** hyperlink to view the business object's expanded schema definition in XSD format.

Click the **View XML** hyperlink to view the XML document used to pass data to and from the service in the [Service XML Viewer](#). You may find it useful to leave the application viewer window open while defining your business service schema.



---

**NOTE: XML document may not be viewable.** If you create a new service program and do not regenerate the application viewer, you will not be able to view its XML document.

---

### Where Used

Follow this link to open the data dictionary to view the tables that reference [FI\\_BUS\\_SVC](#).

## Business Service - Schema

Use this page to maintain a Business Service's schema and to see where the Business Service is used in the system. Open this page using **Admin > System > Business Service** and then navigate to the **Schema** tab.

### Description of Page

The contents of this section describe the zones that are available on this portal.

The **General Information** zone displays main attributes of the business service.

The [Schema Designer](#) zone allows you to edit the business service's schema. The purpose of the schema is to map the business service's elements to the corresponding fields of the back-end service program it rides on.

---

**NOTE: Generating a Schema** A context sensitive "Generate Schema" zone is associated with this page. The zone provides a button that allows the user to generate a basic schema that includes all the elements that are found in the XML of the BS's service.

---

**FASTPATH:** Refer to [Schema Syntax](#) for a complete list of the XML nodes and attributes available to you when you construct a schema. Also note that the **Schema Tips** zone in the dashboard provides a link to launch this help topic directly.

---

The **Schema Usage Tree** zone summarizes all cross-references to this schema. These may be other schemas, scripts, and web services. For each type of referencing entity, the [tree](#) displays a summary node showing a total count of referencing items. The summary node appears if at least one referencing item exists. Expand the node to list the referencing items and use their description to navigate to their corresponding pages.

## Useful Services and Business Services

The following section highlights some business services and services provided by the product that may be useful for implementations to use.

### Data Explorer Service

The system provides a mechanism for performing an SQL select statement for use in scripting, Java plug-ins, or via a web service call. This is done by creating a zone using one of the data explorer zone types where the SQL is defined. Then, create a business service using the Data Explorer service (**FWLZDEXP**).

---

**NOTE:** There are numerous business services delivered with the base product that reference this service that may be used as a template.

---

The following points highlight how to create your own business service for this service. Note that typically a separate business service exists for each zone.

- Enter a **Business Service** code and a **Description**. It is recommended to define the business service code to match the zone code so that it's easier to manage which business service invokes which zone.
- Select the **Service NameFWLZDEXP**.



- On the **Schema** tab, under the `<schema>` node, enter mapping for the fields that are required for the Data Explorer service:
  - The **Zone** should be mapped into service field **ZONE\_CD**. Define the zone code as the default value.
  - For every **user filter** defined on the zone, create a schema mapping into the service field **Fx\_VALUE**, where "x" is the filter number (from the zone parameters).
  - For every **hidden filter** defined on the zone, create a mapping into the service field **Hx\_VALUE**, where "x" is the filter number (from the zone parameters).
  - The search results are returned as a list by the data explorer service. Each column value is in the service field **COL\_VALUE** with an appropriate sequence number (**SEQNO**). The results can be **flattened** based on sequence number allowing for a logical element name to be defined.
  - Another useful field is **ROW\_CNT**, which provides the number of rows retrieved by your search.

The following is an example of the schema for a BS that receives a business object code and returns a list of status values and their descriptions that allow status reasons to be defined.

```
<schema>
  <zone mapField="ZONE_CD" default="F1-BOSTSLST" />
  <bo mapField="H1_VALUE" />>
  <rowCount mapField="ROW_CNT" />>
  <results type="list" mapList="DE">>
    <status dataType="string" mapField="COL_VALUE">
      <row mapList="DE_VAL">>
        <SEQNO is="1" />>
      </row>>
    </status>>
    <description dataType="string" mapField="COL_VALUE">
      <row mapList="DE_VAL">>
        <SEQNO is="2" />>
      </row>>
    </description>>
  </results>>
</schema>
```

## Maintenance Object Log Service

Many maintenance objects support a log table that follows a pattern of column names and behavior. The system provides a service called Generic MO Log Service (**F1MOLOGP**) that may be used to perform common functions related to log entries:

- Read log entries. If you pass a certain MO, primary key and log sequence number, the service will return the details of that log entry. The product provides a generic business service that may be used for this purpose — Generic MO - Retrieve Log Details (**F1-ReadMOLog**). Alternatively, it is possible to create a business service for a given MO where the MO code is assigned to the MO element using the default syntax. This allows business functionality specific to that maintenance object to use the specific BS.
- Add log. The service may be used to add a log entry. If a user log is added, then the comments from the user are populated in the detailed description. System generated log entries typically supply a message category / message number along with other information such as the status, a specific log type and optionally a related object reference (via a characteristic). The product provides a generic business service that may be used for this purpose — Add Generic MO Log (**F1-AddMOLog**). Alternatively, it is possible to create a business service for a given MO where the MO code is assigned to the MO element using the default syntax. This allows business functionality specific to that maintenance object to use the specific BS.

## Base Business Services

The following table highlights some business services provided by the product that may be useful for custom logic for an implementation.

---

**CAUTION:** This is not intended to be a complete reference of Business Services. Refer to the business service page to find all the supported business services.

---

## Business Object Related Services

Business Service Name	Description
F1-AutoTransitionBO	Performs monitoring algorithms associated with the current state of a given business object instance (which may result in subsequent state transitioning).
F1-CompareBusinessObjectData	Compares two versions of a given business object instance.
F1-DetermineBo	Determines the business object of a given instance of a maintenance object by executing the MO's Determine BO logic.
F1-GetRequiredFieldsForBOState	Returns the required fields for a given business object status.
F1-RetrieveBOOption	Returns BO option values for a given BO and option type.
F1-RetrieveBOStatusOption	Returns BO option values for a given BO, status and option type.
F1-RetrieveBOStatusOption	Retrieves a list of BOs for a given MO that are accessible for the current user.
F1-RetrieveBoStatusDescription	Return the description of a given BO status.
F1-RetrieveBusinessObjectLabel	Return the label appropriate for a given path (e.g. element) within a BO schema.
F1-RetrieveNextStates	Return a list of next possible states based on the input of a MO and its prime key, or a BO and one of its statuses.

## Email Related Services

Business Service Name	Description
F1-EmailService	Sends an email message in real time.
F1-RetrieveEmailAddress	Retrieves the email addresses of users belonging to a To Do Role.
F1-RetrieveEnvironmentURL	Retrieves the current environment URL information for the installation.

## Tools for Maps and Scripting

Business Service Name	Description
F1-DateMath	Performs various date and time math calculations. Refer to the BS description for more details.
F1-DateTimeFormattingService	Formats a given date / time based on the user's display profile settings.
F1-ExecuteScriptInNewSession	Executes a Service Script in a new processing session/transaction.
F1-GetFieldLabel	Retrieves the label for a given field.
F1-GetForeignKeyReference	Returns foreign key reference information for a given FK Reference and primary key, including info description, navigation option, and context menu.

Business Service Name	Description
F1-GetFKReferenceDetails	Returns foreign key reference information for a given MO and primary key, including FK reference code, info description, navigation option, search zone and context menu.
F1-GetLookupDescription	Returns lookup description for a lookup field value given the lookup field name.
F1-GetExtLookUpVal	Returns the list of values for a given extendable lookup BO.
F1-GetMonthInYearAbbreviation	Returns a 3-character month abbreviation for an input date in system format.
F1-NumberAmountFormatter	Formats a given amount or number based on the user's display profile settings. It also may receive input to adjust the scale and optionally apply currency settings.
F1-OutmsgDispatcher	Dispatches a real-time message giving the user the option of whether to persist the message on the database, and whether to trap errors that may take place during the call. Refer to <a href="#">Real Time Messages</a> for more information.
F1-OutmsgMediator	Alternative to <b>F1-OutmsgDispatcher</b> and may be a better option if the sender does not require an outbound message record to be instantiated. Refer to <a href="#">Real Time Messages</a> for more information.
F1-RethrowError	Issues an application error using the input message category / number / parameters.
F1-RetrieveMODescription	Retrieves the description for a maintenance object.
F1-ReturnMessage	Returns the expanded message given a message category, number, parameters, and parameter types.
F1-SavePointDispatcher	Allows for a service script to be executed where exceptions are trapped and the transaction is rolled back to a save point set before the service script execution.

## User Related Services

Business Service Name	Comments
F1-CheckApplicationSecurity	Checks a user's security for a given application service / access mode
F1-CheckUserAuthorization	Determine whether a given user is authorized for access based on the input application service, security code, and authorization level.
F1-DeterminelfUserCanApproveTD	Determine if the current user can approve a given To Do.

## User Interface (UI) Maps

The User Interface (UI) map holds HTML to be rendered within [portal zones](#) and [Business Process Assistant \(BPA\) scripts](#). UI maps allow your implementation to create input forms and output maps that closely match your customer's business practices. In other words, the UI Map is designed to facilitate the capture and display of your [business objects](#) and [business services](#).

The UI map is a repository for a single HTML document paired with an XML schema where the schema defines the data that the HTML document displays and/or modifies. The UI Map HTML gives you the ability to craft the display by any method that an html document can support, including JavaScript and full CSS functionality.

Configuration tool support for UI Maps hinges around the ability to inject and extract an XML document from the HTML. For more information on the specialized support for HTML and JavaScript functionality refer to [UI Map Attributes and Functions](#).

```

<html>
<head>
<title>Output Personal Information</title>
<link rel="stylesheet" type="text/css" href="cm_templates/cmStyles.css"/>
</head>
<body>

<table width="100%" border="0" cellpadding="2" style="margin-top:15px;" >

  <tr>
    <td/>
    <td/> <!-- locate the edit button on the bottom of the third column -->
    <td rowspan="99" style="vertical-align:bottom; margin-left:5px">
      <input type="button" value="edit" onClick="oraRunScript('HumanInfoU', 'personId');"/>
    </td>
  </tr>

  <tr>
    <td class="outputLabel">Name:</td>
    <td><span oraField="name" class="outputData"></span></td>
  </tr>
  <tr>
    <td class="outputLabel">Home Phone:</td>
    <td><span oraField="homePhone" class="outputData"></span></td>
  </tr>
  <tr>
    <td class="outputLabel">Business Phone:</td>
    <td><span oraField="businessPhone" class="outputData"></span></td>
  </tr>
  <tr>
    <td class="outputLabel">Cell Phone:</td>
    <td><span oraField="cellPhone" class="outputData"></span></td>
  </tr>
  <tr>
    <td class="outputLabel">FAX:</td>
    <td><span oraField="fax" class="outputData"></span></td>
  </tr>
  <tr>
    <td class="outputLabel">Social Security:</td>
    <td><span oraField="socialSecurity" class="outputData"></span></td>
  </tr>
  <tr>
    <td class="outputLabel">Drivers License:</td>
    <td><span oraField="driversLicense" class="outputData"></span></td>
  </tr>
  <tr>
    <td class="outputLabel">Email:</td>
    <td><span oraField="email" class="outputData"></span></td>
  </tr>
</table>

</body>

<xml>
<root>
  <name>Greer, Johan</name>
  <email>jurgen.greer@media.com</email>
  <socialSecurity>939-30-3939</socialSecurity>
  <driversLicense>C8392020</driversLicense>
  <homePhone>(838) 030-0303</homePhone>
  <cellPhone>(444) 444-4040</cellPhone>
  <businessPhone>(737) 393-3838</businessPhone>
  <fax>(373) 939-3939</fax>
  <personId>1239997654</personId>
</root>
</xml>
</html>

```

Figure 1: HTML to Display Customer Business Object

Name:	<b>Greer,Johan</b>	
Home Phone:	<b>(838) 030-0303</b>	
Business Phone:	<b>(737) 393-3838</b>	
Cell Phone:	<b>(444) 444-4040</b>	
FAX:	<b>(373) 939-3939</b>	
Social Security:	<b>939-30-3939</b>	
Drivers License:	<b>C8392020</b>	
Email:	<b>jurgen.greer@media.com</b>	<input type="button" value="edit"/>

Figure 2: Customer HTML Rendered (Output Data for Zone)

UI maps are typically crafted as output tables when used in conjunction with portal zones - please refer to [Map Zones](#) for more information. When referenced within [BPA scripts](#), UI maps are typically crafted as forms for the capture and update of data.

**Edit Personal Information**

[err](#)

**Name:**   
Last-name suffix, prefix first-name middle-name/initial

**Home Phone:**   -

**Business Phone:**   -

**Cell Phone:**   -

**FAX:**   -

**Social Security:**  -  -

**Drivers License:**

**Email:**

Figure 3: HTML Input Form Rendered (for BPA Script)

Portal zones can reference a UI map for the zone header. They may also utilize a UI map to define their filter area. This type of UI map is not a complete HTML document, but is instead configured as a UI Map "fragment".

---

**NOTE:** UI Map Tips. A context sensitive "UI Map Tips" zone is visible on the UI map maintenance page. This zone provides several links to launch help topics related to valid schema syntax and UI Hint syntax in one click.

---

**NOTE:** Editing HTML. You can use a variety of HTML editors to compose your HTML, which you can then cut, and paste into your UI map. In addition, the zone provides a complete list of the XML schema nodes and attributes available to you when you construct the map's data schema.

---

## Defining UI Maps

The topics in this section describe how to maintain UI Maps.

## UI Map - Main

Use this page to define basic information about a user interface (UI) Map. Open this page using **Admin > System > UI Map**

### Description of Page

Enter a unique **Map** name. **Owner** indicates if the UI map is owned by the base package or by your implementation (**Customer Modification**).

---

**CAUTION:** Important! If you introduce a new UI map, carefully consider its naming convention. Refer to [System Data Naming Convention](#) for more information.

---

Use **UI Map Type** to indicate whether the map is a **Complete XHTML Document**, **Complete HTML Document**, **XHTML Fragment** or an **HTML Fragment**. The default value is **Complete XHTML Document**.

Enter a **Description**. Use the **Detailed Description** to describe how this map is used in detail.

Click on the **View Schema** to view the UI map's expanded schema definition. Doing this opens the [schema viewer](#) window.

Use the **Test UI Map** hyperlink to render your HTML in a test window.

---

**NOTE:** The **Test UI Map** hyperlink also exercises the proprietary functionality that binds an XML element with an HTML element so you can get immediate feedback on your HTML syntax.

---

### Where Used

Follow this link to open the data dictionary to view the tables that reference [FI\\_MAP](#).

## UI Map - Schema

Use this page to maintain a UI Map's HTML and schema and to see where the UI Map is used in the system. Open this page using **Admin > System > UI Map** and then navigate to the **Schema** tab.

### Description of Page

The contents of this section describe the zones that are available on this portal.

The **General Information** zone displays main attributes of the UI Map.

The **HTML Editor** zone allows you to edit the HTML document of the map.

---

**NOTE:** Refer to [UI Map Attributes and Functions](#) and [UI Map Standards](#) for more information about HTML definition syntax. These topics describe good ways to produce simple HTML, however, they are not an HTML reference. Note that you can use a variety of HTML editors to compose your HTML, which you can then cut and paste into your UI map.

---

**NOTE: Providing Help.** A [tool tip](#) can be used to display additional help information to the user. This applies to section elements as well as individual elements on a map. Refer to [UI Map Attributes and Functions](#) for more information on how to enable and provide UI map help.

---

The [Schema Designer](#) zone allows you to edit the data schema part of the map. The purpose of the schema is to describe the data elements being displayed by the map.

---

**FASTPATH:** Refer to [Schema Syntax](#) for a complete list of the XML nodes and attributes available to you when you construct a schema. Also note that the **UI Map Tips** zone in the dashboard provides a link to launch this help topic directly.

---

The **Schema Usage Tree** zone summarizes all cross-references to this schema. These may be other schemas, scripts, and web services. For each type of referencing entity, the [tree](#) displays a summary node showing a total count of referencing items. The summary node appears if at least one referencing item exists. Expand the node to list the referencing items and use their description to navigate to their corresponding pages.

## UI Map Attributes and Functions

---

**NOTE:** This topic uses the term "field" to refer to both the generic concept of displaying and capturing data in a 'field' as well as referring to the meta-data object supplied in the product to define [Fields](#). When referring to the latter, the term "MD Field" (meta-data Field) is used and a hyperlink to the Field documentation is provided.

---

### Contents

- [Bind XML to HTML](#)
- [Build a Dropdown List](#)
- [Format Input and Output Fields](#)
- [Display Labels](#)
- [Enable UI Map Help](#)
- [Search Using a Pop-Up Explorer Zone](#)
- [Display Errors](#)
- [Fire JavaScript for Browser Events](#)
- [Hide Elements](#)
- [Invoke Schema Based Services](#)
- [Refresh a Rendered Map or Portal Page](#)
- [Embed Framework Navigation](#)
- [Launch BPA Script](#)
- [Exit UI Map with Bound Values](#)
- [Include a Map Fragment](#)
- [Show Schema Default on Add](#)
- [Configure a Chart](#)
- [Upload and Download a CSV File](#)
- [Construct Portal Zone Map Fragments](#)
- [Required JavaScript Libraries](#)
- [Detecting Unsaved Changes](#)
- [Hiding Portal Tabs](#)

### Bind XML to HTML

Only two different attributes are required to bind a UI Map's XML to its HTML. Both of these attributes require an XML document embedded within the HTML, where the XML is bounded by <xml> nodes.

---

**WARNING:** You must embed a pair of <xml></xml> tags within your HTML document for binding to occur.

---

### Linking a Field

Syntax	Values	Description
oraField=" "	Field element XPath	This attribute is used to link an HTML element directly with an XML element, where the XML element is defined within the UI Map's XML schema. The attribute can be used with any <i>rendering</i> HTML element, such as: <span>, <div>, and <input>.

---

- HTML for input element:

```

<html>
<body>
<table>
  <tr>
    <td>Address:</td>
    <td><input type="text" oraField="address"/></td>
  </tr>
  <tr>
    <td>City:</td>
    <td><input type="text" oraField="city"/></td>
  </tr>
  <tr>
    <td>State:</td>
    <td><input type="text" oraField="state"/></td>
  </tr>
  <tr>
    <td>Zip:</td>
    <td><input type="text" oraField="zip"/></td>
  </tr>
</table>
</body>
<xml>
  <root>
    <address>123 Main St</address>
    <city>Alameda</city>
    <state>CA</state>
    <zip>94770</zip>
  </root>
</xml>
</html>

```

#### Rendered HTML

Address:	<input type="text" value="123 Main St"/>
City:	<input type="text" value="Alameda"/>
State:	<input type="text" value="CA"/>
Zip:	<input type="text" value="94770"/>

- HTML for span and div elements:

```

<html>
<body>

<div oraField="address"></div>
<span oraField="city"></span>
<span>,</span>
<span oraField="state"></span>
<span oraField="zip"></span>
<span oraField="country"></span>

</body>
<xml>
  <root>
    <address>123 Main St</address>
    <city>Alameda</city>
    <state>CA</state>
    <zip>94770</zip>
  </root>
</xml>
</html>

```

#### HTML rendered:



## Linking a List

This attribute is used to link an HTML table with an XML list, where the XML list is defined within the UI Map's XML schema. The purpose of the element is to trigger the framework to replicate the table's HTML for each occurrence of the list.

Syntax	Values	Description
oraList=" "	List element XPath	This attribute is used to link an HTML table with an XML list, where the XML list is defined within the UI Map's XML schema. The purpose of the element is to trigger the framework to replicate the table's HTML for each occurrence of the list.

**NOTE:** The oraField attributes embedded within the list must contain XPath navigation relative to the list. See below for an example.

```
<html>
<head><title>Bind xml list element</title></head>
<body>
<table oraList="payment">
  <thead>
    <tr>
      <th><span>Pay Date</span></th>
      <th><span>Amount</span></th>
    </tr>
  </thead>
  <tr>
    <td>
      <span oraField="date" oraType="date"></span>
    </td>
    <td align="right">
      <span oraField="amount" oraType="money"></span>
    </td>
  </tr>
</table>
</body>
<xml>
<root>
  <payment>
    <date>2008-01-01</date>
    <amount>44.28</amount>
  </payment>
  <payment>
    <date>2008-02-01</date>
    <amount>32.87</amount>
  </payment>
  <payment>
    <date>2008-03-01</date>
    <amount>21.76</amount>
  </payment>
</root>
</xml>
</html>
```

HTML rendered:

Pay Date	Amount
01-01-2008	\$44.28
02-01-2008	\$32.87
03-01-2008	\$21.76

## Build a Dropdown List

The following attributes are provided to build an HTML 'select' element, also called a dropdown, based on various sources.

Source	Syntax	Values	Examples
Lookup	oraSelect="lookup: ;"	Lookup field	<pre>... &lt;td&gt;House Type:&lt;/td&gt; &lt;td&gt;   &lt;select oraField="houseType" oraSelect="lookup:HOUSE_TYPE;"&gt; &lt;/select&gt; &lt;/td&gt;</pre>
Extendable Lookup	oraSelect="lookupBO: ;"	BO code	<pre>... &lt;td&gt;UI Device Display Type:&lt;/ td&gt; &lt;td&gt;   &lt;select oraField="uiDeviceType" oraSelect="lookupBO: F1- DeviceDisplayTypes;"&gt;&lt;/ select&gt; &lt;/td&gt;</pre>
Characteristic Type (pre-defined)	oraSelect="charType: ;"	Characteristic Type code	<pre>... &lt;td&gt;Usage:&lt;/td&gt; &lt;td&gt;   &lt;select oraField="statusReasonUsage" oraSelect="charType:F1- SRUSG;"&gt;&lt;/select&gt; &lt;/td&gt; ...</pre>
Control Table	oraSelect="table: ;"  <b>NOTE:</b> This attribute only works with tables that follow the standard control table structure where there is a related language table that includes that includes the column <b>DESCR</b> as its description column. Use the Application Viewer data dictionary to identify tables that qualify for this functionality.  <b>WARNING:</b> The oraSelect function will only work if less than 500 values are displayed.	Table name	<pre>... &lt;td&gt;Currency: &lt;/td&gt; &lt;td&gt;   &lt;select oraField="currency" oraSelect="table:CI_CURRENCY_CD;"&gt; &lt;/select&gt; &lt;/td&gt; ...</pre>
Page Service	oraSelect="service: ;"	Page Service name	<pre>... &lt;td&gt;Country:&lt;/td&gt; &lt;td&gt;   &lt;select oraField="country" oraSelect="service:CIPTCNTW;"&gt; &lt;/select&gt; &lt;/td&gt;</pre>

Source	Syntax	Values	Examples
Embedded List	Used to build a select dropdown based on a list within the map's XML. oraSelect="valuePath: ;descPath: ;"	After the valuePath, indicate the XPath of the element that holds the values. After the descPath, indicate the XPath of the element that holds the descriptions.	<pre> ... &lt;html&gt; &lt;body&gt; &lt;table summary="" border="0" cellpadding="1" cellspacing="1"&gt;   &lt;tr&gt;     &lt;td&gt;Select: &lt;/td&gt;     &lt;td&gt;&lt;select oraSelect= "valuePath:list/value; descPath:list/desc" oraField="target"&gt;&lt;/ select&gt;&lt;/td&gt;   &lt;/tr&gt; &lt;/table&gt; &lt;/body&gt; &lt;xml&gt; &lt;root&gt; &lt;target&gt;10&lt;/target&gt;   &lt;list&gt;     &lt;value&gt;10&lt;/value&gt;     &lt;desc&gt;Ten&lt;/desc&gt;   &lt;/list&gt;   &lt;list&gt;     &lt;value&gt;20&lt;/value&gt;     &lt;desc&gt;Twenty&lt;/ desc&gt;   &lt;/list&gt;   &lt;list&gt;     &lt;value&gt;40&lt;/value&gt;     &lt;desc&gt;Forty&lt;/desc&gt;   &lt;/list&gt; &lt;/root&gt; &lt;/xml&gt; &lt;/html&gt; </pre>
Service Script	oraSelect="ss: ;"	Service Script code	See below for additional syntax needed when using this function.
Business Service	oraSelect="bs: ;"	Business Service code	See below for additional syntax needed when using this function.

When specifying a service script or a business service, extra mapping information is needed to pass data to and from the service.

Syntax	Values	Description
oraSelectIn=" ;"	serviceXPath:element;  serviceXPath:'Literal';	Used to pass the value of another element into the service (mapping to the service's XPath).  Used to pass a constant or literal to the service (mapping to the service's XPath).
oraSelectOut="valuePath: ; descPath: ;"	See examples below	Used to indicate which element in the service's output holds the values and which one holds the descriptions.

Example using a business service:

```

...
<td>External System: </td>
<td>
  <select oraField="externalSystem" oraSelect="bs:F1-RetrieveExternalSystems"
oraSelectIn="outboundMsgType:boGroup/parameters/
outboundMsgType;" oraSelectOut="valuePath:results/externalSystem;
descPath:results/description"></select>
</td>
...

```

This method for building dropdowns is often used when there is a dependency between elements and the list of valid values in a dropdown (for the child element) is based on another element in the map (the parent element). When the parent element is changed, it may be required to refresh the child element. This behavior can be implemented using the function called within an **onChange** event in the map. The syntax is **oraHandleDependentElements('dependent element');** Multiple target elements (dependents) can be named.

The following example is related to the above business service example where the list of external systems is specific for a given outbound message type, which is passed in as input. The snippet below shows the configuration for the outbound message type element to trigger a refresh of the external system's dropdown list.

```
...
<div>
  <label oraLabel="boGroup/parameters/outboundMsgType"></label>
  <span>
    <select oraSelect="table:F1_OUTMSG_TYPE" oraField="boGroup/parameters/outboundMsgType"
onChange="oraHandleDependentElements('boGroup/parameters/externalSystem');"></select>
  </span>
</div>
...
```

## Format Input and Output Fields

The following attributes are designed to apply data type formatting for input and output fields.

### Automatic Formatting

---

#### Syntax

```
oraSchemaDataTypes="false"
```

---



---

This attribute is used to trigger automatic formatting in the rendered HTML document. The automated formatting will occur according to the data type attributes defined in the UI map's schema. For details on specific data type formatting, please refer to the `oraType` attribute descriptions below.

**WARNING:** The attribute `oraSchemaDataTypes="true"` will be automatically injected into the UI map's HTML! If you do not wish to apply the schema's data types to the rendered HTML then you must specify this attribute in the body node with a value of false. The attribute `<body oraSchemaDataTypes="false">` is required to avoid automatic formatting!

- UI Map schema:

```
<schema>
  <schemaDate dataType="date"/>
  <schemaDateTime dataType="dateTime"/>
  <schemaFKRef fkRef="CI_USER"/>
  <schemaLookup dataType="lookup" lookup="ACCESS_MODE"/>
  <schemaMoney dataType="money"/>
  <schemaNumber dataType="number"/>
  <schemaTime dataType="time"/>
</schema>
```

- UI Map HTML:

```
<html>
<body oraSchemaDataTypes="true">
<table border="1" cellpadding="1" cellspacing="1">
<tr><th>dataType</th><th>result type</th><th>input result</th><th> display-only result</th></tr>
<tr>
  <td rowspan="2">date (from schema)</td>
<td>raw</td>
<td><input oraField="schemaDate" oraType="string" /></td>
<td><span oraField="schemaDate" oraType="string"></span></td>
```

```

    </tr>
    <tr>
<td>rendered</td>
    <td><input oraField="schemaDate"></td>
<td><span oraField="schemaDate"></span></td>
    </tr>

    <tr>
    <td rowspan="2">dateTime (from schema)</td>
<td>raw</td>
<td><input oraField="schemaDateTime" oraType="string"></td>
    <td><span oraField="schemaDateTime" oraType="string"></span></td>
    </tr>
    <tr>
<td>rendered</td>
<td><input oraField="schemaDateTime"></td>
<td><span oraField="schemaDateTime"></span></td>
    </tr>

    <tr>
    <td rowspan="2">fkRef (from schema)**</td>
<td>raw</td>
<td><input oraField="schemaFkRef" oraType="string"></td>
<td><span oraField="schemaFkRef" oraType="string"></span></td>
    </tr>
    <tr>
<td>rendered</td>
<td><input oraField="schemaFkRef"></td>
<td><span oraField="schemaFkRef"></span></td>
    </tr>

    <tr>
    <td rowspan="2">lookup (from schema)</td>
<td>raw</td>
<td><input oraField="schemaLookup" oraType="string"></td>
<td><span oraField="schemaLookup" oraType="string"></span></td>
    </tr>
    <tr>
<td>rendered</td>
<td><input oraField="schemaLookup"></td>
<td><span oraField="schemaLookup"></span></td>
    </tr>

    <tr>
    <td rowspan="2">money (from schema)</td>
<td>raw</td>
<td><input oraField="schemaMoney" oraType="string"></td>
<td><span oraField="schemaMoney" oraType="string"></span></td>
    </tr>
    <tr>
<td>rendered</td>
<td><input oraField="schemaMoney"></td>
<td><span oraField="schemaMoney"></span></td>
    </tr>

    <tr>
    <td rowspan="2">number (from schema)</td>
<td>raw</td>
<td><input oraField="schemaNumber" oraType="string"/></td>
<td><span oraField="schemaNumber" oraType="string"></span></td>
    </tr>
    <tr>
<td>rendered</td>
<td><input oraField="schemaNumber"></td>
<td><span oraField="schemaNumber"></span></td>
    </tr>

    <tr>
    <td rowspan="2">time (from schema)</td>
<td>raw</td>
<td><input oraField="schemaTime" oraType="string"></span></td>
<td><span oraField="schemaTime" oraType="string"></span></td>

```

```

    </tr>
    <tr>
<td>rendered</td>
<td><input oraField="schemaTime"></td>
<td><span oraField="schemaTime"></span></td>
    </tr>
</table>

</body>
<xml>
<root>
<schemaDate>2007-11-02</schemaDate>
<schemaDateTime>2007-11-02-23.45.00</schemaDateTime>
<schemaFkRef>USD</schemaFkRef>
<schemaLookup>A</schemaLookup>
<schemaMoney>1000000</schemaMoney>
<schemaNumber>5661976.11548</schemaNumber>
<schemaTime>23.45.00</schemaTime>
</root>
</xml>
</html>

```

HTML rendered.

dataType	result type	input result		display-only result
date	raw	<input type="text" value="2007-11-02"/>		2007-11-02
	rendered	<input type="text" value="11-02-2007"/>		11-02-2007
dateTime	raw	<input type="text" value="2007-11-02-23.45.00"/>		2007-11-02-23.45.00
	rendered	<input type="text" value="11-02-2007"/>	<input type="text" value="11:45PM"/>	11-02-2007 11:45PM
fkRef	raw	<input type="text" value="SYSUSER"/>		SYSUSER
	rendered	<input type="text" value="SYSUSER"/>		SYSUSER
lookup	raw	<input type="text" value="A"/>		A
	rendered	<input type="text" value="Add"/>		Add
money	raw	<input type="text" value="1000000"/>		1000000
	rendered	<input type="text" value="\$1,000,000.00"/>		\$1,000,000.00
number	raw	<input type="text" value="5661976.11548"/>		5661976.11548
	rendered	<input type="text" value="5,661,976.11548"/>		5,661,976.11548
time	raw	<input type="text" value="23.45.00"/>		23.45.00
	rendered	<input type="text" value="11:45PM"/>		11:45PM

## Date Formatting

This function is used to display a date according to the user's display profile. For input fields, the setting formats the data when the user tabs out of the field.

---

### Syntax

---

**oraType="date"**

---



---

```

<html>
<body>
<table summary="" border="0" cellpadding="1" cellspacing="1">
  <tr>
    <td>Date: </td>

```

```

<td><span oraField="date" oraType="date"></span></td>
</tr>
<tr>
  <td>Date: </td>
<td><input oraField="date" oraType="date" /></td>
</tr>
</table>
</body>
<xml>
<root>
<date>2008-12-28</date>
</root>
</xml>
</html>

```

HTML rendered.

Date: 12-28-2008

Date:

## Time Formatting

This function is used to display a time according to the user's display profile. For input fields, the setting formats the data when the user tabs out of the field.

---

### Syntax

---

**oraType="time"**

---



---

```

<html>
<body>
<table summary="" border="0" cellpadding="1" cellspacing="1">
  <tr>
    <td>Time: </td>
  <td><span oraField="time" oraType="time"></span></td>
  </tr>
  <tr>
    <td>Time: </td>
  <td><input oraField="time" oraType="time" /></td>
  </tr>
</table>
</body>
<xml>
<root>
<time>00.28.54.389</time>
</root>
</xml>
</html>

```

HTML rendered.

Time: 12:28AM

Time:

## Date and Time Formatting

This function is used to display a timestamp according to the user's display profile. If this function is used for an input element, it is broken into two pieces, one for [date](#) and one for [time](#). Optionally, the time portion of the date time element can be suppressed using the attribute value 'time:suppress'.

---

### Syntax

---

**oraType="dateTime; time:suppress"**

---

## Syntax

---

---

```
<html>
<body>
<table summary="" border="0" cellpadding="1" cellspacing="1">
  <tr>
    <td>Date time: </td>
    <td><span oraField="dateTime" oraType="dateTime"></span></td>
  </tr>
  <tr>
    <td>Date only: </td>
    <td><span oraField="dateTime" oraType="dateTime; time:suppress"></span></td>
  </tr>
  <tr>
    <td>Date time: </td>
    <td><input oraField="dateTime" oraType="dateTime" /></td>
  </tr>
  <tr>
    <td>Date only: </td>
    <td><input oraField="dateTime" oraType="dateTime; time:suppress" /></td>
  </tr>
</table>
</body>
<xml>
<root>
<dateTime>2009-11-01-00.28.54</dateTime>
</root>
</xml>
</html>
```

HTML rendered.

Date time: 11-01-2009 12:28AM

Date only: 11-01-2009

Date time:

Date only:

## Date / Time Formatting with Standard Time

This true function is used to render a date / time element according to the daylight savings time schedule of the 'base' time zone. The 'base' time zone is specified on the Installation table and represents the database time zone. For input elements with this setting, all time entered is assumed to correspond with the daylight savings time schedule of the base time zone. If a time is entered that cannot be unambiguously translated to standard time, then the user will be required to provide a time zone label to indicate whether daylight savings time, or standard time, has been entered.

---

## Syntax

---

---

**oraType="dateTime; stdTime:true;"**

---

---

```
<html>
<body>
<table summary="" border="0" cellpadding="1" cellspacing="1">
  <tr>
    <td>Date time: </td>
    <td><span oraField="dateTime" oraType="dateTime; stdTime:true;"></span></td>
  </tr>
  <tr>
    <td>Date time: </td>
    <td><input oraField="dateTime" oraType="dateTime; stdTime:true;" /></td>
  </tr>
</table>
</body>
<xml>
```



```

<root>
<dateTime>2009-11-01-00.28.54</dateTime>
</root>
</xml>
</html>

```

HTML rendered.

**NOTE:** The time zone label is displayed because 1:28 is ambiguous otherwise. Legally, November 1, 2009 1:28 AM occurs twice because daylight savings time (DST) is removed at 2:00 AM. With the stdTime function time zone labels are only displayed when required to clarify time overlaps.

Date time: 11-01-2009 01:28AM PDT

Date time:	11-01-2009	01:28AM PDT
------------	------------	-------------

HTML rendered for the following day.

Date time: 11-02-2009 12:28AM

Date time:	11-02-2009	12:28AM
------------	------------	---------

## Date and Time Formatting with Time Zone Reference

Syntax	Valid Values	Description
<code>oraType="dateTime; stdTimeRef: ;"</code>	Reference an XPath after the colon.	This function is used to render a date / time element according to the daylight savings time schedule of a time zone whose XPath is referenced. Note that the time processed is assumed to have been stored in the standard time of the referenced time zone - so only daylight savings time shifting will execute - not time zone shifting.
<code>oraType="dateTime; displayRef: ;"</code>	Reference an XPath after the colon.	This function is similar to the stdTimeRef function, except that this function will execute time zone shifting in addition to daylight savings time shifting. To use displayRef correctly, only associate it with time zone elements that have been stored in the base time zone.

For input elements, all time entered is assumed to correspond with the daylight savings time schedule of the referenced time zone. If a time is entered that cannot be unambiguously translated to standard time, then the user will be required to provide a time zone label to indicate whether daylight savings time, or standard time, has been entered.

```

<html>
<body>
<table summary="" border="0" cellpadding="1" cellspacing="1">
  <tr>
    <td>Date time: </td>
    <td><span oraField="dateTime" oraType="dateTime; stdTimeRef:timeZone;"></span></td>
  </tr>
  <tr>
    <td>Date time: </td>
    <td><input oraField="dateTime" oraType="dateTime; stdTimeRef:timeZone;" /></td>
  </tr>
</table>
</body>
<xml>
<root>
<timeZone>US-EAST</timeZone>

```

```
<dateTime>2009-11-01-00.28.54</dateTime>
</root>
</xml>
</html>
```

HTML rendered.

---

**NOTE:** The time zone label is always displayed for a referenced time zone.

---

Date time: 11-01-2009 01:28AM EDT

Date time:

HTML rendered for the following day.

Date time: 11-02-2009 12:28AM EST

Date time:

## Duration Formatting

---

### Syntax

---

**oraType="duration"**

---

---

This function is used to display time duration. For an input element, the value entered by the user is translated from minutes to hour and minutes as appropriate. For example, an entered value of '90', is converted to '00:01:30' when tabbing out of the input field.

```
<html>
<body>
<table summary="" border="0" cellpadding="1" cellspacing="1">
  <tr>
    <td>Duration: </td>
    <td><span oraField="duration" oraType="duration"></span></td>
  </tr>
  <tr>
    <td>Duration: </td>
    <td><input oraField="duration" oraType="duration" /></td>
  </tr>
</table>
</body>
<xml>
<root>
<duration>90</duration>
</root>
</xml>
</html>
```

HTML rendered.

Duration: 00:01:30

Duration:

## Day in Month Formatting

---

### Syntax

---

**oraType="dayInMonth"**

---

---

This function is used to display a concatenated day and month.

```
<html>
<body>
```

```

<table summary="" border="0" cellpadding="1" cellspacing="1">
  <tr>
    <td>Day In Month: </td>
  <td><span oraField="dayMonth" oraType="dayInMonth"></span></td>
  </tr>
  <tr>
    <td>Day In Month: </td>
  <td><input oraField="dayMonth" oraType="dayInMonth" /></td>
  </tr>
</table>
</body>
<xml>
<root>
<dayMonth>0228</dayMonth>
</root>
</xml>
</html>

```

HTML rendered.

Day In Month: 02-28

Day In Month:

## Month In Year Formatting

### Syntax

---

**oraType="monthInYear"**

---



---

This function is used to display a concatenated month and year.

```

<html>
<body>
<table summary="" border="0" cellpadding="1" cellspacing="1">
  <tr>
    <td>Month In Year: </td>
  <td><span oraField="month" oraType="monthInYear"></span></td>
  </tr>
  <tr>
    <td>Month In Year: </td>
  <td><input oraField="month" oraType="monthInYear" /></td>
  </tr>
</table>
</body>
<xml>
<root>
<month>200811</month>
</root>
</xml>
</html>

```

HTML rendered.

Month In Year: 11-2008

Month In Year:

## Monetary Formatting

This function is used to display a number as a monetary amount. See the table for configuration options with respect to the currency. For input elements, an error is issued if a non-numeric value is entered.

### Syntax

### Description

---

**oraType="money: "**

Directly specify a currency code after the colon.

---

## Syntax

## Description

`oraType="money;currencyRef: "`

Reference an XPath (after the colon) for an element that references a currency code.

`oraType="money"`

If no currency or currency reference is specified, the installation currency is used.

**NOTE:** You must specify a pair of stylesheet references, `cisEnabled` and `cisDisabled`, in the map's header for right alignment. The stylesheet controls how the field will be rendered. If you want to alter the rendering you must override the `oraMoney` style.

```
<html>
<head>
  <link rel="stylesheet" type="text/css" href="cisDisabled.css"/>
  <link rel="stylesheet" type="text/css" href="cisEnabled.css"/>
</head>
<body>
<table summary="" border="1" cellpadding="1" cellspacing="1">
  <tr>
    <td>Amount, currency specified:</td>
  <td><span oraType="money:EUR" oraField="totalAmt"></span></td>
  </tr>
  <tr>
    <td>Amount, default currency:</td>
  <td><span oraType="money" oraField="totalAmt"></span></td>
  </tr>
  <tr>
    <td>Amount, default input:</td>
  <td><input oraType="money" oraField="totalAmt"/></td>
  </tr>
  <tr>
    <td>Amount, currency reference:</td>
  <td><input oraType="money;currencyRef:cur" oraField="totalAmt"/></td>
  </tr>
</table>
</body>
<xml>
<root>
<totalAmt>50500.09</totalAmt>
<cur>EUR</cur>
</root>
</xml>
</html>
```

HTML rendered

```
Amount, currency specified: €50,500.09
Amount, default currency: $50,500.09
Amount, default input: 
Amount, currency referenced:€50,500.09
```

## Number Formatting

This function is used to display a number or validate an input value. For input elements, the system will return an error if a non-numeric value is entered.

## Syntax

`oraType="number"`

---

**NOTE:** You must specify a pair of stylesheet references, `cisEnabled` and `cisDisabled`, in the map's header for right alignment. The stylesheet controls how the field will be rendered. If you want to alter the rendering you must override the `oraNumber` style.

---

```
<html>
<head>
  <link rel="stylesheet" type="text/css" href="cisDisabled.css"/>
  <link rel="stylesheet" type="text/css" href="cisEnabled.css"/>
</head>
<body>
<table summary="" border="1" cellpadding="1" cellspacing="1">
  <tr>
<td>Count:</td>
<td><span oraType="number" oraField="count"></span></td>
  </tr>
  <tr>
    <td>Count, input:</td>
<td><input oraType="number" oraField="count"/></td>
  </tr>
</table>
</body>
<xml>
<root>
<count>989</count>
</root>
</xml>
</html>
```

HTML rendered.

Count:	989
Count, input:	<input type="text" value="989"/>

## FK Reference Formatting

By default, when an element with an **fkRef** `oraType` is displayed, an info string, context menu, navigation, and search are enabled (if the FK reference has been configured accordingly). Syntax is provided to allow you to selectively turn off any of these features.

Note that you can enable the foreign key hyperlink separately as well, refer to [Embed Framework Navigation](#) for more information. The various attributes used to control foreign key reference functionality are as follows. Note that in every case, the default value is **true**. A value of **false** should be used to disable the feature.

---

### Syntax

---

`oraType="fkRef:true|false; info:true|false; context:true|false; navigation:true|false; search:true|false"`

---

---

- **fkRef.** A value of 'true' enables all of the following foreign key reference processing. Use a value of 'false' to disable automatic FK Reference processing.
- **info.** A value of 'true' renders an [information string](#) on the UI map, if applicable.
- **context.** A value of 'true' renders a context menu to appear before the foreign key reference element, if applicable.
- **navigation.** A value of 'true' causes the information string to be rendered as a hyperlink, if applicable. Clicking the hyperlink [navigates](#) to the appropriate page.
- **search.** A value of 'true' displays a search icon that launches the [search zone](#) if applicable.

---

**NOTE:** Foreign key navigation and context menu functionality is only available for UI maps presented in a portal zone. UI Maps presented during BPA script processing cannot support navigation options. Search functionality is only available for input HTML elements.

---

- UI Map schema:

```
<schema>
  <userId fkRef="CI_USER" />
</schema>
```

- UI Map HTML:

```
<html>
<body>
<table summary="" border="1" cellpadding="1" cellspacing="1">
  <tr>
<td>User</td>
<td><span oraField="userId" oraType="fkRef:true; info:true; context:true; navigation:true;"></span></td>
  </tr>
</table>
</body>
<xml>
<root>
<userId>CZAAND</userId>
</root>
</xml>
</html>
```

- HTML rendered.

User  [Andrada,Czarina](#)

## Lookup Formatting

This function is used to display the description of a lookup value.

Syntax	Valid Values
<code>oraType="lookup: "</code>	Lookup field name after the colon.

```
<html>
<body>
<table summary="" border="1" cellpadding="1" cellspacing="1">
  <tr>
<td>Status:</td>
<td><span oraField="status" oraType="lookup: BATCH_JOB_STAT_FLG"></span></td>
  </tr>
</table>
</body>
<xml>
<root>
  <status>PD</status>
</root>
</xml>
</html>
```

HTML rendered.

Status: Pending

## Extendable Lookup Formatting

This function is used to display the description of an extendable lookup value.

Syntax	Valid Values
<code>oraType="lookupBO: "</code>	Business Object code name after the colon.

```
<html>
<body>
<table summary="" border="1" cellpadding="1" cellspacing="1">
  <tr>
    <td>Status:</td>
    <td><span oraField="status" oraType="lookupBO:F1-DeviceDisplayTypes"></span></td>
  </tr>
</table>
</body>
</html>
<xml>
<root>
  <status>PD</status>
</root>
</xml>
</html>
```

HTML rendered.

Status: Pending

## Characteristic Type Formatting

This function is used to display the description of a predefined characteristic value.

Syntax	Valid Values
<code>oraType="charType: "</code>	Characteristic Type code after the colon.

```
<html>
<body>
<table summary="" border="1" cellpadding="1" cellspacing="1">
  <tr>
    <td>Skill:</td>
    <td><span oraType="charType:CM-SKILL" oraField="skill"></span></td>
  </tr>
</table>
</body>
</html>
<xml>
<root>
  <skill>10</skill>
</root>
</xml>
</html>
```

HTML rendered.

Skill: Quality assurance

## Control Table Formatting

This function is used to display the description of a control table that has an associated language table.

---

**Syntax****Valid Values**

---

**oraType="table: "**Table code after the colon.

---

---

```
<html>
<body>
<table summary="" border="1" cellpadding="1" cellspacing="1">
  <tr>
<td>Currency:</td>
<td><span oraType="table:CI_CURRENCY_CD" oraField="curr"></span></td>
  </tr>
</table>
</body>
<xml>
<root>
<curr>USD</curr>
</root>
</xml>
</html>
```

HTML rendered.

Currency: United States Dollars
---------------------------------

---

**Add / Remove Grid Formatting**

---

**Syntax****Description**

---

**oraType="addGridRow"**

The addGridRow function is used to build "insert row" dialog into the UI map.

- An 'add' image is displayed.
- Clicking the image inserts a new row in the grid.
- If the list is empty, by default, an empty grid row is automatically be added. This means that the user will always see at least one grid row when this attribute is used.

**oraType="deleteGridRow"**

The deleteGridRow function is used to build "delete row" dialog into the UI map.

- A 'delete' image is displayed.
  - Clicking the image removes the adjacent row from the grid.
- 
- 

**NOTE:** Because add and delete dialogs are relevant only inside a table, these attributes must be specified within a <td> element.

**WARNING:** These attributes are designed to work with the business object action of 'replace' rather than 'update'. Therefore, if the map contains a grid, the business object action of 'replace' must be used to update the business object. Refer to [BO Replace Action](#) for more information.

---

Example:

```
<html>
<head>
<title>Demonstrate Grid Add and Grid Delete OraTypes</title>
  <link rel="stylesheet" type="text/css" href="cisDisabled.css"/>
  <link rel="stylesheet" type="text/css" href="cisEnabled.css"/>
</head>
<body>
```









```

<table oraList="listEntry">
  <thead>
    <tr>
      <th/>
      <th/>
    <th><span>Date</span></th>
    <th><span>Amount</span></th>
  </thead>
  <tbody>
    <tr>
      <td oraType="addGridRow"></td>
      <td oraType="deleteGridRow"></td>
      <td>
        <input oraField="date" oraType="date"></input>
      </td>
      <td align="right">
        <input oraField="amount" oraType="money"></input>
      </td>
    </tr>
  </tbody>
</table>
</body>
<xml>
<root>
  <listEntry>
    <date>2008-01-01</date>
    <amount>44.28</amount>
  </listEntry>
  <listEntry>
    <date>2008-02-01</date>
    <amount>32.87</amount>
  </listEntry>
  <listEntry>
    <date>2008-03-01</date>
    <amount>21.76</amount>
  </listEntry>
</root>
</xml>
</html>

```

HTML rendered.

	Date	Amount
 	<input type="text" value="01-01-2008"/>	<input type="text" value="\$44.28"/>
 	<input type="text" value="02-01-2008"/>	<input type="text" value="\$32.87"/>
 	<input type="text" value="03-01-2008"/>	<input type="text" value="\$21.76"/>

## Unformatted Elements

This function is used to display the contents of an element that contains 'raw' data as defined for the schema element being rendered.

---

### Syntax

---

`oraType="raw"`

---

- UI Map schema:

```

<schema>
  <rawStuff type="raw"/>
</schema>

```

- UI Map HTML:

```

<html>

```

```

<head>
  <link rel="stylesheet" type="text/css" href="cisDisabled.css"/>
  <link rel="stylesheet" type="text/css" href="cisEnabled.css"/>
</head>
<body>
<table summary="" border="1" cellpadding="1" cellspacing="1">
  <tr>
    <td>Raw Stuff:</td>
    <td><span oraType="raw" oraField="rawStuff"></span></td>
  </tr>
</table>
</body>
<xml>
<root>
  <rawStuff>
    <ele1>text in element 1</ele1>
    <group1>
      <ele2>text inside element 2, group 1</ele2>
      <ele3>text inside element 3, group 1</ele3>
    </group1>
  </rawStuff>
</root>
</xml>
</html>

```

HTML rendered.

Raw Stuff:	<pre> &lt;ele1&gt;text in element 1&lt;/ele1&gt; &lt;group1&gt;   &lt;ele2&gt;text inside element 2, group 1&lt;/ele2&gt;   &lt;ele3&gt;text inside element 3, group 1&lt;/ele3&gt; &lt;/group1&gt; </pre>
------------	--

## String Formatting

This function is used to display the contents of an element, as XML pretty-print, when the element contains escaped XML.

---

### Syntax

**oraType="xmlString"**

---

**NOTE:** It is not required, but the pretty print of the rendered XML is enhanced if you specify a pair of stylesheet references, cisEnabled and cisDisabled, in the map's header.

---

Example:

```

<html>
<head>
  <link rel="stylesheet" type="text/css" href="cisDisabled.css"/>
  <link rel="stylesheet" type="text/css" href="cisEnabled.css"/>
</head>
<body>
<table summary="" border="1" cellpadding="1" cellspacing="1">
  <tr>
    <td>XML Stuff:</td>
    <td><span oraType="xmlString" oraField="xmlStuff"></span></td>
  </tr>
</table>
</body>
<xml>
<root>
<xmlStuff>
  <ele1>text in element 1</ele1>
  <group1>
    <ele2>text inside element 2, group 1</ele2>
    <ele3>text inside element 3, group 1</ele3>
  </group1>
</root>

```

```

</xmlStuff>
</root>
</xml>
</html>

```

HTML rendered.

XML Stuff:	<pre> &lt;ele1&gt;text in element 1&lt;/ele1&gt; &lt;group1&gt;   &lt;ele2&gt;text inside element 2, group 1&lt;/ele2&gt;   &lt;ele3&gt;text inside element 3, group 1&lt;/ele3&gt; &lt;/group1&gt; </pre>
------------	--

HTML rendered without oraType="xmlString"

XML Stuff:	<pre> &lt;ele1&gt;text in element 1&lt;/ele1&gt;&lt;group1&gt;&lt;ele2&gt;text inside element 2, group 1&lt;/ele2&gt;&lt;ele3&gt;text inside element 3, group 1&lt;/ele3&gt;&lt;/group1&gt; </pre>
------------	--

## HTML Formatting

This function is used to display the contents of an element as HTML as opposed to plain text. An element defined as oraType="fkref" is automatically rendered as HTML.

---

### Syntax

oraType="html"

---

#### WARNING:

To avoid execution of malicious HTML not all HTML tags are supported. The list of supported tags is defined in the "F1-HTMLWhiteList" managed content definition.

If unsupported HTML is detected the entire element is escaped and rendered as plain text. It is therefore recommended to properly escape any source string that contributes to the final HTML element if it is not expected to contain valid HTML. This way only the offending string is escaped and not the entire element.

If the HTML element is composed in scripting refer to the 'escape' function described in the [Edit Data Syntax](#) for more information. Use the WebStringUtilities.asHTML java API for escaping text composed in Java.

---

```

<html>
<head>
  <link rel="stylesheet" type="text/css" href="cisDisabled.css"/>
  <link rel="stylesheet" type="text/css" href="cisEnabled.css"/>
</head>
<body>
<table summary="" border="0" cellpadding="1" cellspacing="1">
  <tr>
    <td>Info :</td>
    <td><span oraType="html" oraField="info"></span></td>
  </tr>
</table>
</body>
<xml>
<root>
  <info><b>text in bold</b></info>
</root>
</xml>
</html>

```

HTML rendered.

Info : <b>text in bold</b>
----------------------------

HTML rendered without oraType="html"

Info : **text in bold**

## Display Labels

### Derive Label from an Element

This attribute is used to obtain a language sensitive label for a `<span>`, `<td>`, or `<input>` HTML element.

Syntax	Valid Values
<code>oraLabel=" "</code>	XPath of an element in the UI map schema. The element must reference either the <code>mapField=</code> , <code>mdField=</code> , or <code>label=</code> attribute.

**NOTE:** You can also define a field directly in your HTML for label definition, refer to [Deriving Label from a Field](#) for more information.

**NOTE:** If the schema contains multiple attributes, the `oraLabel` attribute will pick the label to render according to the following hierarchy: The label attribute overrides the `mdField` attribute, which in turn will override the `mapField` attribute.

- UI Map schema:

```
<schema>
  <user mapField="USER_ID" />
  <info type="group" mapXML="CLOB">
    <city label="Metro Area" />
    <age mdField="AGE_LBL" />
  </info>
</schema>
```

- HTML:

```
<html>
<head><title oraMdLabel="BUS_LBL"></title></head>
<body>
<table>
  <tr>
    <td oraLabel="user"></td>
    <td><input oraField="user" /></td>
  </tr>
  <tr>
    <td oraLabel="info/city"></td>
    <td><input oraField="info/city" /></td>
  </tr>
  <tr>
    <td oraLabel="info/age"></td>
    <td><input oraField="info/age" /></td>
  </tr>
  <tr>
    <td />
    <td><input type="button" oraMdLabel="ACCEPT_LBL" /></td>
  </tr>
</table>
</body>
<xml>
  <root>
    <user>RWINSTON</user>
    <info>
      <city>Alameda</city>
      <age>32</age>
    </info>
  </root>
</xml>
```

```
</html>
```

HTML rendered:

User	<input type="text" value="RWINSTON"/>
Metro Area	<input type="text" value="Alameda"/>
Age	<input type="text" value="32"/>
	<input type="button" value="Accept"/>

### Deriving Label from a Field

This attribute is used to obtain a language sensitive label for a `<span>`, `<td>`, `<input>`, or `<title>` HTML element. The label text is derived from the field referenced.

---

Syntax	Valid Values
<code>oraMdLabel=" "</code>	<a href="#">MD Field code</a> .

---

**NOTE:** You can also define labels derived from the map's schema definition, refer to [Derive Label from an Element](#) for more information.

---

- HTML:

```
<html>
<head><title oraMdLabel="NOTES_LBL"></title></head>
<body>
<table>
  <tr>
    <td oraLabel="user"></td>
    <td><input oraField="user" /></td>
  </tr>
  <tr>
    <td oraLabel="info/city"></td>
    <td><input oraField="info/city" /></td>
  </tr>
  <tr>
    <td oraLabel="info/age"></td>
    <td><input oraField="info/age" /></td>
  </tr>
  <tr>
    <td />
    <td><input type="button" oraMdLabel="ACCEPT_LBL" /></td>
  </tr>
</table>
</body>
<xml>
  <root>
    <user>RWINSTON</user>
    <info>
      <city>Alameda</city>
      <age>32</age>
    </info>
  </root>
</xml>
</html>
```

HTML rendered:

User

Metro Area

Age

## Enable UI Map Help

The [Display Labels](#) section describes ways to derive the label for an element using an underlying [MD Field](#). In addition, if the same MD field contains help text, the system will automatically generate a tool tip adjacent to the element label. Clicking the tool tip allows the user to view the help text.

It is possible to change the rendering of the tool tip. Refer to [Custom Look And Feel Options](#) for more information

## Search Using a Pop-Up Explorer Zone

### Search Option

This attribute is used to enable search zone functionality for input HTML elements.

Syntax	Valid Values
<code>oraSearch=" "</code>	Zone code.

**NOTE:** The `oraSearch` attribute is similar to the `oraType` attribute, because it will be 'automatically' included into HTML via the `oraSchemaDataTypes` attribute. This means that coding the `oraSearch` attribute into UI Map HTML is only required if a search zone has not been specified in the schema, or in the schema element's FK reference.

- Example of defining the search in the HTML. UI Map's Schema:

```
<schema>
  <uiMap/>
</schema>
```

#### UI Map's HTML

```
<html>
<body>
<table summary="" border="1" cellpadding="1" cellspacing="1">
  <tr>
    <td>UI Map with Search </td>
    <td><input oraField="uiMap" oraSearch="F1-UISRCH"></td>
  </tr>
</table>
</body>
<xml>
<root>
  <uiMap/>
</root>
</xml>
</html>
```

- Example of defining the search in the schema. UI Map's Schema:

```
<schema>
  <uiMap search="F1-UISRCH" />
</schema>
```

## UI Map's HTML

```
<html>
<body>
<table summary="" border="1" cellpadding="1" cellspacing="1">
  <tr>
    <td>UI Map with Search </td>
    <td><input oraField="uiMap"></td>
  </tr>
</table>
</body>
<xml>
<root>
  <uiMap/>
</root>
</xml>
</html>
```

- Example where the FK reference defines the search zone. UI Map's Schema:

```
<schema>
  <uiMap fkRef="F1-UISRC" />
</schema>
```

## UI Map's HTML

```
<html>
<body>
<table summary="" border="1" cellpadding="1" cellspacing="1">
  <tr>
    <td>UI Map with Search </td>
    <td><input oraField="uiMap"></td>
  </tr>
</table>
</body>
<xml>
<root>
  <uiMap/>
</root>
</xml>
</html>
```

In all cases, the HTML rendered is the same.



## Initializing Search Fields

This optional attribute is used to initialize search zone filters. Multiple filters may be initialized. This attribute can only be used in conjunction with the oraSearch attribute.

Syntax	Valid Values	Field Value Options	Comments
<b>oraSearchField=" "</b>	One or more pairs of field name and field value separated by colon. Each pair is separated by a semi-colon.	No value	If you do not specify a field value, then the value of the input element containing the oraSearchField attribute will be used.
<b>oraSearchField="fieldName:fieldValue: ..."</b>	The field name is used to identify the zone filter to initialize when the search is launched. The field name must match the value of the searchField mnemonic	XPath  'literal'	Indicate the XPath to the schema element that contains the value to use.  Indicate a literal value to supply.

Syntax	Valid Values	Field Value Options	Comments
	specified on a search zone <a href="#">user filter</a> or <a href="#">hidden filter</a> parameter.		

**NOTE:** If you do not specify an oraSearchField attribute and the schema element has a search enabled fkRef specified, the framework automatically builds an oraSearchField where the field name is equal to the FK reference's key (MD) [fields](#).

**WARNING:** The pop-up explorer zone can be invoked one of two ways: By clicking on the search button, or by hitting the enter key from the field to the left of the button. If you click on the button then no search field information will be passed to the zone. Search field information is only used to initialize zone filter values when enter is pressed.

Two filter values are initialized as shown in the following example:

```
<schema>
  <bo/>
  <uiMap/>
</schema>

<html>
<body>
<table summary="" border="1" cellpadding="1" cellspacing="1">
  <tr>
    <td>UI Map with Search </td>
    <td><input oraField="uiMap" oraSearch="F1-
UISRCH" oraSearchField="MAP_CD; BUS_OBJ_CD:bo;"></td>
  </tr>
</table>
</body>
<xml>
<root>
  <bo/>
  <uiMap/>
</root>
</xml>
</html>
```

### Mapping Returned Search Fields

This optional attribute is used to direct values returned by the search zone. Multiple fields may be specified. This attribute can only be used in conjunction with the oraSearch attribute.

Syntax	Valid Values	Field Value Options	Comments
<b>oraSearchOut=" "</b>	One or more pairs of field name and field value separated by colon. Each pair is separated by a semi-colon.	No value	If you do not specify a field value, then the input element containing the oraSearchField attribute receives the returned value.
	<b>oraSearchOut="field name:xpath target; ..."</b> The field name is used to identify the search result returned from the query zone. The field name must match the ELEMENT_NAME mnemonic defined within the explorer zone's search results parameter.	XPath	Indicate the XPath to the schema element that should receive the returned value.



**NOTE:** If you do not specify an oraSearchOut attribute, the framework will build a default where the field name will be set equal to the oraSearchField's field name.

Two values are returned in the following example:

```
<schema>
  <bo/>
  <mo/>
</schema>

<html>
<body>
<table summary="" border="1" cellpadding="1" cellspacing="1">
  <tr>
    <td>BO Search </td>
    <td><input oraField="bo" oraSearch="Z1-BOSRCH" oraSearchOut="BUS_OBJ_CD; MO_CD:mo;"></td>
  </tr>
</table>
</body>
<xml>
<root>
  <bo/>
  <mo/>
</root>
</xml>
</html>
```

## Display Errors

### Display Error Variables

One of the following error variables may be displayed.

---

#### Syntax

---

**oraErrorVar="ERRMSG-TEXT"**

---

**oraErrorVar="ERRMSG-LONG"**

---

**oraErrorVar="ERRMSG-CATEGORY"**

---

**oraErrorVar="ERRMSG-NUMBER"**

---

```
...
<table width="100%" cellpadding="12">
  <tr class="oraErrorText">
    <td>
      <a href="" onclick="oraShowErrorAlert(); return false;">
<span class="oraErrorText" oraErrorVar="ERRMSG-TEXT"></span>
      </a>
    </td>
  </tr>
</table>
...
```

HTML rendered



**Last name required**

**User Id** BOND007

**First Name**

**Last Name**

## Highlight a Field in Error

**NOTE:** For more information on throwing an error, refer to the [Terminate Statement](#) in the Edit Data Syntax.

Syntax	Comments
<code>oraError="automate:true false; prefix: "</code>	Specifying <b>automate:true</b> automatically enables highlighting of the element in error when issuing an error. Note that <b>true</b> is the default and doesn't need to be specified. Specify <b>automate:false</b> to turn off field highlighting.  The system uses a match on the element name referenced in the error to the element names in the UI map. If the elements in the schema are within an XPath that may not match what is referenced by the error, use <b>prefix:XPath</b> to specify that.

**NOTE:** A pair of stylesheet references, `cisEnabled` and `cisDisabled`, must be specified for reference of the `oraError` style. The stylesheet controls how the field in error will be rendered. If you want to alter the rendering you must override the `oraError` style.

The following HTML example shows that the elements in the map are defined within a group called **boGroup**. The element name returned by the error will not include this group so in order for the field highlighting to work properly the **prefix:** attribute must indicate the group name.

```
<html>
<head>
  <title>User Zone Input</title>
  <link rel="stylesheet" type="text/css" href="cisDisabled.css"/>
  <link rel="stylesheet" type="text/css" href="cisEnabled.css"/>
</head>
<body oraError="automate:true; prefix:boGroup">
<table width="100%" cellpadding="12">
  <tr class="oraErrorText">
    <td>
      <a href="#" onclick="oraShowErrorAlert(); return false;">
        <span class="oraErrorText" oraErrorVar="ERRMSG-TEXT"></span>
      </a>
    </td>
  </tr>
</table>
<table width="100%" border="0" cellpadding="4">
  <tr style="padding-top:30px;">
    <td align="right" class="label">User Id</td>
    <td>
      <span oraField="boGroup/userId" class="normal"/>
    </td>
  </tr>
  <tr>
    <td align="right" class="label">First Name</td>
    <td>
      <input oraField="boGroup/firstName" class="normal"/>
    </td>
  </tr>
  <tr>
    <td align="right" class="label">Last Name</td>
    <td>
      <input oraField="boGroup/lastName" class="normal"/>
    </td>
  </tr>
</table>
</body>
```

```

<xml>
<root>
<boGroup>
  <userId>BOND007</userId>
  <firstName>James</firstName>
  <lastName></lastName>
</boGroup>
</root>
</xml>
</html>

```

HTML rendered, where the error element thrown is equal to 'lastName':

## Overriding the Error Element Name

In the rare occasion where the element name returned by the error doesn't match the element name in the map, you can add an explicit attribute to indicate the error element name.

Syntax	Valid Values	Comments
<code>oraErrorElement=</code>	"element name"	The element name referenced here must exactly match the name of the error element assigned when the error was thrown. More than one HTML field can be referenced by the same error element name.

**NOTE:** A pair of stylesheet references, `cisEnabled` and `cisDisabled`, must be specified for reference of the `oraError` style. The stylesheet controls how the field in error will be rendered. If you want to alter the rendering you must override the `oraError` style.

This illustrates a scenario where the element name associated with the error differs from the element name on the map.

```

<html>
<head>
  <title>User Zone Input</title>
  <link rel="stylesheet" type="text/css" href="cisDisabled.css"/>
  <link rel="stylesheet" type="text/css" href="cisEnabled.css"/>
</head>
<body>
<table width="100%" cellpadding="12">
  <tr class="oraErrorText">
    <td>
      <a href="" onclick="oraShowErrorAlert(); return false;">
        <span class="oraErrorText" oraErrorVar="ERRMSG-TEXT"></span>
      </a>
    </td>
  </tr>
</table>
<table width="100%" border="0" cellpadding="4">
  <tr style="padding-top:30px;">
    <td align="right" class="label">User Id</td>
    <td>
      <span oraField="userId" class="normal"/>
    </td>
  </tr>
  <tr>
    <td align="right" class="label">First Name</td>

```

```

    <td>
      <input oraField="firstName" class="normal" oraErrorElement="firstName"/>
    </td>
  </tr>

  <tr>
    <td align="right" class="label">Last Name</td>
    <td>
      <input oraField="familyName" class="normal" oraErrorElement="lastName"/>
    </td>
  </tr>
</table>
</body>

<xml>
<root>
  <userId>BOND007</userId>
  <firstName>James</firstName>
  <familyName></familyName>
</root>
</xml>
</html>

```

HTML rendered.

The screenshot shows a web form with the following elements:

- A purple error message: **Last name required**
- A label **User Id** followed by the value **BOND007**.
- A label **First Name** followed by a text input field containing the value **James**.
- A label **Last Name** followed by a redacted input field (black box).

## Display Error Pop-Up

When the error text is displayed, this function may be used to pop-up the standard error dialog (which displays more information) when a user clicks the error message.

---

### Syntax

---

**oraShowErrorAlert(); return false;**

---

```

<html>
<head>
  <link rel="stylesheet" type="text/css" href="cisDisabled.css"/>
  <link rel="stylesheet" type="text/css" href="cisEnabled.css"/>
</head>
<body>
<table width="100%" cellpadding="12">
  <tr class="oraErrorText">
    <td>
      <a href="#" onclick="oraShowErrorAlert(); return false;">
        <span class="oraErrorText" oraErrorVar="ERRMSG-TEXT"></span>
      </a>
    </td>
  </tr>
</table>
<table>
  <tr>
    <td >Address:</td>
    <td><input type="text" oraField="address"/></td>
  </tr>
  <tr>
    <td>City:</td>
    <td><input type="text" oraField="city"/></td>
  </tr>
  <tr>
    <td>State:</td>
    <td><input type="text" oraField="state"/></td>
  </tr>
</table>

```

```

</tr>
<tr>
    <td>Zip:</td>
    <td><input type="text" oraField="zip"/></td>
</tr>
<tr>
    <td/>
    <td style="padding-top:15px;">
<oraInclude map="F1-SaveCancelButtons"/>
    </td>
</tr>
</table>
</body>
</xml>
<xml>
    <root>
        <address>123 Main St</address>
        <city>Alameda</city>
        <state>CA</state>
        <zip>94770</zip>
    </root>
</xml>
</html>

```

HTML rendered.

Address field missing

Address:

City:

State:

Zip:

Standard error pop-up dialog launched via click on error message:

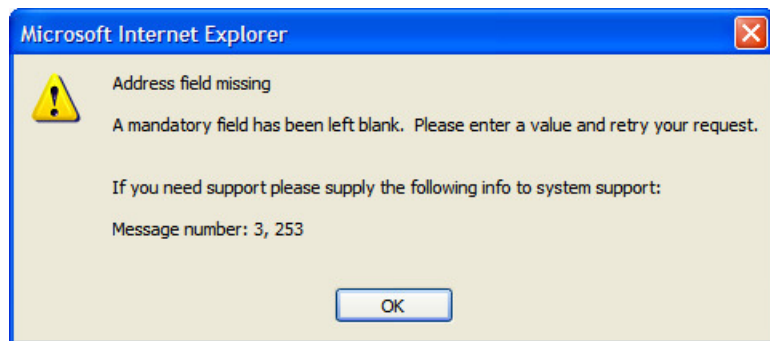

## Fire JavaScript for Browser Events

### Working with the JavaScript Framework

There are many JavaScript events that can be used within the HTML/Javascript environment. These include events such as onLoad, onBlur, onChange, etc. The UI Map Framework also makes use of some of these events. It is important that any UI Map you develop works with the framework in order to obtain consistent results (events may not always be executed in the same order at all times!).

---

**WARNING:**

The following describes the recommended approach for safely handling loading and processing field updates in your UI Maps.

If JavaScript is required within an XHTML UI Map or fragment, it will be necessary to bound it within a `![CDATA[ ]]` tag to ensure a valid XML document. Note that the tags themselves may need to be commented out to promote compatibility with older browsers. For example:

```
<script type="text/javascript">

/* <![CDATA[ */

//

// javascript

//

/* ]]> */

</script>
```

## Element Change Event

Syntax	Valid Values
<code>oraChange=" "</code>	A JavaScript function.

At the time of UI Map load, if there is an event handler already attached to an HTML element, the framework removes it and attaches a combined event handler. The combined handler calls any **framework handler first** and then calls the other (custom) handlers.

**WARNING:** Note that the function must not be used to execute logic that will modify the associated field data value again - or an endless loop will occur.

In the following example the **oraInvokeBS** function is executed when the button is clicked.

```
<html>
<head>
<title>oraInvokeBS test</title>
</head>
<body>
<table>
<tr>
<td>User Id:</td>
<td>
<input oraField= "xmlGroup/userId"/>
<input type="button" value="Search" oraChange="oraInvokeBS( 'UserSearch' , 'xmlGroup' );"/>
</td>
</tr>
<tr>
<td/>
<td>Search Results</td>
</tr>
<tr>
<td/>
<td>
<table oraList="xmlGroup/searchList">
<tr>
<td><span oraField="userId"></span>
</td>
</tr>
</table>
</td>
</tr>
</table>
</body>
<xml>
<root>
```

```

    <xmlGroup>
      <userId/>
      <searchList>
        <userId/></userId>
      </searchList>
    </xmlGroup>
  </root>
</xml>
</html>

```

## Page Load Event

Syntax	Valid Values
<code>oraLoad=" "</code>	A JavaScript function.

**WARNING:** When executing `oraLoad` within a fragment UI map, and you need to execute a JavaScript function during page load (where the function invokes a business object, business service, or service script) you can use the special syntax `oraLoad[$SEQUENCEID]`. For other special syntax used for map fragments, refer to the [Construct a Portal Zone Header](#) section.

- In the following example, the `oraDisplayNone` function is executed during page load:

```

<html>
<body>
<table summary="" border="1" cellpadding="1" cellspacing="1">
  <tr>
    <td oraLoad="oraDisplayNone(item,'userId','')>User Id: </td>
    <td><span oraField="userId"></span></td>
  </tr>
</table>
</body>
<xml>
<root>
  <userId>SPLAXT</userId>
</root>
</xml>
</html>

```

- HTML rendered

User Id: SPLAXT

## After Page Load Event

Syntax	Valid Values
<code>oraAfterLoad=" "</code>	A JavaScript function.

In the following example the `oraGetValueFromScript` function is executed after page load.

```

<div>
  <label for="boGroup_parameters_externalSystem" oraLabel="boGroup/parameters/externalSystem">
  </label>
  <span>
    <select oraSelect="bs:F1-RetrieveExternalSystems" class="oraInput"
      id="boGroup_parameters_externalSystem" oraField="boGroup/parameters/externalSystem"
      oraSelectOut="valuePath:results/externalSystem; descPath:results/description"
      oraSelectIn="outboundMsgType:boGroup/parameters/outboundMsgType"
      oraAfterLoad
        ="oraGetValueFromScript(document.getElementById('boGroup_parameters_externalSystem'));">
    </select>
  </span>

```

</div>

## Hide Elements

### Hide Using a Function

The system provides a function that is used to hide an HTML element based on the value on another element or based on the results of a JavaScript function. Note that the first parameter is the string **item**, which lets the function identify the HTML item being manipulated.

Syntax	Valid Values	Comments
<code>oraDisplayNone(item);</code>	(item, 'XPath', 'value', 'operator')	Used to hide an element based on the value of another element (referenced using its XPath). Enter a value of '' to interrogate a blank value. By default the operator is '='. This may be set instead to another operator such as '!=', '>', or '<'.
	(item, function name, <b>true</b>   <b>false</b> )	Used to indicate a JavaScript function, which must return a Boolean.

- Example where the User Id label is hidden when no User Id value exists.

```
<html>
<body>
<table summary="" border="1" cellpadding="1" cellspacing="1">
  <tr>
    <td oraLoad="oraDisplayNone(item, 'userId', '')">User Id: </td>
    <td><span oraField="userId"></span></td>
  </tr>
</table>
</body>
<xml>
<root>
  <userId></userId>
</root>
</xml>
</html>
```

- Example where the Save button is hidden when the user does not have security access to the action of change ('C') for the application service 'F1-DFLTS'.

```
<html>
<body>
<table summary="" border="1" cellpadding="1" cellspacing="1">
  <tr>
    <td oraLoad="oraDisplayNone(item, oraHasSecurity('F1-DFLTS', 'C'), false);">
      <input name="Save" type="button" onclick="oraInvokeBO('CM-
IndividualTaxpayer', null, 'replace')"/>
    </td>
  </tr>
</table>
</body>
<xml>
<root>
  <userId></userId>
</root>
</xml>
</html>
```

### Check User's Security Access

The system provides two functions to check a user's security access to a given application service and access mode. These are commonly used for hiding elements.



Syntax	Parameters
<code>oraHasSecurity()</code>	'Application Service code'
	'Access Mode'
<code>oraHasSecurityPath('x','y')</code>	'Application Service XPath'
	'Access Mode XPath'

See the previous section for an example of the **oraHasSecurity** function. The following shows an example where the status button is hidden when the user does not have security access to the access mode 'ACT' of the application service 'FORMTST'.

```
<html>
<body>
<table>
  <tr>
    <td oraLoad="oraDisplayNone(item, oraHasSecurityPath('appService', 'accessMode'), false );">
      <input oraField="statusLabel" type="button" onclick="oraRunScript('UpdateState', 'status');"/>
    </td>
  </tr>
</table>
</body>
<xml>
<root>
  <status>ACTIVATE</status>
<statusLabel>Activate</statusLabel>
<appService>FORMTST</appService>
  <accessMode>ACT</accessMode>
</root>
</xml>
</html>
```

## Invoke Schema Based Services

The system provides functions for invoking a business object, business service or service script.

### Invoke BO Function

This function is used to perform a BO interaction directly from the UI map's HTML. It returns a 'true' or a 'false' depending on whether the invocation encounters an error.

Syntax	Parameters	Comments
<code>oraInvokeBO()</code>	'BO Name'	
	'XPath' or <b>null</b>	Identifies a group element via XPath. If you specify the word <b>null</b> , then the entire embedded XML object will be passed.
	'action'	Indicate the action to use. Valid values are <b>add</b> , <b>delete</b> , <b>read</b> , <b>update</b> , and <b>replace</b> .

- Example with the statement invoked in a JavaScript function.

```
function invokeBO {
  if (!oraInvokeBO('F1-User', 'xmlGroup', 'read')) {
    oraShowErrorAlert();
    return;
  }
}
```

- Example with the statement invoked within onClick.

```
<html>
```

```

<head>
  <title>oraInvokeBO test</title>
</head>
<body>
  <table>
    <tr>
      <td>User Id:</td>
      <td>
        <input oraField= "xmlGroup/userId" />
        <input type="button" value="Find" onClick="oraInvokeBO('F1-
User', 'xmlGroup', 'read');" />
      </td>
    </tr>
    <tr>
      <td/>
      <td>Result</td>
    </tr>
    <tr>
      <td/>
      <td>
        <span oraField="xmlGroup/firstName"></span>
        <span oraField="xmlGroup/lastName"></span>
      </td>
    </tr>
  </table>
</body>

<xml>
  <root>
    <xmlGroup>
      <userId>SPLNXU</userId>
      <firstName></firstName>
      <lastName></lastName>
    </xmlGroup>
  </root>
</xml>
</html>

```

HTML rendered.

User Id:

Result

Czarina Andrada

## Invoke BS Function

This function is used to perform a business service interaction directly from the UI map's HTML. It returns a 'true' or a 'false' depending on whether the invocation encounters an error.

Syntax	Parameters	Comments
<code>oraInvokeBS( )</code>	'BS Name'  'XPath' or <code>null</code>	Identifies a group element via XPath. If you specify the word <code>null</code> , then the entire embedded XML object will be passed.

- Example with the statement coded within a JavaScript function.

```

function invokeBS {
  if (!oraInvokeBS('F1-UserSearch', 'xmlGroup')) {
    oraShowErrorAlert();
    return;
  }
}

```

- Example with the statement invoked via onClick.

```

<html>
  <head>
    <title>oraInvokeBS test</title>
  </head>
  <body>
    <table>
      <tr>
        <td>User Id:</td>
        <td>
          <input oraField= "xmlGroup/userId" />
          <input type="button" value="Search" onClick="oraInvokeBS('Fl-
UserSearch', 'xmlGroup');" />
        </td>
      </tr>
      <tr>
        <td/>
        <td>Search Results</td>
      </tr>
      <tr>
        <td/>
        <td>
          <table oraList="xmlGroup/searchList">
<tr><td><span oraField="userId"></span></td></tr>
          </table>
        </td>
      </tr>
    </table>
  </body>
</html>
<xml>
  <root>
    <xmlGroup>
      <userId/>
      <searchList>
        <userId></userId>
      </searchList>
    </xmlGroup>
  </root>
</xml>
</html>

```

HTML rendered.

User Id:

Search Results

BBLABY  
 CBALKAN  
 CRUPPERT  
 CTICZON  
 DSISKA

### Invoke SS Function

This function is used to perform a service script interaction directly from the UI map's HTML. It returns a 'true' or a 'false' depending on whether the invocation encounters an error.

Syntax	Parameters	Comments
oraInvokeSS( )	'Service Script Name'  'XPath' or null	Identifies a group element via XPath. If you specify the word <b>null</b> , then the document belonging to the parent node will be passed. If the parent node is not enough, then the entire

**Syntax****Parameters****Comments**

---

document can always be passed using the following syntax:  
oraInvokeSS('service script', null, null, [SEQUENCEID])

---

- Example with the statement invoked within a JavaScript function:

```
function invokeSS {
    if (!oraInvokeSS('F1-GetUsers','xmlGroup')) {
        oraShowErrorAlert();
        return;
    }
}
```

- Example with the statement invoked within onClick.

```
<html>
  <head>
    <title>oraInvokeSS test</title>
  </head>
  <body>
    <table>
      <tr>
        <td>User Id:</td>
        <td>
          <input oraField= "xmlGroup/userId"/>
          <input type="button" value="Search" onClick="oraInvokeSS('F1-
GetUsers','xmlGroup');"/>
        </td>
      </tr>
      <tr>
        <td/>
        <td>Search Results</td>
      </tr>
      <tr>
        <td/>
        <td>
          <table oraList="xmlGroup/searchList">
<tr><td><span oraField="userId"></span></td></tr>
          </table>
        </td>
      </tr>
    </table>
  </body>
  <xml>
    <root>
      <xmlGroup>
        <userId/>
        <searchList>
          <userId></userId>
        </searchList>
      </xmlGroup>
    </root>
  </xml>
</html>
```

HTML rendered.

User Id:

Search Results

BBLABY  
CBALKAN  
CRUPPERT  
CTICZON  
DSISKA

## Refresh a Rendered Map or Portal Page

### Refresh Map

This function is used to 'Refresh' only the map zone issuing the command.

---

#### Syntax

---

**oraRefreshMap;**

---

---

```
...  
  <tr>  
    <td/>  
    <td><input type="button" onclick="oraRefreshMap();" value="Refresh"/></td>  
  </tr>  
...
```

### Refresh Page

This function is used to refresh all zones in the portal.

---

#### Syntax

---

**oraRefreshPage;**

---

---

```
...  
  <tr>  
    <td/>  
    <td><input type="button" onclick="oraRefreshPage();" value="Refresh"/></td>  
  </tr>  
...
```

## Embed Framework Navigation

### Navigate using Navigation Option

This function is used to navigate to another page using the information defined on a navigation option.

---

#### Syntax

---

**oraNavigate( );**

#### Parameters

---

'Navigation Option code'

---

'Key XPath'

---

---

**WARNING:** This function is only intended for a UI map defined within a portal zone. It should not be used within a UI map launched by a BPA script.

---

The following example exhibits two possible uses of this function: as a URL and as a button. Note that the UI Map schema must contain a fkRef attribute. Refer to [FK Reference Formatting](#) for more information.

```
<schema>
  <userId fkRef="CI_USER" />
</schema>

<html>
<body>
<table summary="" border="1" cellpadding="1" cellspacing="1">
  <tr>
    <td>User Link: </td>
    <td><a href="" onclick="oraNavigate('userMaint','userId'); return false;">
      <span oraField="userId" oraType="fkRef:CI_USER"></span></a>
    </td>
  </tr>
  <tr>
    <td>User Button: </td>
    <td><input type="submit" onclick="oraNavigate('userMaint','userId')"
      value="Go to User" /></td>
  </tr>
</table>
</body>
<xml>
<root>
  <userId>SPLAXT</userId>
</root>
</xml>
</html>
```

HTML rendered.



## Launch BPA Script

### Launch BPA Script

Syntax	Parameters	Comments
<code>oraRunScript( );</code>	'BPA script code'.  'XPath Element'	One or more element values may be passed into the BPA where it may be referenced as temporary variables.

**WARNING:** This function is only applicable to UI maps displayed in portal zones. UI maps launched within a running BPA script cannot directly launch another BPA script from the UI map's HTML. Instead, return a value from the UI map and execute a Perform Script or Transfer Control step type.

**NOTE:** It is incumbent on the script author to pull information out of temporary storage in the initial steps of the script.

In the following example, a temporary variable named 'personId' is created with value '1234567890' and the BPA script named 'Edit Address' is launched.

```
<html>
<body>
<table>
  <tr>
    <td>
      <div oraField="address"></div>
      <span oraField="city"></span>
    </td>
  </tr>
</table>
</body>
</html>
```

```

        <span>,</span>
        <span oraField="state"></span>
        <span oraField="zip"></span>
        <span oraField="country"></span>
        <a href="" onClick="oraRunScript('Edit Address','personId');">edit</a>
    </td>
</tr>
</table>
</body>
<xml>
    <root>
        <personId>1234567890</personId>
        <address>123 Main St</address>
        <city>Alameda</city>
        <state>CA</state>
        <zip>94770</zip>
    </root>
</xml>
</html>

```

HTML rendered.

123 Main St  
Alameda, CA 94770 [edit](#)

### Launch BPA Script With Values

This function is used to launch a BPA, providing name/value pairs to push into temporary storage. Multiple values can be passed. The BPA script can then reference the temporary variables by name.

Syntax	Parameters	Comments
<code>oraRunScriptWithValues( );</code>	'BPA script code'.	
	'XPath Element Name':value	One or more pairs of element names and values.

**NOTE:** You would use this JavaScript function, instead of `oraRunScript`, if you need to push values to the BPA script that are not located in the UI Map's XML structure.

In the example below, a JavaScript function named `editUser()` is responsible for launching the BPA script named `'UserEdit'`. The temporary variable named `'userId'` will be created with value `'CMURRAY'`.

```

<html>
<head>
<script type="text/javascript">

function editUser() {
    var values = {'userId': 'CMURRAY'};
    oraRunScriptWithValues('UserEdit', values);
    return;
}

</script>
</head>
<body>
...
</body>
</html>

```

### Exit UI Map with Bound Values

This function is used to exit a UI Map. When you quit the map you can specify a value to return to the script and, in addition, whether to return updated XML.

Syntax	Parameters	Comments
<code>oraSubmitMap( );</code>	'Return Value' Boolean value	Indicates if the updated XML should be returned. Default is <b>true</b> .

In the following example, the Save button will return updated information, the Cancel button will not.

```

<html>
<body>
<table>
  <tr>
    <td/>
    <td style="padding-bottom:15px;">
      <a href="#" onclick="oraShowErrorAlert(); return false;">
        <span oraErrorVar="ERRMSG-TEXT"></span></a>
      </td>
    </tr>
  <tr>
    <td >Address:</td>
    <td><input type="text" oraField="address"/></td>
  </tr>
  <tr>
    <td>City:</td>
    <td><input type="text" oraField="city"/></td>
  </tr>
  <tr>
    <td>State:</td>
    <td><input type="text" oraField="state"/></td>
  </tr>
  <tr>
    <td>Zip:</td>
    <td><input type="text" oraField="zip"/></td>
  </tr>
  <tr>
    <td/>
    <td style="padding-top:15px;">
      <input type="button" value="Save" onClick="oraSubmitMap('SAVE');"/>
      <input type="button" value="Cancel" onClick="oraSubmitMap('CANCEL',false);"/>
    </td>
  </tr>
</table>
</body>
<xml>
  <root>
    <address>123 Main St</address>
    <city>Alameda</city>
    <state>CA</state>
    <zip>94770</zip>
  </root>
</xml>
</html>

```

Save and Cancel buttons rendered:

The screenshot shows a web form with a red error message at the top: "Address field missing". The form has four input fields: "Address:" (empty), "City:" (filled with "Alameda"), "State:" (filled with "CA"), and "Zip:" (filled with "94770"). Below the fields are two buttons: "Save" and "Cancel".



## Include a Map Fragment

This function is used to embed a map fragment within another UI map. Note that it is possible to use the include node within a map or a map fragment.

Syntax	Parameters	Comments
<code>&lt;oraInclude map=' ' prefixPath=' '/&gt;</code>	<code>map='UI Map Code'</code> <code>prefixPath='Xpath'</code>	Optionally specify an xpath prefix to be appended onto every included oraField, oraLabel, oraList, oraSelect valuePath and descPath, oraDownloadData, and oraUploadData attribute value defined within the included UI map fragment's HTML.  <b>NOTE:</b> This functionality only applies to XPath attribute values when those values do not appear beneath an oraList attribute. Any XPath value within a table containing an oraList attribute will not be affected by a prefixPath.

- An example of a map fragment with two buttons, named 'F1-SaveCancelButtons'.

```
<input onClick = "oraSubmitMap( 'SAVE' );" oraMdLabel="SAVE_BTN_LBL" class="oraButton" type="button" />
<input onClick = "oraSubmitMap( 'CANCEL', false );" oraMdLabel="CANCEL_LBL" class="oraButton" type="button" />
```

- An example of a map that includes the map fragment named 'F1-SaveCancelButtons'.

```
...
<tr>
  <td colspan="2" align="center">
<oraInclude map="F1-SaveCancelButtons" />
  </td>
</tr>
...
```

## Show Schema Default on Add

Default values within in the UI map's schema will be displayed on a UI map's input fields if an embedded <action> node has a value of 'ADD' or blank.

### Syntax

```
<action>ADD</action>
```

```
<action> </action>
```

The schema default for the <description> element will be displayed:

```
<schema>
  <action/>
  <boGroup type="group">
    <key/>
    <description default="enter description here" />
  </boGroup>
```

```

</schema>
<html>
<body>
<table summary="" border="1" cellpadding="1" cellspacing="1">
  <tr>
    <td>Description  </td>
    <td><input oraField="boGroup/description"></td>
  </tr>
</table>
</body>
</html>
<xml>
<root>
  <action>ADD</action>
  <boGroup>
    <key/>
    <description/>
  </boGroup>
</root>
</xml>
</html>

```

HTML rendered.

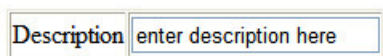

## Configure a Chart

The following HTML attributes are used to configure a graphical representation of an XML list. The designer can control the type, size, position, and contents of the chart using the following attributes.

### **oraChart="type:pie, stacked, cluster, line, area, combo ;"**

This attribute defines the type of graph to display and its general configuration. The set of configuration parameters available for this attribute are as follows:

Parameter	Values	Description
<b>type:</b>	<b>pie</b>	Defines the type of chart to display.
	<b>stacked</b>	Required
	<b>cluster</b>	
	<b>line</b>	
	<b>area</b>	
	<b>combo</b>	
<b>showLegend</b>	<b>true</b>	Defines if the chart should have a legend displayed. Optional (default is <b>true</b> )
	<b>false</b>	
<b>legendPosition</b>	<b>left</b>	Defines where the legend should appear. Optional (default is <b>right</b> )
	<b>right</b>	
	<b>bottom</b>	Setting position to <b>left</b> or <b>right</b> will automatically render it vertically. Setting position to <b>top</b> or <b>bottom</b> will automatically render it horizontally.
	<b>top</b>	
<b>legendBorder</b>	<b>true</b>	Defines if the legend should display with a border around it. Optional (default is <b>false</b> )
	<b>false</b>	

Parameter	Values	Description
<b>depth</b>	<b>true</b>	A value of <b>true</b> indicates a 3 dimensional depth for the chart.
	<b>false</b>	Optional (default <b>false</b> , which is a 2 dimensional chart)
<b>animate</b>	<b>true</b>	A value of <b>true</b> indicates that the graph should animate when displayed.
	<b>false</b>	Optional (default is <b>true</b> ). When using large data sets, consider disabling animation.
<b>dataCursor</b>	<b>on</b>	A value of <b>on</b> enables hovering anywhere in the graph.
	<b>off</b>	Optional (default is <b>off</b> ). It is not applicable to pie charts.
<b>orientation</b>	<b>horizontal</b>	Defines the chart orientation. This only applies to bar, line, area, combo charts.  E.g., <b>oraChart="type:cluster; orientation:horizontal"</b> , defines horizontal cluster chart.  Optional (default is vertical).

The **oraChartSeries** attribute defines the source information for the graph. There are 5 of these attributes:

- **oraChartSeries1**
- **oraChartSeries2**
- **oraChartSeries3**
- **oraChartSeries4**
- **oraChartSeries5**

Stacked charts support an unlimited number of series by continuing to add attributes **oraChartSeries6** and above, but beware of performance implications and memory limits when using an excessively high number of series.

All attributes are identical in format and accept the same parameters, as described below.

---

**NOTE:** All the charts require **oraChartSeries1**. Stacked, Cluster and Line charts may optionally include the additional series attributes (for multiple bars/lines).

---

If you define multiple series, then data must be provided for all series defined. The data amounts can be 0 (zero) but they have to be present in order for the chart to display correctly.

The set of configuration parameters available for the **oraChartSeriesN** attribute are:

Parameter	Values	Description
<b>list:</b>	XPath value	Defines the XPath to the list in the XML that contains the data to chart.  Required
<b>amount:</b>	XPath value	Defines the XPath to the element in the XML list that contains the amount to chart.  Required

Parameter	Values	Description
<b>xaxis:</b>	XPath value	<p>Defines the XPath to the element in the XML list that contains the x-axis data.</p> <p>Required for Stacked, Cluster, Line, Area and Combo charts.</p>
<b>xaxisFormat:</b>	<b>date</b> <b>dateTime</b> <b>time</b> <b>localDate</b> <b>string</b>	<p>Defines the x-axis data format.</p> <p>If it is <b>date</b>, <b>dateTime</b> or <b>time</b> then the value is presented in the format as defined on the <a href="#">user's</a> display profile.</p> <p>In case of <b>localDate</b> or <b>string</b> the data is displayed as is with no special formatting.</p> <p>Optional (Default is <b>date</b>).</p>
<b>label:</b>	Text value	<p>Defines the label for the amount being charted.</p> <p>Either this setting or <b>labelPath:</b> must be defined.</p>
<b>labelPath:</b>	XPath value	<p>Defines the XPath to the element that provides the label for the amount being charted.</p> <p>Either this setting or <b>label:</b> must be defined.</p>
<b>currency:</b>	A valid Currency code	<p>Defines the currency code for the amount being charted.</p> <p>Optional.</p>
<b>currencyPath:</b>	XPath value	<p>Defines the XPath to the element that provides the currency code for the amount being charted.</p> <p>Optional.</p>
<b>hoverText:</b>	Text value	<p>Defines the hover text for the chart element.</p> <p>Optional (A default hover text is always available.) Ignored if <b>hoverTextPath:</b> is defined.</p> <p>The following substitution variables are available.</p> <ul style="list-style-type: none"> <li>• <b>\$label</b> This will be replaced with the label text as determined by the <b>label:</b> or <b>labelPath:</b> setting.</li> <li>• <b>\$amount</b> This will be replaced with the amount text as specified by the <b>amount:</b> setting.</li> <li>• <b>\$axis</b> This will be replaced with the x-axis text.</li> <li>• <b>\$%</b> This will be replaced by the percentage "slice" of the pie or bar.</li> <li>• <b>\$newline</b> This will be force a line break.</li> </ul>

Parameter	Values	Description
		<p>If the hover text defined contains any of the above values, they will be replaced by the equivalent text prior to being displayed.</p> <p>Example:</p> <pre>"hoverText:\$label\$newline\$amount"</pre>
<b>hoverTextPath:</b>	XPath value	<p>Defines the XPath to the element that provides the hover text for the chart element.</p> <p>The hover text in the XML can utilize all the substitution functionality described above in the <b>hoverText:</b> description.</p> <p>Optional.</p>
<b>type:</b>	<b>bar</b> <b>line</b> <b>area</b>	<p>This attribute is used for the <b>combo</b> chart type only. It defines how each series on the <b>combo</b> chart should be presented.</p> <p>The following example defines a <b>combo</b> chart where one series is rendered as bars and another one as area.</p> <pre>oraChart="type:combo;" oraChartSeries1="list:set; xaxis:date; label:Charge; amount:amount;type:bar" oraChartSeries2="list:set; xaxis:date; label:Balance; amount:balance;type:area"</pre>
<b>navOpt:</b>	A valid Navigation Option code.	<p>Defines a navigation option to be activated when the chart element is clicked.</p> <p>Optional.</p>
<b>navOptPath:</b>	XPath value	<p>Defines the XPath to a navigation option to be activated when the chart element is clicked.</p> <p>Optional</p> <p>Note that both <b>navOpt:</b> and <b>navOptPath:</b> may be configured. The XPath navigation option is processed first. If a value is found it is used, otherwise the value in the <b>navOpt:</b> setting is used. This means that the HTML can define a "default" navigation option and a navigation option present in the XML document will override it.</p>
<b>key:</b>	XPath value	<p>Defines the XPath to an XML element in the series list that contains the key field data to be used in a navigation option.</p> <p>This is required if either <b>navOpt:</b> or <b>navOptPath:</b> is defined.</p> <p><b>NOTE:</b> Only one key field can be configured for a navigation option.</p>
<b>script:</b>	A BPA script name	<p>Defines a BPA script to be activated when the chart element is clicked.</p> <p>Optional</p>

Parameter	Values	Description
		When a script is executed, all the elements from that list item will be made available to the script as temporary variables.
<b>scriptPath:</b>	XPath value	<p>Defines the XPath to a BPA script to be activated when the chart element is clicked.</p> <p>Optional</p> <p>Note that both <b>script:</b> and <b>scriptPath:</b> can be configured. The XPath script option is processed first. If a value is found it is used, otherwise the value in the <b>script:</b> setting is used. This means that the HTML can define a default script and a script present in the XML document will override it.</p>
<b>color:</b>	HTML Color code / RGB value	<p>Defines the color for the series. The format is valid HTML color code, e.g. <b>green</b>, <b>red</b> or <b>black</b>. All valid color names are defined in this link: <a href="http://www.w3schools.com/html/html_colornames.asp">http://www.w3schools.com/html/html_colornames.asp</a>.</p> <p>Alternatively an RGB format may be used. (<b>FF0000</b> is red, <b>00FF00</b> is green and <b>0000FF</b> is blue)</p> <p>Optional (default colors applied)</p>
<b>colorPath:</b>	XPath value	<p>Defines the XPath to a color for the series. The valid format as described in the <b>color:</b> setting apply.</p> <p>Optional (default colors applied)</p>
<b>pieColors:</b>	HTML color code / RGB values	<p>Defines the colors for the pie series. Any number of HTML color codes or RGB color values can be specified, separated by spaces.</p> <p>Examples:</p> <pre>pieColors: red green black pieColors: FF0000 00FF00</pre> <p>Optional (default colors applied if the series exceeds the values specified)</p>

### **oraChartBroadcast="FIELD\_NAME:XPath;"**

A chart configured in a map zone can be set to broadcast portal context. An unlimited number of fields can be broadcast, configured as name/value pairs, as follows:

1. **FIELD\_NAME:** the name of the portal context field to be broadcast.
2. **XPath:** the XML schema element from the same list item that corresponds to the user selected chart segment and contains the data value to be broadcast.

### **Graph Examples**

- Sample of a pie chart configuration:

```
<html>
<head>
```

```

<title>Pie Chart</title>
</head>
<body>

<div style="width:100%; height:290px;"
  oraChart="type:pie;"
  oraChartSeries1="list:set; labelPath:date; amount:amount; "
  oraChartBroadcast="BILL_ID:billId;">
</div>

</body>

<xml>
<root>
  <set>
<date>05-02-2003</date>
<amount>163.24</amount>
<billId>592211649441</billId>
  </set>
  <set>
<date>06-02-2003</date>
<amount>97.29</amount>
<billId>592211649442</billId>
  </set>
  <set>
<date>07-02-2003</date>
<amount>54.38</amount>
<billId>592211649443</billId>
  </set>
</root>
</xml>
</html>

```

- A pie chart rendered for a single series:

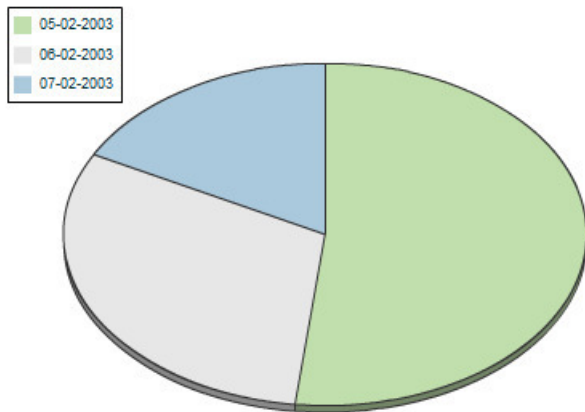

- Sample of a line, cluster, or stacked graph configuration - each with two series:

```

<html>
<head>
<title>Stacked Chart</title>
</head>
<body>

<div style="width:100%; height=300px;"
  oraChart="type:line;"
  oraChartSeries1="list:set; xaxis:date; label:Charge; amount:amount; "
  oraChartSeries2="list:set; xaxis:date; label:Balance; amount:balance; "
  oraChartBroadcast="BILL_ID:billId;">
</div>

<div style="width:100%; height=300px;"
  oraChart="type:cluster;"
  oraChartSeries1="list:set; xaxis:date; label:Charge; amount:amount; "

```

```

oraChartSeries2="list:set; xaxis:date; label:Balance; amount:balance; "
oraChartBroadcast="BILL_ID:billId;">
</div>

<div style="width:100%; height=300px;"
oraChart="type:stacked;"
oraChartSeries1="list:set; xaxis:date; label:Charge; amount:amount; "
oraChartSeries2="list:set; xaxis:date; label:Balance; amount:balance; "
oraChartBroadcast="BILL_ID:billId;">
</div>

</body>

<xml>
<root>
  <set>
<date>05-02-2003</date>
<amount>163.24</amount>
<balance>163.24</balance>
<billId>592211649441</billId>
  </set>
  <set>
<date>06-02-2003</date>
<amount>97.29</amount>
<balance>260.53</balance>
<billId>592211649442</billId>
  </set>
  <set>
<date>07-02-2003</date>
<amount>54.38</amount>
<balance>314.91</balance>
<billId>592211649443</billId>
  </set>
</root>
</xml>
</html>

```

- Three types of chart rendered for two series each: line, cluster, and stacked.



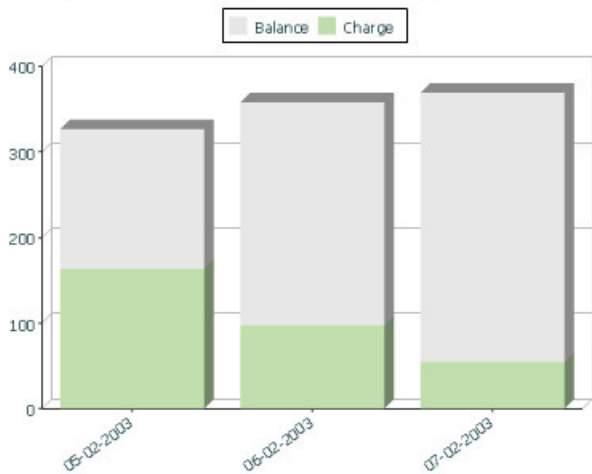
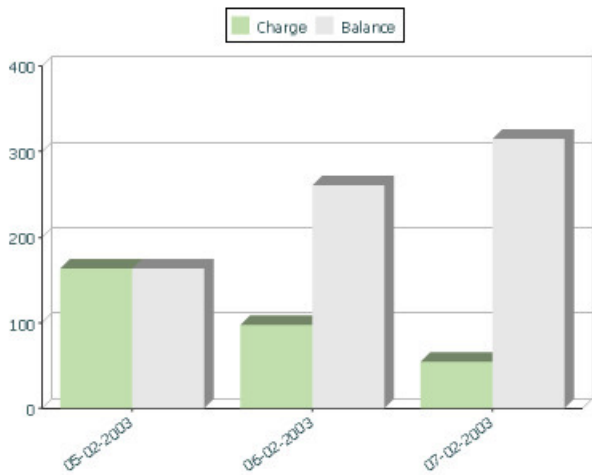
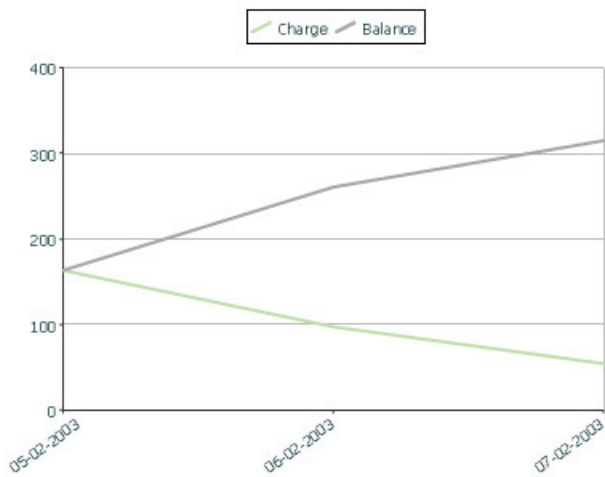

## Upload and Download a CSV File

The following HTML attributes can be used to manage both an upload and a download between a list defined within the map's schema and a CSV (comma separated value) file. Note that this technique is only recommended for a small to medium volume of data, for example no more than several hundred rows. For higher volumes, it is recommended to use batch upload / download functionality instead.

The syntax is `oraUploadData="type:embed;path:list xpath;useLabels:true;showCount:true"`

Upload configuration requires you to name a CSV file to be uploaded, and an XML list as target. By convention, each CSV row will create a separate list instance. Each comma-separated field in the file will be uploaded as a separate element in the list. To embed an upload dialog within a map, the **oraUploadData** attribute must be associated with a container element such as a div, td, or span.

The optional **useLabels:true** value indicates that while parsing the upload CSV file, the headers are expected to be labels

---

**NOTE:** If you do not specify the **useLabels:true** value and the XML target element name is "camelCase" then the corresponding spreadsheet header should be title case with a space between words, e.g.;"Camel Case". Letters and special characters are not considered a different word, for example Address1 must be uploaded into the target XML element address1.

---

Specifying the optional **showCount:true** value will display the number of records uploaded.

---

**CAUTION:** If you are using a grid in conjunction with the **oraUploadData** function, then you must maintain the grid's list with a 'replace' business object action. Refer to [BO Replace Action](#) for more information.

---

Sample of **oraUploadData="embed"** within a div element.

```
<html>
<head>
  <title>File Upload</title>
</head>
<body>

  <div oraUploadData="type:embed;path:myList" > </div>

</body>

<xml>
<root>
  <myList>
<id>838383930</id>
  <name>Janice Smith</name>
  </myList>
  <myList>
<id>737773730</id>
  <name>Bill McCollum</name>
  </myList>
</root>
</xml>
</html>
```

This file upload dialog will be embedded into the body of the page where the oraUploadData is defined.

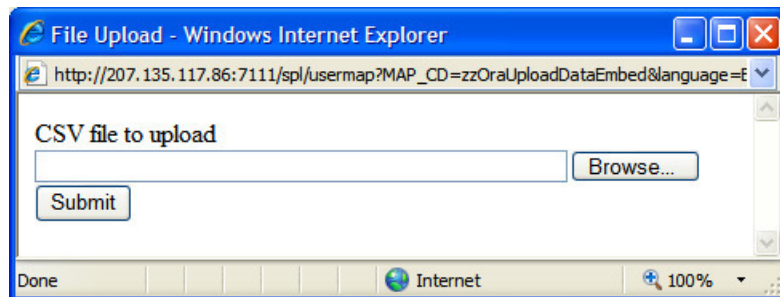

**oraUploadData="type:popup;path:list xpath;useLabels:true;showOk:true;showCount:true"**

Upload configuration requires you to name a CSV file to be uploaded, and an XML list as target. By convention, each CSV row will create a separate list instance. Each comma-separated field in the file will be uploaded as a separate element in the list. To upload a CSV file using a pop-up dialog, the oraUploadData attribute must be associated with an input element such as a button, text link, or image.

The optional useLabels:true value is used to indicate that while parsing the upload CSV file, the headers are expected to be labels

**NOTE:** If you do not specify the useLabels:true value and the XML target element name is "camelCase" then the corresponding spreadsheet header should be title case with a space between words, e.g., "Camel Case". Letters and special characters are not considered a different word, for example Address1 must be uploaded into the target XML element address1.

Specifying the optional showOk:true value will display an "Ok" button once the upload finishes. The popup will stay open until the button is pressed. Additionally, specifying the showCount:true value will display number of records uploaded.

**CAUTION:** If you are using a grid in conjunction with the **oraUploadData** function, then you must maintain the grid's list with a 'replace' business object action. Refer to [BO Replace Action](#) for more information.

Sample of oraUploadData="popup" associated with a button:

```
<html>
<head>
  <title>File Upload</title>
</head>
<body>
  <input type="button" name="submitButton" oraUploadData="type:popup;path:myList;" value='Get Data'>
  <table oraList="myList">
    <tr/>
    <tr>
<td><span oraField="id"/></td>
<td><span oraField="name"/></td>
    </tr>
  </table>
</body>
<xml>
<root>
  <myList>
<id>838383930</id>
  <name>Janice Smith</name>
  </myList>
  <myList>
<id>737773730</id>
  <name>Bill McCollum</name>
  </myList>
</root>
</xml>
</html>
```

HTML Rendered:

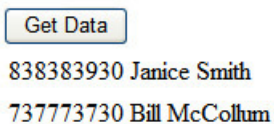

Pressing the "Get Data" button will launch a standard file upload dialogue (provided by Framework) as shown below.

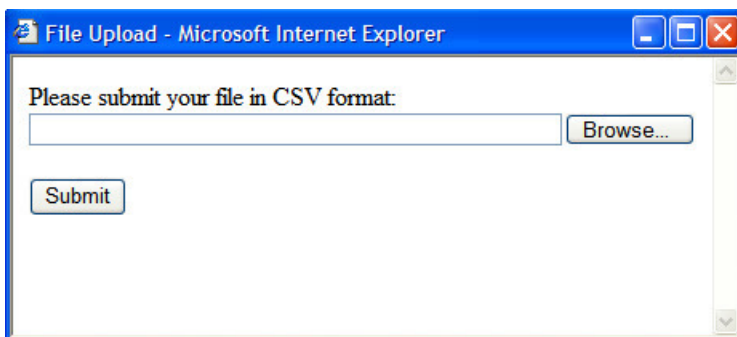

## oraDownloadData="list xpath"

Download configuration requires you to name an XML list to be downloaded. By convention, each list instance will represent a separate row in the created file. By default every element of the list will be comma separated in the file.

---

**NOTE:** The number formatting is based on the user profile setting. For localities where the decimal symbol is a comma, an implementation may configure a property setting (`spl.csv.delimiter.useFromDisplayProfile=true`) to cause the system to use a semicolon as the delimiter that separates the elements rather than a comma.

---

Sample of oraDownloadData.

```
<html>
<head>
<title>File Download</title></head>
<body>
<input type="button" name="downloadButton" oraDownloadData="myList" value="Download"/>
</body>
<xml>
<root>
  <myList>
    <id>881-990987</id>
    <name>John Mayweather</name>
  </myList>
  <myList>
    <id>229-765467</id>
    <name>Anna Mayweather</name>
  </myList>
  <myList>
    <id>943-890432</id>
    <name>Andrew Brewster</name>
  </myList>
</root>
</xml>
</html>
```

HTML Rendered:

Download

Pressing the "Download" button will launch a standard file download dialogue (provided by Framework) as shown below.

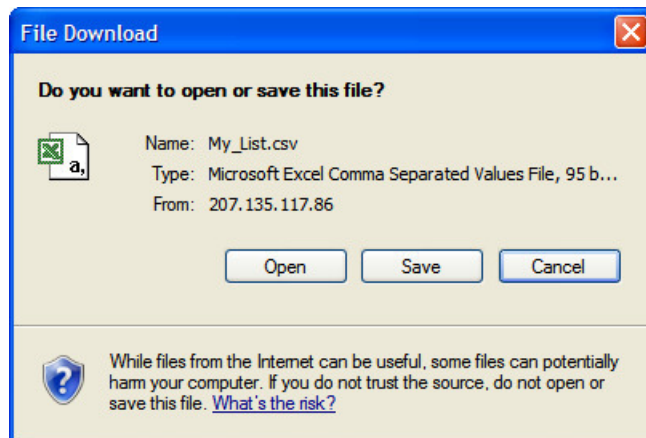

A successful download will result in a CSV file:

	A	B	C
1			
2	Id	Name	
3	881-99098	John Mayweather	
4	229-76546	Anna Mayweather	
5	943-89043	Andrew Brewster	
6			

To download data from a sub list use the attribute `oraDownloadDataInList` instead of `oraDownloadData`. The attribute `oraDownloadDataInList` will have the sub list name. The XPath of the sub list is used to pick data of the specific row from the parent list. Thus only the specific sub list is downloaded.

### **`oraDownloadDataUseLabels="true"`**

The `oraDownloadDataUseLabels` attribute can be used in conjunction with the `oraDownloadData` attribute described above. Specify `oraDownloadDataUseLabels` if you want the generated CSV file to use the element labels for columns headers rather than element names.

## **Construct Portal Zone Map Fragments**

Portal zones can reference a UI map for the zone header and filter area. This UI map is not a complete HTML document, but is instead configured as a UI Map fragment. When constructing a zone map fragment you can reference the following substitution variables. Note that these variables will be dynamically populated at run time with information particular to the map's zone within the portal:

<b>Variable</b>	<b>Replacement Logic</b>
<b>[\$ZONEDESCRIPTION]</b>	Zone's description text.
<b>[\$SEQUENCEID]</b>	Zone's sequence ID.
<b>[\$ZONENAME]</b>	Zone's name.
<b>[\$HELPTEXT]</b>	Zone's help text.
<b>[\$ZONEPARAMNAME]</b>	Zone parameter's value (or blank if it has not been specified).

### **WARNING:**

- Refer to one of the following maps as examples: F1-UIMapHeader and F1-ExplorerHeader.
- These maps make use of the [oraInclude](#) tag to incorporate HTML fragments for the header menu and framework actions. Refer to the zone type parameters for the UI Map fragments you should include in your HTML.
- If you wish to have the "help text" icon appear next to your zone description, you should have `id="title_[$SEQUENCEID]"` on the `<td>` that contains your description.
- If it is necessary to encapsulate JavaScript within a UI Map fragment, it will be necessary to bound the JavaScript within a `![CDATA[ ]]` tag to ensure a valid XML document. Note that the tags themselves may need to be commented out to promote compatibility with older browsers. For example:

```
<script type="text/javascript">
/* */
//
//javascript
//
*]]&gt; */
&lt;/script&gt;</pre>
</div>
<div data-bbox="467 942 913 959" data-label="Page-Footer">
<p>Oracle Utilities Customer to Meter Administrative User Guide • 225</p>
</div>
```

**NOTE:** If you wish to preserve the values of a filter input field, within a filter map fragment, for the framework 'Go Back' and 'Go Forward' functionality, you must associate the input field (text box, select, etc.) with a unique HTML id. Input field values associated with a unique id will be captured in the framework's 'memento'. The 'memento' is used to rebuild the input map when the portal zone is navigated to using the 'Go Back' or 'Go Forward' functionality.

**NOTE:** Many specialized functions exist to manipulate zone behavior, for example:

- **oraGetZoneSequence(zoneName).** Uses the zone's code to retrieve its sequence number.
- **oraIsZoneCollapsed(sequenceId).** Uses the zone's sequence to determine if collapsed.
- **oraHandleCollapse(seq).** Collapse a zone.
- **oraHandleExpand(seq,refresh).** Expand and/or refresh a zone.

All of these, and many more functions, are located within the JavaScript library [userMapSupport.js](#) described below.

**NOTE:** When executing oraLoad within a fragment UI map, and you need to execute a JavaScript function during page load (where the function invokes a business object, business service, or service script) you can use the special syntax "oraLoad[\$SEQUENCEID]". Refer to the [Load Page Event](#) section for more information.

Example of oraLoad[\$SEQUENCEID] used within a function:

```
<script type="text/javascript">
function oraLoad[$SEQUENCEID]() {
checkRebateClaimStatus();
}

function checkRebateClaimStatus() {
    var work = id('analyticsFilterText[$SEQUENCEID]',
document).cells[0].innerText.split(' ');
    var rebateClaimId = work[work.length - 3];
    id('rebateClaimId', document).value = rebateClaimId;
oraInvokeSS('C1-CheckRCSt','checkRebateClaimStatus', false);
    var statusIndicator = id('statusInd', document).value;
    if (statusIndicator == 'C1PE' || statusIndicator == 'C1ID') {
        id('addRebateClaimLine', document).style.display = '';
    } else {
id('addRebateClaimLine', document).style.display = 'none';
    }
}
</script>
```

**F1-ExplorerHeader** rendered:



### Invoking a Business Object

The oraInvokeBO function may be used within a portal zone header or zone filter map. It is similar to the command described in [Invoke BO Function](#) which allows for a business object to be invoked within the UI map's HTML. Refer to that section for a description of the first three parameters.

Syntax	Parameters	Comments
oraInvokeBO( )	'BO Name'	
	'XPath' or null	
	'action'	
	null	This must be specified as the fourth argument.
	<b>[\$SEQUENCEID]</b>	This must be specified as the fifth argument.

Syntax	Parameters	Comments
	<b>true   false</b>	Specify <b>true</b> if the fragment is used within a portal zone header. Specify <b>false</b> if the fragment is used with a zone filter map.

Example in a portal zone header:

```
oraInvokeBO('CM-User','xmlGroup','read', null, [SEQUENCEID], true)
```

## Invoking a Business Service

The oraInvokeBS function may be used within a portal zone header or zone filter map. It is similar to the command described in [Invoke BS Function](#) which allows for a business service to be invoked within the UI map's HTML. Refer to that section for a description of the first two parameters.

Syntax	Parameters	Comments
<b>oraInvokeBS( )</b>	'BO Name'	
	'XPath' or <b>null</b>	
	<b>null</b>	This must be specified as the fourth argument.
	<b>[SEQUENCEID]</b>	This must be specified as the fifth argument.
	<b>true   false</b>	Specify <b>true</b> if the fragment is used within a portal zone header. Specify <b>false</b> if the fragment is used with a zone filter map.

Example in a portal zone header:

```
oraInvokeBS('CM-UserSearch','xmlGroup', null, [SEQUENCEID], true)
```

## Invoking a Service Script

The oraInvokeSS function may be used within a portal zone header or zone filter map. It is similar to the command described in [Invoke SS Function](#) which allows for a service script to be invoked within the UI map's HTML. Refer to that section for a description of the first two parameters.

Syntax	Parameters	Comments
<b>oraInvokeSS( )</b>	'Service Script Name'	
	'XPath' or <b>null</b>	
	<b>null</b>	This must be specified as the fourth argument.
	<b>[SEQUENCEID]</b>	This must be specified as the fifth argument.
	<b>true   false</b>	Specify <b>true</b> if the fragment is used within a portal zone header. Specify <b>false</b> if the fragment is used with a zone filter map.

Example in a portal zone header:

```
oraInvokeSS('UserSearch','xmlGroup', null, [SEQUENCEID], true)
```

## Detecting Unsaved Changes

Use this function to return a Boolean set to true if there are unsaved changes. The system will interrogate the function when the user attempts to navigate and issue a warning accordingly. This function is only needed if a UI map is using custom

javascript to manage elements such that the system is not able to detect whether changes have been made. Also note that it's the responsibility of the UI map javascript to manage the values in the Boolean used for this function.

```
function hasUnsavedChanges(){
    return isDirtyFlag;
}
```

## Hiding Portal Tabs

The product provides the ability to use JavaScript to hide a tab on the current portal based on some condition using the oraAuthorizeTab JavaScript API. This API accepts a function as a parameter and turns off the tab index indicated.

For example, the UI Map may have a function to turn off one or more tab indexes.:

```
function overrideTabIndex(index){
    if (index == 2) return false;
    if (index == 3) return false;
}
```

The JavaScript is referenced "on load":

```
<body class="oraZoneMap"
onLoad="oraAuthorizeTabs(overrideTabIndex);">
```

## Required JavaScript Libraries

All of the functionality described in this document depends on a pair of JavaScript libraries. If you are writing and executing your maps entirely within the UI map rendering framework - you do not need to manually insert the following libraries - the framework will insert them for you when the UI Map is rendered.

---

**WARNING:** When executing HTML outside of the framework you must include the following references explicitly within your HTML. In addition, the tool you use to render the HTML must have access to a physical copy of privateUserMapSupport.js for bind support.

---

src="privateUserMapSupport.js"

Your HTML document must reference this library to execute binding in a stand-alone environment.

---

**WARNING:** Referencing functions within this JavaScript library is dangerous - because these functions are owned by framework and they may be changed during version upgrade or via the normal patch process.

---

```
<script type="text/javascript" src="privateUserMapSupport.js"></script>
```

src="userMapSupport.js"

To take advantage of optional toolset features, you must reference this library.

---

**NOTE:** You can reference the functions within this JavaScript library to write custom functions within the UI map..

---

```
<script type="text/javascript" src="userMapSupport.js"></script>
```

onload="oraInitializeUserMap();"

To execute binding in a stand-alone environment, you must embed the following onload function into the <body> node.

```
<body onload="oraInitializeUserMap();">
```



# UI Map Standards

## Contents

- [Basic UI Map Templates](#)
- [Basic HTML and Styles](#)
- [Grids \(Tables of Data\)](#)
- [Action Buttons](#)
- [Available Styles](#)
- [Using OJET](#)

## Basic UI Map Templates

All UI Maps share the same basic structure regardless of placement (page area, zone, pop-up) or usage (display only, input).

## Sample XML

All information in this document is based upon the following XML structure.

```
<xml>
  <root>
    <address>123 Main St</address>
    <city>Alameda</city>
    <state>CA</state>
    <zip>94770</zip>
    <contactInformation>
      <type>Home Phone</type>
      <number>510-555-2287</number>
    </contactInformation>
    <contactInformation>
      <type>Cell Phone</type>
      <number>510-555-4285</number>
    </contactInformation>
  </root>
</xml>
```

## Display Only UI Map

```
<html>
<head>
  <title oraMdLabel="ADDRESS_LBL"></title>
  <link rel="stylesheet" type="text/css" href="cisDisabled.css"/>
  <link rel="stylesheet" type="text/css" href="cisEnabled.css"/>
</head>
<body class="oraZoneMap">
<table cellpadding="4" width="100%">
  <colgroup>
    <col class="oraLabel oraTableLabel" />
    <col class="oraNormal oraTableData" />
  </colgroup>
  <tr>
    <td oraLabel="address"></td>
    <td oraField="address"></td>
  </tr>
  <tr>
    <td oraLabel="city"></td>
    <td oraField="city"></td>
  </tr>
  <tr>
    <td oraLabel="state"></td>
    <td oraField="state"></td>
  </tr>
  <tr>
    <td class="oraSectionEnd" oraLabel="zip"></td>
    <td class="oraSectionEnd" oraField="zip"></td>
  </tr>
</table>
```

```

        <td colspan="2" class="oraSectionHeader" oraMdLabel="CONTACT_LBL"></td>
</tr>
<tr>
  <td colspan="2" class="oraSectionStart oraEmbeddedTable">
    <table oraList="contactInformation" cellspacing="2">
      <thead >
        <tr>
          <th class="oraGridColumnHeader" nowrap="nowrap">
            <span oraLabel="contactInformation/type"></span>
          </th>
          <th class="oraGridColumnHeader" nowrap="nowrap">
            <span oraLabel="contactInformation/number"></span>
          </th>
        </tr>
      </thead >
      <tbody>
        <tr>
          <td class="oraNormalAlt oraDisplayCell">
            <span oraField="type"></span>
          </td>
          <td class="oraNormal oraDisplayCell">
            <span oraField="number"></span>
          </td>
        </tr>
      </tbody>
    </table>
  </td>
</tr>
</table>
</body>
<xml>
  <root>
    <address>123 Main St</address>
    <city>Alameda</city>
    <state>CA</state>
    <zip>94770</zip>
    <contactInformation>
      <type>Home Phone</type>
      <number>510-555-2287</number>
    </contactInformation>
    <contactInformation>
      <type>Cell Phone</type>
      <number>510-555-4285</number>
    </contactInformation>
  </root>
</xml>
</html>

```

## Input UI Map

```

<html>
<head>
  <title oraMdLabel="ADDRESS_LBL"></title>
  <link rel="stylesheet" type="text/css" href="cisDisabled.css"/>
  <link rel="stylesheet" type="text/css" href="cisEnabled.css"/>
</head>
<body>
<table width="100%" cellpadding="12">
  <tr class="oraErrorText">
    <td><a href="" onclick="oraShowErrorAlert(); return false;">
      <span class="oraErrorText" oraErrorVar="ERRMSG-TEXT"></span></a>
    </td>
  </tr>
</table>
<table cellspacing="4" width="100%">
  <colgroup>
    <col class="oraLabel oraTableLabel" />
    <col class="oraNormal oraTableData" />
  </colgroup>
  <tr>
    <td oraLabel="address"></td>
    <td><input type="text" oraField="address"/></td>
  </tr>
</table>

```

```

</tr>
<tr>
  <td oraLabel="city"></td>
  <td><input type="text" oraField="city"/></td>
</tr>
<tr>
  <td oraLabel="state"></td>
  <td><input type="text" oraField="state"/></td>
</tr>
<tr>
  <td oraLabel="zip"></td>
  <td><input type="text" oraField="zip"/></td>
</tr>
<tr>
  <td colspan="2" class="oraSectionHeader" oraMdLabel="CONTACT_LBL"></td>
</tr>
<tr>
  <td colspan="2" class="oraSectionStart oraEmbeddedTable">
    <table oraList="contactInformation" cellspacing="2">
      <thead >
        <tr>
          <th class="oraGridColumnHeaderButton"></th>
          <th class="oraGridColumnHeaderButton"></th>
          <th class="oraGridColumnHeader" nowrap="nowrap">
            <span oraLabel="contactInformation/type"></span>
          </th>
          <th class="oraGridColumnHeader" nowrap="nowrap">
            <span oraLabel="contactInformation/number"></span>
          </th>
        </tr>
      </thead >
      <tbody>
        <tr>
          <td oraType="addGridRow"></td>
          <td oraType="deleteGridRow"></td>
          <td>
            <input type="text" oraField="type"/>
          </td>
          <td>
            <input type="text" oraField="number"/>
          </td>
        </tr>
      </tbody>
    </table>
  </td>
</tr>
<tr>
  <td colspan="2" class="oraSectionStart oraEmbeddedTable">
    <table cellspacing="2">
      <tr>
        <td>
          <input class="oraButton" oraMdLabel="C1_SAVE_LBL" type="button"
            onClick="oraSubmitMap('OK');"/>
        </td>
        <td>
          <input class="oraButton" oraMdLabel="CANCEL_LBL" type="button"
            onClick="oraSubmitMap('CANCEL',false);"/>
        </td>
      </tr>
    </table>
  </td>
</tr>
</table>
</body>
<xml>
  <root>
    <address>123 Main St</address>
    <city>Alameda</city>
    <state>CA</state>
    <zip>94770</zip>
    <contactInformation>
      <type>Home Phone</type>
    </contactInformation>
  </root>

```

```

        <number>510-555-2287</number>
    </contactInformation>
</contactInformation>
    <type>Cell Phone</type>
    <number>510-555-4285</number>
</contactInformation>
</root>
</xml>
</html>

```

## Basic HTML and Styles

The basic templates introduced the standard HTML and styles used for UI Maps. These standards are described individually in the following sections.

### Stylesheets

The styles to apply the standard look to the maps are all contained in stylesheets. These stylesheets should be included in all UI Maps.

```

...
    <link rel="stylesheet" type="text/css" href="cisDisabled.css"/>
    <link rel="stylesheet" type="text/css" href="cisEnabled.css"/>
...

```

### Title

Each UI Map should have a <title> tag.

```

...
    <title oraMdLabel="ADDRESS_LBL"></title>
...

```

This will give the UI Map a descriptive title.

- If the UI Map is presented in a "pop-up", the title will be in the window title bar.
- If the UI Map is presented in the page area, the title will be added as a <span> tag to the UI Map and will appear at the top of the UI Map.
- If the UI Map is presented as a zone map, it will be ignored. The <title> tag should still be included in the HTML as standard.

### Zone Maps

When the map is presented in a zone as part of a portal, the UI Map should have a border so that the information is "contained" within the zone.

```

...
    <body class="oraZoneMap">
...

```

### Page Area Maps vs Pop-Up Maps

The presentation of the UI Maps can vary from design to design. The following standards have been applied to decide when to use a Page Area UI Map and when to use a Pop-Up Map:

- If there are multiple UI Maps in the sequence, always use the Page Area.
- If the UI Map has many input fields, always use a Page Area.
- If the UI Map is a "confirmation" type dialog or only has one or two input fields, use a Pop-Up.

---

**NOTE:** The difference between "just a few input fields" and "many input fields" can be discretionary. The final decision should rest with the dialog designer.

---

## Error Messages

Input maps have a ability to present error messages to the User.

```
...
<table width="100%" cellpadding="12">
  <tr class="oraErrorText">
    <td><a href="" onclick="oraShowErrorAlert(); return false;">
      <span class="oraErrorText" oraErrorVar="ERRMSG-TEXT"></span></a></td>
    </tr>
  </table>
...
```

This HTML structure provides the necessary elements and functions to display errors to the User. It should be directly after the <body> tag. When there is no error, nothing will be visible on the UI Map. It will be made visible if an error occurs and the UI Map is re-presented to the User. Clicking on the link (when visible) will result in a pop-up alert appearing with the long error message text.

## Standard Layout and Styles

The information is presented on the UI Map by using a <table> to organize the information in rows and columns.

```
...
<table cellspacing="4" width="100%">
<colgroup>
<col class="oraLabel oraTableLabel" />
  <col class="oraNormal oraTableData" />
</colgroup>
...
```

The <colgroup> and <col> tags allow for the application of classes to the columns (the label is in the first column and the data is in the second column.). Using these tags mean that the class attribute (to apply styles) does not need to be defined on every <td>.

## Grids (Tables of Data)

A UI Map could contain information that is best presented as a grid. These are referred to as "Embedded Tables". The embedded table can be used to display information or input information.

### Example Embedded Table HTML

The embedded table will be included within a row (<tr>) of the basic layout:

```
...
<tr>
  <td colspan="2" class="oraEmbeddedTable">
    <table oraList="contactInformation" cellspacing="2">
      <thead >
        <tr>
          <th class="oraGridColumnHeader" nowrap="nowrap">
            <span oraLabel="contactInformation/type"></span>
          </th>
          <th class="oraGridColumnHeader" nowrap="nowrap">
            <span oraLabel="contactInformation/number"></span>
          </th>
        </tr>
      </thead >
      <tbody>
        <tr>
          <td class="oraNormalAlt oraDisplayCell">
            <span oraField="type"></span>
          </td>
          <td class="oraNormal oraDisplayCell">
            <span oraField="number"></span>
          </td>
        </tr>
      </tbody>
    </table>
  </td>
</tr>
```

```

    </td>
</tr>
...
<xml>
  <root>
    <address> 123 Main St</address>
    <city>Alameda</city>
    <state>CA</state>
    <zip>94770</zip>
    <contactInformation>
      <type>Home Phone</type>
      <number>510-555-2287</number>
    </contactInformation>
    <contactInformation>
      <type>Cell Phone</type>
      <number>510-555-4285</number>
    </contactInformation>
  </root>
</xml>

```

## Embedding the Table

The embedded table is included within the overall table structure. The `colspan` attribute ensures that the embedded table can span the standard two columns of the overall layout table.

```

...
<tr>
  <td colspan="2" class="oraEmbeddedTable">
    ...
    ...
    ...
  </td>
</tr>
...

```

## Embedded Table Structure

The embedded table is very similar to the basic layout table.

```

...
<table oraList="contactInformation" cellspacing="2">
<thead>
  ...
  ...
</thead>
<tbody>
  ...
  ...
</tbody>
</table>
...

```

- The `<table>` tag has a slightly smaller cellspacing and it defines the "list" element contained in the XML that will be used to provide the data.
- The `<thead>` element is used to give the embedded table headings for the columns.
- The `<tbody>` element is the element that will be repeated for each referenced "list" element in the XML. In the previous example, there are two "contactInformation" list elements, so the displayed embedded table will have two rows.

## Column Headings

Embedded tables should have headings for the displayed columns. The `<thead>` tag defines these.

```

...
<thead>
  <tr>
    <th class="oraGridColumnHeader" nowrap="nowrap">
      <span oraLabel="contactInformation/type"></span>
    </th>

```

```

        <th class="oraGridColumnHeader" nowrap="nowrap">
            <span oraLabel="contactInformation/number"></span>
        </th>
    </tr>
</thead>
...

```

The "nowrap" attribute prevent the column heading from taking multiples lines. If multiples lines are required, the "nowrap" may be removed.

## Input Fields

Embedded tables may be used for input as well as display only. The framework provides a convenient control to assist in the creation of editable embedded tables.

```

...
<tr>
    <td colspan="2" class="oraEmbeddedTable">
        <table oraList="contactInformation" cellspacing="2">
            <thead >
                <tr>
                    <th class="oraGridColumnHeaderButton"></th>
                    <th class="oraGridColumnHeaderButton"></th>
                    <th class="oraGridColumnHeader" nowrap="nowrap">
                        <span oraLabel="contactInformation/type"></span>
                    </th>
                    <th class="oraGridColumnHeader" nowrap="nowrap">
                        <span oraLabel="contactInformation/number"></span>
                    </th>
                </tr>
            </thead >
            <tbody>
                <tr>
                    <td oraType="addGridRow"></td>
                    <td oraType="deleteGridRow"></td>
                    <td>
                        <input type="text" oraField="type" />
                    </td>
                    <td>
                        <input type="text" oraField="number" />
                    </td>
                </tr>
            </tbody>
        </table>
    </td>
</tr>
...

```

There are two new columns added to the input embedded table.

- oraType="addGridRow" will add a "+" button to the row. This will allow the User to add an additional row to the existing grid.
- oraType="deleteGridRow" will add a "-" button to the row. This will allow the User to delete an existing row from the grid.

---

**NOTE:** The <thead> tag also requires these two new columns to be added.

---

These controls are, as standard, placed at the beginning of the row in the order shown. Either of the controls may be omitted if required (if, for example, Users are not permitted to delete information).

The presence of either of these controls will activate the "empty list" process. This means that if the XML has no data for the "list" specified, the input grid will display with an empty row ready for the input of new information.

## Action Buttons

### Example Action Button HTML

Action buttons are used to perform some specified function from the UI Map. The actions are as varied as the information being displayed/updated. Below are two common examples:

- Save. Normally used on an Input UI Map to allow a User to save any changes they have made.
- Cancel. Normally used on an Input UI Map to allow a User to cancel changes in progress.

```
...
<tr>
  <td colspan="2" class=" oraEmbeddedTable">
    <table cellspacing="2">
      <tr>
        <td>
          <input class="oraButton" oraMdLabel="C1_SAVE_LBL" type="button"
            onClick="oraSubmitMap( 'OK' );"/>
        </td>
        <td>
          <input class="oraButton" oraMdLabel="CANCEL_LBL" type="button"
            onClick="oraSubmitMap( 'CANCEL' ,false);"/>
        </td>
      </tr>
    </table>
  </td>
</tr>
...
```

### Button Standards

The following points highlight some standards related to buttons.

- Buttons are included as an embedded table.
- Buttons should be grouped together. They should not be placed in different areas of the UI Map.
- The location of the buttons depends mainly on the type of UI Map.
  - Display Only UI Maps should have a Record Actions section in the upper right section of the UI map.
  - Input UI Maps should have the buttons at the foot of the UI Map (after all input fields).

### Available Styles

Styles are all contained in the referenced CSS stylesheets. They are applied by the HTML "class" attribute. The actual style settings used are not documented here as they may be adjusted. This section only specifies when a particular style should be used.

---

**NOTE:** The "class" attribute may reference more than one style (class="oraLabel oraSectionEnd")

---

Style	Comments	Example
<b>oraButton</b>	Applied to <input> elements where the type is button.	... <input class="oraButton" oraMdLabel="CANCEL_LBL" type="button" onClick="oraSubmitMap( 'CANCEL' ,false);"/> ...
<b>oraDisplayCell</b>	Applied to the <td> tag of an embedded table. It defines how the table cell looks (not the data contained inside the cell).	... <td class="oraDisplayCell"> <span oraField="type"></span> </td>



Style	Comments	Example
<b>oraEmbeddedTable</b>	Applied to the <td> tag that will contain the embedded table.	<pre> ... &lt;tr&gt;   &lt;td colspan="2" class=" oraEmbeddedTable"&gt;     &lt;table cellpadding="2"&gt;       ...       ...       ...     &lt;/table&gt;   &lt;/td&gt; &lt;/tr&gt; ... </pre>
<b>oraError</b>	<p>This style is applied to elements that are identified as "error elements". Refer to <a href="#">Display Errors</a> for more information.</p> <p><b>NOTE:</b> This style is not normally applied directly in the UI Map HTML</p>	
<b>oraErrorText</b>	This style is applied to the elements concerned with error messages.	<pre> ... &lt;table width="100%" cellpadding="12"&gt;   &lt;tr class="oraErrorText"&gt;     &lt;td&gt;&lt;a href="#"       onclick="oraShowErrorAlert();       return false;"&gt;       &lt;span class="oraErrorText"         oraErrorVar="ERRMSG-TEXT"&gt;&lt;/span&gt;     &lt;/a&gt;     &lt;/td&gt;   &lt;/tr&gt; &lt;/table&gt; ... </pre>
<b>oraGridColumnHeader</b>	This style is applied to the <td> tags that define column headers within embedded table.	<pre> ... &lt;thead &gt;   &lt;tr&gt;     &lt;th class="oraGridColumnHeaderButton"&gt;&lt;/th&gt;     &lt;th class="oraGridColumnHeaderButton"&gt;&lt;/th&gt;     &lt;th class="oraGridColumnHeader"       nowrap="nowrap"&gt;       &lt;span oraLabel="contactInformation/type"&gt;     &lt;/span&gt;&lt;/th&gt;     &lt;th class="oraGridColumnHeader"       nowrap="nowrap"&gt;       &lt;span oraLabel="contactInformation/number"&gt;     &lt;/span&gt;&lt;/th&gt;   &lt;/tr&gt; &lt;/thead &gt; ... </pre>
<b>oraGridColumnHeaderButton</b>	This style is applied to the <td> tags that define the column headers for the "+" and "-" buttons used on editable embedded tables.	<pre> ... &lt;thead &gt;   &lt;tr&gt;     &lt;th class="oraGridColumnHeaderButton"&gt;     &lt;/th&gt;     &lt;th class="oraGridColumnHeaderButton"&gt;     &lt;/th&gt;     &lt;th class="oraGridColumnHeader" nowrap="nowrap"&gt;       &lt;span oraLabel="contactInformation/type"&gt;     &lt;/span&gt;&lt;/th&gt;     &lt;th class="oraGridColumnHeader"       nowrap="nowrap"&gt;       &lt;span oraLabel="contactInformation/number"&gt;     &lt;/span&gt;&lt;/th&gt;   &lt;/tr&gt; &lt;/thead &gt; ... </pre>
<b>oraInput</b>	<p>This style is applied to input fields:</p> <ul style="list-style-type: none"> <li>&lt;input type="text"&gt;</li> </ul>	<pre> ... &lt;input type="text" class="oraInput"   oraField="address" /&gt; ... </pre>

Style	Comments	Example
	<ul style="list-style-type: none"> <li>• &lt;input type="checkbox"&gt;</li> <li>• &lt;select&gt;</li> <li>• &lt;textarea&gt;</li> </ul> <p><b>NOTE:</b> This can normally be omitted as input styles are applied automatically when oraSchemaDataTypes="true".</p>	
<b>oraInputMoney</b>	<p>This style is applied to input fields:</p> <ul style="list-style-type: none"> <li>• &lt;input type="text"&gt;</li> <li>• &lt;select&gt; (rare)</li> <li>• &lt;textarea&gt; (not recommended)</li> </ul> <p><b>NOTE:</b> This can normally be omitted as input styles are applied automatically when oraSchemaDataTypes="true".</p>	<pre>... &lt;input type="text" class="oraInputMoney"   oraField="amount" /&gt; ...</pre>
<b>oraInputNumber</b>	<p>This style is applied to input fields:</p> <ul style="list-style-type: none"> <li>• &lt;input type="text"&gt;</li> <li>• &lt;select&gt; (rare)</li> <li>• &lt;textarea&gt; (not recommended)</li> </ul> <p><b>NOTE:</b> This can normally be omitted as input styles are applied automatically when oraSchemaDataTypes="true".</p>	<pre>... &lt;input type="text" class="oraInputNumber"   oraField="count" /&gt; ...</pre>
<b>oraLabel</b>	<p>This style is applied to standard label fields that are right aligned.</p> <p><b>NOTE:</b> This can normally be omitted as it is applied by the &lt;col&gt; tag.</p>	<pre>... &lt;td class="oraLabel"   oraLabel="address"&gt;&lt;/td&gt; ...</pre>
<b>oraLabelAlt</b>	<p>This style is applied to standard label fields only if it is desired to have the label aligned to the left.</p>	<pre>... &lt;td class="oraLabelAlt"   oraLabel="address"&gt;&lt;/td&gt; ...</pre>
<b>oraLabelCenter</b>	<p>This style is applied to standard label fields only if it is desired to have the label aligned in the center of the cell.</p>	<pre>... &lt;td class="oraLabelCenter"   oraLabel="address"&gt;&lt;/td&gt; ...</pre>
<b>oraLink</b>	<p>This style is applied to foreign key references (links). This is automatically added by the UI Map framework but can also be used manually if desired.</p>	<pre>... &lt;td class="oraLabel"&gt;   &lt;a href="www.google.com"     class="oraLink"&gt;Google&lt;/a&gt;&lt;/td&gt; ...</pre>
<b>oraNormal</b>	<p>This style is applied to standard data fields (display only) that are left aligned.</p>	<pre>... &lt;td class="oraNormal"   oraField="address"&gt;&lt;/td&gt; ...</pre>

Style	Comments	Example
	<p><b>NOTE:</b> This can normally be omitted as it is applied by the &lt;col&gt; tag.</p>	
<b>oraNormalAlt</b>	This style is applied to standard data fields (display only) only if it is desired to have the data aligned to the right.	<pre>... &lt;td class=" oraNormalAlt"   oraField="address"&gt;&lt;/td&gt; ...</pre>
<b>oraNormalCenter</b>	This style is applied to standard data fields (display only) only if it is desired to have the data aligned in the center of the cell.	<pre>... &lt;td class=" oraNormalCenter"   oraField="address"&gt;&lt;/td&gt; ...</pre>
<b>oraPageTitle</b>	<p>This style is applied to the element that contains the page title.</p> <p><b>NOTE:</b> This style is not normally applied directly in the UI Map HTML. The &lt;span&gt; is created by the UI Map framework when the UI Map is displayed in the page area.</p>	<pre>... &lt;span class=" oraPageTitle"   oraMdField="PAGE_TITLE_LBL"&gt;&lt;/span&gt; ...</pre>
<b>oraSectionEnd</b>	<p>This style is applied to the &lt;td&gt; tags at the end of a "section" (group of elements). It provides some space to separate the section from the following information.</p> <p><b>NOTE:</b> The style must be applied to both &lt;td&gt; tags or the label may be misaligned with the data/input.</p>	<pre>... &lt;tr&gt;   &lt;td class="oraSectionEnd"     oraLabel="zip"&gt;   &lt;/td&gt;   &lt;td class="oraSectionEnd"     oraField="zip"&gt;   &lt;/td&gt; &lt;/tr&gt; ...</pre>
<b>oraSectionHeader</b>	<p>This style is applied to the &lt;td&gt; tag used to give a heading for a section within the information being displayed. It does not provide spacing before or after itself. The oraSectionStart and oraSectionEnd classes are used for this.</p> <p><b>NOTE:</b> The section header should span both the label column and the data column.</p>	<pre>... &lt;tr&gt;   &lt;td class="oraSectionHeader"     colspan="2"     oraMdField="DATA_SECTION_LBL"&gt;&lt;/td&gt; &lt;/tr&gt; ...</pre>
<b>oraSectionStart</b>	<p>This style is applied to the &lt;td&gt; tags at the start of a "section" (group of elements). It provides some space to separate the section from the previous information (often a section header).</p> <p><b>NOTE:</b> The style must be applied to both &lt;td&gt; tags or the label may be misaligned with the data/input.</p>	<pre>... &lt;tr&gt;   &lt;td class="oraSectionStart"     oraLabel="zip"&gt;&lt;/td&gt;   &lt;td class="oraSectionStart"     oraField="zip"&gt;&lt;/td&gt; &lt;/tr&gt; ...</pre>
<b>oraTableData</b>	This style is applied to the <col> tag for the data column of the main table (second column). It is used to provide a percentage width for the horizontal space to be used for the information.	<pre>... &lt;colgroup&gt;   &lt;col class="oraLabel     oraTableLabel" /&gt;   &lt;col class="oraNormal     oraTableData" /&gt; &lt;/colgroup&gt; ...</pre>
<b>oraTableLabel</b>	This style is applied to the <col> tag for the label column of the main table (first column). It is used	<pre>... &lt;colgroup&gt;   &lt;col class="oraLabel     oraTableLabel" /&gt;   &lt;col class="oraNormal     oraTableData" /&gt; &lt;/colgroup&gt; ...</pre>

Style	Comments	Example
	to provide a percentage width for the horizontal space to be used for the labels.	<pre>&lt;col class="oraNormal oraTableData" /&gt; &lt;/colgroup&gt; ...</pre>
<b>oraTinyText</b>	This style is typically applied directly beneath an <input> tag to provide information or a hint to the user concerning information relevant to the input. For example, name or address format.	<pre>... &lt;tr&gt;   &lt;td oraLabel="address"&gt;&lt;/td&gt;   &lt;td&gt;     &lt;input type="text" oraField="address" /&gt;     &lt;div class="oraTinyText"       oraField="addressFormatHint"&gt;&lt;/div&gt;   &lt;/td&gt; &lt;/tr&gt; ...</pre>
<b>oraZoneMap</b>	This style is used applied when the UI Map is to be displayed as a zone on a portal.	<pre>... &lt;body class="oraZoneMap"&gt; ...</pre>

## Using OJET

There are some UI maps delivered by the product that use UI widgets provided by Oracle JavaScript Extension Toolkit (OJET). Releases for OJET do not always align with releases of the framework. In addition, there are times when OJET adjusts APIs that the product uses. The framework will attempt to ensure that each release of the product has the latest and greatest version of the OJET libraries. Implementations are discouraged from attempting to use features in OJET that are not used by the product because the product is not necessarily testing those features and is not ensuring that upgrades to the APIs for those features are backward compatible.

Note that the product isolates the references to OJET into a UI map fragment that is included in the maps that use OJET widgets. This is so that changes to future versions of OJET are minimized to a single place. The map is called F1-OJETLIBS. If your implementation wants to use OJET, the recommendation is to use this UI map fragment.

## Ensuring Unique Element IDs for UI Maps

The following describes how to modify JavaScript code to ensure the proper rendering of unique element IDs for UI Maps.

The modification is required only for code that renders HTML using a `getElementById()` (or similar) function to generate list IDs and avoid account verification or related errors.

The following sample snippet contains the necessary modifications:

```
...
function getElementsFromList(namePrefix) {
  var ret = [];
  var elements = document.getElementsByTagName("INPUT");
  for(var i=0;i<elements.length;i++) {
    var elemID = elements[i].id;
    if((id) && (id.startsWith(namePrefix + '_'))) {
      ret.push(elements[i]);
    }
  }
}
...
return ret;
```

Since IDs aren't necessarily unique in generated UI Map IDs, the code shown above ensures uniqueness at runtime by appending an underscore and row number (e.g., `myField_1`, `myField_2`) for proper handling by Framework in the rendered HTML, while still allowing you to reference the unmodified IDs contained in the generated UI Map.

A switch in the `spl.properties` file also permits you to disable the generation of unique IDs for elements in a grid (as described below), though, for standards compliance reasons, it is highly recommended that this switch be left at its default value.

```
Property Name: spl.runtime.compatibility.uiMapDisableGenerateUniqueHtmlIDs
File Name: spl.properties (under web project in FW)
Default Value: false
Accepted Values: true or false
Description: This property controls the generation of unique IDs for all input elements inside
a list. When this value is set to true it disables the generation of unique IDs, thus
replicating the old behavior. When this property is set to false or this property is missing
it enables the generation of unique IDs, thus enabling the list to be standards-compliant.
```

## Process Flows

This section describes concepts and provides guidelines related to the configuration of various type of process flows.

## Understanding Process Flows

A process flow is a user interface guiding a user through a series of actions in order to accomplish a specific task. The task can be as simple as the collection of information in order to update business data or involve more complex logic such as submitting and tracking batch processes, exchanging messages with an external system, etc.

This section describes topics related to designing and working with process flows.

### A Process Flow Is Made Of Panels

Each process flow consist of a number sequential "steps" needed to accomplish a certain task. Each step is represented by a stop on a progress bar and an associated panel.

Progress is linear in that each step may only lead to a single next step. A process flow always starts at a single initial step but allows for one or more final steps at which the user may choose to complete the process.

At any step the user may take the following actions:

- Enter data or take action as prompted by the panel of the step.
- Continue to a next step, if any.
- Navigate back to any step they have previously visited.
- Finish the process flow if the current step is a final step.
- Save off their work on the process flow and either continue their work or navigate away. At a later time the user may resume their work on the process flow from where they have left off.
- Cancel the process flow.

A process flow type defines the entire metadata needed to control the behavior of process flows of a given type. This includes the sequence of steps, the panel and rules associated with each step and more.

### Panel Presentation

The panel presented on each step of the process flow is rendered based on the panel type selected on the step configuration.

For a **Data Area** type of panel, the panel is rendered using UI Hints built into the schema of a specified data area.

For a **UI Map** type of panel, the panel is rendered using a specified UI map fragment.

For a **Panel Set** type of panel, the panel is rendered as a set of tabs, one for each panel that references the current panel as its parent panel. Clicking on each tab renders the UI based on the selected panel's type. The behavior of a panel set is analogous to or can be thought of as a nested process flow within a single panel. A panel set may not include another panel set.

## A Single UI Map

While the user enters data one panel at a time, data is collected and captured at the entire process flow level. All the elements edited and displayed on the various panels of the process flow must be included in the overall process schema and referenced by their appropriate xpath location in that schema. Each type of process flow defines its unique schema on a designated UI map.

The HTML of such UI map should simply include the **Process Flow Controller (F1-ProcessController)** UI map fragment and nothing else. The latter is designed to render the user interface for a process flow based on the metadata defined on its process flow type.

## Panel Scripts

A single **Pre-Processing** service script may be associated with a panel for the purpose of preparing the data before the panel is presented to the user. The system calls the script each time the user navigates to this panel on a non finalized process flow.

A single **Post-Processing** service script may be associated with a panel for the purpose of validating the data entered by the user on that panel. The system calls the script each time the user exits the panel on a non finalized process flow.

## Process Flow Scripts

A single **Process Start** service script may be associated with a process flow for the purpose of preparing the data before a newly initiated process flow is presented to the user.

A single **Process End** service script is executed when the user clicks on the **Finish** button to complete the process flow. Entire data collected by the process flow UI map schema is provided to this service script for final processing.

---

### NOTE:

---

The schema of these scripts should be the same as the **Process Flow UI map** schema. This would ensure that business rules have access to the entire data captured by the user.

## Launching A New Process Flow

Each process flow must be initiated and executed by a designated BPA script that has the following simple steps:

- Set BPA area height to zero.
- Populate the temporary variable **\$processCode** with the code of the specific process flow type.
- Transfer control to the **Process Flow Navigation (F1-PROCEXEC)** common BPA script.

Launching a process flow of a specific type is assumed to be made from a designated menu option or within a specific context applicable to that type of work. As such this item needs to be configured specifically for each type of process flow. The navigation option associated with that launching option should reference the BPA script associated with the corresponding type of process flow.

## Saving Off Work

The user may save off their work on a process flow at any time. If enabled on the process flow type, the system would also automatically save the data when the user navigates to another panel or away from the process flow portal.

On either manual or automatic save operations, the **Process Manager** script defined on the process flow type is called to save off the entire process flow data on a designated record in the database.

The base product provides a generic **Process Flow** maintenance object that is designed to support the storage of any type of process flow as well a corresponding process manager script. Should process flows of a specific type be stored elsewhere then a dedicated process manager script should be implemented and used instead.

## Review Process Flow Records

A process flow record is created when a user saved off their work or the process flow type enables automatic saving. When the user finishes a process flow, depending on the process flow type configuration the record may be deleted or retained for audit purposes.

Reviewing process flow records of a specific type is assumed to be made from a designated menu option or within a specific context applicable to that type of work. As such this item needs to be configured specifically for each type of process flow. The navigation option associated with that item should reference a query portal designed to query and manage the specific type of process flow records.

In addition to standard query features, the query portal should allow the user to resume their work on a non-finalized process flow as well as review the data captured on a completed record. When implementing such query portal, refer to the sample **Process Flow Query (F1PRSTRQ)** portal for key features. Your specific product may already include such query portals for process flow types it supports. Refer to your specific product documentation for additional information.

## Designing Process Flows

A wide range of process flows may be designed to implement online tasks business users may need to perform. Refer to [Understanding Process Flows](#) for more information.

Below is a high-level summary of the steps required to design and configure various types of process flows.

### Analyze The Task

The following provides a the high-level guidance in analyzing the necessary data and rules needed to support an implementation of a new type of process flow:

- Identify the data and business rules that are needed to complete the entire task.
  - When possible organize data into logical groups of details defined as data areas.
  - Design logic for the final processing script that accepts the entire data entered and completes the task.
  - If data needs to be initially prepared for a newly initiated process flow, design logic for a corresponding initial processing script.
- Design the sequence of panels the user should follow to complete the task. Identify the initial and final panels.
- Review each panel and determine the following:
  - Is it a single panel or a nested process flow, i.e. a panel set?
  - What would be the title of the panel and its label on the progress bar?
  - How would the layout be rendered? Use a data area that leverages UI Hints to describe the panel layout when possible. For more complex HTML requirements you may use a UI map fragment.
  - Should details on this panel be defaulted with some initial values when the user enters this panel? If so design logic for a corresponding pre-processing script.
  - If data entered on this panel should be validated before the user exits the panel design logic for a corresponding post-processing script.
- Determine whether this type of process flow should be automatically saved by the system or solely rely on the user to control when data is saved.
- Determine whether a record of a completed process flow should be retained for audit purposes or deleted upon completion.
- Determine whether a user may delete in progress records of such process flow.

- Determine whether process flows of this type are saved off and stored in a dedicated table in the database or can use the generic table provided by the base product. Assumption is that introducing new designated storage maintenance objects is not common. Refer to your edge product documentation for additional maintenance objects that may have been provided to support specific types of process flows shipped with the product.
- Determine the context in which a user can initiate, resume work on and review process flows of that type.
  - The process flow may be launched from a menu or a favorite script etc.
  - Design the query portal a user would use to find and resume a saved off process flow of this type as well as review completed process flow records. Depending on the context of this task, the query may be associated with the same menu line that initiates the process flow.

## Configure The Process Flow Type

The following describes the high-level steps needed to configure a new type of process flow:

- Create the UI map for the process flow. Its schema should contain all the details needed to complete the task. Its HTML should only include the process controller UI map fragment.
- Create a start processing service script if needed.
- Create a final processing service script such that it applies all the rules needed to complete the task.
- For each panel perform the following:
  - Create a UI map fragment for it unless it corresponds to a data area already included in the process flow schema.
    - Make sure the xpath of each element references in the data area or UI map is the same xpath of that element in the process flow's UI map schema.
    - When using a UI map fragment, make sure it includes the standard error message section used for reporting errors.
  - Create a pre-processing service script if needed.
  - Create a post-processing service script if needed.
  - Set up a label and title MD fields if existing ones cannot be used.
- Create a BPA script for the process flow.
- Configure the [process flow type](#) record.
- Set up a navigation option and reference the BPA script on it. Associate the navigation option with a menu or provide other means for the user to initiate the process flow.
- Create a query portal for the specific type of process flow records. Add the new query portal to a menu or provide other means for the user to resume work on a process flow they have saved off or review completed records.

## Defining Process Flow Types

This portal is used to maintain process flow types.

Refer to [Understanding Process Flows](#) for more information.

You can access the portal from the **Admin Menu > System > Process Flow Type**.

The following zones may appear as part of the portal's **Main** tab page

- **Process Flow Type List.** This zone lists all process flow types. Broadcast a record to display the details of the selected process flow type.
- **Process Flow Type.** This zone provides information about the selected process flow type.

### Where Used

Follow this link to open the data dictionary where you can view the tables that reference [FI\\_PROC\\_DEFN](#).



## Maintaining Managed Content

The Managed Content maintenance object is used to store content such as XSL files used to create vector charts, JavaScript include files, and CSS files. These files may then be maintained in the same manner as the HTML in UI Maps.

The topics in this section describe the Managed Content portal.

### Managed Content - Main

This page is used to define basic information about the content. Open this page using **Admin > System > Managed Content**.

#### Description of Page

Enter a unique name for the content in the **Managed Content** field.

**Owner** indicates if the content is owned by the base package or by your implementation.

Use **Managed Content Type** to indicate the type of content, for example, XSLT or JavaScript.

Enter a **Description**.

Use the **Detailed Description** to describe in detail how this map is used.

### Managed Content - Schema

This page is used to create and maintain the managed content. Open this page using **Admin > System > Managed Content** and then navigate to the **Schema** tab.

#### Description of Page

The General Information zone displays the main attributes of the content. The Editor zone allows you to edit the content.

## Data Areas

The data area has no business purpose other than to provide a common schema location for re-used schema structures. It exists solely to help eliminate redundant element declaration. For example, if you have multiple schemas that share a common structure, you can set up a stand-alone data area schema for the common elements and then include it in each of the other schemas.

Be aware that a stand-alone data area can hold elements that are mapped to true fields. For example, you might have 50 different types of field activities and all might share a common set of elements to identify where and when the activity should take place. It would be wise to declare the elements that are common for all in a stand-alone data area and then include it in the 50 field activity business objects.

It's strongly recommended that you take advantage of stand-alone data areas to avoid redundant data definition!

---

**CAUTION: Dynamic inclusion!** When the system renders a schema, all schemas included within it are expanded real-time. This means that any change you make to a data area will take effect immediately within all schemas it is referenced within.

---

#### NOTE:

**Schema Tips.** The data area page includes a special Schema Tips zone that provides a link to launch help topics related to the [Advanced Schema Topics](#) help in one click.

---

Data areas may be included in a business object that does not define a full UI map for display or input. Rather, it is using auto-rendering by defining UI attributes in its schema and via UI hints.

---

**NOTE: View UI Rendering.** A context sensitive "View UI Rendering" zone appears on this page. It may be used for a data area that is part of a business object that is using auto-rendering for the display and input maps. The buttons allow you to view the rendered UI for the segment of the schema that is defined by the data area.

---

## Defining Data Areas

The topics in this section describe how to maintain Data Areas.

### Data Area - Main

Use this page to define basic information about a data area. Open this page using **Admin > System > Data Area**.

#### Description of Page

Enter a unique **Data Area** name and **Description**. Use the **Detailed Description** to describe what this data area defines in detail. **Owner** indicates if the data area is owned by the base package or by your implementation (**Customer Modification**).

---

**CAUTION:** Important! If you introduce a new data area, carefully consider its naming convention. Refer to [System Data Naming Convention](#) for more information.

---

Click the **View Schema** to view the data area's expanded schema definition. Doing this opens the [schema viewer](#) window.

Click the **View XSD** hyperlink to view the business object's expanded schema definition in XSD format.

To extend another data area, reference that data area in the **Extended Data Area** field. By extending a data area you can add additional elements to a base product data area.

Here's an example of an extended data area:

- The product releases with data area A, which contains elements a, b, and c.
- Your implementation creates data area CM-A, which contains element z, and references data area A as the extended data area.
- At run time, everywhere data area A is included it will contain elements a, b, c, and z.

#### Where Used

Follow this link to open the data dictionary to view the tables that reference [FI\\_DATA\\_AREA](#).

### Data Area - Schema

Use this page to maintain a Data Area's schema and to see where the data area is used in the system. Open this page using **Admin > System > Data Area** and then navigate to the **Schema** tab.

#### Description of Page

The contents of this section describe the zones that are available on this portal.

The **General Information** zone displays the main attributes of the data area.

The [Schema Designer](#) zone allows you to edit the data area's schema. The purpose of the schema is to describe the structure and elements of the data area.

---

**FASTPATH:** Refer to [Schema Syntax](#) and [UI Hint syntax](#) for a complete list of the XML nodes and attributes available to you when you construct a schema. Also note that the **Schema Tips** zone in the dashboard provides links to launch these help topics directly.

---

**NOTE: View UI Rendering.** A context sensitive "View UI Rendering" zone is associated with this page. The zone is useful for data areas that are to be included in [business objects that define the user interface detail](#) using schema attributes and UI Hints. The buttons allow you to view the automatically rendered display and input maps.

---

The **Schema Usage Tree** zone summarizes all cross-references to this schema. These may be other schemas, scripts, and web services. For each type of referencing entity, the [tree](#) displays a summary node showing a total count of referencing items. The summary node appears if at least one referencing item exists. Expand the node to list the referencing items and use their description to navigate to their corresponding pages.

## Advanced Schema Topics

The topics in this section describe some advanced information related to schemas used for business objects, business services, service scripts and UI maps.

## Schema Nodes and Attributes

For business object definition, the purpose of the schema is to create a link between the schema and a maintenance object. For business service definition you are specifying the link between the schema and a service (either a general service, search service, or a maintenance object service). For service script definition, you are defining the API for passing information to and from the script. The following documentation is a complete list of the XML nodes and attributes available to you when you construct a schema.

### Contents

- [The Four Element Types](#)
- [The Data Type of a Field Element](#)
- [Referencing Other Elements](#)
- [Standard Time Considerations](#)
- [The Mapping Attributes](#)
- [Descriptive Attributes](#)
- [Schema Constants](#)
- [Defaulting and System Variables](#)
- [The Flattening Nodes and Attributes](#)
- [Search Zone](#)
- [Extend Security for Service Script](#)
- [Overriding Action for a Business Service](#)
- [Specifying searchBy for a Search Service](#)
- [Including Other Schemas](#)
- [Compatibility Attributes](#)

### The Four Element Types

A schema element can be one of four different structure types. Note that there are two classes of element types: the structural nodes group and list, and the data containing nodes of field and raw.

Mnemonic	Valid Values	Description	Examples
type=	"field"	The field type is the default type for any element not explicitly labeled as something other than	

Mnemonic	Valid Values	Description	Examples
		<p>a field. Therefore, you virtually never have to explicitly label an element as a field. Note that a field element, unlike group or list, will contain information in its nodes - rather than other nodes.</p>	
	<p><b>"group"</b></p>	<p>The group element is typically a structural element of the schema only, in which case it has no mapping.</p> <p>Note that when grouping several elements that are all used to map an XML structure of a CLOB / XML field of a business object driven record, the mapping may be at the group level.</p>	<p>Example where a group is used to create a structure</p> <pre data-bbox="1143 470 1419 659">&lt;schema&gt;   &lt;input type="group"     &lt;userId/&gt;   &lt;/input&gt;   &lt;output type="group"&gt;     &lt;firstName/&gt;     &lt;lastName/&gt;   &lt;/output&gt; &lt;/schema&gt;</pre> <p>Example where the group includes the mapping:</p> <pre data-bbox="1143 747 1500 957">&lt;parameters type="group" mapXML="BO_DATA_AREA" mdField= "F1_TODOSUMEMAIL_PARM_LBL" / &gt;   &lt;numberOfDays mdField="F1_NBR_DAYS" required="true"/&gt;   &lt;frequency mdField="F1_FREQUENCY" / &gt;</pre>
	<p><b>"list"</b></p>	<p>The list node is structural node like the group node. The only difference is that the list structure has the ability to repeat multiple times in an XML document.</p>	<p>Example of a schema with a list:</p> <pre data-bbox="1143 1031 1484 1178">&lt;schema&gt;   &lt;statesList type="list"&gt;     &lt;state isPrimeKey="true"/   &gt;     &lt;description/&gt;   &lt;/statesList&gt; &lt;/schema&gt;</pre> <p>Example of a schema with a list:</p> <pre data-bbox="1143 1234 1451 1507">&lt;xml&gt;   &lt;statesList&gt;     &lt;statesList&gt;       &lt;state&gt;AK&lt;/state&gt;       &lt;description&gt;Alaska&lt;/ description&gt;     &lt;/statesList&gt;     &lt;statesList&gt;       &lt;state&gt;AL&lt;/state&gt;       &lt;description&gt;Alabama&lt;/ description&gt;     &lt;/statesList&gt;     . . .   &lt;/xml&gt;</pre>
	<p><b>"raw"</b></p>	<p>The raw data type is used to capture a chunk of raw text that doesn't have any inherent structure associated with it.</p>	<pre data-bbox="1143 1541 1435 1562">&lt;sendDetail type="raw" /&gt;</pre> <p>Example of an XML instance for the above schema:</p> <pre data-bbox="1143 1650 1549 1818">&lt;sendDetail&gt;   &lt;messageInfo&gt;     &lt;senderAddress&gt;123 W. Main St,     &lt;/senderAddress&gt;     &lt;corpZone&gt;3A&lt;/ corpZone&gt;   &lt;/messageInfo&gt; &lt;/sendDetail&gt;</pre>

## The Data Type of a Field Element

Of the four different element types, only a field can have a data type.

Mnemonic	Valid Values	Description	Examples
dataType=	"string"	By default, a field element is a string. Therefore, there is no requirement to specify the string data type.	<pre>&lt;schema&gt;   &lt;custName dataType="string" /&gt; &lt;/schema&gt;</pre>
	"number"	<p>Defines an element that is a number.</p> <p><b>NOTE:</b> UI hints include a setting to <a href="#">Suppress Automatic Number Formatting</a>.</p> <p><b>NOTE:</b> Use <b>currencyRef</b> attribute for auto-display of currency symbol that is associated with the referenced currency code. The currency decimal positions are ignored by this formatting allowing you to display a currency symbol for a unit rate with many decimals.</p>	<p>Examples</p> <pre>&lt;schema&gt;   &lt;count dataType="number" /&gt; &lt;/schema&gt;</pre> <pre>&lt;schema&gt;   &lt;taxRate dataType="number"     currencyRef="currency" /&gt; &lt;/schema&gt;</pre>
	"money" Optional additional attributes currencyRef="element name"	<p>Defines an element that represents a monetary amount.</p> <p>The currency reference is optional and if left blank the installation currency will be used. Automatic formatting and validation to be applied based on the currency. For example, the currency symbol will be shown when auto-rendering. In addition, the number of decimal places must not exceed the valid number defined for the currency.</p> <p><b>NOTE:</b> Refer to <a href="#">Referencing Other Elements</a> for supported syntax for referring to other elements.</p>	<pre>&lt;schema&gt;   &lt;currency default="USD"     suppress="true" /&gt;   &lt;balance dataType="money"     currencyRef="currency" /&gt; &lt;/schema&gt;</pre>
"lookup" Required additional attribute lookup="field name"	<p>Defines an element that has valid values defined using a lookup. The lookup field is required.</p>	<pre>&lt;schema&gt;   &lt;status dataType="lookup"     lookup="STATUS_FLG" /&gt; &lt;/schema&gt;</pre>	
"lookupBO" Required additional attribute lookupBO="bo name"	<p>Defines an element that has valid values defined using an extendable lookup. The</p>	<pre>&lt;schema&gt;   &lt;category dataType="lookupBO"     lookupBO="CM-     BusinessCategory" /&gt; &lt;/schema&gt;</pre>	

Mnemonic	Valid Values	Description	Examples
		extendable lookup's business object is required.	
	"boolean"	Defines an element that has values of "Y" and "N".	<pre>&lt;schema&gt;   &lt;allowsEdit dataType="boolean" /&gt; &lt;/schema&gt;</pre>
	"date"	Defines an element that represents a date.	<pre>&lt;schema&gt;   &lt;startDate dataType="date" /&gt; &lt;/schema&gt;</pre>
	"dateTime"	Defines an element that represents a date and time.  <b>NOTE:</b> Refer to <a href="#">Standard Time Considerations</a> for additional configuration available for date / time fields that represent standard time.	<pre>&lt;schema&gt;   &lt;startDateTime     dataType="dateTime" /&gt; &lt;/schema&gt;</pre>
	"time"	Defines an element that represents a time.	<pre>&lt;schema&gt;   &lt;startTime dataType="time" /&gt; &lt;/schema&gt;</pre>
	"uri"	Defines an element captures a URI. Elements defined with this type enable the support for URI Whitelist and Substitution as described in <a href="#">Referencing URIs</a> .	<pre>&lt;schema&gt;   &lt;exportDirectory dataType="uri" /&gt; &lt;/schema&gt;</pre>

## Referencing Other Elements

There are several attributes that allow for a reference to another element in the same schema. The supported syntax of the XPath reference is the same in every case. This section provides examples using the default reference attribute (**defaultRef**).

Reference a sibling element:

```
<schema>
  <id mapField="ACCT_ID" required="true" />
  <altId defaultRef="id" required="true" />
</schema>
```

Reference an element in a higher group:

```
<schema>
  <id mapField="ACCT_ID" required="true" />
  <msgInfo type="group" mapXML="XML_FIELD">
    <altId defaultRef="../id" required="true" />
  </msgInfo>
</schema>
```

Reference an element in a lower group:

```
<schema>
  <id mapField="ACCT_ID" defaultRef="msgInfo/altId" required="true" />
  <msgInfo type="group" mapXML="XML_FIELD">
    <altId required="true" />
  </msgInfo>
</schema>
```

Reference an element in another group:

```
<schema>
  <acctInfo type="group">
    <id mapField="ACCT_ID" required="true"/>
  </acctInfo>
  <msgInfo type="group" mapXML="XML_FIELD">
    <altId defaultRef="../acctInfo/altId" required="true"/>
  </msgInfo>
</schema>
```

## Standard Time Considerations

Most date / time fields represent "legal" time such that if a time zone changes their clocks for winter and summer time, the date / time field captures the current observed time. However, some date / time fields should always be captured in standard time to avoid confusion / ambiguity. A good example is a date and time related to detailed interval data.

When defining an element with **dataType="dateTime"**, you may optionally configure **stdTime="true"** indicating that data captured in the element always represents standard time in the 'base' time zone. The 'base' time zone is specified on the [Installation options](#).

---

**NOTE:** If an element is mapped to a table / field with a Standard Time Type of **Physical**, then **stdTime="true"** is implied. Refer to [Table / Field](#) for more information.

---

Example:

```
<schema>
  <startTime dataType="Time" stdTime="true"/>
</schema>
```

If the time zone that represents the date / time field is not the installation time zone, use the optional setting **stdTimeRef="XPath to time zone element"** on a date / time element to indicate that the element represents standard time and indicates the time zone to use. Refer to [Referencing Other Elements](#) for supported syntax for referring to other elements. .

Example:

```
<schema>
  <alternateTimeZone fkRef="F1-TZONE" suppress="true"/>
  <startDateTime dataType="dateTime" stdTimeRef="alternateTimeZone"/>
</schema>
```

---

**NOTE:** If an element is mapped to a table / field with a Standard Time Type of **Referenced**, then **stdTime="XPath"** is implied. Refer to [Table / Field](#) for more information.

---

**NOTE:** When schema elements are captured in standard time the UI map supports HTML notation to automatically display the data applying a daylight savings time / summer time correction. Refer to the HTML attribute [oraType="dateTime; stdTime:true"](#) for more information.

---

There may be cases where the date / time is captured as standard time in one time zone, but should be displayed using a different time zone. In this case, the attribute **displayRef="XPath"** may be used in addition to the appropriate attribute that identifies the time zone that the data is capture in. Refer to [Referencing Other Elements](#) for supported syntax.

```
<schema>
  <displayTimeZone fkRef="F1-TZONE" suppress="true"/>
  <startDateTime dataType="dateTime" stdTime="true" displayRef="displayTimeZone"/>
</schema>
```

## The Mapping Attributes

When constructing your schema, you can choose from one of the following mapping attributes.

Mnemonic	Valid Values	Description	Examples
<b>mapField=</b>	"field name"	In the case of a business object, the <b>mapField</b> attribute is used to identify the database column the element is related to. For business service schemas, the <b>mapField=</b> attribute is used to link a schema element with a service element.	<pre>&lt;schema&gt;   &lt;factId     mapField="FACT_ID" /&gt; &lt;/schema&gt;</pre>
<b>mapChild=</b>	"table name"	<p>The <b>mapChild</b> attribute is used only for business object mapping. It is used in two ways:</p> <ul style="list-style-type: none"> <li>First, to create a list in the business object that corresponds to a child table of an MO.</li> <li>Second, you can use <b>mapChild</b> to identify the child table a flattened field lives in. For more information on flattening, refer to <a href="#">flattening section</a> below.</li> </ul>	<p>Example of a list within a child table in a BO:</p> <pre>&lt;persons type="list"   mapChild="CI_ACCT_PER"   &lt;personId mapField="PER_ID" / &gt; &lt;/persons&gt;</pre>
<b>mapList=</b>	"list name"	<p>The <b>mapList</b> attribute is used only for business service mapping. It is used in two ways:</p> <ul style="list-style-type: none"> <li>First, to create a list in the business service that corresponds to a list in the service.</li> <li>Second, you can use <b>mapList</b> to identify the list that a flattened field lives in. For more information on flattening, refer to <a href="#">flattening section</a> below.</li> </ul>	<p>Example of a list within a business service:</p> <pre>&lt;selectList type="list"   mapList="DE"   &lt;value mapField="COL_VALUE"&gt;   &lt;row mapList="DE_VAL"&gt;     &lt;SEQNO is="2" /&gt;   &lt;/row&gt; &lt;/value&gt; &lt;/selectList&gt;</pre>
<b>mapXML=</b>	"field name"	The <b>mapXML</b> attribute is typically used to map XML structures into a large character / XML field of the service. Note that when you use <b>mapXML</b> to map either a list or group structure ( <b>type="list"</b> or <b>type="group"</b> ) you don't have to map all the child elements within the structure. It is also possible to map list elements to a large character field associated with the list child.	<pre>&lt;enrollmentRequest type="group"   mapXML="CASE_CLOB"&gt;   &lt;messageID/&gt;   &lt;sender/&gt; &lt;/enrollmentRequest&gt; &lt;enrollmentKey   mapXML="CASE_CLOB" /&gt; &lt;enrollmentInfo type="list"   mapChild="CI_CASE_CHILD"&gt;   &lt;sequence     mapField="CHILD_SEQ" /&gt;   &lt;name     mapXML="CASE_CHILD_CLOB" /   &gt;   &lt;value     mapXML="CASE_CHILD_CLOB" /   &gt; &lt;/enrollmentInfo&gt;</pre>
<b>isPrimeKey=</b>	"true"	You must specify a primary key for a list defined within a mapped	<pre>&lt;questionnaire   type="list" mapXML="CASE_CLOB"&gt;   &lt;question     isPrimeKey="true" /&gt;</pre>



Mnemonic	Valid Values	Description	Examples
		<p>XML element (<b>type="list"</b> <b>mapXML="CLOB"</b>). The primary key is used by the framework to determine whether a list element add, update or delete is required during a business object update.</p> <p><b>NOTE:</b> You do not need to specify the prime key for a business object list mapped to maintenance object list. When a physical list is mapped, the prime key is derived from existing physical meta-data.</p>	<pre>&lt;answer/&gt; &lt;/questionnaire&gt;</pre>
<b>orderBy=</b>	"XPath <b>asc desc</b> , XPath <b>asc desc</b> "	<p>By default, a list defined within a mapped XML element (<b>type="list"</b> <b>mapXML="CLOB"</b>) is sorted by the first element of the list. A different sort order may be specified using the <b>orderBy</b> attribute. The attribute value is a comma separated list of field XPath(s) (relative to the list element) with an optional sort order (ascending is the default).</p> <p><b>NOTE:</b> This is only available for lists mapped as XML within business objects.</p>	<pre>&lt;questionnaire type="list"   orderBy="page/section,   page/sequence"   mapXML="CASE_CLOB"&gt;   &lt;question isPrimeKey="true"/   &gt;   &lt;answer/&gt;   &lt;page type="group"&gt;   &lt;section/&gt;   &lt;sequence/&gt;   &lt;/page&gt; &lt;/questionnaire&gt;</pre>

## Descriptive Attributes

The following attributes can be used to describe a schema element and provide additional configuration related to the element. Typically, these attributes are useful for field elements only.

Mnemonic	Valid Values	Description	Examples
<b>&lt;!-- comment --&gt;</b>		Use this to add a comment to a schema by using special open and close characters: <b>&lt;!--</b> and <b>--&gt;</b> .	<pre>&lt;schema&gt;   &lt;!-- This schema is used to   capture business information   only, please refer to the   'HUMAN' BO for person   information --&gt; &lt;/schema&gt;</pre>
<b>description=</b>	"text"	The description of an element may be used to provide an internal description of the element to help a reader of the schema to understand the business reason for the element.	<pre>&lt;schema&gt;   &lt;active type="boolean"   description="active account"   label="Active"/&gt; &lt;/schema&gt;</pre>
<b>label=</b>	"text"	The label of an element is meant to be a short bit of verbiage	<pre>&lt;schema&gt;   &lt;active type="boolean"   description="active account"   label="Active"/&gt;</pre>

Mnemonic	Valid Values	Description	Examples
		that would typically precede the element in a user interface.	<code>&lt;/schema&gt;</code>
<b>required=</b>	"true"	Used to require the existence of an element during object interaction.  <b>NOTE:</b> For <a href="#">included</a> schemas, the <code>required="true"</code> attribute is not processed on business object and business service schemas when they are included within a service script schema. This is to support the ability of the service script to populate required elements before an embedded business object or business service is invoked from the service script.	<pre>&lt;schema&gt;   &lt;logDate mapField="LOG_DT"     default="%CurrentDate"     required="true"     private="true"   &gt; &lt;/schema&gt;</pre>
<b>mdField=</b>	"field code"	The meta-data field attribute is used to associate an element with a field's metadata. The field defines data type, as well as its label and help text. If you link an element with a meta-data field, you don't need to specify any of these attributes.  <b>NOTE:</b> For a business object schema, the <code>mapField</code> attribute is used to derive the data type and label. An <code>mdField</code> attribute may be provided to override these attributes, if needed. If the element is mapped to an XML column, the <code>mdField</code> is needed to provide the appropriate data type and label.	<pre>&lt;schema&gt;   &lt;active     mdField="CM_ACTIVE_SW" /&gt; &lt;/schema&gt;</pre>
<b>fkRef=</b>	"FK Reference Code"	If the element is a foreign key, defining its FK Reference will enable framework validation of the element during schema interaction and automatically provide descriptions and navigation capability.	<pre>&lt;schema&gt;   &lt;person fkRef="PER"     mapField="CHAR_VAL_FK1"&gt;     &lt;row mapChild="CI_SA_CHAR"&gt;       &lt;CHAR_TYPE_CD is="PER" /     &gt;     &lt;/row&gt;   &lt;/person&gt; &lt;/schema&gt;</pre>
<b>private=</b>	"true"	Marking an element as private will prevent it from being exposed in schema interaction.	<pre>&lt;schema&gt;   &lt;type mdField="SA_TYPE_CD"     default="E1" private="true" /   &gt; &lt;/schema&gt;</pre>

Mnemonic	Valid Values	Description	Examples
		<p><b>NOTE:</b> A private element requires a default.</p>	
<b>suppress=</b>	"true"	<p>This setting prevents an element from appearing in automatically generated user interfaces.</p> <p><b>NOTE:</b> This attribute can be specified on a group, in which case all elements of the group will be suppressed.</p>	<pre>&lt;schema&gt;   &lt;ls mdField="LIFE_SUPPORT_FLG"   default="N" suppress="true"/ &lt; &lt;/schema&gt;</pre>
	"blank"	<p>This setting means that automatic UI rendering will hide the element if its value is blank. The element will still be modifiable on the input map whether blank or not.</p>	<pre>&lt;schema&gt;   &lt;email mdField="EMAIL"   suppress="blank"/&gt; &lt;/schema&gt;</pre>
	"input"	<p>This setting means that automatic UI rendering will suppress the element for input, although it may still be displayed if it is not blank.</p> <p><b>NOTE:</b> Elements marked as <b>suppress="input"</b> will behave as with <b>suppress="blank"</b>. If the value is blank, no value will be displayed on either the display or input map. If the element's value is present, then the element will be displayed on both the display and input map.</p>	<pre>&lt;schema&gt;   &lt;email mdField="EMAIL"   suppress="input"/&gt; &lt;/schema&gt;</pre>
<b>noAudit=</b>	"true"	<p>This setting prevents an element from appearing as a changed element in the business object's audit plug-in spot. If specified on a group or list node it applies to the whole node. You cannot specify it on the schema root node, only on schema elements.</p> <p><b>NOTE:</b> This attribute is only applicable to business object schemas.</p>	<pre>&lt;schema&gt;   ...   &lt;version mapField="VERSION_NBR"   noAudit="true"/&gt;   ...   &lt;workFields type="group"   noAudit="true"   &lt;lastProcessedId/&gt;   &lt;lastProcessedTime/&gt;   &lt;/workFields&gt; &lt;/schema&gt;</pre>

## Schema Constants

There are some product owned schemas where the design warrants a value to be defaulted in the schema, but where the value is implementation specific and therefore cannot be defined by the product. For these situations, the product may use

a technique called a schema constant. The design of the schema will include a declared constant. At implementation time, a configuration task will include defining the appropriate value for the constant.

For example, imagine the product delivers an algorithm that will create an outbound message when a certain condition occurs. The outbound message type to use must be configured by the implementation. To use a schema constant to define the outbound message type, the base product will configure the following:

- An option type lookup value for the lookup **F1CN\_OPT\_TYP\_FLG** is defined. For example, **M202 - Activity Completion Outbound Message Type** with a Java Value Name of **outmsgCompletion**
- The base schema that is used to create the "complete activity" outbound message references the schema constant using the Java Value Name of the option type's lookup value

```
...
<outboundMessageType mapField="OUTMSG_TYPE_CD" default="%Constant(outmsgCompletion)"/>
...
```

At implementation time, the administrative users must configure the appropriate outbound message type for "activity completion". Then, navigate to [Feature Configuration](#), choose the **Schema Constants** feature type, choose the option type **Activity Completion Outbound Message Type** and enter the newly created outbound message type in the option value.

Schema constants may also be used in the flattening syntax to define [the row elements required for flattening](#).

## Defaulting and System Variables

The default node can be used to default values into field elements as well as [the row elements required for flattening](#). You can default a field to a constant or to one of several system variables.

### NOTE:

When a field is displayed on the user interface in Add mode, the default value defined in the schema is shown. In addition, the server logic uses the default value if no value is supplied and the element is marked as required or suppressed.

Mnemonic	Valid Values	Description	Examples
default=	"value"	Use this attribute to default an element to a specified value. The values that are valid depend on the <b>dataType</b> setting.	<pre>&lt;schema&gt;   &lt;perType mapField="PER_OR_BUS_FLG"     default="P" required="true"/ &gt; &lt;/schema&gt;  &lt;schema&gt;   &lt;frequency dataType="number"     default="1" required="true"/ &gt; &lt;/schema&gt;</pre>
	"%CurrentDate"	Used to default the element to the current date. This is only applicable to date elements.	<pre>&lt;schema&gt;   &lt;logDate mapField="LOG_DT"     default="%CurrentDate" required="true"/ &gt; &lt;/schema&gt;</pre>
	"%CurrentDateTime"	Used to default the element to the current date / time. This is only applicable to date / time elements.	<pre>&lt;schema&gt;   &lt;logDateTime mapField="LOG_DTTM"     default="%CurrentDateTime"     required="true"/&gt; &lt;/schema&gt;</pre>
	"%StandardDateTime"	Used to default the standard date and time. The standard date and time is identical to the current date and time, unless daylight savings time / summer time is in effect for the base time	<pre>&lt;schema&gt;   &lt;startDateTime mapField="START_DTTM"     default="%StandardDateTime"     required="true"/&gt; &lt;/schema&gt;</pre>

Mnemonic	Valid Values	Description	Examples
		<p>zone. This may be used with the <b>stdTime</b> attribute.</p> <p><b>NOTE:</b> Refer to <a href="#">Standard Time Considerations</a> for more information.</p>	
"%ProcessDate"		<p>You can default the process date. The process date differs from the current date because the process date will remain constant throughout the duration of the process being executed. The current date will reflect the actual date of processing. This is similar to the batch business date that is a standard <a href="#">batch parameter</a>.</p>	<pre>&lt;schema&gt;   &lt;billDate mapField="BILL_DT"     default="%ProcessDate"     required="true"/&gt; &lt;/schema&gt;</pre>
"%ProcessDateTime"		<p>This is similar to "<b>%ProcessDate</b>" but for date / time fields.</p>	<pre>&lt;schema&gt;   &lt;calcDateTime mapField="CALC_DTMM"     default="%ProcessDateTime"     required="true"/&gt; &lt;/schema&gt;</pre>
"%CurrentUser"		<p>Used to default the element to the current user.</p>	<pre>&lt;schema&gt;   &lt;logUser mapField="LOG_USER"     default="%CurrentUser"     required="true"/&gt; &lt;/schema&gt;</pre>
"%CurrentUserTimeZone"		<p>Used to default the element to the current user's time zone. If the current user's time zone is not found, the installation time zone is used.</p>	<pre>&lt;schema&gt;   &lt;timeZone     default="%CurrentUserTimeZone"     required="true"/&gt; &lt;/schema&gt;</pre>
"%CurrentUserLanguage"		<p>Used to default the element to the current user's language.</p>	<pre>&lt;schema&gt;   &lt;custLanguage mapField="CUST_LANG"     default="%CurrentUserLanguage"     required="true"/&gt; &lt;/schema&gt;</pre>
"%InstallationCurrency"		<p>Used to default the currency from the installation record.</p>	<pre>&lt;schema&gt;   &lt;currency mapField="CURRENCY_CODE"     default="%InstallationCurrency"     required="true"/&gt; &lt;/schema&gt;</pre>
"%InstallationCountry"		<p>You can default the country from installation record.</p>	<pre>&lt;schema&gt;   &lt;country mapField="COUNTRY"     default="%InstallationCountry"     required="true"/&gt; &lt;/schema&gt;</pre>
"%InstallationLanguage"		<p>You can default the language from the installation record.</p>	<pre>&lt;schema&gt;   &lt;language mapField="LANGUAGE"     default="%InstallationLanguage"     required="true"/&gt; &lt;/schema&gt;</pre>
"%Constant( )"		<p>You can default an element value using a <a href="#">schema constant</a>.</p>	<p>The following is an example of a schema constant used as a default value, where the Java</p>

Mnemonic	Valid Values	Description	Examples
			Value Name of the Lookup Value is 'customerLanguage'. <pre>&lt;language mapField="CUSTOMER_LANG" default=%Constant(customerLanguage) required="true"/&gt;</pre>
	<code>"%Context( )"</code>	You can default a value contained in a context variable.  <b>WARNING:</b> Context variables must be initialized within a server script before the schema context default can be applied. Refer to <a href="#">Context Variables</a> for more information.	An example of a context variable used as a default value: <pre>&lt;source mapField="PER_ID" default=%Context(source) required="true"/&gt;</pre> <b>NOTE:</b> When defining a context variable in scripting, it should be prefixed with <code>\$\$</code> . When referring to the variable in the <code>%Context( )</code> syntax, the prefix is not included.
<code>defaultRef=</code>	<code>"XPath"</code>	Use this attribute to default the value of one element to the value of another one.	Refer to <a href="#">Referencing Other Elements</a> for supported syntax for referring to other elements.

## The Flattening Nodes and Attributes

The term "flattening" is used to describe the act of defining one or more single elements for a schema that are actually part of a list within the maintenance object. Flattening is possible if there are other attributes of the list that can be defined to uniquely describe the element or elements. A common use case for flattening is a characteristic. Rather than defining the characteristics of an object using a collection where the user must choose the characteristic type and then define the value, the characteristics are defined as actual elements with the appropriate label already displayed. This technique enables the designer of the schema and the user interface to display each separate characteristic in the logical place in the user interface rather than all lumped together.

---

**NOTE:** A flattened element represents a unique row in the database. This row is inserted when the flattened values are created. The row is updated when any of the flattened values are changed. The row is deleted when all the flattened values are removed. The behavior of effective dated elements is slightly different - please see [Flattening an Effective Dated List](#).

---

**NOTE:** The flattening feature can also be used to define a list, see [Flattened List](#).

---

## Identifying the List or Child Table

When flattening a child table, the row node is required to identify the list / child table that the element comes from. Within the row node, at least one element must be defined with an `is=` definition that ensures that the element is a unique row in the database. It may also define elements or fields in the row that are suppressed and are populated using default value configuration.

- For a business object, the row node defines the child table the flattened field belongs to.

The syntax is `<row mapChild="table name">`. This example is for the list of persons for an account in the customer care and billing product. One person may be marked as the "main" person. This illustrates how to define an explicit element for the main person ID to simplify references to that field. It is part of the `CI_ACCT_PER` child table. What makes it unique is that the `MAIN_CUST_SW` is **true** (and only one row may have that value)

```
<custId mapField="PER_ID" mdField="CM-MainCust">
<row mapChild="CI_ACCT_PER">
```

```

    <MAIN_CUST_SW is="true" />
    <ACCT_REL_TYPE_CD default="MAIN" />
</row>
</custId>

```

**NOTE:** The above example illustrates that the row node may also define elements within the list that are suppressed and assigned a default value. This syntax is never used to identify a particular row. Note that a default value can either be a literal string, or a [system variable](#).

- For a business service, the row node identifies the list name the flattened field belongs to.

The syntax is `<row mapList="list name">`. This example shows two entries from a list being flattened to a field value and description.

```

<selectList type="list" mapList="DE">
  <value mapField="COL_VALUE">
<row mapList="DE_VAL">
  <SEQNO is="2"/>
</row>
  </value>
  <description mapField="COL_VALUE">
<row mapList="DE_VAL">
  <SEQNO is="3"/>
</row>
</description>
</selectList>

```

## Uniquely Identifying the Flattened Field or List

The `is=` syntax within a row or rowFilter element is used to uniquely identify the row.

Mnemonic	Valid Values	Description	Examples
<code>is=</code>	"value"	Use this attribute to reference a value directly.	<pre> &lt;tdTypeCd   mapField="CHAR_VAL_FK1"&gt;   &lt;row     mapChild="Fl_EXT_LOOKUP_VAL_CHAR"&gt;     &lt;CHAR_TYPE_CD       is="CM-TD-TYPE" /&gt;     &lt;/row&gt;   &lt;/tdTypeCd&gt; </pre>
	<code>"%Constant( )"</code>	You can configure a flattened element using a <a href="#">schema constant</a> . During a service interaction the value of the schema constant will be used to identify the flattened element in its child row.	<p>An example of a schema constant used in flattening syntax where the Java Value Name of the Lookup field value is 'cmRate'.</p> <pre> &lt;unitRate mapField="CHAR_VAL"   dataType="number"&gt;   &lt;row mapChild=     "Fl_EXT_LOOKUP_VAL_CHAR"&gt;     &lt;CHAR_TYPE is       ="%Constant(cmRate)" /&gt;     &lt;/row&gt;   &lt;/unitRate&gt; </pre>
	<code>"%n"</code>	The <code>%n</code> substitution value is used to reference a relative list instance. A relative list instance is typically used to configure a flattened element for a child table keyed by sequence number. The value of <code>n</code> should be a positive integer value. During a business object read interaction the relative	<p>An example with a relative list instance - where the <b>first</b> instance of the row is returned.</p> <pre> &lt;schema&gt;   &lt;mainPhone mapField="PHONE"&gt;     &lt;row mapChild="CI_PER_PHONE"&gt;       &lt;PHONE_TYPE_CD         is="%Constant(mainPhoneType)" /&gt;     &gt;     &lt;SEQ_NUMis="%1" /&gt;   &lt;/row&gt; &lt;/mainPhone&gt; </pre>

Mnemonic	Valid Values	Description	Examples
		list instance (position) specified by the integer will be returned.	</schema>

**FASTPATH:** Additional values for `is=` are used when [Flattening an Effective Dated List](#). Refer to that section for more information.

## Flattening a Pre-defined Characteristic Type

If the flattened field is in a characteristic collection and the characteristic type is a predefined characteristic, automatic UI rendering will generate a dropdown for the list of valid values. For example, the schema below will generate a dropdown for the Usage element showing the valid values of the Status Reason Usage (**F1-SRUSG**) characteristic type.

```
<usage mdField="STATUS_RSN_USAGE" mapField="CHAR_VAL">
  <row mapChild="F1_BUS_OBJ_STATUS_RSN_CHAR">
    <CHAR_TYPE_CD is="F1-SRUSG"/>
    <SEQ_NUM is="1"/>
  </row>
</usage>
```

## Defining Multiple Elements from the List

When attempting to include multiple columns from the same list, the system provide shorthand notation for copying the flattening rules defined on another element so that the flattening rules do not need to be repeated. To do this, the row node includes the **rowRef** attribute and it indicates the other element name that defines the mapping information. The following example illustrates flattening the fields Customer ID and Receives Copy of Bill from the same list of Persons for an Account (where the `MAIN_CUST_SW` is `true`).

```
<custId mapField="PER_ID">
  <row mapChild="CI_ACCT_PER">
    <MAIN_CUST_SW is="true" />
    <ACCT_REL_TYPE_CD default="MAIN" />
  </row>
</custId>
<copyBill mapField="RECEIVE_COPY_SW" rowRef="custId"/>
```

Note that the above notation also illustrates that the **rowRef** may be defined directly in the element's attribute definition.

**NOTE:** Refer to [Referencing Other Elements](#) for supported syntax for referring to other elements.

## Flattening Two Layers Deep

If your maintenance object or service has nested lists two layers deep, the system supports flattening and element within a flattened element. This technique also uses the **rowRef** attribute. The flattening of the second level refers to the flattened element of the first level. The following example illustrates flattening a characteristic into an element called `legalContact` for the "main" customer. Notice that the `legalContact` element has two row nodes: one to refer to the flattening information for its parent record and one to define its child table

```
<custId mapField="PER_ID">
  <row mapChild="CI_ACCT_PER">
    <MAIN_CUST_SW is="true" />
    <ACCT_REL_TYPE_CD default="MAIN" />
  </row>
</custId>
<legalContact mapField="CHAR_VAL_FK1">
<row rowRef="custId">
  <row mapChild="CI_ACCT_PER_CHAR" >
    <CHAR_TYPE_CD is="LEGAL" />
  </row>
</row>
</legalContact>
```

Note that the above notation also illustrates that the **rowRef** may be defined as an attribute of a row node rather than directly in the element's attribute definition.



## Defining a Flattened List

There are times that a list or child table supports multiple values of the same "type" and these should be presented as a list. To continue with the example above, the list of persons for an account may identify one person as the "main" person. This person has been flattened to a single element (with the account relationship type defaulted and suppressed). To maintain the other persons related to an account, you can define a list where each row captures the Person Id and the Account Relationship Type.

Rather than a row node, the flattened list is configured with a **rowFilter** element. The following schema illustrates the described example. The list node defines the child table. The **rowFilter** includes the criteria that identify the rows within the table to include. The elements of the list are defined within the list node outside the **rowFilter** element.

```
<custId mapField="PER_ID">
  <row mapChild="CI_ACCT_PER">
    <MAIN_CUST_SW is="true" />
    <ACCT_REL_TYPE_CD default="MAIN" />
  </row>
</custId>
<miscPersons type="list" mapChild="CI_ACCT_PER">
  <rowFilter>
    <MAIN_CUST_SW is="false" />
  </rowFilter>
  <relType mapField="ACCT_REL_TYPE_CD"/>
  <personId mapField="PER_ID"/>
</custId>
```

Note that the system will validate that if a schema contains flattened single elements and flattened lists from the same child table, the criteria that defines what makes them unique must be analogous.

## Flattening an Effective Dated List

There are some lists in the application that are effective dated (and still others that have effective date and time). For example, there are some effective dated characteristic collections. In these collection, the design is to capture a single value for a characteristic type that may change over time. It is not meant to support multiple characteristic values in effect at the same time. The following highlights some information regarding effective dated characteristic functionality:

- The most recent dated row is returned when invoking a BO for read.
- No new row added when all of the values are unchanged on a change to the BO.
- The flattened row value is updated when any of the flattened values are changed and the most recent date is equal to the current date (or the referenced effective date);
- A new row value is inserted when any of the flattened values are changed and the most recent date is different than the current date (or the referenced effective date);

**NOTE:** Refer to [Referencing Other Elements](#) for supported syntax for referring to other elements.

When flattening an effective dated list, the date column must include information regarding the date to use. The following table highlights the possible values.

Mnemonic	Valid Values	Description	Examples
is=	"%effectiveDate"	Use this configuration to indicate that current date should be used for processing. Any value added or updated using this schema will be for the current date.  With this option, if the maintenance object allows for the characteristic value to be blank, then setting the flattened value	<pre>&lt;schema&gt;   &lt;price mapField="CHAR_VAL"   dataType="number"&gt;     &lt;row     mapChild="CI_SA_CHAR"&gt;       &lt;CHAR_TYPE is="PRICE" /     &gt;       &lt;EFFDT       is="%effectiveDate" /&gt;     &lt;/row&gt;   &lt;/price&gt; &lt;/schema&gt;</pre>

Mnemonic	Valid Values	Description	Examples
		to blank during the BO update will result in updating the existing record with an empty value, or adding a new row with an empty value in case the current date effective dated record is not found.	
"%effectiveDate( )"		Use this configuration to indicate that the date to use the value of another element.  <b>NOTE:</b> Refer to <a href="#">Referencing Other Elements</a> for supported syntax for referring to other elements.	<pre>&lt;schema&gt;   &lt;price mapField="CHAR_VAL"     dataType="number" required="true"&gt;     &lt;row mapChild="CI_SA_CHAR"&gt;       &lt;CHAR_TYPE is="PRICE"/     &gt;       &lt;EFFDT         is="%effectiveDate(priceEdate)" /       &gt;     &lt;/row&gt;   &lt;/price&gt; &lt;priceEdate mapField="EFFDT"   rowRef="price"/&gt; &lt;/schema&gt;</pre>
"%effectiveDateTime"		Use this configuration to indicate that current date /time should be used for processing. Any value added or updated using this schema will be for the current date / time.	<pre>&lt;schema&gt;   &lt;price mapField="CHAR_VAL"     dataType="number"&gt;     &lt;row mapChild="RATE_CHAR"&gt;       &lt;CHAR_TYPE is="PRICE"/     &gt;       &lt;EFFDT         is="%effectiveDateTime" /       &gt;     &lt;/row&gt;   &lt;/price&gt; &lt;/schema&gt;</pre>
"%effectiveDateTime( )"		Use this configuration to indicate that the date / time to use the value of another element.  <b>NOTE:</b> Refer to <a href="#">Referencing Other Elements</a> for supported syntax for referring to other elements.	<pre>&lt;schema&gt;   &lt;price mapField="CHAR_VAL"     dataType="number"&gt;     &lt;row mapChild="RATE_CHAR"&gt;       &lt;CHAR_TYPE is="PRICE"/     &gt;       &lt;EFFDTTM         is="%effectiveDateTime(priceEdatetime)"       &gt;     &lt;/row&gt;   &lt;/price&gt; &lt;priceEdatetime mapField="EFFDTTM"   rowRef="price"/&gt; &lt;/schema&gt;</pre>

## Search Zone

A UI Map schema element can be configured to enable an automatic search dialog when the schema is included within a maintenance UI map.

**NOTE:** Please note that an fkRef can be configured with a search zone. If a schema element has an fkRef but no explicit search attributes (as described here) then the fkRef search information will be used in the UI map. In other words, if the schema element already has an fkRef, then these explicit search attributes in the schema are only used to override the fkRef search information.

**NOTE:** Refer to the [UI Map Attributes and Functions](#) for more information on search zone configuration.

## search="search zone"

The search attribute can be used within a UI map schema and is used to automatically generate the oraSearch UI map attribute. The search zone is an explorer zone configured as a search.

```
<person fkRef="PER" search="C1_PSRCH"/>
```

## searchField="search field:element|'literal';"

The searchField attribute can only be used in conjunction with the search attribute. The searchField attribute is used to build the oraSearchField UI map attribute. The searchField value is used to populate a search zone filter with an initial value when the search zone is launched. The initial value can be a literal also. The searchField value is used to match to the filter mnemonic also named searchField.

Search field: element|'literal'. The search field represents the search zone filter to populate on launch. The element is the map's schema element used to populate the filter. The element is optional, if left blank, it will default to the element that this attribute is specified on. The searchField also takes 'literal' as input value

---

**NOTE:** Multiple filters can be populated within the search zone at launch, but multiple search field pairs must be constructed within the attribute value. The value specified here will be used to directly build the HTML attribute oraSearchField within the UI map where this schema is specified.

---

**NOTE:** Note that the element reference is *relative*. Refer to [Referencing Other Elements](#) for supported syntax for referring to other elements.

---

```
<person fkRef="PER" search="C1_PSRCH" searchField="PERSON; PER_TYPE:personType; "/>
```

## searchOut="search field:element;"

The searchOut attribute can only be used in conjunction with the search attribute. The searchOut attribute is used to build the oraSearchOut UI map attribute. The searchOut value is used to capture a selected value from the search zone and move it to a UI map element. The searchOut value specified should match the ELEMENT\_NAME mnemonic within the search result zone parameter.

Search field: element. The search field represents the search zone result brought back to the UI map. The element is the map's schema element to be populated. The element is optional, if left blank, it will default to the element that this attribute is specified on.

---

**NOTE:** Multiple elements can be populated as a result of search zone selection, but multiple search field pairs must be constructed within the attribute value. The value specified here will be used to directly build the HTML attribute oraSearchOut within the UI map where this schema is specified.

---

**NOTE:** Note that the element reference is *relative*. Refer to [Referencing Other Elements](#) for supported syntax for referring to other elements.

---

```
<person fkRef="PER" search="C1_PSRCH" searchField="PER_ID" searchOut="PER_ID; PRIMARY_PHONE:personPhone; "/>
```

## Extend Security for Service Script

Application service security will be enforced when either a business object or a service script is invoked from a BPA script or a UI map, but not from a service script. If you want security to be enforced when the business object or a service script is invoked from a service script, you must add the following attribute to the service script's schema.

## **appSecurity="true"**

The appSecurity attribute is only available for service script schemas. If specified, any business object or service script directly invoked by the service script will have their application service evaluated for access.

```
<schema appSecurity="true">
  ...
</schema>
```

## **Overriding Action for a Business Service**

If you want to invoke a business service with an action other than 'read', you need to specify the action attribute on the primary node business service schema.

### **pageAction="add, change, delete"**

The action attribute is used to override the default action of read on a business service schema. Valid values are:

- add
- update (only allowed for maintenance object service)
- change (not allowed for maintenance object service)
- delete
- read (this is the default action if no pageAction specified)

Example:

```
<schema pageAction="change">
  <parm type="group">
    <ele1/>
    <ele2/>
  </parm>
</schema>
```

## **Specifying searchBy for a Search Service**

If you want to invoke a search service then you must explicitly specify the searchBy attribute appropriate for the elements mapped in the schema.

### **searchBy="MAIN"**

The value values of the searchBy attribute can be found by viewing the XML schema linked to the business service, use the View XML URL. Typical values are:

- MAIN
- ALT
- ALT2
- ALT3
- etc.

```
<schema searchBy="MAIN">
  <AccountID mapField="ACCT_ID"/>
  <Results type="list">
    <AccountID mapField="ACCT_ID"/>
  </Results>
</schema>
```

## **Including Other Schemas**

There are no limitations on your ability to include a schema into another schema - all types can be included in all other types. Nested includes are also allowed - and at present there is no limitation on the depth of the nesting.

Including a schema requires two parts:

1. The include node
2. The name attribute

The following table highlights the supported include statements.

Mnemonic	Description	Examples
<code>&lt;includeBO name=" "/&gt;</code>	<p>Including a business object schema into another schema is allowed.</p> <p>Note that the mapping rules of a business object or business service schema may or may not make sense in the context of the parent schema. Include other schemas at your own risk. However, a very useful aspect of XML processing is that the framework ignores non-pertinent attributes. In other words, it will not hurt to have mapping attributes included into a script schema.</p>	<pre>&lt;schema&gt;   &lt;cust type="group"&gt;     &lt;includeBO name="C1-Person"/&gt;   &lt;/cust&gt;   &lt;spouse type="group"&gt;     &lt;includeBO name="C1-Person"/&gt;   &lt;/spouse&gt; &lt;/schema&gt;</pre>
<code>&lt;includeBS name=" "/&gt;</code>	Used to include a business service schema.	<pre>&lt;schema&gt; &lt;includeBS name="F1-ReadMOLog" /&gt; &lt;/schema&gt;</pre>
<code>&lt;includeDA name=" "/&gt;</code>	Used to include a data area schema.	<pre>&lt;schema&gt; &lt;includeDA   name="F1CommonSchemaFieldData" / &gt; &lt;/schema&gt;</pre>
<code>&lt;includeMP name=" "/&gt;</code>	Used to include a UI map schema.	<pre>&lt;schema&gt; &lt;includeMP   name="F1-DisplayRecordActions" / &gt; &lt;/schema&gt;</pre>
<code>&lt;includeSS name=" "/&gt;</code>	Used to include a service script schema.	<pre>&lt;schema&gt; &lt;includeSS name="F1-ActShowZn" /&gt; &lt;/schema&gt;</pre>

## Compatibility Attributes

These attributes were added as part of upgrades from previous versions of the Framework.

### fwRel="2"

This attribute has been added to schemas created in Framework 2 as part of a Framework 4 upgrade. New schemas will not need this attribute. It is not advisable to modify this attribute without understanding the following behavior differences as improper changes could result in errors:

**NOTE:** Schemas created in Framework 2 with the fwRel="2" attribute will store any XML mapped fields under groups as top-level XML elements in the mapXML field. This means that if two or more fields, in different group structures, were to have the same field name, their storage would conflict with one another resulting in errors. The new behavior, without the fwRel="2" attribute, will preserve the group structure and avoid the conflicts.

```
<schema fwRel="2"
  . . .
</schema>
```

# UI Hint Syntax

## Contents

- [Working Examples](#)
- [Technical Notes](#)
- [Format an Input Map Title](#)
- [Create a Section](#)
- [Include a Map Fragment](#)
- [Build Dropdown](#)
- [Conditionally Hide Elements](#)
- [Conditionally Protect Elements](#)
- [Trigger Dependent Behavior](#)
- [Control Rendering Target](#)
- [Generate a Text Area](#)
- [Modify FK Reference Defaults](#)
- [Suppress Automatic Number Formatting](#)
- [Auto Capitalize the Input Data](#)

## Working Examples

For working examples of uiHint functionality, refer to the following business objects:

### BOs with User Assigned Keys

The following examples illustrate the patterns used to enable uiHints on an object with a user specified key.

- **F1-OutcomeStyleLookup.** This extendable lookup BO does not require state transition, but does allow duplicate and delete actions.
- **F1-TodoSumEmailTyp.** This request type illustrates the hints required to support state transition on a display map.
- **F1-WebSvc.** This web service BO is a good example for management of complex JavaScript requirements. Both display and input maps have functionality that requires specialized javascript.

### BO with System Generated Key

The following example illustrates the pattern used to enable uiHints on an object with a system generated key.

- **F1-GenericAttachment.** This attachment BO has a system assigned key, which entails the following special handling:
  - **F1-AttachmentMain.** This is the main section data area contains the elements common to all attachments, including the key, bo, and version. Because this data area is used to define the main section of the generated maps, the main section of the map can be extended by an implementation via data area extension functionality.
  - **F1-AttachmentActions.** This record actions map contains the standard actions, Edit and Delete, plus custom actions used only by attachments, View and Upload.
  - **F1-AttachmentIDFrag.** This record information map contains the primary key of the attachment.

### Display Map Service Script

Display map service scripts can be fully supported via dynamic HTML generation. However, to help eliminate the need for a display service script, self-contained uiHint functionality has been developed to write the business object status and determine valid state transitions. So the two most common reasons to craft a display service script have been eliminated.

A typical reason to use a display pre-script is if you have an embedded map fragment that contains a business service schema. The display service script can be used to invoke the business service. Both the map fragment and the display service script must declare the business service schema to support this scenario.

---

**WARNING:** The zone used to display the object's map must have a derivation script, like **F1-GncDsMpDZ** or **F1-GenDss**, that will invoke a display service script for the business object if it has been defined as a BO option - but not require an explicit display map BO option. In addition, the display service script's schema must be enabled for uiHint functionality - as the script's schema will be dynamically rendered by the zone - and not the BO schema.

---

- **F1-ExcelSpreadsheet.** This attachment BO has a display service script used to manipulate the attachment business object before displaying it:
- **F1-AttchDtIU.** This display map service script's schema has been defined with the uiHint namespace, and will have a display map generated for it.

### Maintenance Pre-Processing Service Script

Maintenance pre-processing service scripts can be used with uiHints.

- **F1-ExcelSpreadsheet.** This attachment BO has a maintenance pre-processing service script used to manipulate the attachment business object before rendering the maintenance map:
- **F1-AttchPre.** This pre-processing service script's schema mimics a maintenance map schema with embedded boGroup and action elements. It will be invoked before the maintenance map is rendered.

### Maintenance Post-Processing Service Script

Maintenance post-processing service scripts can be used with uiHints.

- **F1-ExcelSpreadsheet.** This attachment BO has a maintenance post-processing service script used to manipulate the attachment business object after rendering the maintenance map:
- **F1-AttchPost.** This post-processing service script's schema mimics a maintenance map schema with embedded boGroup and action elements. It will be invoked after the maintenance map is rendered.

## Technical Notes

The following prerequisites are required to support dynamic HTML generation:

### Schema Requirements

To support automated UI generation, the business object schema must contain the following:

- `<schema xmlns:uiHint="http://oracle.com/ouafUIHints">`. The schema node must name the uiHint namespace.
- `isPrimeKey="true"`. Every element of the business object schema that is part of the primary key must be identified.

### Maintenance Script Requirements

The maintenance script for the MO must be enabled for dynamic generation.

---

**CAUTION:** The business object maintenance BPA script must be declared as an MO Option for uiHint maintenance functionality to work!

---

If the script performs **F1-BOProc** then it is likely no special functionality is needed. However, if the maintenance script contains its own call to **F1-GetValOpt** then the following statement is required prior to that call:

```
move 'false' to "F1-GetBOOpts/input/maintenanceMapRequired";
performScript 'F1-GetValOpt';
```

After the call to **F1-GetValOpt** the following logic must be included to dynamically declare the map schema if the business object does not have a maintenance map of its own:

```
// Perform Main Processing
if ("F1-GetBOOpts/output/maintenanceMap = $BLANK")
  declareBOWithBOGroup "$bo" as 'map_schema';
else
  declareMap "F1-GetBOOpts/output/maintenanceMap" as 'map_schema';
```

end-if;

## Format an Input Map Title

**NOTE:** Throughout this topic the term "field" to refer to both the generic concept of displaying and capturing data in a 'field' as well as referring to the meta-data object supplied in the product to define [Fields](#). When referring to the latter, the term "MD Field" (meta-data Field) is used.

A uiHint element can be used to build a title for a maintenance map. The title will only print on the maintenance map, not on the display map. It will be printed as the first line in the map, centered, with a heading style.

Syntax	Description	Examples
<code>&lt;uiHint:title mdField=" "/&gt;</code>	Displays the label of a referenced MD field as the title.	<pre>&lt;schema xmlns:uiHint="http:// oracle.com/ouafUIHints"&gt; &lt;uiHint:title   mdField="STATUS_RSN_LBL" /&gt;   ... &lt;/schema&gt;</pre>
<code>&lt;uiHint:title text=" "/&gt;</code>	Displays the indicated text as the title. (Do not use this mechanism when multiple languages are supported.)	<pre>&lt;schema xmlns:uiHint="http:// oracle.com/ouafUIHints"&gt; &lt;uiHint:title   text="Status Reason" /&gt;   ... &lt;/schema&gt;</pre>

## Create a Section

The uiHint namespace supports the definition of a UI map section. Note that sections are currently created in generated UI Maps when the schema has a group or list node with a label or mdField. The functionality described here enables the creation of a section without requiring a labeled group or list node within the schema. Every section must be bounded by **startSection** and **endSection** element pair.

Syntax	Supporting Attributes	Description
<code>&lt;uiHint:startSection .../&gt;</code>	<code>sectionColumn="left   right   fullWidth   float"</code>	The default is that the section will be the full width in display maps. To override that setting, specify if you want a half-width section to appear in either the left ( <b>left</b> ) or right ( <b>right</b> ) column or to float ( <b>float</b> ). Sections that are marked as 'float' will display half-width and be aligned according to whether prior sections are displayed or conditionally hidden. For example, if a left-aligned section is followed by a floating section, the floating section will appear in the right column if the left section is populated but will display in the left column if the left section is hidden / collapsed.
	<code>editColumn="left   right   fullWidth   float"</code>	By default a section appears as full width in maintenance maps. To override that setting, specify if you want a half-width section to appear in either the left ( <b>left</b> ) or right ( <b>right</b> ) column or to float ( <b>float</b> ). The behavior is the analogous to the <b>sectionColumn</b> behavior.



Syntax	Supporting Attributes	Description
	sectionOpen="false"	By default a section is open on initial display. Specify this attribute to initially display the section as closed (collapsed).
	mdField=" "	Specify the name of a MD field whose label should be used as the section heading.
	label=" "	Specify the explicit text to use as the section heading.
	visibleOn="displayMap   inputMap"	By default a section appears on both the display and the input maps. Use this attribute to limit the display of the section to either the display map ( <b>displayMap</b> ) or input map ( <b>inputMap</b> ).

The syntax for the end section attribute is `<uiHint:endSection/>`

Examples:

```
<schema xmlns:uiHint="http://oracle.com/ouafUIHints">
  <uiHint:startSection label="Main" sectionColumn="left" />
  ...
  <uiHint:endSection/>
</schema>
```

```
<schema xmlns:uiHint="http://oracle.com/ouafUIHints">
  <uiHint:startSection mdField="F1-ADD-
INFO" sectionColumn="fullWidth" editColumn="float" sectionOpen="false" visibleOn="displayMap" />
  ...
  <uiHint:endSection/>
</schema>
```

**NOTE:** The sectionColumn, editColumn and sectionOpen attributes are available for group and list nodes as well.

## Include a Map Fragment

You can specify a UI map fragment to inject HTML into a generated map using the **includeMap** element name. This allows for you to support more sophisticated behavior on your user interface. For any element that is included for rendering in the map fragment, be sure to suppress the element in its schema definition, otherwise HTML will automatically be generated for the element.

Syntax	Supporting Attributes	Description
<code>&lt;uiHint:includeMap .../&gt;</code>	map=" "	Specify the name of the map.
	visibleOn="displayMap   inputMap"	By default the details from the map fragment appear on both the display and the input maps. Use this attribute to limit the display of the section.

Example:

```
<schema xmlns:uiHint="http://oracle.com/ouafUIHints">
  ...
  <uiHint:includeMap map="StandardActionButtons" visibleOn="displayMap" />
  ...
</schema>
```

**NOTE: Important note on the map fragment schema:** If a map fragment contains a schema, then the fragment schema structure will be injected into the dynamically generated schema when the business object is rendered for input.

Technically, the fragment schema will be inserted after the boGroup structure within the map's schema. This method may be used to support the implementation of maintenance pre and post script processing for a business object and oraInvokeBS function calls within embedded JavaScript.

If JavaScript is required within an XHTML UI Map fragment, it is necessary to bound it within a `![CDATA[ ]]` tag to ensure a valid XML document. Note that the tags themselves may need to be commented out to promote compatibility with older browsers. For example:

```
<script type="text/javascript">
/*  */
//
//javascript
//
/* ]&gt; */
&lt;/script&gt;</pre>
</div>
<div data-bbox="88 273 896 334" data-label="Text">
<p><b>Flush the cache:</b> For performance reasons, the Framework automatically caches business object schemas, data areas, and UI maps. When you update a business object, the cache is automatically flushed. However, if the business object includes either a data area or embedded UI map fragment, the cache must be manually flushed in order for your changes to be recognized. Refer to <a href="#">Server Cache</a> for more information.</p>
</div>
<div data-bbox="88 352 257 370" data-label="Section-Header">
<h2>Build A Dropdown</h2>
</div>
<div data-bbox="88 375 896 404" data-label="Text">
<p>Syntax is provided to build a dropdown list in an edit map. The dropdown may be built using data returned from a service script, a business service or a table.</p>
</div>
<div data-bbox="88 410 906 500" data-label="Table">
<table border="1">
<thead>
<tr>
<th>Syntax</th>
<th>Description</th>
</tr>
</thead>
<tbody>
<tr>
<td>uiHint:select="ss: "</td>
<td>Specify the name of the service script after the colon.</td>
</tr>
<tr>
<td>uiHint:select="bs: "</td>
<td>Specify the name of the business service after the colon.</td>
</tr>
<tr>
<td>uiHint:select="table: "</td>
<td>Specify the name of the table after the colon.</td>
</tr>
</tbody>
</table>
</div>
<div data-bbox="88 513 885 543" data-label="Text">
<p>When specifying a service script or a business service, extra mapping information is needed to pass data to and from the service.</p>
</div>
<div data-bbox="88 550 906 714" data-label="Table">
<table border="1">
<thead>
<tr>
<th>Syntax</th>
<th>Values</th>
<th>Description</th>
</tr>
</thead>
<tbody>
<tr>
<td rowspan="2">uiHint:selectIn=" "</td>
<td>serviceXPath:element</td>
<td>Used to pass the value of another element into the service (mapping to the service's XPath).</td>
</tr>
<tr>
<td>serviceXPath:'Literal'</td>
<td>Used to pass a constant or literal to the service (mapping to the service's XPath).</td>
</tr>
<tr>
<td>uiHint:selectOut="valuePath: ; descPath: "</td>
<td>See examples below.</td>
<td>Used to indicate which element in the service's output holds the values and which one holds the descriptions.</td>
</tr>
</tbody>
</table>
</div>
<div data-bbox="88 729 163 745" data-label="Text">
<p>Examples:</p>
</div>
<div data-bbox="88 751 870 888" data-label="Text">
<pre>&lt;schema xmlns:uiHint="http://oracle.com/ouafUIHints"&gt;
  &lt;boStatus mapField="BO_STATUS_CD" uiHint:select="bs:F1-BOStateReasonList"
    uiHint:selectIn="boStatusBO:boStatusBO" uiHint:selectOut="valuePath:results/status;
    descPath:results/description"/&gt;
  ...
  &lt;algorithm mdField="ALG_CD" uiHint:select="bs:F1-RetrieveSysEvtAlgorithms"
    uiHint:selectIn="algorithmEntity:'F1AA';" uiHint:selectOut="valuePath:results/algorithm;
    descPath:results/description"/&gt;
  ...
  &lt;outboundMsgType mdField="OUTMSG_TYPE_CD" required="true" fkRef="F1-
  OMTYP" uiHint:select="table:F1_OUTMSG_TYPE"/&gt;
&lt;/schema&gt;</pre>
</div>
<div data-bbox="467 942 913 959" data-label="Page-Footer">
<p>Oracle Utilities Customer to Meter Administrative User Guide • 270</p>
</div>
```

## Conditionally Hide Elements

The **displayNone** attribute is used to suppress elements on the map based on conditions.

Syntax	Values	Description
uiHint:displayNone=	"XPath','value','!='   '='"	Used to conditionally hide this element based on the value of another element (referenced using its XPath). Enter a value of '' to interrogate a blank value. By default the operator is '='. This may be overridden using '!='. <hr/>
	"function name, true   false"	Used to indicate a JavaScript function, which must return a Boolean. <hr/>

### WARNING:

Embedded spaces are not supported within the comma separated string values of this attribute.

This setting may be used on group nodes, list nodes, and elements - except for elements within a list. Elements within a list cannot be hidden conditionally.

The following example illustrates that two elements (currency reference and lookup) that will be hidden or displayed based on the value of the data type element. Note that this example also illustrates [Trigger Dependent Behavior](#) because the data type element's value may change and if it does, the condition for hiding the subsequent elements should be re-evaluated.

```
<schema xmlns:uiHint="http://oracle.com/ouafUIHints">
  ...
  <dataType mdField="F1_SE_DATA_TYPE" dataType="lookup" lookup="F1_SE_DATA_TYPE"
    uiHint:dependents="currencyRef;lookup; "/>
    <currencyRef mdField="F1_SE_CURR_REF_LBL" uiHint:displayNone='dataType','F1MO','!=' />
    <lookup mdField="F1_SE_LOOKUP_LBL" fkRef="F1-LKUPF" uiHint:displayNone='dataType','F1LP','!'
      =' ' />
  ...
</schema>
```

The following example illustrates referring to a function where the function receives parameters:

```
<uiHint:startSection mdField="F1_SE_DEFAULT_SECT"
  uiHint:displayNone="isApplicableForSchemaType(item,'F1MP'),true"/>
```

## Conditionally Protect Elements

The **protect** attribute is used to protect elements on the map based on other factors.

Syntax	Values	Description
uiHint:protect=	"XPath','value','!='   '='"	Used to conditionally protect this element based on the value of another element (referenced using its XPath). Enter a value of '' to interrogate a blank value. By default the operator is '='. This may be overridden using '!='. <hr/>
	"function name, true   false"	Used to indicate a JavaScript function, which must return a Boolean. <hr/>
	"action','A'   'C','!='   '='"	Use the <b>'action'</b> setting to protect the element based on the current action. For example, certain elements may only be specified when adding a record. Any subsequent changes to

Syntax	Values	Description
		the record should protect the element from being changed. When using this option, the valid values for the 'value' are <b>A</b> (add) and <b>C</b> (change).

**WARNING:**

Embedded spaces are not supported within the comma separated string values of this attribute.

The protect UI Hint may be used on group nodes, list nodes, and elements - except for elements within a list. Elements within a list cannot be protected conditionally.

The following UI Hint will protect the statistics category when the action is 'C'.

```
<schema xmlns:uiHint="http://oracle.com/ouafUIHints">
...
<statisticsCategory dataType="lookup" mapField="STAT_CATEGORY_FLG"
  lookup="STAT_CATEGORY_FLG" uiHint:protect="'action','C','='"/>
...
</schema>
```

### Trigger Dependent Behavior

The dependents attribute is used to trigger behavior on a child element when a parent element is changed.

Syntax	Values
uiHint:dependents=" "	A list of one or more dependent elements separated by semicolons.

The following example illustrates that the dropdown list of one element is driven by the value of another element. In this example, when the Country changes, the list of States to choose from should change to only show the states for the indicated country.

```
<schema xmlns:uiHint="http://oracle.com/ouafUIHints">
<country label="Country" uiHint:select="table:CI_COUNTRY" uiHint:dependents="state" />
<state label="State" uiHint:select="ss:CM-RetrieveCountryStates"
  uiHint:selectIn="input/country:country;" uiHint:selectOut="valuePath:output/state/stateCode;
  descPath:output/state/stateDesc" />
...
</schema>
```

**NOTE:**

Dependent targets may only name elements, not group or list nodes.

Do not modify the "id" attribute value of dependent and parent element. Data population in dependent is done based on the "id" attribute value.

### Control Rendering Target

By default all elements that are not suppressed are visible on both the display map and the input map. Use the **visibleOn** attribute to limit the inclusion of an element to either the display or input map.

Syntax	Values
uiHint:visibleOn=	"displayMap"
	"inputMap"

```
<schema xmlns:uiHint="http://oracle.com/ouafUIHints">
...
```

```
<uiHint:includeMap map="StandardActionButtons" visibleOn="displayMap"
...
</schema>
```

## Generate a Text Area

By default, a standard text box is rendered in an input map for any string element. If the field is larger and you wish to have a bigger text area (with a scroll bar), use the **textArea** attribute.

---

### Syntax

---

**uiHint:textArea="true"**

---

```
<schema xmlns:uiHint="http://oracle.com/ouafUIHints">
...
<message label="Message" uiHint:textArea="true"/>
...
</schema>
```

## Modify FK Reference Defaults

By default, when an element with **fkRef** is displayed, an info string, context menu, navigation, and search are enabled (if the FK reference has been configured accordingly). Syntax is provided to allow you to selectively turn off any of these features.

---

### Syntax

---

**uiHint:fkRef="info:false;context:false;navigation:false;search:false;"**

---

Only the feature that you wish to turn off needs to be specified. The following example illustrates turning off the navigation capability, meaning the text will not be rendered as hypertext.

```
<schema xmlns:uiHint="http://oracle.com/ouafUIHints">
...
<attachmentID fkRef="F1-
ATTCH" primeKey="true" suppress="input" uiHint:fkRef="navigation:false;"/>
...
</schema>
```

**FASTPATH:** Refer to [FK Reference Formatting](#) in the UI Map Attributes section for more information on each FK reference setting.

## Suppress Automatic Number Formatting

By default numeric fields (**dataType="number"**) are formatted as numeric fields. An attribute is provided to instead apply alphanumeric formatting.

Note: If **dataType** is not specified explicitly, it is derived from **mdField** or **mapField**.

---

### Syntax

---

**uiHint:alphaFormat="true|false"**

---

By default, its value is **false** (and therefore can be left out altogether).

Examples:

```
<schema xmlns:uiHint="http://oracle.com/ouafUIHints">
...
<numberCount mdField="" dataType="number" uiHint:alphaFormat="true"/>
...
</schema>
```

## Auto Capitalize the Input Data

The `uiHint` provides syntax to automatically capitalize input data.

---

### Syntax

---

`uiHint:capitalize="true|false"`

---

---

By default, its value is **false** (and therefore can be left out altogether).

```
<schema xmlns:uiHint="http://oracle.com/ouafUIHints">
  <toDoTypeCd mdField="TD_TYPE_CD" uiHint:capitalize='true' isPrimeKey="true"/>
</schema>
```

---

**NOTE:** This attribute is ignored if `uiHint:textArea="true"` is configured.

---

The attribute is only available in the schema designer when the `isPrimeKey` is set to **true**. The attribute may be added to any string element when using the source viewer.

## Schema Designer

The Schema Designer is a user-friendly interface for performing the following common schema editing tasks:

- Displaying existing schemas.
- Creating schema elements.
- Moving elements within a schema.
- Adding attribute values.

The designer provides two view modes:



- **Text** mode shows the schema elements and their attributes written in the proper syntax and allows for direct text entry.
- **Tree** mode is a view showing the elements in a tree format with many of the key attributes of each element in tabular form. While in this mode, the **Node Display** controls allow the user to choose between displaying the elements by their internal identifiers or their associated screen labels while viewing or editing the schema.

---

**NOTE:** Schemas that are not owned by the current installation owner are protected in both view modes.

---

The following sections provide more information about functionality available in the Tree mode.

- If the schema definition refers to another schema using an 'include' statement, a triangle is visible to the left of the tree area. One can expand that schema by clicking the triangle.
- Detailed information about an element's definition can be displayed and if applicable, updated from the **Tree** view by clicking the edit icon for that element, which appears on the right.  Note that the element attributes are only editable if the element is defined in this schema. When viewing the attributes of an element that is part of an 'include' of another schema, the attributes are display only.
- Context-sensitive embedded help is provided for fields and controls in the edit pane by clicking the Help icon 
- There is a menu dropdown icon visible to the left of the tree for any element that is defined in the current schema being viewed. It is not visible for elements included from another schema. New elements may be added in the **Tree** mode.

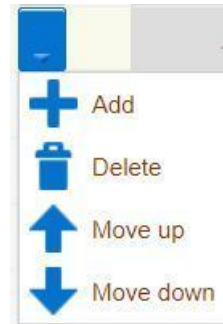

Clicking that dropdown displays options to Add, Delete or Move an element. Note that not all options are visible, based on what is allowed for the element adjacent to the menu. For example, on the main "schema" node, only the Add option is visible as deleting or moving the "schema" node is not applicable.

When adding a new element, you are prompted first for the element position, which is either a sibling node to the current element or a child node of that element. For either option, the new element is added below the one adjacent to where the menu is clicked. You are then prompted for the element type.

The following lists the possible element types. Most are self explanatory and represent standard schema options.

- **Characteristic List.** This is a special type of Flattened List element that is used to map list elements that include a sequence and a characteristic value for a given characteristic type. This element is only applicable for maintenance objects that have one or more characteristic child tables where the primary key is the maintenance object's key, characteristic type and sequence. Effective dated characteristic collections are not supported. The user defines the list name, the characteristic value element name and the characteristic type. The system will configure the remaining flattening information accordingly.
- **Characteristic.** This is a special type of Flattened Field element that is used to map a single element to the characteristic for a given characteristic type. This element is only applicable for maintenance objects that have one or more characteristic child tables where the primary key is the maintenance object's key, characteristic type and sequence. Effective dated characteristic collections are not supported. The user defines the element name and the characteristic type. The system will configure the remaining flattening information accordingly.
- **Comment.** This adds a comment to the schema.
- **Embedded HTML.** This is specific to a schema enabled for UI Hints. It is used to include a UI map fragment.
- **Field**
- **Flattened Field**
- **Flattened List**
- **Group**
- **Include BO Schema**
- **Include BS Schema**
- **Include DA Schema**
- **Include Map Schema**
- **Include SS Schema**
- **Input Map Title.** This is specific to a schema enabled for UI Hints. It is used to define a title element for the map.
- **List**
- **Nested Flattened Field.** This is a flattened field from a child table.
- **Raw Element.** This element is used to capture text as is. It is typically used to capture an XML structure without any details of the definition of the individual nodes.
- **Section.** This is specific to a schema enabled for UI Hints. It is used to define a section within the map.

- Simple Field. This is a special type of Field element that is used to define an element that is mapped to a column that supports data defined in an XML structure. (This is either a column with the character large object data type (CLOB) or the XML data type).

The **Schema Designer** is available by choosing the **Schema** tab on the [Business Object](#), [Data Area](#), [UI Map](#), [Business Service](#), and [Script](#) pages.

## Schema Viewer

The schema viewer shows a tree-view presentation of a schema in its expanded form.

The schema illustrates the structure to be used when communicating with the schema's associated object. The following takes place when a schema is expanded:

- If the schema definition includes references to other schemas, these references are replaced with the corresponding schema definitions.
- Also, if the schema definition contains **private** elements, they are omitted from this view.

Clicking on any node on the tree populates the text box on the top with the node's absolute XPath expression. You will find this feature very useful when writing scripts interacting with schema-based objects. [Scripting](#) often involves referencing elements in a schema-based XML document using their absolute XPath expression. You can use this feature on the schema viewer to obtain the XPath expression for an element and copy it over to your script.

## Business Event Log

Business Event Log may be viewed as a tool designed to capture any type of business event worth noting. You configure business objects to represent the various types of events your application calls for. The following type of details may be captured for each event:

- The business object representing the type of event.
- The date and time the event took place and who initiated it.
- The business entity for which this event is logged.
- Standard application message to describe the event.
- Additional context information that is available at the time of the event and varies for each type of event. The Business Event Log maintenance object supports a standard characteristics collection as well as an XML storage (CLOB) field. The event's business object determines where each piece of information resides. Refer to [Business Objects](#) for more information.

One common type of event may be the audit of changes made to sensitive data, for example, tracking an address change. Whenever an entity associated with a business object is added, changed, or deleted the system summarizes the list of changes that took place in that transaction and hands them over to **Audit** business object algorithms to process. You may design such an algorithm to audit the changes as business event logs. Refer to [a business object may define business rules](#) for more information.

You can also allow users to initiate business event logs to capture important notes about a business entity by exposing a [BPA Script](#) to invoke the event's corresponding business object.

Bottom line is that any process can create a business event log by invoking the business object representing the appropriate type of event.

### Where Used

Follow this link to open the data dictionary where you can view the tables that reference [F1\\_BUS\\_EVT\\_LOG](#).



## Miscellaneous Topics

The following sections describe miscellaneous system wide topics.

### Module Configuration

The system provides the ability to simplify the user interface based on functionality areas practiced by your organization. Menu items and other user interface elements are associated with function modules. By default, all function modules are accessible. If a function module is not applicable to your business you may turn it off. Refer to [Turn Off A Function Module](#) for more information on how to turn off a module.

If a function module is made non-accessible, i.e. turned off, its related elements are suppressed from the user interface. In addition the system may validate that related functionality is not accessed. This also means that turning off the wrong module may cause any of the following to occur:

- Menu items may not appear. Refer to [Menu Item Suppression](#) to better understand how menu item suppression works.
- Entire menus may not appear. Refer to [Menu Suppression](#) to better understand how menu suppression works.
- Tabs on pages may not appear.
- Fields may not appear.
- The system may return an error message when you attempt to use a function (indicating the function is turned off).

To correct the above situation, simply remove the module from the turned off list thus making it accessible again.

Your module configuration setup is displayed on the [installations](#) record.

### Menu Item Suppression

The following points describe how your module configuration can suppress [menu items](#).

- Menu items that are owned by the base product (as opposed to those your implementation adds) are associated with one or more function modules. If your module configuration has turned off all of the menu item's modules, the menu item is suppressed. If at least one of the modules is accessible, i.e. turned on, the menu item is not suppressed.
- If a menu line doesn't contain any accessible items, the menu line is suppressed.
- If all lines on a menu are suppressed, the menu itself ([Menu](#) or [Admin menu](#)) is suppressed in the application toolbar.

### Menu Suppression

In addition to the above Menu Item Suppression logic, the following points describe how your module configuration can suppress an entire menu.

- Menus that are owned by the base product (as opposed to those your implementation adds) are associated with one or more function modules.
- If your module configuration has turned off all of the menu's modules, the entire menu is suppressed. If at least one of the modules is accessible, i.e. turned on, the menu is not suppressed.

### Turn Off A Function Module

The base package is provided with a [Module Configuration Feature Configuration](#) that allows your organization to turn off base package function modules.

To turn off any of the base package function modules add a **Turned Off** option to this feature configuration referencing that module. Refer to the **MODULE\_FLG** lookup field for the complete list of the application's function modules.

Any module not referenced on this feature configuration is considered turned on, i.e. accessible. To turn on a module, simply remove its corresponding **Turned Off** option from this feature configuration.

You may view your module configuration setup on the [installation options](#) page.

---

**NOTE: Only one.** The system expects only one **Module Configuration** feature configuration to be defined.

---

## Global Context Overview

The framework web application provides each product the ability to nominate certain fields to act as a "global context" within the web application. For example, in Oracle Utilities Customer Care and Billing, the global context fields include Account ID, Person ID and Premise ID. The values of these fields may be populated as a result of searching or displaying objects that use these fields in their keys. If you navigate to the Bill page and display a bill, the global context is refreshed with the Account ID associated with that bill. The global context for Person ID and Premise ID are refreshed with data associated with that account.

The fields designated as global context for the product are defined using the lookup **F1\_UL\_CTXT\_FLDS\_FLG**.

Changing the values of the global context typically cause data displayed in zones on the dashboard to be refreshed to show information relevant to the current values of these global context fields.

When the value of one of the global context fields changes, an algorithm plugged into the [installation record](#) is responsible for populating the remaining global context values accordingly. Refer to your specific product for more information about the base algorithm that is provided for that product.

## System Data Naming Convention

There are several maintenance objects in the system that include owner flag in one or more of its tables. We refer to the data in these tables as "system data". Some examples of system data tables include Algorithm Type, Batch Control, Business Object and Script. Implementations may introduce records to the same tables. The owner flag for records created by an implementation is set to **CM** (for customer modification), however the owner flag is not part of the primary key for any of the system data tables. As a result, the base product provides the following guidelines for defining the primary key in system data tables to avoid any naming conflict.

## Base Product System Data

For any table that includes the owner flag, the base product will follow a naming convention for any new data that is owned by the base product. The primary key for records introduced by the product is prefixed with **xn-** where **xn** is the value of the owner flag. For example, if a new background process is introduced to the framework product, the batch code name is prefixed with **F1-**.

---

**NOTE:** There are some cases where the hyphen is not included. For example, portal codes omit the hyphen.

---

For most system data, the remainder of the primary key is all in capital case. An exception is schema oriented records. For business objects, business services, scripts, data areas and UI maps, the product follows the general rule of using CapitalCase after the product owner prefix. For example, **F1-AddToDoEntry** is the name of a base product business service.

---

**NOTE: Data Explorer Business Services.** For business services used to invoke a data explorer zone, it is recommended to name the Business Service the same name as the related zone rather than defining a different CapitalCase name for the business service.

---

Please note that this standard is followed for all new records introduced by the base product. However, there are base product entries in many of these system data tables that were introduced before the naming convention was adopted. That data does not follow the naming convention described above.

---

**NOTE: Schema naming conventions.** A context sensitive "Schema Tips" zone is associated with any page where a schema may be defined. The zone provides recommended naming conventions for elements within a schema along with a complete list of the XML nodes and attributes available to you when you construct a schema.

---

## Implementation System Data

When new system data is introduced for your implementation you must consider the naming convention for the primary key. The product recommends prefixing records with **CM**, which is the value of the owner flag in your environment. This is consistent with the base product naming convention. This convention allows your implementation to use the CM packaging tool in the Software Development Kit as delivered. The extract file provided with the tool selects system data records with an owner flag of **CM** and with a **CM** prefix.

---

**NOTE:** If you choose not to follow the CM naming convention for your records and you want to use the CM packaging tool, your implementation must customize the extract file to define the appropriate selection criteria for the records to be included in the package. Refer to the Software Development Kit documentation for more information.

---

Also note that owner flag may be introduced to an existing table in a new release. When this happens, the CM packaging tool is also updated to include these new system data tables. Your implementation will have existing records in those tables that probably do not follow any naming convention. After an upgrade to such a release, if you want to include this data in the CM packaging tool, you must customize the extract file for the tables in question.

## Referencing URIs

There are some configuration objects that require a reference to a URI, including file path URIs. The following sections highlight some functionality supported by the product with respect to defining / accessing URIs.

---

**NOTE:** In order for the functionality described below to occur, specific APIs must be used by the underlying code related to the fields that capture or process the file path or URL information. If you find that there is a URI-related field that does not provide the functionality described here, please contact customer support.

---

---

**NOTE:** For schema elements in a business object that reference a [Field](#) with the **URI** data type or define the element with the **URI** data type configured in the [schema](#) will automatically use the appropriate API that validates the value that may reference a substitution variable or must be checked against the whitelist if applicable.

---

## Validation Against a Whitelist

Based on a property setting, your implementation may be configured to define a whitelist of URIs. If this setting is enabled, the system will issue an error if the URI is not defined in the whitelist. Consult your system administrator to verify if this setting is enabled or not for your implementation.

---

**FASTPATH:** Refer to [URI Substitution](#) for information about how defining substitution tokens for URIs using the properties file technique automatically adds the defined URI to the whitelist.

---

## URI Substitution

The system supports the ability to define substitution variables (sometimes referred to as tokens) for both URL values and file path values that reference native file storage locations. For URLs, the system supports defining variables in a

Substitution Variable properties file. For native file storage paths, there are two options: the Substitution Variable properties file or via a File Storage configuration extendable lookup. More details on both these options are found below.

- Substitution variables properties file. A substitution variable for all or part of the URI definition may be configured in a properties file. This allows the system administrators to define the proper URI locations in a properties file whereas the configuration users only need to know the variable name. For example, when defining a location for an extract file in an extract batch job, instead of typing a file path of `h:\oracle\serverName\1.0.0\batch\extract\`, the batch user can enter `@FILE_EXTRACT@`, assuming there is an entry in the substitution variables file with a name of `FILE_EXTRACT`, and a value of `h:\oracle\serverName\1.0.0\batch\extract\`. Another example is that the batch user could enter `@BATCH_FILES@\extract\`, assuming that the URI variable for `BATCH_FILES` is defined as `h:\oracle\serverName\1.0.0\batch\`.

---

**NOTE:** The product automatically populates the value of `SPLOUTPUT` in the properties file so that this may be used in URI configuration. In addition, the product may supply some pre-defined variable names for other common references. As part of this, the 'advanced' menu in the system installation steps may prompt for installers to define the values of these pre-defined variables, if desired. Installations may opt to define additional substitution variables for various URI references. Refer to the *System Administration Guide* for more information.

---

- File Storage extendable lookup. Specifically for file paths that reference the native file system, the system also supports the ability to define a path using the **File Storage Configuration** extendable lookup. The following points highlight the steps to take for this option.
  - Navigate to [Extendable Lookup](#) and search for the **File Storage Configuration** lookup.
  - Click **Add** to create a new entry. Define a lookup value name. This will be used when configuring a file path that uses this value. Choose the File Adapter value of **Native File Storage**. Enter the desired file path value. The values defined here may in turn refer to values defined in the Substitution Variables properties file. For example, the file path can reference `@SPLOUTPUT@`.
  - To reference this value in system configuration, use the syntax `file-storage://XXXX`, where `XXXX` is the extendable lookup value. Using the same example from above, if you define an extendable lookup value of `CM-FileExtract` with a file path of `h:\oracle\serverName\1.0.0\batch\extract\`, then when configuring the extract file path for an extract batch job, enter `file-storage://CM-FileExtract`. Another example is that if the extendable lookup value's file path is configured as `h:\oracle\serverName\1.0.0\batch\`, then the user configuring the file path on the batch extract can enter `file-storage://CM-FileExtract/extract`

When should you define substitution variables in the properties file and when you define them in the extendable lookup? The following points highlight differences between the options that may help this decision.

- Substitution variables for URLs are only supported via the properties file.
- The properties file can typically only be modified by a system administrator. If there are values that are set at installation time and don't change, then defining the values in the properties file may be beneficial.
- When defining additional environments, such as test environments or production, the values in the extendable lookup may be copied using CMA. Ideally the values are defined such that they are the same between various regions.

## External File Storage

The system supports using Oracle Cloud Object Storage for cloud customers for managing files and can be configured to read files from or write files to this external location. Refer to Oracle Cloud Object Storage documentation for more information about obtaining an account and defining appropriate file locations or "buckets".

Once your cloud storage information is defined, the following points highlight the configuration steps required in the application.

- Define a [signature key ring](#). When the system tries to communicate with cloud object storage, it must provide a signature key so that cloud storage can confirm that the request is from a trusted source.

- Navigate to [Key Ring](#) in add mode and select the **Signature Key Ring** business object.
- Define a key ring code, which will be used in the File Storage configuration (below) along with a description.
- Once the key ring is added, click **Generate Key** to generate a private / public key pair.
- Click View Public Key to launch a pop-up that displays the public key, allowing the user to copy the key.
- At this point, the user should navigate to cloud object storage and register the public key. Once this is done, the key ring is now ready to be configured in file storage configuration.
- Use a File Storage extendable lookup to define the location and connection information so that you may reference this location in system configuration. The following points highlight the steps to take for this option.
  - Navigate to [Extendable Lookup](#) and search for the **File Storage Configuration** lookup.
  - Click **Add** to create a new entry. Define a lookup value name. This will be used when configuring a file path that uses this value. Choose the File Adapter value of **Oracle Cloud Object Storage**. Provide the following information that identifies the cloud storage options: User, Tenancy, Compartment, Namespace and Region. For the Key Ring, choose the value defined above.
- To reference this value in system configuration, use the syntax **file-storage://XXXX/...**, where XXXX is the extendable lookup value and any additional path information that is appropriate. For example, if you define an extendable lookup value of **CM-CloudStorage** and you have a bucket defined in Cloud Storage for processUpload, when configuring the file path for an upload batch job, enter **file-storage://CM-CloudStorage/processUpload**.

---

**NOTE:** The initial key pair is generated in the **Active** state. Once the key ring is defined on a File Storage lookup, it is recommended to practice key rotation and generate new keys periodically. To do this, use the **Generate Key** button on the Key Ring. New key pairs are generated in the **Inactive** state. The user should register the public key of the new key pair with cloud storage. Once that is done, the new key should be activated. The system generates the signature for connecting to cloud storage using the private key of the **Active** key pair for the key ring.

---

## Caching Overview

A great deal of information in the system changes infrequently. In order to avoid accessing the database every time this type of information is required by an end-user or a batch process, the system maintains a cache of static information on the web server and in the batch thread pool worker. These are referred to as the “application caches”. Some examples of application caches include

- System messages
- Field label and other field information
- Security Information

The framework product provides many specific caches for commonly used (and infrequently changed) data. In addition, specific edge applications may introduce additional caches as appropriate.

Information may also be cached on each user's browser.

The following topics highlight information about refreshing the various caches.

## Server Cache

The server cache refers to data that is cached on the web server. An important use of this cache is for users’ online access to the application. The caches aid in better performance while navigating throughout the system, allowing for data to be accessed from the cache rather than by always accessing the database. Besides user access to the web server cache, other functionality deployed to the web server uses caches in a similar way. For example, web services are deployed to the web server and access their own version of the cache.

The contents of the cache are cleared whenever the web server is restarted. This means that fresh values are retrieved from the database once users and web services start using the application again.

The product also supplies a flush command that one can issue in the browser's URL to immediately clear the contents of the cache. The command **flushAll.jsp** flushes every cache.

For example, assume the following:

- the web server and port on which you work is called **OU-Production:7500**
- you add a new record to a control table and you want it to be available on the appropriate transactions immediately

You would issue the following command in your browser's address bar: **http://OU-Production:7500/flushAll.jsp**. Notice that the command replaces the typical `cis.jsp` that appears after the port number.

If your system has been configured correctly, the **flushAll** command will submit a request to do a “global” flush of caches (including the web services cache and the thread pool worker cache). This functionality uses a JMS Topic to publish the flush request. Refer to the *Server Administration Guide* for details on how to configure the JMS topic.

## Batch Cache

When submitting a batch job, the batch component uses a Hibernate data cache to cache administrative data that doesn't change very often. The tables whose records are included in this cache are configured using the Caching Regime value of **Cached for Batch**. Refer to [Table - Main](#) for more information. When starting a thread pool worker, data in tables marked as cached is loaded and cached for as long as that thread pool is running.

In addition batch jobs may also access application caches when applicable. When starting a thread pool worker, application data that is cached is loaded and cached for as long as that thread pool is running.

If there is a change in cached data that should be available for the next batch job, the following points highlight how the cache can be refreshed:

- By default the system is configured to automatically refresh the Hibernate cache every 60 seconds. However, an implementation may override the configuration to either change the number of seconds between intervals or to disable the automatic caching altogether. Application caches used by the batch jobs are not impacted by this refresh.
- Restart the thread pool workers.
- Run the **F1-FLUSH** (Flush all Caches) background process. This background process will flush the application data cached for all thread pool workers for all thread pools.
- If your the region has configured the thread pool workers to “listen” to requests for global flush as described in the [Server Cache](#) topic, the thread pool worker caches are also refreshed when a **flushAll** command is issued.

## Client Cache

In addition to the web server's cache, information is also cached on each user's browser. After clearing the cache that's maintained on the web server, you must also clear the cache that's maintained on your client's browser. To do this, follow the following steps:

- Select **Tools** on your browser's menu bar
- Select **Internet Options...** on the menu that appears.
- Click the **Delete Files** button on the pop-up that appears.
- Turn on **Delete all offline content** on the subsequent pop-up that appears and then click **OK**.
- And then enter the standard URL to re-invoke the system.

---

**NOTE: Automatic refresh of the browser's cache.** Each user's cache is automatically refreshed based on the **maxAge** parameter defined in the web.xml document on your web server. We recommend that you set this parameter to **1** second

on development / test environments and **28800** seconds (8 hours) on production environments. Please speak to system support if you need to change this value.

## Expression Parser

The product provides support for defining expressions that may be of a mathematical or logical/boolean nature. The expression may include variables and functions.

The data explorer [column parameter](#) is an example of where this may be used. That parameter supports the definition of a formula. Edge applications may include support for a formula or expression using this parser as well. For example, several application include a type of 'rule' object (calculation rule, form rule or usage rule) that is used for validation or calculation that may support applying a formula.

The following tables highlight what is supported in the expressions that use this parser.

Category	Supported in Expression	Description
Data types	Number	
	String	
	Boolean	
	List	
Literals	Numbers	
	Strings surrounded with either single quote or double quote.	
	<b>NOTE:</b> 'Escaping' special characters is not currently supported.	
	Boolean values: <b>true</b> and <b>false</b> .	
Operations	+	Plus
	-	Minus
	/	Division
	*	Multiplication
	^ or **	Power
	%	Modulus
Logical operations	=	Equal
	>	Greater than
	>=	Greater than or equal to
	<	Less than
	<=	Less than or equal to
	!= or <>	Not equal to

This table identifies the functions that are supported. Note that several of the functions are applicable to a list of values. Note that although the functions are listed in lower case, the column parameter syntax in data explorer indicates referencing the functions as all capital letters. The system converts the data explorer column formula to lowercase before being evaluated.

Function	Parameter	Results	Comments
<b>size( )</b>	List element	Number of elements in the list.	
<b>isEmpty( )</b>	List element	Returns true if the list is empty.	
<b>sum( )</b>	List element of type 'number'	Returns the sum of the numbers in the list.	
<b>avg( )</b>	List element of type 'number'	Returns the average of the numbers in the list.	
	One or more numbers separated by commas	Returns the average of the number arguments.	
<b>max( )</b>	List element	Returns the largest value in the list.	

Function	Parameter	Results	Comments
	One or more comparable elements.	Returns the largest value of the number arguments.	
<b>min()</b>	List element	Returns the smallest value in the list.	
	One or more comparable elements.	Returns the smallest value of the number arguments.	
<b>abs()</b>	Number	Returns the absolute value.	
<b>ceiling()</b>	Number	Rounds the number to the ceiling.	
<b>exp10()</b>	Number	Raises 10 to the number power.	
<b>acos()</b>	Number	Returns the arc cosine of the number in radians.	The result will lose precision, as it uses double float based functions.
<b>asin()</b>	Number	Returns the arc sine of the number radians.	The result will lose precision, as it uses double float based functions.
<b>atan()</b>	Number	Returns the arc tangent of the number radians.	The result will lose precision, as it uses double float based functions.
<b>cos()</b>	Radian	Returns the cosine of the radian angle input.	The result will lose precision, as it uses double float based functions.
<b>exp()</b>	Number	Raises e to the number power.	The result will lose precision, as it uses double float based functions.
<b>log10()</b>	Number	Takes the log, base 10, of the number.	The result will lose precision, as it uses double float based functions.
<b>log()</b>	Number	Takes the natural log (base e) of the number.	The result will lose precision, as it uses double float based functions.
<b>sin()</b>	Radian	Returns the sine of the radian angle input.	The result will lose precision, as it uses double float based functions.
<b>sqrt()</b>	Number	Returns the square root of the number.	The result will lose precision, as it uses double float based functions.
<b>tan()</b>	Radian	Returns the tangent of the radian angle input.	The result will lose precision, as it uses double float based functions.
<b>floor()</b>	Number	Rounds the number to the floor.	
<b>round()</b>	Number	Assumes a scale of 0. The default rounding mode of "round half up" is applied.	
	Number, Scale	The default rounding mode of "round half up" is applied.	
	Number, Scale, Mode	The mode must be set to one of the following: <ul style="list-style-type: none"> <li>• "ROUND_CEILING"</li> <li>• "ROUND_DOWN"</li> <li>• "ROUND_FLOOR"</li> <li>• "ROUND_HALF_DOWN"</li> <li>• "ROUND_HALF_UP"</li> <li>• "ROUND_HALF_EVEN"</li> <li>• "ROUND_UP"</li> <li>• "ROUND_UNNECESSARY"</li> </ul>	
<b>negate()</b>	Number	Returns the negative value of the number.	Only available in data explorer.

The following are special functions supported in the application for a list of values. In each case, the syntax is *function* [ *indexVariable* in *listName* | *expression using indexVariable* ], where the *indexVariable* is chosen by the formula writer to represent each entry in the list and the expression used to evaluate each entry must reference that variable.

**NOTE:** The syntax supported for a given use of the formula in a functional area is driven by that particular functional area. For example, in Oracle Public Sector Revenue Management, a formula is supported in the "conditional element validation" form rule. In that form rule all variables including lists are declared in the form rule using letters and the formulas in turn use these letters. In that scenario, the functions below would reference the declared variable letter as the



“listName”. Other specific functional area that use this expression parser may support different syntax for referencing elements or lists.

Function	Description	Examples
<b>any [ ]</b>	This function returns the value <b>true</b> if any of the entries in list satisfies the expression.	The following returns <b>true</b> if any entry in the Balance list is greater than 0. <code>any [ i in list/Balance   i &gt; 0 ]</code>
<b>all [ ]</b>	This function returns the value <b>true</b> if all of the entries in the list satisfy the expression.	The following returns <b>true</b> if all phone numbers are populated. <code>all [ i in list/phoneNumber   i != ' ' ]</code>
<b>collect [ ]</b>	This function returns a new list of elements from the referenced list where the value of each entry of the new list is the result of the expression applied to each original value.	The following returns a new list with the tax rate applied to each amount. <code>collect [ i in list/amount   i * taxRate ]</code>
<b>select [ ]</b>	This function returns a list of all the values of the original list that satisfy the Boolean expression.	The following returns a new list with only the amounts that are negative numbers. <code>select [ i in list/amount   i &lt; 0 ]</code>
<b>reject [ ]</b>	This function returns a list of all the values of the original list that do not satisfy the Boolean expression.	The following returns a new list with only the amounts that are not negative numbers. <code>reject [ i in list/amount   i &lt; 0 ]</code>

## Debug Mode

Your implementation team can execute the system using a special mode when they are configuring the application. To enable this mode, enter **?debug=true** at the end of the URL that you use to access the application. For example, if the standard URL was **http://CD-Production:7500/cis.jsp**, you'd enter **http://CD-Production:7500/cis.jsp?debug=true** to enable configuration mode.

When in this mode certain debugging oriented tools become available right below the main toolbar.

- **Start Debug** starts a logging session. During this session the processing steps that you perform are logged. For example, the log will show the data areas that are passed in at each step and the data areas returned after the step is processed.
- **Stop Debug** stops the logging session.
- **Show Trace** opens a window that contains the logging session. All of the steps are initially collapsed.
- **Clear Trace** clears your log file.
- **Show User Log** allows you to view your own log entries. The number of "tail" entries to view may be specified in the adjacent **Log Entries** field before clicking the button. Limiting the number of entries to view allows the user to quickly and easily see only the latest log entries without having to manually scroll to the end of the log.
- Checking the **Global Debug** indication starts various tracing options.

Other parts of the system may show additional configuration oriented icons when in this mode. For example, explorer zones may provide additional tools to assist in debugging zone configuration. These icons are described in the context of where they appear.

Also, in debug mode drop down lists in data explorer and UI map zones will contain the code for each item in addition to the item's display string.

---

**NOTE: Show User Log button is secured.** An application service **F1USERLOG** has been provided for this functionality to allow implementations to restrict user access to this button. Such restriction may be called for in production environments.

---

## System Override Date

The system provides a way to override the system date used for online operations. This feature is available if the server administrator has enabled it in the environment properties. For instructions on configuring environment properties see the *Server Administration Guide*. The system date override feature is not recommended for production environments.

Under the **General System Configuration** [Feature Configuration](#), the **System Override Date Option Type** holds the date the application will use as the global system date instead of retrieving the same from the database. This feature can be especially useful in running tests that require the system date to be progressed over a period of time.

The system override date feature is also available at the user level. This is useful when a user wants override the system date to run tests without affecting the system date for other users in the environment. In order to override the system date for the user, open the [User — Characteristics](#) page, add the **System Override Date** characteristic type with a characteristic value set to the desired date in the YYYY-MM-DD format.

If system override dates are defined at both the feature configuration level and the user level, the date set at the user level will take precedence.

## Advanced Search Options

The product supports fuzzy searching in explorer zone types using the Oracle Text CONTAINS operator.

Refer to the DBA guide for details on setting up the database to support fuzzy searching. Note that there are some implementations where fuzzy searching will not be possible. For example, it's only available for implementations using the Oracle database. Additionally, not all languages are supported. Refer to the Oracle Database documentation for more information about fuzzy searching.

For information about the particular syntax to use in the explorer zones, refer to [SQL Statement](#) in the zone parameter details section.

## To Do Lists

Certain events that occur within the system will trigger messages describing work that requires attention. For example, if a bill segment has an error, the system generates a To Do message to alert the person responsible for correcting such errors.

Each type of message represents a To Do list. For example, there are To Do lists for bill segment errors, payment errors, customer contact reminder, etc.

We refer to each message as a **To Do Entry**. Each To Do entry is assigned a specific **To Do Role**. The role defines the users who may work on the entry. A To Do entry has a **To Do log** that maintains record of the progress on the To Do entry. For example, the To Do log indicates when the To Do entry was created, when it was assigned to a user and to whom it was assigned, and when and by whom it was completed.

---

**FASTPATH:** Refer to [To Do Processing](#) for a description of end-user queries and tools assisting in reviewing, assigning and processing To Do entries.

---

## The Big Picture of To Do Lists

The topics below provide more information about To Do configuration.

## To Do Entries Reference A To Do Type

Every [To Do entry](#) references a To Do type. The To Do type controls the following functions:

- The To Do list on which the entry appears.
- The page into which a user is taken when they drill down on an entry.
- The message that appears in the user's To Do list. Note this message can be overridden for specific To Do messages by specifying a different message number in the process that creates the specific To Do entry. For example, the process that creates To Do entries associated with bill segments that are in error displays the error message rather than a generic "bill segment is in error" message.
- The To Do list's sort options. Sort options may be used on the To Do list page to sort the entries in a different order. For example, when a user looks at the bill segment error To Do list, they have the option of sorting it in error number order, account name order, or in customer class order. Note the default sort order is also defined on To Do type.
- Whether (and how) the To Do entry is downloaded to an external system (e.g., an email system).
- The roles to which an entry may be reassigned.
- The default priority of the To Do list in respect of other To Do lists.
- The To Do list's usage, which indicates whether a To Do of that type may be created manually by a user.
- The algorithms used to perform To Do list specific business rules.
- The characteristics applicable to the To Do list.

## To Do Entries Reference A Role

Every [To Do entry](#) references a role. The role defines the users who may be assigned to **Open** entries.

The permissible roles that may be assigned to a To Do entry are defined on the entry's To Do type. After an entry is created, its role may be changed to any role defined as valid for the entry's To Do type.

An entry's initial role is assigned by the background process or algorithm that creates the entry. Because you can create your own processes and algorithms, there are an infinite number of ways to default an entry's role. However, the base package processes and algorithms use the following mechanisms to default an entry's role:

- The system checks if an entry's message category / number is suppressed (i.e., not created). If so, the entry is not created. Refer to [To Do Entries Can Be Rerouted Or Suppressed Based On Message Number](#) for more information.
- The system checks if an entry's message category / number is rerouted to a specific role. If so, it defaults this role. Refer to [To Do Entries Can Be Rerouted Or Suppressed Based On Message Number](#) for more information.
- Your specific product may introduce additional criteria for assigning a role, for example perhaps important accounts are assigned to a kind of account management group and the account management group includes configuration for special role for certain To Do types. Refer to [Set Additional Information Before a To Do is Created](#) for more information.
- If a Role wasn't determined in one of the previous steps and a Role is provided by the initiating process, the entry is created with that Role.
- If the entry does not have a role after the above takes place, the entry's To Do type's default role is assigned to the entry.

---

### NOTE:

At installation time, the system provides a default role assigned to the system To Do types when first installed called **F1\_DFLT**. This is done to allow testing of the system prior to implementing of appropriate To Do roles for your organization. The recommendation is to configure all the To Do Types with appropriate business oriented To Do roles once they are defined.

---

**CAUTION:** Important! Most organizations have the notion of a supervisor who is responsible for all entries assigned to a given role. It's important for this user (or users) to be part of all such roles. Refer to [To Do Supervisor Functions](#) for information about transactions that can be used by supervisors to review and assign work to users.

---

## To Do Entries Can Be Rerouted (Or Suppressed) Based On Message Number

Consider the To Do type used to highlight bill segments that are in error. To Do entries of this type reference the specific bill segment error number so that the error message can be shown when the Bill Segments in Error To Do list is displayed.

---

**NOTE: Message Category / Message Number.** Every error in the system has a unique message category / number combination. Refer to [The Big Picture of System Messages](#) for more information about message categories and numbers.

---

If you want specific types of errors to be routed to specific users, you can indicate such on the To Do type. For example, if certain bill segment errors are always resolved by a given rate specialist, you can indicate such on the To Do type. You do this by updating the [To Do type's message overrides](#). On this page you specify the message category / number of the error and indicate the To Do role of the user(s) who should work on such errors. Once the To Do type is updated, all new To Do entries of this type that reference the message number are routed to the desired role.

---

**NOTE: Reroute versus suppression.** Rather than reroute an entry to a specific role, you can indicate that an entry with a given message number should be suppressed (i.e., not created). You might want to do this if you have a large volume of certain types of errors and you don't want these to clutter your users' To Do lists.

---

Obviously, you would only reroute those To Do types that handle many different types of messages. In other words, if the To Do type already references a specific message category / number rerouting is not applicable.

We do not supply documentation of every possible message that can be handled by a given To Do type. The best way to build each To Do type's reroute list is during the pre-production period when you're testing the system. During this period, compile a list of the messages that should be routed to specific roles and add them to the To Do type.

Keep in mind that if a message number / category is not referenced on a To Do type's reroute information, the entry is routed as described under [To Do Entries Reference A Role](#).

---

**NOTE: Manually created To Do entries cannot be rerouted or suppressed.** The rerouting occurs as part of the batch process or algorithm processing when the To Do is created. The role or user to whom a manual To Do should be assigned is specified when the To Do is created online. A manually created To Do may also be forwarded to another user or role.

---

## The Priority Of A To Do Entry

Some To Do entries may be more urgent to resolve than others. A To Do entry is associated with a priority level representing its relative processing order compared to other entries.

Priority level is initially assigned as follows:

- If one or more **Calculate Priority** plug-ins are defined on the To Do entry's type, the system calls them to determine the entry's priority. They are called initially when a To Do entry is created and each time it gets updated. You may want to use this method if an entry's priority is based on context or time-based factors. For example, when priority takes into consideration account specific attributes. The system also provides a batch process ([F1-TDCLP](#)) that calls the calculate priority algorithms "at will" for non-closed To Do entries. This is useful when the priority should be reassessed periodically based on factors external to the To Do entry's information. Refer to [To Do Type](#) for more information on priority calculation algorithms. When the priority is determined by one of the algorithms, a log entry is created indicating that the priority was calculated.
- If a priority value has not been determined by a plug-in, the system defaults a To Do entry's initial priority to the value specified on its type.

A user may manually override a To Do entry's priority at any time. When a user overrides the priority a log entry is created indicating that the priority was overridden. Notice that once a To Do entry's priority is overridden, **Calculate Priority** plugins are no longer called so as to not override the value explicitly set by the user.

---

**NOTE:** The system does not use priority values to control order of assignment nor processing of To Do entries. Priority is available to assist your organization with supporting a business practice that ensures higher priority issues are worked on first.

---

## Working On A To Do Entry

A user can drill down on a To Do entry. When a user drills down on an entry, the user is transferred to the transaction associated with the entry. For example, if a user drills down on a bill segment error entry, the user is taken to the Bill Segment - Main page. Obviously, the page to which the user is taken differs depending on the type of entry.

It is also possible to configure the To Do type to launch a [script](#) when a user drills down on an entry rather than taking the user to a transaction. The script would walk the user through the steps required to resolve the To Do entry. Refer to [Launching Scripts When A To Do Is Selected](#) for more information.

After finishing work on an entry, the user can mark it as **Complete**. Completed entries do not appear on the To Do list queries (but they are retained on the database for audit purposes). If the user cannot resolve the problem, the user can forward the To Do to another user.

## Monitoring A To Do Entry

A To Do type may reference a To Do monitor [algorithm](#). The algorithms are executed by the To Do monitor background process (F1-TDMON). The process executes the monitor algorithms for any non-complete To Do entry whose To Do type references at least one monitor algorithm.

Monitor algorithms may be useful if there are business requirements where a To Do could be automatically completed based on criteria that the algorithm can review. For example, an algorithm may be used to detect if the situation that caused the To Do Entry to be generated has been remedied in the meantime, allowing for the To Do Entry to be completed.

## Launching Scripts When A To Do Is Selected

Users can complete many To Do entries without assistance. However, you can set up the system to launch a [script](#) when a user selects a To Do entry. For example, consider a To Do entry that highlights a bill that's in error due to an invalid mailing address. You can set up the system to execute a script when this To Do entry is selected by a user. This script might prompt the user to first correct the customer's default mailing address and then re-complete the bill.

A script is linked to a To Do type based on its message number using the [To Do type's message overrides](#). Refer to [Executing A Script When A To Do Is Selected](#) for more information.

## To Do Entries Have Logs

Each [To Do entry](#) has a To Do log that maintains a record of the To Do's progress in the system. For example, the To Do log indicates when the To Do entry was created, when it was assigned to a user and to whom it was assigned, and when and by whom it was completed. Users can view the log to see who assigned them a particular To Do and whether any work has already been done on the To Do.

A log entry is created for all actions that can be taken on a To Do entry. Log entries are created for the following events:

- A To Do entry is created (either by the system or by a user)
- A To Do entry is completed (either by the system or by a user)
- A user takes an open To Do entry

- A supervisor assigns a To Do entry
- A user forwards an entry to another user or role
- A user sends back a To Do to the user who forwarded it
- A user manually adds a log entry to record details about the To Do's progress
- A user manually overrides the To Do entry's priority
- The To Do entry's priority was updated as a result of a calculate priority algorithm.

---

**FASTPATH:** For information about the contents of log entries for each of the events, refer to [Log Entry Events](#).

---

## How Are To Do Entries Created?

A To Do Entry may be created in the following ways:

- A [background process](#) can create To Do Entries.
- An [algorithm](#) can create entries of a given type. Because the use of algorithms is entirely dependent on how you configure the control tables, the number of types of such entries is indeterminate.
- A user can create entries of To Do types that have a **Manual** usage. Refer to [To Do Entries Created Manually](#) for information about setting up manual To Do types.

For any base product process that includes logic to create a To Do entry, the system supplies a sample To Do type that may be used. Although the To Do types provided by the product are system data, the following information related to each To Do type may be customized for an implementation and is not overwritten during an upgrade:

- The creation process. If the To Do is created by a background process where the background process is referenced on a To Do type. Refer to [To Do Entries Created By Background Processes](#) for more information.
- The routing process. Refer to [To Do Entries May Be Routed Out of the System](#) for more information.
- The priority. Refer to [To Do Type - Main](#) for more information.
- The [roles](#) that may be associated with the To Do type. Refer to [To Do Entries Reference a Role](#) for more information.
- The [message override](#) information. Refer to [To Do Entries Can Be Rerouted \(Or Suppressed\)](#) and [Launching Scripts When a To Do Is Selected](#) for more information.

## To Do Entries Created By Background Processes

There are different types of To Do entries created by background processes:

- To Do entries created by dedicated To Do background processes
- To Do entries created for object-specific errors detected in certain background processes
- To Do entries created based on a specific condition

## Dedicated To Do Background Processes

There are To Do entries that are created by system background processes whose main purpose is to create To Do entries based on a given condition. For these background processes, the To Do Type indicates the creation background process.

---

**NOTE:** If you don't schedule the background process, the entries will **not** be created! The To Do entries of this type will only be created if you have scheduled the associated background process. Therefore, if you want the system to produce a given entry, schedule the background process.

---

## To Dos Created for Object-Specific Error Conditions

A system background process may create a To Do entry when an error is detected during object-specific processing. This is applicable for processes that do not have built in error handling, for example where there is an explicit “error” state or where the record has an explicit “exception” record.

For these background processes, the To Do Type must reference the creation background process.

To have the system create To Do entries for some or all of the errors generated by one of these processes, you must do the following:

- If you want the system to generate To Do entries for errors detected by one of the background processes below, go to the appropriate To Do type and populate the creation background process.
- If you want the system to generate To Do entries for some errors for the process, but not for all errors, populate the creation background process and then proceed to the [message overrides](#) tab to [suppress](#) certain messages. To this by indicating the message category and message number you want to suppress. Any error that is suppressed is written to the [batch run tree](#).

The functionality will only create a new To Do entry if there is not already an existing (non-complete) To Do for the same To Do type, drill key and message category / message number. It will also check for an existing To Do for a successfully processed record and complete that To Do.

If you do not populate the creation background process, the errors are written to the [batch run tree](#).

---

**NOTE: Errors received while creating a To Do entry.** If the background process cannot successfully create a To Do entry to report an object-specific error, the error is written to the batch run tree along with the error encountered while attempting to create the To Do entry.

---

**NOTE: System errors are not included.** To Do entries are not created for a system error, for example an error related to validation of input parameter. These errors are written to the [batch run tree](#). Refer to [Processing Errors](#) for more information.

---

## To Dos Created by Background Processes for Specific Conditions

There are some system background processes that create a To Do entry when the process detects a specific condition that a user should investigate. For each background process, the To Do type is an input parameter to the process. The system provides To Do types for each base package background process that may create a To Do entry.

---

**NOTE: No Creation Process.** These To Do types do not need (and should not have) a **Creation Process** specified.

---

## To Do Entries Created By Algorithms

There are To Do entries that are created by algorithm types supplied with the base package. The system supplies a To Do Type for each of these To Do entries that you may use.

If you want to take advantage of these types of entries for system algorithm types, you must do the following:

- Create an [algorithm](#):
  - This algorithm must reference the appropriate Algorithm Type.
  - These algorithms have a parameter of the To Do Type to be created. You should specify the To Do Type indicated in the table.
- Plug the algorithm into the respective control table.

## To Do Entries Created Manually

You must set up manual To Do entry types if you want your users to be able to create To Do entries online. Users may create a manual To Do entry as a reminder to themselves to complete a task. Online To Do entries may also be used like electronic help tickets in the system. For example, if a user is having a problem starting service, the user can create a To Do that describes the problem. The To Do can be assigned to a help resolution group that could either resolve the problem or send the To Do back to the initiating user with information describing how to resolve the problem.

If you want to take advantage of manual To Do entries, create a To Do type and specify the following information.

### On the Main tab:

- Set the **To Do Type Usage** flag to **Manual**.
- Set the **Navigation Option** to **toDoEntryMaint** (To Do entry maintenance).
- Set the **Message Category** and **Message Number** to the message you want to be used for To Do entries of this type. The system will populate the message parameter with the Subject. To show only the subject in the To Do's message, use a message with "%1" as its text.

### On the Roles tab:

- Specify the [To Do roles](#) that may be assigned to To Do entries of this type.
- Indicate the To Do role that should be defaulted when you create To Do entries of this type.

### On the Sort Keys tab:

When a user adds a manual To Do entry, the system creates an entry with three sort key values. (Sort keys may be used on the To Do list page to sort the entries in a different order.) The To Do type should be set up to reference the sort keys as follows:

Sequence	Description
1	Created by user ID
2	Created by user name
3	Subject

We recommend that the keys have an **Ascending** sort order and that the Subject is made the default sort key.

**NOTE:** It is possible to define additional sort keys and use a To Do Post Processing algorithm to populate the values. In this case, the base sort keys defined above should still be defined.

### On the Drill Keys tab:

When a user adds a manual To Do entry, it is created with a drill key value equal to the To Do entry's ID. When the user clicks the Go To button next to the message in the To Do list, the system uses the drill down application service (defined on the main tab) and the drill key to display the associated To Do entry.

The To Do type must be set up with a drill key that reference the To Do entry table and the To Do entry ID:

Sequence	Table	Field
1	CI_TD_ENTRY	TD_ENTRY_ID

## The Lifecycle Of A To Do Entry

The following state transition diagram will be useful in understanding the lifecycle of a To Do entry.



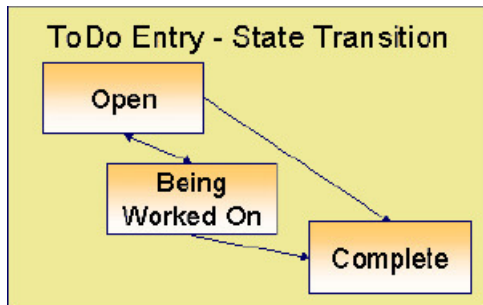

A To Do entry is typically created in the **Open** state. Entries of this type can be viewed by all users belonging to the entry's role. Refer to [How Are To Do Entries Created?](#) for information about how entries are created.

An **Open** entry becomes **Being Worked On** when it is assigned to a specific user or when a user proactively assumes responsibility for the entry. While an entry is **Being Worked On**, it is visible on the To Do Summary page only by the user who is assigned to it.

---

**NOTE:** To Do entries may be created in the **Being Worked On** state. Some To Do background processes may create To Do entries in the **Being Worked On** state. When a user adds a To Do entry online and assigns the To Do to a user (as opposed to a role), the To Do entry is also created in the **Being Worked On** state.

---

A **Being Worked On** entry may be forwarded to a different user or role. If the entry is forwarded to a role, it becomes **Open** again.

When an entry becomes **Complete**, it is no longer visible in the To Do list queries (but it remains on the database for audit purposes). There are two ways an entry can become **Complete**:

- A user can manually indicate it is **Complete** (there are several ways to do this).
- For To Do entries that are logically associated with the state of some object, the system automatically marks the entry **Complete** when the object is no longer in the respective state. For example, an entry that's created when an account doesn't have a bill cycle is completed when the account has a bill cycle.

---

**CAUTION:** Important! The automatic completion of To Do entries occurs when the background process responsible for creating entries of a given type is executed. Therefore, if you only run these processes once per day, these entries remain **Being Worked On** even if the object is no longer in the respective state.

---

- The To Do monitor process may be used to evaluate whether or not the To Do entry can be closed automatically. Refer to [Monitoring a To Do Entry](#) for more information.

## Linking Additional Information To A To Do Entry

Additional information may be linked to a To Do entry using characteristics. For example, when creating a manual To Do entry, a user may define the account related to the To Do.

When creating an automatic To Do entry, the program that generates the To Do may link related data to the To Do using characteristics. In addition, a system [algorithm](#) allows you to automatically to link related entities. For manually created To Dos, the valid characteristic types that may be linked to the To Do entry must be defined on the [To Do type](#) for that To Do entry.

If your To Do entries reference characteristics that are related to your global context data, you may want to configure an [alert algorithm](#) to display an alert if a related entry is **Open** or **Being Worked On**.

## Implementing Additional To Do Entry Business Rules

If your business practice calls for additional validation rules or processing steps to take place after a To Do Entry is created or updated, you may want to take advantage of the **To Do Post Processing** plug-ins defined on [To Do type](#).

For example, you may want to validate that To Do entries are only assigned to users with the proper skill levels needed to resolve them. Refer to [F1-VAL-SKILL](#) for a sample algorithm handling such validation.

## To Do Entries May Be Routed Out Of The System

A To Do type can be configured so that its entries are interfaced to another system.

For example, a given To Do type can be configured to create an email message whenever a new To Do entry is created. The following points describe how to do this:

- Define the name of the background process responsible for interfacing the new To Do entries to another system on the respective To Do type. The base package contains a batch process called [F1-TDEER](#) that can be used for most situations. This batch process invokes the **External Routing algorithms** defined on each entry's To Do type.
- Plug in an appropriate **External Routing** algorithm on the respective To Do type. The logic in this type of algorithm performs the interface efforts for a specific To Do entry. For example, if an email message should be created for a To Do entry, the logic in the algorithm would compose and send the email message(s) for a specific To Do entry.

Click [here](#) to see the algorithm types available for this system event.

## Periodically Purging To Do Entries

**Completed** To Do entries should be periodically purged from the system by executing the [F1-TDPG](#) background process. This background process offers you the following choices:

- You can purge all To Do entries older than a given number of days.
- You can purge To Do entries for a specific list of To Do types that are older than a given number of days.
- You can purge all To Do entries except for a specific list of To Do types that are older than a given number of days.

We want to stress that there is no system constraint as to the number of **Completed** To Do entries that may exist. You can retain these entries for as long as you desire. However, you will eventually end up with a very large number of **Completed** entries and these entries will cause the various To Do background processes to degrade over time. Therefore, you should periodically purge **Completed** To Do entries as they exist only to satisfy auditing and reporting needs.

---

**NOTE: Different retention periods for different types of To Do entries.** Keep in mind that the purge program allows you to retain different types of entries for different periods of time.

---

## Setting Up To Do Options

The topics in this section describe how to set up To Do management options.

## Installation Options

The following section describes configuration setup on the installation options.

## To Do Information May Be Formatted By An Algorithm

A **To Do Information** algorithm may be plugged in on the [installation record](#) to format the standard To Do information that appears throughout the system. This algorithm may be further overridden by a corresponding plug-in on the [To Do Type](#).

## Set Additional Information Before A To Do Is Created

A **To Do Pre-creation** algorithm may be plugged in on the [installation record](#) to set additional information for a To Do entry before it is created. Algorithms of this type are used for two common purposes:

- Linking context specific data to the To Do entry using characteristics. For example, Oracle Utilities Customer Care and Billing provides an algorithm that attempts to link a related person, account, premise, service agreement or service point to a To Do entry based on its drill key value. Note, before you can set up this algorithm, you must define the characteristic types that you'll use to hold each of these entities. Also note that it is not necessary to define these characteristics as valid characteristic types on the To Do type.
- Overriding the Role of a To Do entry based on specific configuration related to the To Do's context data. For example, Oracle Utilities Customer Care and Billing provides an algorithm to determine a To Do role based on overrides related to the account's account management group or division.

## Alerts

If your To Do entries reference characteristics related to your global context data and your product supports dashboard alerts generated by algorithms, you may want configure an algorithm to display an alert if the entry is **Open** or **Being Worked On** for the data currently in context.

Refer to your product's documentation to determine if these types of alerts are supported.

## Next Assignment Algorithm

If your organization opts to use the next assignment feature supported by the Current To Do dashboard zone, you need to plug-in a **Next To Do Assignment** algorithm into the [installation options](#) to determine the next To Do entry the user should work on. Make sure you provide users with security access rights to the zone's next assignment action.

---

**FASTPATH:** Refer to the [Current To Do](#) zone for more information.

---

## Messages

You need only set up new messages if you use algorithms to create To Do entries or prefer different messages than those associated with the base package's To Do types.

## Feature Configuration

The base package is provided with a generic **Activity Queue Management Feature Configuration** type. You may want to set up a feature configuration of this type to define any To Do management related options supporting business rules specific to your organization.

For example, the base package provides the following plug-ins to demonstrate a business practice where To Do entries are only assigned to users with the proper skill levels to work on them.

- The base **To Do Post Processing** To Do Type algorithm [F1-VAL-SKILL](#) validates that a user has the necessary skill levels required to work on a given To Do entry.
- The base **Next To Do Assignment** installation options algorithm [F1-NEXT-ASSG](#) only assigns To Do entries to users that have the proper skills to work on them. This plug-in is only applicable if your organization practices [work distribution](#) "on demand."

You must set up such an **Activity Queue Management** feature configuration if you want to use any of the above base package plug-ins.

The following points describe the various **Option Types** provided with the base package:

- **Skill.** This option provides a reference to a skill category. For example, if you were using characteristics to represent skill categories then you should reference each characteristic type using this option.
- **Override Skill.** This option provides an override skill information reference for a specific message. For example, if you were using a To Do Type characteristic to specify an override skill category and level for a specific message category / number then you would reference this characteristic type using this option.

---

**NOTE: Skill Setup.** Refer to the description of the above base package algorithms for further details on how to setup skill level information.

---



---

**NOTE: More Options.** Your implementation may define additional options types. You do this by add new lookup values to the lookup field **F1QM\_OPT\_TYP\_FLG**.

---



---

**NOTE: Only one.** The system expects only one **Activity Queue Management** feature configuration to be defined.

---

## Defining To Do Roles

This section describes the control table used to maintain To Do roles.

### To Do Role - Main

The **Main** page is used to define basic information about a To Do role.

To maintain this information, select **Admin > General > To Do Role**.

#### Description of Page

Enter a unique **To Do Role** and **Description** for the To Do role.

The grid contains the ID of each **User** that may view and work on entries assigned to this role. The First Name and Last Name associated with the user is displayed adjacent.

---

**NOTE: System Default Role.** The system supplies a default role **F1\_DFLT** linked to each system To Do type. This is done so that To Do functionality may be tested prior to the creation of appropriate business oriented To Do roles.

---

#### Where Used

Follow this link to view the tables that reference [CI\\_ROLE](#) in the data dictionary schema viewer.

In addition, various "type" objects or algorithms may reference a To Do role to use when creating a To Do for a given business scenario. This is dependent on your specific product.

## To Do Role - To Do Types

The **To Do Types** page defines the To Do types that may be viewed and worked on by users belonging to a given To Do role.

To maintain this information, select **Admin > To Do Role > Search** and navigate to the **To Do Types** page.

### Description of Page

Enter the ID of each **To Do Type** whose entries may be viewed and worked on by the role.

**Use As Default** is a display-only field that indicates if the role is assigned to newly created entries of this type. You may define the default role for a given To Do type on the To Do Type maintenance page.

---

**CAUTION:** If you remove a To Do type where this role is the default, you must define a new role as the default for the To Do type. You do this on the To Do Type maintenance page.

---

## Defining To Do Types

This section describes the control table used to maintain To Do types.

### To Do Type - Main

The **Main** page is used to define basic information about a To Do type.

---

**FASTPATH:** Refer to [The Big Picture Of To Do Lists](#) for more information about To Do types and To Do lists in general.

---

To maintain this information, select **Admin > General > To Do Type**.

---

**CAUTION:** Important! If you introduce a To Do type, carefully consider its naming convention. Refer to [System Data Naming Convention](#) for more information.

---

### Description of Page

Enter a unique **To Do Type** and **Description** for the To Do type.

**Owner** indicates if this entry is owned by the base package or by your implementation (**Customer Modification**).

Use the **Detailed Description** to provide further details related to the To Do Type.

Enter the default **Priority** of To Do entries of this type in respect of other To Do types. Refer to [The Priority Of A To Do Entry](#) for more information.

For **To Do Type Usage**, select **Automatic** if To Dos of this type are created by the system (i.e., a background process or algorithm). Select **Manual** if a user can create a To Do of this type online.

Define the **Navigation Option** for the page into which the user is transferred when drilling down on a To Do entry of this type.

Use **Creation Process** to define the background process, if any, that is used to manage (i.e., create and perhaps complete) entries of this type. A **Creation Process** need only be specified for those To Do types whose entries are created by a background process. Refer to [To Do Entries Created By Background Processes](#) for more information.

Use **Routing Process** to define the background process that is used to download entries of a given type to an external system, if any. A **Routing Process** need only be specified for those To Do types whose entries are routed to an external system (e.g., an Email system or an auto-dialer). Refer to [To Do Entries May Be Routed Out Of The System](#) for more information.

Use **Message Category** and **Message Number** to define the message associated with this To Do type's entries. Note: this message will only be used if the process that creates the To Do entry does not supply a specific message number. For example, the process that creates To Do entries that highlight bill segments that are in error would not use this message; rather, the entries are marked with the message associated with the bill segment's error.

Use the characteristics collection to define a **Characteristic Type** and **Characteristic Value** common to all To Do entries of this type. You may enter more than one characteristic row for the same characteristic type, each associated with a unique **Sequence** number. If not specified, the system defaults it to the next sequence number for the characteristic type.

#### Where Used

Follow this link to view the tables that reference [CI\\_TD\\_TYPE](#) in the data dictionary schema viewer.

## To Do Type - Roles

The **Roles** page defines the roles who may view and work on entries of a given To Do type.

To maintain this information, select **Admin > To Do Type > Search** and navigate to the **Roles** page.

#### Description of Page

Enter each **To Do Role** that may view and work on entries of a given type. Turn on **Use as Default** if the role should be assigned to newly created entries of this type. Only one role may be defined as the default per To Do type.

---

**FASTPATH:** Refer to [To Do Entries Reference A Role](#) for more information about roles and To Do entries.

---

## To Do Type - Sort Keys

The **Sort Keys** page defines the various ways a To Do list's entries may be sorted. For example, when you look at the bill segment error To Do List, you have the option of sorting the entries in error number order, account name order, or in customer class order.

To maintain this information, select **Admin > To Do Type > Search** and navigate to the **Sort Keys** page.

---

**CAUTION:** Do not change this information unless you are positive that the process / algorithm that creates entries of a given type stores this information on the entries.

---

#### Description of Page

The following fields display for each sort key.

**Sequence** is the unique ID of the sort key.

**Description** is the description of the sort key that appears on the To Do list.

**Use as Default** indicates the default sort key (the one that is initially used when a user opens a To Do list). Only one sort key may be defined as the default per To Do type.

**Sort Order** indicates whether the To Do entries should be sorted in **Ascending** or **Descending** order when this sort key is used.

**Owner** indicates if this entry is owned by the base package or by your implementation (**Customer Modification**).

## To Do Type - Drill Keys

The **Drill Keys** page defines the keys passed to the application service (defined on the Main page) when you drill down on an entry of a given type.

To maintain this information, select **Admin > To Do Type > Search** and navigate to the **Drill Keys** page.

---

**CAUTION:** Do not change this information unless you are positive that the process / algorithm that creates entries of a given type stores this information on the entries.

---

### Description of Page

**Navigation Option** shows the page into which the user is transferred when drilling down on a To Do entry of this type.

The following fields display for each drill key.

**Sequence** is the unique ID of the drill key.

**Table** and **Field** are passed to the application service when you drill down on an entry of a given type.

**Owner** indicates if this entry is owned by the base package or by your implementation (**Customer Modification**).

## To Do Type - Message Overrides

The **Message Overrides** page is used if you want To Do entries that reference a given message category / number to be routed to a specific To Do role (or suppressed altogether) or if you want to associate a script to a given message category / number.

---

**FASTPATH:** Refer to [To Do Entries Reference A Role](#) and [To Do Entries Can Be Rerouted Or Suppressed](#) for more information.

---

To maintain this information, select **Admin > To Do Type > Search** and navigate to the **Message Overrides** page.

### Description of Page

The following fields display for each override.

**Message Category** and **Number** allow the message to be overridden.

**Exclude To Do Entry** indicates if a To Do entry of this type that references the adjacent **Message Category** and **Number** should not be created.

**Override Role** indicates the to do role to which a To Do entry of this type that references the adjacent **Message Category** and **Number** should be addressed. This field is protected if **Exclude To Do Entry** is on.

**Script** indicates the script that should execute when a user drills down on a To Do entry of this type that references the adjacent **Message Category** and **Number**. This field is protected if **Exclude To Do Entry** is on. Refer to [Working On A To Do Entry](#) for more information.

## To Do Type - To Do Characteristics

The **To Do Characteristics** page defines characteristics that can be defined for To Do entries of this type. The characteristic types for characteristics that are linked to the To Do entry as a result of a pre-creation algorithm do not need to be defined here.

To maintain this information, select **Admin > General > To Do Type > Search** and navigate to the **To Do Characteristics** page.

Turn on the **Required** switch if the **Characteristic Type** must be defined on To Do entries of this type.

Enter a **Characteristic Value** to use as the default for a given **Characteristic Type** when the **Default** switch is turned on. Use **Sequence** to control the order in which characteristics are defaulted.

## To Do Type - Algorithms

The **To Do Algorithms** page defines the algorithms that should be executed for a given To Do type.

To maintain this information, select **Admin > To Do Type > Search** and navigate to the **Algorithms** page.

## Description of Page

The grid contains **Algorithms** that control important To Do functions. If you haven't already done so, you must [set up the appropriate algorithms](#) in your system. You must define the following for each algorithm:

- Specify the **System Event** with which the algorithm is associated (see the table that follows for a description of all possible events).
- Specify the **Sequence Number** and **Algorithm** for each system event. You can set the **Sequence Number** to 10 unless you have a **System Event** that has multiple **Algorithms**. In this case, you need to tell the system the **Sequence** in which they should execute.

The following table describes each **System Event**.

System Event	Optional / Required	Description
Calculate Priority	Optional	<p>Algorithms of this type may be used to calculate a To Do entry's priority. Refer to <a href="#">The Priority of a To Do Entry</a> for more information on when this plug-in is called.</p> <p>Note that it is not the responsibility of the algorithms to actually update the To Do entry with the calculated priority value but rather only return the calculated value. The system carries out the update as necessary.</p> <p>If more than one algorithm is plugged-in the system calls them one by one until the first to return a calculated priority.</p> <p>Click <a href="#">here</a> to see the algorithm types available for this system event.</p>
External Routing	Optional	<p>Algorithms of this type may be used to route a To Do entry to an external system.</p> <p>The base package <a href="#">F1-TDEER</a> background process invokes the algorithms for every To Do entry that its type references the process as the <b>Routing Process</b> and that the entry was not already routed. The background process marks an entry as routed by updating it with the batch control's current run number.</p> <p>If more than one algorithm is plugged-in the batch process calls them one by one until the first to indicate the To Do entry was routed.</p> <p>Click <a href="#">here</a> to see the algorithm types available for this system event.</p>
To Do Information	Optional	<p>We use the term "To Do information" to describe the basic information that appears throughout the system to describe a To Do entry. The data that appears in "To Do information" is constructed using this algorithm.</p> <p>Plug an algorithm into this spot to override the "To Do information" algorithm on installation options or the system default "To Do information" if no such algorithm is defined on installation options.</p> <p>Click <a href="#">here</a> to see the algorithm types available for this system event.</p>
To Do Monitor	Optional	<p>Algorithms of this type are executed by the To Do Monitor background process and may be used to periodically review a To Do entry and perform actions, if needed. Refer to <a href="#">Monitoring a To Do Entry</a> for more information.</p> <p>Click <a href="#">here</a> to see the algorithm types available for this system event.</p>



System Event	Optional / Required	Description
To Do Post-Processing	Optional	Algorithms of this type may be used to validate and/or further process a To Do entry that has been added or updated.  Click <a href="#">here</a> to see the algorithm types available for this system event.

## List of System To Do Types

The To Do types available to use with the product are found in the To Do Type page. In addition, they may be viewed in the [application viewer's To Do type](#) viewer. If your implementation adds To Do types, you may [regenerate](#) the application viewer to see your additions reflected there.

## Implementing The To Do Entries

To enable the To Do entries visible in the To Do Type page and application viewer, you must configure the system as follows:

- Define the To Do roles associated with each To Do type and link the appropriate users to them. Once you have defined the roles appropriate for your organization's To Do types, remove the reference to this system default role **F1\_DFLT**. Refer to [To Do Entries Reference A Role](#) for more information.
- For any To Do Type that is provided for a specific background process, the To Do simply needs to reference the appropriate Creation Background Process. When the background process is scheduled, To Dos are created based on the logic of the related background process. This applies to [To Dos Created for Object-Specific Error Conditions](#) and [Dedicated To Do Background Processes](#).
- For any To Do Type that is provided for creation by an algorithm or other process, there may be configuration required to populate that To Do type as an algorithm parameter or as an attribute on a control table.

---

**NOTE:** Refer to the description of the To Do type for more information.

---

## Background Processes

This chapter covers various topics related to background processes. Besides providing an overview of background process functionality, the various tools available within the application to define, submit and monitor background processes are covered.

---

**NOTE:** Your specific source application may have additional background process topics. Please refer to the documentation section that applies to your source application for more information.

---

## Understanding Background Processes

This section describes various topics related to the background processes that perform many important functions throughout your product such as:

- Processing To Do Entries
- Monitor processes that select records in a given state to progress them to their next state in their lifecycle
- Processes that purge data
- Processes that extract data

- And many more...

## Background Processing Overview

While the system relies on a scheduler to secure and execute its background processes, there are additional issues that you should be familiar with:

- Batch control records are used for the following purposes:
  - Define the code that executes the logic associated with the background process.
  - For processes that extract information, the batch control record defines the next batch number to be assigned to new records that are eligible for extraction. For example, the batch control record associated with the process that routes To Do entries to an external system defines the next batch number to be assigned to new To Do entries that are configured with this batch control. When this To Do external routing process next runs, it selects all To Do entries marked with the current batch number (and increments the next batch number).
  - The batch control record for each background process organizes audit information about the historical execution of the background process. The system uses this information to control the restart of failed processes. You can use this information to view error messages associated with failed runs.
  - Many processes have been designed to run in parallel in order to speed execution. For example, the process that applies updates for a migration data set import for CMA can be executed so that multiple "threads" are processing a different subset of records (and multiple threads can execute at the same time). Batch control records associated with this type of process organize audit information about each thread in every execution. The system uses this information to control the restart of failed threads. Refer to [Parallel Background Processes](#) for more information.
  - Some processes define extra parameters. These parameters are defined with the batch control. Default values may also be captured for each parameter. They will be used when the [background process is submitted on-line](#).

The following diagram illustrates the relationships that exist for batch control records.

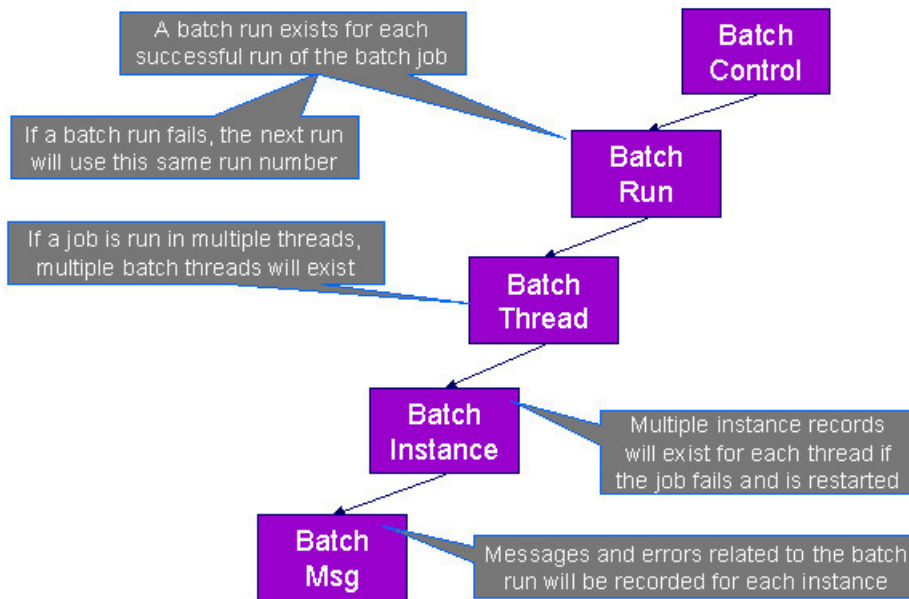

Results of each batch run can be viewed using the [Batch Run Tree](#) page.

Refer to [Batch Scheduler Integration](#) for information about the integration with the Oracle Scheduler.

## Parallel Background Processes

Many processes have been designed to run in parallel in order to speed execution. This is referred to as running the process with multiple “threads”.

The system provides two strategies for distributing the data to the multiple threads.

- **Thread Level SQL Select.** This strategy is sometimes referred to as the “thread iterator” strategy. In this strategy, the batch job uses the primary key to figure out how to evenly distribute key ranges to each thread. Each thread is then responsible for selecting the records. In this strategy, the threads should also re-select the data periodically to release the cursor, which aids in performance. Note that this strategy is preferred but may only be used under the following conditions:

- The data from only one maintenance object is being processed.
- The primary key for the maintenance object is a single, numeric system generated key.

---

**NOTE:** Parameters may be used to override the low and high id. Refer to [Parameters Supplied to Background Processes](#) for more information.

---

- **Job Level SQL Select.** This strategy is sometimes referred to as the “standard commit” strategy. In this strategy, the keys for the records to be processed by the batch job are all selected first and stored in a temporary table. The batch job then supplies each thread with a range of keys that it should process. This strategy is used if multiple maintenance objects are being processed by the batch job; if the primary key of the maintenance object has multiple parts or if the primary key is non-numeric.

The multi-threading logic relies on the fact that primary keys for master and transaction data are typically system generated random keys. In addition, if the data is partitioned, it is expected to be partitioned based on the primary key.

---

**NOTE:** The detailed description in the metadata for each batch control provided with the system should indicate if it may be run in parallel. Note that the strategy used is not typically indicated in the detailed description.

---

**NOTE: Overriding the thread ranges.** Your implementation has the ability to override the thread ranges if certain data in your system takes longer to process. For example, imagine you have a single account in Oracle Utilities Customer Care and Billing that has thousands of service agreements (maybe the account for a large corporation or a major city). You may want to set up the thread ranges to put this large account into its own thread and distribute the other accounts to the other threads. To do this, you should create the appropriate batch thread records ahead of time in a status of **Thread Ready ( 50)** with the key ranges pre-populated. Note that the base product does not provide the ability to add batch thread records online. If you are interested in more information about this technique, contact Customer Support.

---

## Optimal Thread Count

Running a background process in multiple threads is almost always faster than running it in a single thread. The trick is determining the number of threads that is optimal for each process.

---

**NOTE:** A good rule of thumb is to have one thread for every 100 MHz of application server CPU available. For example if you have four 450 MHz processors available on your application server, you can start with 18 threads to begin your testing:  $(450 * 4) / 100 = 18$ .

---

This is a rule of thumb because each process is different and is dependent on the data in your database. Also, your hardware configuration (i.e., number of processors, speed of your disk drives, speed of the network between the database server and the application server) has an impact on the optimal number of threads. Please follow these guidelines to determine the optimal number of threads for each background process:

- Execute the background process using the number of threads dictated by the rule of thumb (described above). During this execution, monitor the utilization percentage of your application server, database server and network traffic.
- If you find that your database server has hit 100% utilization, but your application server hasn't one of the following is probably occurring:
  - There may be a problematic SQL statement executing during the process. You must capture a database trace to identify the problem SQL.
  - It is also possible that your commit frequency may be too large. Commit frequency is a parameter supplied to every background process. If it is too large, the database's hold queues can start swapping. Refer to [Parameters Supplied to Background Processes](#) for more information about this parameter.
- It is normal if you find that your application server has hit 100% utilization but your database server has not. This is normal because, in general, all processes are CPU bound and not IO bound. At this point, you should decrease the number of threads until just under 100% of the application server utilization is achieved. And this will be the optimal number of threads required for this background process.
- If you find that your application server has not hit 100% utilization, you should increase the number of threads until you achieve just under 100% utilization on the application server. And remember, the application server should achieve 100% utilization before the database server reaches 100% utilization. If this proves not to be true, something is probably wrong with an SQL statement and you must capture an SQL trace to determine the culprit.

Another way to achieve similar results is to start out with a small number of threads and increase the number of threads until you have maximized throughput. The definition of "throughput" may differ for each process but can be generalized as a simple count of the records processed in the batch run tree. For example, in the Billing background process in Oracle Utilities Customer Care and Billing, throughput is the number of bills processed per minute. If you opt to use this method, we recommend you graph a curve of throughput vs. number of threads. The graph should display a curve that is steep at first but then flattens as more threads are added. Eventually adding more threads will cause the throughput to decline. Through this type of analysis you can determine the optimum number of threads to execute for any given process.

## Parameters Supplied To Background Processes

This section describes the various types of parameters that are supplied to background processes.

### General Parameters

The following information is passed to every background process.

- **Batch code.** Batch code is the unique identifier of the background process.
- **Batch thread number.** Thread number is only used for background processes that can be run in multiple parallel threads. It contains the relative thread number of the process. For example, if the billing process has been set up to run in 20 parallel threads, each of the 20 instances receives its relative thread number (1 through 20). Refer to [Optimal Thread Count for Parallel Background Processes](#) for more information.
- **Batch thread count.** Thread count is only used for background processes that can be run in multiple parallel threads. It contains the total number of parallel threads that have been scheduled. For example, if the billing process has been set up to run in 20 parallel threads, each of the 20 instances receives a thread count of 20. Refer to [Optimal Thread Count for Parallel Background Processes](#) for more information.
- **Batch rerun number.** Rerun number is only used for background processes that download information that belongs to given run number. It should only be supplied if you need to download an historical run (rather than the latest run).
- **Batch business date.** Business date is only used for background processes that use the current date in their processing. For example, a billing process may use the business date to determine which bill cycles should be downloaded. If this parameter is left blank, the system date is used. If supplied, this date must be in the format YYYY-MM-DD. Note: this parameter is only used during QA to test how processes behave over time.
- **Override maximum records between commits.** This parameter is optional and overrides each background process's Standard Commit. You would reduce this value, for example, if you were submitting a job during the day and you

wanted more frequent commits to release held resources. You might want to increase this value when a background process is executed at night (or weekends) and you have a lot of memory on your servers.

- **Override maximum minutes between cursor re-initiation.** This parameter is optional and overrides each background process's Standard Cursor Re-Initiation Minutes. You would reduce these values, for example, if you were submitting a job during the day and you wanted more frequent commits to release held resources (or more frequent cursor initiations). You might want to increase these values when a background process is executed at night (or weekends) and you have a lot of memory on your servers.
- **User ID.** Please be aware of the following in respect of user ID:
  - Both the user submitting the job and the user ID recorded on the batch submission should have access to the application service for the batch control that secures execution.
  - Any batch process that stamps a user ID on a record it creates or updates uses this user ID in applicable processing.
  - This user ID's [display profile](#) controls how dates and currency values are formatted in messages.
- **Password.** Password is not currently used.
- **Language Code.** Language code is used to access language-specific control table values. For example, error messages are presented in this language code.
- **Trace program at start (Y/N), trace program exit (Y/N), trace SQL (Y/N) and output trace (Y/N).** These switches are only used during QA and benchmarking. If trace program start is set to Y, a message is displayed whenever a program is started. If trace program at exist is set to Y, a message is displayed whenever a program is exited. If trace SQL is set to Y, a message is displayed whenever an SQL statement is executed. If output trace is set to Y, special messages formatted by the background process are written.

---

**NOTE:** The information displayed when the output trace switch is turned on depends on each background process. It is possible that a background process displays no special information for this switch.

---

## Common Additional Parameters

Each batch control supports the definition of additional parameters. There are some additional parameters that are common to all batch processes or common to a specific type of batch process. The batch control should be delivered with the appropriate additional parameters. However, when new additional parameters are introduced, existing batch controls may not be updated with the new additional parameter.

The following table highlights the common parameters that may be linked to a batch control. Note that for batch parameters, although there is a sequence number that controls the displayed order of the parameter, the batch process does not use the sequence to identify a particular parameter but rather uses the parameter name. In some cases multiple parameter names are supported (a 'camel case' version and an 'all caps' version).

Parameter Name	Description	Additional Comments
<b>MAX-ERRORS / maxErrors</b>	Each of the batch processes has, as part of its run parameters, a preset constant that determines how many errors that batch process may encounter before it is required to abort the run. A user can override that constant using this parameter.	The input value must be an integer that is greater than or equal to zero. The maximum valid value for this parameter is 999,999,999,999,999.
<b>DIST-THD-POOL</b>	Each batch process executes in a thread pool. This parameter is only necessary if the batch process should execute in a different thread pool than the default thread pool.	The default thread pool name is <b>DEFAULT</b> .
<b>emailMode</b>	When the batch job is submitted with an associated email address, the default logic is to send an email when the job completes	Valid Values <ul style="list-style-type: none"> <li>• <b>ERROR</b> — send an email only when the job ends in Error status.</li> </ul>

Parameter Name	Description	Additional Comments
	regardless of success or failure. Use this parameter to limit the email based on the status of the job when it ends.	<ul style="list-style-type: none"> <li>• <b>SUCCESS</b> — send an email only when the job ends in successfully.</li> <li>• <b>ALL</b> — always send an email only when the job ends. (This is the default.)</li> </ul>
<p>The following parameters are only applicable to jobs that use the <b>Thread Level SQL Select</b> method of distributing work to threads as described in <a href="#">Parallel Background Processes</a>.</p>		
<b>overrideLowIdValue</b>	Specifies a new low id to use in calculating the range for a thread. The framework by default assumes that the Id is between 0's (e.g. 000000000) and 9's (e.g. 999999999), but this parameter will override the low value.	The parameter value can be an actual number or it can be set to <b>auto</b> . If <b>auto</b> is configured, it is set to the lowest current value on the database table associated with the background process.
<b>overrideHighIdValue</b>	Specifies a new high id to use in calculating the range for a thread. The framework by default assumes that the Id is between 0's (e.g. 000000000) and 9's (e.g. 999999999), but this parameter will override the high value.	The parameter value can be an actual number or it can be set to <b>auto</b> . If <b>auto</b> is configured, it is set to the highest current value on the database table associated with the background process.
<b>idRangeOverrideClass</b>	Use this parameter to specify a custom class to do thread range calculation. During batch execution, this override class is instantiated and the setter methods called to initialize the Ids as required. The low and high getter methods are called to retrieve the high and low ids to be used for the run.	The class name specified must implement interface <code>com.splwg.base.api.batch.BatchIdRangeOverride</code> .

The following parameters are only applicable to jobs that perform a single commit, for example for extract batch jobs.

<b>numRecordsToFlush</b>	This parameter defines how frequently to flush the Hibernate cache to prevent high heap consumption and Out Of Memory Errors.
--------------------------	---

## Specific Batch Parameters

Some background processes define additional parameters that are specific to their functionality. When a process receives additional parameters, they are defined and documented in the batch control entry in the application. They are also visible in the [batch control](#) viewer (part of the [application viewer](#)).

## Indicating a File Path

Some of the system background processes use extra parameters to indicate a File Path and/or File Name for an input file or an output file. For example, most extract processes use File Path and File Name parameter to indicate where to place the output file.

When supplying a FILE-PATH variable, the directory specified in the FILE-PATH must already exist and must grant write access to the administrator account for the product. You may need to verify a proper location with your systems administrator.

The syntax of the FILE-PATH depends on the platform used for the product application server. Contact your system administrator for verification. For example, if the platform is UNIX, use forward slashes and be sure to put a trailing slash, for example `/spltemp/filepath/`.

## Processing Errors

When a background process detects an error, the error may or may not be related to a specific object that is being processed. For example, if the program finds an error during batch parameter validation, this error is not object-specific. However, if the program finds an error while processing a specific bill, this error is object-specific. The system reports errors in one of the following ways:

- Errors that are not object-specific are written to the error message log in the [Batch Run Tree](#).
- Some batch processes create entries in an "exception table" for certain object-specific errors. For example, an error detected in the creation of a bill in Oracle Utilities Customer Care and Billing may be written to the bill exception table. If an error is written to an exception table, it does not appear in the batch run tree. For each exception table, there is an associated to do entry process that creates a To Do Entry for each error to allow a user to correct the problem on-line.
- For some background processes, errors that do not result in the creation of an exception record may instead generate a To Do entry directly. For these processes, if you wish the system to directly create a To Do entry, you must configure the To Do type appropriately. Refer to [To Do entry for object-specific errors](#) for information about configuring the To Do type. If the background process detects an object specific error and you have configured the system to create a To Do entry, the error is not written to the batch run tree. If you have configured your To Do type to not create To Do entries for certain errors, these errors are written to the [batch run tree](#).

---

**NOTE: Some processes create exceptions and To Do entries.** It is possible for a background process to create entries in an exception table and create To Do entries directly, depending on the error. Consider batch billing in Oracle Utilities Customer Care and Billing; any conditions that cause a bill or bill segment to be created in **error** status result in a record added to the bill exception table or the bill segment exception table. However, any object-specific error that is not related to a specific bill or bill segment or any error that prevents a bill or bill segment from being created may result in a To Do entry for the object-specific error.

---

## Error Post-Processing Logic

The product supports executing one or more algorithms when a batch process encounters an error that causes execution to stop. This allows for some special processing to occur to handle the failure of the batch job. Algorithms for this plug-in spot receive the batch control, batch run number, batch processing business date, number of threads and the list of the ad hoc parameters of the batch job. The following are some examples of functionality that may be executed when a batch job fails:

- Another object or record that is monitoring the batch job may have its status updated to reflect the batch status.
- An outbound message service may be invoked to perform a task related to the failure.

Note that the units of work for all threads are committed prior to executing the error post-processing logic.

## Post-Processing Logic

The product supports executing one or more algorithms after all the threads of a given batch job have completed. This allows for some special processing to occur at the end of a batch job. Algorithms for this plug-in spot receive the batch control, batch run number, batch processing business date, number of threads and the list of the ad hoc parameters of the batch job. The following are some examples of functionality that may be executed at the end of a batch job:

- Another dependent batch job can be kicked off. Note that this use case is only needed when the multiple dependent jobs are not part of a scheduler (which can also detect the successful end of one batch job so as to submit the next job).
- Statistics for the batch run may be analyzed and based on results, a To Do Entry may be sent to an administrator.
- If the current batch job is processing a large number of child records in multiple threads, a parent record could be updated to a different status or with some other audit information.



Note that the units of work for all threads are committed prior to executing the post-processing logic. The algorithm should perform standard error handling. If an error occurs in one of the post-processing algorithms, the overall batch job's status is set to Error so that it can be re-submitted to retry the logic in the finalize step.

## Timed Batch Processes

Most batch jobs are submitted via a batch scheduler. In the absence of a scheduler, a batch control may be configured as “timed” triggering the framework to monitor and schedule these batch jobs as defined by the timer interval. The timer interval defines the desired interval between starts (in seconds). The system schedules new batch runs at each interval if the last instance of the job has completed.

When configuring a batch control as “timed”, other default information must be provided, including the User ID and Language to use for submitting the job and the email address for notification, if desired.

Timed batch controls also include an Active setting, allowing for an implementation to temporarily stop further executions of the batch job (but retain the other timer settings).

Timed jobs are controlled by the default threadpool and not by a scheduler. When the **DEFAULT** threadpoolworker starts it will start executing any job for a Batch Control configured as **Timed** with the Timer Active set to **Yes**. This is whether the batch daemon or batch server is enabled or not.

## Monitor Background Processes

In many areas of the system, functionality is driven from business object configuration as a BO driven record progresses through its lifecycle. Refer to [Business Object Lifecycle](#) for details. As part of that functionality, it is possible that a background process, called a [monitor batch process](#), is used to execute functionality for the record. A single program is provided for the BO monitor functionality and parameters are used to limit the records processed by maintenance object and other optional parameters that may further limit the records. The product typically provides at least one monitor batch control for each maintenance object that supports a configurable lifecycle on its business object.

This topic highlights the parameters supported by the monitor batch job. Not all parameters are applicable to all maintenance objects and therefore may not be configured on a give base monitor batch control.

Parameter Name	Description	Comments
<b>maintenanceObject</b>	Maintenance Object	For most base delivered batch controls, this parameter is delivered already populated with the value of the maintenance object value. Note that it is supported to leave this value blank, at which point, the program will determine the maintenance object (objects) to process by looking for an MO that refers to this batch control record as an option.
<b>isRestrictedByBatchCode</b>	Restrict by Batch Code	Set this to <b>true</b> to indicate whether the process should only select records that explicitly refer to this batch control on its current BO state. This is also referred to as “deferred” mode. If set to <b>false</b> , the program includes all records that refer to the current batch control in its BO state and records that don't refer to any batch control in its current state (but monitor algorithms exist in the current state). This is commonly referred to as “periodic” mode. Note that if the value is not set at all, the program will determine whether to run it as “deferred” or “periodic” based on whether the batch code is configured on the MO option as a <b>State Monitor Process</b> (“deferred”) or a <b>Periodic Monitor Process</b> .
<b>restrictToType</b>	Restrict by Related Type	This parameter is only applicable to maintenance objects that have a related 'type' object and the maintenance object has



Parameter Name	Description	Comments
		configured an option indicating the field for the related type column. This parameter may be used to limit the processing to records that are in the indicated type.
<b>restrictToBusinessObject</b>	Restrict by Business Object	This parameter may be used to limit the processing to records that are in the indicated business object.
<b>restrictToBOStatus</b>	Restrict by Status	This parameter may be used to limit the processing to records that are in the indicated status.
<b>restrictToDate</b>	Restrict By Date	Enter a valid date on the record's primary table to limit processing to records that are have a value in this field that is on or before the batch business date. Optionally, enter "+" or "-" followed by a number to shift the comparison date to the batch business date plus or minus the given number. For example, entering REVIEW_DT -3 will retrieve all records whose review date is on or before the batch business date minus 3 days.
<b>sampleRecordNumber</b>	Sample Record Number	This is not a commonly used parameter. It is only applicable when the monitor is used for a business use case that supports processing a subset of the records during a testing phase. For example, if the process is validating a large number of records, it may be an option to only validate every 100 records to determine if there are repeated validation errors that may indicate a common problem that may be solved to fix many errors.

Also note that when submitting a monitor process with multiple [parallel threads](#), the program will use a **Thread Level SQL Select** strategy unless any of the following are true (in which case it will use the **Job Level SQL Select** strategy):

- The input maintenance object is left blank and the program finds more than one maintenance object that refers to this batch control in its options.
- A single MO is applicable but it has a multi-part primary key.
- A single MO is applicable and it has a single primary key, but it is a user defined key instead of a system generated key.
- The sample record number parameter is populated.

## Plug-in Driven Background Processes

Although the product is delivered with a rich library of background processes, implementations may have business requirements that require new processes to be introduced. It is possible for an implementation to write a background process from scratch using a base process as a template. However, the product also provides base background processes that call algorithms to do the work that is needed. These are called plug-in driven background processes. There are two major types of plug-in driven batch processes:

- Processes that act on records that are stored in the database in the system. These types of processes require SQL to select the records along with the logic to process the records.
- Processes that import data from a file and store new records in the system as a result. These types of processes require an algorithm that is able to map the data from the file to appropriate new records in the system

The subsequent sections provide more detail about the two types of plug-in driven background processes.

## Processing System Records

Processes that retrieve records in the system and do some action on them require an algorithm to select the records to be processed and another algorithm to process the records. The base processes implement standard background process functionality including parallel background process logic and the ability to create To Do entries for errors. This allows for an implementation to take advantage of the pre-built support and provide plug-ins that include the logic that is unique to the specific use case.

The system provides the following processes that support plug-ins for selecting and processing the records:

- **Ad-hoc Process.** This background process is provided for implementations that have some custom business logic that needs to be performed on a group of records. The base batch control Plug-in Driven Generic Template ([F1-PDBG](#)) may be used as a template.
- **Extract Process.** This background process is provided for implementations that have extract files to produce for integration with external systems. The process includes parameters to configure the file path and file name for the created file along with other parameters to control how the file is formatted. The base batch control Plug-in Driven Extract Template ([F1-PDBEX](#)) may be used as a template.

The following sections provide more information about implementing this type of functionality.

### Select Records Algorithm

The first important algorithm to design when implementing a plug-in driven batch process is the Select Records algorithm, plugged in on the [batch control](#) page. This algorithm type must define the first parameter as the SQL. The batch job will directly access the SQL parameter value in the metadata (rather than invoking the algorithm). All other parameters are available for the algorithm to use for its own logic.

In addition, when invoking the algorithm, it must return the strategy to use (**Thread Level SQL Select** or **Job Level SQL Select**). Refer to [parallel background processes](#) for more information about the two strategies and when to use each. When choosing the **Thread Level SQL Select** strategy, the algorithm should return the name of the primary key in the Key Field parameter. In addition, the SQL should include a **BETWEEN** clause that includes the bind variables for the low and high ID for the ranges. See below for the bind variable syntax.

If the SQL statement includes variables that are determined at execution time, it must use bind parameters. Bind parameters are referenced in the SQL statement using a colon and a parameter name (for example **:parameter**). There are some variables provided by the system that are populated by the batch job at execution time. These have **f1\_** as its prefix.

The system supports the following pre-defined bind parameters:

- **:f1\_lowID** and **:f1\_highID** - these should be used in the **BETWEEN** clause for the **Thread Level SQL Select** strategy. The batch job will substitute the appropriate ID range as required.
- **:f1\_batchCode** and **:f1\_batchNumber** - these are common attributes of the batch control that are referenced on a record for selection purposes. Note that the batch run number is set according to whether the batch job is a re-run of a previous run or not.
- **:f1\_businessDate** - the batch job will populate the input batch business date, if populated otherwise the current date.

---

**NOTE:** The system supports both "f1." and "f1\_" as a prefix for the bind variables. However, the "f1." prefix will result in an error if the SQL security property setting is turned on. As such, the underscore syntax is recommended. The period syntax remains for backwards compatibility.

---

For any other custom parameters, the Select Records algorithm may return one or more sets of field name / variable name / value where the variable name matches a bind variable in the SQL. The field name provides information about data type and length that assists the SQL binding logic to properly substitute the values. Note that the variable name cannot start with **f1.** as its prefix. The batch job will use the value returned by the algorithm to set the bind parameter in the SQL statement.

The plug-in spot receives a list of the ad hoc parameters for the batch job as name / value pairs. If the list includes parameters whose values are to be used in selecting records, your algorithm may be used to identify the relevant batch parameter passed as input and populate the field name and output bind variable appropriately.

The product provides a base algorithm type for this plug-in spot that simply defines a parameter for the SQL. It also includes parameters for the strategy and the key field name. This algorithm type may be used by any custom batch process where the SQL does not rely on any special bind variables that must be determined. Simply create an algorithm for the algorithm type and provide the appropriate SQL. Refer to the algorithm type [Select Records by Predefined Query \(F1-PDB-SR\)](#) for more information.

## Process Records Algorithm

The other important algorithm to design when implementing a plug-in driven batch process is the Process Record algorithm, plugged in on the [batch control](#) page. This algorithm is called for each record selected for the process. It receives all the information that was selected from the Select Records plug-in.

For the ad-hoc processing batch process, algorithms plugged into this spot are responsible for doing the work for each record based on the desired logic.

For the extract batch process, algorithms plugged into this spot are responsible for returning the data that should be written to the file in one or more XML instances along with the schema name(s) that describes the XML instance(s). For XML output format, the batch process will write the XML instance data as returned by the plug-in. For fixed position or CSV output format, the batch process will convert the XML instance data to the appropriate format and add it to the file.

Also note that algorithms for this plug-in spot will be passed two Booleans, `isFirst` and `isLast`, to indicate if the current work unit is the first and/or last for that thread. This allows for the plug-in to do additional work if needed. Note that the `isFirst` indication is available for both types of batch processes, ad-hoc and extract. However, the `isLast` indication is only applicable for the file extract batch. For the ad-hoc batch process this value will always be set to **false**. Extracts will always execute in a single database transaction. In a single transaction run, any error causes the run to be aborted so that it restarts from the beginning when resubmitted. This is done to avoid partial files being written along with inaccurate setting of the `isLast` element.

The product provides a base algorithm type for this plug-in spot that illustrates the technique to follow when implementing an extract type of plug-in driven background process. Refer to the algorithm type [General Process - Sample Process Record Extract \(F1-GENPROCEX\)](#) for more information.

## Configuring a New Process

The following points summarize the steps needed to implement a new background process that act on records in the system using plug-ins for the specific functionality:

- Verify the SQL that the background process should execute. Keep in mind that all the data selected in the SQL is available to pass to the plug-in that processes the records. If the performance of the background process is important, be sure to consult with a DBA when designing the SQL.
  - If the SQL does not require any custom variables to substitute at runtime, create an algorithm for the base algorithm type [F1-PDB-SR](#) and configure the SQL. In addition, configure the strategy and the primary key name (for the **Thread Level SQL Select** strategy).
  - If the SQL requires custom variables, a new [plug-in script](#) must be designed and coded to populate the variable names and values using the algorithm entity **Batch Control - Select Records**. Besides defining the variables, the algorithm must also indicate the strategy and the primary key name (for the **Thread Level SQL Select** strategy). Define the algorithm type for the newly created script. The first parameter of the algorithm type must be the SQL as illustrated in the base algorithm type. Note that the other parameters are available for use by this algorithm type if needed. Define the algorithm, populating the SQL as appropriate (using the custom variables).
- Design the logic required for each record and create a [plug-in script](#) where the algorithm entity is **Batch Control - Process Record**. Note that the plug-in receives all the information selected in the SQL defined in the Select Records plug-in

- For an ad-hoc process, the algorithm should perform whatever process is required based on the business use case. Note that the background process is responsible for committing the records.
- For an extract process, the algorithm is responsible for returning one or more schema instances populated with information that should be written to the file. If an existing schema satisfies the output requirements, it may be used. Otherwise, define a data area to indicate the output format of the records as appropriate.

In either case, define the algorithm type and algorithm for the newly created script.

- Create a batch control by duplicating the appropriate base template as per the type of background process needed. Plug in the algorithms created above and configure the parameters as appropriate. Note that you may configure custom ad hoc parameters on the batch control if required. Both base and custom batch parameter values are available to the Select Records and Process Records plug in algorithms.

## Uploading Records

The base product provides a background process to upload data from a file. The batch control Plug-in Driven File Upload Template ([F1-PDUPL](#)) may be used as a template. The process includes parameters to configure the file path and file name for file to upload along with other parameters to control how to handle missing files and how to rename the file once processed. Refer to the description of the batch control and its parameters for more information.

This background process requires an algorithm plugged into the plug-in spot **File Upload**. This plug-in is called once for a given file. The batch process opens the file and passes to the algorithm the file reader element. The algorithm associated with the batch control is responsible for using provided APIs to read the content of the file and store the data in appropriate table(s) (for example, an appropriate staging table). The base provided process supports uploading multiple files and may be run mutli-threaded to process multiple files. Each file is processed by one call to the File Upload algorithm and supports a single commit for the records uploaded in a given file.

---

**NOTE:** Plug-in scripts written to implement this type of algorithm must use the Groovy script engine version as the APIs are not accessible using the XPath scripting language. Refer to [Additional Coding Options For Server Scripts](#) for more information.

---

Note that this step in the upload of data is only one part of a typical upload end-to-end process. This step is sometimes referred to in the product as "Process X". The goal of this step is to get records from a file into database records, with minimal validation and processing. The data should be stored in records that are then processed by a second step (often referred to in the product as the "upload" step, for example "Payment Upload"). The second step, independent of the plug-in driven batch process described here, is responsible for validating the data and should be able to be threaded by individual records and have proper error handling for individual records. Note that depending on the type of data being uploaded, the product may already supply appropriate tables that the plug-in driven upload process may populate. These could be staging tables, such as payment upload staging. Or they may be records with business objects that have a lifecycle designed to handle uploaded data, for example Business Flag. In such cases, the product will typically supply out-of-the-box background processes to validate and further process the data and finalize the upload. If the data to upload does not already have a base provided staging table, be sure to work with your implementation team to identify an appropriate table to use for the plug-in driven batch upload. In addition, confirm the design for the second step that is responsible for the detailed validation and finalization of the data.

The product supplies sample algorithms to illustrate calling the supplied APIs for processing different types of source data: comma delimited, fixed position and XML. In every case, the sample data supported by the upload uses 'degree day' information to illustrate the process. The system provides sample target records (based on the Fact maintenance object) in order to illustrate the step to store records based on the input data. Note that only sample plug-in scripts have been provided. No algorithm, algorithm type or batch control is configured to use the sample plug-in scripts. To view the scripts, navigate to the [Script](#) page, search for a Script Type of **Plug-in Script** and Algorithm Entity of **Batch Control - File Upload** and look for the 'Sample' scripts.

Note that the sample plug-in scripts provided by the product are supplied to illustrate use of the provided APIs. They should not be considered a template for how to implement a plug-in script for a real use case. The following highlight some points to consider when designing a file upload algorithm:

- **Error handling / resolution.** The sample plug-in scripts do some basic error handling related to the data to illustrate error handling. However, any errors found in this step require processing of the whole file to stop. As such, this plug-in should only report errors that are not possible to fix, but where the whole file should be rejected. If there are errors that can be adjusted in the data, then the recommendation is to not check for those errors at this step. Rather, this plug-in should simply populate the appropriate staging tables and let the next step check for validity. As described above, the next step should include the ability to mark individual records in error, allowing for users to fix the data and retry.
- **Target tables.** The sample plug-in scripts use Fact as the target for the resulting insert statements. As mentioned above, the decision of where to store the uploaded data must be carefully considered. There may already be existing tables that are specific to a given use case. If the data being uploaded does not have existing tables to use, review the product to verify what existing tables may be useful, such as Inbound Sync Request or Service Task. Be sure that the tables chosen support error handling, either out-of-the box or via designing an appropriate business object with a lifecycle that supports an error status and the ability to resolve the error. Also note that the Sample Flat File Upload plug-in illustrates a header record / detail record scenario. In this case, the header record is linked to the child record via a CLOB element. This is not the recommended technique. In a real use case, the header record should be linked to the child record via a separate database column to allow for searching.

## Configuring a New Process

The following points summarize the steps needed to implement a new file upload background process:

- Verify the details of the data in the upload file and map the data to fields in one or more appropriate tables in the system.
- Design the logic required for reading the record details and identifying each record to properly create the insert statements for storing the data. The sample plug-in scripts provided by the product illustrate using the various APIs available for use. Create a [plug-in script](#) where the algorithm entity is **Batch Control - File Upload**. Create an appropriate algorithm type and algorithm for this plug-in script.
- Create a batch control by duplicating the base template. Plug in the algorithm created above and configure the parameters as appropriate. Note that you may configure custom ad hoc parameters on the batch control if required. Both base and custom batch parameter values are available to the File Upload algorithm.

## How to Re-extract Information

If you need to recreate the records associated with an historical execution of an extract process, you can - simply supply the desired batch number when you request the batch process.

## How to Submit Batch Jobs

Most batch jobs are submitted via a batch scheduler. Refer to [Batch Scheduler Integration](#) for information about the integration with the Oracle Scheduler.

Batch jobs may be configured as **Timed**, which means they will automatically be run based on the timer frequency.

In addition, you can manually submit your adhoc background processes or submit a special run for one of your scheduled background processes using the online [batch job submission](#) page.

## How to Track Batch Jobs

You can track batch jobs using the batch process pages, which show the execution status of batch processes. For a specified batch control id and run id, the tree shows each thread, the run-instances of each thread, and any messages (informational, warnings, and errors) that might have occurred during the run.

---

**FASTPATH:** For more information, refer to [Tracking Batch Processes](#).

---

## How to Restart Failed Jobs and Processes

Every process in the system can be easily restarted if it fails (after fixing the cause of the failure). All you have to do is resubmit the failed job; the system handles the restart.

## Assessing Level of Service

For some background processes, an implementation may wish to supply one or more algorithms that check some conditions to assess whether or not the process is performing as expected. An algorithm could be used to check the performance of the job to see if it is running as efficiently as expected. Or it could analyze the data processed by the background process to assess whether there may be some problem with the quality of the data.

The system provides a Level of Service plug-in spot on [batch control](#) to configure the appropriate algorithms for a given background process, if desired. Each algorithm is expected to return a value to indicate the 'level of service' determined along with a message indicating the reason for the value. The following Level of Service values are supported:

- **Normal.** Indicates that the algorithm did not detect any issues.
- **Warning.** Indicates that the algorithm found some issues that may or may not indicate a problem.
- **Error.** Indicates that the algorithm found some issues that should be investigated.
- **Disabled.** Indicates that the algorithm could not properly execute the level of service logic.

When viewing a [batch control](#) record, if there are any level of service algorithms configured, the logic is executed and the results are displayed. The level of service is also part of the [Health Check](#) service.

## System Background Processes

---

**NOTE: List of system background processes.** The list of background processes provided in the base product may be viewed in the [application viewer's batch control](#) viewer. In addition if your implementation adds batch control records, you may [regenerate](#) the application viewer to see your additions reflected there.

---

## Defining Batch Controls

The system is delivered with all necessary batch controls. Implementations may define default values for parameters. In addition, implementations may define their own background processes.

To view background processes, open **Admin > System > Batch Control**. Refer to [Background Processing Concepts](#) for more information.

---

**CAUTION:** Important! If you introduce a new batch process, carefully consider its naming convention. Refer to [System Data Naming Convention](#) for more information.

---

### Description of Page

Enter an easily recognizable **Batch Process** and **Description** for each batch process.

**Owner** indicates if this batch control is owned by the base package or by your implementation (**Customer Modification**). The system sets the owner to **Customer Modification** when you add a batch control. This information is display-only.

Use the **Detailed Description** to describe the functionality of the batch process in detail.

Enter the **Application Service** that is used to provide security for submission requests for the batch control. The application service must have an Access Mode of **Execute**. Refer to [Granting Access To Batch Submission](#) for more information.



Use **Batch Control Type** to define the batch process as either **Timed** or **Not Timed**. A [Timed batch process](#) will be automatically initialized on a regular basis. A Not Timed process needs to be run manually or through a scheduler.

Use **Batch Control Category** to categorize the process for documentation purposes. The base values provided are as follows:

- **Ad Hoc.** Processes of this type are run on an ad hoc basis, only when needed. For example, if there is a process to do a mass cancel / correction of data, it would only be run when a situation occurs requiring this.
- **Extract.** Extract processes extract information that is interfaced out of the system. Processes of this type typically extract records marked with a given run number. If the requester of the process does not supply a specific run number, the system assumes that the latest run number should be extracted. If you need to re-extract an historical batch, you simply supply the respective run number when you request the batch process.
- **ILM. Information Lifecycle Management** jobs are crawler background processes that are associated with the ILM based storage solution.
- **Monitor.** Processes of this type are processes related to business objects with a lifecycle state that defines [monitor algorithms](#). The monitor process selects records in a given state and executes its algorithms, which may cause the record to transition to another state or may trigger some other logic to occur. Using configuration, the monitor process may target only specific records. Refer to [Monitoring Batch Processes](#) for more information. Note that these types of background processes can be considered a subset of **Process What's Ready**
- **Process What's Ready.** Processes of this type create and update records that are “ready” for processing. The definition of “ready” differs for every process. For example, a payment upload process creates payments for every record that is **pending**. An overdue event monitor activates pending overdue events that have reached their trigger date.
- **Purge.** Processes of this type are used to purge historical records from certain objects that generate a large number of entries and may become unwieldy over time.
- **To Do Entry.** Processes of this type are used to detect a given situation and create or complete a To Do Entry. Refer to [To Do Entries Created by Background Processes](#) for more information.
- The following categories are related to the data conversion / migration processes, which are not applicable to all products:
  - **Conversion.** Processes of this type are dedicated to converting or migrating data from external applications into the product.
  - **Object Validation.** Processes of this type are dedicated to validate data within objects for conversion or migration purposes.
  - **Referential Integrity.** Processes of this type are dedicated to validate referential integrity within objects for conversion or migration purposes.

---

**NOTE:** Additional categories may be introduced by your specific product.

---

If the batch process is Timed, then the following fields are available:

- **Timer Interval** is the number of seconds between batch process submissions. The system will start the next run this many seconds from the start time of the previous run.
- **User ID** is the ID under which the batch process will run.
- **Email Address** is the Email address to be used for notification if the batch process fails.
- **Timer Active** allows you to temporarily switch off the timer while retaining the other settings for the timed job.
- **Batch Language** is the language associated with the batch process.

Use **Program Type** to define if the batch process program is written in **Java** or **Java (Converted)**, meaning that the program has been converted into Java.

---

**NOTE:** **Java (Converted)** program types are not applicable to all products.

---

Use **Program Name** to define the Java class / program associated with your batch process:

---

**NOTE: View the source.** If the program is shipped with the base package, you can use the adjacent button to display the source code of this program in the [Java docs viewer](#).

---

**Level of Service** shows the output of the [level of service](#) algorithms for the batch control. If one algorithm is plugged into the Batch Control, the level of service lookup value along with a message indicating the reason for the output value is shown. If multiple algorithms are plugged in, the text **See Results for Details** is displayed. There is an icon provided to expand the details returned by each algorithm. If no level of service algorithm is found, then the value **Disabled** is shown with a message indicating that no algorithm is provided for this batch control.

The **Last Update Timestamp**, **Last Update Instance** and **Next Batch Nbr** are used for audit purposes.

Turn on **Accumulate All Instances** to control how this batch control is displayed in the [Batch Run Tree](#). If checked, the run statistics (i.e., "Records Processed" and "Records in Error") for a thread are to be accumulated from all the instances of the thread. This would include the original thread instance, as well as any restarted instances. If this is not turned on, only the ending (last) thread instance's statistics are used as the thread's statistics. This may be preferred for certain types of batch processes where the accumulation would create inaccurate thread statistics, such as those that process flat files and, therefore, always start at the beginning, even in the case of a restart.

The following fields are default values that are used when a batch job is submitted for the batch control:

- Use **Thread Count** to control whether a background process is run single threaded or in multiple parallel threads. This value defines the total number of threads that have been scheduled.
- Select **Trace Program Start** if you want a message to be written whenever a program is started.
- Select **Trace SQL** if you want a message to be written whenever an SQL statement is executed.
- Use **Override Nbr Records to Commit** to define the default number of records to commit. This is used as the default value for timed jobs as well as online submission of jobs that are not timed.
- Select **Trace Program Exit** if you want a message to be written whenever a program is exited.
- Select **Trace Output** if you want a message to be displayed for special information logged by the background process.

For more information about these fields, see [Batch Job Submission - Main](#)

The parameter collection is used to define additional parameters required for a particular background process. The following fields should be defined for each parameter:

**Sequence.** Defines the relative position of the parameter.

**Parameter Name.** The name of the parameter as defined by the background process program.

**Description.** A description of the parameter.

**Detailed Description.** A more detailed description of the parameter.

**Required.** Indicates whether or not this is a required parameter.

**Parameter Value.** The default value, if applicable. Note that an implementation may define a default value for base provided batch controls.

**Security.** Indicates whether the system should **Encrypt** the parameter value or not. A value of **Encrypt** means that the parameter value is stored in the database and written to the log files using encryption. In addition, the parameter is written to the log files with asterisks. The setting applies to values entered here as well as in the online [Batch Submission](#). If there is no need to secure the parameter value, use the default setting of **None**.

**Owner** Indicates if this batch process is owned by the base package or by your implementation (Customer Modification). The system sets the owner to **Customer Modification** when you add a batch process. This information is display-only.



## Batch Control - Algorithms

Use this page to maintain a batch control's algorithms. Open this page using **Admin > System > Batch Control** and then navigate to the **Algorithms** tab.

### Description of Page

The **Algorithms** grid contains algorithms that control important functions for instances of this batch control. You must define the following for each algorithm:

- Specify the **System Event** with which the algorithm is associated (see the table that follows for a description of all possible events).
- Specify the **Sequence Number** and **Algorithm** for each system event. You can set the **Sequence Number** to 10 unless you have a **System Event** that has multiple **Algorithms**. In this case, you need to tell the system the **Sequence** in which they should execute.
- **Owner** indicates if this is owned by the base package or by your implementation (**Customer Modification**).

The following table describes the **System Events**.

System Event	Optional / Required	Description
Error Post-Processing	Optional	Algorithms of this type are called if the batch process fails to complete due to an error. Multiple algorithms are allowed and are executed in sequence order. Refer to <a href="#">Error Post-Processing Logic</a> for more information.  Click <a href="#">here</a> to see the algorithm types available for this system event.
File Upload	Optional	Algorithms of this type are only applicable to <a href="#">plug-in driven background processes</a> and are used to upload all records for a file. Note that only one algorithm is allowed.  Click <a href="#">here</a> to see the algorithm types available for this system event.
Level of Service	Optional	Algorithms of this type are called to determine the Level of Service provided by a batch control. Multiple algorithms are allowed. Refer to <a href="#">Assessing Level of Service</a> for more information.  Click <a href="#">here</a> to see the algorithm types available for this system event.
Post-Processing	Optional	Algorithms of this type are called after all threads are complete. Multiple algorithms are allowed and are executed in sequence order. Refer to <a href="#">Post-Processing Logic</a> for more information.  Click <a href="#">here</a> to see the algorithm types available for this system event.
Process Record	Optional	Algorithms of this type are only applicable to <a href="#">plug-in driven background processes</a> and are used to process a specific record.  Click <a href="#">here</a> to see the algorithm types available for this system event.
Select Records	Optional	Algorithms of this type are only applicable to <a href="#">plug-in driven background processes</a> and are used to define the SQL to use to select the records to process. Only one algorithm is allowed.  Click <a href="#">here</a> to see the algorithm types available for this system event.

---

**NOTE:** You can add new system events. Your implementation may want to add additional batch control oriented system events. To do that, add your new values to the customizable lookup field **F1\_BATCH\_CTRL\_SEVT\_FLG**.

---

## On-Line Batch Submission

The on-line [batch submission](#) page enables you to request a specific background process to be run. When submitting a background process on-line, you may override standard system parameters and you may be required to supply additional parameters for your specific background process. After submitting your background process, you may use this page to review the status of the submission.

The following topics further describe logic available for on-line submission of background processes.

## Batch Submission Creates a Batch Run

When you request a batch job to be submitted from on-line, the execution of the desired background process will result in the creation of a batch run. Just as with background processes executed through your scheduler, you may use the [Batch Run Tree](#) page to view the status of the run, the status of each thread, the run-instances of each thread, and any messages that might have occurred during the run.

---

**NOTE:** Your on-line submission record is assigned a status value so that you may know whether your job has been submitted and whether or not it has ended, however, it will not contain any information about the results of the background process itself. You must navigate to the [Batch Run Tree](#) page to view this detail.

---

## Jobs Submitted in the Background

When you save a record on the batch job submission page, the batch job does not get submitted automatically. Rather, it saves a record in the batch job table. A special background process will periodically check this table for pending records and will execute the batch job. This background process will update the status of the batch job submission record so that a user can determine when their job is complete.

---

**NOTE:** At installation time, your system administrator will set up this special background process to periodically check for pending records in the batch job submission table. Your administrator will define how often the system will look for pending records in this table.

---

It should be noted that this special background process only submits one pending batch job submission record at a time. It submits a job and waits for it to end before submitting the next pending job.

---

**NOTE:** If you request a batch job to be run multi-threaded, the special background process will submit the job as requested. It will wait for all threads to complete before marking the batch job submission record as **ended**. Refer to [Running Multi-threaded Processes](#) for more information.

---

## Email Notification

If you wish the system to inform you when the background process completes, you may supply your email address. The email you receive will contain details related to the batch job's output; similar to the job results you would see from your batch scheduler.

---

**NOTE:** This assumes that during the installation process, your system administrator configured the system to enable email notification. Your administrator may also override the amount of detail included in the email notification.

---

## Running Multi-Threaded Processes

Many of the system background processes may be run multi-threaded. When submitting a background process on-line, you may also run a multi-threaded process or run a single thread of a multi-threaded process. The fields Thread Count and Thread Number on the [batch submission](#) page control the multi-threaded process requests:

- To run a multi-threaded process, indicate the number of threads in **Thread Count** and enter **0** in the **Thread Number**.
- To run a single thread in a multi-threaded process, indicate the number of threads in Thread Count and indicate the Thread Number you would like to run.
- To run a process as a single thread, enter Thread Count = **1** and Thread Number = **1**. This will execute the background process single-threaded.

---

**NOTE:** When running a multi-threaded process, the special background process will wait until all threads are complete before marking the batch job submission record as **Ended**.

---

## Batch Jobs May End in Error

It is possible for your background process to end with an error. When this occurs, your batch job submission record will still be marked as **Ended**. You will need to navigate to the [Batch Run Tree](#) page to determine the status of the batch run.

## Submitting Jobs in the Future

If you wish to request a batch job to be submitted in the future, you may do so when creating your batch job submission record by entering a future submission date. The special background process, which looks for pending records in the batch job submission table, will only submit batch jobs that do not have a future submission date.

## Lifecycle of a Batch Job Submission

The following diagram illustrates the lifecycle of a batch job submission record.

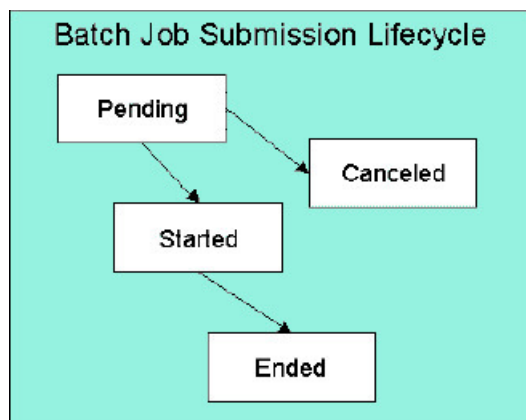

**Pending** — Records are created in **Pending** status. Records in this state are put in a queue to be submitted.

**Canceled**— Users may cancel a pending record to prevent the batch job from being submitted.

**Started**— Once a pending record has been submitted for processing, its status will be changed to **Started**. Records in this status may not be canceled.

**Ended**— When the batch job has finished processing, its status will be changed to **Ended**. Note that records in **Ended** status may have ended in error. Refer to [Batch Jobs May End in Error](#) for more information.

## Granting Access To Batch Submission

Every batch control must reference an [application service](#). When you link a batch control to an application service, you are granting all users in the group the ability to submit the associated batch job for execution.

---

**FASTPATH:** Refer to [The Big Picture Of Application Security](#) for information about granting users access rights to an application service.

---

When the batch control is added to the batch job table, the system checks if both the user submitting the job and the user ID recorded on the batch submission record have access rights. Application security does not apply when viewing a batch control or an associated batch run.

---

**NOTE:** Base batch controls will be associated with base owned application services by default. Implementations will need to ensure the appropriate user groups are linked to these application services.

---

## Batch Job Submission - Main

This page allows you to submit a batch job on-line. Navigate to this page using **Menu > Tools > Batch Job Submission**.

### Description of Page

The **Batch Job ID** is a system generated random number that identifies a particular submission.

To submit a batch job, choose the **Batch Code** for the process you wish to submit.

---

**NOTE: List of system background processes.** The list of background processes provided in the base product may be viewed in the [application viewer's batch control](#) viewer.

---

The following parameters are provided with each background process:

**Thread Number** is used to control whether a background processes is run single threaded or in multiple parallel threads. It contains the relative thread number of the process. For example, if the process has been set up to run in 20 parallel threads, each of the 20 instances receives its relative thread number (1 through 20). Refer to [Running Multi-threaded Processes](#) for more information about populating this field.

---

**NOTE:** Not all processes may be run multi-threaded. Refer to the description of a batch control to find out if it runs multi-threaded.

---

**Thread Count** is used to control whether a background processes is run single threaded or in multiple parallel threads. It contains the total number of threads that have been scheduled. For example, if the process has been set up to run in 20 parallel threads, each of the 20 instances receives a thread count of 20. Refer to [Running Multi-threaded Processes](#) for more information about populating this field.

**Batch Rerun Number** is only used for background processes that download information that belongs to given run number. It should only be supplied if you need to download an historical run (rather than the latest run).

**Batch Business Date** is only used for background processes that use a date in their processing. In Oracle Utilities Customer Care and Billing, for example, a billing process can use the business date to determine which bill cycles should be downloaded. If this parameter is left blank, the system date is used at the time the background process is executed.

---

**NOTE:** Saving a record on this page does not submit the batch job immediately. A special background process will run periodically to find pending records and submit them. Depending on how often the special process checks for pending records and depending on how many other pending records are in the 'queue', there may be a slight lag in submission

time. If the desired execution date/time is close to midnight, it is possible that your batch job will run on the day after you submit it. If you have left the business date blank in this case, keep in mind that your business date would be set to the day after you submit the job.

---

**Override Nbr Records To Commit** and **Override Max Timeout Minutes**. These parameters are optional and override each background process's Standard Commit Records and Standard Cursor Re-Initiation Minutes. (Each background process's Standard Commit Records / Standard Cursor Re-Initiation Minutes should be documented in the detailed description of the batch control record). Note that Max Timeout Minutes corresponds to the Cursor Re-initiation Minutes.

---

**FASTPATH:** Refer to [Parameters Supplied to Background Processes](#) for more information.

---

**User ID** is the user ID associated with the run of the background process. Refer to [Parameters Supplied to Background Processes](#) for more information about the significance of the user id.

---

**NOTE:** This field defaults to the id of the current user.

---

**Password** is not currently used.

**Language Code** is used to access language-specific control table values. For example, error messages are presented in this language code.

If you wish the system to notify you when the batch job is complete, enter your **Email ID**. Refer to [Email Notification](#) for more information.

---

**NOTE:** This field defaults to the email address for the current user, if populated on the [user](#) record.

---

The **Desired Execution Date/Time** defaults to the current date and time. Override this information if you wish the background process to be executed at some future date and time. Refer to [Submitting Jobs in the Future](#) for more information.

The **Batch Job Status** indicates the current status of the batch job. Refer to [Lifecycle of a Batch Job Submission](#) for more information.

The **Program Name** associated with the batch control code is displayed.

The following trace parameters may also be supplied to a background process and are only used during QA and benchmarking.

- **Trace Program Start** Turn on this switch if you wish a message to be written whenever a program is started.
  - **Trace Program Exit** Turn on this switch if you wish a message to be written whenever a program is exited.
  - **Trace SQL** Turn on this switch if you wish a message to be written whenever an SQL statement is executed.
  - **Trace Output** Turn on this switch if you wish a message to be displayed for special information logged by the background process.
- 

**NOTE:** The information displayed when the trace output switch is turned on depends on each background process. It is possible that a background process displays no special information for this switch.

---

**NOTE:** The location of the output of this trace information is defined by your system administrator at installation time.

---

If additional parameters have been defined for this background process on the Batch Control page, the **Parameter Name**, **Description**, **Detailed Description** and an indicator of whether or not the parameter is **Required** are displayed.

If a default parameter value is configured on the batch control configuration, that value is shown and may be overridden. Confirm or enter the appropriate **Parameter Value** for each parameter. Note that if the parameter value is configured to be Encrypted on the batch control configuration, the value here will be shown encrypted.

Once you have entered all the desired values, **Save** the record in order to include it in the queue for background processes.

---

If you wish to duplicate an existing batch job submission record, including all its parameter settings, display the submission record you wish to duplicate and use the **Duplicate and Queue** button. This will create a new Batch Job Submission entry in pending status. The new submission entry will be displayed.

If you wish to cancel a **Pending** batch job submission record use the **Cancel** button. The button is disabled for all other status values.

## Tracking Batch Processes

The batch process pages show the execution status of batch processes. For a specified batch control id and run id, the tree shows each thread, the run-instances of each thread, and any messages (informational, warnings, and errors) that might have occurred during the run. Refer to [Defining Batch Controls](#) for more information on how batch control codes are defined.

### Batch Run Tree - Main

This page allows you to view the status of a specific execution of a batch job. Navigate to this page using **Menu > Tools > Batch Run Tree**.

#### Description of Page

Select a **Batch Control** process and **Batch Number** to view information and statistics on the batch run's "threads". The following points should help understand this concept:

- Many batch jobs cannot take advantage of your hardware's processing power when they are run singularly. Rather, you'll find that a large percentage of the CPU and/or disk drives are idle.
- In order to minimize the amount of idle time (and increase the throughput of your batch processes), we allow you to set up your batch processes so that multiple instances of a given batch job are executed at the same time. For example, in Oracle Utilities Customer Care and Billing when you schedule the **billing** process, you can indicate that multiple parallel instances should be executed (rather than just one instance). You'd do this so that the processing burden of creating bills for your customers can be spread over multiple processes.
- We refer to each parallel execution of a batch process as a "thread".
- Statistics and information messages are displayed in respect of each thread. Why? Because each thread is a separate execution and therefore can start and end at different times.

The **Start Date/Time** and **End Date/Time** of the batch run are shown.

The tree includes a node that displays the total number of records processed for the batch run, the total number of records in error for the batch run and the batch run elapsed time. The elapsed time is the longest elapsed time among the batch thread(s). The message is red if there are any records in error.

If the background process has been enabled to create [To Do entries for object specific errors](#), information about the To Do entries are displayed in the tree. This information is not displayed for each thread, but rather all the To Do entries created for the batch run are grouped together. The To Do entries are grouped by their status.

If the application properties file has been configured with the location of the log files and the log files associated with the batch thread are still available, the links **Download stdout** and (if applicable) **Download stderr** are visible. Clicking either link allows you to view or save the log files.

---

**NOTE: Compression.** The log files are compressed and include a \*.gz extension. Different browsers treat this type of file differently. Some browsers may automatically decompress the file as part of the download and they are viewable in any text viewer by changing the extension to one the text viewer recognizes. However, some browsers download the compressed file and a user will need to unzip the file prior to viewing.

---

---

**NOTE: Security Access.** The 'download' hyperlinks are only visible for users that have security access to the **Download** access mode for the batch run tree application service.

---

The messages that appear under a thread always show the start and end times of the execution instance. If errors are detected during the execution of the thread, these error messages may also appear in the tree. Refer to [Processing Errors](#) for information about the types of errors that appear in the batch run tree.

## Batch Run Tree - Run Control

By default, if a batch process fails, it will restart. This tab allows you to modify the restart status of a failed run.

Navigate to this page using **Menu > Tools > Batch Run Tree** search for the desired batch control and then navigate to the **Run Control** page.

### Description of Page

On the main page, you must select a **Batch Control**, **Batch Number**, and **Batch Rerun Number** to view a tree of the batch run. On this page, the following information is displayed:

- **Last Update Timestamp** contains the date and time the most recent batch run started or completed.
- **Batch Business Date** is the business date that was supplied to the background process (this date is used as the "system date" by the process).

**Run Status** indicates the status of the batch run. Valid values are: **In Progress**, **Error**, and **Complete**.

If the **Run Status** is **Error**, the system will attempt to restart this run when you attempt to execute the **Batch Control**. In most situations, this is exactly what you want to happen. However, there are rare situations where you do not want the system to execute a given batch run (e.g., if this run is somehow corrupt and you cannot correct the data for whatever reasons). If you want the system to skip the execution of a batch run (and proceed to the next run), turn on **Do Not Attempt Restart**.

## Service Health Check

The system provides a service that returns an overall assessment of the system's health. The overall response is expressed using an HTTP code. The codes supported by the service are defined in the lookup **HEALTH\_RESPONSE\_FLG** and are as follows:

- A value of 500 (One or More Critical Functions Degraded) is returned if there is any critical issue detected by the service.
- A value of 203 (Non-Critical Function Degraded) is returned if no critical issues are found and there is at least one non-critical issue detected by the service.
- Otherwise a value of 200 (All Checks Successful) is returned.

This health check service is accessible through the business service **F1-HealthCheck**. Also note that the system provides an [Inbound Web Service](#) for this business service (also called **F1-HealthCheck**) allowing external systems to use a web service to retrieve this information.

In addition, the product provides a portal that allows a user to view the detailed results of the health check service.

Navigate using **Admin > System > Health Check** to view this portal.

The zone on the portal displays the following:

**Overall Response** is the HTTP response code returned by the business service as described above.

The grid displays the detail of each individual component checked as part of the system health check. See below for more detail about what components are checked.



- **Health Component** indicate the type of health check performed. Currently the system supports **Batch Level of Service** component type.
- **Health Component Details** provides information about the individual entity checked. The information displayed here depends on the type of health component. If supported by the type of component, the column may be hypertext, allowing the user to drill into the entity itself.
- **Status** displays the status returned by the health component check for this individual entity. The information displayed here depends on the type of health component.
- **Status Reason** provides more detail about why the individual entity is in the indicated status. The information displayed here depends on the type of health component.
- **Response** shows the health check response code assigned to this individual entity's health check response. It is mapped based on the status returned by the health component check.

## Health Component Type Details

The details returned by the business service for this portal depends on the health component type. The system supports the **Batch Level of Service** health component type.

This health component type finds all the batch controls that are configured with at least one [level of service](#) algorithm and invokes the algorithms for each batch control. The business service populates the output for this health service for each batch control as follows:

- The **Health Component Detail** is populated with the Batch Control code and description. In addition, the navigation information for being able to drill into the batch control are provided and used to build the column as hypertext.
- The **Status** is populated based on whether the batch control has one algorithm or multiple. If there is one algorithm, the description of the Level of Service lookup value returned by the algorithm is displayed. If there are multiple, the system determines an overall status based on the detailed status values from each algorithm. If any algorithm returns Error, that value is displayed. Otherwise, if any return a Warning, that value is displayed. Otherwise Normal is displayed.
- The **Status Reason** is populated based on whether the batch control has one algorithm or multiple. If there is one algorithm, the expanded text of the status reason returned by the algorithm is displayed. If there are multiple, the text **See Results for Details** is displayed. There is an icon provided to expand the details returned by each algorithm.
- The **Response** is populated based on the value of the overall Level of Service status. It is set to **All Checks Successful** (200) when the Level of Service is **Normal** or **Disabled; Non-Critical Function Degraded** (203) when the Level of Service is **Warning** and **One or More Critical Functions Degraded** (500) when the Level of Service is **Error**.

## The Big Picture of Requests

Requests enable an implementer to design an ad-hoc batch process using the configuration tools.

An example of such a process might be to send an email to a group of users that summarizes the To Do entries that are assigned to them. This is just one example. The request enables many types of diverse processing.

## Request Type Defines Parameters

For each type of process that your implementation wants, you must configure a request type to capture the appropriate parameters needed by the process.

## Previewing and Submitting a Request

To submit a new request, go to **Menu > Tools > Request** in add mode. You must select the appropriate request type and then enter the desired parameter values, if applicable.



After entering the parameters, the following actions are possible:

- Click **Save** to submit the request.
- Click **Cancel** to cancel the request.
- Click **Preview** to see a sample of records that satisfy the selection criteria for this request. This information is displayed in a separate map. In addition, the map displays the total number of records that will be processed when the request is submitted. From this map you can click **Save** to submit the request, **Back** to adjust the parameters, or **Cancel** to cancel the request.

When a request is saved, the job is not immediately submitted for real time processing. The record is saved with the status **Pending** and a monitor process for this record's business object is responsible for transitioning the record to **Complete**.

As long as the record is still **Pending**, it may be edited to adjust the parameters. The preview logic described above may be repeated when editing a record.

The actual work of the request, such as generating an email, is performed when transitioning to **Complete** (using an enter processing algorithm for the business object).

## To Do Summary Email

The base product includes a sample request process that sends an email to users that have incomplete To Dos older than a specified number of days.

The following configuration tasks are required to use this process:

- Define an Outbound Message Type. The business object usually defined for the Outbound Message Type is **F1-EmailMessage**.
- Define an External System that contains the Outbound Message Type in one of its steps. In the configuration determine if the communication is through SOA, batch, or real-time processing method when sending the email notification. Refer to [Outbound Messages](#) for more information about configuration needed for the different processing methods.
- Create a Request Type that includes the Outbound Message Type and the corresponding External System.
- Create a Request for the created Request Type.

## Exploring Request Data Relationships

Use the following links to open the application viewer where you can explore the physical tables and data relationships behind the request functionality:

- Click [F1-REQ-TYPE](#) to view the request type maintenance object's tables.
- Click [F1-REQ](#) to view the request maintenance object's tables.

## Defining a New Request

To design a new ad-hoc batch job that users can submit via Request, first create a new Request Type business object. The base product BO for request type, **F1-TodoSumEmailTyp**, may be used as a sample.

The business object for the request includes the functionality for selecting the records to process, displaying a preview map for the user to review, and for performing the actual processing. The base product BO for request, **F1-TodoSumEmailReq**, may be used as a sample. The following points highlight the important configuration details for this business object:

- Special BO options are available for request BOs to support the Preview Request functionality.
  - **Request Preview Service Script**. This script retrieves the information that is displayed when a user asks for a preview of a request.

- **Request Preview Map.** This map displays the preview of a request.
- The enter algorithm plugged into the Complete state is responsible for selecting the records that satisfy the criteria and processing the records accordingly.

## Setting Up Request Types

Use the Request Type portal to define the parameters to capture when submitting a request. Open this page using **Admin > General > Request Type**.

This topic describes the base-package zones that appear on the Request Type portal.

**Request Type List.** The Request Type List zone lists every request type. The following functions are available:

- Click a **broadcast** icon to open other zones that contain more information about the request type.
- Click **Add** in the zone's title bar to add a new request type.

**Request Type.** The Request Type zone contains display-only information about a request type. This zone appears when a request type has been broadcast from the Request Type List zone or if this portal is opened via a drill down from another page. The following functions are available:

- Click **Edit** to start a business process that updates the request type.
- Click **Delete** to start a business process that deletes the request type.
- Click **Deactivate** start a business process that deactivates the request type.
- Click **Duplicate** to start a business process that duplicates the request type.
- State transition buttons are available to transition the request type to an appropriate next state.

Please see the zone's help text for information about this zone's fields.

## Maintaining Requests

Use the Request transaction to view and maintain pending or historic requests.

Open this page using **Menu > Tools > Request > Search**. This topic describes the base-package portals and zones on this page.

**Request Query.** Use the query portal to search for an existing request. Once a request is selected, you are brought to the maintenance portal to view and maintain the selected record.

**Request Portal.** This portal appears when a request has been selected from the Request Query portal. The following base-package zones appear on this portal:

- **Actions.** This is a standard actions zone.
- **Request.** The Request zone contains display-only information about a request. Please see the zone's help text for information about this zone's fields.
- **Request Log.** This is a standard log zone.

## Defining Algorithms

In this section, we describe how to set up the user-defined algorithms that perform many important functions including:

- Validating the format of a phone number entered by a user.
- Validating the format of a latitude/longitude geographic code entered by a user.
- In products that support payment and billing:

- Calculating late payment charges.
- Calculating the recommended deposit amount.
- Constructing your GL account during the interface of financial transactions to your GL
- And many other functions...

## The Big Picture Of Algorithms

Many functions in the system are performed using a user-defined algorithm. For example, when a CSR requests a customer's recommended deposit amount, the system calls the deposit recommendation algorithm. This algorithm calculates the recommended deposit amount and returns it to the caller.

---

**NOTE: Algorithm = Plug-in.** We use the terms plug-in and algorithm interchangeably throughout this documentation.

---

So how does the system know which algorithm to call? When you set up the system's control tables, you define which algorithm to use for each component-driven function. You do this on the control table that governs each respective function. For example:

- You define the algorithm used to validate a phone number on your phone types.
- You define the algorithm in Oracle Utilities Customer Care and Billing used to calculate late payment charges on each Service Agreement Type that has late payment charges.
- The list goes on...

The topics in this section provide background information about a variety of algorithm issues.

## Algorithm Type Versus Algorithm

You have to differentiate between the type of algorithm and the algorithm itself.

- An **Algorithm Type** defines the program that is called when an algorithm of this type is executed. It also defines the types of parameters that must be supplied to algorithms of this type.
- An **Algorithm** references an **Algorithm Type**. It also defines the value of each parameter. It is the algorithm that is referenced on the various control tables.

---

**FASTPATH:** Refer to [How to Add A New Algorithm](#) for an example that will further clarify the difference between an algorithm and an algorithm type.

---

## How To Add A New Algorithm

Before you can add a new algorithm, you must determine if you can use one of the sample algorithm types supplied with the system. Refer to [List of Algorithm Types](#) for a complete list of algorithm types.

If you can use one of the sample algorithm types, simply add the algorithm and then reference it on the respective control table. Refer to [Setting Up Algorithms](#) for how to do this.

If you have to add a new algorithm type, you may have to involve a programmer. Let's use an example to help clarify what you can do versus what a programmer must do. Assume that you require an additional geographic type validation algorithm. To create your own algorithm type you must:

- Write a new program to validate geographic type in the appropriate manner. Alternatively, you may configure a plug-in script to implement the validation rules. The advantage of the latter is that it does not require programming. Refer to [plug-in script](#) for more information.

- Create an Algorithm Type called **Our Geographic Format** (or something appropriate). On this algorithm type, you'd define the name of the program (or the plug-in script) that performs the function. You'd also define the various parameters required by this type of algorithm.
- After creating the new Algorithm Type, you can reference it on an Algorithm.
- And finally, you'd reference the new Algorithm on the Geographic Type that requires this validation.

## Minimizing The Impact Of Future Upgrades

The system has been designed to use algorithms so an implementation can introduce their own logic in a way that's 100% upgradeable (without the need to retrofit logic). The following points describe strong recommendations about how to construct new algorithm type programs so that you won't have to make program changes during future upgrades:

- Do not alter an algorithm type's hard parameters. For example, you might be tempted to redefine or initialize parameters defined in an algorithm type's linkage section. Do not do this.
- Follow the naming conventions for the new algorithm type code and your source code, i.e., both the source code and the algorithm type should be prefixed with "CM". The reason for this naming convention is to make it impossible for a new, base-package algorithm type from overwriting your source code or algorithm type meta-data (we will never develop a program or introduce meta-data beginning with CM).
- Avoid using embedded SQL to perform insert/update/delete. Rather, invoke the base-package's object routines or common routines.
- Avoid using base messages (outside of common messages, i.e., those with a message number < 1000) as we may deprecate or change these messages in future releases. The most common problem is caused when an implementation clones a base package algorithm type program because they need to change a few lines of logic. Technically, to be 100% upgradeable, you should add new messages in the "90000" or greater category (i.e., the category reserved for implementation-specific messages) for every message in your new program even though these messages may be duplicates of those in the base package.

## Setting Up Algorithm Types

The system provides many algorithm types to support base product functionality. If you need to introduce a new type of algorithm, open **Admin > System > Algorithm Type**.

---

**FASTPATH:** Refer to [The Big Picture Of Algorithms](#) for more information.

---

**CAUTION:** Important! If you introduce a new algorithm type, carefully consider its naming convention. Refer to [System Data Naming Convention](#) for more information.

---

### Description of Page

Enter an easily recognizable **Algorithm Type** and **Description**.

**Owner** indicates if this algorithm type is owned by the base package or by your implementation (**Customer Modification**). The system sets the owner to **Customer Modification** when you add an algorithm type. This information is display-only.

Enter a **Detailed Description** that describes, in detail, what algorithms of this type do.

Use **Algorithm Entity** to define where algorithms of this type can be "plugged in". If a detailed description about an algorithm entity is available, a small help icon is visible adjacent to the dropdown. Click the icon to view the information.

---

**NOTE:** The values for this field are customizable using the [lookup](#) table. This field name is **ALG\_ENTITY\_FLG**.

---

Use **Program Type** to define if the algorithm's program is written using **Java**, a **Plug-In Script**, or **Java (Converted)**, meaning the program has been converted to Java.

---

**NOTE: Java (Converted)** program types are not applicable to all products.

---

Use **Program Name** to define the program to be invoked when algorithms of this type are executed:

- If the Program Type is **Java (Converted)**, enter the name of the converted program.
- If the Program Type is **Java**, enter the Java class name.
- If the Program Type is **Plug-In Script**, enter the plug-in [script](#) name. Only plug-in scripts defined for the algorithm entity may be used.

---

**NOTE: View the source.** If the program is shipped with the base package, you can use the adjacent button to display the source code of this program in the [Java docs viewer](#). For plug-in scripts, drill into the plug-in script to view the details.

---

Use the **Parameter Types** grid to define the types of parameters that algorithms of this type use. The following fields should be defined for each parameter:

- Use **Sequence** to define the relative position of the **Parameter**.
- Use **Parameter** to describe the verbiage that appears adjacent to the parameter on the Algorithm page.
- Indicate whether the parameter is **Required**. This indicator is used when parameters are defined on algorithms that reference this algorithm type.
- **Owner** indicates if the parameter for this algorithm type is owned by the base package or by your implementation (**Customer Modification**). The system sets the owner to **Customer Modification** when you add an algorithm type with parameters. This information is display-only.

---

**NOTE:** When adding a new algorithm type that is for a Java program, the parameters are automatically generated based on the Java code. Once an algorithm type exists, any additional parameters defined in the Java code should be manually added to the algorithm type. For other program types, algorithm type parameters must be manually defined.

---

---

**NOTE:** When a new algorithm type parameter is added for any program type, existing algorithms for the algorithm type do not automatically get updated with the new parameter. The algorithms must be manually updated.

---

## Where Used

An Algorithm references an Algorithm Type. Refer to [Setting Up Algorithms](#) for more information.

## List of Algorithm Types

The algorithm types available to use with the product may be viewed in the algorithm type page and in the [application viewer's algorithm](#) viewer. If your implementation adds algorithm types or adds algorithms to reference existing algorithm types, you may [regenerate](#) the application viewer to see your additions reflected there.

## Setting Up Algorithms

If you need to introduce a new algorithm, open **Admin > System > Algorithm**. Refer to [The Big Picture Of Algorithms](#) for more information.

### Description of Page

Enter an easily recognizable **Algorithm Code** and **Description** of the algorithm. **Owner** indicates if this algorithm is owned by the base package or by your implementation (**Customer Modification**).

---

**CAUTION:** Important! If you introduce a new algorithm, carefully consider its naming convention. Refer to [System Data Naming Convention](#) for more information.

---

Reference the **Algorithm Type** associated with this algorithm.

---

**FASTPATH:** Refer to [Algorithm Type Versus Algorithm](#) for more information about how an algorithm type controls the type of parameters associated with an algorithm.

---

The parameters available for an algorithm are defined on the algorithm type. The system allows a set of parameter values to change over time. Use the parameter scroll to view parameter values for a given **Effective Date**. The **Owner** of the collection of parameters is displayed. The collection shows the **Parameter** description, the **Sequence** and the **Value** for each parameter.

---

**NOTE:** If the product delivers an algorithm with parameter values defined, an implementation may override the base provided parameter values by adding an additional effective dated collection of parameters.

---

---

**NOTE:** If an algorithm is defined and subsequently a new parameter is added to the algorithm type, existing algorithms for the algorithm type should be updated as follows: Click the “+” to add a new effective dated entry to the parameter collection. At this point the latest list of parameters for the algorithm type are visible. Configure the parameters accordingly.

---

### Where Used

Algorithms are plugged in on control tables throughout the system. Each algorithm type’s Algorithm Entity indicates the name of the control table where it is plugged in. The [algorithm](#) viewer in the application viewer may also be used to see a list of plug-in spots along with their algorithm types and algorithms.

## Defining Script Options

We use the term "script" to define processing rules that your implementation sets up to control both front-end and back-end processing:

- Rules that control front-end processing are defined using [Business Process Assistant](#) (BPA) scripts. For example, your implementation could set up a BPA script to guide a user through your organization's payment cancellation process.
- Rules that control back-end processing are defined using [Server-based](#) scripts. For example, your implementation could set up a server-based script to control the processing that executes whenever a given type of adjustment is canceled.

The topics in this section describe how to configure your scripts.

## The Big Picture Of Scripts

This section describes features and functions that are shared by both BPA scripts and server-based scripts.

### Scripts Are Business Process-Oriented

To create a script, you must analyze the steps used to implement a given business process. For example, you could create a "stop auto pay" BPA script that:

- Asks the user to select the customer / taxpayer using an appropriate search page
- Asks the user to define the date on which the person would like to stop making automatic payments
- Invokes a server-based script that populates the end-date on the account's latest automatic payment instructions.

After you understand the business process, you can set up a script to mimic these steps. If the business process is straightforward (e.g., users always perform the same steps), the script configuration will be straightforward. If the business process has several logic branches, the composition of the script may be more challenging.

## A Script Is Composed Of Steps

A script contains one or more steps. For example, a "stop auto pay" BPA script might have three steps:

- Ask the user to select the customer / taxpayer using an appropriate search page
- Ask the customer the date on which they'd like to stop making automatic payments (and default the current date)
- Invoke a server-based script that, in turn, updates the account's auto pay options.

Each step references a step type. The step type controls what happens when a step executes. It might be helpful to think of a script as a macro and each step as a "line of code" in the macro. Each step's step type controls the function that is executed when the step is performed.

---

**FASTPATH:** Refer to [How To Set Up Each Step Type](#) for a detailed description of all available step types and how to set them up.

---

## A Script May Declare Data Areas

Both BPA and server-based scripts may have one or more [data areas](#):

- If the script contains steps that exchange XML documents, you must declare a data area for each type of XML document. For example, if a BPA script has a step that invokes a service script, the BPA script must declare a data area that holds the XML document that is used to pass information to and from the service script.
- You can use a data area as a more definitive way to declare your temporary storage. For example, you can describe your script's temporary storage variables using a [stand-alone data area](#) schema and associate it with your script.

Various step types involve referencing the script's data areas as well as support the ability to compare and move data to and from field elements residing in the data areas.

An [Edit Data](#) step supports the syntax to dynamically declare data areas as part of the step itself. This technique eliminates the need to statically declare a data area. Refer to [Edit Data Syntax](#) for more information on edit data commands and examples of the use of dynamic data areas.

---

**NOTE:** Some server based scripts may not use data areas as means of defining or exchanging data, depending on script type and the chosen scripting technique. Refer to [The Big Picture Of Server Based Scripts](#) for an overview of server scripts and their applicable scripting options.

---

## Securing Script Execution

The system supports the ability to secure the execution of scripts by associating the script with an Application Service. Refer to [The Big Picture of Application Security](#) for more information. Application security is optional for user-invocable BPA scripts. If a script is not associated with an application service, all users may execute the script. Otherwise, only users that have **Execute** access to the application service may execute the script. For service scripts, the application service is required.

## The Big Picture Of BPA Scripts

---

**FASTPATH:** Refer to [The Big Picture Of Scripts](#) to better understand the basic concept of scripts.

---

Users may require instructions in order to perform certain tasks. The business process assistant allows you to set up scripts that step a user through your business processes. For example, you might want to create scripts to help users do the following:

- Add a new person to an existing account
- Set up a customer to pay automatically
- Modify a customer who no longer wants to receive marketing information
- Modify a customer's web password
- Record a trouble order
- Merge two accounts into one account
- Fix a bill with an invalid rate
- ... (the list is only limited by your time and imagination)

Users execute these scripts via the [business process assistant](#) (BPA). Users can also define their favorite BPA scripts in their [user preferences](#). By doing this, a user can execute a script by pressing an accelerator key (Ctrl + Shift + a number).

Don't think of these scripts as merely a training tool. BPA scripts can also reduce the time it takes to perform common tasks. For example, you can write a script that reduces the "number of clicks" required to add a new person to an existing account.

---

**CAUTION:** Future upgrade issues. Although we make every effort not to remove fields or tab pages between releases, there may be times when changes made by the base-package will necessitate changes to your scripts. Please refer to the release notes for a list of any removed fields or tab pages.

---

**CAUTION:** Scripts are not a substitute for end-user training. Scripts minimize the steps required to perform common tasks. Unusual problems (e.g., a missing meter exchange) may be difficult to script as there are many different ways to resolve such a problem. However, scripts can point a user in the right direction and reduce the need to memorize obscure business processes.

---

The topics in this section describe background topics relevant to BPA scripts.

## How To Invoke Scripts

Refer to [Initiating Scripts](#) for a description of how end-users initiate scripts.

## Developing and Debugging Your BPA Scripts

We recommend considering the approaches outlined below when you construct scripts.

While designing your scripts, determine the most maintainable way to set them up. Rather than creating complex, monolithic scripts, we recommend dividing scripts into smaller sections. For example

- Determine if several scripts have similar steps. If so, set up a script that contains these common steps and invoke it from the main scripts using a **Perform script** step.
- Determine if a large script can be divided into logical sections. If so, set up a small script for each section and create a "master script" to invoke each sub script via a **Transfer control** step.

For debugging purposes, you may find it helpful to categorize the step types into two groups: those that involve some type of activity in the [script area](#), and those that don't. The following step types cause activity in the script area: **Height**, **Display text**, **Prompt user**, **Input data**, **Input Map**, **Set focus to a field**.

The rest of the step types are procedural and involve no user interaction. There are two techniques you can use to assist in debugging these step types.



- You can instruct the system to display text in the script area.
- You can display an entire data area (or a portion thereof) in the script area by entering `%+...+%` where ... is the name of the node whose element(s) should be displayed.

---

**NOTE: Time saver.** When you develop a new BPA script, change your [user preferences](#) to include the script as your first "favorite". This way, you can press `Ctrl+Shift+1` to invoke the script (eliminating the need to select it from the [script menu](#)).

---

## Launching A Script From A Menu

You can create menu items that launch BPA scripts rather than open a page. To do this, create a [navigation option](#) that references your script and then add a menu item that references the navigation option.

If the navigation option is referenced on a [context menu](#) and the navigation option has a "context field", a temporary storage variable will be created and populated with the unique identifier of the object in context. For example, if you add a "script" navigation option to the bill context menu and this navigation option has a context field of `BILL_ID`, the system will create a temporary storage variable called `BILL_ID` and populate it with the respective bill id when the menu item is selected.

## Launching A Script When Starting The System

You can set the system to launch a script upon startup.

For example, imagine that through an interactive voice response system, a customer has keyed in their account ID and has indicated that they would like to stop an automatic payment. At the point when the IVR system determines that the customer must speak to a user, the interface can be configured to launch the application. When launched it passes the script name and account ID. It can also pass a [navigation option](#) to automatically load the appropriate page (if this information is not part of the script).

To do this, parameters are appended to the standard system URL. The following parameters may be supplied:

- `script=<scriptname>`
- `ACCT_ID=<account id>`
- `location=<navigation option>`

Parameters are added to the standard system URL by appending a question mark (?) to the end and then adding the "key=value" pair. If you require more than one parameter, use an ampersand (&) to separate each key=value pair.

For example, the following URLs are possible ways to launch the **CM-StopAutoPay** script at startup, assuming your standard URL for launching the system is `http://system-server:1234/cis.jsp`:

- **`http://system-server:1234/cis.jsp?script=CM-StopAutoPay`**
- **`http://system-server:1234/cis.jsp?script=CM-StopAutoPay&ACCT_ID=1234512345`**
- **`http://system-server:1234/cis.jsp?script=CM-StopAutoPay&ACCT_ID=1234512345&location=accountMaint`**

It doesn't matter in which order the parameters are provided. The system processes them in the correct order. For example, the following examples are processed by the system in the same way:

- **`http://system-server:1234/cis.jsp?ACCT_ID=1234512345&script=CM-StopAutoPay&location=accountMaint`**
- **`http://system-server:1234/cis.jsp?ACCT_ID=1234512345&location=accountMaint&script=CM-StopAutoPay`**

These parameters are kept in a common area accessible by any script for the duration of the session. To use these parameters on a script you may reference the corresponding `%PARM-<name>` [global variables](#). In this example, after the system is launched any script may have access to the above account ID parameter value by means of the `%PARM-ACCT_ID` global variable. Also note, these parameters are also loaded into temporary storage (to continue the example, there'd also be a temporary storage variable called `ACCT_ID` that holds the passed value).

---

**NOTE: Minimizing the Dashboard.** As described in [Dashboard Portal](#), a URL parameter may be used to minimize the dashboard when launching the system, which may be included in the URL when launching the system with a script.

---

## Determining the Target Navigation in the Script

By default, if a script is provided but the location attribute is not provided, the system navigates to the user's home page prior to executing the script. If the script itself includes a step to navigate to a target page as one of its initial steps, the navigation to the home page is unnecessary and may degrade performance. The system supplies an optional attribute to include in the URL to bypass the home page: **initNav=false**.

---

**NOTE:** The system still requires a page to be launched for technical reasons. A blank portal with no zones is used for this purpose. Users may see this portal (called **Launching Application**) briefly before the navigation initiated by the script. In addition, this is the portal that the user will remain on if there are any errors in the script or if the script does not navigate anywhere.

---

## Navigate to a Given Record's Maintenance Portal

If your use case is to simply navigate to the maintenance page for a given record and display that record, the script **F1-GotoPrtl** (Navigate to portal for an MO and key values) may be used. This script is only applicable to records that are governed by a business object (and define a navigation option as a BO option). It takes the incoming maintenance object code and primary key values, looks up the appropriate portal navigation option from the record's BO, populates keys into the 'page data model' and navigates to the portal.

The script expects the keys to be passed in using variable names **pkValue1** through **pkValue5**. It is also recommended to include the **initNav=false** attribute. This example navigates to the appropriate Migration Data Set portal for the given ID's business object.

- <http://system-server:1234/cis.jsp?script=F1-GotoPrtl&pkValue1=1234512345&mo=F1-MIGRDS&initNav=false>

## Executing A Script When A To Do Entry Is Selected

The system creates [To Do entries](#) to highlight tasks that require attention (e.g., records in error). Users can complete many of these tasks without assistance. However, you can set up the system to automatically launch a script when a user selects a To Do entry. For example, consider a To Do entry that highlights a bill that's in error due to an invalid mailing address. You can set up the system to execute a script when this To Do entry is selected by a user. This script might prompt the user to first correct the customer's default mailing address and then re-complete the bill.

The following points provide background information to help you understand how to implement this functionality:

- Every To Do entry references a [To Do type](#) and a [message category and number](#). The To Do type defines the category of the task (e.g., bill errors). The message number defines the specific issue (e.g., a valid address can't be found.). Refer to [The Big Picture of System Messages](#) for more information about message categories and numbers.
- When a user drills down on a To Do entry, either a script launches OR the user is transferred to the transaction associated with the entry's To Do type. You control what happens by configuring the To Do type accordingly:
  - If you want to launch a script when a user drills down on an entry, you link the script to the [To Do type and message number](#). Keep in mind that you can define a different script for every message (and some To Do types have many different messages).
  - If the system doesn't find a script for an entry's To Do type and message number, it transfers the user to the To Do type's default transaction.

---

**NOTE: How do you find the message numbers?** We do not supply documentation of every To Do type's message numbers (this list would be impossible to maintain and therefore untrustworthy). The best way to determine which message numbers warrant a script is during pre-production when you're testing the system. During this period, To Do

entries will be generated. For those entries that warrant a script, simply display the entry on [To Do maintenance](#). On this page, you will find the entry's message number adjacent to the description.

---

- These types of scripts invariably need to access data that resides on the selected To Do entry. Refer to [How To Use To Do Fields](#) for the details.

## The Big Picture Of Script Eligibility Rules

You can configure [eligibility criteria](#) on the scripts to limit the scripts that a user sees in the [script search](#). For example, you could indicate a script should only appear on the script menu if the user belongs to the level 1 customer service representative group. You may also indicate that a script should only appear if the data a user is viewing has certain criteria. For example, if you are using Oracle Utilities Customer Care and Billing, you can indicate that a script should only appear if the current account's customer class is residential. By doing this, you avoid presenting the user with scripts that aren't applicable to the current data in context or the user's role.

The topics in this section describe eligibility rules.

## Script Eligibility Rules Are Not Strictly Enforced

The [script search](#) gives a user a choice of seeing all scripts or only scripts that are eligible (given the current data in context and their user profile). This means that it's possible for a script that isn't eligible for the given context data / user to be executed via this search. In other words, the system does not strictly enforce a script's eligibility rules.

It might be more helpful to think of eligibility rules as "highlight conditions". These "highlight conditions" simply control whether the script appears in the [script search](#) when a user indicates they only want to see eligible scripts.

## You Can Mark A Script As Always Eligible

If you don't want to configure eligibility rules, you don't have to. Simply indicate that the script is always eligible.

## You Can Mark A Script As Never Eligible

If you have scripts that you do not want a user to select from the script menu, indicate that it is never eligible. An example of a script that you wouldn't want a user to select from the menu is one that is [launched when a To Do entry is selected](#). These types of scripts most likely rely on data linked to the selected To Do entry. As a result, a user should only launch scripts of this type from the To Do entry and not from the script menu.

## Criteria Groups versus Eligibility Criteria

Before we provide concrete examples of eligibility criteria, we need to explain two concepts: Criteria Groups and Eligibility Criteria. A script's criteria groups control whether a user is eligible to choose a script. At a high level, it works like this:

- A criteria group has one or more eligibility criteria. A group's criteria control whether the group is considered true or false.
- When you create a group, you define what should happen if the group is true or false. You have the following choices:
  - The user is eligible to choose the script
  - The user is not eligible to choose the script
  - The next group should be checked

We'll use the following example from Oracle Utilities Customer Care and Billing to help illustrate these points. Assume a script is only eligible if:

- The customer has electric service and the user belongs to user group A, B or C
- OR, the customer has gas service and the user belongs to user group X, Y or A

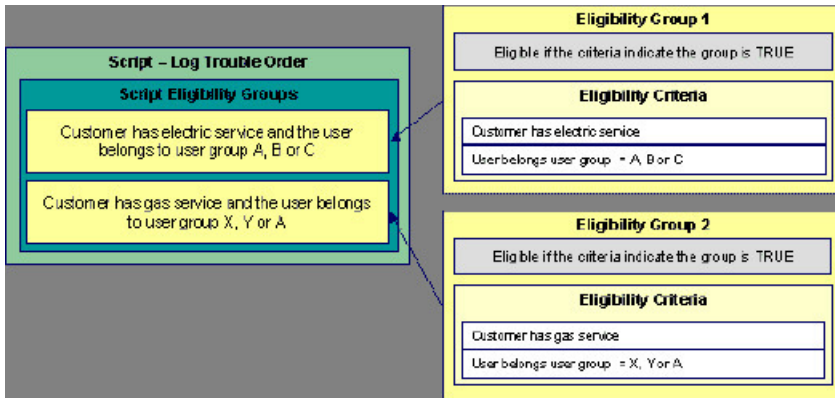

This script requires two eligibility groups because it has two distinct conditions:

- IF (Customer has electric service AND (User belongs to user group A, B or C))
- IF (Customer has gas service AND (User belongs to user group X, Y or A))

If either condition is true, the script is eligible.

You would need to set the following criteria groups in order to support this requirement:

Group No.	Group Description	If Group is True	If Group is False
1	Customer has electric service and the user belongs to user group A, B or C	<b>Eligible</b>	<b>Check next group</b>
2	Customer has gas service and the user belongs to user group X, Y or A	<b>Eligible</b>	<b>Ineligible</b>

The following criteria are required for each of the above groups:

Group 1: Customer has electric service and the user belongs to user group A, B or C				
Seq	Logical Criteria	If Eligibility Criteria is True	If Eligibility Criteria is False	If Insufficient Data
10	Customer has electric service	<b>Check next condition</b>	<b>Group is false</b>	<b>Group is false</b>
20	User belongs to user group A, B or C	<b>Group is true</b>	<b>Group is false</b>	<b>Group is false</b>

Group 2: Customer has gas service and the user belongs to user group X, Y or A				
Seq	Logical Criteria	If Eligibility Criteria is True	If Eligibility Criteria is False	If Insufficient Data
10	Customer has gas service	<b>Check next condition</b>	<b>Group is false</b>	<b>Group is false</b>
20	User belongs to user group X, Y or A	<b>Group is true</b>	<b>Group is false</b>	<b>Group is false</b>

The next section describes how you might configure the specific logical criteria in each of the groups.

## Defining Logical Criteria

When you set up an eligibility criterion, you must define two things:

- The field to be compared
- The comparison method

You have the following choices in respect of identifying the *field to be compared* :

- You can execute an algorithm to retrieve a field value from somewhere else in the system.
- Some products may support choosing a characteristic linked to an appropriate object in the system (such as an account or person).

You have the following choices in respect of identifying the *comparison method*:

- You can choose an operator (e.g., >, <, =, BETWEEN, IN, etc.) and a comparison value.
- You can execute an algorithm that performs the comparison (and returns True, False or Insufficient Data). This is also a very powerful feature, but it's not terribly intuitive. We'll present a few examples later in this section to illustrate the power of this approach.

The [Examples Of Script Eligibility Rules](#) provide examples to help you understand this design.

## Examples Of Script Eligibility Rules

The topics in this section provide examples about how to set up script eligibility rules.

### A Script With A Time Span Comparison

A script that is only eligible for senior citizens has the following eligibility rules:

- Customer class = Residential
- Birth date equates to that of a senior citizen

These rules require only one eligibility group on the script. It would look as follows:

Group No.	Group Description	If Group is True	If Group is False
1	Residential and Senior Citizen	<b>Eligible</b>	<b>Ineligible</b>

The following criteria will be required for this group:

Group 1: Residential, Calif, Senior					
Seq	Field to Compare	Comparison Method	If True	If False	If Insufficient Data
10	Algorithm: retrieve account's customer class	= R	<b>Check next condition</b>	<b>Group is false</b>	<b>Group is false</b>
30	Person characteristic: Date of Birth	Algorithm: True if senior	<b>Group is true</b>	<b>Group is false</b>	<b>Group is false</b>

The first criterion is easy; it calls an algorithm that retrieves a field on the current account. This value, in turn, is compared to a given value. If the comparison results in a True value, the next condition is checked. If the comparison doesn't result in a True value, the **Group is false** (and, the group indicates that if the group is false, the script isn't eligible). Refer to SECF-ACCTFLD in the product documentation for an example of an algorithm type that retrieves a field value from an account.

The last criterion contains a time span comparison. Time span comparisons are used to compare a date to something. In our example, we have to determine the age of the customer based on their birth date. If the resultant age is > 65, they are considered a senior citizen. To pull this off, you can take advantage of a comparison algorithm supplied with the base script as described below.

- Field to Compare. The person characteristic in which the customer's birth date is held is selected.
- Comparison Method. We chose a comparison algorithm that returns a value of **True** if the related field value (the customer's date of birth) is greater than 65 years (refer to [SECC-TIMESPN](#) for an example of this type of algorithm).

You'll notice that if a value of **True** is returned by the **True if senior** algorithm, the group is true (and we've set up the group to indicate a true group means the script is eligible).

---

**NOTE: The time span algorithm can be used to compare days, weeks, months, etc.** Refer to [SECC-TIMESPN](#) for more information about this algorithm.

---

## A Script With Service Type Comparison

Imagine a script that is only eligible if the current customer has gas service and the user belongs to user groups A, B or C. This script would need the following eligibility rules:

- Customer has gas service
- User belongs to user group A, B, or C

These rules require only one eligibility group on the script. It would look as follows:

Group No.	Group Description	If Group is True	If Group is False
1	Has gas service and user is part of user group A, B or C	<b>Eligible</b>	<b>Ineligible</b>

The following criteria are required for this group:

Group 1: Has gas service and user is part of user group A, B, or C					
Seq	Field to Compare	Comparison Method	If True	If False	If Insufficient Data
10	Algorithm: check if customer has gas service	= True	<b>Check next condition</b>	<b>Group is false</b>	<b>Group is false</b>
20	Algorithm: check if user belongs to user group A, B or C	= True	<b>Group is true</b>	<b>Group is false</b>	<b>Group is false</b>

Both criteria are similar - they call an algorithm that performs a logical comparison. These algorithms are a bit counter intuitive (but understanding them provides you with another way to implement complex eligibility criteria):

The first criterion works as follows:

- **Field to Compare.** We chose a "field to compare" algorithm that checks if the current account has service agreements that belong to a given set of service types. It returns a value of **True** if the customer has an active service agreement that matches one of the service types in the algorithm. In our example, the "check if customer has gas service" algorithm returns a value of **True** if the customer has at least one active service agreement whose SA type references the gas service type. The "check if customer has electric service" algorithm is almost identical, only the service type differs.
- **Comparison Method.** We simply compare the value returned by the algorithm to True and indicate the appropriate response.

The second criterion works similarly:

- **Field to Compare.** We chose a "field to compare" algorithm that checks if the user belongs to any user group in a set of user groups. It returns a value of **True** if the user belongs to at least one user group defined in parameters of the algorithm. Refer to [SECF-USRNGRP](#) for an example of this type of algorithm.
- **Comparison Method.** We simply compare the value returned by the algorithm to True and indicate the appropriate response.

---

**NOTE: Bottom line.** The "field to compare" algorithm isn't actually returning a specific field's value. Rather, it's returning a value of **True** or **False**. This value is in turn, compared by the "comparison method" and the group is set to true, false or check next accordingly.

---

# The Big Picture Of Server-Based Scripts

---

**FASTPATH:** Refer to [The Big Picture Of Scripts](#) to better understand the basic concept of scripts.

---

Server-based scripts allow an implementation to configure backend business processes. The system supports three types of server-based scripts, **Plug-In** scripts, **Service** scripts and **Groovy Library** scripts.

- Plug-in scripts allow an implementation to develop routines that are executed from the system's various plug-in spots. For example, an implementation could configure a plug-in script that is executed every time an adjustment of a given type is frozen.
- Service scripts allow an implementation to develop common routines that are invoked from both front-end and back-end services. For example, an implementation could create a service script that terminates an account's automatic payment preferences. This service script could be invoked from a BPA script initiated by an end-user when a customer asks to stop paying automatically, and it could also be executed from a plug-in script if a customer fails to pay their debt on time. Service scripts are typically written using xpath scripting.
- Groovy Library scripts allow an implementation to develop groups of common routines written in the Groovy language which may be invoked from **Groovy Member** step types.

The topics in this section describe background topics relevant to server-based scripts.

## Additional Coding Options For Server Scripts

Server based scripts often perform complex functions best supported by coding in languages with more comprehensive command sets than the base script steps. The system supports two common third-party languages for this purpose.

**XML Path Language** (XPath) is a language for querying and evaluating elements or nodes in an XML document. XPath commands and expressions can be used directly within [Edit Data](#) step types. The script engine version is used to define the applicable XPath version.

**Groovy** is an object-oriented, dynamic language for the Java platform. The framework supports the use of Groovy within server-based scripts to provide restricted and controlled access to Java-like code, particularly for cloud based implementations. The following topic provides more information on how to incorporate Groovy code into scripts.

## Using Groovy Within Scripts

Groovy code can be incorporated in scripts using the step type **Groovy Members**. For each script with Groovy code, there will be a single Groovy class created by concatenating all **Groovy Members** steps.

For security, the product and third party Java classes available for scripting in Groovy will be restricted. The allowable base classes may be viewed via the Groovy JavaDocs feature in the Application Viewer and also via the 'View Groovy Javadocs' link in the context sensitive Script Tips zone. The list of allowable third party classes can be viewed via the 'View third party Groovy whitelist' link in the Script Tips zone.

---

**NOTE:** This system supports the use of Groovy for back end processing purposes. It is not intended for user interfaces. Groovy is also not applicable to BPA scripts.

---

The following describes the two methods for using Groovy.

### Using the Scripting Engine

If the script is configured to use a scripting engine version, it can include a mixture of regular and **Groovy Members** step types. The script step types will define the process to be executed. The **Groovy Members** steps will contain code that can



be called from **Edit Data** step types within the script using the **invokeGroovy** command. Only Groovy methods that receive no arguments and return void are supported using this command. Refer to the section on [edit data](#) steps for more details.

For scripts using this option, the framework provides a superclass containing methods that support common scripting actions such as move commands, string evaluation, and methods to invoke business objects, business services and service scripts. Refer to the Groovy specific JavaDocs for details of the supported methods

## Using the Groovy Engine

The system uses an engine version of **Groovy** to indicate that a script is written entirely in Groovy code and can be processed in a similar way to code written in Java. This avoids the need to convert the script to and from XML format and allows the use of code that acts directly on the system objects with consequent performance benefits.

The following script types support the Groovy engine version:

### Plug In Scripts

Plug-in Scripts can be configured to use the Groovy engine if they contain only **Groovy Members** step types. The system provides an automatically generated superclass that defines the plug-in spot API. Internally, the Groovy code must conform to the system conventions for Java based algorithm types, including the inclusion of an 'invoke' method that is the plug-in entry point, and the definition of 'soft' parameters using annotations.

### Groovy Library Scripts

Groovy Library Scripts provide the ability to create groups of common routines written in Groovy that can be called from within other scripts. Scripts of this type must include a single step type of **Groovy Library Interface** in which the publicly available methods in the library are listed. The supporting code for those methods is defined in one or more **Groovy Members** step types within the library script. The methods defined in the library can accept arguments and return values of any type. Scripts of this type use the Groovy engine by default and cannot include scripting step types.

Scripts that need to invoke methods from a Groovy library can use the createLibraryScript method provided by the system to instantiate the library interface.

## Importing Groovy Classes

The system provides the ability to import one or more Groovy classes into a script. This simplifies coding by allowing those classes to be referenced without having to use the fully qualified package name for the class. The list of imports is defined within a script using a step type of **Groovy Imports**. Only the allowable base and third party classes may be imported. The ability to import Groovy classes applies to all script types that support Groovy coding.

---

**NOTE:** If your application stack includes classes with the same names as imported classes, the code will still need to reference the full class package name when invoking associated methods to avoid ambiguity.

---

## Plug-In Scripts

---

**NOTE:** This section assumes you are familiar with the notion of plug-in spots (algorithm entities) and plug-ins. See [The Big Picture Of Algorithms](#) for more information.

---

As an alternative to writing a java program for a plug-in spot, the framework supports creating plug-ins using the defined script steps, Xpath commands, Groovy code or a combination of these three options.

The following topics describe basic concepts related to plug-in scripts.

## A Plug-In Script's API

Like program-based plug-ins, plug-in scripts:

- Run on the application server



- Have their API (input / output interface) defined by the plug-in spot (i.e., plug-in scripts don't get to declare their own API)
- Can only be invoked by the "plug-in spot driver"

For plug-ins configured to use a script engine version, the best way to understand the script's API is to use the **View Script Schema** hyperlink to view its parameters data area schema.

```

<schema>
  <parm type="group">
    <soft type="list">
      <value/>
    </soft>
    <hard type="group">
      <action use="input"/>
      <businessObject type="group" use="input">
        <id/>
      </businessObject>
    </hard>
  </parm>
</schema>

```

Notice the two groups: soft and hard. If you are familiar with plug-in spots, you'll recognize these as the classic soft and hard parameters:

- The **soft** parameters are the values of the parameters defined on the algorithm. Notice they are not named - if you want to reference them in your plug-in script, you must do it by position.
- The **hard** parameters are controlled by the plug-in spot (i.e., the algorithm entity). Notice that this plug-in spot has a single input parameter called "**businessObject/id**". Also notice the **use=** attribute - this shows that this parameter is input-only (i.e., you can't change it in the plug-in script).

---

**NOTE: XPath.** You can click on an element name to see the XPath used to reference the element in your script.

---

Plug-ins configured to use the **Groovy** engine version do not use an XML interface for the API and instead are processed in the same way as Java algorithms. The framework supplies a dynamically generated superclass that implements the plug-in spot for Groovy objects. Use the **View Script Superclass** hyperlink to view this superclass and the methods to set and get the hard parameters.

---

**NOTE:** For plug-in scripts using the **Groovy** engine version, soft parameters do not appear in the plug-in spot API as defined by the superclass. Plug-ins using only Groovy code define their soft parameters using annotations, in a similar way to Java algorithms, and fetch those values using methods defined in the algorithm code.

---

## Setting Up Plug-In Scripts

The following points describe how to implement a plug-in script:

- Compose your plug-in [script](#), associating it with the appropriate algorithm entity (plug-in spot).
- Create a new algorithm type for the respective algorithm entity, referencing your plug-in script as the program to carry out the algorithm type's function. Only plug-in scripts associated with the algorithm entity may be referenced on the algorithm type.
- Set up an algorithm for the respective algorithm type and plug it in where applicable. Refer to [Setting Up Algorithm Types](#) for more information.

## Service Scripts

BPA scripts run on the client's browser and guide the end-users through business processes. Service scripts run on the application server and perform server-based processing for [BPA scripts](#), [zones](#) and more. You may want to think of a service script as a common routine that is set up via scripting (rather than programming).

The following topics describe basic concepts related to service scripts.

### A Service Script's API

As with any common routine, a service script must declare its input / output parameters (i.e., its API). A service script's API is defined on its [schema](#).

---

**NOTE:** Refer to [Schema Nodes and Attributes](#) for a complete list of the XML nodes and attributes available to you when you construct a schema.

---

### Invoking Service Scripts

Any type of script configured to use a scripting engine version may [invoke a service script](#):

- A BPA script may invoke a service script to perform server-based processing.
- Plug-in scripts may invoke a service script (like a "common routine").
- A service script may call another service script (like a "common routine").

Map zones may be configured to invoke service scripts to obtain the data to be displayed. Refer to [Map Zones](#) for more information.

[Inbound web services](#) support interaction with service scripts allowing the outside world to interact directly with a service script.

You can also invoke a service script from a Java class.

## Groovy Library Scripts

Just as service scripts can define common routines written in scripting language, Groovy library scripts are used to define groups of common components or methods written in Groovy. Groovy library code runs on the application server and performs server-based processing for scripts that utilize Groovy code.

The following topics describe basic concepts related to Groovy library scripts.

### A Groovy Library Script's API

A Groovy library script's API is composed of one or more public methods whose code is defined in the script's steps. Those methods are defined in a step type of **Groovy Library Interface**. A Groovy library script must have one (and only one) step of this type.

### Invoking Groovy Library Methods

Any type of script that supports the **Groovy Members** step type may invoke common methods defined in Groovy library scripts.

Code within a **Groovy Members** step must create an instance of the Groovy library interface definition to enable the interface methods to be invoked. Refer to the topic [Using Groovy Within Scripts](#) for more information.

## Debugging Server-Based Scripts

The server can create log entries to help you debug your server scripts.

The logs contain a great deal of information including the contents of the referenced data area for **Move data**, **Invoke business object**, **Invoke business service** and **Invoke service script** steps.

Refer to the [Debug Mode](#) topic in the Configuration Tools chapter for details of how to execute the application in debug mode.

## Maintaining Scripts

The script maintenance transaction is used to maintain your scripts. The topics in this section describe how to use this transaction.

---

**FASTPATH:** Refer to [The Big Picture Of Scripts](#) for more information about scripts.

---

## Script - Main

Use this page to define basic information about a script. Open this page using **Admin > System > Script**.

---

**NOTE: Script Tips.** A context sensitive "Script Tips" zone is associated with this page. The zone provides links to [Edit Data Syntax](#) and [Advanced Schema Topics](#) so that users can quickly access those online help topics to aid in constructing scripts. In addition, the zone provides links to view the [Groovy JavaDocs Viewer](#) and the whitelist of third party Groovy classes so that users can verify the restricted list of classes available for Groovy coding in the script.

---

### Description of Page

Enter a unique **Script** code and **Description** for the script. Use the **Detailed Description** to describe the purpose of this script in detail. **Owner** indicates if the script is owned by the base package or by your implementation (**Customer Modification**).

---

**CAUTION:** Important! If you introduce a new script, carefully consider its naming convention. Refer to [System Data Naming Convention](#) for more information.

---

**Script Type** indicates if this is a **BPA Script**, **Plug-In Script**, **Groovy Library Script** or **Service Script**. Refer to [The Big Picture Of BPA Scripts](#) and [The Big Picture Of Server Based Scripts](#) for more information.

**Accessibility Option** appears only for BPA scripts. Set this value to **Accessible from Script Menu** for any script that may be launched as a stand-alone script. Scripts with this configuration may be linked to a navigation option so that they may be invoked from a menu and may be configured by a user as a favorite script. Set this value to **Not Accessible from Script Menu** for any script that cannot be launched on its own. For example, any script that is invoked as a sub-script from another script should have this setting. In addition, any script that is designed to be launched from within a specific portal where certain data is provided to the script should include this setting.

Enter an **Application Service** if the execution of the script should be secured. The application service should include **Execute** as one of its access modes. Refer to [Securing Script Execution](#) for more information. This field does not appear if the script type is **Groovy Library Script**.

**Algorithm Entity** appears only for [plug-in scripts](#). Use this field to define the [algorithm entity](#) into which this script can be plugged in.

**Business Object** appears only for business object related plug-in scripts. Enter the [Business Object](#) whose elements are to be referenced by the plug-in script.

**Script Engine Version** defines key information affecting the context and execution of the script.

- Script engine version values of 1, 2 and 3 define the version of the XML Path Language (XPath) to be used for the script. Versions 2 and 3 use the XPath 2 engine supplied by the XQuery team. This is the same engine used inside the Oracle database. The current script engine version 3 is a modified version that offers performance improvements without impacting existing version 2 scripts.

The default script engine version is 3.0 for plug-in and service scripts. The default version for BPA scripts is 1.0 as higher level versions are not applicable.

There are some additional details to note about script engine version 1.0:

- The XPath library used is Jaxen
- For BPA scripts, it uses the browser's xpath and XML support except for Internet Explorer where the SAXXML parser is used.
- XPath 1 (and even JavaScript) uses floating point arithmetic, which means that adding a collection of numbers with two decimal places might end up with a value of 10779.079999999998 instead of 10779.08
- A Script Engine Version value of **Groovy** indicates that only **Groovy Members** step types are used in the script and signals to the system that there is no need to convert the data to and from an XML interface. This allows for greater efficiency in script execution. Only plug-in scripts can select the **Groovy** engine version.
- The value **Framework Version 2.1 Compatibility Mode** remains for upgrade purposes. This value should only be applicable to early versions of BPA scripts using syntax that is incompatible with xpath syntax.

---

**NOTE:** The **Script Engine Version** field does not appear for **Groovy Library** scripts. The script engine version for these scripts is set to **Groovy** by default and cannot be changed.

---

Click the **View Script Schema** to view the [script's data areas](#) on the [schema viewer](#) window. This link does not appear if the script engine version is **Groovy**.

Click the **View XSD** hyperlink to view a script's schema definition in XSD format. This link only appears if the script type is **BPA Script** or **Service Script**.

The **View Script Superclass** hyperlink appears only for plug-in scripts using an engine version of **Groovy**. Click this link to view the code of the runtime generated superclass for the related plug-in spot's implementation.

The **View Script As Text** hyperlink appears for server-based scripts only. Click this link to view the internal scripting commands in a separate window.

The [tree](#) summarizes the script's steps. You can use the hyperlink to transfer to the **Step** tab with the corresponding step displayed.

## Script - Step

Use this page to add or update a script's steps. Open this page using **Admin > System > Script** and then navigate to the **Step** tab.

---

**NOTE: Time saver.** You can navigate to a step by clicking on the respective node in the tree on the Main tab.

---

### Description of Page

The **Steps** accordion contains an entry for every step linked to the script. When a script is initially displayed, its steps are collapsed. To see a step's details, simply click on the step's summary bar. You can re-click the bar to collapse the step's details. Please see [accordions](#) for the details of other features you can use to save time.

Select the **Step Type** that corresponds with the step. Refer to [How To Set Up Each Step Type](#) for an overview of the step types.

---

**CAUTION:** The Step Type affects what you can enter on other parts of this page. The remainder of this section is devoted to those fields that can be entered regardless of Step Type. The subtopics that follow describe those fields whose entry is contingent on the Step Type.

---

**Step Sequence** defines the relative position of this step in respect of the other steps. The position is important because it defines the order in which the step is executed. You should only change a Step Sequence if you need to reposition this step. But take care; if you change the Step Sequence and the step is referenced on other steps, you'll have to change all of the referencing steps.

---

**NOTE: Leave gaps in the sequence numbers.** Make sure you leave space between sequence numbers so that you can add new steps between existing ones in the future. If you run out of space, you can use the **Renumber** button to renumber all of the steps. This will renumber the script's steps by 10 and change all related references accordingly.

---

**Display Step** is only enabled on BPA scripts for step types that typically don't cause information to be displayed in the [script area](#) (i.e., step types like **Conditional Branch**, **Go to a step**, **Height**, etc). If you turn on this switch, information about the step is displayed in the script area to help you debug the script.

---

**CAUTION:** Remember to turn this switch off when you're ready to let users use this script.

---

**NOTE:** If **Display Step** is turned on and the step has **Text**, this information will be displayed in the script area. If **Display Step** is turned on and the step does not have **Text**, a system-generated messages describing what the step does is displayed in the script area.

---

**Display Icon** controls the [icon](#) that prefixes the **Text** that's displayed in the script area. Using an icon on a step is optional. This field is only applicable to BPA scripts.

**Text** is the information that displays in the [script area](#) when the step executes. You need only define text for steps that cause something to display in the script area.

---

**FASTPATH:** Refer to [How To Substitute Variables In Text](#) for a discussion about how to substitute variables in a text string.

---

**FASTPATH:** Refer to [How To Use HTML Tags And Spans In Text](#) for a discussion about how to format (with colors and fonts) the text that appears in the script area.

---

The other fields on this page are dependent on the **Step Type**. The topics that follow briefly describe each step type's fields and provide additional information about steps.

Click on the **View Script Schema** hyperlink to view the script's data areas. Doing this opens the [schema viewer](#) window.

The **View Script As Text** hyperlink appears for server-based scripts only. Click this link to view the internal scripting commands in a separate window. The presented script syntax is valid within [edit data](#) steps.

## How To Set Up Each Step Type

The contents of this section describe how to set up each type of step.

## Common Step Types To All Script Types

The contents of this section describe common step types applicable to all script types using a scripting language engine version.

## How To Set Up Conditional Branch Steps

**Conditional branch** steps allow you to conditionally jump to a different step based on logical criteria. For example, you could jump to a different step in a script if the customer is residential as opposed to commercial. In addition, several fields are required for **Conditional Branch** steps:

**Compare Field Type** and **Compare Field Name** define the first operand in the comparison. The **Field Type** defines where the field is located. The **Field Name** defines the name of the field. The following points describe each field type:

- **Current To Do Information.** Use this field type when the field being compared resides on the current To Do entry. Refer to [How To Use To Do Fields](#) for instructions on how to define the appropriate **Field Name**.
- **Data Area.** Use this field type when the field being compared is one that you put into one of the scripts data areas in an earlier step. **Field Name** must reference both a data area structure name as well as the field, for example "parm/charType". Refer to [How To Reference Fields In Data Areas](#) for instructions on how to construct the appropriate **Field Name**.
- **Page Data Model.** Use this field type when the field being compared resides on one of the tab pages in the [object display area](#). Refer to [How To Find The Name Of Page Data Model Fields](#) for instructions on how to find the appropriate **Field Name**.
- **Predefined Value.** Use this field type when the field being compared is a [global variable](#).
- **Temporary Storage.** Use this field type when the field being compared is one that you put into temporary storage in an earlier step. The **Field Name** must be the same as defined in an earlier step.
- **User Interface Field.** Use this field type when the field being compared resides on the currently displayed tab page. Refer to [How To Find The Name Of User Interface Fields](#) for instructions on how to find the appropriate **Field Name**.

**Condition** defines the comparison criteria:

- Use **>**, **<**, **=**, **>=**, **<=**, **<>** (not equal) to compare the field using standard logical operators. Enter the comparison value using the following fields.
- Use **IN** to compare the first field to a list of values. Each value is separated by a comma. For example, if a field value must equal **1**, **3** or **9**, you would enter a comparison value of **1,3,9**.
- Use **BETWEEN** to compare the field to a range of values. For example, if a field value must be between **1** and **9**, you would enter a comparison value of **1,9**. Note, the comparison is inclusive of the low and high values.

**Comparison Field Type**, **Comparison Field Name** and **Comparison Value** define what you're comparing the first operand to. The following points describe each field type:

- **Current To Do Information.** Use this field type when the comparison value resides on the current To Do entry. Refer to [How To Use To Do Fields](#) for instructions on how to define the appropriate **Field Name**.
- **Data Area.** Use this field type when the comparison value resides in one of the scripts data areas. **Field Name** must reference both a data area structure name as well as the field, for example "parm/charType". Refer to [How To Reference Fields In Data Areas](#) for instructions on how to construct the appropriate **Field Name**.
- **Page Data Model.** Use this field type when the comparison value resides on one of the tab pages in the [object display area](#). Refer to [How To Find The Name Of Page Data Model Fields](#) for instructions on how to find the appropriate **Field Name**.
- **Predefined Value.** Use this field type when the field being compared is a constant value defined in the script. When this field type is used, use **Comparison Value** to define the constant value. Refer to [How To Use Constants In Scripts](#) for instructions on how to use constants.
- **Temporary Storage.** Use this field type when the comparison value is a field that you put into temporary storage in an earlier step. The **Field Name** must be the same as defined in an earlier step.
- **User Interface Field.** Use this field type when the comparison value resides on the currently displayed tab page. Refer to [How To Find The Name Of User Interface Fields](#) for instructions on how to find the appropriate **Field Name**.

---

**NOTE: Conditional field types.** The field types **Current To Do Information**, **Page Data Model** and **User Interface Field** are only applicable to BPA scripts.

---

The above fields allow you to perform a comparison that results in a value of **TRUE** or **FALSE**. The remaining fields control the step to which control is passed given the value:

- **If TRUE, Go to** defines the step that is executed if the comparison results in a **TRUE** value.
- **If FALSE, Go to** defines the step that is executed if the comparison results in a **FALSE** value.

---

**NOTE: Numeric Comparison.** Comparison of two values may be numeric or textual (left-to-right). Numeric comparison takes place only when values on both side of the comparison are recognized as numeric by the system. Otherwise, textual comparison is used. Fields for **Current To Do Information**, **Data Area**, **Page Data Model**, and **User Interface Field** types are explicitly associated with a data type and therefore can be recognized as numeric or not. This is not the case for fields residing in **Temporary Storage** or those set as **Predefined Values**. A **Temporary Storage** field is considered numeric if it either holds a numeric value moved to it from an explicitly defined numeric value (see above) or it is a resultant field of mathematical operation. A **Predefined Value** field is considered numeric if the other field it is compared to is numeric. For example, if a numeric field is compared to a **Predefined Value** the latter is considered numeric as well resulting in numeric value comparison. However, if the two fields are defined as **Predefined Values** the system assumes their values are text strings and therefore applies textual comparison.

---

## How To Set Up Edit Data Steps

**Edit data** steps provide a free format region where you can specify commands to control your script processing.

In general, the syntax available within edit data mimics the commands available within the explicit step types. However, there are a few commands that are available only within edit data. For example, the two structured commands: **For**, and **If**.

For server-based scripts, you may find it useful to create a few explicit step types and then use the **View Script as Text** hyperlink on the [Script - Step](#) page to better understand the edit data syntax.

---

**NOTE:** Not all BPA step types are supported using the edit data syntax. Refer to the Edit Data Syntax topic below for more information on edit data commands and examples.

---

Additional field required for **Edit data** steps:

Enter your scripting commands in the **Edit Data Text** field. Click the adjacent icon to open a window providing more space for defining the edit data step.

Edit Data Syntax

The topics in this section provide detail of the syntax supported in the edit data step type.



## Contents

- [Comments](#)
- [Temporary Variables](#)
- [Context Variables](#)
- [Move Statement](#)
- [Go To Statement](#)
- [Conditional Branch Statement](#)
- [If Statement](#)
- [For Statement](#)
- [List Processing](#)
- [Functions for Processing a List](#)
- [Declare and Invoke Schema Based Objects](#)
- [System and Global Variables](#)
- [Perform Script and Transfer](#)
- [Navigate Statement](#)
- [Invoke Map Statement](#)
- [Declare BO with BO Group](#)
- [Generate Edit Map Statements](#)
- [Terminate Statement](#)
- [Invoking Groovy Code](#)
- [Debugging a BPA Script](#)

## Comments

You can place comments into your script using the double slash notation `//` in the first two characters of the edit data step. Example:

```
//  
// quit with error  
//  
if ("not(customer/securityEnabled)")  
  terminate with error (8000, 1001 %1="customer/id" %1='not allowed');  
end-if;
```

## Temporary Variables

Temporary variables can be declared within all types of scripts. They should be referenced by a leading single dollar sign (`$`). However, temporary variables behave differently in the various script types:

- In BPA Scripts temporary variables remain persistent from one BPA script to another (refer to the [Perform Script and Transfer Control statements](#)), which means that you can use temporary variables to communicate between BPA scripts.
- Temporary variables cannot be passed from a BPA script to a service or plug-in script. Only data area elements can be passed between these types of scripts.
- Within service and plug-in scripts, temporary variables remain persistent only for the life of the particular script that declared the variable. This means that temporary variables cannot be passed between plug-in scripts and service scripts, only [global variables](#), [context variables](#) and data area elements can be passed between these types of scripts.

### Declaring / Initializing / Defaulting Temporary Variables

When using a temporary variable, it should be declared or initialized with an appropriate value before using it. A typical method for declaring a variable is to simply move data to it in a move statement, for example.

```
move "0" to $index;
```

---

**FASTPATH:** Refer to [Move to a Temporary Variable](#) for more information on implicit declaration of a temporary variable within a move statement.

---

For BPA scripts, as mentioned above, temporary variables may be passed from one BPA script to another. As such, it is common to reference a temporary variable in a BPA that should have been initialized by a previous BPA. However, if there



is any reason that a temporary variable did not get initialized by a previous BPA, a reference to it will cause an error. It is good practice, therefore, to use the **default** statement that will initialize temporary variables that are not already created / initialized.

- The following statement will initialize the temporary variable \$InputAction – but only if the temporary variable has not yet been initialized:

```
default $InputAction;
```

- The following statement will set the value of the temporary variable \$InputAction to 'read' – but only if the variable has not yet been initialized:

```
default $InputAction as 'read';
```

---

**NOTE:** Scripts should take care not to define variables using a reserved keyword. The following table lists the reserved keywords.

---

---

**Keyword**

---

add

---

as

---

asError

---

bpa

---

branch

---

data

---

declareBO

---

declareBS

---

declareDA

---

declareMap

---

declareSS

---

default

---

delete

---

edit

---

element

---

else

---

end-edit

---

end-for

---

end-if

---

error

---

escape

---

evaluate

---

fastAdd

---

fastUpdate

---

for

---

goto

---

if

---

## Keyword

---

in

---

invokeBO

---

invokeBS

---

invokeMap

---

invokeSS

---

label

---

map

---

move

---

navigate

---

navigateAndReloadDashboard

---

null

---

page

---

performScript

---

popup

---

read

---

readWithoutVersion

---

replace

---

suppress

---

target

---

terminate

---

to

---

transferControl

---

update

---

using

---

warn

---

with

---

---

## Context Variables

Context variables are only available within service scripts. The context variable will be available for the duration of the service script and all that it invokes. Therefore, you can use a context variable within a service script to communicate information to a lower level service script or schema. They should be referenced by leading double dollar signs ('\$\$').

**NOTE:** Because context variables are available for lower level scripts, they may sometimes be referred to as global variables or global context variables. But they should not be confused with [global variables](#).

### Declaring / Initializing / Defaulting Context Variables

When using a context variable, it should be declared or initialized with an appropriate value before using it. A typical method for declaring a variable is to simply move data to it in a move statement, for example.

```
move 'context variable' to $$contextVariable;
```

**FASTPATH:** Refer to [Move using a Context Variable](#) for more information.

## Move Statement

The **move** statement copies a source value to a target. The following table highlights various options supported in the move statement.

Statement	Example Description	Example Syntax
Move to Element <b>move "xpath" to "xpath";</b>	Move statement with simple XPath reference.	<pre>move "acct/totalBalance" to "parm/formattedValue";</pre>
<b>NOTE:</b> An XPath expression is surrounded by double quotes.	Move statement with XPath concatenate function.	<pre>move "concat(person/ firstName, ', ', person/lastName)" to "parm/fullName";</pre>
	Move statement with XPath substring-before function.	<pre>move "substring-before(parm/ fullName, ', ')" to "person/firstName";</pre>
	Move statement with XPath substring-after function.	<pre>move "substring-after(parm/ fullName, ', ')" to "person/lastName";</pre>
	Move statement with XPath substring function.	<pre>move "substring(parm/date,1,4)" to "parm/year";</pre>
Move to Element <b>move 'literal' to "xpath";</b>	Move statement using a literal string.	<pre>move 'okay for mailing' to "account/ preferences[type="mail"]/text";</pre>
Move to Element <b>move 'Boolean' to "xpath";</b>	Move statement with Boolean as literal string.	<pre>if ("account/balance &gt; 0")   move 'true'   to "account/hasDebitBalance"; end-if;</pre>
	Moving an expression, which results in a Boolean. Note that the filter in the example below is located on a group node.	<pre>&lt;schema&gt;   &lt;account&gt;     &lt;hasDebitBalance type="boolean"/   &gt;     &lt;balance/&gt;   &lt;/account&gt; &lt;/schema&gt;</pre> <pre>move "boolean(account[balance&gt;0])" to "account/hasDebitBalance";</pre>
Move to Group <b>move "xpath" to "xpath";</b>	Move a set of elements from one group with another.  The system matches the initial level of element names and the group / list names from the source schema to the target schema. For lists and groups, the default behavior is to move all elements within the source group / list to the target group / list (even if they are not defined in the target group / list).  The business service F1-MoveByName may be used for more granular control of the move	<pre>move "account/ custInfo" to "person";</pre> <p>This statement is equivalent to the following statement:</p> <pre>move "account/custInfo/ *" to "person/*";</pre>

Statement	Example Description	Example Syntax
	(without having to define each individual move statement).	
Move using a <a href="#">Temporary Variable</a>	When moving to a temporary local variable, it is not surrounded by double quotes. <b>move "xpath" to \$variable;</b>	<pre>move "count(Person/names/ personName) + count(Person/ids/personId)" to \$PersonChildCount;</pre>
	When moving from a temporary variable, the variable is surrounded by double quotes. <b>move "\$variable" to "xpath";</b>	<pre>move "\$AccountBalance" to "parm/formattedValue";</pre>
Move using a <a href="#">Context Variable</a> <b>move "xpath" to \$\$variable;</b> <b>move \$\$variable to "xpath";</b>	Context variables, source or target, are referenced without any double quotes.	<pre>move 'context value' to \$\$contextVariable; // // here, we move from a context variable. move \$\$contextVariable to "MarketMessage/sender";</pre>
Move using a Dynamic Location <b>move "xpath"   'literal' to evaluate("xpath"   \$variable);</b> <b>move evaluate("xpath"   \$variable) to "xpath"   \$variable;</b>	The evaluate statement allows your move source or target location to be dynamically derived from a variable or schema element location.	<pre>move 'literal' to evaluate("schemaLocation"); // move "schemaLocation" to evaluate(\$Variable);  move evaluate("schemaLocation") to \$Variable; // move evaluate(\$Variable) to "schemaLocation";</pre>
Move escape <b>move escape("xpath"   \$variable) to "xpath"   \$variable;</b>	Move escape is only available for service scripts and plug-in scripts. The escape statement scans your source text value for HTML content and escapes it, i.e. replaces any HTML-like characters with special characters that are escaped from HTML rendering. By doing so the text would be displayed as plain text when displayed as part of an HTML element.  <b>NOTE:</b> You should only use this function if the text is to be displayed as part of an HTML element and is suspected to contain HTML-like characters or even malicious HTML that should not be rendered as HTML. If incorrectly displayed using a non HTML element, the special escape characters, if any would be visible as part of your text. Refer to the <a href="#">UI Map Attributes and Functions</a> for more information on how to define an element to display HTML content.	<pre>move escape("schemaLocation") to \$Variable; // move escape(\$Variable) to "schemaLocation";</pre>
Move null <b>move null to "xpath";</b>	You can remove information from the XML instance document through the special syntax of move 'null'. Note that you can specify either a node name in the XPath expression or a group name. If you specify a group then the group and all child elements will be eliminated from processing.	Remove a node and all of its child nodes: <pre>if ("boolean(customer/ securityEnabled)") goto updateInfo; else move null to "customer"; end-if;</pre>

Statement	Example Description	Example Syntax
		Remove all child nodes of a group node with the suffix '/*'.  <pre>if ( "boolean(customer/ securityEnabled)")   move null to "customer/*"; end-if;</pre>

## Go To Statement

The edit data step supports functionality analogous to the [Go To](#) step type. The syntax is **goto label**; where the label represents another location within the edit data text field (identified by this label) or represents another step in the script.

The following is an example of going to another location in the same step identified by the label **addSpouse**.

```
if ( "string(parm/spouse/name) != $BLANK" )
  goto addSpouse;
end-if;
addSpouse: invokeBO 'Person' using "parm/spouse" for add;
```

The following is an example of going to a different step within the same script. The step sequence is the reference used as the label.

```
if ( "string(parm/spouse/name) != $BLANK" )
  goto 110;
end-if;
.
.
.
110: invokeBO 'Person' using "parm/spouse" for add;
```

## Conditional Branch Statement

The edit data step supports functionality analogous to the [Conditional Branch](#) step type. The syntax is **branch (“xpath”) goto label else label**; where:

- The XPath condition in the **branch** statement must evaluate to a Boolean value of True or False.
- The targets for the **goto** and **else** statements are labels that represent another location within the edit data text field (identified by this label) or represent another step in the script.

The following example uses labels for **addSpouse** and **addAccount**

```
branch ( "string(parm/spouse/name) != $BLANK" ) goto addSpouse else addAccount;
```

## If Statement

The **if** statement is similar to the conditional branch statement. Either can be used to structure the logic of your script. This statement may optionally include an **else** statement but it should always end with an **end-if** statement.

**NOTE:** This is an example of a statement that is not represented as a separate step type. It is only available within the edit data text.

The syntax is **if (“xpath”) else end-if**; The XPath condition must evaluate to a Boolean value of True or False. The following are some examples.

Example where the XPath contains a simple logical condition.

```
if ( "string(parm/spouse/name) != $BLANK" )
  //
  // Create spouse since spouse name present
  goto addSpouse;
else
  //
  // Create account without spouse
```

```
goto addAccount;
end-if;
```

Example where the XPath contains a complex condition.

```
if ("string(parm/spouse/name) != $BLANK and string(parm/hasSpouse) = true or boolean(parm/requireSpouse)")
//
// Create spouse since spouse name present
goto addSpouse;
end-if;
```

Example of a stacked set of statements used to evaluate multiple possible values of a field.

```
if ("parm/rowCount = 0")
//
// no rows found
goto quit;
end-if;
if ("parm/rowCount = 1")
//
// one row found
goto process;
end-if;
if ("parm/rowCount > 1")
//
// more than one row found
goto quit;
end-if;
quit: terminate;
```

The following XPath shows Boolean based on the existence of the node. In this example, if the node exists in the XML instance document being processed, the statement will evaluate to True. If no element is found, the statement evaluates to false.

---

**NOTE:** When treating XPath nodes as Boolean variables be aware that an empty node evaluates to True. Only a missing node return False.

---

```
if ("boolean(parm/spouse/name)")
goto addSpouse;
else
//
// Create account without spouse
goto addAccount;
end-if;

if ("not(parm/spouse/name)")
//
// Create account without spouse
goto addAccount;
else
goto addSpouse;
end-if;
```

## For Statement

The **for** statement creates a list of nodes or values depending on your XPath expression. If you specify a list node then every child node of the list, along with its contents, will be available within the loop. If you specify a child node directly, then a list of values only will be available within the loop.

---

**NOTE:** For more information on creating new entries in a list, please refer to the [creating a new list instance](#) example.

---

**NOTE:** This is an example of a statement that is not represented as a separate step type. It is only available within the edit data text.

---

The syntax is **for (\$variable in "xpathList") end-for**; The XPath condition must evaluate to a Boolean value of True or False.

The following examples are based on this sample schema:

```
<schema>
  <SAList type="list">
    <id/>
    <balance/>
  </SAList>
  <SAContributor type="list">
    <id/>
  </SAContributor>
</schema>
```

Example that specifies the list node in the XPath expression where all child nodes are available for processing.

```
move "0" to $AccountBalance;
move "0" to $index;
for ($SAList in "SAList")
  move "$SAList/balance + $AccountBalance" to $AccountBalance;
  //
  // keep track of each SA contributing to the balance in the SA Contributor list
  move "1 + $index" to $index;
  move "$SAList/id" to "SAContributor[$index]/id";
end-for;
```

Example that specifies a child node within the list node in the XPath expression. Only values of that node are available for processing.

```
move "0" to $AccountBalance;
for ($SABalance in "SAList/balance")
  move "$SABalance + $AccountBalance" to $AccountBalance;
end-for;
```

Example that shows that a filter can be used to limit the rows selected by the **for** loop.

```
move "0" to $AccountDebitBalance;
for ($SAList in "SAList[Balance>0]")
  move "$SAList/balance + $AccountDebitBalance" to $AccountDebitBalance;
end-for;
```

Example that shows the use of a filter when specifying child nodes.

```
move "0" to $AccountCreditBalance;
for ($SABalance in "SAList[Balance<0]/balance")
  move "$SABalance + $AccountCreditBalance" to $AccountCreditBalance;
end-for;
```

## List Processing

This section provides details about processing lists. The examples in this section reference the following schema:

```
<schema>
  <parm type="group">
    <name/>
  </parm>
  <Person type="group">
    <names type="list">
      <type/>
      <name/>
    </names>
  </Person>
</schema>
```

**Referencing a List Element.** You can move a value to a particular list instance by referencing an identifying node in the list within a filter. The syntax is **move "xpath" to "xpathList[filter]/element"**; Example:

```
move "parm/name" to "Person/names[type='main']/name";
```

**Creating a New List Instance.** A special notation can be used within a move target statement to indicate a new list instance should be created. The "+" indicates to the script processor that a new instance of a list should be initiated for the target element. The syntax is **move "xpath" to "+xpathList"**; Example:

```
move "parm/name" to "Person/+names/name";
```

**Deleting a List Instance.** An XML list entry can be deleted from the database by moving an action attribute of 'delete' to the element name. To cause a database delete of a list entry requires an attribute of action="delete" in the target node and a subsequent update BO interaction. The syntax is **move 'delete' to 'xpathList@action'**); Example:

```
if ("parm/action = 'd'")
  move "0" to $index;
  for ($CCList in "CCList")
    move "1 + $index" to $index;
    if ("CCList/id = parm/id")
      move 'delete' to "CCList[$index]@action";
      goto update;
    end-if;
  end-for;
end-if;
```

The following shows the resulting XML.

```
<root>
  <CCList>
    <id>9876538976</id>
    <balance>309.98</balance>
  </CCList>
  <CCList action="delete">
    <id>4321125899</id>
    <balance>87.45</balance>
  </CCList>
</root>
```

---

**NOTE:** Deleting a list instance through use of the action attribute is risky if iterative BO interactions are required. The XML document that contains the list instance to be deleted will not be altered after a successful BO interaction, which means the document will still contain the list instance even though it no longer exists. To solve this problem, it is essential to re-read the BO after any BO update where the action attribute of 'delete' has been used.

---

**NOTE:** An alternative to the delete attribute described here, is to use the BO action of [replace](#). Manipulating a list to use the replace action avoids the problem described above concerning stale information in request documents post BO update.

---

## Functions for Processing a List

XPath provides several functions that are useful to process elements of a list including **count**, **sum** and **last**.

The following examples are based on this sample XML document:

```
<xml>
  <ft>
    <type>bill</type>
    <date>20100101</date>
    <amt>30.30</amt>
    <cat>tax</cat>
  </ft>
  <ft>
    <type>adj</type>
    <date>20100301</date>
    <amt>20.20</amt>
    <cat>int</cat>
  </ft>
  <ft>
    <type>bill</type>
    <date>20100201</date>
    <amt>10.10</amt>
    <cat>tax</cat>
```



```
</ft>
</xml>
```

The following is an example of a sum. The syntax is **move "sum(xpathList/element)" to \$variable**; The example sums the total balance.

```
move "sum(ft/amt)" to $TotalBalance;
```

The following is an example of a sum using a filter to get a subtotal. The example sums the balance of the entries that have the 'tax' category.

```
move "sum(ft[cat='tax']/amt)" to $TaxBalance;
```

The following is an example of a count. The syntax is **move "count(xpathList)" to \$variable**; The example finds the count of the number of FT entries in the list.

```
move "count(ft)" to $TranCount;
```

The following is an example of 'last', which is used to locate the last entry. The syntax is **move "last(xpathList)" to \$variable**; The example finds the last amount in the FT list.

```
move "ft[last()]/amt" to $LastAmount;
```

## Declare and Invoke Schema Based Objects

You can invoke a business object, business service or service script within the edit data step. To support the dynamic invoke, a dynamic data area name can be declared.

The schema being declared may be a business object (BO) schema, a business service (BS) schema, a service script (SS) schema, data area (DA) schema or a UI map schema. The declare statement will differ based on the type of schema, but the syntax is analogous.

- **declareBO 'BO Name' | \$variable | "xpath" as 'DynamicDataArea';**
- **declareBS 'BS Name' | \$variable | "xpath" as 'DynamicDataArea';**
- **declareSS 'SS Name' | \$variable | "xpath" as 'DynamicDataArea';**
- **declareDA 'DA Name' | \$variable | "xpath" as 'DynamicDataArea';**
- **declareMap 'Map Name' | \$variable | "xpath" as 'DynamicDataArea';**

When invoking a BO, BS or SS, the name of the object can be specified as a literal or it can be a value contained within an element or a variable. For every Invoke, you must supply an XPath reference to a group name.

- When invoking a business object, an action must be supplied. The syntax is **invokeBO 'BO Name' | \$variable | "xpath" using "xpath" for action**; The valid actions are as follows:
  - **read**. This action reads the current view of the BO data.
  - **add**. This action will add the object and read and return the resulting view of the BO.
  - **fastAdd**. This action will add the object but does not perform a subsequent 'read' to return the resulting view of the BO.
  - **update**. This action will update the object and read and return the resulting view of the BO. This action executes a 'merge' of the information specified in the invoke statement's request XML document with existing BO data. Using this action allows the script to only indicate the elements that are changing.
  - **fastUpdate**. This action will update the object but does not perform a subsequent 'read' to return the resulting view of the BO.
  - **delete**. This action deletes the object.
  - **replace**. This action is an alternate to the update action. The replace action completely replaces existing BO data with the information in the request document. Typically, the replace action is used when a BO contains a list because it is easier to simply replace all instances of a list rather than attempt a list merge, which requires special logic to [delete a list instance](#) explicitly.

---

**NOTE:** The replace action must be used when using the UI map functionality to [Upload a CSV File](#).

---

Examples:

```
invokeBO 'BusinessObject' using "dataArea" for fastAdd;
invokeBO $variableBO using "dataArea" for fastUpdate;
invokeBO "daName/boElement" using "dataArea" for replace;
```

- The syntax of the invoke statements for both a business service and service script are similar. The BS / SS is specified along with the XPath reference to the group name:
  - **invokeBS 'BS Name' | \$variable | "xpath" using "xpath";**
  - **invokeSS 'SS Name' | \$variable | "xpath" using "xpath";**

The examples use the **invokeBS** statement but the statements are similar for the **invokeSS** statement.

```
invokeBS 'BusinessService' using "dataArea";
invokeBS $variableBS using "dataArea";
invokeBS "daName/bsElement" using "dataArea";
```

Note that for BPA scripting, the **invoke** statements may also indicate how to handle warnings.

Syntax	Description	Examples
with warn asError	Indicates that a warning should be treated as an error displayed in the UI map. The text <b>asError</b> is optional.	<pre>invokeBO 'BusinessObject' using "dataArea" for add; invokeSS 'ServiceScript' using "dataArea" with warn asError;</pre>
with warn popup	Indicates that a warning should be presented in the standard framework popup. In this scenario, the user is presented with standard OK and Cancel buttons. If the user clicks OK, it means that the process should continue. If the user clicks Cancel, the processing should discontinue.	<pre>invokeBS "daName/ bsElement" using "dataArea" with warn popup;</pre>
with warn suppress	Indicates that a warning should be suppressed. This is the default if no warning syntax is added to the <b>invoke</b> statement.	<pre>invokeBS "daName/ bsElement" using "dataArea" with warn suppress; invokeSS 'ServiceScript' using "dataArea";</pre>

---

**NOTE:** For service scripts, all objects invoked from the service script will inherit their warning level. Therefore, if the service script is invoked **with warn**, all nested invoke statements will also be invoked **with warn**.

---

For BPA scripts, there should also be logic following the invocation to handle errors and warnings (if **with warn as popup** is used). The system variables **\$ERROR** and **\$WARNING** are provided to interpret the results. **\$WARNING** is set to **true** if the user has clicked the Cancel button. Also note that the product provides a BPA Script **F1-HandleErr** that may be used to display the error. The following is an example of typical error handling logic.

```
invokeBO "F1-DetermineBo/output/bo" using "boSchema" for update with warn popup;
if (" $WARNING")
    terminate;
end-if;
if (" $ERROR")
    transferControl 'F1-HandleErr';
end-if;
```

## System and Global Variables

The following tables highlight system and global variables available for script writing.

### System Variables - All Script Types

The following system variables are available for all script types (service scripts, plug-in scripts, and BPA scripts).

Variable	Description	Example
<b>\$BLANK</b>	Represents an empty node.	<pre>if ("string(parm/spouse/name) ! = \$BLANK")   goto addSpouse; end-if;</pre>
<b>\$CURRENT-DATE</b>	Represents the current date. For BPA scripts, this is the browser date.  For server scripts this is the server date (and is affected by the <a href="#">system date override</a> logic).	<pre>move "\$CURRENT-DATE" to \$tempDate;</pre>
<b>\$CURRENT-STD-DTTM</b>	Represents the current date-time expressed in standard time (meaning without any adjustments for summer time / daylight savings time).	<pre>move "\$CURRENT-STD- DTTM" to \$tempDateTime;</pre>
<b>\$DEVICE-OS</b>	Represents the user's device operating system.	<pre>move "\$DEVICE-OS" to \$tempDeviceOs;</pre>
<b>\$DEVICE-BROWSER</b>	Represents the user's device browser.	<pre>move "\$DEVICE- BROWSER" to \$tempDeviceBrowser;</pre>
<b>\$DEVICE-DISPLAY-TYPE</b>	Represents the user's device screen display type whether it is Desktop size or Medium or Small size. Returned values may be like oraDesktop, oraTablet and oraPhone.	<pre>move "\$DEVICE-DISPLAY- TYPE" to \$tempDeviceDisplayType;</pre>
<b>\$DEVICE-INFO</b>	Provides the combination of all three device properties (DEVICE-OS, DEVICE-BROWSER and DEVICE-DISPLAY-TYPE) and each property value is separated by semi-colon.	<pre>move "\$DEVICE- INFO" to \$tempDeviceInfo;</pre>

### System Variables - BPA Scripts Only

The following system variables are only available / applicable for BPA script types.

Variable	Description	Example
<b>\$DOUBLE_QUOTE</b>	Represents a double quote.	<pre>move "\$DOUBLE_QUOTE" to \$tempField;</pre>
<b>\$SINGLE_QUOTE</b>	Represents an apostrophe.	<pre>move "\$SINGLE_QUOTE" to \$tempField;</pre>
<b>\$SPACE</b>	Contains a single space value.	<pre>move "\$SPACE" to \$tempField;</pre>
<b>\$\$SYSTEM-DATE</b>	Represents the server date. Note that this date is affected by the <a href="#">system date override</a> logic)	<pre>move "\$SYSTEM-DATE" to \$tempDate;</pre>

### System Variables - Server Scripts Only

The following system variables are only available / applicable for service script and plug-in script types.

Variable	Description	Example
<b>\$ADDITIONAL-IP-INFO</b>	An HTTP request includes an "additional IP address" header field. This may be populated by	<pre>move "\$ADDITIONAL-IP-INFO" to "parm/ request/headerIpAddress";</pre>

Variable	Description	Example
	an implementation if there is some information available on the proxy server or load balancer, such as the originating IP address.	
<b>\$CURRENT-DTTM</b>	Represents the current date-time.	<code>move "\$CURRENT-DTTM" to \$tempDateTime;</code>
<b>\$F1-INSTALLATION-TIMEZONE</b>	Represents the time zone code defined on the <a href="#">installation options</a> .	<code>move "\$F1-INSTALLATION-TIMEZONE" to \$timeZone;</code>
<b>\$LANGUAGE</b>	Represents the language code the script is using. Typically this is the user's default language.	<code>move "\$LANGUAGE" to \$tempLanguage;</code>
<b>\$PROCESS-DATE</b>	Represents the process date. The process date differs from the current date because the process date will remain consistent throughout the duration of the process being executed. For example, if a service script stores several business objects – the process date is initialized at the start of the service script execution and each business object will have the same process date defaulted. The current date, especially the current date time, will reflect the actual time of processing.	<code>move "\$PROCESS-DATE" to \$tempDate;</code>
<b>\$PROCESS-DTTM</b>	Represents the process date-time. Note that the process date and time is initialized at the start of a particular process and will not reflect the exact date and time of an update.	<code>move "\$PROCESS-DTTM" to \$tempDateTime;</code>
<b>\$REQUESTING-IP-ADDRESS</b>	Represents the IP address from the HTTP request. Note that if the request is routed through a proxy server or load balancer, this IP address is be the IP address of the proxy or load balancer, not the IP address of the end user. Refer to the <b>\$ADDITIONAL-IP-INFO</b> variable for information.	<code>move "\$REQUESTING-IP-ADDRESS" to "parm/request/systemIpAddress";</code>
<b>\$USER</b>	Represents the user ID of the user executing the script.	<code>move "\$USER" to \$tempUser;</code>

## Global Variables

BPA scripts and service scripts have access to the values defined in [Global Context](#).

When a BPA script is launched from the user interface, these variables will be automatically initialized. They may be referenced with a single dollar sign in front of the field name. For example if PER\_ID is a supported global variable, then \$PER\_ID can be referenced within the BPA script:

```
move "$PER_ID" to "schema/customerId";
```

For service scripts, global variables may only be referenced if the service script has been invoked directly from a BPA script or a zone on a portal. When a service script is invoked from a BPA script or portal zone, it will have access to the suite of global context variables populated in the UI session. For service scripting, the global fields must be prefixed by two dollar signs (instead of one like in BPA scripting). For example if PER\_ID is a supported global context variable, then \$\$PER\_ID can be referenced within the service script.

```
move $$PER_ID to "schema/customerId";
```

**NOTE:** As described in [Context Variables](#), a service script may declare context variables that use the same two dollar sign syntax.

## Perform Script and Transfer Control Statements

The edit data step supports functionality analogous to the [Perform script](#) step type and the [Transfer Control](#) step type. These are both applicable only to BPA scripts.

Syntax	Valid Values	Comments
performScript	'BPA Script Name'	Script to perform is explicitly provided.
	\$Variable	Script to perform is found in a variable.
	"XPath"	Script to perform is found in an element, referenced by its XPath.
transferControl	Analogous to the <b>performScript</b> statement	

**NOTE:** When the script named in the **performScript** statement has finished, control will be returned to the calling BPA script. When the script named in the **transferControl** statement has finished, you will not be returned to the calling script, complete control will be granted to the transferred to script.

## Navigate Statement

The edit data step supports functionality analogous to the [Navigate to a page](#) step type. This is applicable only to BPA scripts.

Syntax	Valid Values	Comments
navigate	'Navigation Code'	Navigation option is explicitly provided.
	\$Variable	Navigation option is found in a variable.
	"XPath"	Navigation option is found in an element, referenced by its XPath.

In addition, the edit data step supports the ability to indicate that the dashboard should be refreshed when navigating. This is only applicable to BPA scripts.

Syntax	Valid Values
navigateAndReloadDashboard	Analogous to the <b>navigate</b> statement

## Declare BO with BO Group

This statement is specific to BPA scripts that plan to use the base script Main BO Maintenance Processing (**F1–MainProc**) for its Generate Edit Map statements. This script expects that the data used to display in the map is within a **boGroup** tag.

Syntax	Valid Values	Comments
declareBOWithBOGroup	'BO Name'	BO is explicitly provided.
	\$Variable	BO is found in a variable.
	"XPath"	BO is found in an element, referenced by its XPath.

The following table highlights additional syntax for this statement.

Syntax	Valid Values
as	'Dynamic Schema Name'

Examples:

```
declareBOWithBOGroup 'BusinessObject' as 'newMapSchema';
declareBOWithBOGroup $variableBO as 'newMapSchema';
declareBOWithBOGroup "daName/boElement" as 'newMapSchema';
```

## Invoke Map Statement

The edit data step supports functionality analogous to the [Invoke map](#) step type. This is applicable only to BPA scripts.

Syntax	Valid Values	Comments
invokeMap	'Map Name'	UI Map is explicitly provided.
	\$Variable	UI Map is found in a variable.
	"XPath"	UI Map is found in an element, referenced by its XPath.

The following table highlights additional syntax for this statement.

Syntax	Valid Values	Comments
using	"Data Area group name"	Indicates the data area to be passed to and from the server when rendering the HTML form associated with the map.
target	bpa	
	page	
	popup	

Refer to the [Invoke map](#) step type for more information about the **target** values.

If the UI map is configured to return a value, then it can be evaluated using the **\$MAP-VALUE** variable.

```
invokeMap 'UI Map' using "dataArea";
invokeMap $variableMap using "dataArea";
invokeMap "daName/mapElement" using "dataArea" target bpa;

// $MAP-VALUE is a variable returned by the invoked map.
if (" $MAP-VALUE='continue' ")
    goto 300;
else
    terminate;
end if;
```

## Generate Edit Map Statements

The 'generate edit map' statements are used to dynamically generate and launch a UI edit map based on a schema definition. The schema used may be a BO schema, a BS schema, an SS schema or a DA schema. This is applicable only to BPA scripts. The generate statement will differ based on the type of schema, but the syntax is analogous.

### Syntax

```
generateBOEditMap
```

## Syntax

---

generateBSEditMap

---

generateSSEditMap

---

generateDAEditMap

---

---

The BO code / BS code / SS code / DA code may be specified using a literal (surrounded by single quotes), as a temporary variable or by referencing an XPath schema location (surrounded by double quotes).

The following table highlights additional syntax for this statement.

Syntax	Valid Values	Comments
using	"Data Area group name"	Indicates the data area to be passed to and from the server when rendering the HTML form associated with the map.
target	bpa page popup	

The target values indicate where the generated map should be displayed as described in the [Invoke map](#) step type. If the UI map is configured to return a value, then it can be evaluated using the **\$MAP-VALUE** variable.

The examples use the **generateBOEditMap** but the statements are similar for the other schema types.

```
generateBOEditMap 'BO Name' using "dataArea";  
generateBOEditMap $variableMap using "dataArea";  
generateBOEditMap "daName/mapElement" using "dataArea" target bpa;  
  
// $MAP-VALUE is a variable returned by the invoked map.  
if (" $MAP-VALUE='continue' ")  
    goto 300;  
else  
    terminate;  
end if;
```

## Terminate Statement

The edit data step supports functionality analogous to the [Terminate](#) step type.

The following is an example of a simple **terminate** step that will stop the script.

```
if ( "not (parm/spouse/name) " )  
    terminate;  
else  
    goto addSpouse;  
end-if;
```

The **terminate with error** statement is only available in a service script.

Syntax	Attributes	Comments
terminate with error (x, y %n= element=)	'x' represents the message category	Required.
	'y' represents the message number	Required.
	%n="Element XPath" or %n='literal'	Specify the substitution parameters supported by the message using either literal values or XPath references.

Syntax	Attributes	Comments
	element="Element XPath"	Optionally specify an element name within a UI map to highlight as part of the error.

Example:

```
if ("string(customer/lastName) = $BLANK")
    terminate with error (8000, 1001 %1="customer/
lastName" %2='Last name required' element='customer/lastName');
end-if;
```

**FASTPATH:** For more information on presenting errors in a UI map, please refer to [Display Errors](#).

## Invoking Groovy Code

The edit data step supports the ability to invoke Groovy code using the syntax **invokeGroovy 'method'**; where 'method' is the name of a method defined in a **Groovy Members** step within the script. Only methods that do not receive arguments and return void can be invoked in this way. However, the method invoked from the edit data step can be supported by additional Groovy code in other **Groovy Members** step types.

Example Edit Data step:

```
invokeGroovy 'invoke';
```

Example Groovy Members step:

```
void invoke() {
    initParms()
    readBO()
    initConfig()
    retrieve()
    updateBO()
}
```

## Debugging a BPA Script

If a BPA script has height greater than zero, then selected nodes of the script's data area can be displayed at runtime. The XML data is displayed during script execution within the BPA script's display area. Specify the XPath of an XML node from any of the BPA script's data areas, between the paired characters: '%+' and '+%'.

For example, the entire contents of the schema group node named 'input', and the specific contents of the schema element named 'output/status' will be displayed in the BPA script's display area. The debug text must be entered into the BPA script's text area and not within the script's edit data field. Debug text can be declared for any explicit step of the script.

```
display input: %+input+% , and output status: %+output/status+%
```

Script Engine Version 2 and Above Notes

Scripting using the engine version 2 or above requires some extra syntax to take advantage of XPath 2 functionality. In general, any variable declared will be assumed to be a string. This means, that if you intend to construct a mathematical statement then it is necessary to explicitly declare the data type of variables as integers, numbers, or dates.

**NOTE:** Unless otherwise noted, all XPath examples in this topic are for the Version 1 engine – which means XPath 1. Statements that function using XPath 1 will not necessarily work for XPath 2. This is especially true when executing math, see below for examples.

## Date and Time Arithmetic

XPath date/time and interval data types support arithmetic operations ('+', '-', '\*' etc.) and functions, which can be used for time calculations in the same way as '1 + xs:integer(value)' is used for numeric calculations.

Compare time duration:

```
if ("(xs:dateTime(fn:current-dateTime()) - xs:dateTime($updateDateTimeX))
```



```

    ge xs:dayTimeDuration(concat('PT', BO/hoursBetweenStatisticsUpdate, 'H'))"
    goto 60;
end-if;

```

Compare one date to another:

```

if ("xs:date(parm/endDate) < xs:date(parm/startDate)")
    terminate with error (11108, 11507 element='endDate');
end-if;

```

Compare a date against today's date:

```

if ("xs:date(parm/startDate) <= xs:date($CURRENT-DATE)")
    terminate with error (11108, 11507 element='endDate');
end-if;

```

Calculate the end of month:

```

// covert to ISO
move "concat($year, '-', $mon2, '-01T00:00:00')" to $monthStart;

// calculate
move "xs:dateTime($monthStart) + xs:yearMonthDuration('P1M') - xs:dayTimeDuration('P0DT1S')"
    to $monthEnd;

// convert from ISO to OUAF
move "concat($year, '-', $mon2, '-', substring(string($monthEnd), 9, 2), '-23.59.59')" to $endDateTime;

```

**NOTE:** XPath date/time/interval formats use the ISO standard, which needs to be converted to/from formats supported in the framework.

## Comparing Date/Times in String Format

Any ISO-like string format for date/time preserves the YYYY MM DD HH MM SS sequence, which is zero-padded. Regardless of separators, this format will remain appropriate for comparison operations. In particular, date/time values in the framework format “YYYY-MM-DD.HH.MM.SS” can be used with “=”, “!=”, as well as “>”, “>=”, “<”, “<=” operators.

```

// retrieve framework date/time value
invokeBS 'CM-MAXMSRMT' using "CM-MAXMSRMT";
move "string(cm-MAXMSRMT/results[1]/measurementDateTime)" to $lastMsmtDT;

// construct another date/time
move "concat($year, '-01-01-00.00.00')" to $startDateTime;

// compare using string operators
if (" $lastMsmtDT >= $startDateTime")
    move "substring($lastMsmtDT, 1, 4)" to $latestMsmtYear;

```

## Converting Date/Times Between Framework and ISO

Conversion of date/time from framework format to ISO is only necessary for date/time arithmetic. Comparisons can be done with the framework format directly. The only difference between the framework format and ISO date/time formats is in the separators:

Framework: “YYYY-MM-DD.HH.MM.SS”

ISO: “YYYY-MM-DDTHH:MM:SS”

Example of converting from the framework format to ISO:

```

move "concat(substring($ouafDT, 1, 10), 'T', translate(substring($ouafDT, 12), '.', ':'))" to $isoDT;

```

Example of converting from ISO to the framework format:

```

move "concat(substring($isoDT, 1, 10), '.', translate(substring($isoDT, 12), ':', '.'))" to $ouafDT;

```

## Round Money With a Dynamic Currency Scale

Because different currencies support a different number of decimals, the framework provides an API for rounding a monetary amount based on a given currency.

```
move "parm/amount" to $qty;  
move "currency/decimals" to $decimals;  
move "fn:round(xs:decimal($qty) * math:exp10(xs:double($decimals)))  
  div math:exp10(xs:double($decimals))" to "parm/roundedAmount";
```

## Looping through Sequences

In XPath 2 it is possible to organize a for-loop over a sequence of integers, not only a node list.

This example shows a loop over a range of months. This is a sequence-forming construct in XPath. The XPath node list, which we are familiar with, is just another type of sequence.

```
for ($month in "1 to 12")
```

This example shows a loop over a give range of years in descending order:

```
for ($year in "fn:reverse(parm/startYear to parm/endYear)")  
  move "concat($year, '-01-01-00.00.00')" to $startDateTime;  
  move "concat($year, '-12-31-23.59.59')" to $endDateTime;  
  ...
```

This example shows a loop through a node list using 'index', so that other node lists can be accessed:

```
for ($idx in "1 to count(parm/touData/touList)")  
  move "parm/touData/touList[$idx]" to $tou; // access any list with this index
```

The above syntax can be used as an elegant alternative to maintaining indices separately, for example instead of the following:

```
move "0" to $idx;  
for ($item in "parm/touData/touList")  
  move "1 + xs:integer($idx)" to $idx;
```

## String Padding and Decimal Formatting

This is used with specific input formats or output formatting. It is applicable to zero, space and other types of padding.

This example shows prefixing for date/time components, for example producing "2010-01-02" instead of "2010-1-2".

```
move "substring(concat('0',string($month)), string-length(string($month)), 2)" to $mon2;
```

This example shows suffixing for adding decimal zero-padded alignment, for example producing "12.30" and "4.00" instead of "12.3" and "4". The example performs 3 tasks: rounding to 2 decimals, inserting a period if necessary, and zero padding.

```
// round and zero-pad to 2 decimals  
move "$item/amount" to $qty;  
move "fn:round(xs:double($qty) * 100) div 100" to $qty;  
move "string($qty)" to $qty;  
move "concat(substring-before(concat($qty, '.'), '.'), '.', substring(concat(substring-  
after($qty, '.'), '00'), 1, 2))" to $qty;
```

## Ternary Operation

This makes a choice between values based on a condition, so that it could be used in a single expression instead of an if/else block. It is know in C/C++ as 'cond ? value1 : value2' or in BASIC as 'IFF(cond, value1, value2)'. In XPath the syntax is: "if (cond) then value1 else value2". Note this is not the top-level scripting if-statement block.

In XPath this is an expression, which can be combined with other expressions. In scripting it can be used as:

```
move "if (string(D1-UnitOfMeasure/  
measuresPeakQuantity) = 'D1MP') then 'D1MX' else 'D1SM' " to $func;
```

## Pipeline Processing

In scripting, it is not easy to create a simple reusable piece of code as there are no local functions, and a separate script call is a coding overhead and requires packing/unpacking parameters. To avoid copying and pasting the same code block between similar script stages, consider ‘pipelining’, which is breaking the overall process into separate top-level steps, some of which could be shared between alternating paths. This is common for parameter preparation and output formatting. An intermediate result between stages can be stored in a “parm” substructure.

---

Instead of this code:

```
if ("type = A")
  prepare params ...
  call services for A ...
  format output ...
end-if;
if ("type = B")
  prepare params ...
  call services for B ...
  format output ...
end-if;
```

Consider this alternative:

```
prepare params ...
if ("type = A")
  call services for A ...
end-if;
if ("type = B")
  call services for B ...
end-if;
format output ...
```

---

## XPath 2 Functions

Script engine versions 2 and above support XQuery 1.0 Functions and Operators, and the XQuery 1.0 standard itself with some minor limitations. Below are the URLs to both specifications. The first link has the functions/operators available to use from XQuery.

- <http://www.w3.org/TR/xpath-functions/>
- <http://www.w3.org/TR/xquery/>

The following can only access local file systems. (For other protocols like http they will return an empty sequence):

- fn:doc
- fn:collection

## How To Set Up Go To Steps

**Go to** steps allow you to jump to a step other than the next step. Additional fields required for **Go To** steps:

**Next Step** defines the step to which the script should jump.

## How To Set Up Invoke Business Object Steps

**Invoke business object** steps allow you to interact with a [business object](#) in order to obtain or maintain its information.

The following additional fields are required for **Invoke business object** steps:

Use **Warning Level** to indicate whether warnings should be suppressed and if not, how they should be presented to the user. By default, warnings are suppressed. If **Warn As Popup** is used, the warning is displayed using the standard popup dialog. If **Warn As Error** is used processing is directed to the **If Error, Go To** step. This field is only applicable to BPA scripts.

**Group Name** references the [data area](#) to be passed to and from the server when communicating with the **Business Object**. Indicate the **Action** to be performed on the object when invoked. Valid values are **Add, Delete, Fast Add (No Read), Fast Update (No Read), Read, Replace, Update**.

---

**NOTE: Performance note.** The actions **Fast Add** and **Fast Update** should be used when the business object's data area does not need to be re-read subsequent to the **Add** or **Update** action. In other words, the **Add** and **Update** actions are equivalent to **Fast Add + Read** and **Fast Update + Read** .

---

The business object call will either be successful or return an error. The next two fields only appear when the call is issued from a BPA script, to determine the step to which control is passed given the outcome of the call.

**If Success, Go To** defines the step that is executed if the call is successful. This field is only applicable to BPA scripts.

**If Error, Go To** defines the step that is executed if the call returns on error. Please note that the error information is held in [global variables](#). This field is only applicable to BPA scripts.

---

**NOTE: Error technique.** Let's assume a scenario where a business object is invoked from a BPA script and the call returned an error. If the BPA script is configured to communicate with the user using a UI map, you may find it useful to invoke the map again to present the error to the user. Alternatively, you may invoke a step that transfers control to a script that displays the error message information and stops.

---

## How To Set Up Invoke Business Service Steps

**Invoke business service** steps allow you to interact with a [business service](#).

The following additional fields are required for **Invoke business service** steps:

Use **Warning Level** to indicate whether warnings should be suppressed and if not, how they should be presented to the user. By default, warnings are suppressed. If **Warn As Popup** is used, the warning is displayed using the standard popup dialog. If **Warn As Error** is used processing is directed to the **If Error, Go To** step. This field is only applicable to BPA scripts.

**Group Name** references the [data area](#) to be passed to and from the server when the **Business Service** is invoked.

The business service call will either be successful or return an error. The next two fields only appear when the call is issued from a BPA script, to determine the step to which control is passed given the outcome of the call.

**If Success, Go To** defines the step that is executed if the call is successful. This field is only applicable to BPA scripts.

**If Error, Go To** defines the step that is executed if the call returns on error. Please note that the error information is held in [global variables](#). This field is only applicable to BPA scripts.

---

**NOTE: Error technique.** Let's assume a scenario where a business service is invoked from a BPA script and the call returned an error. If the BPA script is configured to communicate with the user using a UI map, you may find it useful to invoke the map again to present the error to the user. Alternatively, you may invoke a step that transfers control to a script that displays the error message information and stops.

---

## How To Set Up Invoke Service Script Steps

**Invoke service script** steps allow you to execute a [service script](#).

The following additional fields are required for **Invoke service script** steps:

Use **Warning Level** to indicate whether warnings should be suppressed and if not, how they should be presented to the user. By default, warnings are suppressed. If **Warn As Popup** is used, the warning is displayed using the standard popup dialog. If **Warn As Error** is used processing is directed to the **If Error, Go To** step. This field is only applicable to BPA scripts.

**Group Name** references the [data area](#) to be passed to and from the server when the **Service Script** is invoked.

The service script call will either be successful or return an error. The next two fields only appear when the call is issued from a BPA script to determine the step to which control is passed given the outcome of the call.

**If Success, Go To** defines the step that is executed if the call is successful. This field is only applicable to BPA scripts.

**If Error, Go To** defines the step that is executed if the call returns on error. Please note that the error information is held in [global variables](#). This field is only applicable to BPA scripts.

---

**NOTE: Error technique.** Let's assume a scenario where a service script is invoked from a BPA script and the call returned an error. If the BPA script is configured to communicate with the user using a UI map, you may find it useful to invoke the map again to present the error to the user. Alternatively, you may invoke a step that transfers control to a script that displays the error message information and stops.

---

## How To Set Up Label Steps

**Label** steps allow you to describe what the next step(s) are doing. Steps of this type are helpful to the script administrators when reviewing or modifying the steps in a script, especially when a script has many steps. When designing a script, the label steps enable you to provide a heading for common steps that belong together. The script tree displays steps of this type in a different color (green) so that they stand out from other steps.

There are no additional fields for **Label** steps.

## How To Set Up Move Data Steps

**Move data** steps allow you to move data (from a source to a destination). The following additional fields are required for **Move data** steps:

**Source Field Type**, **Source Field Name** and **Source Field Value** define what you're moving. The following points describe each field type:

- **Context Variable.** Use this field type in a plug-in or service script if the source value is a variable initiated in a higher level script. This is only applicable to Service Scripts and Plug-in Scripts.
- **Current To Do Information.** Use this field type when the source value resides on the current To Do entry. Refer to [How To Use To Do Fields](#) for instructions on how to define the appropriate **Field Name**. This is only applicable to BPA Scripts.
- **Data Area.** Use this field type when the field being compared is one that you put into one of the script's data areas in an earlier step. **Field Name** must reference both a data area structure name as well as the field, for example "parm/charType". Refer to [How To Reference Fields In Data Areas](#) for instructions on how to construct the appropriate **Field Name**.
- **Global Context.** Use this field type when the source value is a [global context variable](#). This is only applicable to BPA Scripts.
- **Page Data Model.** Use this field type when the source value resides on any of the tab pages in the [object display area](#) (i.e., the source field doesn't have to reside on the currently displayed tab page, it just has to be part of the object that's currently displayed). Refer to [How To Find The Name Of Page Data Model Fields](#) for instructions on how to find the appropriate **Field Name**. This is only applicable to BPA Scripts.
- **Portal Context.** Use this field type when the source value is a variable in the portal context. This is only applicable to BPA Scripts.
- **Predefined Value.** Use this field type when the source value is a constant value defined in the script. When this field type is used, use **Source Field Value** to define the constant value. Refer to [How To Use Constants In Scripts](#) for instructions on how to use constants.

---

**NOTE: Concatenating fields together.** You can also use **Predefined Value** if you want to concatenate two fields together. For example, let's say you have a script that merges two persons into a single person. You might want this script to change the name of the person being merged out of existence to include the ID of the person remaining. In this example, you could enter a **Source Field Value** of **%ONAMEmerged into person %PERID** (where **ONAME** is a field in temporary storage that contains the name of the person being merged out of existence and **PERID** contains the

ID of the person being kept). Refer to [How To Substitute Variables In Text](#) for a description of how you can substitute field values to compose the field value.

---

- **Temporary Storage.** Use this field type when the source value is a field that you put into temporary storage in an earlier step. The **Field Name** must be the same as defined in an earlier step.
- **User Interface Field.** Use this field type when the source value resides on the currently displayed tab page. Refer to [How To Find The Name Of User Interface Fields](#) for instructions on how to find the appropriate **Field Name**. This is only applicable to BPA Scripts.

**Destination Field Type** and **Destination Field Name** define where the source field will be moved. The **Field Type** defines where the field is located. The **Field Name** defines the name of the field. The following points describe each field type:

- **Context Variable.** Use this field type in your plug-in or service script if you use a variable to communicate information to a lower level service script or schema. This is not applicable to BPA Scripts.
- **Data Area.** Use this field type when the destination field resides on one of the scripts data areas. **Field Name** must reference both a data area structure name as well as the field, for example "parm/charType". Refer to [How To Reference Fields In Data Areas](#) for instructions on how to construct the appropriate **Field Name**.
- **Page Data Model.** Use this field type when the destination field resides on any of the tab pages in the [object display area](#) (i.e., the field populated doesn't have to reside on the currently displayed tab page, it just has to be part of the object that's currently displayed). Refer to [How To Find The Name Of Page Data Model Fields](#) for instructions on how to find the appropriate **Field Name**. This is only applicable to BPA Scripts.
- **Portal Context.** Use this field type when the destination to be updated is in the current portal context. This is only applicable to BPA Scripts.
- **Temporary Storage.** Use this field type when the destination field resides in temporary storage. Use **Field Name** to name the field in temporary storage. Use **Field Name** to name the field in temporary storage. Refer to [How To Name Temporary Storage Fields](#) for more information.
- **User Interface Field.** Use this field type when the destination field resides on the currently displayed tab page. Refer to [How To Find The Name Of User Interface Fields](#) for instructions on how to find the appropriate **Field Name**. This is only applicable to BPA Scripts.

---

**NOTE: Conditional field types.** The field types **Current To Do Information**, **Page Data Model** and **User Interface Field** are only applicable to BPA scripts.

---

## How To Set Up Terminate Steps

**Terminate** steps cause a server-based script to end processing successfully or issue an error.

The following additional fields are required for **Terminate** steps:

**Error** indicates whether an error should be thrown or not. If error, **Error Data Text** must be specified, indicating the error message and any message substitution parameters. Refer to [Edit Data Syntax](#) the actual syntax of initiating an error message.

---

**NOTE:** The ability to terminate a step in error is only supported for server-based scripts.

---

## Step Types Applicable to BPA Scripts only

The contents of this section describe step types that are only applicable to BPA scripts.

## How To Set Up Display Text Steps

**Display text** steps cause a text string to be displayed in the script area. Steps of this type can be used to provide the user with guidance when manual actions are necessary. In addition, they can be used to provide confirmation of the completion of tasks.

The information you enter in the **Text** field is displayed in the [script area](#) when the step is executed.

The text string can contain [substitution variables](#) and [HTML formatting commands](#). Also note that for debugging purposes, you can display an entire data area (or a portion thereof) by entering `%+...+%` where `...` is the name of the node whose element(s) should be displayed.

---

**NOTE: Conditional step type.** This step type is only applicable to BPA scripts.

---

## How To Set Up Height Steps

**Height** steps are used to change the height of the script area to be larger or smaller than the standard size.

The following additional fields are required for **Height** steps:

**Script Window Height** defines the number of **Pixels** or the **Percentage** (according to the **Height Unit**) that the script window height should be adjusted. The percentage indicates the percentage of the visible screen area that the script area uses. For example, a percentage value of **100** means that the script area will use the entire area.

---

**NOTE: Standard Number of Pixels.** The default number of pixels used by the script area is **75**.

---

**NOTE: Adjust script height in the first step.** If you want to adjust the height of the script area, it is recommendation to define the **height** step type as your first step. Otherwise, the script area will open using the standard height and then readjust, causing the screen to redisplay.

---

**NOTE: Hide script area.** You could use this type of step to set the height to **0** to hide the script area altogether. This is useful if the script does not require any prompting to the user. For example, perhaps you define a script to take a user to a page and with certain data pre-populated and that is all.

---

**NOTE: Automatically close script area.** If you want the script area to close when a script is completed, you could define the final step type with a height of 0.

---

**NOTE: Conditional step type.** This step type is only applicable to BPA scripts.

---

## How To Set Up Input Data Steps

**Input data** steps cause the user to be prompted to populate an input field in the script area. The input value can be saved in a field on a page or in temporary storage. A **Continue** button always appears adjacent to the input field. You may configure steps of this type to display one or more buttons in addition to the **Continue** button. For example, you may want to provide the ability for the user to return to a previous step to fix incorrect information. The user may click on any of these buttons when ready for the script to continue.

The following additional fields are required for **Input Data** steps:

**Destination Field Type** and **Destination Field Name** define where the input field will be saved. The **Field Type** defines where the field is located. The **Field Name** defines the name of the field. The following points describe each field type:

- **Page Data Model.** Use this field type to put the input field into a field that resides on any of the tab pages in the [object display area](#) (i.e., the field populated doesn't have to reside on the currently displayed tab page, it just has to be part of the object that's currently displayed). Refer to [How To Find The Name Of Page Data Model Fields](#) for instructions on how to find the appropriate **Field Name**.
- **Temporary Storage.** Use this field type to put the input field into temporary storage. Use **Field Name** to name the field in temporary storage. Refer to [How To Name Temporary Storage Fields](#) for more information.
- **User Interface Field.** Use this field type to put the input field into a field that resides on the currently displayed tab page. Note, if you want to execute underlying default logic, you must populate a **User Interface Field**. Refer to [How To Find The Name Of User Interface Fields](#) for instructions on how to find the appropriate **Field Name**.

The **Prompt Values** grid may be used to define additional buttons. A separate button is displayed in the script area for each entry in this grid.

- **Prompt Text** is the verbiage to appear on the button. Refer to [How To Substitute Variables In Text](#) for a description of how you can substitute field values into the prompts.
- **Sequence** controls the order of the buttons.
- **Next Script Step** defines the step to execute if the user clicks the button.

---

**NOTE: Conditional step type.** This step type is only applicable to BPA scripts.

---

## How To Set Up Invoke Function Steps

---

**NOTE:** Functions were implemented prior to the introduction of business services (BS), service scripts (SS) and business objects (BO). The functionality is still supported, but the recommendation for implementations going forward is to use a step that invokes one of the above configuration tool objects in a script rather than defining a function.

---

**Invoke function** steps may be used to retrieve or update data independent of the page currently being displayed. For example, if you design a script that takes different paths based on the customer's customer class, you could invoke a function to retrieve the customer's customer class.

---

**FASTPATH:** You must set up a function before it can be referenced in a script. Refer to [Maintaining Functions](#) for the details.

---

The following additional fields are required for **Invoke Function** steps:

**Function** defines the name of the function. The function's **Long Description** is displayed below.

When a function is invoked, it will either be successful or return an error. The next two fields control the step to which control is passed given the outcome of the function call:

- **If Success, Go to** defines the step that is executed if the function is successful.
- **If Error, Go to** defines the step that is executed if the function returns on error. Refer to [How To Use Constants In Scripts](#) for a list of the global variables that are populated when a function returns an error.

---

**NOTE: Error technique.** If a function returns an error, we recommend that you invoke a step that transfers control to a script that displays the error message information and stops (note, the error information is held in [global variables](#)). You would invoke this script via a **Transfer Control**.

---

The **Send Fields** grid defines the fields whose values are sent to the function and whose field value source is not **Defined On The Function**. For example, if the function receives an account ID, you must define the name of the field in the script that holds the account ID.

- **Field** contains a brief description of the field sent to the function.



- **Source Field Type** and **Mapped Field / Value** define the field sent to the function. Refer to the description of Source Field under [How To Set Up Move Data Steps](#) for a description of each field type.
- **Comments** contain information about the field (this is defined on the function).

The **Receive Fields** grid defines the fields that hold the values returned from the function. For example, if the function returns an account's customer class and credit rating, you must set up two fields in this grid.

- **Field** contains a brief description of the field returned from the function.
- **Destination Field Type** and **Mapped Field** define the field returned from the function. Refer to the description of Destination Field under [How To Set Up Move Data Steps](#) for a description of each field type.
- **Comments** contain information about how the field (this is defined on the function).

---

**NOTE: Conditional step type.** This step type is only applicable to BPA scripts.

---

## How To Set Up Invoke Map Steps

**Invoke map** steps are used to invoke a **UI Map** to display, capture and update data using an HTML form. You may configure steps of this type to display one or more buttons in addition to the **Continue** button. For example, you may want to provide the ability for the user to return to a previous step to fix incorrect information. The user may click on any of these buttons when ready for the script to continue.

The following additional fields are required for **Invoke map** steps:

**Group Name** references the **data area** to be passed to and from the server when rendering the HTML form associated with the **Map**.

Use **Target Area** to designate where the map will be presented.

- Select **BPA Zone** if the map should be presented within the **script area**.
- Select **Page Area** if the map should be presented in the **object display area**, i.e. the frame typically used to house a maintenance page.
- Select **Pop-up Window** if the map should be launched in a separate window.

The **Returned Values** grid contains a row for every button defined on the map.

- **Returned Value** is the value returned when the user clicks the button.
- **Use as Default** can only be turned on for one entry in the grid. If this is turned on, this value's Next Script Step will be executed if the returned value does not match any other entry in the grid. For example, if the user closes a pop-up (rather than clicking a button), the default value will be used.
- **Next Script Step** defines the step to execute if the user clicks the button.

---

**NOTE: Conditional step type.** This step type is only applicable to BPA scripts.

---

## How To Set Up Mathematical Operation Steps

**Mathematical operation** steps allow you to perform arithmetic on fields. You can also use this type of step to add and subtract days from dates. For example, you could calculate a date 7 days in the future and then use this value as the customer's next credit review date. The following additional fields are required for **Mathematical Operation** steps:

**Base Field Type** and **Base Field Name** define the field on which the mathematical operation will be performed. The **Field Type** defines where the field is located. The **Field Name** defines the name of the field. The following points describe each field type:

- **Page Data Model.** Use this field type when the field resides on any of the tab pages in the **object display area**. Refer to [How To Find The Name Of Page Data Model Fields](#) for instructions on how to find the appropriate **Field Name**.

- **Temporary Storage.** Use this field type when the field resides in temporary storage. You must initialize the temporary storage field with a Move Data step before performing mathematical operations on the field. Refer to [How To Set Up Move Data Steps](#) for more information.
- **User Interface Field.** Use this field type when the field resides on the currently displayed tab page. Refer to [How To Find The Name Of User Interface Fields](#) for instructions on how to find the appropriate **Field Name**.

**Math Operation** controls the math function to be applied to the **Base Field**. You can specify +, -, /, and \*. Note, if the base field is a date, you can only use + or -.

**Math Field Type, Math Field Name** and **Math Field Value** define the field that contains the value to be added, subtracted, divided, or multiplied. The following points describe each field type:

- **Current To Do Information.** Use this field type when the value resides on the current To Do entry. Refer to [How To Use To Do Fields](#) for instructions on how to define the appropriate **Field Name**.
- **Page Data Model.** Use this field type when the value resides on any of the tab pages in the [object display area](#). Refer to [How To Find The Name Of Page Data Model Fields](#) for instructions on how to find the appropriate **Field Name**.
- **Predefined Value.** Use this field type when the value is a constant. When this field type is used, use **Source Field Value** to define the constant value. Refer to [How To Use Constants In Scripts](#) for more information. Note, if you are performing arithmetic on a date, the field value must contain the number and type of **days/ months/ years**. For example, if you want to add 2 years to a date, the source field value would be **2 years**.
- **Temporary Storage.** Use this field type when the value is a field that you put into temporary storage in an earlier step. The **Field Name** must be the same as defined in an earlier step.
- **User Interface Field.** Use this field type when the value resides in a field on the current tab page. Refer to [How To Find The Name Of User Interface Fields](#) for instructions on how to find the appropriate **Field Name**.

---

**NOTE: Conditional step type.** This step type is only applicable to BPA scripts.

---

## How To Set Up Navigate To A Page Steps

**Navigate to a page** steps cause a new page (or tab within the existing page) to be displayed in the object display area. Steps of this type are a precursor to doing anything on the page. The following additional field is required for **Navigate to a page** steps:

**Navigation Option** defines the transaction, tab, access mode (add or change) and any context fields that are passed to the transaction in change mode. For example, if you want a script to navigate to Person - Characteristics for the current person being displayed in the dashboard, you must set up an appropriate navigation option. Refer to [Defining Navigation Options](#) for more information.

---

**NOTE: Navigating to a page in update mode.** Before you can navigate to a page in change mode, the page data model must contain the values to use for the navigation option's context fields. If necessary, you can move values into the page data model using a [Move Data step](#) first. For example, before you can navigate to a page in change mode with an account ID in context, you may need to move the desired account ID into the ACCT\_ID field in the page data model. The actual field name(s) to use are listed as context fields on the [navigation option](#).

---

**NOTE: Conditional step type.** This step type is only applicable to BPA scripts.

---

## How To Set Up Perform Script Steps

**Perform script** steps cause another BPA script to be performed. After the performed script completes, control is returned to the next step in the original script. You might want to think of the scripts referred to on steps of this type as "subroutines". This functionality allows you to encapsulate common logic in reusable BPA scripts that can be called from other BPA scripts. This simplifies maintenance over the long term.

The following additional field is required for **Perform script** steps:

**Subscript** is the name of the script that is performed.

---

**NOTE: Conditional step type.** This step type is only applicable to BPA scripts.

---

## How To Set Up Press A Button Steps

**Press a button** steps cause a button or link text to be 'pressed' in the [object display area](#), the [application toolbar](#) or the [page title area](#). For example, you could use this type of step to add a new row to a person's characteristic (and then you could use a **Move Data** step to populate the newly added row with a given char type and value). The following additional fields are required for **Press a button** steps:

**Button Name** is the name of the button to be pressed. This button must reside on the currently displayed tab page (or in the application toolbar or page actions toolbar). Refer to [How To Find The Name Of A Button](#) for more information.

---

**NOTE: Conditional step type.** This step type is only applicable to BPA scripts.

---

## How To Set Up Prompt User Steps

**Prompt user** steps cause the user to be presented with a menu of options. The options can be presented using either buttons or in the contents of a drop down. You can also use steps of this type to pause a script while the user checks something out (and when the user is ready to continue with the script, they are instructed to click a prompt button). The following additional fields are required for **Prompt User** steps:

**Prompt Type** controls if the prompt shown in the script area is in the form of **Button(s)** or a **Dropdown**. Note, if you use a **Dropdown**, a Continue button appears adjacent to the dropdown in the script area when the step executes. The user clicks the Continue button when they are ready for the script to continue.

The **Prompt Values** grid contains a row for every value that can be selected by a user. Note, if you use a **Prompt Type of Button(s)**, a separate button is displayed in the script area for each entry in this grid.

- **Prompt Text** is the verbiage to appear on the button or in the dropdown entry. Refer to [How To Substitute Variables In Text](#) for a description of how you can substitute field values into the prompts.
- **Sequence** controls the order of the buttons or dropdown entries.
- **Use As Default** can only be turned on for one entry in the grid. If this is turned on for a dropdown entry, this value is defaulted in the grid. If this is turned on for a button, this button becomes the default (and the user should just have to press **Enter** (or **space**) rather than click on it).
- **Next Script Step** defines the step to execute if the user clicks the button or selects the dropdown value.

---

**NOTE: Conditional step type.** This step type is only applicable to BPA scripts.

---

## How To Set Up Set Focus To A Field Steps

**Set focus to a field** steps cause the cursor to be placed in a specific field on a page. A **Continue** button always appears in the script area when this type of step executes. The user may click the **Continue** button when they are ready for the script to continue. You may configure steps of this type to display one or more buttons in addition to the **Continue** button. For example, you may want to provide the ability for the user to return to a previous step to fix incorrect information. The user may click on any of these buttons when ready for the script to continue.

The following additional fields are required for **Set focus to a field** steps:

**Destination Field Name** defines the field on which focus should be placed. This field must reside on the currently displayed tab page. Refer to [How To Find The Name Of User Interface Fields](#) for instructions on how to find the appropriate **Field Name**.

The **Prompt Values** grid may be used to define additional buttons. A separate button is displayed in the script area for each entry in this grid.

- **Prompt Text** is the verbiage to appear on the button. Refer to [How To Substitute Variables In Text](#) for a description of how you can substitute field values into the prompts.
- **Sequence** controls the order of the buttons.
- **Next Script Step** defines the step to execute if the user clicks the button.

---

**NOTE: Conditional step type.** This step type is only applicable to BPA scripts.

---

## How To Set Up Transfer Control Steps

**Transfer control** steps cause the current BPA script to terminate and the control to pass to another BPA script. You might want to construct a BPA script with steps of this type when the script has several potential logic paths and you want to segregate each logic path into a separate BPA script (for ease of maintenance).

The following additional fields are required for **Transfer control** steps:

**Subscript** is the name of the script to which control is transferred.

---

**NOTE: Conditional step type.** This step type is only applicable to BPA scripts.

---

## Step Types Applicable to Server Based Scripts only

The contents of this section describe step types that are only applicable to server based scripts.

### How To Set Up Groovy Member Steps

**Groovy Member** steps provide a free format text area where you can enter Groovy code.

Enter a description of the code block in the **Text** field. Click the adjacent icon to open a window providing more space for entering text.

Enter your code in the **Edit Data Text** field. Click the adjacent icon to open a window providing more space for editing the code.

---

**NOTE:** While it is possible to set up multiple steps of type **Groovy Member** the system treats these steps as a single class for compilation and execution purposes. Refer to the topic [Using Groovy Within Scripts](#) for more information.

---

### How To Set Up Groovy Imports Steps

**Groovy Imports** step types provide a free format text area where you can list the Groovy classes to be imported for use by the code in **Groovy Member** steps within the script.

Enter a description of the imports step in the **Text** field. Click the adjacent icon to open a window providing more space for entering text.

Enter the list of classes to import in the **Edit Data Text** field using the syntax **import 'class'**; where 'class' is the fully qualified package name of the Groovy class. Click the adjacent icon to open a window providing more space for editing the text.

---

**NOTE:** For security, the classes that may be imported are restricted to those allowed by the Framework. Refer to the topic [Using Groovy Within Scripts](#) for more information.

---

## How To Set Up Groovy Library Interface Steps

**Groovy Library Interface** steps are only applicable to **Groovy Library Scripts**. They provide a free format text area where you can list the Groovy methods defined within the script that are available for use by other scripts.

Enter a description of the interface step in the **Text** field. Click the adjacent icon to open a window providing more space for entering text.

Enter the list of interface methods in the **Edit Data Text** field. Click the adjacent icon to open a window providing more space for editing the list.

---

**NOTE:** Every **Groovy Library Script** must have one and only one step of type **Groovy Library Interface**. The supporting code for the available methods is defined using one or more **Groovy Member** steps in the same script. Refer to the topic [Using Groovy Within Scripts](#) for more information.

---

## Additional Topics

The contents of this section provide additional information about steps.

## How To Find The Name Of User Interface Fields

Follow these steps to find the name of a field that resides on a page:

- Navigate to the page in question.
- Right click in the body of the page (but not while the pointer is in an input field). Note, if the field in question resides in a grid, you must right click while the pointer is in the section that contains the grid (but not while the pointer is in an input field in the grid) - this is because there's a separate HTML document for each grid on a page.
- Select **View Source** from the pop-up menu to display the source HTML.
- Scroll to the Widget Info section (towards the top of the HTML document). It contains a list of all of the objects on a page. For example, the following is an example from the Account - Main page:

```
widget Info:
widget_ID , Element Type - label info - label
ENTITY_NAME, IL - $ENTITY_NAME - Name
ACCT_ID, IT - $ACCT_ID - Account ID
ACCT_CHECK_DIGIT, IL - $ACCT_CHECK_DIGIT - Account Check Digit
IM_ACCT_ID, IM - $SEARCH_FOR_ACC_LBL - Search for Account
COLL_CL_CD, HD - $COLL_CL_CD - Collection Class
SETUP_DT, IT - $SETUP_DT - Set Up Date
CURRENCY_CD, IS - $CURRENCY_CD - Currency Code
CIS_DIVISION, IS - $CIS_DIVISION - CIS Division
PROTECT_DIV_SW, CB - $CI_ACCT$PROTECT_DIV_SW - Protect CIS Division
CUST_CL_CD, IS - $CUST_CL_CD - Customer Class
ACCESS_GRP_CD, IT - $ACCESS_GRP_CD - Access Group
IM_ACCESS_GRP_CD, IM - $SRCH_ACC_GRP_CD - Search for Access Group
ACCESS_DESCR, IL - $DESCR - Description
ACCT_MGMT_GRP_CD, IT - $ACCT_MGMT_GRP_CD - Account Management Group
IM_ACCT_MGMT_GRP_CD, IM - $SEARCH_FOR_TDR_LBL - Search for To Do Role
MGMT_DESCR, IL
ALERT_INFO, IA - $ALERT_INFO - Alert Information
BILL_CYC_CD, IS - $BILL_CYC_CD - Bill Cycle
BILL_AFTER_DT, IT - $BILL_AFTER_DT - Bill After
PROTECT_CYC_SW, CB - $PROTECT_CYC_SW - Protect Bill Cycle
BILL_PRT_INTERCEPT, IT - $BILL_PRT_INTERCEPT - Bill Print Intercept
IM_BILL_PRT_INTERCEPT, IM - $FOR_BILL_PRINT_LBL - Search for User
MAILING_PREM_ID, IT - $MAILING_PREM_ID - Mailing Premise
IM_MAILING_PREM_ID, IM - $SEARCH_FOR_MAI_LBL - Search for Mailing Premise
PREM_INFO, IL
PROTECT_PREM_SW, CB - $PROTECT_PREM_SW - Protect Mailing Premise
dataframe, GD
```

The field names that you'll reference in your scripts are defined on the left side of the HTML (e.g., ENTITY\_NAME, ACCT\_ID, CUST\_CL\_CD, etc.).

The names of fields that reside in scrolls are in a slightly different format. The following is an example of the HTML for the persons scroll that appears on Account - Person. Notice that the fields in the scroll are prefixed with the name of the scroll plus a \$ sign. For example, the person's ID is called **ACCT\_PER\$PER\_ID**.

```

Widget Info:
widget_ID , Element Type - label info - label
ENTITY_NAME, IL - $ENTITY_NAME - Name
PREM_INFO, HD
ACCT_ID, IT - $ACCT_ID - Account ID
ACCT_CHECK_DIGIT, IL - $ACCT_CHECK_DIGIT - Account Check Digit
IM_ACCT_ID, IM - $SEARCH_FOR_ACC_LBL - Search for Account
ACCT_PER$recordCount, SN - $OF_LBL - Of
ACCT_PER$PER_ID, IT - $PER_ID - Person ID
IM_ACCT_PER$PER_ID, IM - $FOR_PERSON_LBL - Search for Person
ACCT_PER$ENTITY_NAME, IL - $ENTITY_NAME - Name
ACCT_PER$MAIN_CUST_SW, CB - $MAIN_CUST_SW - Main Customer
ACCT_PER$FIN_RESP_SW, CB - $FIN_RESP_SW - Financially Responsible
ACCT_PER$THRD_PTY_SW, CB - $THRD_PTY_SW - Third Party Guarantor
ACCT_PER$ACCT_REL_TYPE_CD, IS - CI_ACCT_PER$ACCT_REL_TYPE_CD - Relationship Type
ACCT_PER$WEB_ACCESS_FLG, IS - $WEB_ACCESS_FLG - Web Self Service Access Flag
ACCT_PER$PFX_SFX_FLG, IS - $PFX_SFX_FLG - Prefix/Suffix
ACCT_PER$NAME_PFX_SFX, IT - $NAME_PFX_SFX - Pfx/sfx Name
ACCT_PER$RECEIVE_COPY_SW, CB - $RECEIVE_COPY_SW - Receives Copy of Bill
ACCT_PER$BILL_RTE_TYPE_CD, IS - $BILL_RTE_TYPE_CD - Bill Route Type
ACCT_PER$BILL_RTE_TYPE_INFO, IL
ACCT_PER$BILL_RTG METH_FLG, HD
ACCT_PER$BILL_FORMAT_FLG, IS - $BILL_FORMAT_FLG - Bill Format
  
```

The names of fields that reside in grids are in a slightly different format. The following is an example of the HTML for the names grid that appears on Person - Main. Notice that the fields in the grid are prefixed with the name of the grid plus a :x \$. For example, the person's name is called **PER\_NAME:x\$ENTITY\_NAME**. When you reference such a field in your script, you have the following choices:

- Substitute **x** with the row in the grid (and keep in mind, the first row in a grid is row **0** (zero); this means the second row is row **1**).
- If you want to reference the "current row" (e.g., the row in which the cursor will be placed), you can keep the **x** notation ( **x** means the "current row").

```

Widget Info:
widget_ID , Element Type - label info - label
PER_NAME:x$NAME_TYPE_FLG, IS - $NAME_TYPE_FLG - Name Type
PER_NAME:x$ENTITY_NAME, IT - CI_PER_NAME$ENTITY_NAME - Person Name
  
```

## How To Find The Name Of Page Data Model Fields

You find the name of a **Page Data Model** field in the same way described under [How To Find The Name Of User Interface Fields](#). The only restriction is that you cannot refer to hidden / derived fields. However, you can refer to any of the object's fields regardless of the tab page on which they appear. For example, if you position the object display area to the Main tab of the Account transaction, you can reference fields that reside on all of the tab pages.

**CAUTION:** If you populate a **Page Data Model** field, none of the underlying default logic takes place. For example, if you populate a customer contact's contact type, none of the characteristics associated with the customer contact type are defaulted onto the customer contact. If you want the underlying defaulting to take place, you must populate a **User Interface Field**.

## How To Find The Name Of A Button

If you want a **Press a button** step to press a button or click a link in the application toolbar, use one of the following names:

Button Name
IM_GOBACK
IM_HISTORY
IM_GOFORWARD
IM_menuButton
IM_USER_HOME



IM\_MY\_PREF

IM\_helpButton

IM\_aboutButton

If you want a **Press a button** step to press a button in the page actions toolbar, use one of the following names:

Button Name

IM\_SAVE

IM\_REFRESH

IM\_CLEAR

IM\_COPY

IM\_DELETE

IM\_ScrollBack

IM\_ScrollForward

The following buttons are also supported:

Button Name	Comments
IM_TO_DO	
IM_PrevTo Do	This brings you to the <a href="#">To Do Summary</a> page.
IM_NextTo Do	This simulates clicking the <b>Next To Do</b> button in the <a href="#">Current To Do Zone</a> .
IM_CurrentTo Do	This navigates to the <a href="#">To Do Entry</a> page for the user's current To Do. Refer to <a href="#">A User's Current To Do</a> for more information.
IM_MINIMIZE_DASHBOARD	Pressing this will collapse the dashboard. Note that when a script is finished, it will return the dashboard to the state it was when the script was launched.
IM_MAXIMIZE_DASHBOARD	Pressing this will expand the dashboard. Note that when a script is finished, it will return the dashboard to the state it was when the script was launched.

Follow these steps to find the name of other buttons that reside in the object display area:

- Navigate to the page in question.
- Right click in the body of the page (but not while the pointer is in an input field). Note, if the field in question resides in a grid, you must right click while the pointer is in the section that contains the grid (but not while the pointer is in an input field in the grid) - this is because there's a separate HTML document for each grid on a page.
- The option to select may differ based on the browser you are using. For example, for some browsers, the option may be **View Source**. For others, the option may be **This Frame** and then **Frame Source**
- Scroll to the Widget Info section (towards the top of the HTML document). It contains a list of all of the objects on a page, including buttons.
- Iconized buttons (e.g., search buttons) are represented as HTML images and their field names are prefixed with **IM**. The following is an example of the HTML on the To Do Entry - Main page (notice the **IM** fields for the iconized buttons).

```
* Widget Info:
*   Widget_ID , Element Type - label info - label
*   TD_ENTRY_INFO, IL - $TD_ENTRY_INFO - To Do Info
*   TD_ENTRY_ID, IT - CI_TD_ENTRY$TD_ENTRY_ID - To Do ID
*   IM_TD_ENTRY_ID, IM - $TD_ENTRY_ID_SRCH - Search for Entry Id
*   TD_TYPE_CD, IL - $TD_TYPE_CD - To Do Type
*   TYPE_DESCR, IL
*   ROLE_ID, IL
*   ROLE_DESCR2, IL - $DESCR - Description
*   FULL_MSG, PL - $GOTO_TD_ACTION_LBL - Work on To Do
*   IM_EXP_MSG_LONG, IM - $DISPLAY_MESSAG_LBL - Display Message Explanation
```

- Transaction-specific actions buttons (e.g., the buttons use to complete or forward a To Do) are represented as switches. The following is an example of the HTML on the To Do Entry - Main page (notice the **SW** fields for the buttons). Note, if you want to **Set focus** to such a field, you would move a **Predefined Value** of **TRUE** to the switch.

```
* COMPLETE_SW, BU - $COMPLETE_SW - Complete
* FORWARD_SW, BU - $FORWARD_SW - Forward
* SEND_BACK_SW, BU - $SEND_BACK_SW - Send Back
```

## How To Substitute Variables In Text

You can substitute field values into a step's text string. You do this by prefixing the field name whose value should be substituted in the string with a **%**. For example, the message, "On **%COMPLETION\_DTTM** this bill was completed, it's ending balance was **%ENDING\_BALANCE**" contains two substitution variables (the bill's completion date / time and the bill's ending balance).

To substitute the value of an element from a data area you need to reference its XPath location as follows: **%=XPath=%**. If you want to substitute the whole XML node, not just the value, you need to reference it as follows **%+XPath+%**.

Only fields linked to the [current To Do](#) and fields that reside in [temporary storage](#) and [global variables](#) can be substituted into a text string.

---

**NOTE:** You can substitute fields that reside in the User Interface or Page Data Model by first moving them into temporary storage (using a **Move data** step).

---

You can also substitute field values into the verbiage displayed in [prompts](#) using the same technique.

## How To Use HTML Tags And Spans In Text Strings and Prompts

You can use HTML tags in a step's text string. For example, the word "Continue" will be italicized in the following text string "Press<i>Continue</i> after you've selected the customer" (the <i> and </i> are the HTML tags used to indicate that the surrounded text should be italicized).

The following are other useful HTML tags:

- **<br>** causes a line break in a text string. If you use **<br><br>** a blank line will appear.
- **<font color=red>** text **</font>** causes the surrounded text to be colored as specified (in this case, red). You can also use hex codes rather than the color name.

Please refer to an HTML reference manual or website for more examples.

You can also use "spans" to customize the look of the contents of a text string. For example, your text string could be "Press **<span style='font-family:Courier; font-size:large; font-weight:bold;'>Continue</span>** after you've selected the customer". This would make the word "Continue" appear as large, bold, Courier text. Please refer to a Cascading Style Sheets (CSS) reference manual or website for more examples.

## How To Use Constants In Scripts

Some steps can reference fields called **Predefined Values**. For example, if you want to compare an input value to the letter "Y", the letter **Y** would be defined as a Predefined Value's field value.

Special constants are used for fields defined as switches. When you move **TRUE** to a switch, it turns it on. When you move **FALSE** to a switch, it turns it off.

You can use a [global variable](#) as a Predefined Value. For example, if you wanted to move the current date to a field, you'd indicate you wanted to move a Predefined Value named **%CURRENT\_DATE**.



## How To Use Global Variables

Some explicit steps can reference fields called **Predefined Values**. In addition to referencing an ad hoc constant value (e.g., the letter **Y**), you can also reference a global variable in such a field value. A global variable is used when you want to reference system data.

Note that when using the Edit Data step type, the variable available are slightly different. Refer to [Edit Data Syntax](#) for details.

The following global variables exist for BPA scripts:

Variable Name	Comments
%PARM-<name>	This is the value of a parameter of that name passed in to the application when launched via the standard system URL. Refer to <a href="#">Launching A Script When Starting the System</a> for more information on these parameters.
%PARM-NOT-SET	This is to be used to compare against %PARM-< > parameters to check if the parameter has been set or not when the application was launched. A parameter that has not been set would be considered equal to this global variable. It is recommended to compare parameters against this global variable before using them for the first time.
%BLANK	A constant that contains a blank value (no value).
%SPACE	A constant that contains a single space value.
%CURRENT-DATE	The current date as known by the browser, not the server.
%SYSTEM-DATE	The server date. Note that this date is affected by the <a href="#">system date override</a> logic)
%SAVE-REQUIRED	A flag that contains an indication of whether the data on a page has been changed (and thus requires saving). You may want to interrogate this flag to force a user to save their work before executing subsequent steps. This flag will have a value of <b>TRUE</b> or <b>FALSE</b> .
%NEWLINE	A constant that contains a new line character (carriage return). Upon substitution, a line break is inserted in the resultant text.  <b>NOTE:</b> This constant does not have the desired effect when the resultant text is HTML. For example, a step's text and prompt strings. This is because HTML ignores special characters such as new lines. Refer to <a href="#">How To Use HTML Tags And Spans In Text</a> to learn how to cause a line break in an HTML text.

To refer to a [global context](#) variable, use %FIELD\_NAME. For example, if the field SP\_ID is in the global context, you may reference %SP\_ID to reference the ID of the service point currently in context. In addition, the following special values are supported:

Variable Name	Comments
%CONTEXT-PERSONID	A constant that contains the ID of the current person.
%CONTEXT-ACCOUNTID	A constant that contains the ID of the current account.
%CONTEXT-PREMISEID	A constant that contains the ID of the current premise.

In addition, if the script is invoking something else via one of the various “Invoke” step types and an error is returned, the following global variables contain information about the error:

Variable Name	Comments
%ERRMSG-CATEGORY %ERRMSG-NUMBER	The unique identifier of the error message number.
%ERRMSG-TEXT	The brief description of the error.
%ERRMSG-LONG	The complete description of the error.

## How To Name Temporary Storage Fields

**Input Data** and **Move Data** steps can create fields in temporary storage. You specify the name of the temporary storage field in the step's **Field Name**. The name of the field must not begin with % and must not be named the same as the [global variables](#). Besides this restriction, you can use any **Field Name** that's acceptable to JavaScript (i.e., you can name a field in temporary storage almost anything). Keep in mind that field names are case-sensitive.

## How To Work With Dates

Before we discuss how to work with dates in your scripts, we need to point out that there are two types of date fields: date-only and date-time. Date-only fields only contain a date. Date-time fields contain both a date and a time. The following topics describe how to work with dates on the various step types.

---

**NOTE:** If you're working with a field that resides on the database (as opposed to a temporary storage field), the database field name will tell you what type of date it is: date-only fields are suffixed with **DT**, and date-time fields are suffixed with **DTTM**.

---

## Move Data

If you intend to use a **Move data** step to populate a *date-time* field, please be aware of the following:

- If the destination field resides in the *page data model*, the source field value must be in the format YYYY-MM-DD-HH.MM.SS or YYYY-MM-DD. If the field is in the format YYYY-MM-DD, the time of 12:00 am will be defaulted.
- If the destination field resides in the *user interface*, you must use two steps if you want to populate both date and time. To explain this, we'll assume the field you want to populate is called EXPIRE\_DTTM:
  - First, you populate the date portion of the field. To do this, you'd move a date (this value can be in any valid date format that a user is allowed to enter) to a field called EXPIRE\_DTTM\_FWDDTM\_P1. In other words, you suffix **\_FWDDTM\_P1** to the field name.
  - If you want to populate the time, you'd move the time (again, the field value can be in any format that a user could use to enter a time) to a field called EXPIRE\_DTTM\_FWDDTM\_P2. In other words, you suffix **\_FWDDTM\_P2** to the field name.

If you intend to use a **Move data** step to populate a *date-only* field, please be aware of the following:

- If the destination field resides in the *page data model*, the source field value must be in the format YYYY-MM-DD.
- If the destination field resides in the *user interface*, the source field can be in any valid date format that a user is allowed to enter.

---

**NOTE:** **%CURRENT-DATE**. Keep in mind that the [global variable](#) **%CURRENT-DATE** contains the current date and you can move this to either a page data model, user interface, or temporary storage field. If you move **%CURRENT-DATE** to a temporary storage fields, it is held in the format YYYY-MM-DD.

---

## Mathematical Operation

If you intend to use a **Mathematical operation** step to calculate a date, you can reference both date-only and date-time fields. This is because mathematical operations are only performed against the date portion of date-time fields.

Mathematical operations are limited to adding or subtracting days, months and years to / from a date.

---

**NOTE:** A useful technique to perform date arithmetic using the current date is to move the [global variable](#) **%CURRENT-DATE** to a temporary storage field and then perform the math on this field.

---

## Input Data

If you intend to use an **Input data** step on a *date-time* field, please be aware of the following:

- If the field resides in the *page data model*, the user must enter a value in the format YYYY-MM-DD-HH.MM.SS (and therefore we do not recommend doing this).
- If the field resides in the *user interface*, you must use two steps if you want to populate both date and time. To explain this, we'll assume the field you want to populate is called EXPIRE\_DTTM:
  - First, you populate the date portion of the field. To do this, you'd input the date (this value can be in any valid date format that a user is allowed to enter) in a field called EXPIRE\_DTTM\_FWDDTM\_P1. In other words, you suffix **\_FWDDTM\_P1** to the field name.
  - If you want to populate the time, you'd input the time (again, the field value can be in any format that a user could use to enter a time) in a field called EXPIRE\_DTTM\_FWDTTM\_P2. In other words, you suffix **\_FWDDTM\_P2** to the field name.

If you intend to use an **Input data** step to populate a *date-only* field, please be aware of the following:

- If the field resides in the *page data model*, the user must enter a value in the format YYYY-MM-DD (and therefore we do not recommend doing this).
- If the field resides in the *user interface*, the user can enter any valid date format.

## How To Use To Do Fields

As described under [Executing A Script When A To Do Entry Is Selected](#), you can set up the system to automatically launch a script when a user selects a To Do entry. These types of scripts invariably need to access data that resides on the selected To Do entry. The following points describe the type of information that resides on To Do entries:

- **Sort keys.** These values define the various ways a To Do list's entries may be sorted. For example, when you look at the bill segment error To Do List, you have the option of sorting the entries in error number order, account name order, or in customer class order. There is a sort key value for each of these options.
- **Message parameters.** These values are used when the system finds *%n* notation within the message text. The *%n* notation causes field values to be substituted into a message before it's displayed. For example, the message text **The %1 non-cash deposit for %2 expires on %3** will have the values of three fields merged into it before it is displayed to the user (%1 is the type of non-cash deposit, %2 is the name of the customer, and %3 is the expiration date of the non-cash deposit). Each of these three values is stored as a separate message parameter on the To Do entry.
- **Drill keys.** These values are the keys passed to the page if a user drilled down on the entry (and the system wasn't set up to launch a script). For example, a To Do entry that has been set up to display an account on the account maintenance page has a drill key of the respective account ID.
- **To Do ID.** Every To Do entry has a unique identifier referred to as its To Do ID.

You can access this information in the following types of steps:

- **Move Data** steps can move any of the above to any data area. For example, you might want to move a To Do entry's drill key to the page data model so it can be used to navigate to a specific page.
- **Conditional Branch** steps can perform conditional logic based on any of the above. For example, you can perform conditional logic based on a To Do entry's message number (note, message numbers are frequently held in sort keys).
- **Mathematical Operation** steps can use the above in mathematical operations.

A To Do entry's sort key values are accessed by using a **Field Type** of **Current To Do Information** and a **Field Name** of **SORTKEY[index]**. Note, you can find an entry's potential sort keys by displaying the entry's To Do type and navigating to the [Sort Keys](#) tab. If you want to reference the first sort key, use an index value of **1**. If you want to use the second sort key, use an index value of **2** (and so on).

A To Do entry's drill key values are accessed by using a **Field Type** of **Current To Do Information** and a **Field Name** of **DRILLKEY[index]**. Note, you can find an entry's potential drill keys by displaying the entry's To Do type and navigating to the [Drill Keys](#) tab. If you want to use the first drill key, use an index value of **1**. If you want to use the second drill key, use an index value of **2** (and so on).

A To Do entry's message parameters are accessed by using a **Field Type** of **Current To Do Information** and a **Field Value** of **MSGPARAM[index]**. Note, because a To Do type can have an unlimited number of messages and each message can have different parameters, finding an entry's message parameters requires some digging. The easiest way to determine these values is to display the To Do entry on [To Do maintenance](#). On this page, you will find the entry's message category/number adjacent to the description. Once you know these values, display the message category/number on [Message Maintenance](#). You'll find the message typically contains one or more %n notations (one for each message parameter). For example, the message text **The %1 non-cash deposit for %2 expires on %3** has three message parameters. You then need to deduce what each of the message parameters are. You do this by comparing the message on the To Do entry with the base message (it should be fairly intuitive as to what each message parameter is). If we continue using our example, %1 is the non-cash deposit type, %2 is the account name, and %3 is the expiration date. You can access these in your scripts by using appropriate index value in **MSGPARAM[index]**.

A To Do entry's unique ID is accessed by using a **Field Type** of **Current To Do Information** and a **Field Value** of **TD\_ENTRY\_ID**.

In addition, any of the above fields can be [substituted into a text string or prompt](#). Simply prefix the To Do field name with a % as you would fields in temporary storage. For example, assume you want your script to display the following text in the script area: "ABC Supply does not have a bill cycle" (where ABC Supply is the account's name). If the first sort key linked to the To Do entry contains the account's name, you'd enter a text string of **%SORTKEY[1] does not have a bill cycle**.

## How To Reference Fields In Data Areas

Various step types involve referencing field elements residing in the [script's data areas](#). To reference an element in a data area you need to provide its absolute XPath notation starting from the data area name. For example, use "CaseLogAdd/caseID" to reference a top-level "caseID" element in a script data area called "CaseLogAdd".

You don't have to type in long XPath notions. Use the **View Script Schema** hyperlink provided on the [Script - Step](#) tab page to launch the script's data areas schema.

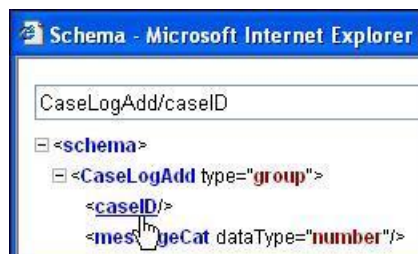

Figure 4: Schema Viewer

Doing this opens the [schema viewer](#) window where you can:

- Click on the field element you want to reference in your script step. The system automatically populates the text box on the top with the element's absolute XPath notation.
- Copy the element's XPath notation from the text box to your script.

You can also use the **View Data Area**, **View Service Script Data Area**, or **View Plug-In Script Data Area** links on [Script - Data Area](#) to the same effect. These open up the schema viewer for a specific data area respectively.

## Script - Data Area

Use this page to define the data areas used to pass information to and from the server or any other data area describing your temporary storage. Open this page using **Admin > System > Script** and then navigate to the **Data Area** tab.

---

**NOTE: Conditional tab page.** This tab page does not appear for [Groovy Library scripts](#) or [plug-in scripts](#) using the **Groovy** engine version.

---

### Description of Page

The grid contains the script's data areas declaration. For steps that invoke an object that is associated with a schema, you must declare the associated schema as a data area for your script. In addition, if you have defined one or more data areas to describe the script's temporary storage, you need to declare them too. The following bullets provide a brief description of each field on a script data area:

- **Schema Type** defines the type of schema describing the data area's element structure.
- The data area's schema is the one associated with the referenced **Object**. Only objects of the specified Schema Type may be selected.
- **Data Area Name** uniquely identifies the data area for referencing purposes. By default, the system assigns a data area with the associated object name.
- Click on the **View Data Area** link to view the data area's schema in the [schema viewer](#) window.

The **View Service Script Data Area** link appears for service scripts only. Use this link to view the script's parameters data area schema in the [schema viewer](#) window.

The **View Plug-In Script Data Area** link appears only for plug-in scripts using a script engine version. Use this link to view the script's parameters data area schema in the [schema viewer](#) window.

---

**FASTPATH:** Refer to [A Script May Declare Data Areas](#) for more information on data areas.

---

## Script - Schema

Use this page to define the data elements passed to and from a service script. Open this page using **Admin > System > Script** and then navigate to the **Schema** tab.

---

**NOTE: Conditional tab page.** This tab page only appears for [service scripts](#).

---

### Description of Page

The contents of this section describe the zones that are available on this portal.

The **General Information** zone displays the script name and description.

The [Schema Designer](#) zone allows you to edit the service script's parameters schema. The purpose of the schema is to describe the input and output parameters used when invoking the script.

---

**NOTE:** Refer to [Schema Nodes and Attributes](#) for a complete list of the XML nodes and attributes available to you when you construct a schema.

---

The **Schema Usage Tree** zone summarizes all cross-references to this schema. For each type of referencing entity, the [tree](#) displays a summary node showing a total count of referencing items. The summary node appears if at least one referencing item exists. Expand the node to list the referencing items and use their description to navigate to their corresponding pages.

## Script - Eligibility

Use this page to define a script's eligibility rules. Open this page using **Admin > System > Script** and then navigate to the **Eligibility** tab.

---

**NOTE: Conditional tab page.** This tab page only appears for [BPA scripts](#).

---

## Description of Page

Use the **Eligibility Option** to indicate whether the script is **Always Eligible**, **Never Eligible** or to **Apply Eligibility Criteria**. The remaining fields on the page are only visible if the option is **Apply Eligibility Criteria**.

---

**CAUTION:** The following information is not intuitive; we strongly recommend that you follow the guidelines under [The Big Picture Of Script Eligibility](#) before attempting to define this information.

---

The **Eligibility Criteria Group** scroll contains one entry for each group of eligibility criteria. The following fields may be defined for each group:

- Use **Sort Sequence** to control the relative order in which the group is executed when the system determines if the script should appear in the [script search](#).
- Use **Description** and **Long Description** to describe the criteria group.
- Use **If Group is True** to define what should happen if the eligibility criteria (defined in the following grid) return a value of **True**.
  - Choose **Eligible** if this script should appear.
  - Choose **Ineligible** if this script should not appear.
  - Choose **Check Next Group** if the next criteria group should be checked.
- Use **If Group is False** to define what should happen if the eligibility criteria (defined in the following grid) return a value of **False**.
  - Choose **Eligible** if this script should appear.
  - Choose **Ineligible** if this script should not appear.
  - Choose **Check Next Group** if the next criteria group should be checked.

The grid that follows contains the script's eligibility criteria. Think of each row as an "if statement" that can result in the related eligibility group being true or false. For example, you might have a row that indicates the script is eligible if the current account in context belongs to the residential customer class. The following bullets provide a brief description of each field on an eligibility criterion. Please refer to [Defining Logical Criteria](#) for several examples of how this information can be used.

- Use **Sort Sequence** to control the order in which the criteria are checked.
- Use **Criteria Field** to define the field to compare:
  - Choose **Algorithm** if you want to compare anything other than a characteristic. Push the adjacent search button to select the algorithm that is responsible for retrieving the comparison value. Click [here](#) to see the algorithm types available for this plug-in spot.
  - Some products may also include an option to choose **Characteristic**. Choosing this option displays adjacent fields to define the object on which the characteristic resides and the characteristic type. The objects whose characteristic values may be available to choose from depend on your product.
- Use **Criteria Comparison** to define the method of comparison:
  - Choose **Algorithm** if you want an algorithm to perform the comparison and return a value of True, False or Insufficient Data. Push the adjacent search button to select the algorithm that is responsible for performing the comparison. Click [here](#) to see the algorithm types available for this plug-in spot.
  - Choose any other option if you want to compare the **Criteria Field** using a logical operator. The following options are available:
    - Use **>**, **<**, **=**, **>=**, **<=**, **<>** (not equal) to compare the **Criteria Field** using standard logical operators. Enter the comparison value in the adjacent field.
    - Use **IN** to compare the **Criteria Field** to a list of values. Each value is separated by a comma. For example, if a field value must equal **1, 3 or 9**, you would enter a comparison value of **1,3,9**.



- Use **BETWEEN** to compare the **Criteria Field** to a range of values. For example, if a field value must be between **1** and **9**, you would enter a comparison value of **1,9**. Note, the comparison is inclusive of the low and high values.
- The next three fields control whether the related logical criteria cause the eligibility group to be considered true or false:
  - Use **If True** to control what happens if the related logical criterion returns a value of True. You have the options of **Group is true**, **Group is false**, or **Check next condition**. If you indicate **Group is true** or **Group is false**, the script is judged **Ineligible** or **Eligible** based on the values defined above in **If Group is False** and **If Group is True**.
  - Use **If False** to control what happens if the related logical criterion returns a value of False. You have the options of **Group is true**, **Group is false**, or **Check next condition**. If you indicate **Group is true** or **Group is false**, the script is judged **Ineligible** or **Eligible** based on the values defined above in **If Group is False** and **If Group is True**.
  - Use **If Insufficient Data** to control what happens if the related logical criterion returns a value of "Insufficient Data". You have the options of **Group is true**, **Group is false**, or **Check next condition**. If you indicate **Group is true** or **Group is false**, the script is judged **Ineligible** or **Eligible** based on the values defined above in **If Group is False** and **If Group is True**.

## Merging Scripts

Use the Script Merge page to modify an existing script by copying steps from other scripts. The following points summarize the many diverse functions available on the Script Merge transaction:

- You can use this transaction to renumber steps (assign them new sequence numbers).
- You can use this transaction to move a step to a different position within a script. When a step is moved, all references to the step are changed to reflect the new sequence number.
- You can use this transaction to delete a step.
- You can use this transaction to copy steps from other scripts. For example:
  - You may want to create a script that is similar to an existing script. Rather than copying all the information from the existing script and then removing the inapplicable steps, this page may be used to selectively copy steps from the existing script to the new script.
  - You may have scripts that are very similar, but still unique. You can use this transaction to build large scripts from smaller scripts. In this scenario, you may choose to create special 'mini' scripts, one for each of the various options that may make a script unique. Then, you could use the script merge page to select and merge the mini scripts that are applicable for a main script.

---

**NOTE:** The target script must exist prior to using this page. If you are creating a new script, you must first create the [Script](#) and then navigate to the merge page to copy step information.

---

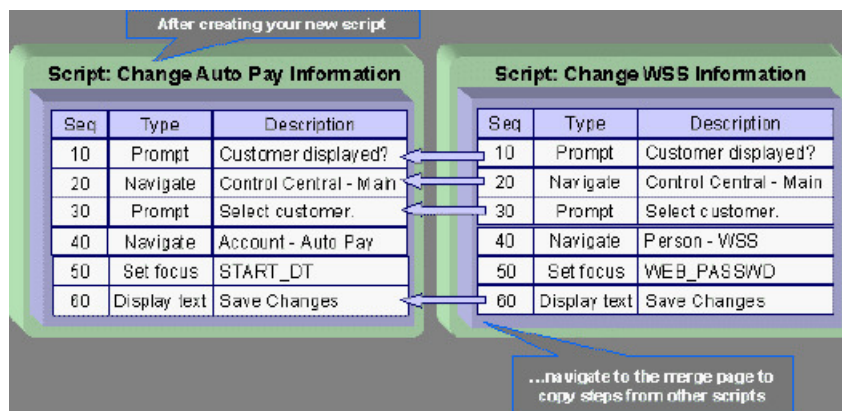

---

**NOTE: Duplicate versus Merge.** The [Script](#) page itself has [duplication](#) capability. You would duplicate a script if you want to a) create a new script and b) populate it with *all* the steps from an existing script.

---

## Script Merge

Open **Admin > System > Script Merge** to open this page.

### Description of Page

For **Original Script**, select the target script for merging steps.

For **Merge From Script**, select the template script from which to copy the steps.

---

**NOTE:** You may only copy steps from one Merge From script at a time. If you want to copy steps from more than one script, select the first Merge From script, copy the desired steps, save the original script, and then select the next Merge From script.

---

The left portion of the page displays any existing steps for the **Original Script**. The right portion of the page displays the existing steps for the **Merge From Script**.

You can use the **Copy All** button to copy all the steps from the **Merge From** script to the **Original** script. If you use **Copy All**, the steps are added to the end of the original script.

Each time you save the changes, the system renumbers the steps in the original script using the **Start From Sequence Number** and **Increment By**.

**Merge Type** indicates **Original** for steps that have already been saved in the original script or **Merge** for steps that have been merged, but not yet saved. The **Sequence**, **Step Type** and **Description** for each step are displayed.

The topics that follow describe how to perform common maintenance tasks:

### Resequencing Steps

If you need to resequence the steps:

- Use the up and down arrows in the Original Script grid to reorder the steps.
- Make any desired changes to the **Start From Sequence Number** or **Increment By**.
- Click Save.

The steps are given new sequence numbers according to their order in the grid.

### Removing a Step from Script







If you want to remove a record linked to the Original script, click the delete button, , to the left of the record.

For example, to remove the **Reset existing bundle XML** step, click the  icon.

		Merge Type	Sequence	Step Type	Description
	 	Original	10	Edit data	Edit data - Check that the BO is an Export Bundle
	 	Original	20	Edit data	Edit data - Read the Bundle
	 	Original	30	Edit data	Edit data - Reset existing bundle XML
	 	Original	40	Edit data	Edit data - Create new bundle XML



After removal, the grid displays:







		Merge Type	Sequence	Step Type	Description
		Original	10	Edit data	Edit data - Check that the BO is an Export Bundle
		Original	20	Edit data	Edit data - Read the Bundle
		Original	40	Edit data	Edit data - Create new bundle XML

**NOTE:** You cannot delete a step that is referenced by other steps unless you also delete the referencing steps, such as **Go to step** or **Prompt** type steps. The system informs you of any missing referenced steps when you attempt to save the original script.

### Adding a Step to a Script

You can move any of the steps from the Merge From script to the Original Script by clicking the left arrow adjacent to the desired step. Once a record is moved it disappears from the Merge From information and appears in the Original information with the word **Merge** in the Merge Type column.

For example, to copy the **Navigate to a page** step, click the left arrow.

Merge Type	Sequence	Step Type	Description
	 10	Height	Height - 0%
	 20	Move data	Move data - Copy 'APP_SVC_ID' to 'APP_SVC_ID'
	 30	Move data	Move data - Copy 'USR_GRP_ID' to 'USR_GRP_ID'
	 40	Navigate to a page	Navigate to a page - userGroupAppService
	 50	Conditional branch	Conditional branch - Compare ACTION with UPDATE
	 60	Press a button	Press a button - IM_scrollSec_add
	 70	Move data	Move data - Copy 'APP_SVC_ID' to 'UGP\$APP_SVC_ID'
	 80	Label	Label - End of Script

The step is moved to the left portion of the page.

		Merge Type	Sequence	Step Type	Description		Sequence	Step Type	Description
		Merge	40	Navigate to a page	Navigate to a page userGro		10	Height	Height - 0%
							20	Move data	Move data - Copy 'APP_SVC_ID' to 'APP_SVC_ID'
							30	Move data	Move data - Copy 'USR_GRP_ID' to 'USR_GRP_ID'
							50	Conditional branch	Conditional branch - Compare ACTION with UPDATE
							60	Press a button	Press a button - IM_scrollSec_add
							70	Move data	Move data - Copy 'APP_SVC_ID' to 'UGP\$APP_SVC_ID'
							80	Label	Label - End of Script

**NOTE:** If you add a step, such as **Go to step** or **Prompt** type steps, that references other steps, you must also add the referenced steps. The step references are updated to use the new sequence numbers when you save the original script. The system informs you of any referenced steps that haven't been added when you attempt to save the original script.

## Removing an Uncommitted Step from a Script

		Merge Type	Sequence	Step Type	Description		Sequence	Step Type	Description
		Merge	40	Navigate to a page	Navigate to a page userGro		10	Height	Height - 0%
							20	Move data	Move data - Copy 'APP_SVC_ID' to 'APP_SVC_ID'
							30	Move data	Move data - Copy 'USR_GRP_ID' to 'USR_GRP_ID'
							50	Conditional branch	Conditional branch - Compare ACTION with UPDATE
							60	Press a button	Press a button - IM_scrollSec_add
							70	Move data	Move data - Copy 'APP_SVC_ID' to 'UGP\$APP_SVC_ID'
							80	Label	Label - End of Script

## Maintaining Functions

**NOTE:** Functions were implemented prior to the introduction of business services (BS), service scripts (SS) and business objects (BO). The functionality is still supported, but the recommendation for implementations going forward is to use one of the above configuration tool objects in a script rather than defining a function. The documentation has not been updated throughout this section to highlight where BS, SS or BO could be used to perform the equivalent logic.

**Invoke function** steps may be used to retrieve or update data independent of the page currently being displayed. For example, if you design a script that takes different paths based on the customer's customer class, you could invoke a function to retrieve the customer's customer class. Doing this is much more efficient than the alternative of transferring to the account page and retrieving the customer class from the Main page.

An **Invoke function** step retrieves or updates the relevant data by executing a service (on the server). These types of steps do not refer to the service directly. Rather, they reference a "function" and the function, in turn, references the service.

---

**NOTE: Functions are abstractions of services.** A function is nothing more than meta-data defining the name of a service and how to send data to it and retrieve data from it. Functions allow you to define a scriptwriter's interface to services. They also allow you to simplify a scriptwriter's set up burden as functions can handle the movement of data into and out of the service's XML document.

---

The topics in this section describe how to set up a function.

---

**NOTE: You can retrieve data from all base-package objects.** If you know the name of the base-package "page" service used to inquire upon an object, you can retrieve the value of any of its fields for use in your scripts. To do this, set up a function that sends the unique identifier of the object to the service and retrieves the desired fields from it.

---

## Function - Main

Use this page to define basic information about a function. Open this page using **Admin > System > Function**.

### Description of Page

Enter a unique **Function** code and **Description** for the function.

Use the **Long Description** to describe, in detail, what the function does.

Define the **Internal Service** that the function invokes.

---

**NOTE:** In this release, only page services can be invoked.

---

Click the **View XML** hyperlink to view the XML document used to pass data to and from the service. Doing this causes the XML document to be displayed in the Application Viewer.

---

**NOTE: XML document may not be viewable.** If you create a new page service and do not regenerate the application viewer, you will not be able to view its XML document.

---

The tree summarizes the following:

- The fields sent to the service. You can use the hyperlink to transfer to the **Send Fields** tab with the corresponding field displayed.
- The fields received from the service. You can use the hyperlink to transfer to the **Receive Fields** tab with the corresponding field displayed.
- Scripts that reference the function. You can use the hyperlink to transfer to the script page.

## Function - Send Fields

Use this page to add or update the fields sent to the service. Open this page using **Admin > System > Function** and then navigate to the **Send Fields** tab.

---

**NOTE: Displaying a specific field.** Rather than scrolling through each field, you can navigate to a field by clicking on the respective node in the tree on the Main tab. Also note, you can use the Alt+right arrow and Alt+left arrow accelerator keys to quickly display the next and previous entry in the scroll.

---

---

**NOTE: You're defining the service's input fields.** On this tab, you define which fields are populated in the XML document that is sent to the service. Essentially, these are the service's input fields.

---

### Description of Page

Use **Sequence** to define the order of the **Send Fields**.

Enter a unique **Function Field Name** and **Description** for each field sent to the application service. Feel free to enter **Comments** to describe how the field is used by the service.

Use **Field Value Source** to define the source of the field value in the XML document sent to the service:

- If the field's value is the same every time the function is invoked, select **Defined On The Function**. Fields of this type typically are used to support "hard-coded" input values (so that the scriptwriter doesn't have to populate the field every time they invoke the function). Enter the "hard-coded" **Field Value** in the adjacent field.
- If the field's value is supplied by the script, select **Supplied By The Invoker**. For example, if the function retrieves an account's customer class, the script would need to supply the value of the account ID (because a different account ID is passed each time the function is invoked). Turn on **Required** if the invoker must supply the field's value (it's possible to have optional input fields).

Regardless of the Field Value Source, use **XML Population Logic** to define the XPath expression used to populate the field's value in the XML document sent to the service.

---

**NOTE: Usability suggestion.** You populate a field's value in an XML document by specifying the appropriate XPath expression for each field. Rather than referring to an XPath manual, the system can create the XPath expression for you. To do this, click the adjacent **View XML** hyperlink. This will display the XML document used to communicate with the **Service** defined on the Main page. After the XML document is displayed, click the **XPath** hyperlink adjacent to the desired field to see how the XPath expression looks. You can then cut / paste this XPath expression into the **XML Population Logic Field**.

---

## Function - Receive Fields

Use this page to add or update the fields received from the service. Open this page using **Admin > System > Function** and then navigate to the **Receive Fields** tab.

---

**NOTE: Displaying a specific field.** Rather than scrolling through each field, you can navigate to a field by clicking on the respective node in the tree on the Main tab. Also note, you can use the Alt+right arrow and Alt+left arrow accelerator keys to quickly display the next and previous entry in the scroll.

---

**NOTE: You're defining the application service's output fields.** On this tab, you define which fields are populated in the XML document that is received from the service. Essentially, these are the service's output fields.

---

### Description of Page

Use **Sequence** to define the order of the **Receive Fields**.

Enter a unique **Function Field Name** and **Description** for each field received from the service. Feel free to enter **Comments** to describe the potential values returned from the service.

Turn on **Required** if the invoker must use the field.

Regardless of the Field Value Source, use **XML Population Logic** to define the XPath expression used to retrieve the field's value from the XML document received from the service.

---

**NOTE: Usability suggestion.** You retrieve a field's value in an XML document by specifying the appropriate XPath expression for the field. Rather than referring to an XPath manual, the system can create the XPath expression for you. To do this, click the adjacent **View XML** hyperlink. This will display the XML document used to communicate with the **Service** defined on the Main page. After the XML document is displayed, click the **XPath** hyperlink adjacent to the desired field to see how the XPath expression looks. You can then copy / paste this XPath expression into the **XML Population Logic Field**.

---

**NOTE: Fields in multiple lists.** Note that the XPath expression generated in the application viewer refers to lists using a generic "list" reference. If a field within the list is unique across the service, the generic list reference is

sufficient for the XML population logic. However, if the field you are trying to reference is in multiple lists, the XPath must include the list name. Adjust the Application Viewer's generated XPath by adding the list name, which can be found in the overview panel in the Service XML viewer. For example, instead of `/pageBody/list/listBody/field[@name='FIELD_NAME']`, the XPath Population Logic must read `/pageBody/list[@name='LIST_NAME']/listBody/field[@name='FIELD_NAME']`.

---

## Mobile Application

This section describes various entities and aspects involved in the configuration of a mobile application.

## Understanding Mobile Devices

Laptops, cellular phones, tablets, and other mobile devices may be used to interface with the system via the supported mobile applications. The mobile application and data reside locally on the mobile device allowing the user to work offline as needed.

This section describes concepts related to device management administration.

## Mobile Platform

The mobile solution consists of a thin runtime installed on the device, the mobile application files, and metadata. The mobile applications are built using HTML5 and JavaScript on top of the Oracle Utilities Mobile Library (OUML) platform. The application communicates with the server via RESTful Services exposed by the main application.

The mobile applications require metadata (such as lookups, business object definitions and more ) to function. All files for all mobile application reside in a shared location on the server. It is the metadata that controls the behavior and functionality unique to each mobile application. The metadata package for each mobile application is also known as a deployment.

The URL entered at application startup is the URL used for both communication with the server and locating the mobile application HTML5 and JavaScript files. The deployment is downloaded once the user selects which mobile application they will be using.

Refer to [Understanding Deployments](#) for more information.

This approach makes it easier to push out applications changes to crews without having to reinstall the application on the device. The footprint on the device is kept to the minimal allowing the rest to be downloaded at start time from the server. The thin runtime can be downloaded from the application store and is assumed to be rarely updated. Customers can make as many changes as they like to the application HTML5 and JavaScript files without having to physically reinstall anything on the device.

## Mobile Device Terminals (MDT)

You must create an MDT record for each physical device that will use a mobile application to communicate with the main server application. The MDT record has to be uniquely identified by a device tag.

The product provides a replicator tool on the MDT portal that may be used to create many MDT records that share the same device tag prefix.

An MDT Type defines attributes common to mobile devices of a certain type such as synchronization settings, attachment maximum size, and so on.

## Registration

The first time a mobile user runs the mobile application, they will be required to register their mobile device.

The system will ask for the MDT Tag and the URL of the server application. The MDT Tag is a unique, user-defined identifier that is assigned to the device when the MDT record is created on the server application.

As part of the registration process, the system posts the device's unique ID on the MDT record on the server. Various mobile platforms like iOS, Android, and Windows provide a system level API to get the device's unique hardware ID which is used as the device's unique ID.

Once the device is registered, the mobile user will be able to log on to the application from that device without further prompting.

All the platforms return the same ID consistently, except for iOS that assigns a unique ID for the application when it is installed. This means that for iOS, the MDT's unique ID changes each time the application is uninstalled and installed again. In this situation, you would need to reset the unique ID stamped on the MDT record after reinstalling the application. Use the **Reset Registration** action on the MDT portal to do so.

## Managing Attachments

The MDT Type may also set a limit for the total size for attachments on mobile devices of that type. When a user attempts to download an attachment, the system validates that the total size of the download plus what is already on the mobile device will not exceed the maximum for the mobile device.

The total size specified should take into account common attachments that are included as part of the mobile application [deployment part](#) configuration. These are automatically downloaded along with the mobile application.

When using the mobile application you may also limit the size of individual image attachments captured in the field by different device types by setting an attachment size restriction on the MDT type.

## Device Data Encryption

You have the option of enabling or disabling data encryption globally as well as for specific devices.

Use the **Data Encryption** parameter on the **Mobile Configuration** ([master configuration](#)) record to turn device data encryption on or off globally.

Each MDT has a data encryption setting which you can set to either use the global default, or turn it on or off for this device.

## Understanding Mobile Application Files

The mobile application consists of the Oracle Utilities Mobile library and application layers responsible for specific business functionality. It uses HTML5 and JavaScript to implement business logic, render the user interface and interact with mobile device services. RESTful services facilitate communication between the mobile application and the application server.

The following diagram illustrates the mobile application architecture in a high level.

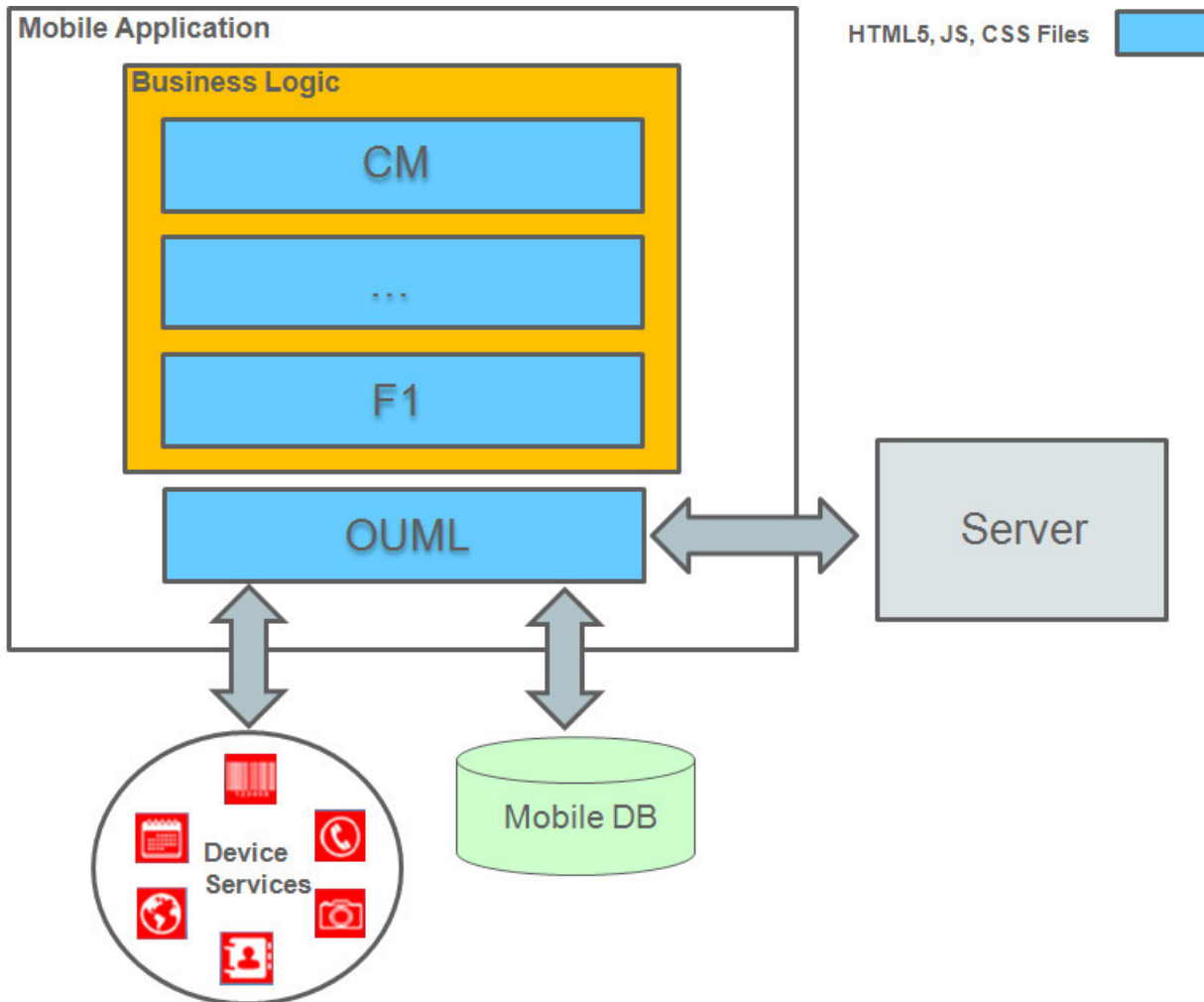

Figure 5: Mobile Application Architecture

The following sections describe concepts related to the mobile application solution as well as how your implementation may extend it to meet your mobile application requirements.

## Oracle Utilities Mobile Library (OURL)

The Oracle Utilities Mobile Library provides a foundation layer and APIs for application development including offline storage, encryption, communication, logging, configuration, UI rendering, navigation, customization, deployment and so on.

The library of APIs is optimized to work with Oracle Utilities Application Framework (OUAF) based services, configurations and metadata mainly around supporting the notion of business objects.

Inbound and outbound communication between the mobile application and server is based on RESTful services and JSON payload. Messages to the server are stored in the device's local database and then forwarded to the server. In situations where device is offline at the time of making an outbound request the communication module of the mobile application ensures the delivery of the message when device is back online and communication with server is reestablished.

## Business Logic Resides in Mobile Components

Business logic supporting the various types of mobile application deployments is implemented in the form of mobile components of the following types:

- Standalone pages.
- Business objects.
- Shared components include:
  - **Business Object Status Enter and Post Processing** plug-ins. These implement business rules triggered when a business object transitions to a new state in its lifecycle or updated respectively. The same plug-in may be associated with multiple business objects.
  - Services. A service implements an independent function that can be called from various places in the application.
  - UI Sections. These model reusable form sections that can be references on multiple pages.
- A library of common functions. Implements a library of functions that can be shared across the application.
- Message to device. Implements a type of message that is sent from the server to be processed on a mobile device.
- Product Configuration. Defines global settings for the mobile application.
- Themes. Defines swatches and styles for the mobile application.

The following sections describe how mobile components are implemented and used.

## Mobile Component Ownership

Mobile components are system-owned records stored in a designated maintenance object. The base product is released with all the necessary mobile components needed to support its mobile applications.

You may implement new custom mobile components to meet your organization's mobile application requirements.

As a rule, only the component's owner is allowed to change and delete it. However, some types of components allow custom extensions where custom content may be added to base components. For example, you may customize a base owned business object mobile component to add more plug-ins when it transitions to a specific state, etc.

## Mobile Component Editor

Mobile components are implemented using a browser-based editor. Use the Mobile Component portal to author custom mobile components as well as extend the content of base components.

## Packaged by a Batch Process

The source of mobile components is stored in the database and as such can be migrated from one environment to another using standard tools such as Bundling and CMA.

The mobile application requires this content (HTML, JavaScript and CSS etc) to be available in the form of files. The **Build Mobile Component Package** batch process needs to run to generate files based on mobile component content and package them into an application bundle file on a shared location on the server. The bundle is downloaded when the application is launched from the mobile device.

The following illustration shows how mobile components are converted to files and packaged along with the OUML files as the mobile application bundle.



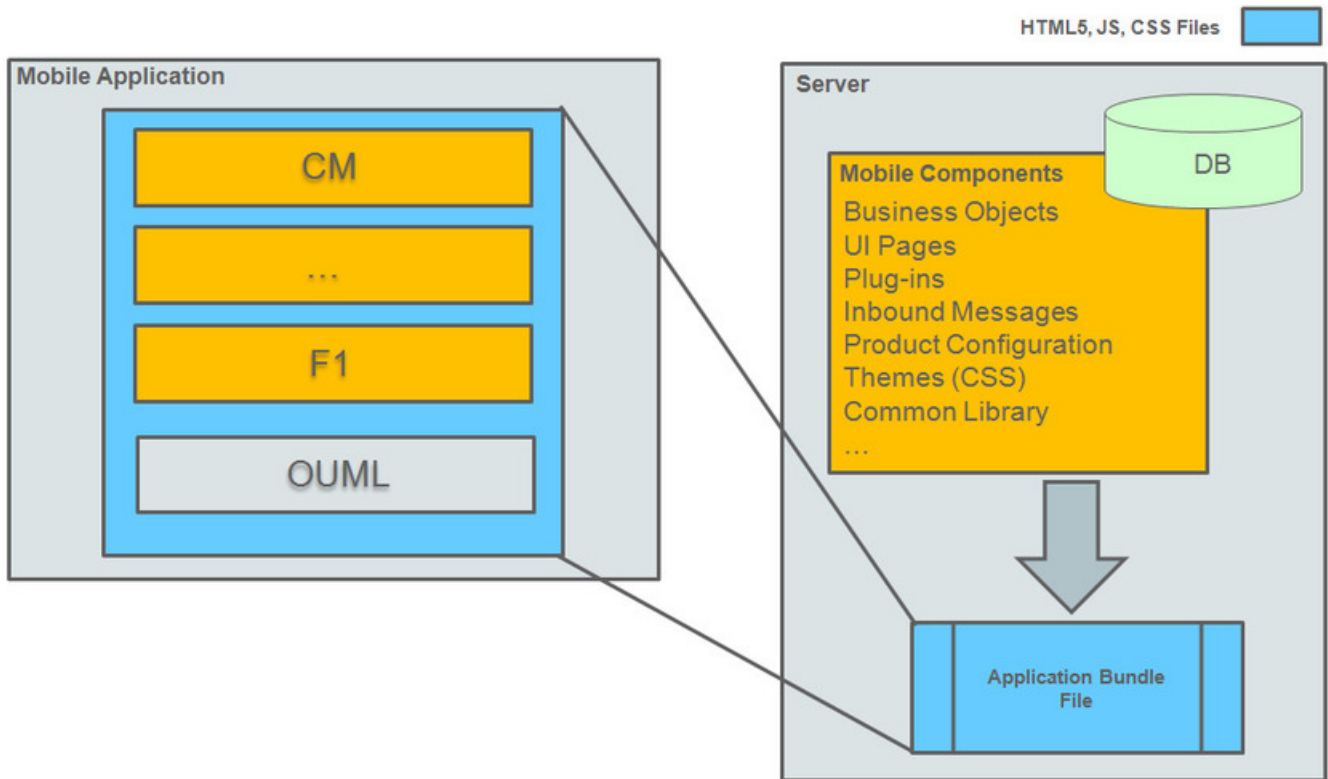

Figure 6: Mobile Application Bundle

**NOTE:** The **Build Mobile Component Package** batch process should run on demand to package the mobile application bundle as a zip file. Refer to [FI-BMCOM](#) batch control for more information.

## Testing

The mobile application is packaged and deployed as a client application in the format native to the supported runtime platforms. The files in the mobile application bundle are downloaded to the mobile device when the client application is launched.

The following illustration describes how to test the mobile application on a mobile device.

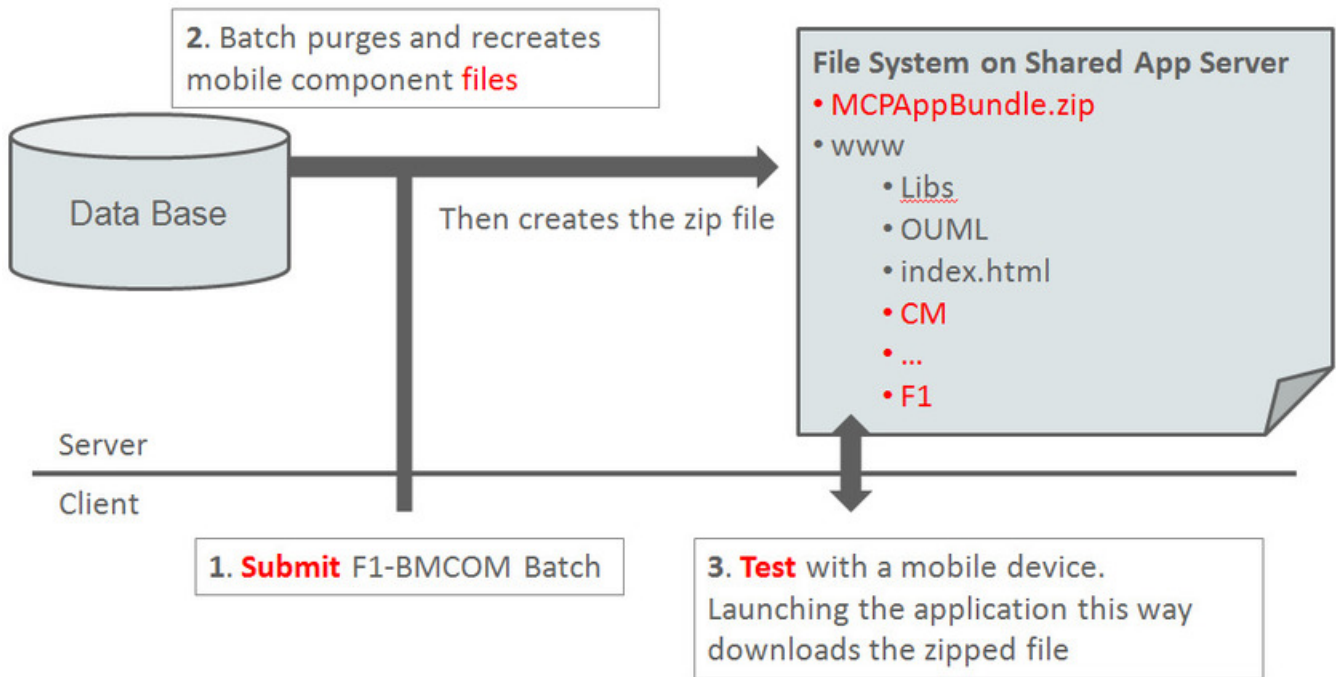
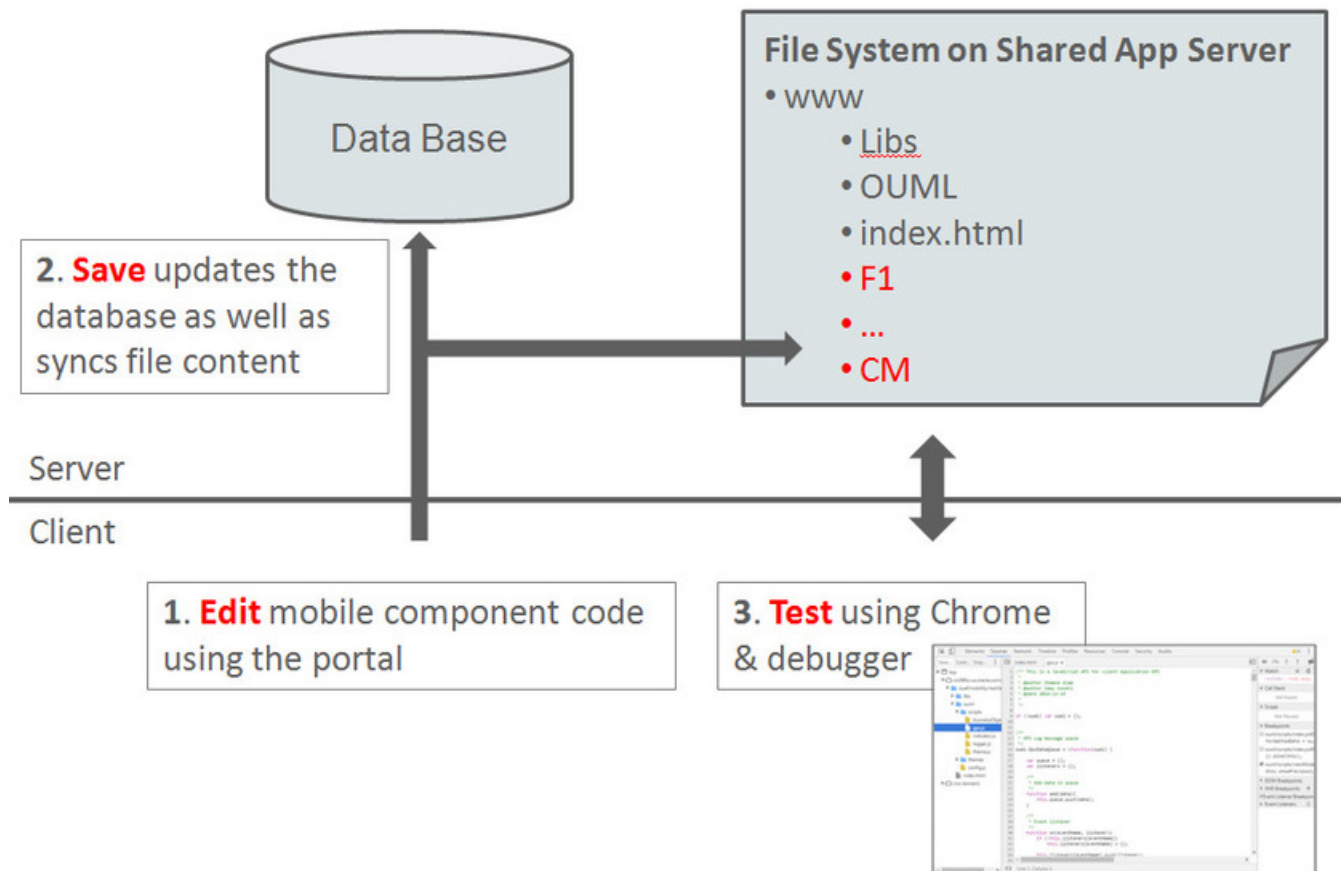

**Figure 7: Mobile Device Testing Illustration**

For testing and development purposes, the mobile application files be directly accessed as a web application using Chrome browser. This approach does not require the files to be bundled.

To simplify browser-based testing in a shared application server, content changes made via the mobile component editor are also automatically synced to the corresponding file in the shared file system. You do not need to run the packaging batch process when testing this way.

The following illustration describes this process.



**Figure 8: Shared Development/Testing Illustration**

Use these steps to test the application using Chrome:

- If not already installed, install the Google Chrome desktop browser.
- Create a shortcut to the executable on your desktop.
- Right-click the shortcut and choose Properties, then append the following to the Target property to disable cross-domain JavaScript security:

```
--user-data-dir="C:/Chrome dev session" --disable-web-security --allow-file-access-from-files --allow-file-access
```

- Start Chrome via the shortcut and load the mobile application at: `http://server:port/ouaf/mobility/rest/test/www/index.html`

Note that certain device specific features, such as barcoding, capturing a picture, etc., are not available when the application is accessed this way. Testing these features must be done using the native application.

**WARNING:** Chrome must **NOT** be used in a production environment. It is only certified to be used for development and debugging purposes.

## Understanding Deployments

A deployment refers to a specific cut of application metadata and control records needed to support a mobile application of a specific type and language. The deployment is downloaded to the mobile device terminal (MDT) by the corresponding mobile application.

This section describes topics related to managing mobile application deployments.

## Deployment Types

A deployment type represents the configuration needed to support an application of a given type. You can configure multiple types of applications by setting up a deployment type for each.

A deployment type configuration defines the following aspect of the mobile application:

- The application items included in the application, by referencing deployment parts.
- The initial function that starts the business flow on the device when the application is launched.
- The MDT Types compatible to run this type of application.
- The authorized user groups that are allowed to use the mobile application.
- The application message categories used by the mobile application.

## Deployment Parts

Deployment parts provide a way to create reusable groups of application items. A deployment part is a collection of application components, such as business objects, lookups, task types, and many more that are needed to support the mobile application.

The base product provides preconfigured deployment parts that include the base mobile application components. You only need to configure parts to include your custom entities. Make sure to include your custom deployment parts as part of your deployment type setup.

Create deployment parts to represent subsets of your custom deployment items based on their type or usage. You should share deployment parts across deployment types when applicable to prevent redundancy and improve management of deployment configuration. For example, use a designated deployment part for control data, another for items that are common across platforms, another with user interface items for a specific platform etc.

To simplify the collection of items in a deployment part it is recommended that you create an export bundle per deployment part so that implementations can add their new or changed items directly to the corresponding bundle using the dashboard zone. Once items are collected, the bundle can be uploaded to the deployment part. You can always maintain items manually on a deployment part.

Consider where attachments must be automatically pushed to the mobile application as part of the deployment and add them to your deployment parts.

## Deployment

A deployment can only be created using the **Create Deployment** batch process. Once your deployment type setup is complete, submit the batch to create a new deployment for your deployment type for a specific language.

By default, once the batch job runs and the deployment has been created, it has to be manually activated on the deployment portal before it can be deployed to any devices. Alternatively, you may set a batch parameter to automatically activate the new deployment.

---

**NOTE:** The **Create Deployment** batch process should run on demand or periodically based on your business needs to avoid situations where out of dates deployments are being used. Refer to [FI-DPLOY](#) batch control for more information.

---

## Out of Date Deployments

Deployments become out of date when a new mobile application version is released, the deployment type configuration changes, or any underlying application component that is part of the configuration changes.

Mobile users are warned at login to their mobile device that they are using an out of date deployment. The user is allowed to continue, but is advised to contact their administrator to synchronize their deployment. Refer to [Downloading Deployments](#) for more information.

The product provides a batch process that evaluates existing active deployment records and marks those that are out of date if it detects any metadata changes. The background process also purges out of date deployments that are older than a specified number of days.

---

**NOTE:** The **Deployment Evaluation and Purge** batch process should run on demand or periodically based on your business needs to avoid situations where out of dates deployments are being used. Refer to [F1-DPUTD](#) batch control for more information.

---

Also note that as part of accepting a new product release, all existing deployments are marked as out of date. New deployments are required to be created and activated.

When an active deployment is marked out of date, the system creates a To Do entry in order for a user to create a new deployment as needed. Creating a new deployment for the same deployment type and language automatically closes any remaining To Do entries reported for out of date deployments for the same configuration.

## Downloading Deployments

Once a deployment has been activated, it is available for download to mobile devices. When the mobile user logs on to the mobile application, the system looks for the most recent version of all active, qualified deployments based on the user's user group, language, and MDT type.

If no deployments are found, the system displays an authorization error message and prevents the user from continuing.

If only one deployment is found and it is the same as the one currently deployed, then the deployment is not downloaded.

If only one deployment is found and it is newer than the one currently deployed or there is none currently deployed, then the deployment is downloaded to the mobile device.

If more than one deployment is found, the user can select the one they want to download.

---

**NOTE:** A new deployment will not be downloaded if unprocessed data from a previous shift still exist on the device. The system warns that user of the situation. If the user is authorized to use the deployment currently on the device, it will be used; otherwise, an authorization error will be displayed

---

## Setting Up Deployments

This section summarizes steps involved in configuring your deployment types:

- Review the various types of devices that needs to be supported and set up corresponding MDT types.
- Define MDT records for each mobile device.
- Create deployment parts to represent subsets of your custom deployment items based on their type or usage.
- Set up a deployment type for each type of application you need to support. For example, the product supports a mobile application for a crew to work their schedule, and another application for a contractor worker.
- Specify the deployment parts and message categories needed to support the application.

- List applicable MDT Types.
- Identify the user groups authorized to use the application and associate them with the deployment type.
- When you have finished defining each deployment type, you need to run the **Create Deployment** batch process to create a deployment for it for each language supported by your company. Refer to [F1-DPLOY](#) batch control for more information.
- Activate each deployment, if not already activated by the batch process.

## Mobile Application Versioning

The mobile application communication architecture involves both client side and server side elements. When a deployment is created on the server, it is marked with the version number of the server side mobile application components that created it. The same version number is also stamped on the mobile application bundle when generated on the server. The version of these elements on the device must match the latest version on the server else errors will occur.

With each new product version, existing deployments stamped with the older version are marked as out of date and existing application bundles are deleted. New deployments need to be created and activated and a new application bundle must be regenerated with each product upgrade.

---

**NOTE:** The **Create Deployment** batch process should run to create a new deployment for each mobile application type and language applicable to your organization. Refer to [F1-DPLOY](#) batch control for more information. Once created, each deployment should be activated.

---

**NOTE:** In addition, the **Build Mobile Component Package** background process should run to regenerate the mobile application bundle. Refer to [F1-BMCOM](#) batch control for more information.

---

To enforce compatibility, the system validates the mobile application version as follows:

- Only deployments and application bundles that are compatible with the server mobile application version can be downloaded.
- When the mobile device attempts to connect to the server, the system checks whether or not the mobile application version already on the device is compatible with the mobile application version on the server. If the versions are not compatible, the device is not allowed to work online and no communication is sent to and from the server. In this situation, the mobile device must be upgraded to the correct version before it can work online again. If there was data on the mobile device, the user can continue offline and manually collect any data they need before the mobile device is upgraded.

---

**NOTE:** Before the server is upgraded, all users using the mobile application must be allowed to end their work successfully from their mobile devices and logoff. This prevents the incompatible version situation described above.

---

The **About** section on the **Settings** menu option on the mobile device shows the mobile application version number. This version is also stamped on the MDT record on the online mobile device screen.

## Configuring Mobile Devices

The following section describes mobile device configuration options.

### Defining MDT Types

This portal is used to maintain MDT types.

Refer to [Understanding Mobile Devices](#) for more information.

You can access the portal from the **Admin Menu > Mobile > MDT Type**.

The following zones may appear as part of the portal's **Main** tab page

- **MDT Type List**. This zone lists all MDT types. Broadcast a record to display the details of the selected deployment part.
- **MDT Type**. This zone provides information about the selected MDT type.

#### Where Used

Follow this link to open the data dictionary where you can view the tables that reference [FI\\_MDT\\_TYPE](#).

## Defining MDTs

This portal is used to display and maintain a mobile data terminal (MDT). You need to define a mobile data terminal (MDT) record for each mobile device that needs to communicate with the system to send and receive work using the mobile application.

You can access the portal from the **Admin Menu > Mobile > MDT**. You are brought to a query portal with options for searching for a specific MDT. Once an MDT has been selected you are brought to the maintenance portal to view and maintain the selected record.

Refer to [Understanding Mobile Devices](#) for more information.

The **MDT** zone on the portal's **Main** tab page provides information about the mobile device.

The following zones may appear as part of the portal's **Log Files** tab page:

- **Mobile Log Files Search**. This zone allows you to search for log files that may have been sent in from the mobile device to a designated location on the sever.
- **Mobile Log**. This zone shows server logging information related to communications made using this mobile device, if this feature is enabled from the mobile device.

## Replicate MDTs

You may use the **Replicate** button set up a bulk of MDT records based on the details of the current MDT. This function sets the device tag for each new MDT to the prefix text you provide and a running sequence number.

## Getting the MDT Log Files

Log files are not sent to the server automatically; they are only sent on demand, usually for debugging or tracing purposes. Use the **Get Log Files** button to send a message to the device to send log files to the server. When the device sends the files, you may use the **Log Files** tab to view their content.

## Changing the Mobile Device Log Level

Click the **Set Log Level** button to send a request to the device to change the logging level used by the mobile application. Once the mobile device is updated, it sends a response back to the server to update the current log level on the MDT record to reflect the change.

## Reset Registration

If this MDT is used by an iOS device and the mobile application was reinstalled on the device, the unique ID has to be reset before the MDT can be used again. Click the Reset Registration button to do so.

Refer to [Registration](#) for more information.

## Configuring Deployment Options

The following section describes mobile device configuration options.

## Defining Deployment Parts

This portal is used to maintain deployment parts. You may upload a predefined bundle when adding or updating a deployment part.

Refer to [Understanding Deployments](#) for more information.

You can access the portal from the **Admin Menu > Mobile > Deployment Part**.

The following zones may appear as part of the portal's **Main** tab page

- **Deployment Part List.** This zone lists all deployment parts. Broadcast a record to display the details of the selected deployment part.
- **Deployment Part.** This zone provides information about the selected deployment part.
- **Deployment Items.** This zone lists the application items included in this deployment part.
- **Referenced By Deployment Types.** This zone lists the deployment types referencing this deployment part.

---

**CAUTION:** Important! If you introduce a new deployment part, carefully consider its naming convention. Refer to [System Data Naming Convention](#) for more information.

---

### Where Used

Follow this link to open the data dictionary where you can view the tables that reference [FI\\_DEPLOYMENT\\_PART](#).

## Defining Deployment Types

A deployment type represents a specific type of mobile application. This portal is used to maintain deployment types.

Refer to [Understanding Deployments](#) for more information.

You can access the portal from the **Admin Menu > Mobile > Deployment Type**.

The following zones may appear as part of the portal's **Main** tab page

- **Deployment Type List.** This zone lists all deployment types. Broadcast a record to display the details of the selected deployment type.
- **Deployment Type.** This zone provides information about the selected deployment type. You may use the **New Deployment** link to submit the batch process to create a new deployment.

### Where Used

Follow this link to open the data dictionary where you can view the tables that reference [FI\\_DEPLOYMENT\\_TYPE](#).

## Maintaining Deployments

This portal is used to view existing deployments and change their status.

---

**NOTE:** A deployment has to be activated before it can be downloaded to mobile devices. You can also inactivate a deployment so that it can no longer be deployed.

---

Refer to [Understanding Deployments](#) for more information.

You can access the portal from the **Admin Menu > Mobile > Deployment**. You are brought to a query portal with options for searching for a specific deployment. Once a deployment has been selected you are brought to the maintenance portal to view and maintain the selected record.

The **Deployment** zone on the portal's **Main** tab page provides information about the mobile device.



The following zones may appear as part of the portal's **Main** tab page

- **Deployment.** This zone provides information about the selected deployment.
- **Out of Date Items.** This zone lists items that have changed and caused the deployment to become out of date. Expand the zone to request the system to evaluate the deployment now. If the deployment is out of date, it is marked as such and the zone lists the out of date items information.

## Defining Mobile Components

This portal is used to maintain mobile components. You may use this portal to review the base components as well as extend them or implement new custom mobile components to support your mobile application requirements.

---

**NOTE:** You need to run the **Build Mobile Component Package** background process to include your custom mobile component content as part of the application bundle that is downloaded when the mobile application is launched from a mobile device. Refer to [FI-BMCOM](#) batch control for more information.

---

Refer [Understanding Mobile Application Files](#) for more information.

You can access the portal from the **Admin Menu > Mobile > Mobile Component**.

The following zones may appear as part of the portal's **Main** tab page:

- **Mobile Component.** This zone provides general information about the selected mobile component.
- **Mobile Component Content Editor.** This zone is used to maintain the various contents associated with the selected mobile component.

---

**CAUTION:** Important! If you introduce a new mobile component, carefully consider its naming convention. Refer to [System Data Naming Convention](#) for more information.

---

### Where Used

Follow this link to open the data dictionary where you can view the tables that reference [FI\\_MOBILE\\_COMPONENT](#).

## Mobile Application Master Configuration

The **Mobile Configuration** ([master configuration](#)) record defines several system wide settings related to mobile application functionality. For more information about specific fields in the master configuration, refer to the embedded help.

## Attachments

Some implementations may require that attachments be available from the application. These attachments can be stored in the Attachment table and then linked to other objects if applicable.

## Attachment Overview

The following topics provide additional information regarding attachment functionality.

### Attachment Types

The system supports several different attachment content types, for example:

- PDF Document
- Excel Spreadsheet

- Jpeg Image
- Text Document

The attachment data itself may be text or binary. When storing the data in the application however, it is stored as text information only. As a result, the upload of an attachment that is a binary type requires a conversion prior to storing the data. When viewing the attachment, the data is converted again for display.

Each type of attachment is defined using an attachment business object. The business object includes configuration defining the supported file extensions, whether the data is binary or not and the content type that represents the type of data for the attachment.

---

**NOTE:** To view the attachment business objects provided with the base product, navigate using **Admin > Business Object > Search** and search for business objects related to the Maintenance Object for Attachments (**F1-ATCHMT**).

---

## Owned Attachments

Attachments can be either ‘owned’ or ‘common’. An owned attachment is one that is related to a specific record. For example, the specific test results for a given device can be uploaded and linked to that device or to its test records. These types of attachments are typically uploaded and maintained via the object that owns it.

## Common Attachments

Common attachments are ones that are uploaded independent of any transaction in the system. They can be used for general system or company information. Or they can be linked to more than one transaction. For example, instructions for performing a certain type of task can be uploaded as an attachment and linked to a task type where those instructions are relevant. These types of attachments are uploaded and maintained in the central Attachment portal. Objects that may refer to the attachments may link the attachments via characteristics or some other appropriate mechanism.

## Emailing Attachments

The system supports a business service that may be used by system processing to send an email. The business service **F1-EmailService** supports receiving the IDs of one or more attachments as input parameters.

Refer to [Sending Email](#) for more information.

## External Reference

Attachment records may be added from an external system in which case, the external system could have a reference ID to capture. The attachment allows for including an external reference ID when adding an attachment internally.

## Configuring Your System for Attachments

In order to link attachments to objects in the system, there may be some configuration or implementation required to support the link. It is possible that one or more objects in your product already support attachments out of the box. Consult the product documentation for the specific object for confirmation. For objects in the system that do not support attachments out of the box, the following sections provide some guidelines for enabling support for attachments. Contact product support for more information.

## Supporting Common Attachments

The attachments themselves are created / uploaded using the attachment portal. Refer to [Maintaining Attachments](#) for more information.

If your implementation has a use case where one or more common attachments may be linked to an object (and the object does not already support this functionality), the object may need to be extended to capture the attachments.

- If the object includes a characteristic collection, this is a recommended way to capture attachments. A characteristic type should be defined for each type of attachment. The characteristic type should be a foreign key type and should reference the Attachment FK reference. The characteristic entity collection should include the object that the common attachment will be linked to.
- Most characteristic collections are sequence based characteristics and would support multiple entries for the same characteristic types, if multiple attachments are applicable.
- If the object to support the attachments is governed by a business object, the implementation must extend the business object to define one or more appropriate elements used to capture the attachments. If only one attachment of a certain type is allowed, a single flattened characteristic may be used. If multiple attachments of a certain type are allowed, the BO schema may define a “flattened list” exposing the sequence and the characteristic type.
- If the object is maintained on a “fixed page” with a generic characteristic collection, no additional configuration is needed to allow users to link attachments to that object.

## Supporting Owned Attachments

When creating an attachment for a specific record, the attachment itself captures the information about the related record, namely its maintenance object code and its primary key. For these types of attachments, no configuration is needed on the related business object to capture the attachments, as was the case with common attachments.

However, it is recommended to configure the user interface of the related object so that the owned attachments can be viewed and maintained from that page. To do this, you may use the generic attachment zone provided by the product: **F1-ATTCHOWN**.

Note that your product may already have support for viewing and maintaining owned attachments on one or more of its base delivered portals.

## Configuring Size Limit

The system allows for configuration of a size limit for uploading attachments. This is optional but the recommendation is to set this to a reasonable value so as to limit the ability to upload unreasonably big files. To configure this, navigate to [Feature Configuration](#). Search for an existing feature configuration with the Feature Type **General System Configuration**. If one does not exist, create a feature configuration of this type. Select the **Maximum Attachment Size** option and define an appropriate value.

## Defining a New Attachment Type

As mentioned, the product provides support for several content types. If your implementation needs to support attachments for a content type not currently supported, create a new business object copying the configuration of an existing attachment business object.

Configure the following option types for the BO:

- **Binary** indicates whether the attachment data must be converted from binary format. Binary attachments are stored in the database as text, and are then converted back to the original format when retrieved.
- **Content Type** represents the browser's mime type of the attachment.
- **Supported File Extension** specifies the valid file extensions for the content type.

Once the business object is defined, it is ready for use.

## Supporting File Name Exceptions

By default, the system prevents attachment file names from having special characters. If there is some reason that an implementation needs to define an attachment with special characters, there is a system property setting that may be configured to relax this validation. Contact your system administrator for support.

## Maintaining Attachments

This section describes the functionality supported for viewing and maintaining attachments.

Navigate using **Admin > General > Attachment**. You are brought to a query portal with options for searching for common attachments.

Once an attachment has been selected, you are brought to the maintenance portal to view and maintain the selected record.

---

**NOTE:** The base search options for the attachments query only support searching for common attachments. Owned attachments may also be viewed on the attachment maintenance portal, but a user may only drill into the attachment maintenance from the maintenance portal of the “owning” entity.

---

The Attachment zone provides basic information about an attachment, including the ability to upload the file and to view an uploaded file.

## Adding Attachments

Common attachments may be added from the attachments portal (or via the standard menu path). In addition, your product may support attachments associated with specific records (“entity owned attachments”) which may also provide the capability to add attachments.

In both cases, when adding an attachment, you are prompted for the file to upload. Once the file is chosen, the system determines the appropriate business object to associate with the attachment based on the file extension. Typically one and only one business object is found at which point you are prompted to provide the Attachment Name. (Your specific product may also require additional information at this time). Fill in the details and save.

Please note the following:

- If no business object is found for the uploaded file’s file type, an error is issued. This type of file is not currently supported as an attachment.
- If multiple business objects are found, the user must choose the appropriate one. This should be rare.

## Application Viewer

The Application Viewer allows you to explore meta-data driven relationships and other deliverable files online.

---

**NOTE: Running Stand-Alone.** You can also launch the Application Viewer as a stand-alone application (i.e., you do not need to start it from within the system). Refer to [Application Viewer Stand-Alone Operation](#) for more information about running the Application Viewer as a stand-alone application.

---

To open the application viewer from within your application, navigate to **Admin > Implementation Tools > Application Viewer**. The application viewer may also be launched from other locations for example when viewing a section of the online help files that contain hypertext for a table name, clicking on that hypertext brings you to the definition of that table in the data dictionary.

## Application Viewer Toolbar

The Toolbar provides the main controls for using the Application Viewer. Each button is described below.

## Data Dictionary Button



The **Data Dictionary** button switches to the Data Dictionary application.

## Physical and Logical Buttons



The **Physical** button changes the display in the List Panel from a logical name view to a physical name view. Note that the Tables are subsequently sorted by the physical name and therefore may not be in the same order as the logical name view. Once clicked, this button toggles to the Logical button.

The **Logical** button changes the display in the List Panel from a physical name view to a logical name view. Note that the Tables are subsequently sorted by the logical name and therefore may not be in the same order as the physical name view. Once clicked, this button toggles to the Physical button.

These buttons are only available in the Data Dictionary.

## Collapse Button



The **Collapse** button closes any expanded components on the list panel so that the child items are no longer displayed.

This button is only available in the Data Dictionary viewer.

## Attributes and Schema Button

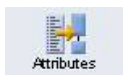

The **Attributes** button changes the display in the Detail Panel from a related tables view to an attribute view. Once clicked, this button toggles to the Schema button.



The **Schema** button changes the display in the Detail Panel from an attribute view to a related tables view. Once clicked, this button toggles to the Attributes button. Note that only tables have this view available. Columns are always displayed in an attribute view.

These buttons are only available in the Data Dictionary.

## Maintenance Object Button



The **Maintenance Object** button switches to the Maintenance Object viewer application.

## Algorithm Button



The **Algorithm** button switches to the Algorithm viewer application.

## Batch Control Button

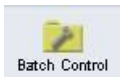

The **Batch Control** button switches to the Batch Control viewer application.

## To Do Type Button



The **To Do Type** button switches to the To Do Type viewer application.

## Description and Code Buttons



The **Description** button changes the display in the List Panel to Description (Code) from Code (Description). Note that the list is subsequently sorted by the description. Once clicked, this button toggles to the Code button.

The **Code** button changes the display in the List Panel to Code (Description) from Description (Code). Note that the list is subsequently sorted by the Code. Once clicked, this button toggles to the Description button.

These buttons are only available in the Batch Control and To Do Type viewers.

## Service XML Button



The **Service XML** button switches to the Service XML viewer. This button is not available when you are already in the Service XML viewer.

You are prompted to enter the name of the service XML file you want to view. The name of the service XML file should be entered without the extension.



## Select Service Button



The **Select Service** button loads another service XML file that you specify. This button is only available in the Service XML viewer.

You are prompted to enter the name of the service XML file you want to view. The name of the service XML file should be entered without the extension.

## Java Docs Button



The **Java Docs** button switches to the Java Docs viewer.

## Groovy Java Docs Button



The **Groovy Java Docs** button switches to the Groovy Java Docs viewer.

## Classic Button



This button is only available in the Java Docs viewer.

The **Classic** button launches the classic Javadocs viewer on a separate window. If you are more comfortable with that look you can use this viewer instead.

## Preferences Button



The **Preferences** button allows you to set optional switches used by the Application Viewer. Refer to [Application Viewer Preferences](#) for more information.

## Help Button



The **Help** button opens the Application Viewer help system. You used this button to access this information.

## About Button



The **About** button opens a window that shows when was each Application Viewer data component recently built.

Data for all application viewer components may be regenerated to incorporate up-to-date implementation-specific information. Refer to [Application Viewer Generation](#) for further details.

## Slider Icon



This "slider" icon allows you to resize the list panel and detail panel to your preferred proportions.

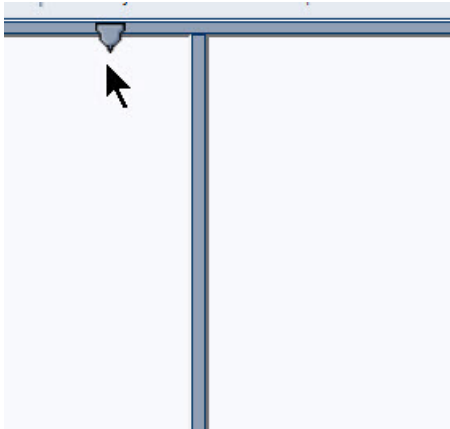

## Data Dictionary

The data dictionary is an interactive tool that allows you to browse the database schema and to graphically view relationships between tables in the system.

To open the data dictionary, click the [Data Dictionary button](#). You can also open the data dictionary by clicking the name of a table in other parts of the application viewer or in the online help documentation.

---

**NOTE: Data Is Generated.** A background process generated the data dictionary information. Refer to [Application Viewer Generation](#) for further details.

---



## Using the Data Dictionary List Panel

The list panel displays a list of tables and their columns. The list panel can list the table names by either their logical names or their physical names. Click the appropriate [button](#) on the toolbar to switch between the two views. The list is displayed in alphabetical order, so the order may not be the same in both views. Both views function in a similar manner.

In the list panel, you can navigate using the following options:

- Click the right arrow icon to expand a table to show its columns.
- Click the down arrow icon to collapse the column list for a table. Optionally, collapse all column lists by using the **Collapse** button.
- Click the column name to display information about the column in the detail panel.
- If the detail panel is in [related table](#) view, click the table name to view its related tables. If the detail panel is in [table detail](#) view, click the table name to display its information.

## Primary And Foreign Keys

The columns in the list panel may display key information as well as the column name:

- A yellow key indicates that the column is a primary key for the table.
- A light blue key indicates that the column is a foreign key to another table. If you hover the cursor over the icon, the tool tip indicates the foreign table.
- A dark blue key indicates that the column is a conditional foreign key. A conditional foreign key represents rare relationships between tables where a single field (or set of fields) may reference multiple primary key constraints of other tables within the application as a foreign key.
- A red key indicates that the column is a logical key field. A logical key represents an alternate unique identifier of a record based on a different set of fields than the primary key.

If you hover your cursor over an icon, the tool tip indicates the key type.

## Field Descriptions Shown

The language-specific, logical name of each field is shown adjacent to the physical column name in the data dictionary. You can enter an override label for a [table / field's](#) to be used throughout the system as the field's logical name. Here too it is the override label that is shown.

---

**NOTE: Regenerate.** You should regenerate the data dictionary after overriding labels. Refer to [Application Viewer Generation](#) for further details.

---

## Using the Data Dictionary Detail Panel

The Data Dictionary detail panel displays the details of the selected item. There are three main displays for the Detail Panel:

- Related tables view
- Table detail view
- Column detail view

## Related Tables View

The Related Tables view displays information about the table's parent tables and child tables. Click the [Schema](#) button in the toolbar to switch to related tables view.

In the related tables view, you can navigate using the following options:

- Click the left arrow and right arrow icons to view the related tables for that linked table. The List Panel is automatically positioned to the selected table.
- Click the maintenance object icon (  ) to view the table's maintenance object.
- If you want to position the [List Panel](#) to view the columns for different table click the name of the table for which you want to view the columns.

## Table Detail View

The table detail view displays information about the selected table. Click [Attributes](#) (in the toolbar) to switch to the table detail view.

In the table detail view, you can navigate using the following options:

- If user documentation is available for the table, click the View User Documentation link to read the user documentation that describes the table's maintenance object.
- If the table has an associated Language Table, click the link to view the Language Table details.
- If there is an associated Maintenance Program, click the link to view the source code for the maintenance program (you are transferred to the [Java Docs Viewer](#)).
- If there is an associated Key Table, click the link to view the Key Table details.

## Column Detail View

Click on a column name in the list panel to switch to the column detail view. The Column Detail view displays information about the selected column.

In the column detail view, you can navigate using the following options:

- If user documentation is available for the column, click the View User Documentation link to read about the column's related maintenance object.
- If the column is a foreign key, click the table name to switch to the Table Detail view for that table.
- If the column has a Value List available (normally only present for a subset of flag and switch fields), click the link to view the source code for the copybook (you are transferred to the [Java Docs Viewer](#)).

## Lookup Values

If the selected column is a lookup field its valid values are also listed. Notice that you can enter an override description for [lookup values](#). In this case the override description is shown.

---

**NOTE: Regenerate.** You should regenerate the data dictionary after overriding lookup value descriptions. Refer to [Application Viewer Generation](#) for further details.

---

## Maintenance Object Viewer

The maintenance object viewer is an interactive tool that allows you to view a schematic diagram of a maintenance object. A maintenance object is a group of tables that are maintained as a unit.

To open the Maintenance Object Viewer, click the [Maint. Object](#) button in the application viewer or click a [maintenance object icon](#) in the Data Dictionary.

---

**NOTE: Data Is Generated.** A background process generated the maintenance object information. Refer to [Application Viewer Generation](#) for further details.

---

## Using the Maintenance Object List Panel

The list panel displays a list of maintenance objects. In the list panel, you can click the maintenance object name to display information about the maintenance object in the detail panel.

## Using the Maintenance Object Detail Panel

The Maintenance Object detail panel displays a schematic of the selected maintenance object.

In the detail panel, you can navigate using the following options:

- Click a table name to transfer to the Data Dictionary [table detail view](#) for a table. (Click the [Maint. Object](#) button in the toolbar to return to the maintenance object.)
- Click the service XML icon () to view the XML file of the Service Program used to maintain the displayed object. (Click the [Maintenance Object](#) button in the toolbar to return to the maintenance object.)

## Algorithm Viewer

The algorithm viewer is an interactive tool that allows you to view algorithm types (grouped by their plug-in spot) and their related algorithms.

To open the Algorithm Viewer, click the [Algorithm](#) button in the application viewer. The Algorithm viewer may also be opened from certain locations in the online help documentation.

---



**NOTE: Data Is Generated.** A background process generates algorithm information. Refer to [Application Viewer Generation](#) for further details.

---

## Using the Algorithm Viewer List Panel

The list panel displays a list of algorithm types and their related algorithms, grouped by their plug-in spot.

In the list panel, you can navigate using the following options:

- Click the algorithm plug-in spot description to display information about the plug-in spot in the detail panel.
- Click the right pointer  icon to expand a plug-in spot and view its algorithm types and their related algorithms.
- Click the down pointer  icon to collapse the list of algorithm types for a plug-in spot.
- Click the algorithm type name to display information about the algorithm type in the detail panel.
- Click the algorithm name to display information about the algorithm in the detail panel.

## Using the Algorithm Plug-In Spot Detail Panel

The Algorithm plug-in spot detail panel displays further information about the selected plug-in spot.

## Using the Algorithm Type Detail Panel

The Algorithm Type detail panel displays further information about the selected algorithm type.

In the Algorithm Type detail panel, you can navigate using the following options:

- Click on the program name to view its source in the Java docs viewer.

## Using the Algorithm Detail Panel

The Algorithm detail panel displays further information about the selected algorithm.

## Batch Control Viewer

The batch control viewer is an interactive tool that allows you to view batch controls.

To open the Batch Control Viewer, click the [Batch Control](#) button in the application viewer. The Batch Control viewer may also be opened from certain locations in the online help documentation.

---

**NOTE: Data Is Generated.** A background process generates batch control information. Refer to [Application Viewer Generation](#) for further details.

---

## Using the Batch Control Viewer List Panel

The list panel displays a list of batch controls. The list panel can display the list of batch controls sorted by their code or sorted by their description. Click the appropriate [button](#) on the toolbar to switch between sorting by the code and description.

In the list panel, you can click the batch control to display information about the batch control in the detail panel.

---

**NOTE: Not All Batch Controls Included.** Note that the insertion and key generation programs for conversion (CIPV\*) are not included.

---

## Using the Batch Control Detail Panel

The batch control detail panel displays further information about the selected batch control.

In the batch control detail panel, you can navigate using the following options:

- Click on the program name to view its source in the Java docs viewer.
- If a To Do type references this batch control as its creation or routing process, click on the To Do type to view its detail in the To Do type viewer.

## To Do Type Viewer

The to do type viewer is an interactive tool that allows you to view to do types defined in the system.

To open the To Do Type Viewer, click the [To Do Type](#) button in the application viewer. The To Do Type viewer may also be opened from certain locations in the online help documentation.

---

**NOTE: Data Is Generated.** A background process generates To Do type information. Refer to [Application Viewer Generation](#) for further details.

---

## Using the To Do Type Viewer List Panel

The list panel displays a list of To Do types. The list panel can display the list of To Do types sorted by their code or sorted by their description. Click the appropriate [button](#) on the toolbar to switch between sorting by the code and description.

In the list panel, you can click the To Do type to display information about the To Do type in the detail panel.

## Using the To Do Type Detail Panel

The To Do type detail panel displays further information about the selected To Do type.

In the To Do type detail panel, you can navigate using the following options:

- If the To Do type references a creation process or a routing process, click on the batch process to view its detail in the batch control viewer.
- Click on the table listed in the drill key section to view its detail in the data dictionary.
- Click on the field(s) listed in the drill key section to view its detail in the data dictionary.

## Service XML Viewer

The service XML viewer is an interactive tool that allows you to browse the XML files of service programs that execute on the application server.

You can access the service XML viewer as follows:

- The maintenance object viewer allows you to view the XML file of the maintenance object's service program. This feature is implemented by viewing the maintenance object and then clicking on the [Service XML icon](#).
- When viewing a maintenance object on the [Maintenance Object](#) page, clicking the **View XML** hyperlink causes the service's XML document to be displayed in the Service XML Viewer.
- When viewing a business service on the [Business Service](#) page, clicking the **View XML** hyperlink causes the service's XML document to be displayed in the Service XML Viewer.
- When setting up a [Function](#), you may want to view the XML document used to pass data to and from the service. Clicking the **View XML** hyperlink causes the XML document to be displayed in the Service XML Viewer.

## Using the Service XML Viewer Overview Panel

The overview panel displays a high level nodes and list names structure of the XML document.

In the overview panel, you can click on any node item to position the detail panel to view that item.

## Using the Service XML Viewer Detail Panel

The detail panel displays nodes and attributes of the selected XML file.

Click the **xpath** button to view the XML path that should be used to reference the selected node in the XML document. The box at the top of the overview panel changes to display this information.

---

**NOTE: Fields in multiple lists.** Note that the generated XPath expression refers to lists using a generic “list” reference. For example: `/pageBody/list/listBody/field[@name='FIELD_NAME']`. If a service has a field that appears in more than one list, the above XPath may not be sufficient for referencing that field. In this case, references to the XPath should be adjusted to include the list name. The list name is visible in the overview panel. To add the list name, use `[@name='LIST_NAME']`. For example: `/pageBody/list[@name='LIST_NAME']/listBody/field[@name='FIELD_NAME']`.

---

## Java Docs Viewer

The Java Docs viewer is an interactive tool that allows you to browse Java documentation files (Javadocs) for Java classes that execute on the application server.

---

**NOTE:** Proprietary Java Classes. A small number of Java classes have been suppressed due to their proprietary nature.

---

**NOTE: Classic view.** If you are more comfortable using the classic Javadocs viewer you may use the [Classic](#) button.

---

To open the Java Docs viewer from within the application viewer, click the [Java Docs button](#). Additionally, the [algorithm viewer](#) and the [batch control viewer](#) allows you to view the Javadocs of a program written in Java.

## Using the Java Docs Viewer List Panel

The list panel displays a tree of Java packages where each package may be expanded to list the Java interfaces classes it includes.

In the list panel, you can navigate using the following options:

- Click the right arrow icon to expand a Java package to view the Java interfaces and classes it includes.
- Click the down arrow icon to collapse the list for a Java package. Optionally, collapse all lists by using the **Collapse** button.
- Click the Java interface or class name to display information about it in the detail panel.

The list details panel designates the interfaces and the classes as follows:

- A green dot indicates Java interfaces.
- A blue key indicates Java classes.

If you hover the cursor over the icon, the tool tip indicates whether it's an interface or a class.

## Using the Java Package Detail Panel

The package detail panel displays a summary of the various Java classes that are included in the selected Java package.

Click the Java class name to display information about the Java class in the detail panel.

## Using the Java Interface / Class Detail Panel

The detail panel displays Java documentation information about the selected Java interface or class.

You can navigate using hyperlinks to other locations in the current detail panel or to view the details of other Java interfaces / classes.

## Groovy Java Docs Viewer

The Groovy Java Docs viewer is an interactive tool that allows you to browse Java documentation files (Javadocs) for the Java classes that are accessible to Groovy code within scripts.

---

**NOTE:** For system protection, only a subset of the base Java classes are available for use by Groovy code.

---

To open the Groovy Java Docs viewer from within the application viewer, click the [Groovy Java Docs button](#). You can also access the viewer via the 'View Groovy Javadocs' link in the context sensitive Script Tips zone. Refer to the additional topics in the [Java Docs Viewer](#) section for details of how to navigate the viewer panels.

## Application Viewer Preferences

This panel displays the Available Languages and allows you to select the language in which the labels and buttons are displayed. Select your desired language and click OK.

## Application Viewer Stand-Alone Operation

You can run the Application Viewer as a stand-alone application (i.e., you do not need to launch it from the online application environment). To run it as a stand-alone application, you should copy the Application Viewer files (all files in the appViewer directory) and the online help files (all files in the help directory) to the server on which you want to run the Application Viewer.

---

**NOTE:** Online Help. If you do not copy the online help files, online help will not be available for the Application Viewer, nor will you be able to view business descriptions of the tables' maintenance objects.

---

To start the application viewer in stand-alone mode, launch the appViewer.html file (located in the appViewer directory).

## Stand-Alone Configuration Options

You can configure the Application Viewer for stand-alone operation by modifying options in a configuration file. The Application Viewer comes with a default configuration file called config\_default.xml (located in the appViewer\config directory). Create a copy of the default configuration file and rename it to config.xml. Modify the options described in the following table to suit the needs of your installation.

---

**NOTE: Default Configuration.** If you do not create the config.xml file, the Application Viewer launches with its default (internal) configuration.

---

Option	Description
defaultLanguage	The default language used when the application viewer is started. Available values are those marked as language enabled on the language page.
defaultView	The default view then the application viewer is started. Available values include: - Data Dictionary
dataDictionary	Whether the Data Dictionary is available or not: - Y - N
sourceCode	This property is not being used. Simply enter 'N'.

Option	Description
<b>baseHelpLocation</b>	The location of the stand-alone online help in relation to the application viewer. Specify the directory structure relative to the location of the directory in which the Application Viewer files are located. Note that this is the directory in which the language subdirectories for the online help are located. The default location is:  ../help
<b>appViewerHelp</b>	The default help topic that is launched when the Help button is clicked in the Application Viewer. Specify a help file and anchor that is under the appropriate language directory under the baseHelpLocation. The default is:  Framework/Admin/91AppViewer.html#SPLINKApplication_Viewer

## Example Application Viewer Configuration

The following excerpt shows an example Application Viewer configuration.

```
<?xml version="1.0" encoding="UTF-8" ?>
<configuration>
<option id="defaultLanguage">PTB</option>
<option id="defaultView">Data Dictionary</option>
<option id="dataDictionary">Y</option>
<option id="sourceCode">N</option>
<option id="baseHelpLocation">../help</option>
<option id="appViewerHelp">Framework/Admin/91AppViewer.html#SPLINKApplication_Viewer</option>
</configuration>
```

## Application Viewer Generation

The Application Viewer is initially delivered with service XML information only.

The other components of the application viewer are generated on site.

- Use the background process **F1-AVALG** to regenerate algorithm information
- Use the background process **F1-AVBT** to regenerate batch control information.
- Use the background process **F1-AVMO** to regenerate maintenance object information
- Use the background process **F1-AVTBL** to regenerate data dictionary information.
- Use the background process **F1-AVTD** to regenerate To Do type information.

These processes have been introduced so that you can more easily incorporate your implementation-specific information into the application viewer.

To keep the information shown in the application viewer current it is important to execute these background processes after you introduce changes to the corresponding system data.

---

**NOTE: Data Generation Is Not Incremental.** Each new execution of these processes first deletes existing data (if any) in the corresponding folder before it generates new data.

---



---

**NOTE: Other Extensions.** Service XML may also be extended to include implementation-specific information. The base package is provided with special scripts that handle this type of extension. Refer to the Software Development Kit User Guide for further information on application viewer extensions.

---



---

**NOTE: War File.** If your application is installed in war file format, each generation of application viewer data rebuilds the corresponding war file. The web application server then needs to be "bounced" in order to make the newly generated data available to the application viewer. Please consult your system administrator for assistance.

---

**NOTE: Certain Web Application Servers Are Special.** WebSphere and Oracle Application web application servers require an additional step in order to make the newly generated data available to the application viewer. These web application servers require a rebuild of the application ear file and its redeployment in the web application server. This step is described in the installation document. Please consult your system administrator for further details.

---

## Reporting and Analytics Tools

This chapter describes various tools provided in the product to support reporting and analytics.

### Reporting Tool Integration

This section describes how to configure your third party reporting tool and how to define your reports in the system to enable users to submit reports online.

### The Big Picture Of Reports

The topics in this section describe the approach for designing and defining your system reports. Note that the product includes an out-of-the-box integration with BI Publisher. However it is possible to use the reporting objects to integrate with a different third party tool.

### Integration with BI Publisher

Your DBMS, your product, and BI Publisher can work together to produce reports. You may choose to use a different reporting tool, but this may not be a trivial effort. This section provides high-level information about some of the business requirements that are being solved with the reporting solution.

### Multi-Language and Localization Support

The integration supports a multi-language implementation and supports different localization settings.:

- All labels, headings and messages are defined using field and message meta-data in the application, which support multiple languages.
- The appropriate font, size, and layout are based on the requested report and the user's language.
- Dates and numbers are formatted as per the user's display profile.
- Currency based numbers are formatted as per the currency definition from the product

### Requesting Reports from The System

Although reports are rendered in your reporting tool, users must be able to request ad-hoc reports from within the system (assuming users have the appropriate security access).

- The prompts for the input parameters must be shown in the user's language
- Users should be able to use the standard search facilities to find parameter values
- Plug-ins can be optionally used to cross-validate input parameters

- Application security must authorize ad-hoc report requests

## Overview of the Data - BI Publisher

The following diagram provides an overview of where data is stored for your reports for integration with BI Publisher.

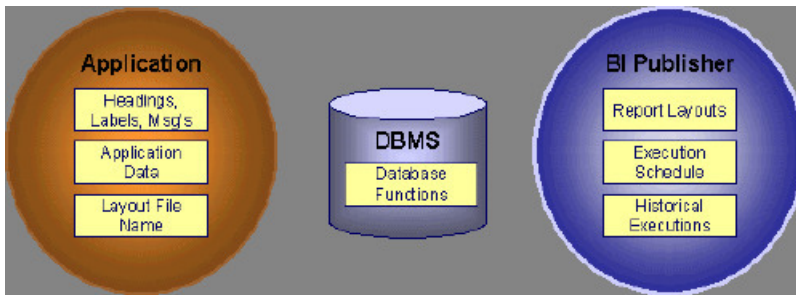

**Figure 9: Application and BI Publisher**

The application contains:

- The application data that appears on your reports.
- The language-specific headings, labels and messages on your reports.
- The layout file name to be used for the report.

BI Publisher contains:

- How your reports look.
- Information about scheduled reports and reports that have already run.

The DBMS contains the SQL used to retrieve the data on your reports (residing in database functions).

---

**NOTE:** BI Publisher can be configured to retrieve data via a service call. Because every business object can be read via a service call, elements that reside in an XML based column can be displayed on reports produced using BI Publisher. See your product's *Installation Guide* or *Optional Products Installation Guide* for information on this configuration.

---

## How To Request Reports

A user may request an ad hoc report from within your product:

- A [report submission](#) page enables a user to choose the desired report and enter the parameter values for the report
- The user must be granted security access to the report
- The request is passed to the reporting tool real time. Refer to [Configure The System to Invoke BI Publisher](#) for more information.
- The reporting tool generates the report and displays it in a new browser window

The reporting tools' scheduler creates reports (as per your schedule). This function is entirely within the reporting tool. No scheduling functions reside within your product.

A user can request an ad-hoc report from within the reporting tool. Note, the user's ID must be supplied as a parameter to the report in order for the user's profile to be used to format dates and numbers

## Viewing Reports

As described above, ad-hoc reports requested from within your product are displayed immediately after they are generated in a new browser window

If your reporting tools supports it, the [Report History](#) page may be configured to open tool's report execution history page and request a view of this report.

---

**NOTE:** The [Report History](#) page currently does not display historical reports for BI Publisher.

---

## Configuring The System To Enable Reports

### Configuring BI Publisher Reports

This section contains topics specific about configuring the product to interoperate with BI Publisher.

#### Configure the System to Invoke BI Publisher Real-time

The base product provides an [installation algorithm](#) plug-in spot called Reporting Tool. This plug-in spot should contain an algorithm that invokes the third party reporting tool real-time.

For BI Publisher, the system provides an algorithm type called [F1-BIPR-INV](#), which invokes BI Publisher.

These algorithms rely on information defined in the [Reporting Options](#) table: the reporting server, reporting folder and the user name and password for accessing the reporting tool. The values in the reporting options should have been set up when the system was installed. Contact your system administrator if there are any problems with the values defined on the reporting options.

To use the algorithm types to invoke BI Publisher, perform the following steps:

- Create an [algorithm](#) for the appropriate algorithm type.
- On the [installation options](#), add an entry to the algorithm collection with an algorithm entity of **Reporting Tool** and indicate the algorithm created in the previous step.

### Batch Scheduling in BI Publisher

For many of your reports, you probably want the report to be produced on a regular basis according to a scheduler. The reporting solution relies on the BI Publisher software to provide the batch scheduler functionality. Refer to BI Publisher documentation for details about configuring the batch scheduler.

### Defining Reporting Options

The reporting options are provided as a mechanism for defining information needed by your reporting solution. The base product uses the reporting options to define information needed to access the reporting tool from within the system using the algorithm defined on the installation option.

Navigate to this page using **Admin > Reporting > Reporting Options**.

#### Description of page

**Reporting Folder** defines the shared folder where reports are stored.

**Reporting Server** defines the URL of the web application where the reporting tool is installed. For example, using BI Publisher, the format is: `http://<BI Publisher Server>:<port>`.

**Reporting Tool User ID** is not applicable when integrating with BI Publisher.

Other reporting tools may require a user id to use when logging in.

**Reporting Tool Password** is not applicable when integrating with BI Publisher.

Other reporting tools may require a password to use when logging in.

---

**NOTE: Customize Options.** The reporting options are customizable using the Lookup table. This field name is **RPT\_OPT\_FLG**. The reporting options provided with the system are needed to invoke the reporting tool. If your implementation requires other information to be defined as reporting options, use the lookup table to define additional values for the reporting option flag.

---

### Where Used

This information is used by the reporting tool algorithm on the [installation option](#) to invoke the reporting tool software. Implementations may use reporting options to record other information needed for their reporting tool.

## Defining Report Definitions

For each report supplied by your installation, use the report definition page to define various attributes of the report.

### Report Definition - Main

Navigate to this page using **Admin > Reporting > Report Definition**.

---

**CAUTION:** Important! If you introduce new report definitions, you must prefix the report code with **CM**. If you do not do this, there is a slight possibility that a future release of the application could introduce a new system report with the name you allocated.

---

### Description of page

Enter an easily recognizable **Report Code** and **Description** for each report. Use the **External Reference ID** to define the identifier for this report in your external reporting tool.

Define an [application service](#) to enable users to request submission of this report online or to view report history for this report. Once you define an application service for each report, use [application security](#) to define which users may access this report.

---

**NOTE: Access Mode.** The access mode for application services related to reports must be set to **Submit/View Report**.

---

If you have more than one parameter defined for your report and you wish to perform cross-validation for more than one parameter, provide an appropriate **Validation Algorithm**. Click [here](#) to see the algorithm types available for this system event.

Enter a **Long Description** to more fully describe the functionality of this report. This information is displayed to the user when attempting to submit the report online or when viewing history for this report.

For BI Publisher, if you want to use one of the sample reports provided by the system, but with a different layout, indicate the layout to use for the report in the **Customer Specific Font/ Layout** field and BI Publisher uses this information instead. The name for base report layout is <report code>\_Base. For example, a base layout for CM\_TODO is named CM\_TODO\_Base.

### Report Definition - Labels

Navigate to this page using **Admin > Reporting > Report Definition** and go to the **Labels** tab.

---

**NOTE: Company name and logo.** Note the company name used as a title in the sample reports is defined as a message on the [installation options](#). For information about installing the company logo, refer to your product's *Installation Guide* or the *Optional Products Installation Guide*.

---

## Description of Page

In order to provide multi-language capability for each report, the labels used for the report must support multiple language definitions. For each label used by your report, indicate a unique **Sequence** and the **Field** used to define the **Label**. The label defined here should be the same label that is defined in your report layout defined in the external reporting tool.

When rendering an image of the report, the external reporting tool retrieves the appropriate label based on the language used for the report.

## Report Definition - Parameters

Navigate to this page using **Admin > Reporting > Report Definition** and go to the **Parameters** tab .

### Description of Page

The **Parameters** scroll contains one entry for every parameter defined for the report. The following fields display:

**Parameter Code** is the identifier of the parameter. This must correspond to the parameter definition in the reporting tool.

**Required** indicates that a value for the parameter must be defined when submitting the report.

**Sort Sequence** must match the parameter order defined in the reporting tool's report. It is also used when displaying the list of parameters on the [report submission](#) page.

**Characteristic Type** indicates the characteristic type used to define this parameter.

**Default Value** is option and if populated is displayed to the user when the report is chosen on the [report submission](#) page.

**Description** is a brief description of the parameter. This description is used when displaying the parameter on the [report submission](#) page.

**Long Description** is a detailed description of the parameter. This description is used on the [report submission](#) page when the user requests more information for a given parameter.

## Sample Reports Supplied with the Product

Depending on your specific product, there may be sample reports provided that your organization may use as they are or as a starting point for creating a [new report](#). The following sections provide an overview of the sample reports along with instructions on how to use one of the sample reports in your implementation environment.

## How to Use a Sample Report Provided with the System

If you would like to use any of the sample reports, you need to perform some steps to be able to execute them in an implementation environment. This section walks you through the steps needed.

### Steps Performed at Installation Time

Refer to the *Installation Guide* or *Optional Products Installation Guide* for instructions for setting up and configuring your product and reporting tool to use the sample reports provided with the system. The following steps are described there.

- Setting up the stored procedures used by the sample reports.
- Defining the company title and logo used by the sample reports. Note the company name used as a title in the sample reports is defined as a message on the [installation options](#).
- Defining a user for integration with your product.
- Publishing the sample reports in BI Publisher.

Contact your system administrator to verify that the above steps have occurred.

# How To Define A New Report

## Use a Sample Report as a Starting Point

- Make a copy of the report and save it in an appropriate directory. Prefix the new report name with **CM**.
- Review the stored procedure(s) used for this report. Refer to the installation guide for information about where the stored procedures should be defined. If you want to change the data that is being accessed, copy the stored procedure, prefixing the new stored procedure with **CM**. Make the appropriate changes in the new version of the stored procedure. Contact your database administrator to find out the procedure for creating a new stored procedure.

---

**NOTE: Performance considerations.** When designing a stored procedure, you must consider the performance of the report when executed. Consult your database administrator when designing your database access to ensure that all issues are considered.

---

**NOTE: Defining Messages.** The stored procedures provided with the system use messages defined in message category 30. If your new stored procedures require new messages, use message category 90000 or greater, which are reserved for implementations.

---

- Review the parameters used by the report. Make appropriate changes to the parameters required by the report. This affects how you define your report. Refer to [Designing Parameters](#) for more information.
- Determine whether or not you require cross validation for your report parameters. If any cross validation is necessary, you should design an appropriate validation algorithm to be executed when requesting a report in your product. Refer to [Designing Validation Algorithms](#) for more information.

---

**NOTE: Cross Validation for On-line Submission Only.** The cross validation algorithm is only executed for ad-hoc report submissions via your product. If you submit this report through your reporting tool, this algorithm is not executed.

---

- Review the labels used by the report. Labels and other verbiage are implemented in the sample reports using a reference to the field table in the system. This enables the report to be rendered in the appropriate language for the user. For any new report label you require, you must define a new field entry. Refer to [Designing Labels](#) for more information.
- Review the layout of the report and make any desired changes based on your business needs.

When you have finished designing and coding your new report in your reporting tool, you must do the following in order for it to be usable:

- Publish the report in BI Publisher. Refer to the documentation for this products for details about publishing a report. Refer to [Publishing Reports in BI Publisher](#) for configuration information specific to publishing a report for integration with your product.
- Define the report. Refer to [Designing Your Report Definition](#) for more information.

## Publishing Reports in BI Publisher

Please refer to the documentation for BI Publisher for more information about publishing a report in this system. The remaining topics in this section provide information about settings needed to ensure that the report is accessible using BI Publisher.

## BI Publisher Database Access

When publishing a report in BI Publisher, you are asked for database logon information. The logon user name and password must be the user name and password that has access to the database functions related to this report in your database.

## Verify BI Publisher User Access Rights

To verify the user's access rights to folders in BI Publisher:

- Open the BI Publisher Enterprise Security Center.
- Check that the role for the user has access to the appropriate report folders.

For more information, refer to the "Understanding Users and Roles" section in the Oracle Business Intelligence Publisher User's Guide.

## Designing Your Report Definition

When adding a new report, you must define it in the system to allow users to request ad-hoc reports from on-line and to take advantage of the multi-language provisions in the system. The following topics illustrate the steps to take to correctly configure your report definition.

## Designing Main Report Definition Values

Refer to field description section of the [report definition](#) main page for information about defining general information about the report.

For the validation algorithm, preliminary steps are required. Refer to [Designing Validation Algorithms](#) for more information.

For the application service, preliminary steps are required. Refer to [Designing Application Services](#) for more information.

## Designing Characteristic Types

The parameter tab on the report definition page uses [characteristic types](#) to define the report parameters. For each report parameter that you plan to use, you must define a characteristic type.

You do not need a unique characteristic type for each report parameter. For example, if Start Date and End Date are parameters your report, only one **Report Date** characteristic type needs to be defined. This characteristic type would be used on both date parameters.

Each characteristic type to be used as a report parameter must indicate a characteristic entity of **Report**.

To illustrate the characteristic type definitions, let's look at the sample report Tax Payables Analysis. It needs the following parameters: From Date, To Date, GL Account Type Characteristic Type and Account Type value.

---

**NOTE: Account Type Parameters.** The tax payables report must find general ledger entries that have posted to a certain distribution code. In order to find the appropriate distribution code, the report expects each distribution code to be defined with a characteristic indicating its GL account type (for example, **Revenue**, **Asset**, etc.) The report needs to know the characteristic type used to define this entry.

---

To support the required parameters, the following characteristic types are needed.

Char Type	Description	Type	Valid Values	Char Entities
-----------	-------------	------	--------------	---------------

CI_DATE	Date Parameter	Ad-hoc	(Uses validation algorithm to validate proper date entry)	Report
CI_CHTYP	Characteristic Type	FK Reference	<b>CHAR_TYP</b>	Report
CI_GLTYP	GL Account Type	Pre-defined	A- Asset, E- Expense, LM- Liability/miscellaneous, LT- Liability/taxes, R-Revenue	Distribution Code, Report

Highlights for some of the above settings:

- We have defined a characteristic type for defining a characteristic type. This is to allow the user to indicate which Char Type on the Distribution Code is used for the GL account type. This is an FK reference type of characteristic.
- The GL account type characteristic type is referenced on both the Distribution Code entity and the report entity.

## Designing Parameters

Your report definition parameters collection must define a unique parameter entry for each parameter sent to the reporting tool. The sequence of your parameters must match the sequence defined in your reporting tool.

Continuing with the Tax Payables Analysis report as an example, let's look at the parameter definitions.

Parameter Code	Description	Char Type	Default Value
P_FROM_DT	From Date	CI_DATE	N/A
P_TO_DT	To Date	CI_DATE	N/A
P_CHAR_TYPE	Account Type Characteristic	CI_CHTYP	CI_GLTYP
P_TAX_ACCTY_CHAR	Account Type Char Value for Tax Related GL Account	CI_GLTYP	LT-Liability/taxes

Highlights for some of the above settings:

- The from date and to date parameters use the same characteristic type.
- The characteristic type parameter is defined with a default value pointing to the GL account type characteristic type.
- The GL account type parameter defines the liability/taxes account type as its default value.

**NOTE: User Id.** The sample reports provided by the system pass the user id as the first parameter passed to the reporting tool. It does not need to be defined in the parameter collection for the report.

## Designing Validation Algorithms

When designing your report definition, determine if cross validation should occur for your collection of parameters. In the Tax Payables Analysis report, there are two date parameters. Each date parameter uses the characteristic type validation algorithm to ensure that a valid date is entered. However, perhaps additional validation is needed to ensure that the start date is prior to the end date. To do this, a validation algorithm must be designed and defined on the report definition.

The system provides a sample algorithm [RPTV-DT](#) that validates that two separate date parameters do not overlap. This algorithm should be used by the Tax Payables Analysis report.

If you identify additional validation algorithm, create a new [algorithm type](#). Create an [algorithm](#) for that algorithm type with the appropriate parameter values. Plug in the new validation algorithm to the appropriate report definition.

## Designing Application Services

[Application services](#) are required in order to allow a user to submit a report on-line or to view history for a report. Define an application service for each report and define the user groups that should have submit/view access to this report.

Update [report definition](#) to reference this application service.



## Designing Labels

The system supports the rendering of a report in the language of the user. In order to support a report in multiple languages, the verbiage used in the report must be defined in a table that supports multiple languages. Some examples of verbiage in a report include the title, the labels and column headings and text such as "End of Report".

The system uses the [field](#) table to define its labels.

---

**NOTE: Report Definition.** This section assumes that your new report in the reporting tool has followed the standard followed in the sample reports and uses references to field names for all verbiage rather than hard-coding text in a single language.

---

For each label or other type of verbiage used by your report, define a field to store the text used for the verbiage.

- Navigate to the field page using **Admin > System > Field**.
- Enter a unique **Field Name**. This must correspond to the field name used in your report definition in the reporting tool and it must be prefixed with **CM**.
- Define the **Owner** as **Customer Modification**.
- Define the **Data Type** as **Character**.
- **Precision** is a required field, but is not applicable for your report fields. Enter any value here.
- Use the **Description** to define the text that should appear on the report.
- Check the **Work Field** switch. This indicates to the system that the field does not represent a field in the database.

Update the [report definition](#) to define the fields applicable for this report in the **Labels** tab.

If your installation supports multiple languages, you must define the description applicable for each supported language.

## Measuring Performance

Many implementations need the ability to track and view the performance of key system processes against a defined target level. The framework provides objects to allow an edge product or an implementation to calculate and display performance measures against a desired target for one or more use cases. The topics in this section provide information about what is supplied in the framework and guidelines for implementing a specific use case for batch processes. Your product may supply out of the box support for additional use cases. Refer to your product documentation for more information.

## About Performance Targets

The following are examples of use cases that would be well suited for tracking as performance targets:

- Track and view the duration of key batch processes, either individually or as a group, and how they relate to a defined target.
- Monitor used and free space on a database against critical levels.
- Check the performance of individual user interface zones against a defined performance expectation
- Compare the number of web service requests made to an application against a threshold where performance may be of concern.

Framework provides functionality to define and categorize performance targets and link them to objects such as business services, zones and portals. This supports the calculation and display of the metrics against desired results.

In addition, Framework supplies out of the box support for batch process performance targets. Individual edge applications may supply more specific functionality for other use cases, if applicable.

Ideally, users should have the ability to view these performance targets on a dashboard that groups related measures. Framework provides the necessary components to achieve this for batch process performance targets.

The following sections highlight functionality supported for performance targets in the framework. Refer to the edge application product documentation for more details of other supported use cases.

## Performance Target Objects Overview

The setup of a performance target involves a unique combination of configuration data and processing logic that calculates and displays a specific measure.

The framework performance target functionality is supported by a combination of inter-related objects, as shown below. Some of these objects will be generic for use in all performance targets while some are specific to a functional area such as batch processes.

- **Maintenance Objects** for capturing performance target types and performance target instances.
- **Extendable Lookups** to define performance target categories and performance target metrics.
- **Business Services** to calculate known metrics for a group of performance targets, such as for batch processes.
- **UI Maps** to interpret the performance calculation results and display them in charts that show the comparison to the target.
- A **Zone** that serves as a template for system duplication to create specific zones related to each performance target. The zone invokes a business service to perform calculations and display performance measures in the related UI map.
- **Business Objects** to capture configuration data for a specific performance target instance and its related objects.
- Functionality to create **Zone instances** for specific performance targets based on the associated template zone.

Each edge application will deliver the following to compliment the objects delivered by the framework:

- **Portals** to group related performance target zones.
- Specific entries for the performance target category **Extendable Lookup** .

The following sections describe the combined use of these objects for performance targets in more detail.

## Calculating and Displaying Performance Targets

Performance targets are intended to be displayed in a portal using an explicit object zone. The zone parameters define both the business service used to calculate the performance metrics and the UI map that displays the results. While an individual performance target needs to reference a zone with a unique configuration that calculates a particular metric, those zones will be based on a template zone which defines the core parameters.

Framework provides a base Batch Performance Target Metric Template zone (**F1-PERFBA**) for batch process performance targets. Refer to this zone and its parameters for more information about the batch performance zone configuration and the related business service and UI map.

## Performance Target Metrics and Metric Types

The framework supports two types of metrics for performance monitoring:

- **Value based metrics** are used to record results against a specific numeric target.
- **Time based metrics** are used to track the results against a specific date and time target.

The list of valid metrics for a given performance target category and its associated performance target types is maintained using an extendable lookup. Framework uses the base business object Batch Performance Target Metric (**F1-BatchPerfTargetMetric**) to define batch process metric values. Refer to this lookup for the supported batch process metrics.

---

**NOTE:** While users are not prevented from adding new values to the lookup, the list is not intended to be extendable as new values will not be recognized by the business service that performs the base batch performance calculation logic.

---

Your edge product or implementation may supply other extendable lookup business objects for additional performance measurement use cases, if applicable.

## Performance Target Categories and Types

There are key configuration details required by all performance targets. These are defined on two related objects.

### Performance Target Categories

Target categories define the template zone and security setting for a group of performance measures. The list of valid categories is maintained using an extendable lookup.

The framework product supplies the business object Performance Target Category (**F1-PerformanceTargetCategory**) for this functionality. Refer to the business object description and configuration for more information.

### Performance Target Types

Target types define the related performance target business object and the display portal for a group of performance measures. In addition, a target type references a target category which defines the associated zone details.

The framework product supplies the business object Performance Target Type (**F1-PerformanceTargetType**) for this functionality. Refer to the business object description and configuration for more information.

The framework does not deliver any standard type or category values for batch processing performance targets. Refer to your specific edge application products to verify if any standard values are delivered for the batch processes within your applications. Edge applications may also supply standard categories and types for additional performance target use cases.

## Performance Targets Define Specific Metrics

Although the types of measures and the business services and UI maps that govern how they are calculated and displayed are defined using separate objects, a **performance target** record defines the additional configuration needed to measure a specific metric and compare the result to a desired value.

There are key configuration details required by all performance target instances. These include a reference to the metric being measured, the desired target value or time, the desired result for the target and the unique zone by which this performance target will be monitored.

---

**NOTE:** The performance target maintenance object has a direct foreign key link to the extendable lookup business object and value that define the performance metric. This is an unusual pattern as extendable lookup values are normally recorded only in an object's schema. The pattern has been adopted to allow the description of the metric to be displayed in the performance target maintenance portal.

---

A given **performance target type** may require additional details for its calculations. For example, the framework batch process performance target defines additional details to restrict the measurement to specific batch processes that have executed within a given time frame. These details are configured on the performance target business object. Refer to the embedded help text on the business objects supplied by the framework and your edge applications for more information.

The **performance target type** also defines the business object to use when creating the resulting performance target record.

## Objects Linked to a Performance Target

Some performance measures such as batch process metrics, derive the data for the calculation from objects within the system. The performance target can be linked to one or more related objects to define the specific data sources included in

that target metric. For example, when creating a batch process performance target, the framework supports linking specific batch codes to the performance target to indicate the group of batch processes that are included in the measure.

The performance target business object may be configured to allow only relevant objects types to be linked to a performance target record. Refer to the base Batch Performance Target business object (**F1-BatchPerformanceTarget**) for an example.

## Creating Performance Target Zones

Once a performance target and its objects have been defined, a unique zone needs to be created to display and monitor the specific target.

The framework functionality for batch performance targets implements the zone creation via the related business object lifecycle. When a performance target is added, status enter plug-ins are responsible for generating the new zone using the template zone and prefix configured on the target category (or the override values) and adding the zone to the portal configured on the target type. When a performance target is inactivated, an enter plug in is responsible for removing the zone from the portal.

---

**NOTE:** While the template zone associated with the performance target category may be overridden, the zone generation algorithm makes certain assumptions about the zone type and parameters. In particular, the logic expects to configure a zone parameter that references the performance target code as input to the business service responsible for calculating the metrics.

---

Refer to the base Batch Performance Target business object (**F1-BatchPerformanceTarget**) for details of the lifecycle and the enter plug-ins responsible for performance target zone creation.

## Setting Up Performance Target Configuration

The following topics highlight the general configuration steps required to use performance target functionality. Your particular product or implementation may supply additional functionality to support specific use cases for performance targets. Refer to your product's documentation and the library of business objects supplied for performance target in your system for more information.

## Performance Target Category Lookup

Refer to [About Performance Targets](#) for an overview of performance target functionality.

Each Performance Target Type is associated with a unique Performance Target Category. The categories are defined as an extendable lookup.

Navigate to the [Extendable Lookup](#) portal. Search for and select the **Performance Target Category** business object. Define values that are appropriate to the categories your implementation is assigning for the performance target types in use. In some cases, an edge application may already have delivered the appropriate performance target category for your use

Refer to the embedded help for more information about configuring this object.

## Defining Performance Target Types

Refer to [About Performance Targets](#) for an overview of performance target functionality.

To maintain the performance target types applicable to your product or implementation, open **Admin > Reports > Performance Target Type**.

This is a standard [All-in-One portal](#).

The information captured on the performance target type depends on the business objects supported by your product or implementation. Refer to the embedded help text for more information.

### Where Used

Follow this link to open the data dictionary where you can view the tables that reference [F1\\_PERF\\_TGT\\_TYPE](#).

## Maintaining Performance Targets

This section describes the functionality supported for viewing and maintaining performance targets.

Refer to [About Performance Targets](#) for an overview of performance target functionality.

Navigate using **Main > Reporting > Performance Target**. This is an [All-in-One portal](#) and includes the standard List and display zones for a performance target.

For information about the data defined on the performance target, refer to embedded help.

## Capturing Statistics

The product provides objects to allow for an edge product or an implementation to periodically calculate and capture statistics for one or more use cases. The topics in this section provide information about what is supplied in the framework and guidelines for implementing specific use cases.

### About Statistics

There are two objects that work together to capture the statistics related to a given business use case:

- The statistics control record which defines configuration related to capturing statistics. It also defines a category that is used to group similar types of statistics together.
- The statistics snapshot is the record where the actual calculated statistics are captured.

### Statistics Control

The statistics control record defines whether or not statistics are automatically calculated and how frequently. In addition, you may control the retention policy of snapshot record. You may indicate that only the most recent snapshot is kept or all snapshot records are kept or that they are retained for a defined number of days.

The system provides a business object for statistics control (**F1-Statistics**) that is expected to be used for most use cases. Its lifecycle includes the support for periodic capturing of statistics snapshot records as well as on demand capture.

### Statistics Snapshot

The statistics snapshot object is the object that is responsible for calculating and capturing the statistics details. A separate business object must be defined for each use case. The schema of the business object defines the details that are captured. In addition, it must include an algorithm as an enter plug-in on the **Complete** state that is responsible for capturing statistics.

The system provides a 'root' business object for statistics snapshot (**F1-SnapshotRoot**) which includes the lifecycle that statistics snapshot business objects should follow. No explicit statistics snapshot use case is provided by the Framework. Your specific product may supply some out of the box support for certain use cases, in which case specific statistics snapshot business objects are provided. Refer to your product specific documentation for more information.

### Viewing / Reporting Statistics

The product provides the mechanism for defining statistics control and statistics snapshot records and viewing the data in basic format. If your product has provided support for specific use cases, there may also be additional portals used to display the statistics in a meaningful format. For example, the statistics snapshot may be capturing data that can be

presented in graphical format. Additionally, if multiple historical statistics snapshot records are retained, a zone may be defined to graph changes over time.

## Configuring Your System for Statistics

If your product provides statistics use cases that you are planning to implement, all that you need to do is configure the appropriate statistics control record and define the appropriate configuration for your business requirements. Refer to [Defining and Monitoring Statistics](#) for more information.

If your implementation has identified an additional use case where you would like to capture statistics, the following points highlight the steps needed to configure the system to support the use case.

- Determine whether an additional Statistics Category value is needed. This is captured on the statistics category record. Navigate to the [Lookup](#) page. Search for and select the **STAT\_CATEGORY\_FLG** field. Review the values and determine if additional values are needed.
- Define a new statistics snapshot BO. This should be a child BO of the base delivered BO (**F1-SnapshotRoot**). Its schema should define elements for the specific information that is captured by the statistics calculations. The schema should be designed in conjunction with an appropriate Enter Status algorithm for the **Complete** that calculates the statistics as appropriate for the business requirement.
- Once the snapshot business object is designed and implemented, configure the appropriate statistics control record.

## Defining and Monitoring Statistics

Refer to [About Statistics](#) for an overview of the statistics functionality.

To define and maintain statistics control records and view a list of the current snapshot records, open **Admin > Reporting > Statistics Control**.

This is an [All-in-One portal](#) and includes the standard List and display zones for a statistics control.

For information about the data defined on the statistics control, refer to embedded help.

### Statistics Snapshot

If there are any Statistics Snapshot records for the statistics control, the **Statistics Snapshot List** zone displays a list of the most recent records. A user may drill into any of the records to view more detail. You are brought to a maintenance portal where you may view details about the calculated statistics. The information captured will be unique to the particular use case. Refer to the embedded help for more information.

## Creating Cube Views

Many implementations require the ability to extract and analyze complex sets of data in a way that is simple to visualize and supports business or organizational decision making. A common model for performing this type of analysis is a multi-dimensional array, often referred to as a data cube. Cube views allow data to be represented in a way that provides the user with multiple perspectives of the results.

Although called a "cube", a cube view can have two, three or a higher number of dimensions. Each dimension represents some attribute in the database and the cells in the data cube represent a measure or value. For example, a cell could contain a count of the number of times that attribute combination occurs in the database, or the minimum, maximum, sum or average value of data related to that attribute. Queries are performed on the cube to retrieve information.

The framework provides objects to support the definition of data cubes and a flexible means of viewing them. The topics in this section provide information about what is supplied in the framework to assist in implementing a cube view. Your product may also supply out of the box support for relevant use cases. Refer to your product documentation for more information.

# About Cube Viewer

The framework provides a cube viewer portal which is intended to be used for most implementations of cube views. It supports a number of common actions and data representations.

**NOTE:** The choice of appropriate menu for the Cube Viewer portal will differ from product to product. Refer to your product specific documentation for more information on how to access the viewer.

The following sections describe the basic concepts and features of the cube viewer.

## Cube Viewer Components

The base Cube Viewer interface is comprised of the following main areas:

1. The Toolbar
2. The Settings Area
3. The Filters Area
4. The Views Area

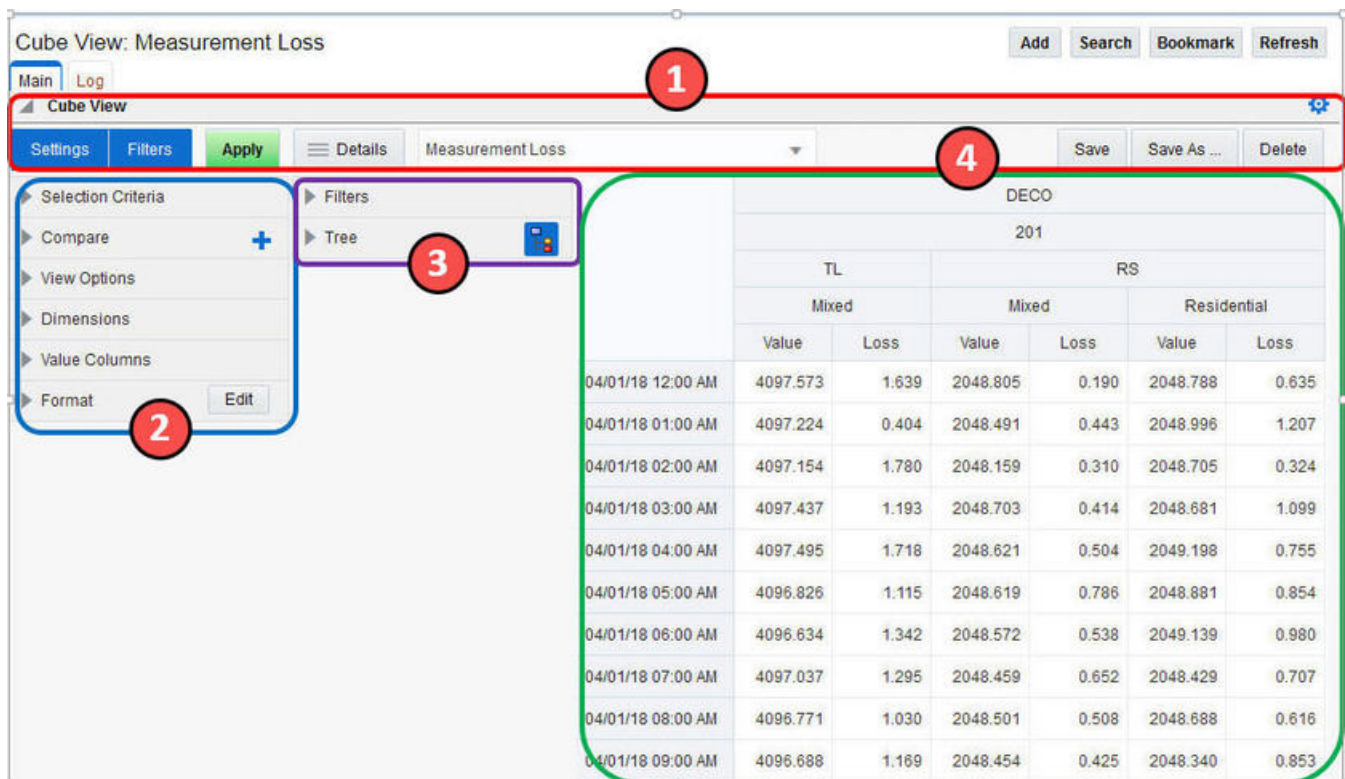

The next topics provide more information about each component.

## The Toolbar

This following features are available on the Cube Viewer toolbar.

## Settings and Filters Buttons

Click the **Settings** and **Filters** toggle buttons to collapse and expand the respective [Settings](#) or [Filters](#) areas.



## Apply Button

Click the **Apply** button to apply any changes to the settings and display the new results in the views.



## Details Button

Click the **Details** button to open a dialog box in which additional attributes of the current cube view can be viewed and updated. Refer to [Cube View Details](#) for more information about the attributes displayed.

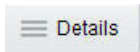

## Cube View Dropdown

Click the **Cube View Dropdown** to open a list of cube views, of the same type as the current view, to which you have access. Selecting a cube view from the list will open that view. Use the search box to search for a view within the list using the cube view description.



## Save, Save As and Delete Buttons

Click the **Save** button to save the current settings for the cube view. Click the **Save As** button to create a copy of the current cube view. Click the **Delete** button to delete the current cube view.

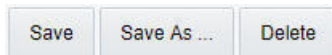

## Cube View Details

Clicking the **Details** button on the cube viewer **Toolbar** allows you to maintain the following information for the cube view:

- The short **Description** for display in the viewer header and a more **Detailed Description** for capturing additional information about the cube view.
- An **Access Type** of shared, private or public.
- The **Access Group** that defines the group of users with access to the cube view. This field is only visible if the access type is shared.
- A specific **User** who has sole access to the cube view. This field is only visible if the access type is private.
- The **Row Functions** text box in which the functions to be applied to the values across the rows in the data grid are defined. Clicking anywhere in the box will display a list of supported functions to choose from.
- The **Column Functions** text box in which the functions to be applied to the values in the columns in the data grid are defined. Clicking anywhere in the box will display a list of supported functions to choose from.
- An **Inactivate** button. Click this button to deactivate this cube view.



The **Fixed Parameters** for the cube view are displayed but cannot be updated here. Refer to [Configuring Cube Types](#) for more information on cube view parameters.



## The Settings Area

The Settings Area contains a number of sections whose inputs control various aspects of the current cube view.

### Selection Criteria

Open the **Selection Criteria** section to enter filter values for the user parameters defined on this cube type. User parameters that have been configured as 'Save with Cube View' on the cube type will be saved when the cube view is saved.

### Compare

Open the **Compare** section to enter one or more sets of criteria that are used to retrieve data sets for comparison to the data retrieved by the main Selection Criteria. Use the Add, , and Delete, , buttons to add or remove a set of criteria. The comparison values will be displayed side by side with the main cube values in the data views. Note that the pseudo dimension **Dataset** must be included as a dimension column in order to display comparison views.

### View Options

Open the **View Options** section to access buttons that toggle on and off the display of the supported data view types. The buttons can be used to change the order in which the views are displayed, using drag and drop. Any changes made to the default button settings will be saved when the cube view is saved. Refer to the [Views Area](#) topic for more information on the available data views.

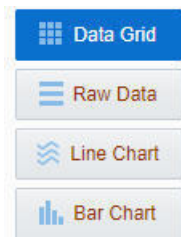

### Dimensions

Open the **Dimensions** section to view the list of dimensions defined on this cube type, as well as the pseudo dimension **Dataset** and the date/time filter, if applicable. Use drag and drop to move a dimension into the list of **Columns** or **Rows** displayed in the data views. Moving a dimension into the **Unassigned** list will remove it from the data views.

### Format

Click the Edit button on the **Format** section to open a dialog box in which conditional formatting, such as background or text color, can be defined for the values in the data grid. Refer to [Defining Conditional Formatting](#) for more information about the formatting controls.

---

**NOTE:** Changes made to the settings will only be reflected in the views when the **Apply** button is pressed, with the exception of the **View Options**, where changes are reflected immediately upon toggling or rearranging the buttons.

---

## Defining Conditional Formatting

Clicking the **Edit** button in the **Format** section of the **Settings** area allows you to define formatting rules for the display of values in the cube view data grid. The rules are based on mathematical expressions or formulas which use the cube view values as variables.

The formulas must be expressed using the field names of the values for the cube, as used in the cube view query zone. A list displaying the **Column Name** and associated **Label** for each value configured in the cube view is provided, to assist in defining the formulas.

The following attributes need to be defined for each rule:

- The **Sequence** defines the order in which the formatting rules are evaluated.
- The **Active** check box indicates whether the rule should be applied or not..
- The **Formula** defines the mathematical expression that is evaluated to determine whether the formatting should be applied. The expression variables should reference the **Column Name** of the value.
- **Format** defines the formats to be applied to cells whose value meets the condition expressed in the formula. The formats include the **Background** and **Text** colors and whether the text should be in **Bold**.
- The **Stop If True** check box indicates whether to stop evaluating the remaining formulas in sequence if this formula evaluates to true.

## The Filters Area

The Filters Area provides the ability to select and apply dimension filters to the current view.

The **Tree** section displays a hierarchical view of the dimension values in the current cube view. Clicking a value will cause it to be displayed in the **Filters** section and immediately applies that filter to the data in the currently selected views. To remove a dimension from the filters, click on the value in the **Filters** section.

The **Hierarchical Filtering** icon, , is used to toggle between hierarchical and non-hierarchical selection mode. In hierarchical mode, clicking a dimension value at any level in the tree will automatically populate the filters with the related higher level dimension values. In non-hierarchical mode, only the selected dimension value is added as a filter.



Use the expand and collapse icons, , to quickly expand the tree, one level at a time, below the currently selected dimension value or collapse the entire level.

## The Views Area

This section describes the types of views supported by the Cube Viewer.

### Data Grid

The **Data Grid** displays the cube view data set in the form of a pivot table. The fields that appear as rows and columns in the table are defined in the **Dimensions** section of the [Settings](#) area. The default aggregation function used for the values is sum. Additional functions can be defined in the details of the cube view. Refer to the description of the **Details** pop-up window in the [Toolbar](#) area for more information.

### Raw Data

The **Raw Data** view displays the cube view data set as a flat table.

### Line Chart

The **Line Chart** displays cube view data in a chart with a time sequence as the X-axis and value intervals as the Y-axis. Each line corresponds to a specific combination of the selected dimensions. This view is only visible if the cube view includes at least one date/time filter in the selection criteria. If the criteria include more than one date/time field, the first date/time filter in order is chosen for the time sequence.

## Bar Chart

The **Bar Chart** also displays cube view data in a chart with a time sequence and value intervals. Each bar corresponds to a specific combination of the selected dimensions. This view is only visible if the cube view includes at least one date/time filter in the selection criteria. If the criteria include more than one date/time field, the first date/time filter in order is chosen for the time sequence.

## Cube Configuration Components

Cube views are supported using a number of standard configuration components.

The system provides a business object for cube views (**F1-CubeView**) which is used to capture access controls and the settings, such as user parameter values, for a cube view instance. The business object also defines the portal navigation and the base display UI Map (**F1-CubeViewDisp**) and accompanying display map service script ( **F1\_CubeViewD**). The display map and service script together drive the functionality supported in the cube viewer.

---

**NOTE:** The system also supplies a UI map fragment (**F1-CubeViewProc**) which is used to display a cube view in a process flow panel. Refer to [Process Flows](#) for more information.

---

The system provides a portal for cube views (**F1CUVWM**) that can be configured on the appropriate menu item or other navigation path for your implementation. The portal is linked to the base cube view zone (**F1-CUBEVIEW**).

In addition, the system supplies a simple query by cube view information (**F1-CUBVIWQ1**) that is the single entry on a base multi-query zone (**F1-CUBVIWQ**). The multi-query zone is not linked to the base portal as the expectation is that implementations will need to create searches tailored to their specific use cases for cube views. The base multi-query provides a quick means of configuring a cube view search while in development mode.

## Configuring Cube Types

Cube Types are used to capture the details that define the sourcing of the data for a cube view and parameters that control certain features of the cube viewer. These details include:

- The business service whose associated zone defines the query used to select and filter the data for the cube view.
- The user parameters that correspond to the filters for this cube type's business service and zone.
- The user parameter settings that determine whether a given filter value should be saved with the cube view and whether the value should be populated from global or portal context, if applicable.
- The fixed parameter values to be applied as hidden filters for cube views of this type.
- The results from the business service and zone to be used as dimensions in the cube view and those that are the cube view values.
- The dimension settings that determine the order in which the dimensions are displayed in the data grid, which dimensions are to be used as filters in the cube view and which dimensions are to be included in the cube view tree.
- The values settings that determine the default sequence in which the values are displayed in the data grid.
- The FK Reference used to navigate from the data grid to the underlying source data.

If your product provides business services that support cube views you plan to use, all you need to do is configure the appropriate cube type records. Refer to [Maintaining Cube Types](#) for more information.

If your implementation has identified additional cube views you need to implement, you will need to create a zone and business service that use specific techniques for defining the SQL to derive the source data for the view and for mapping the results. Refer to [Cube Type Advanced Topics](#) for more information

## Maintaining Cube Types

Refer to [Creating Cube Views](#) for an overview of the cube viewer functionality.

To define and maintain cube type records, open **Admin > Analytics Configuration > Cube Type**.

This is an [All-in-One portal](#) and includes the standard list and display zones for a cube type.

For information about the settings defined on the cube type, refer to [Configuring Cube Types](#) and the embedded help.

## Cube Type Advanced Topics

The following topics describe the technical models that need to be followed when creating a new cube type.

### Designing Your Cube Type SQL

In order to support the base cube viewer, the SQL used in your cube type data explorer zone needs to be constructed with two main components. The first component creates a view of the data and its dimensions in a form that supports a tree-like structure and allows for the dynamic use of filters. The second component queries the filtered data set to provide the values to be displayed for each dimension.

The first component should contain the following queries:

- A sub-query constructed using a 'with' clause that builds a tree-like view of the cube's dimensions and optionally other columns used in the main SQL. This portion of the SQL must be enclosed within '/\*>tree\*/' and '/\*<tree\*/' hints and use the table alias **C\_TREE**. The combination of the dimension columns should form a unique 'key' in the **C\_TREE** data. Both the 'with' clause and the 'tree' portion within it may contain other supporting sub-queries.
- A sub-query which is the placeholder for filtered queries on the 'tree' data. It must use the table alias **C\_FILTER** and take the form 'C\_FILTER as (select \* from C\_TREE where 1=1 and ROWNUM <= n)'. The value of 'n' should be set to limit the rows returned to a number that is manageable within the cube viewer.

The second component is the main query that retrieves the measures for the cube view dimensions. This query references **C\_FILTER** as the subset of the **C\_TREE** and joins with other tables if required to retrieve the numeric values. The first date or date/time result column of the main query (as specified in the zone configuration) designates a time-series column, which forms the time-series 'key' with the dimensions columns.

### Defining Your Cube Type Business Service

The business service that identifies the zone for a cube type is also used to provide additional configuration options.

The business service schema should define meaningful element names for the parameters, dimensions and values. It should also define labels for those elements to be used by both the cube type and cube viewer user interfaces. The labels can be derived by mapping the element to a meta-data fields or by using the 'label=' syntax to define a text string directly in the schema definition. The 'required=true' syntax can be used to require a value to be entered for a user parameter on the cube viewer or for a fixed parameter on the cube type.

The user parameter elements are expected to be defined within a group in the schema called 'input' and the fixed parameters within a group called 'hidden'.

## External Messages

This section describes mechanisms provided in the product that enable an implementation to configure the system to communicate with an external application.

## Incoming Messages

This section provides information about support for incoming messages.

## Inbound Web Services

Inbound web service functionality is provided to support receiving web service requests from an external system.

### Understanding Inbound Web Services

The system supports communicating with the system via RESTful services or via SOAP services. In both cases, the system uses an object called inbound web service (IWS) to store the configuration. A web service class is used to distinguish whether the IWS is used for REST or SOAP. There is also a distinct business object for each web service class value because there is different configuration for each type of IWS.

For both types of inbound web service, the system supports the configuration of one or more operation per web service. Each operation defines the schema-based object to invoke to perform the desired function. An operation may refer to a Business Service, a Business Object, or a Service Script. If the IWS supports multiple operations, each operation can refer to the same or a completely different schema-based object from other operations within the IWS.

The following topics provide more information about the different configuration of IWS based on whether it is SOAP or REST.

### Inbound REST Web Services

There is some configuration that is specific to inbound REST web services:

- Each Inbound REST Web Service must reference a resource category. This category is used to associate the web service with a 'resource' (a common term used for RESTful services). For multiple IWS records linked to the same resource category, external catalogues can use this information to group together related web services.
- Each operation must define the HTTP Method and a Resource URI. This information along with the IWS name is used to compose the URI for this RESTful web service. The resource URI must begin with a slash ('/'). In this release only the HTTP Method of POST is supported.
- For operations that reference a business object, the transaction type must be provided. The REST syntax doesn't support defining the transaction type at runtime.

---

**NOTE:** Using the transaction type **Change** requires all values to be passed in. Using the transaction type **Update** allows the web service to pass only the primary key and the values to be updated. All other elements will retain their existing values.

---

### Inbound SOAP Web Services

For inbound SOAP web services, by default the system uses the Schema Name to dictate the Request and Response for the service. The API can be overridden with custom formats by specifying Request and Response Schemas with the appropriate Request and Response XSL to transform into the relevant schema formats.

In addition, note that for business object based operations, when invoking the web service an action is required. This may be passed into the web service as part of the invocation or alternatively, the action may be defined when configuring the operation using the transaction type.

---

**NOTE:** Using the transaction type **Change** requires all values to be passed in. Using the transaction type **Update** allows the web service to pass only the primary key and the values to be updated. All other elements will retain their existing values.

---

## Annotations Used for Security

When preparing to deploy inbound SOAP web services, the security aspects of the service must be decided. The product provides a default security policy that is applied when no other policy is defined: **@Policy(uri="policy:Wssp1.2-2007-Https-BasicAuth.xml", attachToWSDL=true)** which requires HTTP Basic over SSL and a WS-Security Timestamp.

If a different security policy is desired, the following options are available:

- Security policies may be attached to the Inbound Web Service via the Java Enterprise Edition (Java EE) Web Application Server. This allows for multiple policies to be attached as supported by the Java EE Web Application Server. In order to enable this capability, explicit system configuration is required so that the product does not assume the default security policy. See the subsequent bullets for more information.
- Define a system wide security policy using a feature configuration option. Find the [Feature Configuration](#) record for the **External Messages** feature type. (It may need to be defined if it does not exist). Choose the option type **Default security policy** and define an appropriate value. If your implementation wishes for the policies to be attached at the Java EE Web Application Server, define this option type with an option value of **<none>**.
- Attach a security policy to the IWS via a Web Service Annotation. The base product provides annotation types that support the standard WS-Policy (**F1POLICY**) and OWSM Security Policy (**F1-OWSM**). No base annotation is supplied by the product for either annotation type.

If your implementation wishes for the policy of a particular IWS to be attached at the Java EE Web Application Server, define a special annotation for the **F1POLICY** annotation type and configure the **uri** parameter value to **<none>**.

---

**NOTE:** Refer to WebLogic documentation for more information on supported security policies.

---

---

**NOTE:** In order to use the OWSM Policy, additional system configuration is necessary. Contact your system administrator to confirm if your implementation supports OWSM.

---

## Inbound SOAP Web Service Deployment

A Inbound SOAP Web Service must be deployed to the Java EE Web Application Server in order for it to be available to the Web Service Clients to access the system. Refer to [Deploying SOAP Web Services](#) for more information.

## Deploying XAI Inbound Service via IWS

For implementations using XAI inbound services for external messages, the product recommends moving to the inbound web service mechanism, which uses the Java EE Web Application Server to communicate with the product rather than the XAI servlet.

For XAI inbound services that use the **Business Adapter**, it is straight forward to move to IWS because the configuration is similar. In both cases, the service is configured to reference a business object, business service or service script. The associated WSDL for each record is similar. Changing the interface for the incoming message to use IWS instead of XAI inbound services is similar.

However, for XAI inbound services that use the **Core Adapter**, these services reference an underlying "page service" in the product. For these services, the Request and Response schemas for the XAI inbound service were created using the Schema Editor. In order to support calling an underlying "page service" in IWS, first a [business service](#) must be created to reference the page service (if one doesn't already exist). However, the resulting schema for the business service is different from the Request and Response schemas related to the XAI inbound service. Moving this functionality to IWS using business services requires changes to the format of the incoming messages.

Moving all incoming messages over to use IWS instead of XAI is the product recommendation. However, to aid in implementations that have many integrations in place using the XAI inbound services that use the **Core Adapter** (or any adapter whose message class is **BASEADA**), the product provides the ability to deploy these types of XAI inbound services to the Java EE Web Application Server along with the Inbound Web Services.

To take advantage of this capability, you must define a feature configuration option. Under the **External Messages** feature configuration type, the **Support XAI Services via IWS** is used to indicate if this feature is supported. Setting the value to **true** turns on the feature. If no option is defined for that option type, it is equivalent to setting the value to **false**.

When the system is configured to support XAI services via IWS, the [Inbound SOAP Web Service deployment](#) includes XAI inbound services (that are configured with an Adapter that references the **BASEADA** message class). The deployment portal will also include a zone showing the deployment status of these XAI Inbound Services.

---

**NOTE:** There is no support for XAI inbound services via REST, only via inbound SOAP web services.

---

## Configuring Inbound Web Service Options

This topic describes the configuration needed for using inbound web services.

## Configuring SOAP Inbound Web Service Options

This topics in this section describes the configuration needed for using inbound SOAP web services.

## Technical Configuration

In order to use inbound web services, there are tasks a system administrator must perform.

Refer to the Server Administration Guide for technical details of each of these processes.

## Maintaining Web Service Annotation Types

The product provides some base annotation types. Refer to the metadata for more information. If your implementation wishes to define additional annotation types, use the Web Service Annotation Type portal. Open this page using **Admin > External Message > Web Service Annotation Type**.

You are taken to the query portal where you can search for an existing web service annotation type. Once an annotation type is selected, you are brought to the maintenance portal to view and maintain the selected record.

---

**NOTE:** Use of custom policies should only be considered if the policies supplied by the Java EE Web Application Server are not sufficient for your implementation's needs.

---

**CAUTION:** Important! When adding new records, carefully consider the naming convention of the web service annotation type code. Refer to [System Data Naming Convention](#) for more information.

---

The **Web Service Annotation Type** zone provides basic information about the web service annotation type.

Please see the zone's help text for information about this zone's fields.

The system supports the ability for an IWS record to refer to multiple policies. In this situation, the annotation type for the policy should include a reference to a parent annotation type so that the system can properly build the array of annotations.

### Where Used

Follow this link to open the data dictionary where you can view the tables that reference [FI\\_IWS\\_ANN\\_TYPE](#).

## Maintaining Web Service Annotations

If your implementation wishes to define annotations, use the Web Service Annotation portal. Open this page using **Admin > Integration > Web Service Annotation**.

This is a standard [All-in-One portal](#).

---

**CAUTION:** Important! When adding new records, carefully consider the naming convention of the web service annotation code. Refer to [System Data Naming Convention](#) for more information.

---

### Where Used

Follow this link to open the data dictionary where you can view the tables that reference [FI\\_IWS\\_ANN](#).

## Maintaining XAI Inbound Services

XAI Inbound Service is a legacy mechanism for exposing system services to external systems as web services. The current supported mechanism for defining web services is [Inbound Web Services](#), which should be used for any new web service.

Some framework based products and existing implementations may have existing XAI inbound services that may need to be viewed. For these services, the product supports deploying them as SOAP inbound web services for execution. Refer to [Deploying XAI Inbound Service via IWS](#).

The following sections describe basic information about the maintenance pages. Note that some of the information is related to legacy functionality that is no longer supported.

### XAI Inbound Service - Main

To view an inbound service, open **Admin > XAI > XAI Inbound Service**.

#### Description of Page

**XAI In Service Name** is used in the system to identify the service. The service name is also the first XML element after the <Body> element in the XML request/response document. The **XAI Service ID** serves as the primary key.

**Owner** indicates if this XAI inbound service is owned by the base package or by your implementation ( **Customer Modification**). This information is display-only.

The **Adapter** defines the interface with the target application server.

If adapter for this service invokes a system service, then the appropriate **Service Name** is visible.

If adapter is the **Business Adapter** then **Schema Type** and **Schema Name** reference the object to invoke.

**Web Service Category** is visible if the XAI inbound service is linked to one or more [web service categories](#).

Use the **Description** and **Long Description** to describe the service.

Check the **Active** switch if this service is enabled and available for execution.

**Post Error** is not applicable.

**Trace** is not applicable.

**Debug** is not applicable.

#### Schema Definitions

---

**NOTE:** Request Schema and Response Schema are not applicable to services invoking schema-based objects. They do not appear when the **Business Adapter** is used.

---



The next two properties define the request and response XML schemas. The schemas are SOAP compatible. The schema XML files are expected to be stored in the Schemas Directory on the Web server running the XAI server.

The **Request Schema** is the XML schema defining the service request. The request sent to the server must adhere to the schema definition.

The **Response Schema** is the XML schema defining the service response. The response generated by the XAI server corresponds to the response schema definition.

The same service may perform several actions on a business object. Use the **Transaction Type** to define the default action performed by a service. The transaction type can be provided when invoking a service, by dynamically specifying a transaction type attribute on the Service element of the XML request. This field may take the following values: **Read, Add, Change, Update, Delete, List** and **Search**.

---

**NOTE:** The difference between **Change** and **Update** is that for **Change**, all field values must be passed in with the request. Field values that are not passed in to the request are set to null. For **Update**, you need only pass the primary key field values and the values of the fields to be updated. All other fields retain their existing values.

---

Services, which perform a Search, may allow searching based on different criteria. When the Transaction Type value is **Search**, use the **Search Type** to define the default search criteria. The possible values are **Main, Alternate1, Alternate2, Alternate3, Alternate4, Alternate5** and **Alternate6**.

---

**NOTE:** This is a default definition only and it may be overridden at run time when the service is invoked. To override the search type at run time, you should specify the searchType attribute on the Service element of the XML request.

---

### **XSL Transformation Definitions**

Sometimes, the XML request document does not conform to the request schema, or the response document expected by the service requestor is not the one generated by the adapter. In such cases the request and/or the response documents must be transformed. The XAI server supports transformation through XSL transformation scripts. Transformation scripts may be applied to the request before it is passed to the adapter or applied to the response document before it is sent to the service requestor.

The **Request XSL** is the name of the XSL transformation to be applied to the request document before processing it. The transformation is usually required when the incoming document does not correspond to the XAI service request schema therefore it has to be transformed before it can be processed by the adapter.

The **Response XSL** is the name of the XSL transformation to be applied to the response document when the requester of the service expects the response to have a different XML document structure than the one defined by the response schema for the service.

Click the **WSDL URL** hyperlink to launch a separate window that contains the WSDL definition for the inbound service. Note that the server name and port number for the URL are built using a setting in the common properties file using the XAI HTTP Caller URL setting.

### **XAI Inbound Service - Staging**

The configuration on the staging tab is no longer supported.

### **XAI Inbound Service - Parameters**

The configuration on the parameters tab is no longer supported.

## **Configuring REST Inbound Web Service Options**

This topics in this section describes the configuration needed for using inbound REST web services.

## Resource Category Lookup

Refer to [Inbound REST Web Service](#) for an overview of REST IWS functionality.

Each Inbound REST Web Service is associated with a Resource Category. The categories are defined as an extendable lookup.

Navigate to the [Extendable Lookup](#) portal. Search for and select the **Resource Category** business object. Define values as needed. Typically the category is related to an entity, or maintenance object, referred to as a 'resource' in REST nomenclature. In some cases, an edge application may have already delivered appropriate resource categories for your use.

Refer to the embedded help for more information about configuring this object.

## Maintaining Inbound Web Services

[Inbound Web Services](#) are used to define a specific message that your implementation will receive from an external system and provides configuration needed to process the inbound message.

The product provides support for REST and SOAP services and provides several inbound web services out of the box.

For inbound SOAP web services, by default no annotations are defined for the base inbound web services. You may modify the message options or the annotations for any base IWS record. In addition, you may define additional IWS records for other incoming messages supported by your implementation.

To view an inbound web service, navigate using **Admin > Integration > Inbound Web Service**. You are brought to a query portal with options for searching for inbound web services.

Once an inbound web service has been selected, you are brought to the maintenance portal to view and maintain the selected record.

---

**CAUTION:** Important! When adding new records, carefully consider the naming convention of the inbound web service code. Refer to [System Data Naming Convention](#) for more information.

---

The **Inbound Web Service** zone displays the configuration information for the record and its operations. For information unique to the web service class of REST or SOAP, refer to the embedded help.

Note that in addition to standard actions available on this portal, there is also a special **Add to Category** button in the page action area. Click this button to link an inbound web service to one or more [web service categories](#).

## Deploying Inbound SOAP Web Services

Once an Inbound SOAP Web Service is defined it is not automatically available to the Web Service Clients to access the system. The Deployment Status and the Active flag (set to true) indicate whether a Web Service is available or not. The last step is to deploy the Inbound SOAP Web Services to the Java EE Web Application Server. This deployment phase has a number of steps that are automatically performed when a deployment is initiated:

- The Web Service files are generated and policies are attached.
- The WSDL is generated with appropriate annotations and enumerations.
- The necessary Java stub code to implement the Web Service in the Java EE Web Application Server is generated and compiled.
- The Web Services are built into a valid Web Application Archive (WAR) file.
- Optionally, the newly created Web Services WAR file is deployed to the Java EE Web Application Server. This can also be done manually for clustered deployments, if desired.

There are two methods available for deploying inbound SOAP web services:

- Deployment at the command line using the **iwsdeploy[.sh]** command as outlined in the Server Administration Guide. This method is recommended for native installations and production implementations.
- Deployment using the Inbound Web Service Deployment portal. This method is only supported in development (non-production) environments.

## Inbound Web Service Deployment Portal

To use the online Inbound Web Service Deployment portal, navigate using **Admin > Integration > Inbound Web Service Deployment**.

The following sections describe the base zones that are provided on the portal.

### Deploy Inbound SOAP Web Services

The Deploy Inbound SOAP Web Services zone provides information about the last deployment. If the region is a development (non-production) region you may use the **Deploy** button to deploy or re-deploy inbound web services. All inbound web services whose Active switch is Yes will be deployed. All whose active switch is No will be undeployed.

---

**NOTE:** When an Inbound SOAP Web Service is deployed, the value of its service revision field is captured. Certain changes to configuration will require re-deployment to take effect. When any of the following changes occur, the IWS service revision value is incremented. This will cause the deployment status to show **Needs Deployment**.

- Active switch is changed
- An Annotation is added or removed
- An Operation is added or removed.
- The Operation Name, Schema Type / Schema Name, Request or Response Schema, Request or Response XSL for an Operation is changed.

---

**NOTE:** In addition, if the implementation supports XAI services deployed through IWS, the appropriate XAI inbound services will also be deployed or undeployed as required.

---

### Deployment Status

The Deployment Status zone displays a list of inbound SOAP web services in the product, including the deployment status.

The deployment status is determined by comparing the internal Service Revision field on each IWS against the value captured at the time of deployment.

- **Deployed.** Indicates that the IWS has been deployed and no changes have been detected to the configuration.
- **Needs Deployment.** Indicates that the IWS has never been deployed or has been deployed but in the meantime, changes have been detected to the configuration that require redeployment.
- **Undeployed.** Indicates that the IWS is marked as inactive and the IWS is not found to be deployed at this time.
- **Needs Undeployment.** Indicates that the IWS is marked as inactive but the IWS is found to be deployed at this time.

If the IWS has been deployed, the View column will include a **WSDL** link allowing you to launch a separate window to view the WSDL definition.

Use the broadcast button adjacent to any of the inbound web services listed in the zone to view the details of the IWS record. This causes the **Inbound Web Service** zone to appear. It is the same zone that appears on the [Inbound Web Service](#) maintenance portal.

### XAI Inbound Service Deployment Status

The XAI Inbound Service Deployment Status zone is only visible if the feature configuration option **Support XAI Services via IWS** is configured on the **External Messages** feature type or if the system detects that there are XAI inbound services that have been deployed. (The latter condition is checked for the case where an implementation has XAI inbound services deployed and then chooses to discontinue using this functionality. After changing the feature configuration option to false,

one more deployment is required to "undeploy" the XAI services.) The zone displays a list of XAI inbound services in the product that are related to page services. Refer to [Deploying XAI Inbound Service via IWS](#) for more information.

The deployment status is determined by comparing the record's Version field against the value captured at the time of deployment.

- **Deployed.** Indicates that the XAI inbound service has been deployed and no changes have been detected to the configuration.
- **Needs Deployment.** Indicates that the XAI inbound service has not been deployed or has been deployed but in the meantime, changes have been detected to the configuration.
- **Undeployed.** Indicates that the XAI inbound service is marked as inactive or the **Support XAI Services via IWS** is not set to **true** and the XAI inbound service is not found to be deployed at this time.
- **Needs Undeployment.** Indicates that the XAI inbound service is marked as inactive or the **Support XAI Services via IWS** is not set to **true** but the XAI inbound service is found to be deployed at this time.

XAI inbound service does not have the equivalent of a Service Revision field that inbound web service has, which is only incremented when changes are made to the record that impact deployment. For XAI inbound service, the version number on the record is used. This field is incremented when any changes are made, even ones that may not impact deployment. As a result, some XAI Inbound Services may indicate "Needs Deployment" in cases where a redeployment may not be necessary. The recommendation when this occurs is to simply Deploy again to be safe.

If the IWS has been deployed, the View column will include a **WSDL** link allowing you to launch a separate window to view the WSDL definition.

## Guaranteed Delivery

There are alternatives for sending messages to the system besides using inbound web services. An external system may be able to send messages to the system in a generic manner where a new web service does not need to be defined for every new type of message. These types of messages may provide a payload (the message) and the service script or business service to invoke. An example of this type of communication is a message sent from a mobile application using RESTful operations.

The external system may have no mechanism for retrying failed messages. For this situation, the product provides an algorithm that may be used to capture incoming messages that should 'guarantee delivery'. A servlet processing this type of message may invoke the [installation algorithm](#) - Guaranteed Delivery, passing the details of the message and an indication if a response should be returned. The algorithm is responsible for storing the message information in a table so that it can be subsequently processed.

---

**NOTE:** The framework provides an algorithm that stores the message in the Remote Message table.

---

## Outgoing Messages

"Outgoing messages" is the term used to describe messages that are initiated by our system and sent to an external system. Messages may be sent real time or near real time. The system provides the following mechanisms for communicating messages to external systems.

- **Outbound Messages.** This method allows implementers to use configurable business objects to define the message format and to use scripts to build the message. If sent near real-time the message is posted to the outbound message table waiting for Oracle Service Bus to poll the records, apply the XSL and route the message. If sent real time, the message dispatcher routes the message immediately.
- **Web Service Adapters.** Using a web service adapter, an implementation can consume a WSDL from an external system and create an "adapter" record that references the URL of the external system and creates appropriate request and response data areas to expose the payload information in a format understood by configuration tools. A script may then be written to build the request information and initiate a real-time web service call from within the system.

- **Send Email.** The system supplies a dedicated business service that may be used to send an email real-time from within the application.

All these methods are described in more detail in the following sections.

## Outbound Messages

Outbound messages provide functionality for routing XML messages to an external system real-time or in near real time. In addition the functionality supports collecting related messages into a batch to then be sent to an external system as a consolidate XML message.

For each outbound message that your implementation must initiate you define a **business object** for the outbound message maintenance object. Using the business object's schema definition, you define the fields that make up the XML source field. These are the fields that make up the basis for the XML message (prior to any XSL transformation).

Each outbound message requires the definition of its schema by creating a business object whose schema describes the information that is provided to the external system. An XSL transformation may then be performed when routing the message to an external system.

For each external system that may receive this message, you configure the appropriate message XSL and routing information.

Because the outbound message type is associated with a business object, your implementation can easily create outbound message records from a script using the **Invoke business objectstep type**. Such a script would do the following:

- Determine the appropriate **outbound message type** and **external system** based on business rules
- Access the data needed to populate the message detail
- Populate the fields in the schema and use the **Invoke business object** script step type for the outbound message type's business object to store the outbound message.
- The resulting outbound message ID is returned to the script and the scriptwriter may choose to design a subsequent step to store that ID as an audit on the record that initiated this message.

The following topics provide more information about functionality supported by outbound messages.

## Polling Outbound Messages Using OSB

If the outbound message that needs to be sent to an external system can be sent as an asynchronous message (in 'near real time'), the process initiating the outbound message should create a record in the outbound message staging table. Oracle Service Bus (OSB), is the recommended tool to use to process outbound messages in near real-time.

Outbound messages that should be processed by OSB should be configured with a processing method defined as **SOA** for the external system / outbound message type. No other information is required for defining outbound message types that are processed by OSB.

For the OSB part of the processing, the product provides a custom transport: OUF Outbound Message that may be used by an implementation to define messages to process and how to process them.

This section provides an overview of steps required to develop OSB integrations for outbound messages created by your product.

Before developing OSB integrations, a developer should be familiar with OSB development such as creating proxy services, business services, and message flow/routing. These terms are defined as follows:

**Proxy Service:** In OSB, a Proxy Service is the entity that processes a given type of message and routes it to a Business Service. A separate proxy service should be defined for each type of outbound message. If a given outbound message type may be routed to different external systems, it is the responsibility of the proxy service to query the external system defined on the outbound message and invoke the appropriate business service (see below). If any transformation is required prior to routing a message to a business service, it is the proxy service's responsibility to perform the transformation.

**Business Service:** In OSB, a Business Service is an entity that receives a message from OSB and routes it to the appropriate destination. This should not be confused with the Business Service object provided in the product in the configuration tools.

---

**FASTPATH:** Refer to the whitepaper *OSB Integration* for more information.

---

## Batch Message Processing

Your implementation may be required to send messages to the same destination as a single XML file with multiple messages include. The following points describe this logic:

- The individual messages that should be grouped together must have a processing method of **batch** on the external system / outbound message type record. The appropriate batch code that is responsible for grouping the messages must also be provided.
- A separate "consolidated message" outbound message type should be configured for the external system with a processing method of **SOA**.
- When outbound message records are created for the individual messages, the batch code and current batch run number are stamped on the record.
- When the batch process runs it is responsible for building the XML file that is a collection of the individual messages. This batch process should include the following steps:
  - Format appropriate header information for the collection of messages
  - Apply the individual message XSL to each message before including the message
  - Insert a new outbound message for the external system with the "consolidated message" outbound message type.
- The consolidated message is ready to be processed by Oracle Service Bus.

---

**NOTE: No process provided.** The system does not supply any sample batch job that does the above logic.

---

## Real Time Messages

The system supports the ability to make web service calls, i.e. sending real time messages, to an external system.

The system supports special functionality for sending an Email message real-time. Refer to [Sending Email](#) for more information.

For other types of real-time messages, the system also uses outbound message type and external system configuration to format and route the message. When defining the configuration for real time messages, an additional step is required to define the mechanism for routing the message using a message sender. The system supports routing messages via HTTP and via JMS. Note that for HTTP routing, the system also supports sending the message using a JSON format.

Just like near real-time messages, initiating a real-time outbound message may also be done from a script. When a real time message is added, the system immediately routes it to the external system. If the external system provided a response message back, the system captures the response on the outbound message. If the outbound message type for the external system is associated with a response XSL it is applied to transform the response. In this case the system captures the raw response as well on the outbound message. Note that the outbound message BO should be configured to capture a response XML in its schema.

Any error (that can be trapped) causes the outbound message to be in a state of **Error**. It is the responsibility of the calling process to check upon the state of the outbound message and take a programmatic action. When the outbound message state is changed back to **Pending** the message will be retried.

The base package provides two business services: Outbound Message Dispatcher (**F1-OutmsgDispatcher**) and Outbound Message Mediator (**F1-OutmsgMediator**) that further facilitate making web service calls. Both business services are similar, allowing the calling script to configure the following behavior (with differences noted):

- Whether or not exceptions encountered while sending the message are trapped. Trapping errors allows the calling script to interrogate any errors encountered and take some other programmatic action.
- Whether or not the sent message is persisted as an actual outbound message record.
  - If a persisted message is desired, the recommendation is to use the Outbound Message Dispatcher. This business service creates the message using standard BO processing, relying on the outbound message logic to route the message and store the record. The message is routed after the BO pre-processing algorithm and after the record is persisted but before the BO post-processing and audit plug-ins are executed.
  - If the message should not be persisted, then the business service to choose depends on whether you rely on the BO pre-processing algorithm. As mentioned, the Outbound Message Dispatcher creates the outbound message record, relying on the outbound message logic to route the message. If it should not be persisted, it is subsequently deleted. In contrast the Outbound Message Mediator routes the message explicitly without creating a message record. It is more efficient for scenarios that don't require persistence. However, it should only be used if the pre-processing algorithm on the outbound message BO is needed. Note that the Outbound Message Mediator also supports persistence, but it does so by creating the records without using BO processing. This is not recommended. The Dispatcher is the better option if persistence is desired.

Refer to the descriptions of the two business services for more information.

## Designing the System for Outbound Messages

The following sections describe the setup required when using [Outbound Messages](#) to communicate with an external system. The configuration walks you through the steps to configure a single external system and all its messages.

### Define the Outbound Message Business Object and Type

The product supplies many outbound message Business Objects along with Outbound Message Types for out of the box functionality.

In addition, implementations may need to define configuration for custom outbound messages. For each outbound message that must be sent to an external system, create a [business object](#) for the outbound message maintenance object. Using the business object's schema definition, your implementation defines the elements that make up the XML Source field (XML\_SOURCE). These are the elements that are the basis for the XML message. XSL transformations may be applied to this XML source to produce the XML message.

If your integration is real-time and a response is expected, the Outbound Message business object should also map to the XML Response field (XML\_RESPONSE).

- You may decide to capture the response as is and define the element as “raw”. For example

```
<responseDetail mapXML="XML_RESPONSE" type="raw"/>
```

In this scenario, a Response XSL may or may not be needed.

- Alternatively, if the details of the response are needed, you may define specific elements for the response. For this option, depending on how the integration is designed, a Response XSL may be needed to transform the response into the expected XML format.

Once you have your business object and schema, define an [outbound message type](#) for each unique outbound message.

### Capturing the Outbound Message ID in the Message

If your integration would like to use the system generated Outbound Message ID as a unique identifier with the external system, the following configuration is needed:

- Define an element within the XML Source that should be populated with the system generated outbound message.
- Configure a BO Option on the outbound message's business object using the Option Type **Outbound Message ID XPath** and set the Option Value to the XPath of the element defined to capture the ID.



---

**NOTE:** This functionality is only applicable if the outbound message is persisted.

---

## Support for Dynamic URLs

The product supports the ability to build a dynamic URLs. These are cases where the URL requires information determined at runtime. This is supported with a combination of BO schema definition, URL configuration and appropriate code when creating the outbound message. The following points highlight the steps needed to support this functionality.

- When defining the [Message Sender's](#) URL, use the syntax `${pathParms}` in the location of the URL where runtime information must be inserted. For example: `http://my.server.com:1000/rest/services/${pathParms}`
- Include the data area **F1-OM-DynamicConfig** (Outbound message dynamic configuration) in the schema of the business object for the outbound message. This data area includes elements for **pathParms** and **queryParms**.
- In the code that creates the outbound message, populate the **pathParms** and if applicable **queryParms** elements with the appropriate information. The system will build the URL by plugging in the **pathParms** element value followed by a question mark, followed by the **queryParms** element value into the `${pathParms}` location in the URL.

The following is an example of run time values.

```
<dynamicConfiguration>
  <pathParms>job/1234</pathParms>
  <queryParms>firstName=John&lastName=Doe</queryParms>
</dynamicConfiguration>
```

## Add SOAP Header Parameters at Runtime

The product supports the ability to add SOAP header parameters to an external message at runtime. The following points highlight the steps needed to support this functionality.

- Include the data area **F1-OM-DynamicConfig** (Outbound message dynamic configuration) in the schema of the business object for the outbound message. This data area includes the element **soapHeaders**.
- In the code that creates the outbound message, populate the **soapHeaders** element with the self contained XML to add to the SOAP header section of the outgoing SOAP request.

## Real-Time Message Configuration

When messages are routed to an external system real-time using the outbound message dispatcher or using the real-time send email business service. The system supports routing messages using HTTP and routing messages using JMS. In addition, there is a special type of message sender used for sending emails. The following sections highlights the supported real-time communication and the configuration needed for each.

### Email Messages

For sending emails, the following configuration is needed:

- Define a [message sender](#) configured for email. Senders of this type should be configured with the **RTEMAILSNDNR** class. The sender context is used to configure the connection information for the connecting to the SMTP server.
- This sender may be defined as the default email sender on the [message option](#) table. Alternatively, the message sender can be provided to the business service as input. Refer to [Sending Email](#) for more information.

### Outbound Messages

For other outbound messages that are routed using the real-time outbound message dispatcher, a [message sender](#) must be configured to define how to route the message. The following points highlight more detail related to this configuration.

Determine the communication mechanism prior to configuring the sender.

- When routing the message using JMS, the following configuration must be defined



- Define an appropriate [JNDI Server](#) that indicates where the JMS resources are located.
- Define a [JMS Connection](#) to define additional configuration needed for the connection.
- Define the [JMS Queue](#) or [JMS Topic](#) to define the queue or topic to use.
- When communicating using a JSON format, determine the method to use to convert the XML to JSON. The desired method is driven by how the request should be sent.
  - If choosing the **Base JSON Conversion** method, if XSL transformation needs to be applied prior to the conversion to JSON, then the target XML Request Schema must be defined (using a data area) so that the conversion logic knows the format of the XML it is converting. The XSL is applied to the outbound message's XML Source, resulting in the defined XML Request Schema, which is then converted to JSON. If XSL transformation is not required, then the outbound message's XML Source is converted to JSON.
  - If the XML source on the outbound message can be converted to JSON using an XSL, then the **XSL Transformation** method may be chosen.
  - You may also choose to convert the XML Source to JSON via the **Standard API Conversion** method (using a Jettison library). With this method, an XSL may optionally be provided. The conversion will be performed on the transformed XML.
  - For the response, if the outbound message BO defines detailed elements for the XML Response field, then the JSON should be converted to this format. If your conversion method is **Base JSON Conversion**, then if the JSON response cannot be converted directly to the XML Response elements on the outbound message BO, then define a Response Schema (data area) that represents the results for the base JSON conversion. In addition, define an XSL that can transform the response from the converted XML to the XML format expected on the BO. If the conversion method is **Standard API Conversion** or **XSL Transformation**, the standard API is used to convert JSON to XML. An XSL may be defined to convert the response to the XML Response if needed.
  - If the outbound message BO defines a "raw" element to capture the response, then a response schema and XSL are not necessary. In this case, the system will perform a JSON to XML conversion using the **Standard API Conversion** method (regardless of the conversion method defined) and the result is captured in the XML response.
- For HTTP senders including JSON senders, the system provides support for sending messages secured by OAuth authentication using Oracle Web Services Manager (OWSM). The system provides a pre-configured set of policies for OAuth (**F1-OAUTH**) using a special extendable lookup. Note that the values of this policy set defines a specific CSF key repository that the implementation should use for capturing its CSF keys. In addition, there is a substitution value defined for the token URI: @F1\_OAUTH2\_URI@. Configure the appropriate URI for this implementation as described in [URI Substitution](#). By default the system does not support additional policy sets to be defined. If your implementation requires a different policy set, contact support.

Define a [message sender](#) configured for each appropriate routing method. The invocation type should be configured as **Real-time**. For routing via HTTP, use the **RTHTTPSNDR** - HTTP sender class. For routing via HTTP with SOAP format automatically applied, use the **SOAPSNDNR** - HTTP SOAP sender class. For routing via HTTP using JSON format, use the **RTJSONSNDR** - JSON sender class. For routing via JMS, use the **RTJMSQSNDR** - JMS queue sender class or **RTJMSTSNDR** - JMS topic sender class and configure the JMS Connection and JMS Queue or JMS Topic. Use the sender context to configure the required values for connecting to the appropriate destination.

---

**NOTE:** Refer to [Support for Dynamic URLs](#) for configuration needed to support dynamic URLs when sending an outbound message. There is specific configuration expected when defining the URL on the Sender in order to support dynamic URLs.

---

Configure the [external system](#) / outbound message type collection. The processing method defined for the external system / outbound message type must be **Real-time**.

## Define the External System and Configure the Messages

Define an [external system](#) and configure the valid outgoing messages and their method of communication (processing method). Refer to [Outbound Messages](#) for more information.

## Outbound Message Schema Validation

The outbound messages that are generated by the system should be well formed and valid so that they do not cause any issues in the external system. To ensure this validity you may configure the system to validate messages before they are routed to their destination. Note that the validation is applied just before communication with the sender and therefore after any Request XSL has been applied.

- Define a directory where the valid W3C schemas are located using the Message option **Outbound Message Schema Location**.
- Each [external system](#) message must indicate the appropriate W3C schema to use for validation.

You may turn on or off this validation checking using the Message option **Schema Validation Flag**.

## Configuring the System for Outbound Messages

The following sections describe the setup required when using [Outbound Messages](#) to communicate with an external system.

### JNDI Server

If using JMS to communicate outbound messages, define a new JNDI Server. Open **Admin > Integration > JNDI Server**.

#### Description of Page

Enter a unique **JNDI Server** and **Description**.

Indicate the Provider URL to indicate the location of the JNDI server. A variable may be used in place of all or part of the URL. The variable must be predefined in the substitution variable property file. The value here should enclose the variable name with @. Refer to [Referencing URIs](#) for more information.

Indicate the **Initial Context Factory**, which is a Java class name used by the JNDI server provider to create JNDI context objects.

#### Where Used

Follow this link to open the data dictionary where you can view the tables that reference [CI\\_XAI\\_JNDI\\_SVR](#).

### JMS Connection

To define a JMS Connection, open **Admin > Integration > JMS Connection**.

#### Description of Page

Enter a unique **JMS Connection** and **Description**.

Indicate the **JNDI Server** to be used. Refer to [JNDI Server](#) for more information.

Use the **JNDI Connection Factory** to indicate the lookup keyword in the JNDI server used to locate the JMS connection.

#### Where Used

Follow this link to open the data dictionary where you can view the tables that reference [CI\\_XAI\\_JMS\\_CON](#).

## JMS Queue

To define your JMS Queue values, open **Admin > Integration > JMS Queue**.

### Description of Page

Enter a unique **JMS Queue** and **Description**.

Enter the **Queue Name** as defined in the JNDI server. This is the JNDI lookup name identifying the queue.

Use the **Target Client Flag** to indicate whether or not the target client is **JMS** or **MQ**.

Select the **JNDI Server** where the queue is defined. Refer to [JNDI Server](#) for more information.

### Where Used

Follow this link to open the data dictionary where you can view the tables that reference [CI\\_XAI\\_JMS\\_Q](#).

## JMS Topic

To define your JMS Topic values, open **Admin > Integration > JMS Topic**.

### Description of Page

Enter a unique **JMS Topic** and **Description**.

Select the **JNDI Server** where the topic is defined. Refer to [JNDI Server](#) for more information.

Enter the **Topic Name** as defined in the JNDI server. This is the JNDI lookup name identifying the topic.

### Where Used

Follow this link to open the data dictionary where you can view the tables that reference [CI\\_XAI\\_JMS\\_TPC](#).

## Message Sender

The topics in this section describe the maintenance of a message sender

### Message Sender - Main

To define a new sender, open **Admin > Integration > Message Sender**.

#### Description of Page

Enter a unique **Message Sender** and **Description**.

Set **Invocation Type** to **Real-time**.

---

**NOTE:** The invocation type **MPL** remains in the product for upgrade purposes but is not recommended.

---

Indicate the **Message Class** for this sender, which indicates the method used to route the message. The real-time sender classes are as follows:

Message Class	Description
RTEMAILSNDR	Email sender.
RTHTTPSNDR	HTTP sender.
RTJMSQSNDR	JMS queue sender.
RTJMSTSNDR	JMS topic sender.
RTJSONSNDR	HTTP JSON sender.
SOAPSNDR	HTTP SOAP sender.

The following sender classes are related to MPL processing and remain in the product for upgrade purposes:

Message Class	Description
DWNSTGSNDR	Download Staging sender.
EMAILSENDER	Email sender.
FLATFILESNDR	Flat file sender.
HTTPSNDR	HTTP sender.
JMSENDER	JMS Queue sender.
OUTMSGSNDR	Outbound Message sender.
STGSENDER	Staging Upload sender.
TPCSNDR	JMS Topic sender.
UPLDERRHNDLR	Upload Error Handler.

Indicate whether or not this sender is currently **Active**.

For JMS related senders, indicate whether the **MSG Encoding** is **ANSI message encoding** or **UTF-8 message encoding**. (Note that for all other types of senders, the Character Encoding context type is used to configure encoding.)

If the Message Class is one that connects to a JMS Queue or JMS Topic, indicate the appropriate **JMS Connection**

---

**FASTPATH:** Refer to [JMS Connection](#) for more information.

---

If the Message Class is one that connects to a JMS queue, indicate the name of the **JMS Queue** to define where the message is to be sent.

---

**FASTPATH:** Refer to [JMS Queue](#) for more information.

---

If the Message Class is one that connects to a JMS topic, indicate the name of the **JMS Topic** to define where the message is to be sent.

---

**FASTPATH:** Refer to [JMS Topic](#) for more information.

---

The **XAI JDBC Connection** remains for legacy purposes but is not applicable for supported functionality.

## Message Sender - Context

The sender may require context information to define additional information needed by the system to successfully send outgoing messages. Open **Admin > Integration > Message Sender** and navigate to the **Context** page.

### Description of Page

Define the **Context Type** and **Context Value**, which contain parameters for senders when more information is required. See below for the supported context values for different types of senders.

### Where Used

Follow this link to open the data dictionary where you can view the tables that reference [CI\\_XAI\\_SENDER](#).

## Email Sender Context

The email sender is used by the business service that [sends email messages real-time](#).

An email sender must point to the Message Class **RTHTTPSNDR**. In addition, the following context records should be defined for senders of this type.

Context Type	Description
SMTP Host name	The SMTP server host name.

Context Type	Description
SMTP Username	The user ID used to access the SMTP server.
SMTP Password	The password used to access the SMTP server.
Response Time Out	The amount of time the system should wait for a real time response.

## HTTP Sender

An HTTP sender is one that sends messages to an HTTP server using the HTTP protocol. HTTP senders should reference a Message Class of **RTHTTPSNDR**, **RTJSONSNDR** or **SOAPSNDR**.

Various parameters are required to establish a session with the target HTTP server. You specify these parameters by defining a collection of context values for the sender. A set of context types related to HTTP variables is provided with the product. The following section describes the context types and where appropriate, indicates valid values.

Before defining the HTTP sender, you need to find out how the HTTP server on the other side expects to receive the request, and in particular, to answer the following questions:

- What is the address of the HTTP server?
- Is the HTTP server using a POST or GET HTTP method?
- If the server is using POST, how are message contents passed? Does it use an HTTP FORM or does it pass the data in the body of an XML message?

Context Type	Description	Values
HTTP URL1 - URL9	Used to construct the URL of the target HTTP server.  Since the URL may be long and complex, you can break it into smaller parts, each defined by a separate context record. The full URL is built by concatenating the values in URL1 through URL9.  You may use substitution variables when entering values for URL parts. Note that the substitution string @XMLMSG@ may be used for <b>GET</b> calls if an XSL has been applied to convert the message into HTTP GET parameters. It is useful if the HTTP Form is not applicable to the type of message.  Refer to <a href="#">Support for Dynamic URLs</a> for configuration needed to support dynamic URLs when sending an outbound message.	
HTTP Method	The HTTP method used to send the message.  <b>NOTE:</b> The SOAP sender message class <b>SOAPSNDR</b> only supports the <b>POST</b> method.	<b>POST</b> or <b>GET</b>
HTTP Transport Method	Specifies the type of the message. You can either send the message or send and wait for a response.	<b>Send</b> or <b>sendReceive</b>

Context Type	Description	Values
HTTP Form Data	<p>Used when the message is in the format of an HTML Form (<code>Content-Type: application/x-www-form-urlencoded</code>).</p> <p>This context specifies the form parameters (data) that should be passed in the HTTP message. Since a form may have multiple parameters, you should add a context record for each form parameter.</p> <p>The value of a form parameter takes the format of <code>x=y</code> where <code>x</code> is the form parameter name and <code>y</code> is its value.</p> <p>If <code>y</code> contains the string <code>@XMLMSG@</code> (case sensitive) then this string is replaced by the content of the service response XML message. The <code>@XMLMSG@</code> string can be used in the HTTP Form Data or in the HTTP URL, but not in both.</p> <p>If a context record of this type is defined for a sender, the sender uses the HTML Form message format to send the message even if <code>@XMLMSG@</code> is not specified in one of the context records.</p> <p>If a context record of this type is not defined for a sender, then the XML is sent with <code>Content-Type: text/plain</code>. When using POST it is put in the HTTP message body.</p> <p>Always required when using the GET method. If you are using the GET method and do not specify a Form Data context record, no message is transferred to the HTTP server.</p> <p>The MPL server builds <code>formData</code> by concatenating the individual parts.</p> <p>You may use substitution variables when entering values for Form Data.</p>	
HTTP Login User	<p>The HTTP server may require authentication. Add a context record of this type to specify the login user to use.</p>	
HTTP Login Password	<p>The HTTP server may require authentication. Add a context record of this type to specify the login password to use.</p>	
HTTP Header	<p>Sometimes the HTTP server on the other side may require the addition of HTTP headers to the message.</p> <p>For each HTTP header that has to be specified you should add a context record with a value having the following format <code>x:y</code> where <code>x</code> is the header name and <code>y</code> is the value for the header</p>	

Context Type	Description	Values
HTTP Time Out	Indicates the amount of time to wait for a connection to be established with the remote system.	
Character Encoding	Indicates if the message should be encoded. The sender will add to the HTTP's content type header the string ; charset=x where x is the value of this context and when sending the message it will encode the data in that encoding.	<b>UTF-8</b> or <b>UTF-16</b>
Response Time Out	The amount of time the system should wait for the remote system to send a response.	
Sender Security Type	Indicate the desired security type to apply.	<b>BASIC</b> (HTTP Basic), <b>TEXT</b> (Username Token plain text), <b>DIGEST</b> - Username Token Digest, <b>OWSM</b> - OAuth Security via OWSM.
OWSM Policy Set	Applicable only if the Sender Security Type is <b>OWSM</b> . Defines the policy set to apply.	Enter a valid value for the extendable lookup Set of Policies ( <b>F1-SetOfPolicies</b> ). The product provides the value <b>F1-OAUTH</b> that may be used here.

## Real-time HTTP Sender

The following context type is only applicable to senders with the **RTHTTPSNDR** message class.

Context Type	Description
Content Type	Populate a value here to override the <b>Content-Type</b> attribute in the HTTP header, which defaults to <b>text/xml</b> .

## SOAP Sender

A SOAP sender is an HTTP sender that automatically adds support for the SOAP format. For this type of sender (message class of **SOAPSNDR**), besides the context values listed above, the following context entries may also be supplied.

Context Type	Description	Values
Message Namespace URI	Used to indicate a specific namespace to be included in messages for this sender. Note that this value is used only when the External Message link to this sender is configured with a <b>Namespace Option of Configured on Sender</b> .	
SOAP Insert Timestamp	Indicate whether a timestamp should be added. Default value is 'N'.	<b>Y</b> or <b>N</b>
SOAP Expiration Delay (in seconds)	Indicate an expiration delay to add to the timestamp. The default value is 60.	

**NOTE:** Refer to [Add SOAP Header Parameters at Runtime](#) for information about dynamically including SOAP Header parameters when sending a message.

## JMS Sender

A JMS sender is one that sends messages to a JMS queue or JMS topic. JMS senders should reference a Message Class of **RTJMSQSNDR** or **RTJMSTSNDR**, respectively.

The following parameters are used to connect to the JMS resource.

Context Type	Description	Values
JMS Message Type (Bytes(Y)/Text(N))	Indicates whether the data is sent as a bytes message or as a text message.	<b>Y</b> or <b>N</b>
JMS User Name	Enter the user name to connect to the JMS resource.	
JMS User Password	Enter the password to use to connect to the JMS resource.	
JMS Header	If JMS header values are required for the message, use this context type.  For each JMS header that has to be specified, add a context record with a value having the following format x;y where x is the header name and y is the value.	

## Defining Outbound Message Types

Refer to [Outbound Messages](#) for an overview of this functionality.

Use this page to define basic information about an outbound message type. Open this page using **Admin > Integration > Outbound Message Type**. You are brought to a query portal with options for searching for outbound message types.

**NOTE:** This page is not available if the **External Message** module is [turned off](#).

Once an outbound message type has been selected, you are brought to the maintenance portal to view and maintain the selected record.

The **Outbound Message Type** zone provides basic information about a business flag. Refer to the embedded help for more information.

The **External System Links** zone is visible if the outbound message type is linked to any external systems.

**CAUTION:** Important! When adding new records, carefully consider the naming convention of the outbound message type code. Refer to [System Data Naming Convention](#) for more information.

Note that in addition to standard actions available on this portal, there is also a special **Add to Category** button in the page action area. Click this button to link an outbound message type to one or more [web service categories](#).

### Where Used

Follow this link to open the data dictionary where you can view the tables that reference [F1\\_OUTMSG\\_TYPE](#).

## External Systems

Use this page to define an external system and define the configuration for communication between your system and the external system.



## External System - Main

Open this page using **Admin > Integration > External System**.

---

**NOTE:** This page is not available if both the **External Message** and the **Open Market Interchange** modules are [turned off](#).

---

### Description of Page

Enter a unique **External System** and **Description**.

Use the field **Our Name In Their System** to specify the identity of your organization (i.e., your external system identifier) in the external system.

---

**NOTE:** The workflow process profile and notification download profile are only applicable to products that support workflow and notification. They are not visible in the product if the **Open Market Interchange** module is [turned off](#).

---

If this external system sends inbound communications through notification upload staging, the type of workflow process that is created is controlled by the sender's **W/F (Workflow) Process Profile**.

If you send notifications to this external system, select a **Notification DL (download) Profile** that is used to define the configuration of the outgoing messages.

---

**NOTE:** The remaining fields are not visible if the **External Message** module is [turned off](#).

---

Set **Usage** to **Template External System** for external systems whose outbound message type configuration is inherited by other external systems.

If the outbound message type configuration should be inherited from a template external system, define the **Template External System**. If this field is specified, the outbound message type collection displays the data defined for the template system as display-only.

The **Outbound Message Type** accordion contains an entry for every type of outbound message defined for this external system. For each type of outbound message identify its **Outbound Message Type**.

Define the **Processing Method** for messages of this type. Valid values are **Batch**, **Real-time**, **SOA** and **XAI**.

Define an appropriate **Message Sender** if the processing method is **XAI** or **Real-time**.

**Namespace Option** is used when your message should include a namespace in the resulting XML. The valid options are **Standard Namespace** and **Configured on Sender**. If the value is Standard Namespace, the system will generate a namespace for the resulting WSDL with the following value: **http://ouaf.oracle.com/outbound/AAA\_BBB**, where AAA is the external system code and BBB is the outbound message type code. If the value is Configured on Sender, then the value of the namespace is taken from the sender context with context type **Message Namespace URI**.

Define an appropriate **Batch Control** if the processing method is **Batch**.

If the message sender is one with a message class of **RTJSONSNDR**, indicate the **JSON Conversion Method**. The valid values are **Base JSON Conversion**, **Standard API Conversion** and **XSL Transformation**. Refer to [Real Time Message Configuration](#) for more information about these methods and the additional configuration that may be applicable.

If the **JSON Conversion Method** is **Base JSON Conversion**, the **Request Schema** is enabled. Populate a data area that defines the schema for the XML format to convert the outbound message's BO schema to prior to performing the JSON conversion. Refer to [Real Time Message Configuration](#) for more information.

The **Message XSL** is the schema used to transform information from the format produced by the system to a format understood by the sender, who receives a message of this type. This is not applicable for Processing Method of **SOA**.

Enter the file name of the appropriate **W3C Schema** if you want to validate the message built for outbound messages for this external system / outbound message type prior to being routed to their destination. Refer to [Outbound Message Schema Validation](#) for more information. This is not applicable for Processing Method of **SOA**.

If the **JSON Conversion Method** is **Base JSON Conversion**, the **Response Schema** is enabled. Populate a data area that defines the schema for the XML format that the JSON message is initially converted to. The XML is then converted to BO XML. Refer to [Real Time Message Configuration](#) for more information.

**Response XSL** will have the same search service as is used for the existing Message XSL field. This field will only be displayed when the processing method is **Real-time**. Refer to [Real Time Messages](#) for more information on how it is used.

## External System - Template Use

If you are viewing an external system whose usage is a **Template External System**, use this page to view the other external systems that reference this one. Open this page using **Admin > Integration > External System** and then navigate to the **Template Use** tab.

### Description of Page

The tree shows every external system that references this external system as its template.

## Message Option

The Message Option page defines various system settings used by the system when processing external messages.

To define options for your environment, open **Admin > Integration > Message Option**.

### Description of Page

The following options are supported.

Option	Description	Option Name
Default Email Sender	This is the default Message Sender used for <a href="#">sending e-mails</a> when no explicit Message Sender is specified.	<b>defaultEmailSender</b>
Default User	The default user is used by the system to access your product when no other user is explicitly specified.	<b>defaultUser</b>
Email Attachment File Location	This is the default location of e-mail attachment files. If not specified, the e-mail service provided with the product assumes a full path is provided with each attachment file.	<b>emailAttachmentFileLocation</b>
Email XSL File Location	This is the default location of e-mail XSL files. If not specified, the e-mail service provided with the product assumes a full path is provided to an XSL file as part of an e-mail request.	<b>emailXSLFileLocation</b>
Messages Language	The default language to use for the messages.	<b>language</b>
Outbound Message Schema Location	Enter the full path of the virtual directory where valid W3C schemas are stored if your implementation wants to <a href="#">validate outbound message schemas</a> . For example: http://localhost/cisxai/schemas.	<b>xaiOuboundSchemaLoc</b>
Schema Validation Flag	Enter <b>Y</b> to turn on <a href="#">schema validation for outbound messages</a> . Enter <b>N</b> to turn this off.	<b>xaiSchemaValidationCheck</b>
To Do Type for Inbound JMS Message Errors	To Do type for inbound JMS message errors. The inbound message processor uses this To Do type when creating To Do entries for inbound JMS messages that cannot be successfully processed. The system provides	<b>toDoTypeforInboundJMSMessageErrors</b>

Option	Description	Option Name
	the To Do type <b>F1-INJMS</b> that may be used here.	
To Do Type for Outbound Message Errors	To Do type for outbound message errors. The outbound message receiver uses this To Do type when creating To Do entries for outbound messages that cannot be successfully processed. The system provides the To Do type <b>F1-OUTMS</b> that may be used here.	<b>outboundErrorTodo</b>

Note that the following options are no longer applicable.

Option
Automatically Attempt Resend to Unavailable Sender (Y/N)
Default Response Character Encoding
JDBC Connection Pool Max size
Maximum Errors for a Sender
Messages JDBC Connection
MPL Administrator Port
MPL HTTP Server Authentication Method
MPL HTTP Server Password
MPL HTTP Server User
MPL Log File
MPL Trace File
MPL Trace Type
Privileged Users
Records MPL Receiver Will Process At a Time
Schema Directory
Send SOAP Fault as HTTP 500
Sender Retry Seconds
System Error JDBC Connection
System Error Max Retry
System Error Retry Interval
Thread Pool Initial Size
Thread Pool Max Size
Thread Pool Non Activity Time
WSDL Service Address Location
XAI Authentication Password
XAI Authentication User
XAI Trace File
XAI Trace Type
XSD Compliance
XSL Directory

## Managing Outbound Messages

Use this page to view information about outbound messages.

## Outbound Message - Main

Open this page using **Menu > Integration > Outbound Message**.

### Description of Page

**Outbound Message ID** is the system-assigned unique identifier of the outbound message. These values only appear after the outbound message is added to the database.

The **Processing Method** indicates whether this record will be processed by a **Batch** extract process or **Real-time**. (The value of **XAI** is no longer supported). The value defined on the external system / outbound message type collection populates this value.

When records are created with a processing method of **Batch**, the system sets Extract to **Can Be Extracted**. Change the value to **Not to be extracted** if there is some reason that processing should be held for this record.

For records with a processing method of **Batch**, **Batch Control** indicates the process that will extract this record. This value is populated based on the on the external system / outbound message type's value. **Batch Number** indicates in which batch run this record was extracted or will be extracted.

The **Retry Count** is no longer applicable..

The **Creation Date** indicates the date that this record was created.

The status is no longer applicable.

## Outbound Message - Message

Use this page to view the XML source used to build an outbound message. Open this page using **Menu > Integration > Outbound Message** and then navigate to the **Message** tab.

### Description of Page

The **XML Source** is displayed.

If a message XSL is defined on the external system / outbound message type record linked to this outbound message, the **Show XML** button is enabled. Click this button to view the XML that is a result of applying the Message XSL to the XML source.

## Outbound Message - Response

Use this page to display the XML response. Open this page using **Menu > Integration > Outbound Message** and then navigate to the **Response** tab.

### Description of Page

The **XML Response** and optionally the **XML Raw Response** is displayed.

XML Response displays the response data from the system called by the real-time message. If a response XSL is defined on the external system / outbound message type record linked to this outbound message, a transform is performed and the XML Raw Response displays the original, unchanged response.

## Web Service Adapters

The base product provides a configuration object called Web Service Adapter that is used to help build configuration objects to allow for functionality in the system to initiate a web service call from within the system. A Web Service Adapter provides the following functionality:

- WSDL (web service description language) import. An implementer can use the WSDL import functionality to read the details of a WSDL into the system

- Internal API generation. The system generates internal data areas that have two main purposes: they provide the API for custom code to define the appropriate input and they provide output data for the web service call using Oracle Utilities Application Framework schema language. In addition, the web service dispatcher uses element mapping defined in the data areas to transform the internal XML into the structure expected by the external system as described in the WSDL.
- Defines the URL needed to perform the web service call at runtime.

## Understanding Web Service Adapters

The following topics describe the system functionality in more detail.

### Importing a WSDL

Configuring a Web Service Adapter starts by identifying the WSDL (the web service description language document used to define the interface) that will be provided by the external system. The following steps describe the base product functionality provided to allow a user to import a WSDL.

- Navigate to the **Web Service Adapter** page in add mode and select the appropriate base business object.
- Enter a meaningful Web Service Name and appropriate descriptions.
- Provide the URL of the given WSDL.
- Click **Import** to retrieve the details of the WSDL. The system then parses the WSDL details and populates the WSDL Service Name, WSDL Source, WSDL Port, URL and a list of Operations (methods) defined in the WSDL.
- Determine which Operations should be **active** based on the business requirements for invoking this web service. **Active** operations are those that the implementation is planning to invoke from the system. These require appropriate request and response data areas generated for them. The following section provides more information about that.
- Specify the appropriate Security Type to configure the type of security to use when invoking this web service.
- Click Save.

At this point, a web service adapter record is created in pending status. The next step is to generate the request and response data areas for the operations configured as active.

### Generating Request and Response Data Areas

Each **active** operation for the web service adapter requires a pair of data areas, request and response, that represent the request and response XML messages for the operation.

The base product provides steps to generate the data areas as follows:

- As described in the Importing a WSDL section above, the operations listed in the WSDL are generated for the web service adapter and the implementer should indicate which operation to activate.
- After saving the **pending** web service adapter, the display lists all the active operations and for each one includes a **Generate** button.
- After clicking **Generate** for an operation, a window appears where the names of the new Request and Response Data Areas may be defined. Click **Save** to generate the data areas.

The generated data areas provide the API for the implementer to use when implementing the web service call in an appropriate algorithm or service in the system. The data areas contain the appropriate mapping from the elements that the implementer works within the code that invokes the web services and the WSDL definitions.

To facilitate generating the request and response data areas, the base product invokes a special business service used to create the appropriate mapping. The business service is defined as a BO option on the Web Service Adapter business object. This allows an implementation to provide a custom business service to further enhance the request and response mapping where appropriate.

---

**NOTE:**

**Generated data areas.** It is possible to edit and modify the generated data areas after they are created. An implementer can change element names or remove unneeded elements if desired. Manually changing the generated data areas must be done only when absolutely necessary. This is because the system is not able to validate manual changes and issues with the data areas would only be detected at run time.

---

## Activating Web Service Adapters

The business objects provided by the base package for web service adapters include a simple lifecycle of **Pending** and **Active**. Configure the web service adapter and its data areas while in **Pending** status and activate it when it is ready to be implemented in the appropriate system functionality.

## Invoking Web Services

To make a call to a web service using a web service adapter, the system has provided a Web Service Dispatcher business service (**F1-InvokeWebService**) to submit a web service call. The calling program is responsible for retrieving all the information to correctly populate the request data required by the web service call before invoking the business service.

---

**NOTE:**

Refer to the detailed description of the business service for more information.

---

## Limitations

The following points highlight limitations associated with the types of web services that the system supports:

- It is possible for one WSDL document to contain definitions for several web services. The system currently supports only one port or service per WSDL document.
- It is possible for a WSDL to support multiple message patterns. The system currently supports only request / response.

## Setting Up Web Service Adapters

Use the Web Service Adapter portal to define the configuration needed to communicate with an external system using a web service call. Open this page using **Admin > Integration > Web Service Adapter**. You are brought to a query portal with options for searching for web service adapters.

Once a web service adapter has been selected, you are brought to the maintenance portal to view and maintain the selected record.

The **Web Service Adapter** zone provides basic information about the web service annotation type.

Please see the zone's help text for information about this zone's fields.

---

**FASTPATH:** Refer to [Understanding Web Service Adapters](#) for information about common web service adapter functionality.

---

## Sending Email

The framework provides the ability to initiate an email from within the system. The following topics highlight the functionality available.

- Sending email “real time” using a specific business service. The framework provides a business service **F1-EmailService** that supports sending an email. The schema supports elements for all the information required to create an email real time. It also supports sending attachments. The SMTP information (host, user name and password) may be provided or may be defined on a message sender, that may be provided as input. In addition, the business service supports using a default message sender defined as a [message option](#). Review the business service schema for information about the input elements.

---

**NOTE:** Validating attachments. If a Validate Email Attachment algorithm is plugged into the [installation record](#), it is called to validate the attachments supplied, if applicable.

---

**NOTE: Retry setting.** An option in the system properties file allows your implementation to configure the number of times to retry (if any) if the SMTP server is unavailable. Refer to the server administration guide for more information.

---

- Using an outbound message to send an email. This option allows for different variations as described in [Outbound Messages](#).
  - Some emails may be created en masse (for example a large group of emails routed to users for a given set of To Do entries). In this case, the records can be created in the staging table for processing using OSB.
  - Messages may still be sent real time using one of two business services described in [Real Time Messages](#). This option is an alternative to the dedicated email service described above when aspects of the outbound message functionality are needed, such as the ability to instantiate a record as an audit or to include additional logic via BO plug-ins as part of sending the email.

## Web Service Category

The product provides the ability to categorize web services that are defined in the system. The term web services refers to Outbound Message Types, Inbound Web Services, and for those implementations where they are applicable, XAI Inbound Services.

A given web service may be linked to more than one category. The product supplies web service categories and most base delivered web services are configured with appropriate categories. Implementations may define new categories and may link custom web services to base delivered categories or to custom categories. In addition, implementations may link additional categories to base delivered web services. However, implementations may not remove base delivered web services from base delivered categories.

If your implementation uses the [Integration Cloud Service Catalog](#), the integration provides the categories for each web service that is sent to the catalog.

The web service category portal supports adding and removing web services from the category. In addition, the [Outbound Message Type](#) portal and [Inbound Web Service](#) portal each provide a page action button to **Add to Category**.

## Defining Web Service Categories

Refer to [Web Service Category](#) for an overview of this functionality.

Use this page to define basic information about a web service category. Open this page using **Admin > Integration > Web Service Category**. You are brought to a query portal with options for searching for web service categories.

---

**NOTE:** This page is not available if the **External Message** module is [turned off](#).

---

Once a web service category has been selected, you are brought to the maintenance portal to view and maintain the selected record.

The **Web Service Category** zone provides basic information about a web service category.

---

**CAUTION:** Important! When adding new records, carefully consider the naming convention of the web service category code. Refer to [System Data Naming Convention](#) for more information.

---

Once a web service category exists, an **Add Web Services** zone is provided to find and select web services to link to the web service category.

When viewing a category that already has web services linked to it, they are visible in the zone **Included Web Services**. This zone allows a user to remove a customer owned web service from the list.

### Where Used

Follow this link to open the data dictionary where you can view the tables that reference [FI\\_WEB\\_CAT](#).

## JMS Message Browser

The JMS Message Browser portal allows you to select a JMS queue and view messages currently in the queue.

In order for a JMS queue to be available on the portal, a [message sender](#) must be defined that is configured for the appropriate JMS queue with the credentials to connect to the queue.

- If your organization sends real-time outgoing messages to a JMS queue, this configuration would exist as per the details in [Real-Time Message Configuration](#).
- If inbound web service messages are routed to the system via a JMS queue, no configuration is needed in the system. However, if you would like to view the messages in the queue in the JMS message browser portal, configuration for the JMS queues as described for outgoing messages is required.

Navigate to the portal using **Main > Integration > JMS Message Browser**.

The JMS Senders zone provides a list of configured message senders eligible for selection.

The JMS Message List zone is visible for the JMS Sender broadcast from the first zone. This zone supports selecting one or more records to delete from the queue. Use the message selector to limit the results to messages that satisfy the message selector. This uses standard JMS API message selector functionality. Refer to the zone embedded help for information about the supported syntax.

The JMS Message Details zone displays a message broadcast from the list zone.

## Oracle Integration Cloud Catalog

Oracle Integration Cloud (OIC) is an offering that serves as integration infrastructure for Oracle cloud solutions. The product provides an adapter for OIC to streamline integration between your edge application and OIC.

The product provides a mechanism (referred to as an adapter) for OIC to retrieve the REST catalog and another to retrieve the SOAP catalog from a given product. The expectation is that a given implementation would use either REST or SOAP and not both, but for those implementations that do support both classes of web services, OIC can retrieve both catalogs.

For the SOAP catalog, the adapter retrieves the name, the source system, the WSDL location and namespace for each web service.

For the REST catalog, the adapter retrieves the name, the source system and the OpenAPI specification for each web service.

It is possible that not every web service supported by an edge product is managed by OIC. In order to only include the appropriate web services in the adapter, configuration is needed to identify which web services to include.

The web service catalog is used to identify the records that should be retrieved by the adapter. Separate catalogs exist for REST and for SOAP

- For SOAP inbound messages, the system supports both the use of [inbound web services](#) and XAI inbound services that are [deployed via IWS](#). Each IWS or XAI inbound service that should be included in the catalog must be flagged in the SOAP catalog. Note that only [deployed](#) services are returned to the catalogue.
- For REST inbound messages, each IWS that should be included in the catalog must be flagged in the REST catalog.



- For outbound message, the system requires the creation of an External System that includes each outbound message type that the external system receives. For outbound messages that are integrated through OIC, the external system itself will represent OIC. Rather than identifying each outbound message type to include in the catalog, only the external system needs to be flagged. The adapter will return web service information for all the outbound message types configured for the external system. If an implementation supports both REST and SOAP, separate external systems should be created to separately group the REST and SOAP outbound messages.

---

**NOTE:** Master and Subordinate Catalogs. The master and subordinate catalog functionality is no longer applicable and will be removed in a future release.

---

**FASTPATH:** Refer to [Maintaining the Web Service Catalog](#) for more information.

---

## Web Service Catalog Configuration

The topics in this section describe the configuration needed in your edge application to integrate with OIC.

### Web Service Catalog Master Configuration

The **Service Catalog Configuration** ([master configuration](#)) record defines several system wide settings related to integrating with the service catalog.

It includes configuration for the WSDL base URL for the SOAP catalog. Note that this element supports the functionality described in [Referencing URIs](#). Note that for the REST catalog, the system will use the URL defined in the substitution variable **F1\_OPEN\_API\_BASE\_URL**

The subordinate server section is no longer applicable and will be removed in a future release.

For more information about specific fields in the master configuration, refer to the embedded help.

### Maintaining the Web Service Catalog

Refer to [Oracle Integration Cloud Catalog](#) for an overview of web service catalog functionality.

To add or remove services that are reported to the OIC catalog, navigate to the portal using **Admin > Integration > Web Service Catalog**.

The Catalog by Class zone provides the list of classes (REST and SOAP). Broadcast the web service class that you want to work with.

The Catalog zone provides a list of services that are currently in the catalog based on the web service class chosen. Users may use this zone to remove services from the catalog.

The Candidate Services zone provides a list of external systems and inbound web services that are not currently linked to the catalog. Users may use this zone to add services to the catalog. The inbound web services will be limited to those with the same web service class as the one broadcast. All external systems are shown regardless of the web service class because there is no web service class configuration on external systems.. The expectation is that implementers will create the external system to include either only REST or only SOAP services and will know which external system to include in which catalog. For the SOAP web service class, if XAI inbound services are applicable, they are also visible.

---

**NOTE:** For inbound SOAP web services and XAI inbound services, they may be selected for the SOAP catalog at any time. However, only [deployed](#) services are returned to the catalog by the OIC adapter.

---

## Mobile Remote Messages

This section provides information about the functionality supporting a message exchange with a mobile application.

### About Remote Messages

Remote messages are used to send data to and from a mobile device. This section describes the mechanism that allows the main application to send and receive messages to a mobile device.

### Messages From A Mobile Device

Asynchronous messages from the field may be received continually throughout the day. The processing of such messages ensures against data loss by saving the message before processing it. This approach guarantees message delivery despite of potential processing errors. Refer to [Guaranteed Delivery](#) for more information.

If message processing fails at any time, a To Do entry is created for a user to review and resolve the problem. You can view the content of any message, try to reprocess the message as is, or edit the message content and then reprocess.

Some errors may arise due to a temporary situation and may resolve on their own when the system tries to process the erroneous message again by the remote message monitor batch process.

---

**NOTE:** It is important to schedule the **Remote Message Monitor** batch process to retry failed messages periodically. Refer to [F1-RMMSG](#) batch control for more information.

---

### Messages To A Mobile Device

Depending on your mobile application requirements, certain business events triggered by the main application may need to be communicated to a mobile user's specific mobile device.

The payload and rules associated with such message are defined using a **Message To Device** [mobile component](#). You may use the **Add Message To Device** (F1-AddMessageToDevice) business service to post a message to be processed by a mobile device. Refer to the description of this business service for more information.

The mobile device periodically polls for queued messages and process them in the order they were posted. You may configure an expiry time on the message's mobile component. If specified, messages of this type that have not been picked up by the specified time are automatically discarded by the remote message monitor batch program.

---

**NOTE:** It is important to schedule the **Remote Message Monitor** batch process to expire messages and finalize the state of processed messages. Refer to [F1-RMMSG](#) batch control for more information.

---

### Maintaining Remote Messages

This portal is used to view a messages sent to and from a mobile device.

Refer to [About Remote Messages](#) for more information.

You can access this portal from the **Main > Integration > Mobile Remote Message**. You are brought to a query portal with options for searching for a specific remote message. Once a remote message has been selected, you are brought to the maintenance portal to view and maintain the selected record.

The **Remote Message** zone on the portal's **Main** tab page provides information about the remote message, including the various maintenance actions applicable to its current state.

## XAI Documentation Note

The XAI functionality is legacy functionality and not recommended for new implementations. The help topics are no longer provided.

## Integrations

This chapter provides high level information about product integrations supported for all products that use Oracle Utilities Application Framework.

### LDAP Integration

Organizations commonly use a Lightweight Directory Access Protocol (LDAP) security repository as a source of security credentials. The system provides support for importing users and groups from an external LDAP repository into the product to populate Users and User Groups in the system. Once imported, all user and group functions are available. You can resynchronize your LDAP users and groups at any time.

---

**NOTE: Import only.** The system currently supports importing LDAP information. Exporting users and groups from the system to LDAP is not provided.

---

**NOTE:** Additional configuration. When importing new users and / or groups, additional configuration is needed in the base product. For example, after importing a new user group and its users, the user group configuration should be updated to define the valid application services for the user group. After importing a new user, additional configuration may be needed on the user such as valid To Do Roles, valid Home Page, etc.

---

**FASTPATH:** Refer to [Defining Security and User Options](#) for more information about the application security and what it controls.

---

This section the functionality provided in the framework application that supports LDAP. Refer to the *LDAP Integration* white paper for more information about typical steps related to the full integration.

### LDAP Integration Overview

This topic provides a high level overview of the integration process.

At a high level, the base product provides a process to import user group and / or user definitions from and LDAP repository. This is a one way integration.

- When importing a user, if it is not already found in the system, it will be added; otherwise its attributes will be updated according to the imported information.
- When importing a user group, if it is not already found in the system, it will be added; otherwise its attributes will be updated according to the imported information.
- When importing a user, its user group links will be updated as per the information in the import file. In addition, if there are any user groups linked to the user that are not found system, they will be added (however, the other users linked to that group in the LDAP repository will not be added as part of this step).
- When importing a user group, its user links will be updated as per the information in the import file. In addition, if there are any users linked to the user group that are not found system, they will be added (however, the other user groups linked to that user in the LDAP repository will not be added as part of this step).

- The import will not cause any deletions of the User or User Group to occur.

## A Batch Process Initiates the Import

A batch process is used to initiate the import of information from the LDAP repository. **F1-LDAP** may be submitted ad hoc or may be set up in a scheduler to periodically re-sync the information from the LDAP repository into the application.

The batch process uses parameters to define how to connect to the LDAP repository. In addition, parameters are used to indicate which user or group is being imported.

## Adjusting Data to Import

The system provides several mechanisms for adjusting data that is being added to the system:

- There is an **LDAP Import Preprocess** algorithm plug-in spot on the [installation](#) record. Algorithms plugged in here are called by the batch process prior to the add or update of any records. It may be used to make adjustments to the data before doing updates in the application.
- Specifically for creating or updating Users, the **F1-IDMUser** business object is used to add and create the user. The standard BO Preprocessing algorithm plug-in spot may be used to adjust data prior to creation.
- The LDAP mapping file supports some attributes to perform simple modifications to data.
  - The **transform** attribute supports values to truncate values or to convert data to upper case.
  - The **autoGenerate** attribute is specific to the User ID field. Setting this to true will trigger code that will automatically populate the User ID based on the user's name. Refer to [LDAP Mapping](#) for more information.

## Performing Additional Processing After Import

The system provides a plug-in spot on the [installation](#) record called **LDAP Import**. Algorithms plugged into this spot are called after users or user groups have been added or updated. It may be used to perform any extra processing that may need to be executed.

In addition, for any additional processing related to the creation or update of a User, the standard [Business Object plug-ins](#) may be used for the **F1-IDMUser** business object which the LDAP batch process uses to create or update users.

## Configuring LDAP Integration

To interface the LDAP based security repository with the authorization component of the Oracle Utilities Application Framework product the following must be performed:

- The location and port number of the LDAP based security repository must be defined to in the JNDI Server.
- The LDAP based security repository must be mapped to the Oracle Utilities Application Framework security model. This mapping is expressed as an XML file containing the LDAP query, rules and defaults used in the transformation.
- The mapping file must be configured on the **F1-LDAP** batch job.

### Define the JNDI Server

The first step in the configuration process is to define the location of the LDAP based security repository server so that the interface can connect to the physical attributes of the interface. This is done by creating a [JNDI Server](#).

---

**NOTE:** The LDAP server is strictly not a JNDI source but is treated as a JNDI source for the integration.

---

Enter a reasonable JNDI Server name and description.

Populate the **Provider URL** using the format **ldap://<hostname>:<portnumber>** where **<hostname>** is the host of the LDAP server and **<portnumber>** is the port used for the interface.

For the **Initial Context Factory**, the interface uses the standard `com.sun.jndi.ldap.LdapCtxFactory` provided with java for the LDAP interface. If your vendor supplies a custom context factory it may be used. Refer to the documentation provided with your LDAP based security repository for further information.

## Define Mapping

The critical component of the interface is a file that describes the mapping between the LDAP based security repository and the system's security model. This file contains the mapping, rules and queries used by the LDAP batch program to provide the interface. The LDAP batch job includes the reference to the mapping file as a parameter. Refer to [LDAP Mapping](#) for more information on defining the mapping file.

## Configure LDAP Batch Process

At this point, many parameters for the **F1-LDAP batch control** can be updated with system wide configuration.

- JDNI Server, User and Password may all be configured appropriately. Note that it is recommended that the **Security** setting for the Password be set to **Encrypt**.
- The **LDAP Configuration File** should be populated with the name and location of the LDAP Mapping file.
- If the LDAP service has any limitation to the number of objects that may be imported, configure the **LDAP Query Page Size** parameter to enable querying.

---

**NOTE: Group and User Parameters.** The assumption is that the Group or User input parameters are specific to a given import request and as such would not be populated as part of a configuration step.

---

**NOTE: L2 Cache.** The LDAP Import batch process requires the L2 Cache to be disabled since it needs to perform some updates in the outside of the worker threads. Any environment using LDAP Import must set `spl.runtime.batch.L2CacheMode=OFF` in the `threadpoolworker.properties` file. It is recommended to run the LDAP import in its own dedicated threadpoolworker.

---

## LDAP Mapping

An LDAP repository consists of multiple entries. Each entry represents an object in the directory that is identified by a Distinguished Name (DN) and may contain one or more attributes. In a typical LDAP repository there is usually an entry for users and an entry for groups. The connection between users and groups may be implemented in two different ways:

- The users belonging to a group are defined in a special multiple-value attribute on the Group entry.
- The groups to which a user belongs are defined in a special multiple-value attribute on the User entry.

The mapping between LDAP security objects and base security objects is stored in an XML document that can be processed by the LDAP import batch job. As part of setting up your system for LDAP import, you need to define this mapping. The base package provides a sample mapping file called `ldapdef.xml` that can be used as a starting point and changed per your business requirements and your particular LDAP repository.

Once you have defined the mapping XML document, this is configured as a parameter in the **F1-LDAP** batch job.

The XML structure:

- The **LDAPEntry** element maps the LDAP entries to system objects (User or Group). The mapping file must contain one and only one LDAPEntry element for User and one for Group.
- The **LDAPCDXAttrMapping** element within the LDAPEntry element maps attributes in the LDAP entry to attributes in the system object.
- The **LDAPEntryLinks** element describes objects linked to the LDAP entry. When mapping the user entity you need to describe how the groups the user belongs to are retrieved. When mapping the group entity you need to describe how the users contained in the group are retrieved.

The following table describes the attributes to define for each element.

Element	Attribute	Description
LDAPEntry	name	The name of the LDAP entry: - <b>Group</b> - <b>User</b>
	baseDN	The base distinguished name in LDAP for this entry.
	cdxEntity	The name of the base product entity to which the LDAP entry is mapped: - <b>Group</b> - <b>User</b>
	searchFilter	An LDAP search filter that is used to locate LDAP entries. A %searchParm % string in that filter is replaced by the value from the user or group parameter from the <b>F1-LDAP</b> batch job submission.
	Scope	Sets the scope of the search. Valid values are: - onelevel (the value normally used) - subtree
LDAPCDXAttrMapping	ldapAttr	The name of the LDAP attribute to be mapped. Note that this may be referenced more than once to allow one LDAP element to map to multiple base product elements. For example, if an email address should be used both for the Login ID and the Email Address.
	cdxName	The name of the base product attribute to be mapped. For User, this is the element within the F1-IDMUser business object. For Group, this is either the 'group' or the 'description'.
	default	The default value that will be assigned to the element referenced in the cdxName attribute when one of the following occurs: - The LDAP attribute contains a null or empty value - The LDAP attribute does not exist or is not specified. Default values are applied only when creating a new entity and are not applied to updated entities.
	autoGenerate	Set this to <b>true</b> in order to turn on auto generation of the user ID. If this is true, the system will define the user id as <first initial of first name>+<last name> all uppercase, to a maximum of 8 digits. If an existing user is found for the generated ID, a number will replace the eight digit (or be appended to the end). The system will increment the number until a unique ID is found.
	transform	Use this attribute to indicate if a transformation of the data should occur. Valid values: <b>uppercase truncate</b> . Note that this attribute should not be used in conjunction with the autoGenerate attribute.
LDAPEntryLink	linkedToLDAPEntity	The name of the linked entity ( <b>User</b> or <b>Group</b> ). Use User when describing the Group entity. Use Group when describing the User entity.
	linkingLDAPAttr	The multiple-value attribute name on the LDAP entity that contains the linked entity.
	linkingSearchFilter	The search filter to be applied to retrieve the list of linked objects, for example: (&(objectClass=group)(memberOf=%attr%)) The search filter may contain the string % attr % that acts as a substitution string and is replaced at run time by the value of the attribute named "attr" of the imported entity. If the LDAP entry you are describing is a Group and the string is %name%, it is replaced by the value of the "name" attribute of the group you are importing. If the LDAP entry you are describing is a User and the string is %dn%, it is replaced by the "dn" attribute of the User you are importing.
	linkingSearchScope	Sets the scope of the search. Valid values are: - <b>onelevel</b> (the value normally used) - <b>subtree</b>

## Sample Mapping

The following XML describes a sample mapping. The example makes the following assumptions:

- The base product attribute **displayProfileCode** is defaulted to "NORTHAM" when adding a new user.
- The LDAP Group entry contains the list of users belonging to the group in the **departmentNumber** attribute.
- The groups to which a user belongs are retrieved by applying a search filter.

```
<LDAPEntries>
  <LDAPEntry name=" User" baseDN="ou=people,dc=example,dc=com" cdxEntity="
  user" searchFilter=" (&(objectClass=inetOrgPerson)(uid=%searchParm%))">
    <LDAPCDXAttrMappings>
      <LDAPCDXAttrMapping ldapAttr="uid" cdxName=" user" />
      <LDAPCDXAttrMapping ldapAttr="cn" cdxName="externalUserId" />
      <LDAPCDXAttrMapping cdxName="language" default=" ENG" />
      <LDAPCDXAttrMapping ldapAttr="givenName" cdxName="firstName"/>
      <LDAPCDXAttrMapping ldapAttr="sn" cdxName=" lastName"/>
      <LDAPCDXAttrMapping cdxName="displayProfileCode" default="NORTHAM" />
      <LDAPCDXAttrMapping cdxName="toDoEntriesAge1" default="30" />
      <LDAPCDXAttrMapping cdxName="toDoEntriesAge2" default="90" />
      <LDAPCDXAttrMapping cdxName="userEnable" default="ENBL" />
    </LDAPCDXAttrMappings>
    <LDAPEntryLinks>
      <LDAPEntryLink linkedToLDAPEntity="Group" linkingLDAPAttr="departmentNumber" />
    </LDAPEntryLinks>
  </LDAPEntry>
  <LDAPEntry name="Group" baseDN="ou=people,dc=example,dc=com" cdxEntity="
  Group" searchFilter=" (&(objectClass=organizationalUnit)(ou=%searchParm%))">
    <LDAPCDXAttrMappings>
      <LDAPCDXAttrMapping ldapAttr="name" cdxName="Group" />
      <LDAPCDXAttrMapping ldapAttr="description" cdxName=" Description" default="Unknown" />
    </LDAPCDXAttrMappings>
    <LDAPEntryLinks>
      <LDAPEntryLink linkedToLDAPEntity="User" linkingSearchFilter="
      (&(objectClass=inetOrgPerson)(departmentNumber=%distinguishedName%))"
      linkingSearchScope="onelevel" />
    </LDAPEntryLinks>
  </LDAPEntry>
</LDAPEntries>
```

## Oracle Identity Manager Integration

The *Oracle Identity Manager* product allows a site to centralize their user definitions and password rules to manage and deploy across the enterprise set of products. When an employee joins an organization, changes their name or departs an organization their security presence across an enterprise must be appropriately managed. Oracle Identity Manager allows for users to be provision and managed in a central location.

An integration is provided to allow the ability to create, maintain and remove users in the identity management product and sync those changes to the users defined in the application. The following sections provide additional details about the integration with respect to configuration steps required in an Oracle Utilities Application Framework based product. For more information about the configuration required in the identity management product, refer to the *Identity Management Suite Integration* white paper.

In order to use this functionality, [feature configuration](#) options for the **External Messages** feature type must be configured.

- Set option type **Support SPML Deployment in IWS** to **true**.
- Set option type **Default SPML service security policy** to an appropriate value per your implementation rules.

## Template User Functionality

The user object in this product captures configuration used to control access but also preferences. The identify management product allows for extending the configuration to capture user configuration that is specific to this product. However, it does



not support providing searches or dropdowns to select valid values. For example, to define the user's Home Page requires the reference to a navigation option. To set up your business process such that the home page is configured when defining the user in the identity management product dictates that the security user types in the correct navigation option reference.

On the other hand, to define a minimal amount of user information in the identity management product may result in a two step process for defining users: first define them in the identity management product with the basic authentication details and setting system defaults for some important fields, then after submitting the new user to be added to this product, navigate to the [user](#) page in this product and fill in all the configuration that is specific to this product.

The product provides support for defining a template user that can facilitate the definition of users and reduce some of the challenges listed above. The concept is as follows:

- Define a template user for each broad category of users in the system. For example, Oracle Utilities Mobile Workforce Management may define the following template users: Dispatcher, Mobile Worker, System Administrator and Contractor. Each user would define the typical configuration for users of that type including the home page, the user groups, the To Do roles, the portal preferences, etc.
- When extending the configuration in the identity manager product, simply map the information that is unique to a user and in addition, define a field for the template user. For example, you may choose to only capture the Name (first and last), Email address and User IDs for the user along with its Template User (which is mapped to a user characteristic). Additional fields may be included for capture in the identity management product when defining new users as per an implementation's business needs. For example, if the organization covers multiple time zones, perhaps it is easier to define the user's time zone when defining the user in the identity management product.
- When the new user is uploaded to the system, the interface uses the user BO **F1-IDMUser** to create the user. The BO includes a preprocessing algorithm that looks for the existence of a template user (sent as a characteristic of type **F1-TMUSR**). All the information from the template user will be copied onto the new user record except for the information passed in from the identity manager. The template user is captured on the newly created user via a characteristic for information / audit purposes.
- Once the new user is created, its configuration can now be adjusted, if applicable. Note that the template user is only a tool used when adding a user. Updates to the template user will not "ripple" to all the other users that were created based on this template.

## Configuring Template Users

Before configuring template users, all the administrative control tables that are part of User configuration must be defined, including time zones, display profiles, To Do roles, data access roles and user groups.

The next step is to define the user configuration for your system users. During this exercise, you will find that you have broad categories of users. But you will also see that within a given category of user there may be variations in the user privileges and preferences. For example, perhaps there are supervisors within the Mobile Worker role that have more security privileges than a typical Mobile Worker. In addition, there may be variations based on the attributes of the users themselves. For example, maybe your organization exists in multiple time zones and some of your workers are in one time zone and some are in the other.

At this point your security users that are designing their user provisioning procedures must decide the following:

- What information about a new user will be captured in the identity system (besides the expected information like Name, Email and the User IDs)? For example, for the case of multiple time zones, maybe the best solution is to capture the time zone when defining the user.

What information is defined on the template user and how many template users should be created to reduce the need for manual steps or additional data captured in the identity management system? In the case of multiple time zones, proliferating the template users to have one set for one time zone and another set for the other time zone may not make sense since this is one field that is different. However it may be reasonable to create additional templates in the case of variations in the levels of privileges for workers of a different category. So rather than template users for Dispatcher, Mobile Worker, System Administrator and Contractor, your organization may have template users for Dispatcher, Mobile Worker, Mobile Worker (Supervisor), System Administrator, Contractor (Short Term) and Contractor (Long Term).



What information is must be configured one the User record in the application after the user is added? If only a small number of users have a variation from other users, it may be that the easiest way to deal with those variations is to simply update those user records manually. Using the above examples:

- If your organization covers 2 time zones but only a small group of people work in one of the time zones whereas the bulk of the users are in the other time zone, the simplest procedure may be to define the template users for the main time zone and use that for the creation of all users. Then for the small group of users in the separate time zone, navigate to the User page to adjust the time zone after the record is added.
- If only a small number of Mobile Workers are supervisors with separate privileges, rather than defining a special template user for those type of workers, the simpler procedure may be to use the Mobile Worker template and then navigate to the User page to add the additional privileges to the supervisor users after the record is added.

To create a template user, navigate using **Admin > Security > User**.

- Define a User ID that will become the template user reference in the identity management system.
- Be sure to choose a **User Type** of **Template User**.
- Define all the information that should be copied onto a new user that references this user as a template user. Note that **Bookmarks** are not included in the data that is copied from a template user.

---

**NOTE:** There is configuration needed in Oracle Identity Management to capture the template user and any other information that the implementation has chosen to define in the identity management product when provisioning a new user. Refer to the *Identity Management Suite Integration* white paper for more information.

---

## Batch Scheduler Integration

The Oracle Database includes an enterprise wide scheduler to simplify the scheduling of background processes. The scheduler is implemented by the *DBMS\_SCHEDULER* package. The product provides an integration with the Oracle Scheduler to facilitate scheduling background processes shipped with the product.

At a high level, the integration with the Oracle DBMS Scheduler supports the following entities:

- **DBMS Program.** A program should be defined for each Batch Control that needs to be scheduled by the DBMS scheduler. A program would typically invoke a batch job, but it could be configured to set certain options instead.
- **DBMS Chain.** A Chain defines a series of steps with dependency rules between them. A step references a program, with the program performing the actual work for that step. A rule is attached to each step to identify its dependent steps and the condition for when that step should be executed. For example, in a chain consisting of STEP\_A and STEP\_B, where STEP\_B can only start if STEP\_A was successful, the rule for STEP\_B to start would specify a condition of "STEP\_A SUCCEEDED".
- **DBMS Schedule.** A predefined frequency for jobs that need to be run periodically, for example, nightly jobs.
- **DBMS Job.** Defines a plan to perform a specific program or a chain periodically on a specific schedule or ad-hoc.

The product provides a set of business services to maintain these entities as well as submit jobs, manage submissions and report on past submissions. Refer to business services that start with the prefix "F1-DBMS" for more information.

---

**NOTE:** For details on the integration, refer to the *Server Administration Guide* which contains the API. In addition, refer to the white paper *Oracle Scheduler Integration* that provides guidelines for using this integration.

---

## Data Synchronization

Your implementation may need to communicate certain data to external systems. This may be part of a data warehousing requirement or an integration effort. The synchronization process has two main parts. First, the change to the data must

be detected and captured. Once that is accomplished, the next step is to manage the communication of that change to the external systems involved. The changes must be captured in chronological order so as to avoid systems going out of sync.

## About Data Synchronization

The following sections describe general supported functionality in more detail using the logic supplied in the base business object **F1-SyncRequest**. Note that each edge application delivers an appropriate child business object for this BO for each specific synch scenario supported in that product. Some of the functionality below is accomplished using configuration on the parent BO delivered by the framework while other functionality may be delivered by the child BO. In addition, there may be more complex use cases supported by your specific product integration. Refer to your specific application's library of Sync Request business object along with the documentation related to your specific product integration for more information.

### Capturing the Change

The base product uses the **Audit** plug-in spot on the maintenance object to allow for logic to be performed by the system when a change is detected to a record for that MO. The framework calls the algorithm defined on this plug-in spot in the event a change to the MO has been detected. Refer to the description of the plug-in spot on [Maintenance Object — Algorithms](#) for more information about when this plug-in is called.

The base product provides an change data capture algorithm **F1-GCHG-CDCP** that may be used by maintenance objects. This algorithm creates a Sync Request record for each changed record, capturing the MO code and the primary key, if it doesn't find an existing sync request for the same record (and the same business object) in the initial state. The sync request business object used is the one defined in the **Sync Request BO** option on the MO for the record that was changed.

Your specific product may also introduce additional Audit algorithms to cater for more sophisticated examples. Click [here](#) to see the algorithm types available for this system event.

When creating the sync request record, typically the Sync Request BO will have a pre-processing plug-in that captures a snapshot of the record's data prior to its change. This will be used in subsequent steps to verify that the external system needs to be notified of the change.

### Confirming that a Sync is Needed

Once a sync request is captured, there are several steps performed prior to any information being sent to the external system.

---

**NOTE:** This section only highlights key steps. Please refer to the business object configuration, its lifecycle and algorithms for a thorough picture of the full functionality..

---

- When a Sync Request record is created, its initial state (**Pending**) is configured to be processed by a batch monitor. That way, records are added to the sync request table added throughout the day but all are processed together. The MO audit algorithm ensures that a new synch request is not created if a Pending record already exists for a given MO / PK combination (for the same business object). However, it is possible that a record for that MO / PK exists in a subsequent "non-final" (such as **Awaiting Acknowledgement**). This state includes a monitor algorithm to check for that condition and to skip transitioning if another record exists. This is done to ensure that the existing record is fully processed before this new record is processed.
- The next state of the lifecycle is **Determine if Sync Needed**. This step uses an algorithm to take a snapshot (called the 'final snapshot') of the data and compare it against the initial snapshot taken when the record was created. Based on the logic of the algorithm, it may decide to proceed (transition to **Send Request** or to discontinue (transition to **Discarded**).

### Communicating to the External System

Once it is confirmed that the sync should occur, a message must be sent to the external system. The following points highlight the basic functionality.

- An algorithm linked to the **Send Request** state. The expectation is that this algorithm creates an outbound message that routes the information to the external system appropriately. The algorithm must determine the external system and outbound message type to use. Business objects for Sync Request support BO options to define the external system and outbound message type to use for this algorithm.
- Once the outbound message is triggered, the record transitions to the **Awaiting Acknowledgement** status. This state is used to hold the sync request from further state transitions until an acknowledgement is received from the external system. Note that this step relies on implementation of a response mechanism from the external system. It is recommended to implement a response as this helps control the chronological flow of information. The product supplies the business service **F1-UpdateSyncRequest** that transitions the sync request to either the next default state (in this case the **Synchronized** state) if a positive acknowledgement is received; or the state associated with the Rejection transition condition (in this case the **Error** state) if a negative acknowledgement is received. In addition, this state may be configured with a monitor algorithm that detects that a timeout limit has been reached.
- For records that enter the **Error** state, it is recommended to configure an algorithm that creates a To Do entry to alert someone of the problem. Refer to the integration documentation for more information. The state is already preconfigured with an algorithm to complete To Dos when exiting the state.
- The final state **Synchronized** is used to mark the successful synchronizations. However, for more complicated use cases, this state may be used to trigger some additional action. Refer to the documentation for your specific product integration for more information.

## Maintaining Sync Requests

The system provides a Sync Request portal that is used to view the in progress or completed sync request records.

The menu location of the portal depends on your specific edge product. It may be in a Data Synchronization menu or perhaps in the Batch menu. You are brought to a query portal with options for searching. The options may differ based on your specific product.

Once a sync request has been selected, you are brought to the maintenance portal to view and maintain the selected record.

An **Actions** zone may appear to display specific actions. Alternatively, the actions may be displayed directly in the display area of the **Sync Request** zone.

The **Sync Request** zone provides basic information about the sync request record.

Depending on your specific product additional zones may appear.

## Analytics Integration

The framework provides several building blocks and tools that the edge applications may use to implement integration with the Oracle Utilities Analytics product (referred to in this section as the analytics product). The following sections provide more information about this functionality.

### About Analytics Integration

The following sections describe the type of configuration supported in your product to integrate with the analytics product. Refer to the Oracle Utilities Analytics documentation for more information.

#### Master Configuration

Edge applications that include an integration to the analytics product typically include a master configuration record that captures information needed for the extract, load and transformation step, such as extract parameters. These records are provided by the specific edge products and may be viewed and maintained on the [master configuration](#) portal.

Note that your specific edge application may deliver an **Analytics Configuration** portal that displays the information from the master configuration record along with other analytics related configuration.

## Bucket Configuration

The analytics product provides support for defining a set of ranges, each representing a bucket for which extracted measures can be grouped and classified under the relevant bucket. The framework product provides support for viewing and defining the buckets. Refer to [Bucket Configuration](#) for more information.

## Characteristic Mapping

The product provides objects to allow mapping configuration of characteristics in the product to user defined fields on dimensions in the analytics product. Refer to [ETL Mapping Control](#) for more information.

## Change Data Capture Using Sync Request

Depending on the specific edge application and version you are using, there may be components of the integration that use Sync Request for the change data capture step. If that functionality applies to your implementation, the following points highlight how to get more information:

- Refer to the administration guide for Oracle Utilities Analytics to confirm if your product integration is using Sync Request for any change data capture functionality.
- Review the Sync Request Business Objects provided by your product for analytics integration.
- Refer to [Data Synchronization](#) for a high level understanding of the process.

## Maintaining Bucket Configurations

Several key performance indicators in the analytics product look at measurement values (for example: the age of an asset or the age of debt) classified into a number of pre-defined groups also known as buckets. The overall metric can then be reported by the different buckets and allow various analyses.

For example, the age of an asset can be classified into the following buckets:

- Less than 6 Months
- 6-12 Months
- One Year and Older

The age of debt, also known as arrears can be classified onto the following buckets:

- 0-30 Days
- 30-60 Days
- 60-90 Days
- 90+ Days

The definition of the buckets is extracted to the Business Intelligence data warehouse, to be used as dimensions.

## Bucket Definition Considerations

Each type of bucket is defined using a bucket configuration Business Object. The bucket definition considerations and/or rules will vary based on the bucket configuration business object used. The business objects available are driven by your specific product. For a list of available bucket configurations business objects, navigate to the business object page and view the business objects for the Bucket Configuration maintenance object.

## Setting Up Bucket Configurations

To maintain the bucket ranges for the bucket configuration(s) applicable to your product, open **Admin > Analytics Configuration > Bucket Configuration**.

You are taken to the query portal where you can search for an existing bucket configuration. Once a record is selected, you are brought to the maintenance portal to view and maintain the selected record.

---

**NOTE:** Your specific product may also include an Analytics Configuration portal that displays the list of existing and potential bucket configuration records, allowing you to drill into this page to view the record in detail.

---

The **Bucket Configuration** zone provides basic information about the bucket configuration.

For more information about the elements supported refer to the zone's help or to the relevant analytics integration documentation for your product.

## ETL Mapping Control

If your implementation would like to map characteristic data in your application to user defined fields on dimensions in the analytics product, the ETL mapping control provides configuration to support this.

ETL mapping control relies on configuration in the Allowed Target Dimensions [extendable lookup](#). The extendable lookup is used to define each Target Table in the analytics product that has one or more user defined fields that may be populated with characteristic values. It also defines the valid characteristic entities that may act as the source for the characteristic data.

---

**NOTE:** The framework does not provide any values in this lookup, but edge products that support mapping provide values in this lookup. Please refer to your specific product's integration chapter and refer to the Oracle Utilities Analytics documentation for more information.

---

### Setting up ETL Mapping Control

Use the ETL mapping control to define how to populate each target table (dimension) and target column (user defined field) by indicating the characteristic entity, characteristic type and for sequence-based characteristic, the sequence number.

---

**NOTE:** For sequence based characteristics, if the source entity captures multiple characteristic values for a given characteristic type, each characteristic type and sequence combination must be mapped to a specific target table and target column.

---

---

**NOTE:** Only **Adhoc** and **Pre-defined** characteristic types are supported.

---

To maintain the ETL mapping control records, open **Admin > Analytics Configuration > ETL Mapping Control**.

This is a standard [All-in-One portal](#).

Refer to the embedded help text for more information.

## Business Flags

It is possible that information detected in one product may be useful or even critical to share with another product. The framework provides functionality for receiving information from an external system that acts as a type of flag or alert that may need investigation. This allows any system to store detected business flags in a common way and share that information with one or more other systems.

## About Business Flags

The following is an example of a use case for business flags. Imagine that DataRaker highlights potential theft of service at a certain location. That product may initiate a business flag alert to various products owned by the implementation with a recognized "standard name" for the business flag, such as "TAMPER".

- If Oracle Utilities Meter Data Management receives this business flag, it may initiate a service investigation monitor.
- If Oracle Utilities Mobile Workflow Management receives this business flag, it may initiate a service investigation activity.
- If Oracle Utilities Customer Care and Billing receives this business flag, it may initiate a hold on billing for that location.

Note that the framework product supplies basic functionality to support logic that is common to all edge applications that implement business flag functionality. However it is the individual edge applications that supply more specific functionality (business objects and algorithms) for specific use cases, if applicable.

The following sections highlight functionality supported for business flags in the framework. Refer to the edge application product documentation for more details for supported use cases.

## Standard Name

To ensure that Business Flags are universally understood across all edge applications and to simplify integration each Business Flag will have a Standard Name. This is a name that is used by all the products when sending information to each other. That way, if DataRaker product sends Oracle Utilities Meter Data Management a "TAMPER" business flag, it should result in the same functionality as when Utilities Customer Care and Billing sends a "TAMPER" business flag.

Business Flag Standard Names are defined using an extendable lookup. In addition to standard extendable lookup fields, the standard name also references a category. In addition, the lookup supports defining one or more external names, for cases where information is communicated from an external system that does not send the expected Standard Name.

The framework does not deliver any standard names or category values. Refer to your specific edge application products to verify if any standard names or categories are delivered. Your implementation may configure appropriate standard names and categories based on your business rules.

## Business Flag Type Defines Behavior for a Standard Name

Although the definition of the business flag standard names should be universally understood by the various integrated products that support them, each individual product defines what should occur when a business flag with a given standard name is created. This is configured using a business flag type. Only one active business flag type may exist for a given standard name. Business flags that are received from an external system will define the standard name, but will not have knowledge of the specific business flag types defined. The business flag type is determined based on the standard name.

The business flag type defines the business object to use when creating the resulting business flag record. The business object defines the lifecycle of a resulting business flag record.

## Business Flag Type Algorithms

The business flag type includes support for algorithms. This allows for an implementation to define a common business object that may be used for different business flag types (if a common lifecycle is followed) but allow for different functionality to kick in depending on the business flag type.

The product supplies a plug-in spot for **Additional Processing** that may be invoked by a business flag that enters the Additional Processing state. Refer to your product's library of business objects to determine if there is an Additional Processing state that supports calling algorithms on the business flag type.

Click [here](#) to see the algorithm types available for this system event.

## Objects Linked to a Business Flag

There are two types of links between an object in the system and a given business flag.

### Affected Entity

Each business flag is associated with a single record in the system that is considered the “affected entity” or the entity that the business flag is associated with. The affected entity is defined by the specific business objects designed for the use cases supported by your edge product. For example, many utility base products may configure service point as the affected entity for its business flag use cases. Each business flag created is linked to a specific service point. Linking a specific entity to each business flag allows for algorithms to trigger functionality for that entity such as an investigation order. In addition, algorithms may be implemented in other business process areas that look for the existence of a business flag and act accordingly.

### Related Objects

The business flag supports linking one or more related objects to a business flag to make it easier to trigger functionality or for impacted business processes to look for business flags. For example, when creating a business flag for a given service point, it may be useful to link all the accounts that are currently linked to the service point. Then, if an account oriented process should check for a business flag, it can look directly for a business flag linked to the account in its related object.

## Impacted Business Process

The product supplies support for associating one or more impacted business processes to a business flag type. This configuration is used when functionality for that business process is impacted in some way based on the existence of a business flag of a given type. For example, maybe some process is put on hold when a certain type of business flag exists.

Note that configuring a business process on business flag type is not enough to trigger any impact on that business process when a business flag exists. There must also be some logic implemented in the business process functionality itself that knows to look for a business flag for a given record that is configured to impact the business process.

The definition of the business process is at the discretion of the edge application that supplies functionality to support this. For example, the business process could be defined as something broad such as “billing” or could be something more granular such as “billing estimation”. The system supplies an extendable lookup to use for configuring the supported business processes. Refer to the values of the business process extendable lookup in your edge application or to the edge application specific Business Flag documentation for more information about supported business processes.

## Dates

A business flag supports two dates: a Business Flag Date/Time and a Business Flag **End** Date/Time

- The business flag date / time is required for all business flags. For some types of business flags only one date is needed.
- For business flags that have a start and end period, the business flag date/time acts as the start date and the other field is the end date.

For a business flag that has a date range, it may be important for functionality implemented for [impacted business processes](#). How the process treats the date will depend on its functionality.

- For some processes, the business flag is essentially expired after the end date has passed. This applies to impacted processes that are only looking at the current status of data in the system. For example, collection processing could be held if there is a business flag currently in effect (where the current date is within the date range). It would never look at historical business flags.

- For some processes where historical data may be relevant, a business flag effective during that same historical period may impact the process. For example if a business flag denotes an outage event for a given time period, perhaps estimated consumption should never be calculated for that time period.

Note that because business flags have a status, the design for the lifecycle of the business objects for the above effective dated use cases must carefully consider the states. For business flags that are considered expired after the end date passes, the BO lifecycle may be designed to transition to a final state after that date such that the record is no longer included in active processing. For business flags that continue to impact processing for a historic period, the BO lifecycle may be designed to remain in a non-final state such that it is clear that the record is still applicable.

## Creating Business Flags

Business flags may be created in a system for one of the following reasons:

- A message is received from an external system that initiates the creation of a business flag. In this case, logic in the external system has detected some situation that this product is being alerted about.
- Business logic in this product detects a situation that should be investigated or should act as a flag. In this scenario, there may not be any integration needed depending on the business rules.
- Business logic in this product detects a situation that another integrated product should be alerted about. In this scenario, the business flag record is used to send out information to the integrated product.
- A user manually creates a business flag based on knowledge of the affected entity. For example, a customer service representative may create a business flag as a result of contact with the customer.

### Creating a Business Flag from a Web Service

The system supplies an inbound web service Business Flag Sync Driver (**F1-BusinessFlagSync**) that may be used for an external system to initiate (or update) a business flag. It references a service script whose ultimate responsibility is to determine the appropriate Business Flag Type, based on the standard name or external standard name, and therefore the appropriate business object for the new business flag. Because different products may have different logic related to creating a business flag, the service script calls another service script linked to the maintenance object using the Business Flag Sync MO option.

The framework does not supply a Business Flag Sync service script, however individual edge applications supply a service script based on the use cases it supports out of the box.

---

**NOTE:** For products that are continuing to use XAI for external messages, the product also includes an XAI inbound service for the same Business Flag Sync Driver service script. Note that the product recommendation is to discontinue use of XAI and use [inbound web services](#) instead.

---

### Error Handling

If there is a problem in trying to create a business flag based on incoming information, the Business Flag Sync Driver service script creates a special business flag record using the Business Flag Error Business Object. This is also configured on the maintenance object as an option. The framework product supplies the business object Business Flag Error (**F1-BusinessFlagError**) for this functionality. Refer to the business object description and configuration for more information.

### Confidence

There may be use cases where a condition is suspected, but not confirmed. The originating system should be able to assign a "confidence" level to the business flag.

For example, DataRaker through aggregating and analyzing large amounts of data identifies potential revenue protection issues that need investigation. It triggers business flags with a **Suspected** confidence.

An application receiving this business flag may adjust the confidence to either **Confirmed** or **Rejected**. That update can be communicated to the other products that received the same business flag.



Note that the application that receives a business flag is responsible for acting on the value based on business rules.

Because a utility implementation may have multiple applications installed that support business flags, the following guidelines are suggested for designing where the confidence flag should be updated.

- If Oracle Utilities Service Order Management is implemented, it has the responsibility of updating the confidence flag and communicating the update to other products.
- Otherwise, the assumption is that Oracle Utilities Customer Care and Billing owns field work orchestration and that it will have the responsibility for updating the confidence flag and communicating the update to other products.

No product logic is provided to enforce the above suggestions, however, the business objects supplied by the different edge applications will support the recommended implementation.

## Business Flag Updates from External System

When the product that is responsible for updating the Confidence flag makes a change, it should initiate an outbound message to alert other products. On the receiving side, the same inbound web service and Business Flag Sync service script is responsible for the update. Refer to [Creating Business Flags](#) for more information.

## Setting Up Business Flag Configuration

The following topics highlight the general configuration steps required to use business flag functionality. Your specific product may supply additional functionality to support specific use cases for business flags. Refer to your specific product's documentation and the library of business objects supplied for Business Flag in your product for more information.

### Standard Name Category Characteristic Type

Define one or more categories for grouping your standard names into logical business groupings.

Navigate to the [Characteristic Type](#) page. Search for and select the Business Flag Category characteristic type (**F1–BUSFC**).

Define desired category values and descriptions to be used for the standard names.

### Business Flag Standard Name Lookup

Navigate to the [Extendable Lookup](#) portal. Search for and select the **Business Flag Standard Name** business object.

Define values that are recognized in the external systems that your implementation is receiving business flag details from.

Define a **Category** for the standard name that is appropriate for your product. Note that the category does not have to be in sync with standard name definitions in external products.

Refer to the embedded help for more information about configuring this object.

### Business Process Lookup

If your specific product supports configuring business processes that may be impacted by the existence of a business flag, they are defined as an extendable lookup.

Navigate to the [Extendable Lookup](#) portal. Search for and select the **Business Process** business object.

## Integration Configuration

The following points highlight configuration required to support receiving business flag information from an external source:

- Define a record for each [External System](#) that the product may be receiving business flag records from. This should be a value known by the external system and provided when new business flags are sent to this product.

When this product should initiate business flag information to be sent to an external system, configure one or more [Outbound Message Type](#) records. For each one, update the External System to configure how each outbound message type is communicated to the external system.

## Defining Business Flag Types

Refer to [About Business Flags](#) for an overview of business flag functionality.

To maintain the business flag types applicable to your product, open **Admin > Integration > Business Flag Type**.

This is a standard [All-in-One portal](#).

The information captured on the business flag type depends on the business objects supported by your product. Refer to the embedded help text for more information.

### Where Used

Follow this link to open the data dictionary where you can view the tables that reference [F1\\_BUS\\_FLG\\_TYPE](#).

## Maintaining Business Flags

This section describes the functionality supported for viewing and maintaining business flags.

Refer to [About Business Flags](#) for an overview of business flag functionality.

Navigate using **Main > Integration > Business Flags**. You are brought to a query portal with options for searching for business flags.

Once a business flag record has been selected, you are brought to the maintenance portal to view and maintain the selected record.

The **Business Flag** zone provides basic information about a business flag. Refer to the embedded help for more information.

## Configuration Migration Assistant (CMA)

This chapter describes the Configuration Migration Assistant (CMA), a facility to enable the export of customer-owned configuration data from one environment to another.

---

**CAUTION:** This chapter is intended for users responsible for testing configuration data and performing "what if" analysis in non-production databases.

---

## Understanding CMA

The Configuration Migration Assistant (CMA) provides implementers with a flexible, extensible facility for migrating configuration data from one environment to another (e.g., from a development environment to a production environment). Data is exported from the source system to a file. The file can then be checked in to a version control system for reuse, or can be immediately imported into the target system and applied.

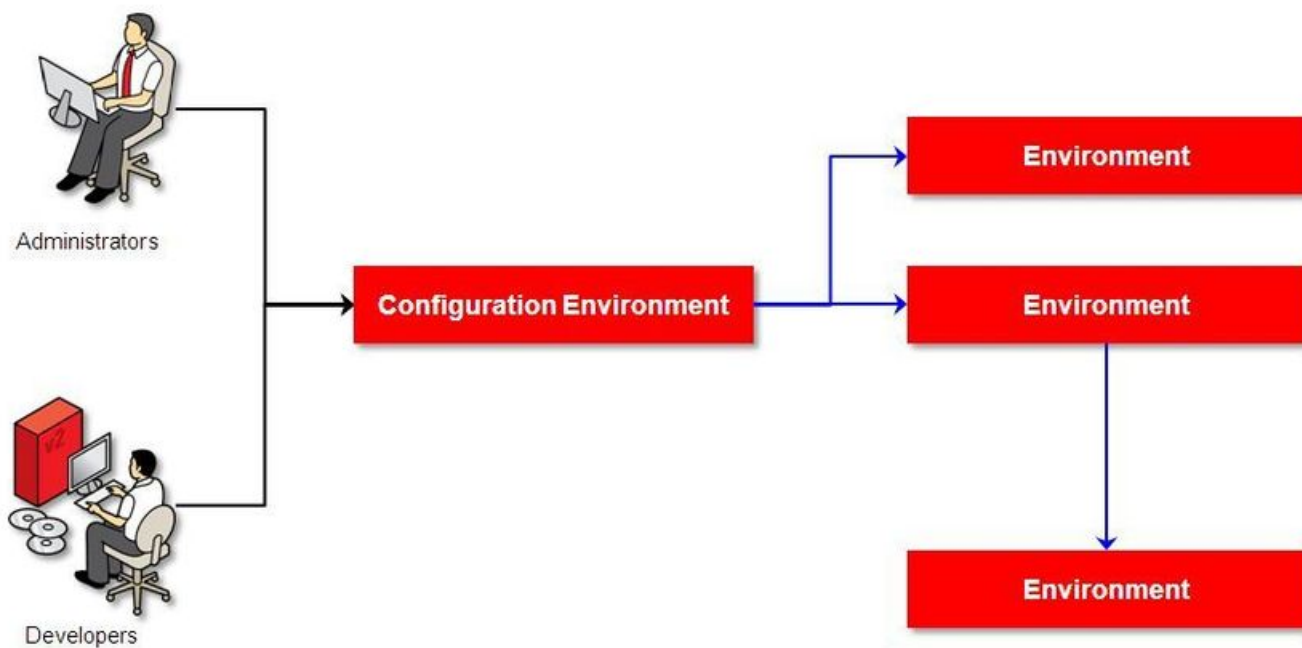

**NOTE:** As used in this chapter, *source* systems are those on which export-related activities are conducted and *target* systems are those on which migration updates are to occur. The two system preparation tasks described in [Migration Assistant Configuration](#) must be performed on both source and target systems.

## The CMA Process Flow

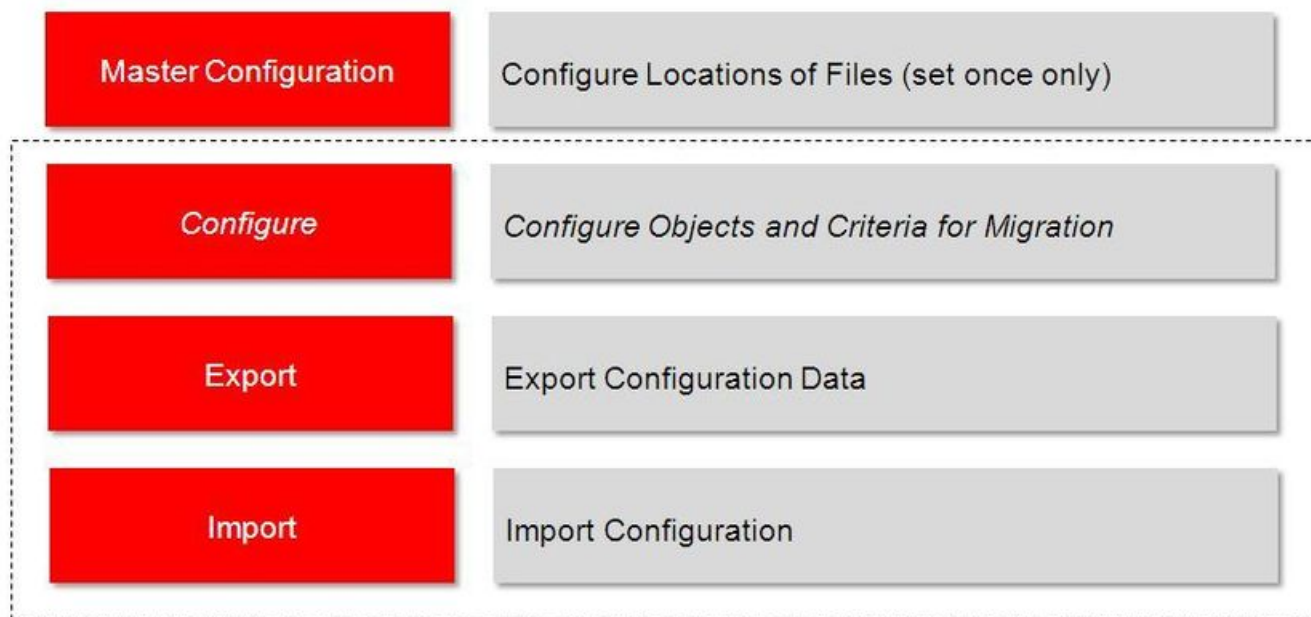

The high-level CMA process comprises the following tasks and flows. Each is described in more detail later in this section.

- **Configuration** steps are used to define the data to migrate. This task is performed on the source system and may be defined at any time. Note that the products provide base delivered configuration that may be used as is or used as a template for building more specific configuration for a given implementation.
- Specify the source and target paths and a file extension for import and export data files in the **Migration Assistant Configuration** master configuration record.
- Each type of record that may be copied requires a **Migration Plan**. The migration plan is used to identify the maintenance object (MO) for the record (using a business object) and allows for instructions to specify related records that may be included in the migration. Multiple migration plans may exist for a given maintenance object if there are different requirements for migrating records in that MO under different circumstances.
- The primary instruction in the migration plan could define the physical BO of the record. This signals to CMA that all records for the MO are eligible to be migrated.
- The primary instruction may define a specific BO, in which case only records that reference that BO in its parental hierarchy are considered.

---

**NOTE:** Refer to [Understanding the BO Filtering Process](#) for more information.

---

- Subsequent instructions may include references to related records. There may be some circumstances where a migration should include subsequent records and some circumstances where they shouldn't based on requirements.
- A **Migration Request** is used to define the data to include in a given migration. There are several types of migration requests:
  - **Criteria-based.** This type of migration request defines a set of migration plans to be logically included together as part of a migration. For each migration plan, selection criteria may be defined to limit the migration to a subset of data for each MO. Selection may be defined using SQL, an algorithm or explicit primary key values.
  - **Entity List.** This type of migration request allows the user to choose explicit MO / prime keys. It is meant for a targeted migration of specific objects. Note that although the user views and maintains MO / PK values when configuring this type of migration request, a migration plan is still used internally for the CMA migration processing.
  - **Group.** This type of migration request points to other migration requests. This allows you to define separate migration requests that represent logical groupings of migration plan instructions for ease of maintenance, but to combine all the separate migration requests into a single "grouped" migration request for streamlined export / import purposes.

---

**FASTPATH:** For more information, refer to [CMA Configuration](#).

---

- The **Export** process includes all the steps needed to select records to be exported from the source environment and create the export file.
  - A **Migration Data Set Export** object is created for a specific migration request.
  - The lifecycle of the Migration Data Set Export business object includes algorithms that select the appropriate records according to the migration request, determine dependencies between records to build groupings of related objects and create the export file.
  - Because there may be a large volume of data in the export, many of the steps in the lifecycle of the migration data set export are executed via the **Migration Data Set Export Monitor**.

---

**FASTPATH:** For more information, refer to [Exporting a Migration](#).

---

- The file created by the export, which is a BINARY file, needs to be transferred from the export directory to the import directory. The transfer needs to be done in such a way as to preserve the file structure. Refer to [Migration Assumptions, Restrictions and Recommendations](#) for more information.

- The **Import** processes include all the steps needed to read an imported file, compare the data in the file to the data in the target, review the proposed changes and apply the updates. The following is a high level overview of the process.
  - A **Migration Data Set Import** object is created for a given file to import.
  - The next step reads the import file and creates **Migration Transactions** and **Migration Objects** based on the information in the import file. A migration object is created for every maintenance object record to potentially be created or updated. The migration transaction is a grouping record that groups together related migration objects.
  - The next step is for the objects to **Compare** the data being imported against the data for that record in the target environment. If it is found that the migration object is new or represents a change to the existing record in the target environment, appropriate SQLs are generated. If no changes are found, the object is marked “unchanged” and doesn’t progress.
  - Once all the objects are compared, the user may review the objects for acceptance or rejection.
  - When the migration objects are all accepted or rejected, the next step is to apply the objects and update the target environment.

---

**FASTPATH:** For more information, refer to [Importing and Applying a Migration](#).

---

## Migration Assumptions, Restrictions and Recommendations

The following sections describe miscellaneous topics that are important to learn with respect to CMA.

### Type of Data Migrated

CMA is designed to migrate configuration data.

The comparison step of the import process will generate appropriate insert or update SQL statements for the following data found in the export:

- Configuration data in a maintenance object with no owner flag. This is purely implementation data.
- Configuration data in a maintenance object with owner flag, where the owner is **Customer Modification**. For example, implementer-specific business objects.
- Configuration data in a maintenance object with owner flag, where the main record is owned by the product but where a child record exists with an owner of **Customer Modification**. For example, implementer-specific algorithms added to a base owned business object.
- Customizable fields in a record that is owned by the product. For example, the priority of a based owned To Do type.

### Data with System Generated Primary Keys

The tool provides support for administrative data with system-generated primary keys. The logic relies on the maintenance object to use a method that looks at other attributes of the record (considered a “logical key”) to detect whether the record being migrated already exists in the target region or not. The examples in this section will use the Attachment maintenance object as an example. Common attachments are considered administrative data. The attachment MO uses the file name and the creation date as the “logical key”.

Imagine a common attachment for the "standard rate codes" file exists in a source region with the key 123456789. The table below highlights possible situations at the target region and actions supported in CMA.

Scenario	Target Situation	Action	Comments
1	No matching record	Record can be added with key 123456789.	
2	Record exists with key 123456789 and logic confirms that it is also the "standard rate codes" attachment.	Record can be updated.	

Scenario	Target Situation	Action	Comments
3	Record exists with key 123456789, but logic detects that it is not the "standard rate codes" attachment.	Record is not updated. An error is issued.	The system cannot update this record because it's not the right attachment record.
4	The system detects that another attachment record exists for the "standard rate codes" attachment with a different ID.	Record is not updated. An error is issued.	Assumption is that the record was created directly in the target or was copied from a different source.

The use cases described in scenarios 3 and 4 above would require key mapping to keep track of the id from the source to the id in the target so that any other records from the source that reference this key as a foreign key would be updated as part of the migration. This functionality is not supported.

Scenarios 1 and 2 above are supported for maintenance objects that use the method to detect the logical key.

**NOTE:** If a maintenance object with a system generated key does not supply a method to detect the logical key, CMA will update an existing record with the same ID. For maintenance objects in the framework that provide this method, refer to [Framework Provided Migration Configuration](#). For your specific edge application, refer to the CMA addendum for information about support for admin data with system generated keys.

The product recommends that an implementation establishes a migration strategy such that administrative records with system generated keys are always created in the same region and always follow a standard migration path for promoting the data from this source region to other regions. Following this strategy, you would minimize or eliminate the possibility that a record for the same logical key is created in multiple places such that different IDs would be generated as described by scenario 4 above.

### MOs with a Mixture of Administration and Non-Administration Data

There are some MOs that contain a mixture of master or transaction data and administrative data. The Attachment is an example of this. The product supports common attachments and owned attachments. Owned attachments are records that are specific to its owner. The owner could be master or transaction data and its attachments are therefore considered master or transaction data. Owned attachments are not candidates for migration using CMA. Common attachments on the other hand are considered administrative data and may be candidates for migration using CMA. For these use cases, an implementation may follow the suggested strategy of only creating the administrative data in one region so that IDs for common attachments are not reused. However, it is reasonable and expected that owned attachments are being created in the target region and may receive a system generated key that matches the key of a common attachment from the source region.

To try to minimize this issue, the system includes special logic to be used by any MO that may contain administrative data mixed in with master or transaction data. This special logic generates the key of an administrative record with a zero (0) in the middle of the key and ensures that the keys for master and transaction data do not include a zero in this spot. For maintenance objects in the framework that use this method, refer to [Framework Provided Migration Configuration](#). For your specific edge application, refer to the CMA addendum for information about additional maintenance objects that may be in this category.

### No Record Deletion

The CMA process allows users to define records to copy from a source environment to a target environment. In that way, the import process for the migrated records is able to identify objects to add and objects to change. There is no mechanism for indicating that records in the target environment should be deleted. The absence of those records in the import is not enough because the migration may be only importing a subset to add or update. If data on the target system must be deleted, users must delete the records in the target accordingly.

Note that CMA does support the deletion of child rows of an object as a result of a comparison. This is only applicable to child records that are owned by the implementation.

## File Transfer Considerations

When moving the export file between systems, use the binary transfer option of whatever tool you use to move the file so that line-end characters are not converted from Linux-style to Windows-style or vice versa.

It is recommended to avoid using 'txt' for the export file's extension (defined in the [master configuration](#)). That file extension by default implies a non-binary file and tools that perform file transfer may treat this as a non-binary file unless explicitly stated. The recommendation is to define 'cma' as the extension. This is not a recognized file extension and most file transfer tools will transfer the file as is.

Note that if the file gets converted, there are two likely outcomes - either a numeric conversion error, or a buffer under-run error may be received when attempting to import the file.

## Multi-Language Environment Considerations

If your implementation uses a language other than English, it means that migrated objects may have multiple language rows (because English is always enabled). There are some important points with respect to multiple languages and CMA:

- As described in [User Language](#), there are steps to follow when supporting an additional language. The steps outlined in that topic highlight that for system data, translation of the strings may be provided via a language pack provided by the product or may be the responsibility of your implementation. In either case, this effort is non-trivial and will have its own established plan. The expectation is that the translation of the system data is applied for each region at your implementation site. CMA should not be used to create a new language in a target region.
- For administrative / control data that your implementation develops as part of your project, the expectation is that descriptions for your supported language are entered in the region that is considered the source region used to promote changes to regions in the "chain". For example, control data is entered in a development region and promoted to a test with the supported language enabled in both regions.
- What if you export data from a region with more languages enabled than your target? This scenario is perhaps a case where the source region is a type of test or playpen region where the additional language is enabled for other purposes. In this case, if the language code doesn't exist at all in the target region, the import will produce an error given that the code is invalid. If the language code exists but is not enabled, this will cause the extra language rows to be inserted in the target region, but will not cause any issues. They are simply ignored.
- What if you export data from a region with fewer languages enabled than your target? In this situation, the import process will only create language rows for the languages that were copied from the source. It will not automatically create language rows in the target as part of the import. For this situation, the recommendation is to run the **New Language** batch program ([FI-LANG](#)) that creates any missing language entries.

## CMA Configuration

The following sections describe tasks required for CMA configuration.

### Master Configuration - Migration Assistant

In both the source environment and the target environment, the system needs to know the location of the export directory and the import directory along with the expected file suffix. Implementations may define the information explicitly for each region using the **Migration Assistant Configuration**[master configuration](#) record.

For more information about specific fields in the master configuration, refer to the embedded help.

---

**NOTE:** This record can be updated at any time to change details. The new configuration takes effect on all subsequent exports and imports.

---



Implementations may also rely on the system defaults. If no Migration Assistant Configuration record is found, the system assumes that there is an entry defined in the system's substitution variable list for **F1\_CMA\_FILES**. Further it defaults the values as follows:

- Export directory is the value for this variable plus "**\export**".
- Import directory is the value of this variable plus "**\import**".
- File suffix is set to **cma**

Refer to [Referencing URIs](#) for more information about the substitution variable list.

## Migration Plans

A migration plan defines one or more types of objects that are eligible for migration. It is essentially a set of instructions describing how the data to be exported is structured, allowing objects to be migrated together as a logical unit to ensure consistency and completeness.

The following topics describe defining a migration plan as well as other topics for a migration plan.

### Defining a Migration Plan

To view or define a migration plan, navigate using **Admin > Implementation Tools > Migration Plan**.

Use the **Migration Plan Query** portal to search for an existing migration plan. Once a migration plan is selected, you are brought to the maintenance portal to view and maintain the selected record.

---

**CAUTION:** Important! If you introduce a new migration plan, carefully consider its naming convention. Refer to [System Data Naming Convention](#) for more information.

---

The following points provide information about defining **Instructions** for a migration plan.

The **Instruction Sequence** uniquely identifies the instruction. The recommendation is to use increments of 10 to allow insertion of other instructions in the future.

Select **Primary** for the first **Instruction Type**. All migration plans must contain one and only one primary instruction. All subsequent instructions require a **Subordinate** instruction type. In this case, the **Parent Instruction Sequence** must be entered. This number, used to maintain the defined relationships in the exported data, must match an instruction sequence number at a higher level in the hierarchy.

The instruction **Description** provides a business description of the instruction.

Select a **Business Object (BO)** to define the type of object from which data will be derived.

---

**NOTE:** Though BOs are specified in each instruction, it's important to understand that each BO is used only for filtering purposes. The migrated data set comprises the complete contents of the *maintenance object* that the business object structure is defined against. For a more detailed explanation of this, see [Understanding the BO Filtering Process](#).

---

**NOTE:** Refer to [Identifying Tables to Exclude From Migrations](#) for information about defining child tables to always exclude from a migration.

---

**Traversal Criteria** is used to define the relationship between each of the objects in a migration plan. The system provides three options to define how the child object is connected to the parent object so the system knows how to traverse from one object to another. **Traversal Criteria Type** options are **Constraint**, **SQL** and **XPath**. The following points explain each option:



- **Constraint** allows you to select a table constraint that represents a given record's relationship to another record in the system via a foreign key constraint defined in the meta-data. If **Constraint** is selected, the following additional fields are enabled:
  - **Constraint ID** is a unique identifier for the constraint. The search will show the valid table constraints for the MO of the instruction's BO and the MO of the parent instruction's BO.
  - **Constraint Owner** is used to define the owner of the constraint. This is populated automatically when selecting a constraint from the search.
- **SQL** lets you specify SQL join criteria between the parent instruction's object and the child object in the **SQL Traversal Criteria**. The syntax of the the traversal criteria is a WHERE clause (without including the word WHERE). When referring to a field on the parent instruction's object, use the syntax #PARENT.TABLE\_NAME.FIELD\_NAME. When referring to a field on the current instruction's object, use the syntax #THIS.TABLE\_NAME.FIELD\_NAME. For example, the following statement is used on a migration plan for Business Object, where the parent instruction is the BO and the subordinate instruction is used to reference the UI Map that is referred to as a BO option with the option type "F1DU":#PARENT.F1\_BUS\_OBJ\_OPT.BUS\_OBJ\_OPT\_FLG = 'F1DU' AND @trim(#THIS.F1\_MAP.MAP\_CD) = @trim(#PARENT.F1\_BUS\_OBJ\_OPT.BUS\_OBJ\_OPT\_VAL).
- The **XPath** option lets you apply syntax in an XPath expression referencing elements in the instructions' referenced business objects. This is entered in the **XPath Traversal Criteria**. For example, the display map collection statement in the SQL example noted above would be written as follows in XPath: #this/mapCd = #parent/businessObjectOption/businessObjectOptionValue AND #parent/businessObjectOption/businessObjectOptionType = 'F1DU'. This technique allows foreign key references that are mapped inside an XML column to be referenced.

---

**NOTE:** The #parent expressions may access elements that are stored in an XML column and described using mapXML and mdField. However, the #this expressions must refer to fields available in the business object using the mapField reference.

---

Defining **Next Migration Plan** provides the ability to indicate that in addition to copying the object defined in the instruction, any additional instructions included in that referenced migration plan will also be included in an export.

The **Algorithms** grid contains algorithms associated with each instruction. You must define the following for each algorithm:

- Specify the **System Event** with which the algorithm is associated (see the table that follows for a description of all possible events).
- Specify the **Sequence** and **Algorithm** for each system event. You can set the **Sequence** to 10 unless you have a **System Event** that has multiple **Algorithms**. In this case, you need to tell the system the Sequence in which they should execute.

System Event	Optional / Required	Description
Pre-Compare	Optional	Algorithms of this type may be used to adjust the data after it is moved to the target system. These may only be defined on the primary instruction.  Refer to <a href="#">Adjusting Imported Data</a> for more information.  Click <a href="#">here</a> to see the algorithm types available for this system event.
Import	Optional	Algorithms of this type are no longer supported.

### Where Used

Follow this link to open the data dictionary where you can view the tables that reference [F1\\_MIGR\\_PLAN](#).

## Understanding the BO Filtering Process

Migration plan instructions require the definition of a business object to provide CMA with information about the record related to the instruction.

If the business object is the physical business object for the maintenance object, then CMA assumes that the instruction applies to all records that satisfy the traversal criteria. CMA recognizes the physical BO by comparing the BO to the value defined in the maintenance object option. If the business object defined is not the physical BO, then CMA will limit the records in the instruction to those that explicitly reference this BO or reference a child of this BO as its [identifying BO](#) value. (In other words, this BO must be in the parentage hierarchy of the records to be included in the instruction.)

---

**NOTE:** Unlike Bundling, CMA does not use the BO schema to drive what data is copied for a given record. The BO is only used as a filtering mechanism for selecting records. Refer to [Identifying Tables to Exclude from Migration](#) for information about how to ensure a child table is not included in a migration.

---

For example, if you define a migration plan for Master Configuration and use the physical business object for the instruction (**F1-MstCfgPhysicalBO**) then all master configuration records are considered for the instruction. If instead the business object you define is Migration Assistant Configuration (**F1-MigrationAssistantConfig**) then only the record related to this business object is included in the instruction.

## Migration Plans for Objects with XML-Embedded Links

When migrating objects where foreign key references are captured in the object's XML based field, subordinate instructions are needed to define the foreign key references in order for CMA to understand the relationships. This is in contrast to direct foreign keys where CMA can determine the relationships using constraints. The instructions provide two purposes. For wholesale migrations, where all data (or a large amount of data) is being migrated, the instructions allow CMA to group related objects into transactions. This helps in the apply process at import time to ensure that related objects are grouped together. However, the apply process includes iterative steps to try to overcome dependencies like this so defining the instructions is not critical for this type of migration. For targeted migrations, defining instructions ensures that the related objects are included in the migration, if appropriate.

The following are options for creating migration plans with XML-embedded links:

- One option is to use the specific logical (business) BO in the primary instruction to define the object you are copying. With this option, the subordinate instructions may use XPath criteria to define the related foreign key. When this approach is used, a separate Migration Plan must be created for each logical BO. (Refer to [Understanding the BO Filtering Process](#) for more information.) This option would only be used in isolated cases.
- Another option is to create a migration plan that uses the Physical BO as the primary instruction, and then include a subordinate instruction for the real logical BO, using SQL Traversal to join the object to itself by its primary key. Note that with this technique, the records that reference the logical BO will still only be included in the export file once. At this point further subordinate instructions may use XPath notation to define the foreign key data. Using the physical BO as the primary instruction ensures that all records in the MO are considered. The subordinate instructions with the logical BO and XPath notations will only apply to the records that are applicable to that BO. This option is useful for MOs that have a small number of logical business objects with disparate foreign keys.
- Another option is to use the physical BO in the primary instruction and use raw SQLs in the subordinate instruction's traversal criteria to identify the foreign keys using substring commands. A separate Subordinate Instruction is needed for each SQL corresponding to each element occurrence. Using this technique has the same advantages of the previous in that all records for the MO are included in the migration. However, this technique may be useful for maintenance objects with a larger number of business objects expected where each has one or more foreign keys. It's especially useful if many business objects reference the same foreign key. Then only one instruction is required for that foreign key. Note that a single migration plan may use this technique and the XPath technique for different elements.

A migration request may have multiple migration plans for the same maintenance object. That allows for some flexibility and long term maintainability in that the above techniques may be used in multiple migration plans. Consider the following example:

- A product provides base business objects with foreign keys defined in the XML field and provides the appropriate migration plan with instructions. An implementation extends this business object or perhaps creates their own business object for the same maintenance object and includes different additional foreign keys in the XML. Rather than duplicating the base migration plan and adding additional instructions for the additional foreign keys, the implementation can create a second migration plan for the MO with the additional foreign keys defined. A migration request should be defined to include both migration plans. In this case if the implementation has only one custom BO, they can choose to use the custom BO as the primary instruction as described above in the first option.

## Defining a Migration Request

Migration Requests are used to define the data to be included in a migration. To view or define a migration request, navigate using **Admin > Implementation Tools > Migration Request**.

Use the **Migration Request Query** portal to search for an existing migration request. Once a migration plan is selected, you are brought to the maintenance portal to view and maintain the selected record.

There are three types or classes of migration request. The system provides a base business object for each along with a migration request class, which matches the business object. The subsequent sections provide more information about each class of migration request.

Note that all migration requests support defining a Category, which allows implementers to categorize the migration request.

In addition, all classes of migration request include the following zones:

- **Migration Request** This zone contains display-only information about the selected record. Please see the zone's help text for information about this zone's fields.
- **Referencing Migration Requests** This zone is only visible if the displayed migration request is included in a Group migration request. It lists each group migration request that includes it.

Other zones may appear for specific classes of migration requests. See the following sections for more information.

### Where Used

Follow this link to open the data dictionary where you can view the tables that reference [F1\\_MIGR\\_REQ](#).

### Criteria-based

This type of migration request defines a set of migration plans to be logically included together as part of a migration. For each migration plan, selection criteria is defined to indicate which records for each MO should be included. Selection may be defined using SQL, an algorithm or explicit primary key values.

- For selection using SQL Statement, refer to the embedded help for examples.
- For selection using Algorithm, the algorithms that are eligible to be plugged in here are those valid for the **Migration Request - Select** system event. Click [here](#) to see the algorithm types available for this system event.
- For selection using Specific Keys, the primary key (1 through 5) must be explicitly specified. Multiple rows are allowed.

### Entity List

This type of migration request allows the user to choose explicit MO / prime keys. The MOs that are eligible are those that are configured with a **Default Migration Plan** option. Although the user is managing MO / PKs, the migration instructions are still defined with a migration plan. The system maps the migration instructions in a similar way to a **Criteria-based** migration requests that use a Specific Key selection type. Note however that it will create a separate

migration instruction for each MO / PK combination. It does not try to group all PKs for the same MO / migration under one migration instruction.

For this type of migration request, a user adds a migration request record with its description and other main information. Then, a special zone **Add Entities** is provided to find and select records based on a selected maintenance object and add to the migration request. The user is prompted to provide a reference and comments, if desired. If the category selected is one that requires a reference, then this will be validated.

When maintaining a migration request with existing entities, they are visible in the zone **Migration Request Entities** . This zone allows a user to remove the entity from the list.

## Group

This type of migration request points to other migration requests. This allows you to define separate migration requests that represent logical groupings of migration plan instructions for ease of maintenance, but to combine all the separate migration requests into a single "grouped" migration request for streamlined export / import purposes.

The CMA export process will build an extract that includes the union of all the objects that qualify for the export and group them together based on their relationships.

## Wholesale and Targeted Migrations

The Configuration Migration Assistant is used for two general types of migrations: wholesale and targeted. The following sections provide some additional information about these concepts.

### Wholesale Migrations

Wholesale migrations are used when migrating all the configuration and/or administrative data from one environment to another. For example, a wholesale migration might be used when migrating administrative data from a development or test environment to a production environment.

A wholesale migration may be comprised of one or more migration requests that in total include all the administrative data to move. With the ability to group migration requests, the expectation is that implementations follow these guidelines:

- Multiple migration requests using the Criteria-based or Entity List migration request classes are used to group information logically together to allow for more reuse.
- A Group migration request is used for the export. This allows for one data set to export and one data set on the import side, simplifying the process. Note that depending on the amount of data, this may be a large import set to process. An implementation may find it easier to create multiple migration requests that break down the process into several steps.

You should consider that the framework product provides base migration requests and your specific edge product may provide base migration requests as well that may or may not include framework migration plans. Using the product provided migration requests is beneficial with respect to maintenance. As features are added to the product (including new administrative maintenance objects), any impact on CMA should be included in the product owned migration requests. If your implementation introduces new custom administrative maintenance objects that should be included in CMA, then custom migration plans and a custom migration request should be added. Your implementation can build a Group migration request that includes the base migration request and your custom migration requests to have a consolidated export.

Migration plans used in wholesale migrations may be designed to omit subordinate instructions related to explicit foreign keys that are identified through constraints as they are not needed, assuming that the data they are referring to will also be included in the migration.

---

**NOTE:** Refer to [Framework Provided Migration Objects](#) for information about migration requests provided in the framework product. Refer to your specific product's documentation for information about addition base provided migration requests.

---

## Targeted Migrations

A targeted migration refers to migrating a specific subset of data from one environment to another. Examples of targeted migrations include:

- Migration of a new Business objects with its options and algorithms.
- Migration of a new maintenance portal, its zones, and its application service.
- Migration of all outbound message types.

It is expected that the Entity List migration request is used for these types of migrations.

## Identifying Tables to Exclude From Migrations

Some maintenance objects that are eligible to be migrated may include child tables that should not be included in the migration. For example, if an object includes log tables, the entries in the log should reflect the actions on the object in that system, and will be different between the source system and the target system. If you have a custom Maintenance Object that includes tables you don't wish to migrate (such as a log table), use the **Non-Migrated Table** option on the MO to specify this table. All child records for this table will also be ignored during migration.

Another use case to consider is a child "many-to-many" table that connects two administrative objects and exists in the maintenance object of both tables. The child table may be in both MOs for convenience sake, but it may be that one MO is considered more of a "driver" object and the other more of a subordinate. If you are doing a targeted migration where you want to copy a subset of objects, you may want to only copy the driver object and its children and their data but not their children. For example, in Oracle Public Sector Revenue Management, a Form Type includes a collection of valid Form Change Reasons and in turn the Form Change Reason refers to its Form Types. If an implementation wants to do a targeted migration of a form type and include all its related information, including form rules and form change reasons, it does not want the migration of a form change reason to in turn copy all its form types (and their data).

---

**NOTE:** The MO option must be set in both the Source and Target systems for a given MO.

---

## Configuring Custom Objects for Migration

During the implementation and extension of the product, new custom administrative maintenance objects may be introduced. If your implementation would like to migrate records in those maintenance objects using the Configuration Migration Assistant, additional steps must be performed, which are highlighted in the following sections.

### Physical Business Object

As described in [Understanding the BO Filtering Process](#), the migration plan requires a business object for its instruction. The business object is used to identify the records eligible for inclusion in the migration. Assuming your custom tables use one or more "logical" business objects for their processing, your implementation must decide if these business objects are appropriate for use by the migration plans, or if a physical BO is warranted. If so, create an appropriate physical BO.

### Review MO Option Configuration

The following points highlight maintenance object (MO) configuration that should be reviewed or updated to support CMA:

- If a physical BO was created (above), link it to the MO as an option using the appropriate option type.
- Be sure that your MO defines an appropriate [FK Reference](#) and includes an Option on the MO that identifies the FK Reference. This is used by various portals and zones for CMA when showing detail about records being imported into the target region. Also be sure that this FK reference defines an Information program.

- As described in [Identifying Tables to Exclude From Migrations](#), an MO option is used to identify child tables for an MO that should never be included in a migration. If your custom maintenance object includes a standard Log table, then the recommendation is to list that table as an excluded table. Depending on the specific design of the maintenance object, there may be other child tables to define.

## Characteristic Type Configuration

The CMA import process will attempt to create a log record for any administrative object that includes a log table. If your implementation has introduced any custom administrative tables that you plan to include in a migration request and it includes a log table, you must, to ensure that the log creation is successful, add your log table as a valid characteristic entity to the characteristic type **F1-MGO** (Migration Object).

Navigate to [Characteristic Type](#) and select the characteristic type **F1-MGO**. Navigate to the **Characteristic Entity** tab and add a row to include the characteristic entity for your custom maintenance object's log table.

## Standard CMA Configuration

Create one or more migration plans for the new object, depending on the type of data in the maintenance object and the types of migrations you envision:

- If you have implemented only one "logical" business object used to define the data in the MO, then a single migration plan that references the this BO (or the maybe the MO's physical BO) is appropriate.
- If you have implemented more than one "logical" business object, would the data for multiple business objects get copied together? Then perhaps a single migration plan that references the MO's physical BO is appropriate.
- Are there additional foreign keys defined using mapXML in the business object(s) for the MO? If so, then it is recommended to include sub-instructions to define the links. At this point, if multiple "logical" BOs exist, your implementation may choose to define all the additional elements in the same migration plan or choose to define separate migration plans for each logical BO.
- Your implementation may decide to define more than one migration plan for the same type of record based on the types of migrations you plan to include. For example, you may decide to include a migration plan that copies only the records in this maintenance object. You may decide to define another migration plan that copies the records in this MO along with related records in another MO (for a special type of migration). Having said that, be sure to design the migration plan with reuse in mind to minimize maintenance efforts.

In order to support **Entity List** migration request, a default migration plan must be defined as an option on the maintenance object. This should be a single migration plan that supports all types of business objects for the MO.

If your implementation has a template migration request to use for targeted or wholesale migrations, include the new migration plan(s) as appropriate.

---

**CAUTION:** Important! New migration plans and migration requests should follow naming conventions. Refer to [System Data Naming Convention](#) for more information.

---

## The CMA Execution Process

The following diagram illustrates a high-level view of the Configuration Migration Assistant execution process. The subprocesses illustrated here are described in more detail in the following sections.

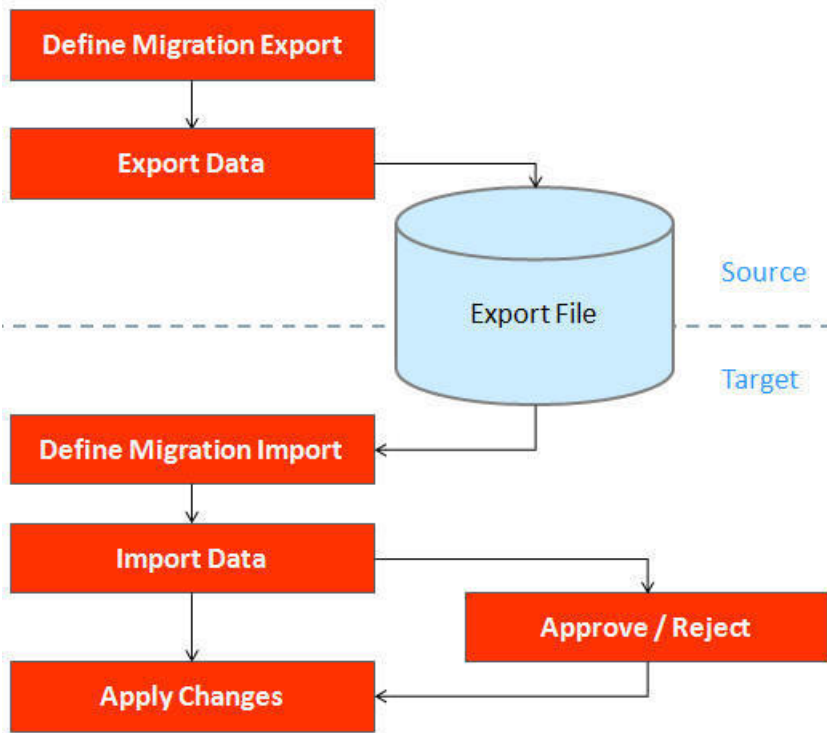

## Exporting a Migration

The migration export process begins in the source environment by defining a **Migration Data Set Export**, which specifies a defined **Migration Request** and provides a file name and description for the export file. After the data set is defined and saved, the **Migration Data Set Export Monitor** batch job can be submitted generate the export file.

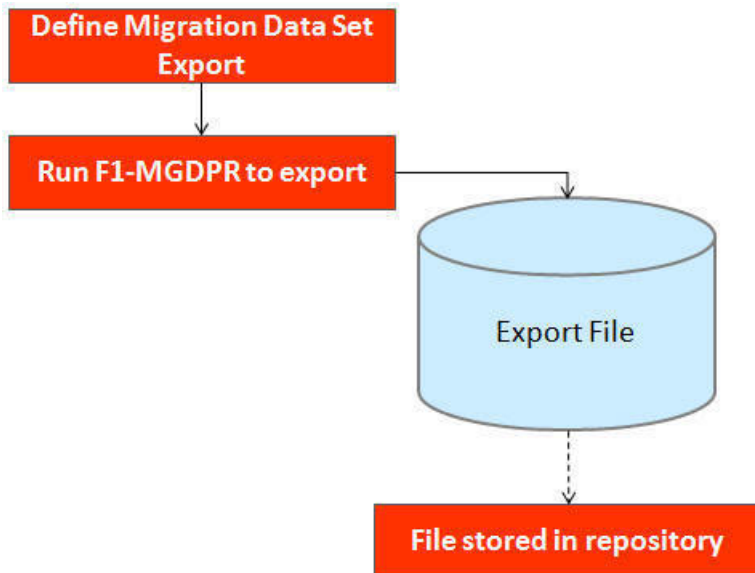

The following topics provide more detail about this process.



## Migration Data Set Export

To migrate data from one region to another, define a **Migration Data Set Export**. This establishes the export file name and identifies the migration request.

To view an existing migration data set export, navigate using **Admin > Implementation Tools > Migration Data Set Export**. Use the query criteria to locate the desired data set.

Note that you can also initiate the creation of an export data set from the [Migration Request](#) portal using the **Export** button.

The export requires the name of an existing **Migration Request**.

Enter a unique **File Name** for the export. Do not use spaces in the name, and do not enter the file extension or a path. The output location and file extension of the intended export file, which should appear in the **Export Directory** and **File Suffix** labels, are defined as described in the topic [Migration Assistant Configuration](#).

Enter an **Export Description** to provide information about the purpose of the export. Note that this field is not language enabled.

The **Source Environment Reference** is for information purposes. It should be populated with text that provides a meaningful description of the source environment. The default value is the URL of the source environment.

## Export Lifecycle

The following diagram describes the lifecycle of a Migration Data Set Export (data set).

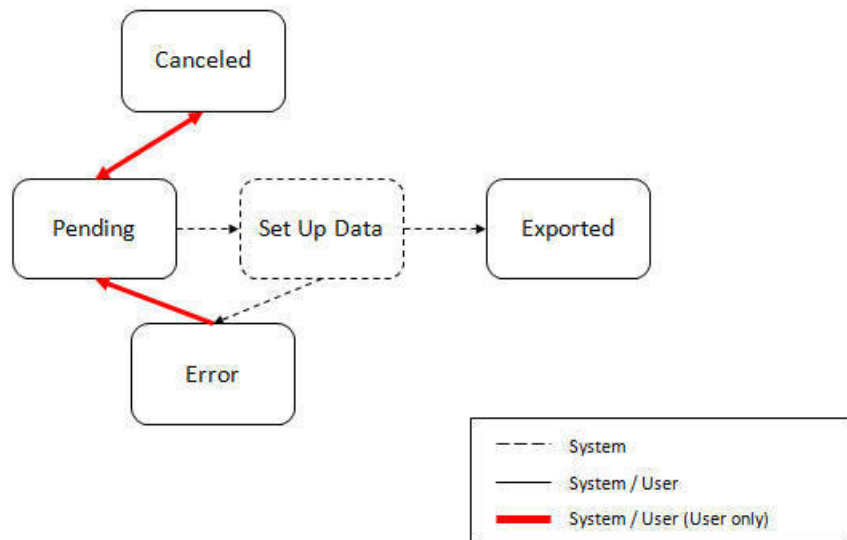

The following points describe the lifecycle.

- The data set is created in **Pending** status.
- A user may choose to temporarily **Cancel** a pending data set to prevent it from being processed. The user can later return it to the Pending state when desired.
- The record remains in Pending until its monitor batch job is submitted. The **Migration Data Set Export Monitor** (F1-MGDPR) selects pending records and transitions them to **Set up data**. Refer to [Running Batch Jobs](#) for more information.
- Set up data is a transitory state that includes the algorithm that does the work of determining the objects to include in the export and group related objects together into a transaction. If everything is successful, the export file is written to the appropriate file location and the record transitions to **Exported**. If an error is detected, the process stops and the record transitions to **Error**.



- If a record is in error and it is possible to correct the error, the record may be transitioned back to Pending to try again.

When the process is marked as **Exported**, the export file can be imported into the target system.

---

**NOTE:** The export process creates a file, providing the benefits of having a standalone file. It can be stored in a version control system for audit purposes or provided to others for import purposes.

---

**CAUTION:** Under no circumstances should exported data files be edited manually. Doing so could cause data corruption when the file content is applied to the target environment.

---

**NOTE:** The export functionality is supported using the business object **Migration Data Set Export** (F1-MigrDataSetExport). The expectation is that implementations will use the delivered base business object and its logic and will have no reason to implement a custom business object for the CMA export process.

---

## Importing and Applying a Migration

The import process is broken down into four general steps: Import, Compare, Approve, Apply. The following points provide an overview of the steps.

- **Import.** The first step covers importing the file and creating appropriate Migration Import records in the target environment to facilitate the subsequent steps.
- **Compare.** The compare step reviews each object that is in the import file and compares the object in the import against the equivalent record in the target environment. The comparison step results in noting which objects are unchanged, which are new (and the appropriate SQL to insert them) and which objects are changed (and the appropriate SQL to update them). Based on user configuration at import time, the objects that qualify for the import may be in a state that requires review or may be pre-approved.
- **Approve.** Once the comparison is complete, the user should review the results. There may be records marked for review. All of these records must be approved or rejected before the import can proceed. When the user is satisfied with the results of the comparison and has completed the review, the import is marked to proceed to the Apply step. Optionally, a migration import may be configured to automatically apply.
- **Apply.** This is the final step and is the step where the records in the target environment are added or updated. Because of potential high volumes of data and because of possible dependencies between records, this step supports two levels of attempting to apply the records. There is an apply step at the object level and an apply step at the transaction level. This will be described in more detail below.

## Import Step

The import process starts with verifying the import directory configured as described in the following topic [Master Configuration - Migration Assistant](#) and ensuring that the exported file is located in that directory. Then, in the target environment, a **Migration Data Set Import** record should be created. The user indicates the file name.

In addition, the user decides what the default status should be for resulting objects.

- The **Default Status for Add** sets the default status for objects that are determined to be *new* during the import comparison process. The default is to automatically set new objects to **Approved** status. Other options are to set any new objects to **Rejected** or **Needs Review** status.
- The **Default Status for Change** sets the default status for objects that are determined to be *changed* during the import comparison process. As with new objects, the default for changed objects is **Approved**, with **Rejected** or **Needs Review** options available.

The user may also configure the **Automatically Apply** flag to **Yes**. This allows for use cases where the migration is repetitive and has been tested and the user feels that there is no need for manual approval. Note that when configuring this setting, neither of the Default Status values may be set to **Needs Review** and at least one must be set to **Approved**.

The file to import contains a list of all the objects included in the export. Any objects that the export step determined to be related have been grouped into “transactions”. Once the Migration Data Set Import is created, the next step is for the system to read in the file and create Migration Transactions and Migration Objects.

The following is a portion of the Migration Data Set Import lifecycle as it pertains to the import step.

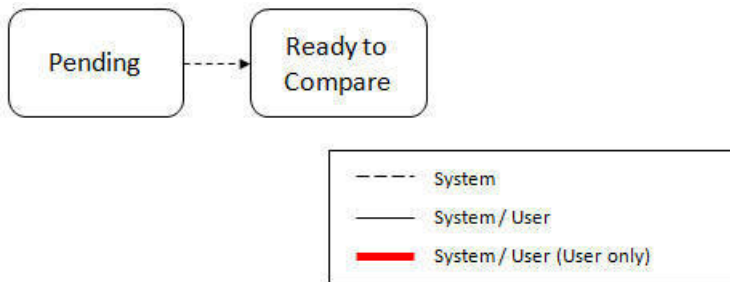

The following points describe the lifecycle.

- The data set is created in **Pending** status.
- The record remains in Pending until its monitor batch job is submitted. The **Migration Data Set Import Monitor** (F1-MGDIM) selects pending records and transitions them to **Ready to Compare**. Refer to [Import Process Summary](#) and [Running Batch Jobs](#) for more information.

The Ready to Compare state has an algorithm that is responsible for reading the related import file and creating the migration transactions and migration objects. The data set remains in this state until the comparison step is complete.

---

**NOTE:** A user may choose to **Cancel** a data set. Refer to [Cancelling a Data Set](#) for more information.

---

The following diagram highlights the relationships of the resulting migration import records.

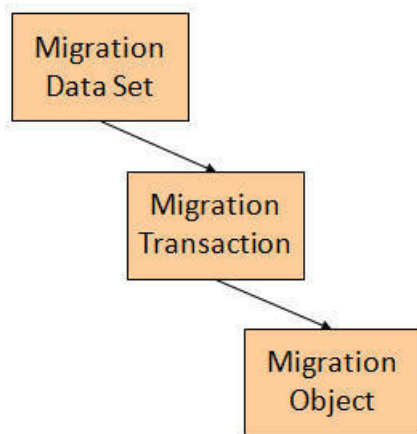

The migration transaction and migration object each have their own lifecycle that will help manage the subsequent compare and apply steps. At the end of the import step, the status values of the three types of records are as follows:

- Migration Data Set Import is in the **Ready to Compare** state.
- Migration Transaction is in the **Pending** state.
- Migration Object is in the **Pending** state.

---

**NOTE:** The import functionality is supported using business objects supplied by the base product. The expectation is that implementations will use the delivered base business objects and their logic and will have no reason to implement a custom business objects for the CMA import process. The base business objects are **Migration Data Set Import** (F1-MigrObjectImport), **Migration Transaction** (F1-MigrTransactionImport) and **Migration Object** (F1-MigrObjectImport).

---

## Compare Step

The import step results in the creation of one or more migration objects, one for each record selected in the export based on the export's migration request and its configuration. Related objects are grouped together in migration transactions. The next step in the import process is the Comparison step. In this step, the data captured by the import file for each object is compared to the view of that object in the target environment.

To cater for a possible large volume of objects, the comparison is done via a batch monitor. To aide in performance of the process, the monitor is performed on the migration objects so that it can be run multi-threaded. Once the objects are finished with the comparison, the migration transactions and the migration data set should be updated with an appropriate overall status before continuing to the next step. As a result, the comparison actually requires three steps: Migration Object Comparison, Migration Transaction Status Update and Migration Data Set Export Status Update. The steps are explained in detail in the following sections.

---

**NOTE:** Refer to [Running Batch Jobs](#) for more information about streamlining the various steps in the process.

---

## Migration Object Compare

This is the main step of the comparison. The **Migration Object Monitor** (F1-MGOPR) selects pending migration object records and transitions them to **Comparing**. This is a transitory state that includes the algorithm that does the work of comparing. There are various possible outcomes that could occur based on the logic in the algorithm. The following diagram illustrates a portion of the migration object lifecycle that pertains to comparison.

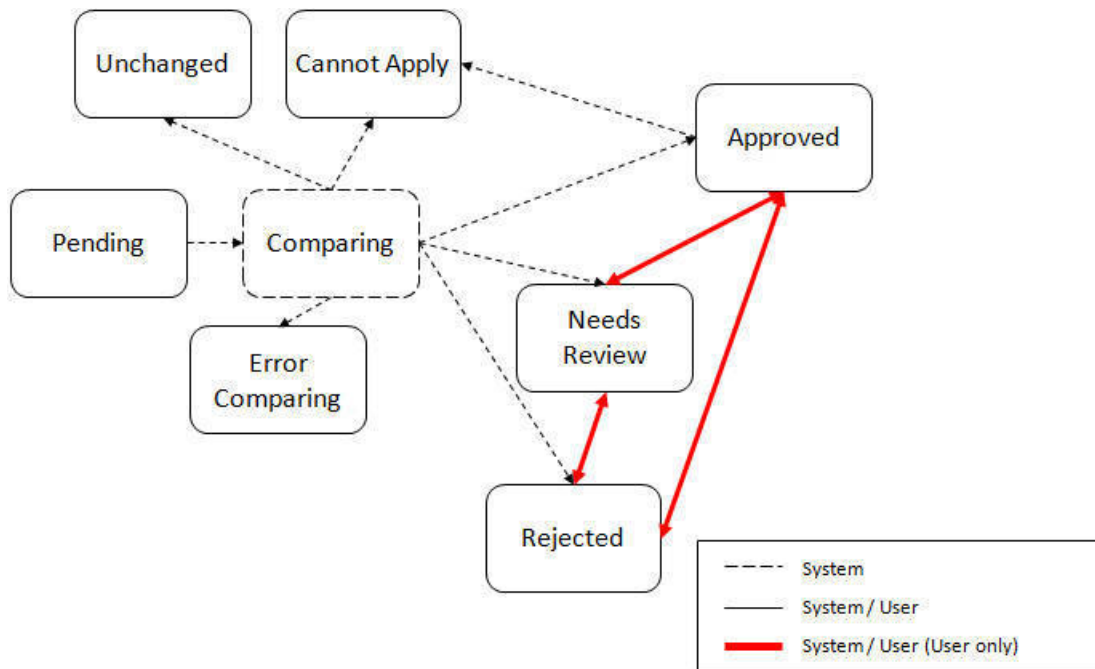

The following points describe the lifecycle.

- When **Pending** records are selected by the monitor batch job, it transitions to **Comparing**. If the migration object refers to one or more pre-compare algorithms, they are executed to [adjust the data prior to comparison](#). Then algorithm will determine the appropriate next state by comparing the source data to the target data.
- If the record in the migration object is found in the target environment and the data is exactly the same, the record transitions to **Unchanged** (with the object action value also set to **Unchanged**).
- If the record in the migration object is found in the target environment and the data is different, the algorithm sets the object action value to **Change** and generates the appropriate SQL to be used later in the Apply step to update the record.

It then transitions to **Approved**, **Needs Review** or **Rejected** based on the Default Status For Change setting captured on the Data Set.

- If the record in the migration object is not found in the target environment, the algorithm sets the object action value to **Add** and generates the appropriate SQL to be used later in the Apply step to insert the record. It then transitions to **Approved**, **Needs Review** or **Rejected** based on the Default Status For Add setting captured on the Data Set.
- If there is any issue with attempting to parse the object data from the import, the record transitions to **Error Comparing**.
- If there is any reason that the imported object is not valid for import, the record transitions to **Cannot Apply**. The log will be updated with the error that caused the record to transition to this state. An example is that perhaps the record was exported in a different version of the product and has additional elements that are not recognized in this version.

---

**NOTE:** Refer to [Cancelling a Data Set](#) for information about cancelling a data set and its impact on its related objects.

---

## Migration Transaction Status Update

After the import step, the migration transaction remains in the Pending state until all its objects have completed the comparison step. At that point, the status of the transactions should be updated based on the results of their objects. The **Migration Transaction Monitor** (F1-MGTPR) selects pending migration transaction records and runs its monitor algorithms. There are various possible outcomes that could occur based on the logic in the algorithms. The following diagram illustrates a portion of the migration transaction lifecycle that pertains to comparison.

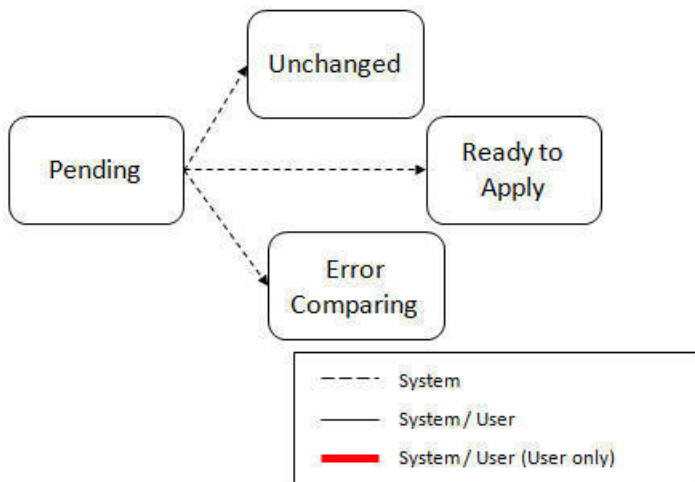

The following points describe the lifecycle possible next states after Pending.

- If any related migration object is in the Error Comparing state, the transaction transitions to **Error Comparing**.
- If all related migration objects are in the Unchanged state, the transaction transitions to **Unchanged**.
- Otherwise, the transaction transitions to **Ready to Apply**. This means that at least one object is in an “apply-able” state.

The transaction remains in the **Ready to Apply** state until a user has approved the data set to move to the Apply step and the transaction’s related objects have attempted to apply themselves. This is described in more detail below.

---

**NOTE:** Refer to [Cancelling a Data Set](#) for information about cancelling a data set and its impact on its related objects.

---

## Migration Data Set Import Status Update

Once all the objects and all transactions have been updated via the previous two steps, the migration data set export must be updated based on the results of their transactions. The **Migration Data Set Import Monitor** (F1-MGDIM) selects Ready to Compare data sets and runs its monitor algorithms. Note that this is the same monitor process that is used to select Pending data sets. There are various possible outcomes that could occur based on the logic in the algorithms. The following diagram illustrates the portion of the migration transaction lifecycle that pertains to comparison.

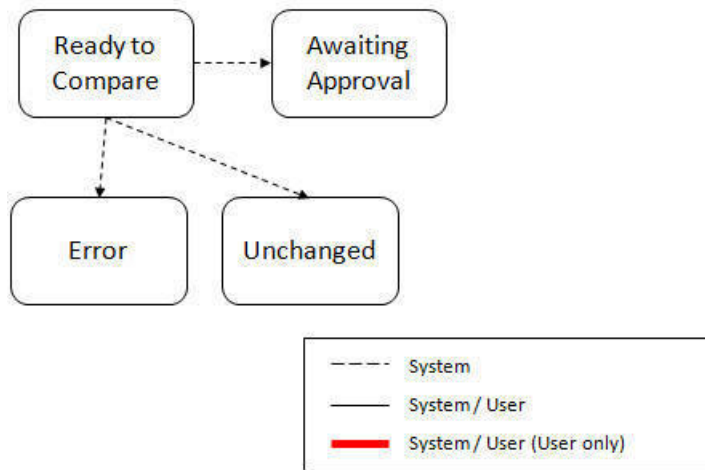

The following points describe the lifecycle possible next states after Ready to Compare.

- If any related migration transactions is in the Error Comparing state, the data set transitions to **Error**.
- If all related migration transactions are in the Unchanged state, the data set transitions to **Unchanged**.
- Otherwise, the transaction transitions to **Awaiting Approval**. This means that there are no errors and at least one object is in an “apply-able” state.

The data set remains in the **Awaiting Approval** state until a user decides that the data set and all its records are ready to progress to the Apply step.

---

**NOTE:** A user can choose to cancel a data set at any time while it is in progress. Refer to [Cancelling a Data Set](#) for more information.

---

## Approval Step

Once the comparison is complete and the data set transitions to the Awaiting Approval state, a user needs to progress the data set to **Apply Objects** to trigger the Apply step. The following points describe steps a user may take during the approval step.

- If the data set configuration for the Default State for Add and Change was set to **Approved**, then any migration object that is determined to be eligible for the Apply step will be in the Approved state. In this situation, a user may want to review the data set and its transactions and objects to see verify that the results make sense. At that time, the user is able to move an object to Needs Review or Rejected as appropriate.
- If the data set configuration for the Default State for Add and Change was set to **Needs Review** for either option, then each migration object in the Needs Review state must be reviewed and the user must either Reject or Approve each object before moving to the Apply step.
- If the data set configuration for the Default State for Add and Change was set to **Rejected** for either option, the assumption is that the rejected records don’t need to be reviewed. But if a user finds a rejected record that shouldn’t be rejected, it may be transitioned to Approved (or Needs Review) as appropriate.

Once the user is comfortable with the data set’s results and no more objects are in the Needs Review state, the user should transition the record to **Apply Objects**. This will initiate the Apply step.

Alternatively, if the Automatically Apply flag was set to **Yes** when creating the import record, the import data set will progress from **Awaiting Approval** to **Apply Objects**. Refer to [Import Process Summary](#) for more information.

---

**NOTE:** Refer to [Maintaining Import Data](#) for details about the pages provided to help the user review a data set and its transactions and objects to help in the approval step.

---

---

**NOTE:** A user can choose to cancel a data set at any time while it is in progress.

---

## Apply Step

The apply step is the step where records in the target environment are added or updated. Like the comparison step, the apply step is actually multiple steps to optimally handle high volume and dependencies between records as smoothly as possible.

---

**NOTE:** Refer to [Running Batch Jobs](#) for more information about streamlining the various steps in the process.

---

Before explaining the apply steps in detail, the following points highlight the type of data that may be included in a given data set.

1. Records that have no foreign keys and therefore no dependencies on other records. Examples: Message, Display Profile.
2. Records that have foreign keys that may already be in the target. Examples: Algorithms for existing algorithm types, To Do Roles for existing To Do Types.
3. Records that have foreign keys that are new records but also part of the migration. CMA detected the relationship at export time and grouped the objects in the same transaction. Example: Script-based Algorithm Type where the script is also in the migration.
4. Records that have foreign keys that are new records but also part of the migration. CMA did not detect the relationship. This may occur if the reference the foreign key is in a XML or parameter column and the migration plan did not include an instruction to explicitly define the relationship. Example, a Zone that references a visibility script.
5. Records that have circular references where both records are new and are part of the migration. CMA detected the relationship at export time and grouped the objects in the same transaction. Example: plug-in Script for a BO plug-in spot. The script references the BO and the BO references an algorithm for the script's algorithm type.

To handle high volume data, the first step in the apply process is to perform the apply logic at the migration object level via a multi-threaded batch job. This should result in all records in categories 1 and 2 above being applied successfully.

For records in categories 3 and 4 above, if a record with a foreign key is added or updated before its related record, the validation will fail. However, if the related record is added first and then the record referring to it is added, validation will pass. Because the migration objects are not ordered, the multi-threaded batch process may not process records in the desired order. To overcome this potential issue, the Apply step has special functionality, described in detail below.

For records in category 5 above, the circular reference will mean that the apply process at the object level will not successfully add or update these records. The apply process at the transaction level will cover these records. This is described in detail below.

## Apply Objects

Once the Data Set is in the state of **Apply Objects**, the **Migration Object Monitor - Apply** process (F1-MGOAP) runs to attempt to apply the objects. The background process in conjunction with the Apply algorithm have special functionality to ensure records in categories 3 and 4 (above) successfully apply during this step:

- The **Migration Object Monitor - Apply** process is a special one that continually re-selects records in the **Approved** state until there are no more eligible records to process.
- When an error is received in the Apply Object algorithm, the algorithm increments an "iteration count" on the migration object record. If the iteration count does not exceed a maximum count (noted in the algorithm), the object remains in the **Approved** state and is eligible to be picked up for processing again. If the iteration count exceeds the maximum defined in the algorithm, the record transitions to the **Error Applying** state.

---

**NOTE:** When submitting this Apply batch job, be sure to set the number of threads to a number that does not exceed the number of threads supported by the thread pool worker. Doing this will cause the 'excess' threads to wait for the supported number of threads to finish.

---

The following diagram is the portion of the migration object lifecycle that pertains to the Apply step.

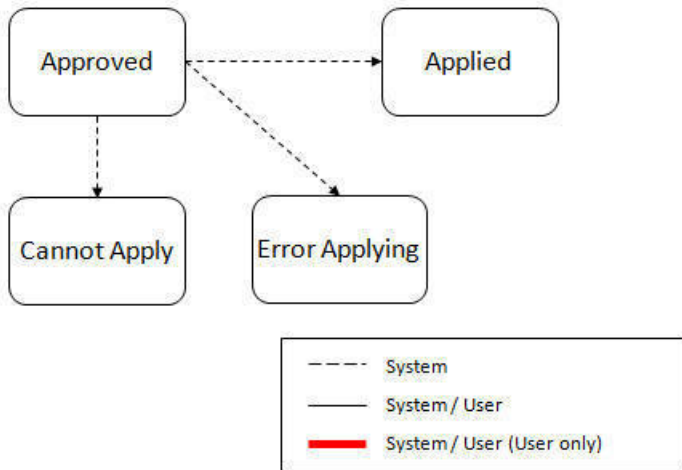

At the completion of the Apply monitor process, typically the objects will be in the **Applied** state or the **Error Applying** state. The records in the Error Applying state are in that state for one of two reasons.

- They are in category 5 described above where the records have a circular reference with another record. For this scenario, the Apply Transactions step described below should successfully apply the records.
- There is some other error that is unrelated to the records in the current migration. In this case, manual intervention may be required. Refer to the [Resolving Errors](#) section below for more information.

As shown in the diagram, the Apply Objects algorithm may also detect a reason that the object cannot be applied. This may occur if the object in the target environment has been updated since the comparison step, making the SQL captured at that point no longer applicable. If this occurs, after the current migration is fully applied, the original file may be imported again, and new comparisons can be generated and applied.

## Apply Transactions

Ideally, after the Apply Objects step, all the objects are **Applied** or are in **Error Applying** due to the "circular reference" situation. The typical next step is to turn over responsibility to the transactions. The migration transactions can then attempt to apply their objects in bulk.

In order to ensure that multiple background processes are not trying to select migration objects to run the Apply step, the Transactions are only eligible to attempt to "apply my objects" if the Data Set is in the **Apply Transactions** state.

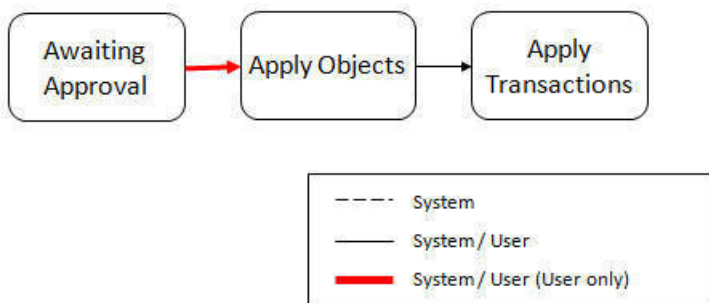

A monitor algorithm (executed by the data set monitor batch process) on the Apply Objects state checks to see if all migration objects are no longer **Approved** or the count of records in **Error Applying** does not exceed a configured limit. If so, it automatically transitions the record to the **Apply Transactions** state.



If the number of objects in **Error Applying** exceeds a configured limit, the monitor algorithm does not automatically transition the record. In that case, a user must determine if the large number of errors can be resolved or manually transition to **Apply Transactions** (despite the large number of errors). The [Resolving Errors](#) section below describes alternative steps that the user may take if there are errors.

Once the Data Set is in the state of **Apply Transactions**, the **Migration Transaction Monitor - Apply** process (F1-MGTAP) runs. It attempts to apply the transaction's objects. If no migration objects are in error, the migration transaction simply transitions to **Applied**. If any of the migration objects are in **Error Applying**, the background process and the Apply algorithm have special functionality to try to overcome dependencies in migrated objects:

- The Apply algorithm selects all migration objects in error and performs all their SQL, then validates all the records. If there are objects in the transaction with circular references, they should pass validation at this point.
- Because there may still be some dependencies across transactions, similar error handling described in the Apply Objects step occurs here. When an error is received in the Apply Transaction's Object algorithm for any of the objects in the transaction, the algorithm increments an "iteration count" on the migration transaction record. If the iteration count does not exceed a maximum count (noted in the algorithm), the transaction remains in the **Ready to Apply** state and is eligible to be picked up for processing again. If the iteration count exceeds the maximum, the record transitions to the **Error Applying** state. Note that if any objects in the transaction are in error, none of the objects are applied. They all remain in error.
- The **Migration Transaction Monitor - Apply** process is a special one that continually re-selects records in the **Ready to Apply** state until there are no more eligible records to process.

---

**NOTE:** When submitting this Apply batch job, be sure to set the number of threads to a number that does not exceed the number of threads supported by the thread pool worker. Doing this will cause the 'excess' threads to wait for the supported number of threads to finish, erasing the benefit of the iteration processing.

---

The following diagram is the portion of the migration transaction lifecycle that pertains to the Apply step illustrating the points above.

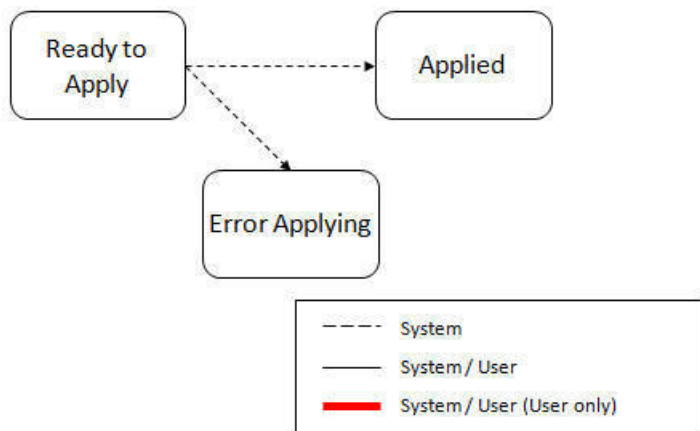

If at the end of the transaction level Apply process there are transactions in error (and therefore there are still objects in error), a user must review the errors and determine how to fix them. Refer to the [Resolving Errors](#) section below for more information.

## Resolving Errors

As mentioned in the previous sections, errors may be received after the Apply Objects process runs. If the number of records in error is below a certain limit (and the data set monitor batch job is submitted to execute the monitor algorithms) the system will automatically transition the data set to the **Apply Transactions**. If the monitor batch job is not run or if the number of objects in error exceeds a certain limit, a user must make the decision after viewing the errors in the Objects in Error zone on the [Migration Data Set Import](#) portal.



- If the errors appear to be dependency related, the user can decide to let the "transactions apply their objects" and transition the data set to **Apply Transactions**, described above.
- If the errors appear to be related to an outside issue that can be manually resolved, the user may choose to fix the issue and redo the Apply Objects step.
- The user may also decide to reject one or more objects to remove them from the migration.

After the Apply Transactions step, if there are still errors, a user must review the records and determine how to proceed. Errors are visible in the **Transactions in Error** zone on the [Migration Data Set Import](#) portal.

- The user may decide to reject one or more objects to remove them from the migration.
- The user may manually resolve an issue external to the migration and then decide to do one of the following:
  - Redo the **Apply Objects** step. This is recommended if there are a large number of Objects still in error and not a large number of dependencies expected. The benefits of running the Apply Objects multi-threaded will ensure that the process runs efficiently.
  - Redo the **Apply Transactions** step.

Because the objects and transactions are in Error Applying, in order to "retry" the Apply step after manually fixing an error, the system needs to move the records back to the state that allows them to be picked up by the appropriate Apply process. For migration objects, records need to be moved back to **Approved**. For migration transactions, records need to be moved back to **Ready to Apply**. The following points describe the Retry logic for migration objects.

- If a user decides to **Retry Objects** (using an action button on the Migration Data Set Import page), the data set transitions to the **Retry Objects** state. At this point the Migration Object monitor must be run.
- The monitor on the **Error Applying** state for the objects detects that the data set is in the state of **Retry Objects** and that triggers the transition back to **Approved**.
- The next step is to transition the data set from **Retry Objects** to **Apply Objects**. This may be done manually or by running the Migration Data Set Import monitor process.
- Now the objects are eligible to be picked up by the object level Apply process.

Analogous logic exists for the migration transactions.

- If a user decides to **Retry Transactions** (using an action button on the Migration Data Set Import page), the data set transitions to the **Retry Transactions** state. At this point the Migration Transaction monitor must be run.
- The monitor on the **Error Applying** state for the transactions detects that the data set is in the state of **Retry Transactions** and that triggers the transition back to **Ready to Apply**.
- The next step is to transition the data set from **Retry Transactions** to **Apply Transactions**. This may be done manually or by running the Migration Data Set Import monitor process.
- Now the transactions are eligible to be picked up by the transaction level Apply process.

The retry logic may also occur when transitioning between the Apply Objects and Apply Transactions depending on whether or not there are errors. The following scenario highlights this point.

- After the **Apply Objects** step there are objects in **Error Applying**. The data set transitions to **Apply Transactions** and the Apply step is done at the transaction level.
- After the **Apply Transactions** step there are transactions in **Error Applying**.
- User chooses to try to apply objects again (by clicking **Retry Objects**). The steps outlined above for retrying objects are followed at this point.
- After the apply objects, user may choose to retry objects again (after fixing errors if applicable).
- At some point the user will transition to **Apply Transactions** again. If there are transactions in **Error Applying**, the system will automatically transition the data set to **Retry Transactions** and the steps outlined above for retry transactions are followed.

## Finalize Apply Step

Once all the migration objects for a migration transaction are in a final state (**Applied**, **Rejected** or **Cannot Apply**), the migration transaction transitions to the **Applied** state. Once all the migration transactions are in the **Applied** state, the Migration Data Set record transitions to the **Completed** and the import is complete.

---

**NOTE:** To review the full lifecycle for each record, refer to the Business Object - Summary tab in the application metadata for the base business objects **Migration Data Set Import** (F1-MigrObjectImport), **Migration Transaction** (F1-MigrTransactionImport) and **Migration Object** (F1-MigrObjectImport).

---

## Adjusting Data Prior to Comparing

Some records may have data that is specific to the environment it is in and won't apply in the target environment. In such cases, an algorithm plugged into the [migration plan](#) primary instruction may be used to adjust the data when importing. This algorithm is executed by the comparison algorithm before any comparison is performed. Algorithms of this system event receive the view of the source record (being imported) and the view of the existing record in the target region, if it exists. The data is provided using the physical BO of the migration plan's maintenance object. The algorithm may make changes and pass a new view of the record that should be used for the comparison. This system event supports multiple algorithms that are executed in sequence. Each algorithm receives the original record's data, the target record's data (if applicable) and the 'new' view of the data (as populated by previous algorithms, if any). The final 'new' view of the data is used for the object comparison.

---

**FASTPATH:** Refer to [Base Business Objects](#) for more information about physical BOs.

---

Some examples of records that may require import algorithms.

- Batch Control references its next batch sequence number along with snapshot information like the last run date / time. This information is only relevant with respect to its environment. The instruction for a batch control can include an algorithm to not overwrite the batch sequence number when copying a batch control.
- Some products include administrative objects that reference a master data object. Master data objects are not copied as part of CMA. An import algorithm may be used to adjust the referenced master data foreign key when importing, for example to reset it (or not overwrite when updating). If the algorithm knows how to find the appropriate master data record to link, that may also be included.

Note that it is possible to use the algorithm to "reset" the source data as a way of indicating that the record should not be imported. For these situations, the migration object comparison step will transition the record to **Unchanged** and will use an object action value of **Canceled**. (Note that object action is a simple lookup value. The record is not transitioned to the **Canceled** BO state as to reserve that status for user initiated cancellations of the object or one of its parent records). This technique not expected to be used often because ideally using appropriate selection criteria at export time should ensure that the only records exported are those that should be imported.

---

**NOTE: Legacy 'Import' system event.** The system originally provided an Import system event / plug-in spot. The purpose of algorithms for this plug-in spot were similar in that they were meant to adjust imported data prior to adding or updating. The algorithms were executed in the Apply step. The logic does not allow for easily interacting with the record using a BO. This makes it difficult to use a plug-in script as the plug-in type. In addition, it is difficult to update elements in an XML column. The support for the plug-in spot will be removed in a future release. Algorithms to adjust the data should be using the pre-compare system event.

---

## Import Process Summary

The following table summarizes the steps required to complete the import process from start to finish. Note that this section **only a summary** and assumes that you are familiar with the details described in the previous sections. It highlights what steps are manual and what steps are performed by a batch monitor process. For each step, the table highlights the

Next Action sequence that would occur. For the Apply steps, there are two parts where multiple next actions are possible based on whether there are errors and the user’s decision on how to resolve the error. Refer to [Resolving Errors](#) for more information. The possible next actions have the same sequence with a letter following the sequence highlighting the action to take based on the results of the previous step.

**NOTE:** When running the Apply batch jobs, be sure to set the number of threads to a number that does not exceed the number of threads supported by the thread pool worker.

Also note that a sequence and action marked in bold is considered the “normal path”.

Step	Seq	Action	Manual / Batch	Portal - Action	Batch Control	Record Impacted - Resulting Status	Next Action Sequence
Import	<b>10</b>	<b>Create Import record</b>	Manual	Migration Data Set Import - Add		Migration Data Set Import - Pending	11
	<b>11</b>	<b>Import file</b>	Batch		F1-MGDIM - Migration Data Set Import Monitor	Migration Data Set Import - Ready to Compare Migration Transaction - Pending Migration Object - Pending	20
Compare	<b>20</b>	<b>Migration Object Compare</b>	Batch		F1-MGOPR - Migration Object Monitor	Migration Object - Approved, Needs Review, Rejected, Unchanged or Error Comparing	21
	<b>21</b>	<b>Migration Transaction status update</b>	Batch		F1-MGTPR - Migration Transaction Monitor	Migration Transaction - Ready to Apply, Unchanged or Error Comparing	22
	<b>22</b>	<b>Migration Data Set Import status update</b>	Batch		F1-MGDIM - Migration Data Set Import Monitor	Migration Data Set Import - Awaiting Approval, Apply Objects (if configured for Automatic Apply), Unchanged or Error	30
Approval	<b>30</b>	<b>Review comparison results, approve / reject as needed</b>  (This step is skipped if the data set is configured for Automatic Apply)	Manual	Migration Data Set Import, drill in to the Transactions / Objects as necessary.		Migration Object - Approved or Rejected (no records should be in Needs Review) Migration Data Set Import - Apply Objects	40

Step	Seq	Action	Manual / Batch	Portal - Action	Batch Control	Record Impacted - Resulting Status	Next Action Sequence
Apply	40	<b>Apply Objects</b>	Batch		F1-MGOAP - Migration Object Monitor - Apply	Migration Object - Applied or Error Applying	41 Appropriate next action is based on error review, if applicable.
	41a	Migration Data Set Import status update - auto transition to Apply Transactions.  Only applicable if the number of migration objects in Error Applying is below a threshold	Batch		F1-MGDIM - Migration Data Set Import Monitor	Migration Data Set Import - Apply Transactions	42
	41b	<b>Migration Data Set Import status update - manual transition to Apply Transactions.</b>  Occurs if user reviews errors and determines that they may be resolved in the Apply Transaction step.	Manual	Migration Data Set Import - click Apply Transactions			
		System detects that all the transactions are in the Ready to Apply state and proceeds to the Apply Transactions state.				Migration Data Set Import - Apply Transactions	42
		System detects that there are transactions in the Error Applying state and transitions instead to the Retry Transactions state.				Migration Data Set Import - Retry Transactions	45
	41c	Migration Data Set Import status update - manual transition to Retry Objects.  Occurs if user reviews errors and decides to fix an external	Manual	Migration Data Set Import - click Retry Objects		Migration Data Set Import - Retry Objects	44

Step	Seq	Action	Manual / Batch	Portal - Action	Batch Control	Record Impacted - Resulting Status	Next Action Sequence
		error and wants to try the batch level Apply again at the object level.					
	42	<b>Apply Transactions</b>	Batch		F1-MGTAP - Migration Transaction Monitor - Apply	Migration Transaction - Applied or Error Applying Migration Object - Applied or Error Applying	43 Appropriate next action is based on error review, if applicable.
	43a	<b>Migration Data Set Import status update - auto transition to Completed</b> Applicable if all transactions are Applied	Batch		F1-MGDIM - Migration Data Set Import Monitor	Migration Data Set Import - Completed.	N/A
	43b	Migration Data Set Import status update - manual transition to Retry Objects. Occurs if user reviews errors and decides to fix an external error and wants to try the batch level Apply again at the Object level.	Manual	Migration Data Set Import - click Retry Objects		Migration Data Set Import - Retry Objects	44
	43c	Migration Data Set Import status update - manual transition to Retry Transactions. Occurs if user reviews errors and decides to fix an external error and wants to try the batch level Apply again at the Transaction level.	Manual	Migration Data Set Import - click Retry Transactions		Migration Data Set Import - Retry Transactions	45
	44	Migration Objects status update from Error Applying back to Approved. Occurs if user chose to Retry Objects.	Batch		F1-MGOPR - Migration Object Monitor	Migration Object - Approved	

Step	Seq	Action	Manual / Batch	Portal - Action	Batch Control	Record Impacted - Resulting Status	Next Action Sequence
		Migration Data Set Import status update from Retry Objects to Apply Objects	Batch		F1-MGDIM - Migration Data Set Import Monitor	Migration Data Set Import - Apply Objects	40
	45	Migration Transactions status update from Error Applying back to Ready to Apply.  Occurs if user chose to Retry Transactions or if the user transitions to Apply Transactions and the system detects that there are Transactions in the Error Applying state.	Batch		F1-MGTPR - Migration Transaction Monitor	Migration Transaction - Ready to Apply	42
		Migration Data Set Import status update from Retry Objects to Apply Objects	Batch		F1-MGDIM - Migration Data Set Import Monitor	Migration Data Set Import - Apply Transactions	42

The following table summarizes the batch monitor jobs that are used in the import process. You can see that there are special monitor processes for the Apply step for both the Object and Transaction. However, for all other states that have monitor logic, the standard monitor process for that MO is used.

Batch Control	Description	Comments
F1-MGDIM	Migration Data Set Import Monitor	Processes data set records in the following states: <ul style="list-style-type: none"> <li>• Pending</li> <li>• Ready to Compare</li> <li>• Apply Objects</li> <li>• Retry Objects</li> <li>• Apply Transactions</li> <li>• Retry Transactions</li> </ul>
F1-MGTPR	Migration Transaction Monitor (Deferred)	Processes transaction records in the following states: <ul style="list-style-type: none"> <li>• Pending</li> <li>• Error Applying</li> </ul>
F1-MGTAP	Migration Transaction Monitor - Apply	Processes transaction records in the Ready to Apply state where the data set is in the Apply Transactions or Canceled state. <p><b>NOTE:</b> Be sure to set the number of threads to a number that does not exceed the</p>

Batch Control	Description	Comments
		number of threads supported by the thread pool worker.
F1-MGOPR	Migration Object Monitor	Processes object records in the following states: <ul style="list-style-type: none"> <li>• Pending</li> <li>• Needs Review (check for Data Set cancellation)</li> <li>• Rejected (check for Data Set cancellation)</li> <li>• Error Applying</li> </ul>
F1-MGOAP	Migration Object Monitor - Apply	Processes object records in the Approved state where the data set is in the Apply Objects or Canceled state. <p><b>NOTE:</b> Be sure to set the number of threads to a number that does not exceed the number of threads supported by the thread pool worker.</p>

Refer to [Running Batch Jobs](#) for more information about managing the batch jobs, including ways to automate the above steps.

## Canceling a Data Set

A user may choose to **Cancel** a data set to prevent it from being processed at any point during the process.

If related migration transactions or migration objects have already been created, they will not be canceled as part of the data set getting canceled (due to possible high volumes of related records). They will be canceled the next time an appropriate monitor batch process runs. The child records checks to see if the data set has been canceled prior to any state transition.

## Additional Note Regarding Imports

The following points describe miscellaneous comments related to Migration Import.

- CMA relies on the fact that database referential integrity constraints are not in place, and that the SQL statements can be run in any order within the transaction. Any archiving solution that requires referential integrity constraints (such as Information Lifecycle Management) would not be possible on this data. Given that CMA migrations comprise administrative data and not transactional data, this should be a reasonable exception.
- The validation that is performed is only via the **Page Validate** service. BO validation algorithms are not executed. Page validation does not include validation of the business object against the schema (for example, for required fields, field sizes, etc.).
- If multiple migration requests are exported at the same time, on the import side, you should consider importing, reviewing, and applying an entire file/data set before moving on to the next one. The reason is that if objects are included in more than one file, two sets of "inserts" will be generated, but only the first will succeed. The second will cause the object to transition to "Cannot Apply". If instead you wait until the first file is completed before importing the second, the second data set will not generate any SQL for the object, since it has already been inserted. It's a matter of efficiency: If you first import all files and then try to apply all, you'll have to identify the duplicated object as an error and then mark the object as rejected before applying the transaction. This may also be avoided by using a Group migration request to include all objects in one file rather than multiple files.
- The system provides an algorithm to purge "unchanged" migration objects for a given migration data set. This may be plugged in as a BO exit algorithm on the **Ready to Compare** state for the Migration Data Set Import business object (**F1-MigrDataSetImport**).

## Caching Considerations

Because CMA updates administrative data that is usually read from a cache, after a successful migration, the target region now has new administrative data which needs to be part of various caches. It is recommended to flush the server cache (which will trigger a 'global' flush of the cache). If the thread pool workers in the target region are configured to refresh their caches when a global flush is requested, then this is the only step required. If not, then the **F1-FLUSH** batch job should also be submitted to refresh the caches used in batch processing.

---

**FASTPATH:** Refer to [Caching Overview](#) for more information.

---

## Maintaining Import Data

This section describes the portals provided to add, view and maintain migration import data.

### Migration Data Set Import

Use the Migration Data Set Import portal to view and maintain migration data set import records. Refer to [Importing and Applying a Migration](#) for an overview of the import process.

Navigate using **Admin > Implementation Tools > Migration Data Set Import**. You are brought to a query portal with options for searching for import data sets. In addition, the query provides an option to specifically search for data sets that have either objects in error or transactions in error.

Once a data set has been selected, you are brought to the maintenance portal to view and maintain the selected record. The following zones are visible on the main tab:

- **Migration Data Set Import.** This zone contains display-only information about the selected record. Please see the zone's help text for information about this zone's fields.
- **Migration Data Set Transactions.** This zone is visible once the [Import Step](#) has occurred and lists all the transactions that are related to the data set. To see more information about a specific migration transaction, click the hypertext for its ID. This brings you to the [Migration Transaction](#) portal.
- **Migration Data Set Impacted Object Summary.** This zone is visible once the [Import Step](#) has occurred and lists the objects that are related to the data set. To see more information about a specific migration object, click the hypertext for its ID. This brings you to the [Migration Object](#) portal. A user may choose to update the status of one or more records by checking the records and clicking **Approve**, **Reject** or **Needs Review** accordingly.
- **Migration Data Set Objects in Error.** This zone is only visible if there are objects for this data set in a non-final status that have errors. It indicates the error for each object. A user may use this zone to review errors after the monitor batch job to apply objects completes. Using the error information shown, the user can choose to drill into the record to transition it to **Error Applying** or choose to manually fix the cause of the errors and click **Retry Objects**. The user may also choose to select one or more records to **Reject**.

---

**NOTE:** Refer to [Apply Step](#) for more information about resolving errors.

---

- **Migration Data Set Transactions in Error.** This zone is only visible if there are transactions for this data set in a non-final state that have errors. It indicates the error for each transaction. A user may use this zone to review errors after the monitor batch job to apply transactions completes. The errors received when attempting to apply objects at the transaction level may differ from those received when attempting to apply objects at the object level. A transaction log is created for each object error received and these exceptions are shown in this zone.

---

**NOTE:** Refer to [Apply Step](#) for more information about resolving errors.

---



## Migration Transaction Portal

This page appears after drilling into a specific migration transaction from the migration data set portal or from the migration object portal.

Refer to [Importing and Applying a Migration](#) for an overview of the import process.

The following zones are visible on the main tab:

- **Migration Transaction.** This zone contains display-only information about the selected record. Please see the zone's help text for information about this zone's fields.
- **Migration Transaction Objects.** This zone lists the objects that are related to the data set. To see more information about a specific migration object, click the hypertext for its ID. This brings you to the [Migration Object](#) portal. A user may choose to update the status of one or more records by checking the records and clicking **Approve**, **Reject** or **Needs Review** accordingly.

## Migration Object Portal

This page appears after drilling into a specific migration object from the migration data set portal or from the migration transaction portal.

Refer to [Importing and Applying a Migration](#) for an overview of the import process.

The **Migration Object** zone contains display-only information about the selected record. Please see the zone's help text for information about this zone's fields.

The **Migration Object - List of SQL Statements** zone lists the SQL statements that have been generated as a result of the comparison step.

The **Migration Object - Algorithms** zone displays any pre-compare algorithms that are associated with the migration plan for this migration object.

## Running Batch Jobs

There are several batch jobs that are part of the CMA process, especially the import step (which are highlighted in [Import Process Summary](#)). And in some cases, a single batch jobs may process multiple states in the same business object lifecycle. Implementations must decide the best way to manage the batch job submission depending on how they plan to work.

- **Batch scheduler.** If an implementation wishes to put these batch jobs in the batch scheduler, a given job may need to be included several times to manage progressing the records to completion.
- **Timed Batches.** The batch controls can be configured as timed batches so that they run every N minutes based on the setting. This allows for the batch jobs to run periodically and process whatever is ready. A user doesn't have to manually submit a batch request. Navigate to the [Batch Control](#) page and select the appropriate batch controls. For each one, change the Batch Control Type to **Timed**. Fill in the additional information that appears for timed batches.
- **Event Driven.** The system provides BO enter plug-in algorithms and batch control post processing plug-in algorithms that automatically submit the appropriate next batch job for that step in the process. This allows for as much automation as possible for the steps that don't require user input. Note that configuration is required because the BOs / batch controls are not configured for this scenario by default. The following table highlights the BO and status where an algorithm may be plugged in and the name of the algorithm to use.

Business Object	Status	Algorithm
Migration Data Set Export	Pending	F1-MGDPR-SJ (Submit Migration Data Set Export Monitor).
Migration Data Set Import	Pending	F1-MGDIM-SJ (Submit Migration Data Set Import Monitor).

Business Object	Status	Algorithm
	Ready To Compare, Retry Objects	F1-MGOPR-SJ (Submit Migration Object Monitor).
	Apply Objects	F1-MGOAP-SJ (Submit Migration Object Apply Monitor).
	Apply Transactions	F1-MGTAP-SJ (Submit Migration Transaction Apply Monitor).
	Retry Transactions	F1-MGTPR-SJ (Submit Migration Transaction Monitor).

The following table highlights the batch controls where an algorithm may be plugged in and the name of the algorithm to use.

Batch Control	Algorithm
F1-MGTPR (Migration Transaction Monitor)	F1-MGDIM-NJ (Submit Migration Data Set Import Monitor).
F1-MGTAP (Migration Transaction Monitor - Apply)	F1-MGDIM-NJ (Submit Migration Data Set Import Monitor).
F1-MGOAP (Migration Object Monitor - Apply)	F1-MGDIM-NJ (Submit Migration Data Set Import Monitor).
F1-MGOPR (Migration Object Monitor)	F1-MGTPR-NJ (Submit Migration Transaction Monitor).

- **Manual submission.** The user managing the CMA import process submits the appropriate batch jobs on demand when a particular step is ready. Navigate to [Batch Job Submission](#), select the appropriate batch control and fill in the parameters as needed.

Note that after successfully applying the migrated data, the L2 cache of all thread pools must be refreshed. For more information, see [Caching Considerations](#).

---

**CAUTION:** Be sure that the Thread Count set when submitting the batch job does not exceed the number supported by the thread pool. Otherwise the extra threads will wait until the supported number of threads are finished, possibly resulting in a large number of errors in the Apply steps.

---

Refer to the parameter descriptions in the batch control metadata for more information about filling in the parameters.

For additional details on submission controls, refer to the topic [Batch Job Submission - Main](#) in the Batch Jobs section.

## CMA Reference

This section provides additional reference information.

## Framework-Provided Migration Configuration

This topic describes special information relating to migration objects provided for use by CMA in the product. Additional objects may be provided by your specific product. Any special information for objects is provided separately in each product's documentation.

The following points highlight some information about Framework-provided migration requests. Navigate to the migration request page in the application to view the details of all provided objects.

- Several base migration requests are supplied to logically group system and administrative tables. For example, there is a migration request for Framework System Configuration **F1-SystemConfig** where most system configuration objects are included. There is another one provided for CMA related configuration objects.
- There are several different security related migration requests that include different combinations of migration plans to support multiple possible business requirements related to security migration.
- The system supplies a group migration request **F1-FrameworkConfig** (Framework Configuration), which includes several other migration requests. The expectation is that this migration request includes all the typical objects that are included in a wholesale migration. Your specific product may include this migration request into its own group migration

request to support a wholesale migration of all the framework and product administrative tables. An implementation may choose to build a custom group migration request. In this case, review the various migration requests provided by base to see if any may be included as components for the custom migration request. Then any new migration plans added to the base migration request in future releases are automatically included in future migrations.

---

**NOTE:** Refer to your specific product's CMA documentation for its recommendation on which migration requests to use for a full migration of framework and product administrative tables.

---

The following points highlight some information about the Framework-provided migration plans. Navigate to the migration plan page in the application to view the details of all provided objects.

- Fields and characteristic types are not migrated with an object (like a business object or a data area) unless specifically indicated.
- The **Application Service** used by an object is migrated only if it is CM-owned.
- The **Batch Control** object optionally references a User. If this user does not exist on the target system, CMA cannot apply the requested changes. Also note that when running a batch job, snapshot information is captured on the batch control. Updates like this increment the version number. If a batch control record is part of the migration and the comparison step has detected a change to the batch control, the Apply step will error out for this batch control if a batch job is submitted between the compare and apply step.

---

**NOTE:** CMA batch controls that are part of the import step are executing and as such, the system does not include these records in a migration. If your implementation changes default parameters for any of the batch controls, the recommendation is to manually make those changes to the target region.

---

- The base migration plans for MO and BO include instructions to copy option types that use foreign key references to refer to other objects. Note that the data stored in the options are not validated, so defining these instructions is not required when doing wholesale migrations. However, including subordinate instructions for foreign key references is useful for targeted migrations to ensure that the related data is included in the migration. If you add additional MO or BO option types that use foreign keys and you want to support targeted migrations, you must create custom migration plans and requests for MO and BO, respectively to include these referenced objects in the migration plan. Note that you do not need to duplicate the instructions in the base migration plans. You may define the additional migration plans to only have the additional custom option types. When submitting a migration request for MO or BO you must include both the base migration plans and the custom migration plans in the request.
- For scripts, schema-based objects and zones, the migration plans provided by the product migrate, through constraints, some of the typical associated data with them. However, data specified through alternate formats (such as through **Edit Data** steps in scripts, referenced in schemas for schema-based objects, or data from mnemonics in zone parameters, etc.) are not identified and combined in the same transaction. The iterative processing functionality of the import step should resolve any timing issues that may result in validation errors for these types of objects.
- There are two migration plans for **Scripts**. The migration plan **F1-ScriptOnly** migrates just the script and its **Application Service** (provided the Application Service is CM-owned). The migration plan **F1-Script** includes most related objects, but does not migrate any objects referenced in the edit data area steps. It does not move the **Function** maintenance object. It may be included in any appropriate custom targeted migration request where scripts and related data should be migrated.
- If your implementation includes a **Feature Configuration** setting for the **F1\_DBCONINFO** entry that will be included in a migration request, be sure that the import user on the target region has the appropriate security rights to this entry (**Administrator** access mode for the Feature Configuration application service (**CILTWSDP**)).
- The common attachments in the Attachment maintenance object may be considered administrative data to include in a migration. Because this MO has a system generated key, as described in [Migration Assumptions, Restrictions and Recommendations](#), it uses a logical key of the file name and the creation date to determine if the record exists in the target environment. In addition, this MO contains admin data (common attachments) and non-admin data (owned attachments). To try to minimize the possibility of key “collision”, new common attachments receive a generated key

that includes a zero in the middle whereas owned attachments receive a generated key that does not have a zero in the middle.

- The Menu maintenance object has a user defined key, however, its menu lines and menu items have system generated keys. To avoid the possibility of overriding a menu line or menu item incorrectly, the menu MO will check the menu line's menu name in the source and target to be sure they match and will check the menu item's menu line in the source and target to be sure they match otherwise an error will be issued in the comparison step.
- For the system messages, the product provides three different migration plans.
  - Message Category and its Messages (F1-MessageCategory). This migration plan is included in the **F1-SystemConfig** migration request.
  - Message Category (F1-MessageCategoryOnly). This migration plan is provided to support a targeted migration where an implementation has created a custom message category and wants to move it but doesn't want to move all its messages.
  - Message (F1-Message). This migration plan is provided to support a targeted migration where only specific messages within a message category should be migrated.
- For lookup values, the product provides two different migration plans.
  - Lookup Field and its Values (F1-Lookup). This migration plan is included in the **F1-SystemConfig** migration request.
  - Lookup Value (F1-LookupValue). This migration plan is provided to support a targeted migration where only specific lookup values within a lookup field should be migrated.
- There are some system data objects where no information in a base delivered record may be modified by an implementation. For these records, the base delivered migration requests include selection criteria to only select CM-owned records (because the base records will always exist in the target region assuming both regions have the same release). An example is Algorithm Type. The **F1-SystemConfig** migration request only includes CM-owned algorithm types. However, many system data objects support custom changes to one or more fields, for example the Zone object allows an implementation to override the zone text or certain parameters. Other system data objects support custom additions to a collection. For example, the Maintenance Object allows an implementation to add algorithms or options. For the migration plans related to these system data objects, all records are included in the base delivered migration requests to allow for any customized configuration to be migrated. It means that during the Import / Compare step many base delivered objects that are not customized will be marked **Unchanged**.
- Many of the integration related maintenance objects that include references to environment-specific data, such as Message Senders. This data should be migrated with extreme care. When appropriate, consider taking advantage of URI substitution. Refer to [Referencing URIs](#) for more information.

## Configuring Facts

Fact is an optional configuration tool for simple workflow-type business messages or tasks. The base package does not provide a dedicated Fact user interface because fact is generic by design. Implementations configure their own user interface to visualize the desired custom business process. The topics in this section describe the generic Fact entity and how it can be customized.

## Fact Is A Generic Entity

The Fact maintenance object is a generic entity that can be configured to represent custom entities and support automated workflows for a variety of applications. Each fact references a business object to describe the type of entity it is. A status column on the fact may be used to capture its current state in the processing lifecycle controlled by its business object.

The maintenance object also supports a standard characteristic collection as well as a CLOB element to capture additional information.

### Where Used

Follow this link to open the data dictionary where you can view the tables that reference [F1\\_FACT](#)

## Fact's Business Object Controls Everything

A fact's business object controls its contents, lifecycle and various other business rules:

- Its schema defines where each piece of information resides on the physical Fact maintenance object.
- It may define a lifecycle for all fact instances of this type to follow. Each fact must exist in a valid state as per its business object's lifecycle definition.
- It may define validation and other business rules to control the behavior of facts of this type.

---

**FASTPATH:** For more information about business objects, refer to [The Big Picture of Business Objects](#).

---

## Fact Supports A Log

The Fact maintenance object supports a log. Any significant event related to a Fact may be recorded on its log. The system automatically records a log record when the fact is created and when it transitions into a new state. In addition, any custom process or manual user activity can add log entries.

---

**FASTPATH:**

---

Refer to [State Transitions Are Audited](#) for more information on logging.

## Cloud Service Foundation

This chapter provides information on how to administer features associated with Oracle Utilities Cloud Service Foundation functionality.

---

**NOTE:** This chapter does not apply to all implementations. Contact your system administrator to confirm if your implementation includes Oracle Utilities Cloud Service Foundation.

---

## Process Automation Tool

---

**NOTE:** This section does not apply to all implementations. Contact your system administrator to confirm if your implementation includes Oracle Utilities Cloud Service Foundation and the Process Automation Tool.

---

The Process Automation Tool allows customers and implementers to orchestrate and automate a set of infrastructure related multi-step processes. The tool provides the ability to monitor the progress of such process and each of the steps. The tool also supports user actions at the process and step level.

The process automation tool is made out of the following system entities:

- Infrastructure Process - a Business Object of the Service Task MO.
- Infrastructure Process Step - a Business Object of the Service Task MO.
- Infrastructure Process Type - a Business Object of the Service Task Type MO.
- Infrastructure Process Step Type - a Business Object of the Service Task Type MO.

An Infrastructure Process references a type that includes the steps that are a part of that process. The steps are executed one by one according to their sequence as long as the previous step ended successfully. When a step in a process fails, the process will stop and wait for a user to take further actions.

An Infrastructure Process can span up to two product environments. This means that it can invoke and monitor steps in two systems. This, for example, allows it to orchestrate a configuration migration (using the [Configuration Migration Assistant](#)) from one product environment to another. Such a migration can include steps to create the export data on the **source** environment, move the export file to the **target** environment and execute all the import tasks on the target environment, all as a single Infrastructure Process. In this case the Infrastructure Process will be created on the **target** environment and will pull the configuration from the **source** environment.

---

**NOTE:**

This is done in order to ensure that only application users with sufficient security privileges in any system environment can create Infrastructure Processes that can update that environment.

The rule is that when an Infrastructure Process is created to run processes on two systems, the process will always be created on the **environment with the higher security requirements**. For example, if you need to run processes on the Development and Test environments, the infrastructure process will be created and executed from the Test environment (assuming that the Test environment has higher security requirements than the Development environment).

---

The steps that make an Infrastructure Process reference a step type that governs their behavior. A comprehensive set of process and step types is provided with the product. This set can be extended by implementers as needed.

## Creating an Infrastructure Process

To create a new process, navigate using **Admin > Implementation Tools > Infrastructure Process**. Use the Infrastructure Process Query to search for an existing process. Once an Infrastructure Process is selected, you are brought to the maintenance portal to view and maintain the selected record.

The following points provide information about creating a new Infrastructure Process.

Infrastructure Process references an **Infrastructure Process Type**. When creating a new process you need to select the type that the process will be based on.

The **Name** of the process is used for tracking purposes. The name doesn't have to be unique in the system.

The **Process Steps** list is read-only and represents the steps that were configured on the Infrastructure Process Type.

---

**NOTE:**

Changing information on the Infrastructure Process Type, including the steps, will not affect existing Infrastructure Process records.

---

The **Process Details** section represents additional information that is required according to the corresponding process type definition.

# Executing an Infrastructure Process

## Infrastructure Process Lifecycle

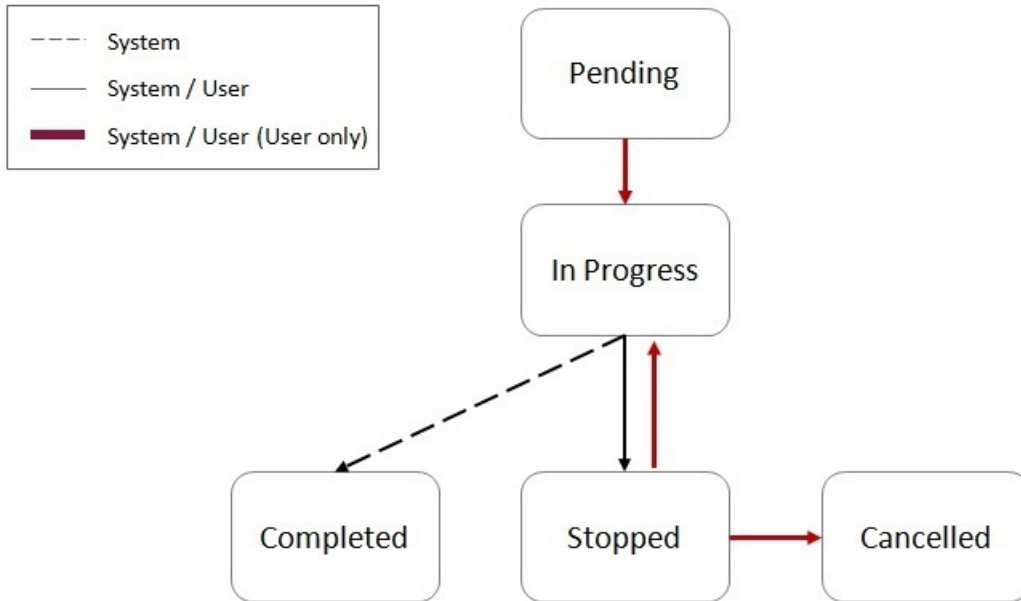

New processes are created in a Pending status. While in this status the Infrastructure Process record can be modified, deleted or duplicated.

---

**NOTE:** Once an Infrastructure Process record is created, its type cannot be changed. To change the type, you can delete the process that was created with the wrong type (if it is still in Pending status) and create a new process with the correct type.

---

Use the **Start** action, on the maintenance portal to begin the process execution. The process status will change to **In Progress**.

---

**NOTE:** While the Infrastructure Process is in **Pending** status, the steps will not have a status or any available actions. When the process transitions to **In Progress** status the process step records are created. From that point on they have a status and actions according to the step that and status.

---

While the process is **In Progress** the steps of the process will execute one by one according to their sequence. The process can be stopped using the **Stop** action. In this case the current step that is in progress will continue but the next step will not be executed. If any of the steps fail, the process will also transition into **Stopped** status and will not execute the next step.

When the process is in **Stopped** status it can be resumed by selecting the **Resume** action, or it can be cancelled by selecting the **Cancel** action.



## Infrastructure Process Step Lifecycle

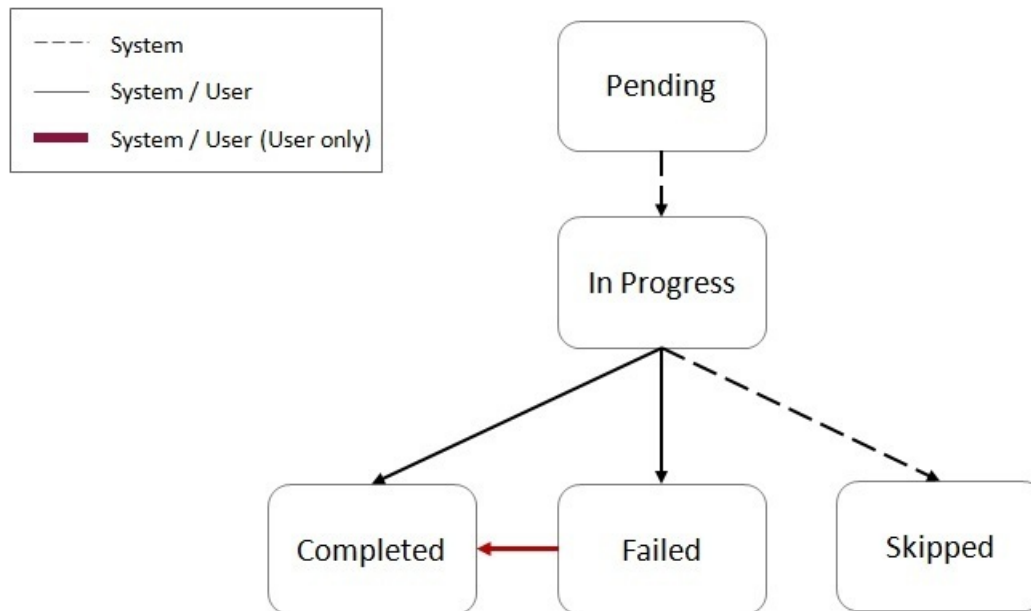

A process step is created in **Pending** status and is transitioned to **In Progress** by the process logic when its turn to execute arrives.

When a step is **In Progress**, the following transitions are possible:

- Transition the step into **Completed** status upon successful completion of the step's work or by selecting the **Complete** action.
- Transition the step into **Failed** status when an error was detected during the step's work or by selecting the **Fail** action.
- Steps may include logic that will transition the step into **Skipped** status if that logic determines that the step should not be executed.

When the step is **In Progress**, selecting the **Job Status** action will display information about the job running status (if it is a batch job type of step).

---

**NOTE:** Manually changing the step status to **Completed** or **Failed** while the step is **In Progress** should be carefully considered. This should only be done when step stays **In Progress** status for a long time and upon investigation it is clear that some manual intervention is required.

---

When a step is in **Failed** status it is still possible to manually transition the step into **Completed** status.

---

**NOTE:** Transitioning the step from **Failed** to **Completed** status should only be done if it is clear that the step was able to successfully accomplish its task. This will likely be established after some investigation.

---

## Monitoring Infrastructure Process Progress

### Infrastructure Process Control

The Infrastructure Process Control portal provides an overview of Infrastructure Processes that are active (i.e. in **Pending** or **In Progress** status) or processes that did not complete (i.e. in **Stopped** status) within the last X days.



Navigate to Infrastructure Process Control portal, using **Admin > Implementation Tools > Infrastructure Process Control**.

Available actions on this portal are:

- **New Process** - creates a new Infrastructure Process
- **Environment Setup** - directs the user to the master configuration related to the process automation tool

Select any of the processes from the portal lists for more information.

## Monitoring a Running Infrastructure Process

When a process is running (in **In Progress** status), you can monitor its progress by refreshing the page. To configure automatic page refresh, refer to the User Portal Preferences for this portal.

The Infrastructure Process maintenance portal provides information about the status of the overall process as well as each of the steps.

You can also view the details of each individual step including their log for more information or to investigate exceptions.

## Dealing with Exceptions

Infrastructure Process steps can be divided into two main categories:

- Steps that start a batch process (job)
- Steps that are not batch process related

In addition, steps can be local or remote. Local steps execute on the same product environment that the process is executing while remote steps are executed on a different product environment.

## Batch Job Step Exceptions

Batch job steps start a batch job either locally or on a different product environment.

### Batch job step in Failed status as a result of a batch job error

When a batch process (local or remote) ends with an error, the process step is automatically transitioned to **Failed** status.

In this case, you should:

1. Ascertain the cause of the job failure (in the local or remote environment).
2. If the issue is temporary or can be fixed, fix it and then rerun the batch job manually using the Batch Job Submission page (in the local or remote environment). If the resubmitted job ended successfully, you can transition the process step to the **Completed** status and use the **Resume** action at the process level to continue the process execution.

If the issue cannot be resolved, further investigation is required. In this case the process should remain in **Stopped** status.

### Batch job step in In Progress status while batch job ended with an error

When an Infrastructure Process Step that is associated with a batch job stays in **In Progress** status while the batch job ended with an error, further investigation is required. One possible cause for that situation could be an error that causes the job to fail and at the same time also prevents the job from communicating its status back to the originating process step.

In this case you should manually transition the step into **Failed** status and continue your investigation.

---

**NOTE:** If you decide to stop the Infrastructure Process altogether (as a result of the exception), it is a good idea to mark the batch job that failed as “Do Not Attempt Restart” in the Batch Run Control for that batch run. This will ensure that

the next time the Infrastructure Processes runs, when it gets to that batch process step it will not attempt to resume the execution that ended with an exception, possibly causing a repeat of the exception.

---

## Batch job step in In Progress status while batch job ended successfully

When an Infrastructure Process Step that is associated with a batch job stays in **In Progress** status while the batch job ended successfully, further investigation is required. In this case, once you ascertained that the job did actually end successfully, you can manually transition the process step into **Completed** status and use the **Resume** action at the process level to continue its execution.

## Non-Batch Step Exceptions

Infrastructure Process Steps that are not associated with batch jobs can experience errors as well and therefore can fail. As a reminder, the logic for these steps can experience local or remote errors. When such a step fails, information about the failure can be found in the process step log.

## Process Automation Tool Setup

The process automation tool requires the setup of the following components:

- Master Configuration
- External Systems
- Message Senders

In addition, a security setup is required.

The setup itself is done automatically as part of the environment provisioning process. The information in this section is provided for reference and in case changes in existing setup are required.

## Security Setup

Before the process automation tool can be used, the security credentials of the Message Senders, used by the process automation tool, must be updated.

In order to execute the security setup, navigate using **Admin > Implementation Tools > Process Automation Security Setup**.

The setup script will ask you to provide a User ID, a Password and to indicate whether or not to override the existing security setup.

**Please contact your system or security administrator for more information about what User ID should be used for this setup.**

You should select to override existing security setup when you need to update the User ID or the Password on the existing Messages Senders, used by the process automation tool. A common use case will be mandatory periodic password rotation for the user account that was selected for the setup.

---

**NOTE:** At the end of the process, you will be asked to flush all the system cache. This is required in order for the information update to take effect.

---

## Master Configuration Setup

The process automation tool relies on master configuration settings in order to identify all the product environments that are available to it. The Master Configuration is automatically setup as part of the system provisioning process.

This section describes the setup options in case manual changes are needed.

To access the configuration for the process automation tool, navigate using **Admin > General > Master Configuration** and look for Process Automation Configuration.

The Main section includes the definition of the **Current Environment** code and the **default file extension** for CMA export files.

The Current Environment code is a **unique** code that is given to each product environment.

The Environment List section describes all the existing product environments and integration (SOA) environment that the process automation tool need to interact with, for example, in order to run a process that moves integration configuration from one environment to another.

The environment in the list includes the following details:

- **Environment:** the environment code.
- **Product:** defined in the Process Automation Product extendable lookup.
- **Domain:** defined in the Process Automation Domain extendable lookup.
- **Migration Source:** select “Yes” if you can migrate configuration data from this environment.

---

**NOTE:** You should not allow automated migration of configuration from your development environment directly to your production environment but you would allow migrating from the development to test environments.

---

- **External System:** reference to the External System definition that will support communication with the row’s environment.
- **SFTP Alias:** this is a name of the SSH file that will be used to support file transfer capabilities between system environment directories.

## External Systems and Message Senders

The process automation tool communicates with other product environments (including SOA environments) through Outbound Messages.

The automated setup for the process automation tool creates a set of Message Senders and External Systems to support communication with other product environments.

Each product environment which is defined on the Process Automation Configuration has a corresponding unique External System. Each External System contains the details of all the message types that it supports, the message sender for each message type and additional data if required (for example, message or response XSLs).

## Configuring New Infrastructure Processes

The process automation tool configuration is essentially a collection of process types and step types that support the automation of various multi-step processes. A set of Infrastructure Process Types and Infrastructure Process Step Types is provided with the base product. Customers and implementers can create new process and step types.

This section describes the actions required to configure new Infrastructure Process Type and Infrastructure Process Step Type.

## Configuring a New Infrastructure Process Step Type

In order to configure a new step type, navigate using **Admin > Implementation Tools > Infrastructure Process Step Type**. Use the Infrastructure Process Step Type Query to view existing step types.

---

**CAUTION:** Base product step type names start with “K1” and should not be change. Changing these step types can break the process and step types that are provided with the product.

---

The following points provide information about creating a new Infrastructure Process Step Type.

When creating a new step type, a business object has to be selected first. The Infrastructure Process Step Type BO contains the information necessary for the Infrastructure Process Step that references that step type. For example, a batch process step type BO contains information related to the batch code that should be submitted and the parameters that will be passed to it. You can use existing Infrastructure Process Step Type BOs or create new BOs according to your business requirements.

The **Related Transaction BO** references the Infrastructure Process Step BO. The step BO contains the business logic associated with the step. For example, a batch process step BO is responsible to submit a batch job with to the information from the step type. You can use existing Infrastructure Process Step BOs or create new BOs according to your business requirements.

The **Process Step Type Details** section represents additional information that is required for this specific step type BO.

## Configuring a New Infrastructure Process Type

In order to configure a new process type, navigate using **Admin > Implementation Tools > Infrastructure Process Type**. Use the Infrastructure Process Step all-in-one portal to view existing process types.

---

**CAUTION:** Base product process type names start with “K1” and should not be change. Changing these process types can break the base product process types that are provided with the product.

---

The following points provide information about creating a new Infrastructure Process Type.

When creating a new process type, a business object has to be selected first. The Infrastructure Process Type BO contains information necessary for the Infrastructure Process that references that process type. You can use existing Infrastructure Process Type BOs or create new BOs according to your business requirements.

The **Related Transaction BO** references the Infrastructure Process BO. The process BO contains the business logic associated with the process. This includes the orchestration of the process steps. The process BO also contains information that is shared by step business logic during the process. For example, a process BO that handles migration of data between product environments can have a buffer that will hold the information pulled from the source environment using one step so that another step can use it to push that to the target environment. You can use existing Infrastructure Process BOs or create new BOs according to your business requirements.

The **Process Type Steps** section includes a collection of step types. The sequence of steps has to be unique and this will be sequence of execution.

---

**CAUTION:** When selecting step types for a process type you need to consider the fact that not all step types can be used on all process types. For example, some steps need to get or save information in the process itself so it can be used by other steps of that process. These types of steps can only work with a certain type of process. Please refer to the detailed description in each of the base product provided Infrastructure Process Step Types to see what process types they can be referenced on.

---

The **Infrastructure Process Type Details** section represents additional information that is required for the specific process type BO.

## CMA Migration Infrastructure Process Types

The following Infrastructure Process Types are provided to support the following configuration migration use cases:

- CMA Accelerator Load - import an exported file created by the Configuration Migration Assistant export process.

- CMA Migration - a wholesale or piecemeal configuration migration (using the Configuration Migration Assistant), exporting configuration from a source environment and importing it to a target environment.

## CMA Accelerator Load (K1-CMA-LOAD)

The K1-CMA-LOAD Infrastructure Process Type supports importing of an exported CMA file.

K1-CMA-LOAD is based on K1-CMAMigrationProcessType Infrastructure Process Type BO and uses the K1-CMAMigration as the Infrastructure Process BO.

The CMA Accelerator Load process type includes all the necessary steps to download an exported CMA file (that was uploaded to the system via FTP) into the environment that the process is running on (via FTP) and to run all the batch processes that are a part of the CMA import.

---

**NOTE:** This process type does not include a step for a manual user review. It is assumed that when loading an accelerator, there shouldn't be anything to review and the new configuration content is expected to be new for the most part or OK to override existing configuration.

---

## Using the CMA Accelerator Load Infrastructure Process Type

In order to import a CMA export file (e.g. an accelerator), you need to:

- Upload the file to the system via FTP.
- Create a new infrastructure process with the K1-CMA-LOAD Infrastructure Process Type and provide the following additional details:
  - **Name.**
  - The **Process Steps** list is for reference only.
  - **Export filename:** specify the CMA export file name that was uploaded to the system. You should specify the full name including the file extension name.
  - **User Review Needed:** select “Yes” only if you are expecting the CMA file to include data that already exists in the system and need to be reviewed before changes are applied.
  - **Default Status For Add, Default Status For Update** are relevant in case you selected to have a user review. In this case define the default status of migration data items when imported into the target environment.
- Once the process is saved, you can start it by selecting the Start action.

## CMA Migration (K1-CMA-MIGRATE)

The K1-CMA-MIGRATE Infrastructure Process Type supports a full or partial migration of configuration data, from a remote environment (the source) to the environment that the process is running on (the target).

---

**NOTE:** The configuration migration process is done as a PULL (running on the target environment and pulling data from the source environment) to make sure that users without security privileges to make changes in a product environment “A” won't be able to run a process from a remote environment “B” that will force changes into “A”.

---

K1-CMA-MIGRATE is based on K1-CMAMigrationProcessType Infrastructure Process Type BO and uses the K1-CMAMigration as the Infrastructure Process BO.

This configuration migration process type includes all the necessary steps to create an export CMA file from a migration request on the source environment, move the file into the target environment (via FTP) and to run all the import batch processes on the target environment to process the file. This process type also includes a step for a manual user review of the imported data if needed.

## Using the CMA Migration Infrastructure Process Type

In order to migrate configuration data from a remote environment (the source environment) to the current environment (the target environment) you need to:

- Create a new infrastructure process with the K1-CMA-MIGRATE Infrastructure Process Type and provide the following additional details:
  - **Name.**
  - **From Environment:** select the source environment from which the data will be migrated to the target environment (the current environment). The list of valid environments to choose from is taken from the Process Automation Master Configuration. The target environment is always the current environment - the one that this process is created on.
  - The **Process Steps** list is for reference only.
  - **Migration Request:** specify the CMA Migration Request ID that will be used for the migration process. The migration request should exist on the source environment and will be validated against that environment.
  - **Export filename:** specify the CMA export file name that will be used for the export and import process. You should specify the full name including the file extension name. If you leave this field empty, the system will default the file name according to the migration request ID and the default file extension name.
  - **User Review Needed:** select “Yes” only if you are expecting the CMA file to include data that already exists in the system and need to be reviewed before changes are applied.
  - **Default Status For Add, Default Status For Update** are relevant in case you selected to have a user review. In this case define the default status of migration data items when imported into the target environment.
- Once the process is saved, you can start it by selecting the Start action.

## Integration Configuration (SOA) Infrastructure Process Types

The K1-INTEG-CONFIG-MIGR Infrastructure Process Type supports the migration of integration configuration data from a source to a target environment for the following configuration types:

- DVM data
- Integration Configuration Properties

The migration is done by using REST APIs that are provided by the integration infrastructure to get and post data. Migration of integration configuration will include a step to get the data from the source environment and then post it to the target environment.

## Integration Configuration Migration (K1-INTEG-CONFIG-MIGR)

K1-INTEG-CONFIG-MIGR is based on K1-IntegConfigMigProcessType Infrastructure Process Type BO and uses the K1-IntegrationConfigMigration as the Infrastructure Process BO.

This migration process type includes all the steps to migrate DVM and Integration Configuration Properties.

## Using the Integration Configuration Migration Infrastructure Process Type

In order to migrate integration configuration data from a remote environment (the source) to the current environment (the target) you need to:

- Create a new infrastructure process with the K1-INTEG-CONFIG-MIGR Infrastructure Process Type and provide the following additional details:
  - **Name.**

- **Product:** select the integration product whose configuration you wish to migrate.
- **From Environment:** select the source environment to migrate the configuration from. The environment should be one of environments of the product that was selected. The list of valid environments to choose from is taken from the Process Automation Master Configuration according to the product that was selected.
  - The target environment is set to the current domain of the product that was selected. For example, if you are creating a process in the Test environment and you select an integration product “A”, then the target environment will be the “A”-Test environment.
- **Migrate DVM:** select Yes to migrate DVM data. Selecting No will cause the process to skip this step.
- **Migrate Configuration File:** select Yes to migrate the integration configuration properties file. Selecting No will cause the process to skip this step.
- Once the process is saved, you can start it by selecting the Start action.

## Data Conversion Support for Cloud Implementations

This chapter provides information and requirements on data conversion in support of Oracle Utilities Cloud implementations.

---

**NOTE:** This section does not apply to all implementations. Contact your system administrator to confirm if your implementation includes Oracle Utilities Cloud Service Foundation and Data Conversion Support for cloud implementations.

---

## Data Conversion Overview

The ability to convert customer data from legacy systems to OUAF based products is critical for every implementation. The following chapter describes the overall process, tools and considerations for customer data conversion to SaaS OUAF based product on Oracle Cloud.

## Conversion Steps

In general data conversion effort in the cloud is divided into the following steps:

- Prepare for conversion
- Create conversion data files
- Upload conversion data files to the cloud
- Process conversion data files
- Process converted data in cloud application
- Approve converted data for production mode

---

**NOTE:**

It is important to note that the conversion process is a highly iterative process. All the steps above are likely to be done (completely or partially) multiple times during the conversion process.

For example, customer typically start with a small set of data to convert, they fix issues discovered with that data and then re-create new data files and proceed to convert them. This can happen many times, each time with either a different data sample or bigger and bigger data conversion sets until all the required data has gone through the conversion process.

---

## Prepare for Conversion

Preparing for conversion will typically include the following actions:

- Identify the OUAF product entities (Maintenance Objects) for which data will be converted. Refer the specific OUAF product documentation for information about converted entities for that product. Each of the product converted entities will have a set of conversion staging tables that will receive the data from your legacy system before they get processed into the system.
- Identify tables and maintenance objects whose data requires special treatment. That may include high volume tables, extremely large CLOB data, tables with multiple CLOB fields or any other special considerations related to the legacy data being converted.

Address the special circumstances by customizing the default configurations:

- Enable conversion for tables that are not marked for conversion in the metadata use the Master Configuration
- If your table(s) contain multiple CLOBs, but you don't plan to supply the legacy data for all of them, create Conversion Task Type for this table(s) and populate **Exclude CLOB Field** list and then add a corresponding entry to Master Configuration's Special Instructions
- If you dealing with high volumes of data, you may want to adjust the load parameters and options for the SQL Loader.. In this case, create a **custom Control File Header** (Managed Content), configure a dedicated Conversion Task Type referencing this custom Control File Header and then add a corresponding entry to Master Configuration's Special Instructions. Note that creating the custom Control File Header will result in a control file composed from the custom fragment and the generated fields list.
- If the generated field definitions list in the control file doesn't satisfy your requirements, you may completely override the control file. In this case, create a **custom Control File** (Managed Content, same as above), configure a dedicated Conversion Task Type referencing this custom Override Control File and then add a corresponding entry to Master Configuration's Special Instructions. Make sure your custom Control File contains all the run-time substitution variables that appear in the base Control File Header.

See [Conversion Task Types](#) and [Conversion Master Configuration](#) chapters for more details.

- Generate the conversion artifacts for the product entities you plan to convert data for. This will include, for example, a set of data specification files that describe the format of data required for each file.
- Run the batch job to copy the generated conversion artifacts to sFTP server. Download and examine the input data specifications and determine the expected data formats and input file names.
- Identify your various sources of data and extraction methods.

## Create Conversion Data Files

In this step you create the set of data conversion files that were identified for the conversion process. You can choose to generate data files for each staging table or create a smaller set for each converted Maintenance Object.

The data conversion files typically do not include all the data to begin with but start small and grow with every iteration of the conversion process until they reach their maximum size at the end.

---

**NOTE:** When performing data conversion in the cloud, customers don't have access to the database staging tables. Data scrubbing and transformation activities has to take place before the data files are generated (in each conversion iteration) so the result of these activities is reflected on the data files that are moved to the cloud to be loaded into the staging tables.

---



## Upload Data Conversion Files to the Cloud

Since data conversion files are created locally they have to be uploaded to the cloud environment in order to be processed and loaded into the conversion staging tables.

In this step you can use any sFTP client with the account credentials that were provided at provisioning time to upload all the files via FTP to the cloud environment.

For more details refer to [Input Data Files](#) .

## Process Conversion Data Files

After uploading the files to the cloud, you should run a set of batch processes that will process the data files using Oracle SQL Loader and insert the data to the product conversion staging tables.

The staging table load process also produces output files that provide feedback on the load process.

You can download these output files for review using the same sFTP client you used to upload the data file.

---

**NOTE:** The process that imports the data in the files to the staging tables, using Oracle SQL Loader, is using the artifacts that were generated in the “Prepare for Conversion” step.

---

For more details refer to [Understanding Load Data Process](#) .

## Process Converted Data in Cloud Application

When the data intended for conversion (for a conversion iteration) is loaded into the appropriate conversion staging tables, the OUAF application in the cloud can process that data according to the product’s data model, technical and business rules.

Refer to the OUAF product specific documentation for further guidelines and information on the specific processes and guidelines related to data conversion.

---

**NOTE:**

This is one step of the overall iterative process but it is also includes many internal steps, for example:

1. Validation of the data in the conversion staging tables.
2. Generation of the system assigned keys for the converted entities.
3. Migration of the converted data from the staging tables into the actual system tables.

When the processing of the converted data in this iteration is completed, information from the system is used to identify changes necessary to source data, the extraction process or other activities involved in producing the data to be converted.

The process can then start over by loading a new set of data into data conversion files, load them to the staging tables in the cloud and process them once more to get more feedback.

---

## Approve Converted Data for Production Mode

When the quality and scope of data converted has reached its target, the process can stop. Once the overall data has been approved for production mode the conversion process comes to an end. The process of approving the data includes many activities, for example:

- Running various reports to compare converted data with legacy data to verify the quantity and quality of the data.
- Running reports and tests in the new application to verify the data and the system’s behavior using that data.

- Manual review of random and key data in the system.

## SQL Loader

Loading the data in the data conversion files into the product conversion staging tables is done using Oracle SQL Loader. Oracle SQL Loader is an Oracle Database Tool that enables mass upload of data from various sources into database tables in a fast and safe way.

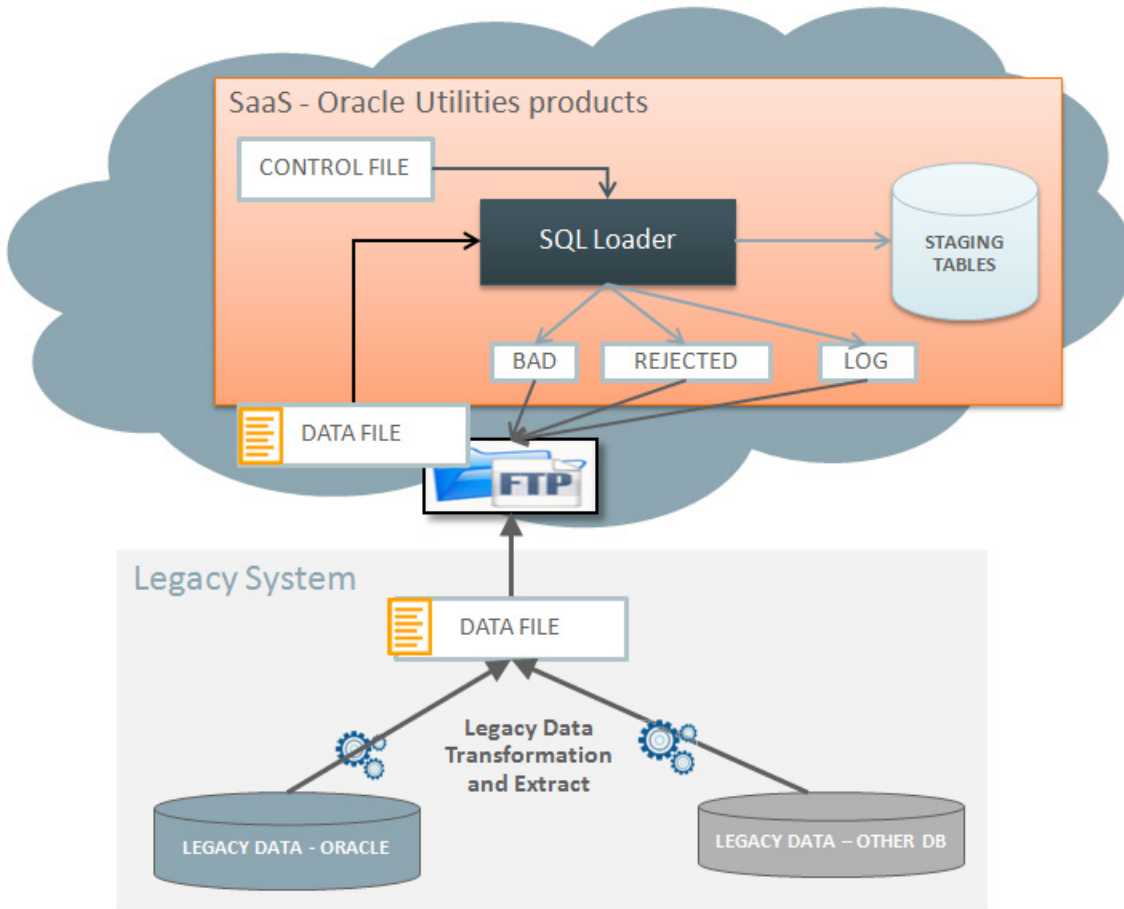

SQL Loader processing is determined by Control Files. The control files for the data conversion process are provided for each of the product conversion staging tables as part of the artifact generation which is a part of the preparations activities before starting the conversion process.

The Control Files typically define:

- The location of input files to load.
- The character set of the input data.
- The target table(s) for the load and how to insert the data (e.g. append to or override).
- How to map the data in the input file to tables and fields.
- The location of the output files (e.g. log, bad or rejected records).
- Options for parallel processing and load balancing.

The control files that are generated for the product include all the parameters necessary to load the product conversion staging tables. There are some customization options for these files that are discussed later.

After loading the control files, SQL Loader reads the records in the input data file(s), converts the input into database tables and columns that are inserted into the database.

SQL Loader has 2 modes of operation:

- **Conventional Path Load** – data is inserted to the database by using database SQL INSERT statements.
- **Direct Path Load** – data is inserted into the database using data blocks that are written directly to the database. This method is much faster and therefore is the method selected for the data conversion process.

SQL Loader has the ability to deal with multiple data files mapped to multiple tables as well as loading data into CLOB fields.

## Using SQL Loader When Processing Conversion Data Files

Processing of uploaded conversion data files is done via a Batch Process (for each staging table or MO) that does the following:

- Prepare parameters for invoking SQL Loader.
- Invoke SQL Loader for loading one staging table or one MO, using the data files that was uploaded to the cloud (using sFTP). The data file is processed directly from the sFTP server and is NOT copied to a local directory on the server.
- Archive the input file(s) and upload the results output files to the sFTP server so they can be subsequently downloaded by the customer for review.

## Conversion Artifacts

The base product includes a set of artifacts that support the conversion process. These artifacts are provided on demand (generated as a result of a user request in the system).

The available artifacts are:

- Input Data Specifications
- SQL Loader Control Files

## Conversion Input Data Specifications

The system will generate a text file with data specification instructions for each of the conversion tables that are supported by the base product.

The specification files are for reference ONLY and are not used by the system at run time. These files describe the data format for each table so that the data specified can be loaded correctly with the Control File that is also generated by the system.

For more details refer to [Conversion Artifact Generator](#) .

## SQL Loader Control Files

The control files are for internal use and are generated for each of the conversion tables that are supported by the product. These files are used by SQL Loader to interpret and load the data that is provided in the conversion data files.

The control file contains:

- General load parameters and options
- Data field specifications and table-specific load instructions

For more details refer to [Conversion Artifact Generator](#) .

# Configuring Conversion

The following sections describe the settings and configurations used by various conversion processes.

## Conversion Master Configuration

The **Conversion Data Upload Master Configuration** controls generic aspects of legacy data load process.

**Main** section captures the definitions globally applicable for all converted objects (tables and/or maintenance objects):

- **Default Conversion Instructions for Artifact Generator** reference conversion task types that define load parameters for individual tables or maintenance objects.  
The Master Configuration captures conversion task types with default configurations for both table and maintenance object-level loads.
- **Conversion Artifacts options.** You can indicate that the snapshot of the generated file(s) should be **Stored as an Attachment**. If the indicator is set to **Y**, the **Business Object to use for the Attachment** has to be specified, otherwise, it is not required.

**Special Instructions** section captures the definitions that support various idiosyncratic data upload scenarios

- **Override Instructions** for Tables and Maintenance Objects define Conversion Instructions (conversion task types) for objects that require special processing or data formatting
- **Override Conversion Eligibility** list allows you to specify tables that are not marked for conversion in metadata, but your implementation wishes to include in the conversion scope. NOTE: if the table you wish to convert has a related key table, this key table has to be explicitly added to this list.

## Conversion Task Types

To configure a new conversion task type, navigate using Admin → Conversion Support → Conversion Task Type.

The definitions on the conversion task type control the data load parameters for the target table or maintenance object. Conversion Task Type also defines the transactional business object for Conversion Task. The algorithms linked to the transactional business object are responsible for the generation of the Conversion Artifacts: control files and input data specifications.

Conversion Task Types defines:

**General Input Data Instructions** (all Conversion Task Types Business Objects)

- Strings to use as **data delimiters** and enclosing characters. These attributes are referencing the Extendable Lookup values for *K1-ConvFileDelimiterLookup* and *K1-ConvFileEnclosingCharLookup*
- **Date and DateTime fields' formats.** These attributes are referencing the Extendable Lookup values for *K1-ConvLoadDateFormatLookup* and *K1-ConvLoadDateTimeFmtLookup*
- **CLOB data extract rule** indicates whether the CLOB data is supplied as part of the input data file or as a separate, secondary file
- **Control File Header** - a fragment of the control file that contains general load parameters. This fragment is included in the generated control file. This is a Foreign Key reference to the **Managed Content** entry.
- **Override Control File** - a full text of the control file that contains both load parameters and field definitions. The entire text is copied into generated control file 'as is'. This is a Foreign Key reference to the **Managed Content** entry.

**CLOB Field Instructions** for Tables/MO-s that contain multiple CLOB fields (Business Objects *K1-ConvArtMultClobMOTaskType* and *K1-ConvArtMultClobTblTaskType*)

- Target Object — **Table** or **Maintenance Object**

- **Exclude CLOB Fields** list — the list of CLOB fields that are not expected to be provided with the legacy data extract and therefore should be excluded from the generated control file.

The following Conversion Task Types are pre-configured in the product:

- **K1-CNV-TABLE** - meant to be used for a single table load. It is referencing a Transactional Conversion Task Business Object whose algorithms generate Table Conversion Artifacts
- **K1-CNV-MO** - meant to be used for a single maintenance object load. It is referencing a Transactional Conversion Task Business Object whose algorithms generate Maintenance Object Conversion Artifacts
- **K1-CNV-KEY-TABLE** – meant to be used for the Key Tables. Key Tables are index-organized tables (IOT) and as such cannot be loaded in multiple concurrent sessions of SQL loader. This Task Type is referencing a Control File Header (Managed Content) where *Parallel Load* parameter is set to *false*

## Conversion Artifact Generator

Conversion Artifacts is a set of supporting files used for data upload with SQL Loader. The artifacts are generated based on the table and maintenance object metadata and the definitions from [Conversion Master Configuration](#) and [Configuration Task Types](#). Conversion artifacts include SQL Loader control files and input data file specifications.

Input data file specifications provide detailed field-by-field description of the expected data type and format, field order and other instructions. Your implementation may use these specifications to create the legacy data extract.

The generator reads [Conversion Master Configuration](#) in order to determine the conversion task type associated with the table or maintenance object.

You can choose to generate artifacts for table-level and/or maintenance object-level load, or for the entire system or for specific Table or Maintenance Object:

- Navigate to **Admin** —> **Conversion Support** —> **Generate Conversion Artifacts**.
- Select one of the options:
  - **Generate All** – performs a complete refresh of the conversion artifacts. It deletes existing and creates new Conversion Tasks for every table that is marked for conversion in the metadata. It also creates Conversion Task for every Maintenance Object that includes tables marked for conversion.
  - **Include All Tables** – recreates artifacts for all Tables that are marked for conversion in the metadata
  - **Table search** allows you to select specific target table
  - **Include All maintenance Objects** – recreates artifacts for all Maintenance Objects whose tables are marked for conversion in the metadata
  - **Maintenance Object search** allows you to select specific target Maintenance Object.

---

**NOTE:** The process overrides all previously generated artifacts and replaces existing files.

---

The generator creates **Conversion Tasks**, one instance per table and/or per maintenance object and creates attachment that stores the input data file specifications file. The attachment is linked to the Conversion Task as a Related Object.

The regeneration is necessary each time the metadata or conversion configurations are amended.

Conversion Tasks query is provided with the base product.

### Accessing the Artifacts

In order to make the generated input data file specifications available for download, submit the batch process [K1-CNVUS](#).

After successful batch completion, locate the files under corresponding folder. Refer to [Input and Output File Location](#) for more details. You can also view the individual specifications by searching for a Conversion Task and exploring the linked attachment.

---

**NOTE:**

- The specification file name for the table is composed as *<table name>\_spec.txt*
  - The specification file name for the maintenance object is composed as *<maintenance object code>\_spec.txt*
- 

## Conversion Tasks

The following sections provide information about Conversion Tasks and generated conversion artifacts.

### Conversion Task Query

Conversion Task query allows to search by variety of criteria:

- Creating User, Conversion Task Type and Status
- Linked Object – Table or Maintenance Object
- Exact Conversion Task ID

### Conversion Task

The purpose of the **Conversion Task** is to maintain the conversion artifacts for Table or Maintenance Object. Please consider the following with respect to conversion tasks.

- The business object lifecycle supports multiple attempts to re-generate the artifacts.
- The re-generation could be triggered either manually or by the Conversion Artifact Generator. Only one set of the artifacts is relevant at any point of time, hence only one Conversion Task at the time can exist for a given Table or Maintenance Object.
- Typically, Conversion Tasks are created by [Conversion Artifact Generator](#). However, it can also be created manually by navigating to **Admin**—> **Conversion Support** —> **Conversion Task**.
- Use the Conversion Task Query to search for an existing entry. Select the entry from the search results to navigate to the maintenance portal to view and maintain the selected record.
- Conversion Task references a Conversion Task Type and contains standard business object record information, including the creation date/time, status update date/time and creating user.
- The task references the object – **Table or Maintenance Object** – for which the artifacts are generated.
- The collection of task's **Related Objects** store references to the Attachments that store a snapshot of the generated files. A new attachment is created after each generation run and linked to the Conversion Task for audit purposes.

### Conversion Batch Controls

The following batch controls are delivered with base product:

---

**NOTE:**

Batch processes that interact with sFTP server include **Source Host Alias** parameter (required). This parameter should be populated with SSH configuration file name of the sFTP account.

The value will be different for each of the OUAF-based products; the file is generated upon service subscription. Contact your security administrator to obtain the file name.

---

Batch Control	Description
K1-CNVLD	Conversion - Load Data using SQL Loader.

---

This process facilitates the legacy data extract upload using SQL Loader. The input data files are expected to be compressed using **gzip** and uploaded to the sFTP site.

One run uploads the data into a target Table or Maintenance Object.

The process is multi-threaded.

---

K1-CNVDS	<p>Conversion - Disable Conversion</p> <p>This process resets the environment indicators and prevents further conversion activities. Once conversion is disabled, the following actions are blocked:</p> <ul style="list-style-type: none"><li>• Switching between Conversion and Production</li><li>• Table truncation</li><li>• Disable Indexes and Rebuilding the Statistics</li><li>• Data insertion into Production</li><li>• Data upload into staging</li></ul>
K1-CNVEN	<p>Conversion - Enable Conversion</p> <p>This process resets the environment indicators and enables it for conversion activities. It should be executed at the start of the Conversion project.</p>
K1-CNVUS	<p>Conversion - Upload Specification Files</p> <p>This process is copying the input data specification files into sFTP location and makes them available for the download</p>
K1-DRPIN	<p>Conversion - Disable Indexes on Production Tables</p> <p>This process can be used in two modes:</p> <ul style="list-style-type: none"><li>• Populate Table or Maintenance Object batch parameter to process specific object</li><li>• If no specific target is populated, the process disables indexes on all converted tables in Production schema</li></ul>
K1-SDSIN	<p>Conversion - Disable Indexes on Staging Tables</p> <p>This process can be used in two modes:</p> <ul style="list-style-type: none"><li>• Populate Table or Maintenance Object batch parameter to process specific object</li><li>• If no specific target is populated, the process disables indexes on all converted tables in Staging schema</li></ul>
K1-RIUSP	<p>Conversion - Rebuild Indexes and Update Statistics in Production</p> <p>This process can be used in two modes:</p> <ul style="list-style-type: none"><li>• Populate Table or Maintenance Object batch parameter to process specific object</li><li>• If no specific target is populated, the process rebuilds indexes and updates statistics on all converted tables in Production schema</li></ul>
K1-RIUSS	<p>Conversion - Rebuild Indexes and Update Statistics in Staging</p> <p>This process can be used in two modes:</p> <ul style="list-style-type: none"><li>• Populate Table or Maintenance Object batch parameter to process specific object</li><li>• If no specific target is populated, the process rebuilds indexes and updates statistics on all converted tables in Staging schema</li></ul>
K1-CLNTB	<p>Conversion - Truncate Tables in Production</p> <p>This process can be used in two modes:</p> <ul style="list-style-type: none"><li>• Populate Table or Maintenance Object batch parameter to process specific object</li><li>• If no specific target is populated, the truncates all converted tables in Production schema</li></ul>
K1-SCLTB	<p>Conversion - Truncate Tables in Staging</p> <p>This process can be used in two modes:</p> <ul style="list-style-type: none"><li>• Populate Table or Maintenance Object batch parameter to process specific object</li><li>• If no specific target is populated, the truncates all converted tables in Staging schema</li></ul>
K1-CLNKY	<p>Conversion - Truncate Key Reference Tables</p> <p>This process can be used in two modes:</p> <ul style="list-style-type: none"><li>• Populate Table or Maintenance Object batch parameter to process specific object</li><li>• If no specific target is populated, the truncates all Key Reference tables in Staging schema</li></ul>

---

---

## Configuring Data Load Batch Controls for Conversion Project

The generic batch process [K1-CNVLD](#) performs the load of the input data file(s) into a target table or maintenance object, specified as one of the batch parameters.

Consider creating individual batch controls per object (table or maintenance object).

It allows leverage the parallel processing capacity of the system; the data load processes for all objects can be submitted near-simultaneously, thus minimizing the time needed for the legacy data upload, which is only an initial step in the overall data conversion process.

Use batch control [K1-CNVLD](#) for rehearsal load batch run for various tables and/or maintenance objects and determine the optimal load strategy:

- Whether the data should be extracted and loaded as single Tables and/or Maintenance Objects
- Whether and how to split the data files and the number of threads for the batch
- Potential log file size and the feasible logging level

Configure data load Batch Controls for each individual Table or Maintenance Object. Pattern the configuration after [K1-CNVLD](#) and set the default parameter values for:

- Target Table or Maintenance Object
- File Extension
- Log Level
- Retain Input Option
- Max Number of Upload Error

Default **Thread Count** depends on the type of the uploaded table. Regular tables can be uploaded in a single or multiple threads. Key tables must be uploaded in a single thread

**Source Host Alias** parameter value is environment-specific. The default value cannot be pre-configured, but would be the same for all batch jobs submitted in a specific environment. Obtain the value for the parameter by navigating to **Implementation Tool** —> **Process Automation Configuration**, locate the entry corresponding to the current environment in the **Environment** list and find the *sFTP Alias*.

## Input Data Files

This section provides information on inputting data files for data conversion.

### Overview

This section provides information on the requirements and details for file upload, loading table, maintenance object, CLOB, layout, data formatting, and so on related to inputting data files for data conversion.

### File Creation and Upload

The extract data is expected to be uploaded in compressed form. Use *gzip* to create compressed input data files.

#### File Creation

Use your sFTP account to retrieve input data specifications from **conversion/reference** directory. Create the data extract text file, using field delimiters, enclosing characters and data formatting according to the specifications.

If the files were created under Windows operating system, it is recommended to remove the carriage return character prior to compression (not applicable for secondary files with CLOB data).



## File Compression with gzip

Use gzip utility to compress the file.

- For Windows operating system, download and install gzip utility for Windows. Run the following:

```
# Navigate to the gzip folder
cd C:\gzip-1.3.12-1-bin\bin
# Run gzip.
# New file will be created in the same directory as the original the input file
gzip -k <full path to the input data file>
# Sample command for the file TABLE_NAME.txt located under
# C/myDataDirectory/:
gzip -k C/myDataDirectory/TABLE_NAME.txt
```

- For Unix/Linux operating systems, run the following command:

```
gzip < <inputFile name> > <outputFile name with .gz suffix>
# Sample command for the file TABLE_NAME.txt
gzip < TABLE_NAME.txt > TABLE_NAME.txt.gz
```

## Loading Table or Maintenance Object

The conversion data upload supports two types of the extract:

- Data extract that contains the data for a single target staging table.

In this case, the upload process inserts records into a single staging table. The input data file consists of similar records, each represents a row in the target table.

- Data extract that contains the data for the group of target staging tables that represent a Maintenance Object.

In this case, the upload process populates all the tables that belong to a maintenance object. The input data file contains multiple types of records that are inserted into various tables. Each record is prefixed with the table name that is used as record type indicator.

## Multiple Data Files

The large volume of the converted data may require the extract to be split into multiple parts.

In this case the multi-part extract for a target staging Table or Maintenance Object is loaded with a multi-threaded batch run.

### Sample scenario:

10M of the Person records are being converted. The extract file is split into 10 files, PERSON1, PERSON2 PERSON3 etc., each file contains 1M records. All 10 files are uploaded to sFTP.

Batch process 'Load Person data' is submitted with 5 threads; each thread picks up 2 files and uploads the data into staging tables.

## Loading CLOB Data

The CLOB data can be loaded in two ways:

- Extracted as part of the main data file. This method is suitable for the relatively small CLOB data size. Refer to [Limitations](#) for more details.
- Extracted into a separate file. This method is suitable for larger CLOB data sizes and also for large volume tables or maintenance objects. In this scenario, the secondary file has to be uploaded at the same time as the primary data file.

## Notes on Secondary Data Files (CLOB Data)

Secondary data file is loaded simultaneously with the primary data file. The CLOB data extract should contain exactly the same number of records as a primary file.

---

### NOTE:

When splitting the extract into multiple data files, make sure that the numbers of extracted records in the primary and secondary files are matching.

It is applicable for both table-level and maintenance-object level load.

---

### Sample Scenario:

Table CI\_PER includes CLOB column CI\_PER\_DATA\_AREA. The CLOB field is used to store customer's resume.

The legacy table contain 10K records and the CLOB data is available for some of the records

The primary data file, CI\_PREM.csv contains 10K lines, one line per record

*The secondary data file, CI\_PREM\_CLOB, contains 10K records too. The records with the empty CLOB are represented by CLOB delimiter.*

<b>Primary File – Regular Data Fields</b>	<b>Secondary File - CLOB</b>
12345678,John,Doe,.....	John's resume <endclob>
45165609,Smith,Mary,.....	Mary Smith resume<endclob>
33336733,Brand,Brent,.....	<endclob>
06737482,Sunshine,Julie,.....	Julie Sunshine resume<endclob>

### Splitting single table data extract with CLOB

The following example illustrates how to split the single table large volume extract correctly if the CLOB data is supplied in the secondary file:

Assuming the table has 10K records, split into two equal parts. The following files should be created:

- Primary File 1 with 5K records
- Secondary File 1 with 5K CLOB entries
- Primary File 2 with 5K records
- Secondary File 2 with 5K CLOB entries

### Splitting maintenance object data extract with CLOB

The following example illustrates how to split the maintenance object large volume extract correctly if the CLOB data is supplied in the secondary file:

Assuming the maintenance object has two tables, one of the tables includes CLOB column and the primary table has 10K records. The data supposed to be split into two equal parts. The following files should be created:

- Primary File 1 with 5K records for the primary table and corresponding records for the child table
- Secondary File 1 with CLOB entries corresponding to the table in the Primary File 1

- Primary File 2 with 5K records for the primary table and corresponding records for the child table
  - Secondary File 2 with CLOB entries corresponding to the table in the Primary File 2
- 

**NOTE:**

For Maintenance Object-level load consider supplying CLOB data in the primary file, to avoid complicated logic of data splitting.

Refer to [CLOB Data - XML](#) for limitations concerning XML CLOB data

---

## File Layout and Data Formatting

The input data specifications for each table or maintenance object that are subject to conversion specification files are available for download. Refer to [Input and Output File Location](#) for details.

Specifications are generated based on the metadata and conversion configurations. Configurations control delimiters and enclosing characters and define CLOB data processing rules.

The data extract file is expected to contain one record per each target table row. The data field order in the record has to be exactly the same as it is listed in the specification file.

The specifications contain field-by-field data formatting rules for:

- Data type and size
- Date, DateTime and Time formatting
- Special notes on CLOB fields

The fields in the record are expected to be separated by a delimiter character (or string).

The CLOB data in the main record has to be enclosed in the CLOB Delimiter string, for example `<clobend>some clob data<clobend>`

For the not-nullable columns with no data, a single space enclosed in the enclosing character (or string) has to be supplied, for example “ “

Enclosing character (or string) can also be used to encapsulate data that includes a field delimiter, for example “*Hello, World*”

## Defining Custom Data Delimiters and Enclosing Characters

The default configurations are delivered with the base product.

Your entire legacy data or a specific table may require use of a different data delimiter and/or enclosing characters.

- Define new data delimiter string, CLOB delimiter string and/or enclosing string
- Configure Conversion Task Type using newly created delimiters
- Amend Conversion Master Configuration, setting default (for all tables or maintenance objects) or override (for specific table or maintenance Object) instructions.
- Regenerate Conversion Artifacts

Now you can create data extract according to the newly generated specifications.

## Input Data for a Staging Table

The extract for a single table contains delimited data records. Depending on the conversion configuration, the CLOB data should be supplied either inline or in a separate, secondary file.

### Input Data File Names

Input data file names has to follow the rules described in this chapter. The names are case-sensitive.

File Type	File Name
Single data file per table, no CLOB	File name equal target table name, i.e. CI_PREM
Single data file per table, CLOB data in secondary file	Primary file name equal target table name, i.e. CI_PREM Secondary file name composed as target table name concatenated with '_CLOB', i.e. CI_PREM_CLOB
Multiple data file per table, no CLOB	File name is composed as target table name concatenated with file number, i.e. CI_PREM1, CI_PREM2 etc
Multiple data file per table, CLOB data in secondary file	Primary file name is composed as target table name concatenated with numeric file number, i.e. CI_PREM1, CI_PREM2 etc Secondary file name composed as target table name concatenated with '_CLOB' and file number, i.e. CI_PREM_CLOB1, CI_PREM_CLOB2 etc

## Input Data for Maintenance Object

The extract for a maintenance object contains delimited data records for all tables included in the maintenance object. Depending on the conversion configuration, the CLOB data should be supplied either inline or in a separate, secondary files, one file per table containing CLOB. Refer to [Notes on Secondary Data Files \(CLOB Data\)](#) for limitations concerning XML CLOB data and more details.

### Input Data File Names

Input data file names has to follow the rules described in this chapter. The names are case-sensitive.

File names for Maintenance Object contain Maintenance Object Code. If the code includes spaces or special characters, it should be replaced with '\_', for example:

*For actual MO Code: SP/MTR HIST, in the file name, use SP\_MTR\_HST*

File Type	File Name
Single data file per Maintenance Object, no CLOB	File name equal target maintenance object name, i.e. PREMISE
Single data file per Maintenance Object, CLOB data in secondary file	Primary file name equal maintenance object name, i.e. PREMISE Secondary files name composed as maintenance object name concatenated with table name concatenated with '_CLOB'. For example, if CI_PREM table contains CLOB, the secondary file name is. PREMISE_CI_PREM_CLOB
Multiple data file per Maintenance Object, no CLOB	File name is composed as target maintenance object name concatenated with file number, i.e. PREMISE1, PREMISE 2 etc
Multiple data file per Maintenance Object, CLOB data in secondary file	Primary file name is composed as target maintenance object name concatenated with file number, i.e. PREMISE1, PREMISE 2 etc Secondary files name composed as maintenance object name concatenated with table name concatenated with '_CLOB' concatenated with file number. For example, if CI_PREM table contains CLOB, the secondary file name is. PREMISE_CI_PREM_CLOB1, PREMISE_CI_PREM_CLOB2, etc

## Limitations for Input Data

### Key Tables

Due to the technical limitations, the Key tables cannot be loaded in the multi-threaded mode. If you decided to create input data files using the Maintenance Object method, consider the following:

- Created data extract(s) for a Maintenance Object data, but exclude the Key table(s) and run data upload in the multi-threaded batches
- Create separate extract for the Key table(s) only and upload them in the single threaded batches.

### CLOB Data Size

The maximum size of the CLOB data included in the main data file is 10K. If you converted CLOB data size is expected to be larger than 10K, create secondary data file.

### CLOB Data - XML

The XML data formatted using new line character cannot be uploaded as part of the primary data file. If your CLOB data includes formatted XML, you should create secondary data file(s) for CLOB columns.

## Conversion Orchestration

This section provides information on orchestrating a data conversion.

## Input and Output File Location

Locations for conversion input and output files on the sFTP server:

- Upload input data files: **download/upload-download/conversion/upload**
- Download the process output: logs, discard and bad files: **download/upload-download/conversion/download**
- Download archived (processed) input data files: **download/upload-download/conversion/archive**
- Download input data specifications: **download/upload-download/conversion/reference**

## Understanding Load Data Process

The setup of the batch controls that is necessary to support data conversion and legacy data extract upload is described in [Data Load Batch Controls](#) .

The following sections explain the process of legacy data extract upload with SQL loader.

## Load Data Batch Run Parameters

The data upload batch is processing single target object – Table or Maintenance Object. The data extract may be supplied in one or multiple files, created and named according to the Input File instructions for [a Staging Table](#) and [Maintenance Object](#) .

The process is multi-threaded and optimized for the parallel load.

Using the batch parameters you can control:

- Level of logging
- Data extract retention

- Maximum number of load errors

## Multi-Threading

The process is threading by dividing the multiple data files between the threads. Each thread in turn, is processing its files one by one.

The exception is Key Tables. They are index-organized tables and have to be loaded in the single thread, due to the SQL Loader restrictions.

## Load Outcome – Log, Bad and Rejected Files

SQL Loader output files are available for download after each run . Refer to [Input and Output File Location](#) for details. To ensure file name uniqueness, the output file names are concatenated with the current timestamp.

- **Log file** contains the information about the run, including number of record processed, errors encountered and other useful information. The level of logging is controlled by the batch parameter *log* .
- **Bad and Rejected** files contains the records that were rejected by either the SQL Loader or the database.

## Interrupted Load

The data load process can be re-started. Once SQL Loader reached the maximum number of errors allowed for the run, it records the position of the last record in error in the log. The restarted load begins pulling the data from the file after skipping certain number of records.

In order to continue processing interrupted load, perform the following steps:

- Retrieve the log file. Find statement '*Specify SKIP=n when continuing the load.*' in the log file.
- Re-upload the input data file to the server
- Submit the batch once again, this time specifying the *n* as a *skip* batch parameter

## Tables Cleanup and Index Maintenance

The SQL Loader is running in parallel mode in order to maximize the performance. Therefore the target tables are not emptied prior to the data insertion and it has to be done implicitly, by running corresponding batch jobs.

Indexes are disabled during the data upload. The product provides batch processes that support index disabling/re-building and statistics update.

- User batch control **KI-SCLTB** to truncate tables in **Staging** area and batch control **KI-CLNTB** to truncate tables in **Production**
- Use batch control **KI-SDSIN** to disable indexes in **Staging** area and batch control **KI-DRPIN** to disable indexes in **Production**
- Use batch control **KI-CLNKY** to truncate **Key Reference** tables in **Staging** area

The supported scenarios are:

- **Truncate Specific Table or Maintenance Object:** In order to truncate the specific table, submit the corresponding batch job, specifying *table* parameter. In order to truncate the data that stored in a specific Maintenance Object, submit the corresponding batch job, specifying *maintenanceObject* parameter. The process will also disable indexes in the truncated tables.

---

**NOTE:** If the truncated table's metadata defines a Key table, the Key table gets truncated too.

---

- **Truncate all Converted Tables:** In order to truncate all converted tables run the corresponding batch job without specifying *table* or *maintenanceObject* parameters. The process will disable indexes and truncate all tables marked for conversion in the metadata.
- **Truncate Key Reference Tables for Specific Table or Maintenance Object:** In order to truncate Key Reference table linked to a staging table, submit the corresponding batch job, specifying *table* parameter. In order to truncate Key Reference tables for a specific Maintenance Object, submit the corresponding batch job, specifying *maintenanceObject* parameter.
- **Truncate all Key Reference Tables:** Submit the corresponding batch job without specifying *table* or *maintenanceObject* parameters to truncate all Key Reference tables.
- **Disable Indexes for Specific Table or Maintenance Object:** In order to disable indexes for the specific table, submit the corresponding batch job, specifying *table* parameter. In order to disable indexes for the specific Maintenance Object's tables, submit the corresponding batch job, specifying *maintenanceObject* parameter.
- **Disable Indexes for all converted Tables:** In order to disable indexes on all converted tables run the corresponding batch job without specifying *table* or *maintenanceObject* parameters. The process will disable indexes and truncate all tables marked for conversion in the metadata.

## Load Performance Tuning

The data specifics – volumes, structure and other aspects – may justify customizing the default configurations for all or some tables.

The SQL Loader is processing data according to the Control File. The fragment that contains general load parameters is stored as Managed Content that is referenced on the Conversion Task Type.

You can create new Managed Content, configure the Conversion Task Type and specify the new settings on Conversion Master Configuration, for all or specific Tables or Maintenance Objects.

## Understanding the Conversion Orchestration Process

The following sections provide information on general aspects of conversion orchestration.

### Enabling Conversion

Conversion activities are possible as long as conversion is enabled in the environment. The authorized Conversion Administrator may run the corresponding batch job to enable conversion.

### Switching between Staging and Production Schema

In the environment enabled for conversion, the online application is running against the database schema that contains synonyms pointing to either Staging or Production tables.

The synonyms could be switched by running the corresponding batch job.

The switching is possible only while Conversion is Enabled

Navigate to **Admin** → **Conversion Support** → **Switch Schema** to perform the action.

### Preparing for Conversion

The preparation steps include evaluating initial conversion configurations provided by the product, customizing the configurations if needed, and finally, generating conversion artifacts.

The preparation should be done when the environment is running against Production schema

## Conversion Development

The creation of the legacy data extract and rehearsal of the data load and subsequent conversion data processing is done while the environment is running against Staging schema.

Consider creating and scheduling the sequence of the batch processes for both data load and following validation and insertion.

Include table truncation, index maintenance and statistic updates into batch chains.

## Conversion Run

For the mock-up, or dress rehearsal or the actual go-live conversion run you may choose to amend data load batch controls for tables/maintenance objects to improve performance:

- Reduce the logging level – set *log* batch parameter to NOLOG
- Do not retain input data – set *retaininput* batch parameter to PURGE

## Disabling Conversion

After conversion is completed, the various activities such as table truncation and index maintenance should not be allowed.

Upon conversion project completion, switch the schema to Production and request that the authorized Conversion Administrator run the corresponding batch job to disable Conversion in the environment.

## Enabling Incremental Conversion

**The legacy data conversion may be done in stages. After the first chunk is converted and the system begins running in production, you may need to convert the next portion(s) of the data. This orchestration macro-scenario is called *incremental conversion*; it imposes certain limits and restrictions on the conversion activities and it has to be approved by the management.**

**If the incremental conversion has been approved , request that the authorized Conversion Administrator run the corresponding batch job to enable the incremental conversion in the environment.**

## Security Setup for Conversion

The services associated with data conversion are combined into the following user groups

- **Conversion Administrators** includes the services linked to the most sensitive database operations: enable/disable conversion and switching database synonyms between production and staging schema
- **Conversion Development** includes the services associated with conversion-related configurations
- **Conversion Operations** provides access to services associated with data load batch processes. This group could be extended to include services associated with specific table(s) or maintenance object data loads

These user groups are included in the base product. Your implementation may chose to use it as is or create a different setup.

## Conversion Reconciliation Reports

Your cloud service subscription includes an access to the BI Publisher instance that can be used to create and run data reports against both production and staging tables. Contact your Security Administrator for access information.



# Customer to Meter Administrative User Guide

---

## Customer to Meter Overview

### Customer to Meter Overview

Oracle Utilities Customer to Meter is a next generation customer service and billing application that incorporates a modern meter data management system. This system is designed to scale with mass smart meter volumes while handling the complexity associated with a utility's processes across multiple types of service, operating divisions, and jurisdictions. The new application components allow for traditional scalar meter functionality that is equivalent to prior versions of Oracle Utilities Customer Care and Billing; so, it can accommodate the many types of utility environments, and evolve with the business to include more advanced digital requirements.

The roles for each application area in Oracle Utilities Customer to Meter are defined as follows:

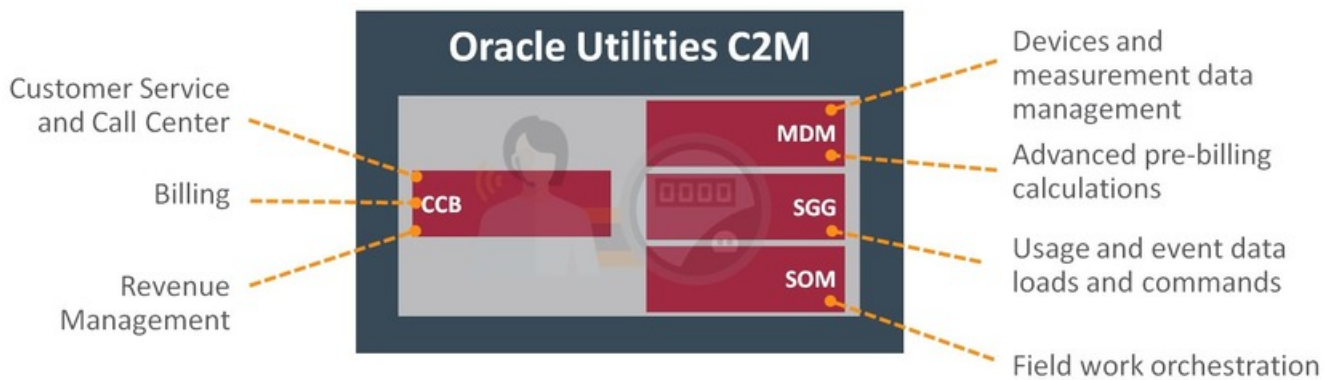

The application components have internal integration for master, admin, and transactional data. The primary transactions between them are for bill determinant processing with MDM and service order processing with SOM. These transactional processes can be initiated by the CCB solution, or from other external systems.

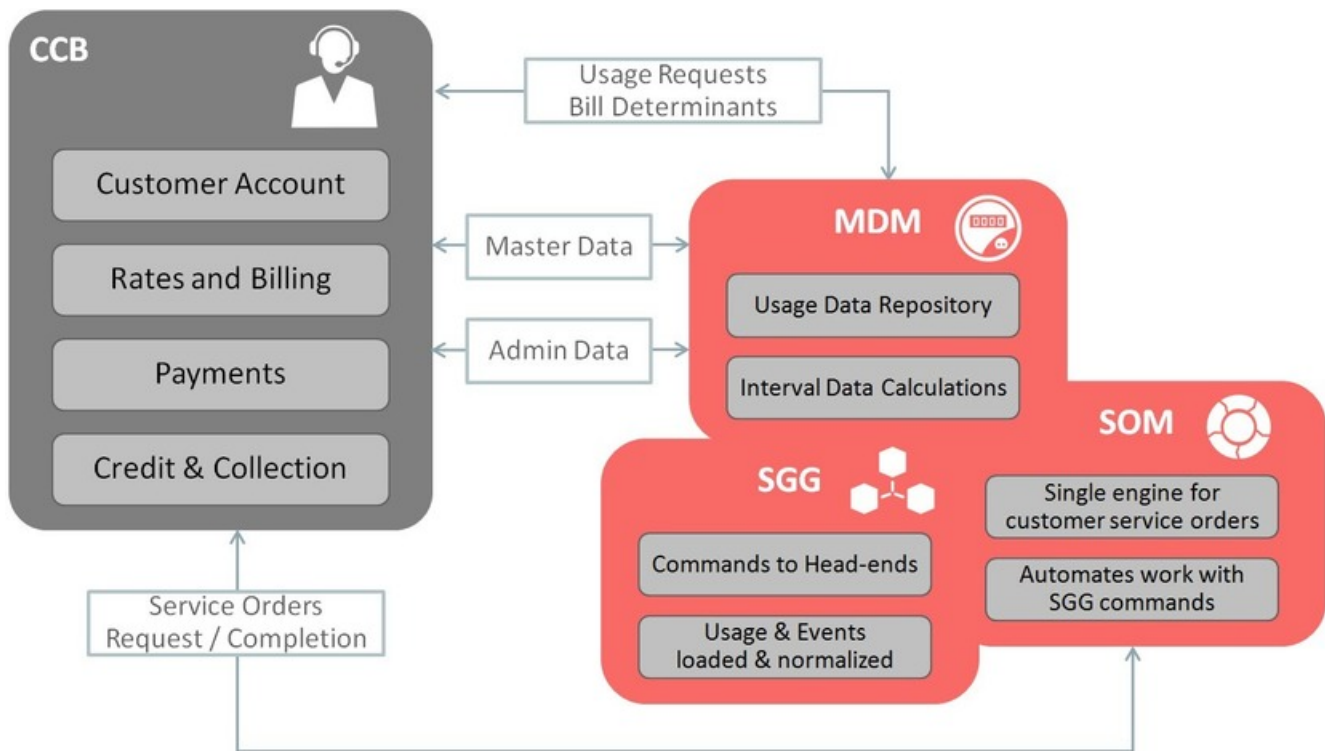

In addition, Oracle Utilities Customer To Meter can also include asset management functionality via Oracle Utilities Operational Device Management which provides the ability to handle large volumes of assets and to manage the receipt, installation, maintenance, tracking and removal of those assets.

## Meter Data Management Best Practices

### Performance Recommendations

#### Initial Measurement Loading Recommendations

- In general, keep the number of devices to 1,000 per file for optimum usage and event processing through OSB. A lower number of devices, per file, will take more time for processing. A higher number of devices, per file, leads to high growth in garbage collection leading to waits and results in lower throughput. Please note, the optimum number of transactions per file may vary by head-end system.
- Initial measurement payloads should have very selective criterion to get to the exact measuring component (MC). In an ideal case, it should be the MC identifier along with device serial number. If this is not provided, then the UOM/TOU/SQI configured on the MC type is used to retrieve the exact business object (BO) from the Service Provider which might have the same values for multiple channels.
- Populating the raw data section of the IMD record will reduce overall throughput

#### VEE Recommendations

- For the High-Low VEE Rule, the historic pre window should be set as low as possible based on business needs. This rule has an intensive hit on performance of the Initial Measurement loading process.

- Each VEE Rule included in VEE processing can have an impact on overall performance. The table below summarizes the relative costs in terms of performance for several commonly used VEE Rules. Using this table when designing your VEE groups and rules can help identify potential performance challenges.
- For example, using "Minimal Impact" rules will likely have little to no significant impact on performance, while using several "Moderate Impact" rules could result in performance challenges, and using the High Low Check rule is very likely to introduce noticeable impacts to VEE processing performance.

Relative Cost	VEE Rules
Minimal Impact (0% - 5%)	Interval Interpolation Interval Replacement Rule Interval Size Validation Interval Spike Check Negative Consumption Check Scalar Replacement Rule UOM Check
Moderate Impact (5% - 20%)	Final Measurement Validation Interval Adjustment From Scalar Interval Averaging Multiplier Check Scalar Calculation From Interval Scalar Proration Sum Check
Significant Impact (20%)	High/Low Check

- Consumption sync processes should only be run on devices where the difference in consumption is outside the defined tolerance as dictated by the sum check tolerance. In a production environment, running consumption sync for two percent of devices or less is advisable.
- Using Scripting for simple VEE Rules is approximately 10% more expensive than a similar Java rule.
- Run performance testing on all configuration changes performed that impact portions of Oracle Utilities Meter Data Management with high transactional processing.
- Any VEE Rules, whether provided as part of base product or custom developed, should be configured to query no more than 30 cumulative days of historical data (i.e. High/Low) to help optimize the data loading process
- A good way to troubleshoot a VEE Rule is to use the Trace section of the IMD Log. When an IMD is in Pending status, the **Trace On** button can be used to trace all VEE Rules fired during IMD processing. Once processing is complete, view the Log tab of the IMD and review the results in the **IMD Trace Log** section. For any custom developed VEE Rules, the average run time should be no longer than the average run time of other base product VEE Rules. Also, the impact of different configuration can be checked through this method as well.

## Usage Transaction Recommendations

- Saving derived interval data and sending the data to an external system via the "Save Interval Vector" and "Extract Interval Data" options on the "Vector and Service Quantity Math" and "Get Interval Data" usage calculation rules can have a noticeable impact on usage transaction processing. Usage transaction processing can be improved by up to 45% if extraction of interval data is eliminated. Use of these options should be limited to situations in which they are absolutely required.
- For Outbound Messages, the schema extraction for usage transactions should be converted into a RAW string operation to allow for more efficient Pre-Processing logic.

## User Interface Recommendations

- For better performance, user interface zones should be initially collapsed when not required for 90% or more of business processes. The initial state of zones (collapsed or not) can be controlled via the "Portal Preferences" tab on the **User** portal.
- The number of records returned to the user interface for a zone should be limited to 50 rows when building custom zones against large transactional tables.
- UI Map schemas should be specific to the displayed data. This will make sure that application will not visit all the elements that are not required for display.
- A good way to troubleshoot a screen in the user interface is to go to the **Preferences** in the top right hand corner of the application and choose the **Portal Preferences** tab. Choose the appropriate portal and set all zones to "Initially Collapsed". Next, navigate back to the screen that has performance issues, expand the zones one by one, and measure the execution time of each zone. This should be an accurate step-by-step representation of the full screen execution. This testing is especially important for **custom** user interfaces.
- For optimal user interface performance, Oracle Utilities Meter Data Management users should ensure their computer set to **high performance mode** so all CPU resources are used. Also, check if allocating additional memory through your browser's default settings helps improve performance.

## SQL Recommendations

- Avoid making unbounded SQLs statements with no boundary condition on date columns.
- Reduce CLOB searches and use physical columns wherever possible.
- Implement caching to pre-fetch data instead of issuing multiple SQLs.

## Java Recommendations

1. For areas where the transactional volume is high (such as Initial Measurement), use Hibernate SQL for non-CLOB fields whenever possible as opposed to reading entire Business Object. If a CLOB field must be retrieved, then either Entity or Lite BO should be used. Reading the full Business Object should be used as the last resort for high volume areas. This process should be considered for updating data as well when it provides the same functionality as updating the Business Object. These methods should only be considered if BO level validations, pre-processing, and post-processing aren't required.
2. For a simple SQL select statement needed in Java (not many joins and no complex logic), using Hibernate SQL provides a benefit over using a Business Service and a Zone since the entities are cached for Hibernate SQL.
3. "Lite" Business Objects are provided as a way to access the main fields for a BO without pulling back all of the information. Retrieving less information will speed up the process for reading the BO.

## Referencing Master Data by Identifiers

### Understanding Referencing Master Data by Identifiers

There are many places within admin configuration where direct references to master data can be made. Since master data relies on system generated keys this configuration often breaks once migrated to a new environment since the master data referenced does not exist in the target environment. To alleviate this issue, in each of these instances, a user defined identifier can be used instead of the system generated keys.

This has an added benefit for installations that support multiple time zones by enabling the identification of the master data to not only search by the user defined identifier but also the time zone of the instance data. This is advantageous because it allows one set of admin configuration to satisfy master data in multiple time zones since things like TOU Maps and profile measuring components will be identified at run time using the identifier and time zone.

The following types of data can be referenced by an identifier on admin configuration:

- **Device:** can be referenced by a device identifier type. An example of this can be seen on the Specification Lookup (D1-SpecificationLookup) extendable lookup.
- **Measuring Component:** can be referenced by a measuring component identifier. When multiple time zone support is enabled the measuring component's time zone will also be evaluated. There are two major patterns for this:
- *Profile Factors:* The profile factor itself will reference the measuring component by identifier and then the admin configuration will point to the profile factor. An example of this is the profile factor list on interval measuring component types.
- *Direct Measuring Component references:* An example of this is the Final Values Overlay Profile (D1-FinalValuesOverlayProfile) extendable lookup.
- **TOU Map:** can be referenced by the TOU map template code. The appropriate TOU map is then found by searching for the appropriate TOU map that references a TOU map type for the supplied TOU map template. When multiple time zone support is enabled the TOU map type time zone will also be evaluated. An example of this is the default TOU map that can be configured in the display profile of a measuring component type.

During execution the identifier supplied will be used to find the appropriate master data entry. The following validation will occur:

**When multiple time zone support is off:** the search must find one and exactly one master data entry for the identifier type and value.

**When multiple time zone support is on:** the search must find one and exactly one master data entry for the identifier type, identifier value, and time zone. Note: some installations may want to use master data across time zones, this can still be achieved by supplying one and only one master data entry for the identifier type and value:

When the search fails to find the master data for the identifier type, identifier value, and time zone and there is only one entry for the identifier type and value that master data will be used (thus allowing one master data entry to be used across time zones)

When the search fails to find the master data for the identifier type, identifier value, and time zone and there are multiple entries for the identifier type and value an error will be encountered.

## Recommendations for Creating a Production Environment

Oracle recommends that you do not clone the demonstration environment as a basis for a new production environment. The demonstration environment typically includes transactional data that will be irrelevant to your production environment and can cause unexpected issues if it is not purged correctly. The recommended process is to start a new production environment from a new installation and migrate "clean" system data (such as business objects and algorithms) and administrative data (such as sample activity types or other administrative entities) from the demonstration and/or test or development environments as applicable.

Your implementation can use bundling and/or the Configuration Migration Assistant to move system and administrative data. Instructions for using these tools are contained in the [Bundling](#) and [Configuration Migration Assistant](#) sections in the Oracle Utilities Application Framework *Administrative User Guide*.

Contact [Oracle customer support](#) if further assistance is required.

## Additional Resources

## How to Get Support

Oracle is deeply committed to technical support services for its products. The Oracle Support online portal provides a reliable, easy-to-use method for obtaining technical support for Oracle Utilities Meter Data Management. To register as a new user for Oracle Support, go to <https://support.oracle.com> and follow the steps shown on the screen.

Oracle policies for standard technical support services are available at <http://www.oracle.com/us/support/policies/index.html>.

## Knowledge Base Articles

Once you have access to Oracle Support, finding Knowledge Base articles is an easy process.

1. Log in to <https://support.oracle.com>.
2. Select the **Knowledge** tab at the top of the Oracle Support portal.
3. Under the Knowledge Base section, type "**Oracle Utilities Meter Data Management**" as the product.
4. Enter key search topics into the **Enter search terms** box.
5. Click **Search**.

The search results will display all knowledge articles stored on Oracle Support related to Oracle Utilities Meter Data Management for your key topics.

## Important Articles

While there is a vast library of important Knowledge Base articles on Oracle Support, the list below highlights a few of the key knowledge articles that should be helpful if you're looking for additional detailed information about Oracle Utilities Meter Data Management:

Article Name	Knowledge Base Article Number
Information Center: Meter Data Management and Smart Grid Gateway Version 2	1907636.2
Related Measuring Component Consumption Sync White Paper	1672461.1
Overview and Guidelines for Managing Business Exceptions and Errors	1628358.1

(this document was created by the CC&B team but pertains to MDM as well)

## Support Hot Topic Emails

Oracle Support provides a way to receive daily or weekly updates on new information posted for Oracle Utilities Meter Data Management.

1. Log in to <https://support.oracle.com>.
2. Select the **Settings** tab at the top of the Oracle Support portal. (Note: this tab may be hidden for you and may require clicking a dropdown on the right side of the tabs)
3. Once on the Settings screen, choose the **Hot Topics E-mail** from the set of options on the left.
4. Under Delivery Options, choose **Send With Selected Options**.
5. Choose your delivery frequency: either Daily or Weekly.

6. Add content which interests you: there are a number of options available. To subscribe to updates for Oracle Utilities Meter Data Management, hit the **Add...** button under Selected Products. Enter "Oracle Utilities Meter Data Management" for the Product then choose the types of information for which you'd like to receive an email.
7. Make sure you click **Apply** at the bottom once you've made all of your selections.

## Embedded Help

Oracle Utilities Meter Data Management, like all Oracle Utilities Application Framework applications, provides extensive internal documentation. For example, detailed descriptions of system objects are included in the objects' maintenance portals. The lifecycle of each business object is described on the Lifecycle tab and depicted in flow diagrams on the Summary tab. This information is extremely useful for implementers and system administrators.

Embedded help is provided for all non-obvious fields in most portals and zones. If a field has associated help text, a question mark icon appears next to the field when the zone is displayed.

## Leveraging Demonstration Data

One of the best ways to understand Oracle Utilities Meter Data Management is through a thorough review of the demonstration data (also referred to as "demo data") provided by Oracle. The demo data for Oracle Utilities Meter Data Management provides the following:

- An overall view of how to implement the product for common needs
- Examples of the productized solutions to solve key utility scenarios
- Some examples of adding "customer modifications" on top of Oracle Utilities Meter Data Management

This demo data can be downloaded along with the Oracle Utilities Meter Data Management. It's recommended that this be installed into an isolated environment for reference purposes separate from other development or testing environments.

Once installed, the demo data scenarios can be found in two places within Oracle Utilities Meter Data Management:

- A zone named **Demo Scenarios** is shown in the right side Dashboard. This provides a quick method to link to the 360 Degree View for the specific demo meter.
- An extendable lookup named **Demo Scenarios Catalog** describes each of the scenarios in detail. This matches the scenarios displayed in the Demo Scenarios zone.

**NOTE:** Oracle recommends that you do not clone the demonstration environment as a basis for a new production environment. The demonstration environment typically includes transactional data that will be irrelevant to your production environment and can cause unexpected issues if it is not purged correctly. The recommended process is to start a new production environment from a new installation and migrate "clean" system data (such as business objects and algorithms) and administrative data (such as sample activity types or other administrative entities) from the demonstration and/or test or development environments as applicable. Instructions for using these tools are contained in the [Bundling](#) and [Configuration Migration Assistant](#) sections in the Oracle Utilities Application Framework *Administrative User Guide*.

## Customer User Groups

A number of Customer User Groups have been established (one in the United States and others internationally) that are specific to sharing best practices and learnings about Oracle Utilities Meter Data Management and Oracle Utilities Smart Grid Gateway (SGG). If you're interested in participating in a Customer User Group, contact the appropriate Product Manager.

# Customer To Meter Configuration

Oracle Utilities Customer to Meter employs functionality from Oracle Utilities Customer Care and Billing, Oracle Utilities Meter Data Management, and (optionally) Oracle Utilities Operational Device Management. While much of the configuration of the application is very similar to that used with the individual applications, the merging of functions requires some configuration that is unique to Customer To Meter.

This chapter describes topics specific to configuring Customer To Meter to support a seamless integration between Customer Care and Billing, Meter Data Management, and Operational Device Management functionality.

## Customer To Meter Master Configuration

The Customer To Meter (C2M) master configuration provides a single point of access for configuration information related to consolidated data maintenance, data mapping, and other master configurations used with Customer To Meter.

To open the master configuration, select **Admin > General > C2M Configuration**. The master configuration opens in the **C2M Configuration** portal.

The **External System** field references the external system used for communication between Customer Care and Billing, Meter Data Management, and Operational Device Management including data synchronization requests, Service Order Management (SOM) queries, etc.

### C2M Consolidated Maintenance

The **C2M Consolidated Maintenance** section documents objects that use some form of consolidated maintenance in Customer To Meter.

**Merged Maintenance** references the extendable lookup used to configure [Merged Maintenance](#). Click **Joint Maintenance Lookup** to view values for this extendable lookup.

The **Consolidated Maintenance Objects** table lists objects that use [Master Data Synchronization](#) and [Data Audit Maintenance](#) for consolidated maintenance. Click on an object's name to view its maintenance object.

### C2M Mapping

The **C2M Mapping** section lists objects used to map data between Customer Care and Billing and Meter Data Management.

**SA Type Mapping** references the extendable lookup used to map Customer Care and Billing service agreement (SA) types to Meter Data Management usage subscription types. Click **C2M SA Type Mapping Values** to view values for this extendable lookup.

The table lists fields that use [Lookup Value Mapping](#) to map values between Customer Care and Billing and Meter Data Management. Click the Description link to view and/or edit mapping values for a specific field. A plus sign (+) indicates that mapping values have not been defined for that field. Click the icon to configure values for that field.

### MDM—ODM Mapping

The **ODM—MDM Mapping** section lists objects used to map data between Meter Data Management and Operational Device Management.

The table lists fields that use [Lookup Value Mapping](#) to map values between Meter Data Management and Operational Device Management. Click the Description link to view and/or edit mapping values for a specific field. A plus sign (+) indicates that mapping values have not been defined for that field. Click the icon to configure values for that field.



## Related Master Configurations

The **Related Master Configurations** section lists other master configurations used with Customer To Meter, including:

- Master Data Synchronization Configuration
- Seeder Sync Request Master Configuration
- Service Order Management Master Configuration
- Service Order Management Integration

Click the **Master Configuration** link to view a specific master configuration.

## Customer to Meter Consolidated Maintenance and Data Mapping

Oracle Utilities Customer to Meter uses data from Oracle Utilities Customer Care and Billing, Oracle Utilities Meter Data Management, and (optionally) Oracle Utilities Operational Device Management. This chapter describes how data used by these applications can be maintained through a consolidated maintenance process, and how data in each application is mapped to similar data in other applications..

There are several types of consolidated maintenance and data mapping used by Customer to Meter, including:

- Merged Maintenance: maintenance of data in applications through use of a single portal.
- Master Data Synchronization: master data used by the applications is kept synchronized when data is created or updated.
- Data Audit Maintenance: creating specific types of Meter Data Management data triggers creation of corresponding Customer Care and Billing data via Audit algorithms
- Lookup Value Mapping: lookup values used by one application are mapped to corresponding values in other applications via extendable lookups
- Transactional Data Mapping: creating specific types of transactional data in one part of Customer to Meter triggers the creation of corresponding transactions in other parts.

## Merged Maintenance

Merged maintenance allows data in multiple product—specific maintenance objects to be updated via a single maintenance portal.

### Administrative Data Merged Maintenance

Merged maintenance is used with several types of administrative data in Customer Care and Billing and Meter Data Management that are used in nearly identical ways in both applications. These include:

- Service Type
- SP Type (Service Point Type)
- Service Quantity Identifier
- Time of Use
- Unit of Measure

When a user creates or updates data of these types, the maintenance portal displays a superset of data elements from product-specific business objects based on a “superset” service script (defined in the Joint Maintenance Lookup extendable lookup (see below)). When the data is saved, the corresponding maintenance objects in Customer Care and Billing, Meter Data Management, and Operational Device Management are updated. For example, when a user navigates to the **Unit of Measure** portal and selects a record to update, the portal displays a combination of data from the X1-UnitOfMeasure and

D1-UnitOfMeasure business objects. When the user saves the data, the changes are saved to both the UOM Customer Care and Billing maintenance object and the D1\_UOM Meter Data Management maintenance object.

---

**NOTE:** Service Point Types (asset location types) are also used by Operational Device Management.

---

## Service Point Merged Maintenance

In addition to the above types of administrative data, Customer to Meter service points are also maintained through merged maintenance. Service point merged maintenance does NOT make use of a “superset” service script, but does use product-specific business objects. Oracle Utilities Customer to Meter service points (asset locations in the case of Operational Device Management) are maintained through these product-specific business objects and extendable lookups.

The Customer to Meter base package uses the following service point business objects:

- Meter Data Management: X1D-ServicePoint
- Customer Care and Billing: X1-ServicePoint
- Operational Device Management: W2-ServicePoint

When a Customer to Meter service point is created or updated, the “Maintain CCB Service Point” (X1-CCBSPMNT) and “Maintain ODM Service Point” (X1-ODMSPMNT) Pre-Processing algorithms on the X1D-ServicePoint business object uses the C2M Mapping Field Values (X1-CCBMDM-MDMCCB-Lookup) and ODM-MDM Mapping Field Values (X1-ODMMDM-MDMODM-Lookup) extendable lookups to map lookup values between Customer Care and Billing and Meter Data Management and between Meter Data Management and Operational Device Management, and creates or updates an instance of the X1-ServicePoint and W2-ServicePoint business objects (which are used to update the their corresponding maintenance objects).

---

**NOTE:** Customer to Meter service point types should reference the “Service Point — MDM” (X1D-ServicePoint) business object.

---

## Joint Maintenance Extendable Lookup

The specific business objects and service scripts used by merged maintenance are defined in the Joint Maintenance Lookup (X1-JointMaintenance) extendable lookup. Records in this extendable lookup define the superset script that contains the union of the elements of the objects that exist in Customer Care and Billing and Meter Data Management, as well as the corresponding product-specific business objects.

Merged maintenance lookup values are defined by the following:

- **CCB Maintenance Object:** the unique identifier for the joint maintenance lookup value
- **Superset Script:** the superset script that contains the union of the elements of the objects that exists in Customer Care and Billing and Meter Data Management. Used for administrative data maintenance only.
- **CCB Business Object:** the business object used to update the Customer Care and Billing maintenance object
- **MDM Business Object:** the business object used to update the Meter Data Management maintenance object
- **ODM Business Object:** the business object used to update the Operational Device Management maintenance object

## Customer To Meter Master Data Synchronization

This section describes the master data synchronization processes supported by Oracle Utilities Customer to Meter.

In Customer to Meter, Customer Care and Billing information is generally considered the data of record for account, customer, or service agreement-related data. Synchronizing master data between Customer Care and Billing tables and Meter Data Management tables ensures that all account, customer, and service point-related data is correct and up to date before usage transaction calculations are performed. Master data synchronization ensures that when specific types of Customer Care and Billing data are created or updated, corresponding Meter Data Management data is also created or updated.

The table below summarizes the types of data master data synchronization supported in Customer to Meter:

<b>When Customer Care and Billing data of this type is created and/or updated:</b>	<b>Master Data Synchronization creates and/or updates this type of Meter Data Management data:</b>
Bill Cycle / Bill Cycle Schedule	Bill Cycle / Bill Cycle Schedule
Contract Option	Dynamic Option
Contract Option Event	Dynamic Option Event
Person	Contact
Service Agreement	Usage Subscription

For example, when a Customer Care and Billing Service Agreement is created, the synchronization process creates a corresponding Meter Data Management usage subscription.

**NOTE:** Master data synchronization is a one-way process. When Customer Care and Billing data is created or updated, corresponding Meter Data Management data is created or updated, but changes made to Meter Data Management data are NOT synchronized to the Customer Care and Billing data. As a general rule, changes to the types of data outlined above should be made in the Customer Care and Billing entities instead of their Meter Data Management counterparts.

The Customer to Meter synchronization process is based on the [Data Synchronization](#) functionality of the Oracle Utilities Application Framework, and is supported through a set of maintenance objects, master configurations, business objects, and service scripts.

## Maintenance Objects

Customer to Meter supports master data synchronization for the following maintenance objects.

<b>Customer Care and Billing Maintenance Object</b>	<b>Meter Data Management Maintenance Object</b>
BILL CYCLE (Bill Cycle)	D1-BILLCYCLE (Bill Cycle)
CONTRACT OPT (Contract Option)	D1-DOP (Dynamic Option)
CONTRACT OPT (Contract Option Event)	D1-DOPEVT(Dynamic Option Event)
PERSON (Person)	D1-CONTACT (Contact)
SA (Service Agreement)	D1-(Usage Subscription)

## Master Configurations

The following master configurations are used to configure the sync process between Customer Care and Billing data and Meter Data Management data:

<b>Master Configuration</b>	<b>Name / Description</b>
Master Data Synchronization Configuration	Lists all foreign key references that need resolution. Each one should reference the view that contains the external key / production key cross-reference. If initial synchronization process are also configured for data conversion in addition to the ongoing synchronization process, two views are specified. For entities that undergo the ongoing synchronization, an external system / ID type mapping is specified to cater for entities that might be synchronizing from more than one external system.
Seeder Sync Request Master Configuration	Lists the maintenance objects (contact, usage subscription, etc.) that require synchronization. Each references the synchronization business object that needs to be instantiated when processing a synchronization request for that

maintenance object. For maintenance objects that undergo both initial and the ongoing synchronization, two business objects are specified.

---

---

## Outbound Data Synchronization Business Objects

When data is created for one of the above Customer Care and Billing maintenance objects, an outbound synchronization request is created to create the appropriate Meter Data Management data.

Synchronization of Customer Care and Billing data and Meter Data Management data uses the following outbound synchronization business objects:

Data Sync	Object Name	Business Object
Bill Cycle/Schedule > Bill Cycle/Schedule	MDM2 Bill Cycle Sync Request	C1-MDM2BillCycleSyncRequest
Contract Option > Dynamic Option	MDM2 Contract Option Sync Request	C1-MDM2ContractOptSyncRequest
Contract Option Event > Dynamic Option Event	MDM2 Contract Option Event Sync Request	C1-MDM2ContrOptEvtSyncRequest
Person > Contact	MDM2 Person Sync Request	C1-MDM2PersonSyncRequest
Service Agreement > Usage Subscription	MDM2 SA Sync Request	C1-MDM2SASyncRequest

## Inbound Data Synchronization Service Scripts

When outbound synchronization requests enter the “Send Request” state, Enter algorithms invoke service scripts to create corresponding inbound data synchronization requests.

Synchronization of Customer Care and Billing data and Meter Data Management data uses the following inbound data synchronization service scripts:

Data Sync	Name	Service Script
Bill Cycle/Schedule > Bill Cycle/Schedule	Bill Cycle Inbound Sync Request	X1-InBCSynSS
Contract Option > Dynamic Option	Inbound Dynamic Option Sync	X1-InSyDyOp
Contract Option Event > Dynamic Option Event	Inbound Dynamic Option Event Sync	X1-InSyDyOpE
Person > Contact	Inbound Contact Sync	X1-InSyCont
Service Agreement > Usage Subscription	Inbound Usage Subscription Sync	X1-InSyUS

## Inbound Data Synchronization Business Objects

When outbound synchronization requests enter the “Send Request” state, service scripts create corresponding inbound data synchronization requests. Master data synchronization uses two types of inbound synchronization requests:

- **Initial Synchronization Requests:** Initial synchronization requests are used during initial data conversion to facilitate creation of bill cycles/bill cycle schedules, dynamic options, dynamic options events, contacts, and usage subscriptions in Meter Data Management based on corresponding data in Customer Care and Billing. See [Initial Data Synchronization](#) for more information about initial synchronization requests
- **Ongoing Synchronization Requests:** Ongoing synchronization requests are used to continuously keep Meter Data Management data synchronized with corresponding Customer Care and Billing data. Ongoing synchronization requests can be used to maintain contacts, usage subscriptions, dynamic options, and bill cycles.

Ongoing synchronization of Customer Care and Billing data and Meter Data Management data uses the following data synchronization business objects:

Data Sync	Ongoing Synchronization Object Name	Business Object
Bill Cycle/Schedule > Bill Cycle/Schedule	Inbound Bill Cycle Sync Request	D2-InboundBillCycleSyncRequest
Contract Option > Dynamic Option	Dynamic Option Ongoing Sync Request	D2- OngoingSyncRequestDynOpt
Contract Option Event > Dynamic Option Event	Dynamic Option Event Ongoing Sync Request	D2- OngoingSyncRequestDynOptEvt
Person > Contact	Contact Ongoing Sync Request	D1-OngoingSyncRequestContact
Service Agreement > Usage Subscription	Usage Subscription Ongoing Sync Request	D2-OngoingSyncRequestUS

## Example Synchronization Process Steps

This section provides an overview of the processing that takes place when an ongoing synchronization request is sent. For each step in the process, the table below provides a brief description of the processing that takes place, and lists the specific objects involved.

Step	Process	Objects
1	Data in Customer Care and Billing is created or changed, triggering a synchronization request.  For example, a service agreement is updated, and the corresponding usage subscription must be updated.	
2	An outbound synchronization request is created.	Outbound Synchronization Request business object:  C1-MDM2SASyncRequest
3	When the synchronization requests enters the "Send Request" status, an Enter algorithm invokes the inbound synchronization service script to create an inbound sync request.	Inbound Synchronization Service Script:  X1-InSyUS
4	The service script creates the appropriate inbound synchronization request. In this case, it's an ongoing synchronization request.	Inbound Synchronization Request business object:  D2-OngoingSyncRequestUS
5	For ongoing synchronization requests, the following steps are performed by Enter algorithms on the synchronization request business object lifecycle states: <ul style="list-style-type: none"> <li>Data Transformed/Basic Schema Validated</li> <li>Determine Sync Request BO</li> <li>Setup Transformed Data</li> <li>Pre-Added</li> </ul>	Setup Transformed Data Algorithm: D1- SETTRANDT Sync Request Pre-Add Data Algorithm: D1-SR-PREADD Resolve Keys - Ongoing Sync Algorithm: D1-RESKEYFAL Sync Request Update Data Algorithm: D1- SR-UPDDAT

- Sync Request Pre-Add Data
- FKs Resolved
- Resolve Keys - Ongoing Sync
- Updating
- Sync Request Update Data

## Initial Data Synchronization

This section describes the initial master data synchronization processes supported by Oracle Utilities Customer to Meter.

Initial data synchronization is used during initial data conversion to facilitate creation of data in Meter Data Management based on corresponding data in Customer Care and Billing. After creating bill cycles/schedules, contract options, contract option events, persons, and service agreements in Customer Care and Billing, initial data synchronization can be used to create corresponding bill cycles/schedules, dynamic options, dynamic options events, contacts, and usage subscriptions in Meter Data Management.

Initial data synchronization uses the same maintenance objects, master configurations, outbound synchronization request business objects, and service scripts as ongoing data synchronization (see [Customer to Meter Master Data Synchronization](#) for more information about these objects).

## Inbound Initial Data Synchronization Business Objects

Initial synchronization of Customer Care and Billing data and Meter Data Management data uses the following data synchronization business objects:

Data Sync	Initial Synchronization Object Name	Business Object
Bill Cycle/Schedule > Bill Cycle/Schedule	Inbound Bill Cycle Sync Request	D2-InboundBillCycleSyncRequest
Contract Option > Dynamic Option	Dynamic Option Initial Sync Request	D2- InitialSyncRequestDynOpt
Contract Option Event > Dynamic Option Event	Dynamic Option Event Initial Sync Request	D2- InitialSyncRequestDynOptEvt
Person > Contact	Contact Initial Sync Request	D1-InitialSyncRequestContact
Service Agreement > Usage Subscription	Usage Subscription Initial Sync Request	D2-InitialSyncRequestUS

## Initial Synchronization Request Batch Controls

Batch controls perform processing for initial synchronization requests such as allocating keys to data, resolving foreign keys, and loading data.

"Initial Sync Request - Resolve Keys XXX" batch controls invoke a generic maintenance object transition process to invoke the "Resolve Keys - Initial Sync" algorithm for synchronization requests of the appropriate type. Parameters used by "resolve keys" batch controls include:

- **Maintenance Object:** (Required) the maintenance object (contact, usage subscription, etc.) to be processed. This must be set to the Sync Request maintenance object for the batch control (contact for contact synchronization requests, usage subscription for usage subscription synchronization requests, etc.)
- **Restrict By Batch Code:** Restricts processing to synchronization requests whose current state is linked to this batch code.
- **Restrict By Business Object:** Restricts processing to synchronization requests linked to this business object.
- **Restrict By Status Code:** Restricts processing to synchronization requests of this status (default: KEY\_ALLOCATD).

- **Max Errors:** Specifies the maximum number of errors allowed before the process exits.

"Initial Sync Request - Load Data XXX" batch controls load data (created new instances of business objects) for requests of the appropriate type (contact, usage subscription, etc.). Parameters used by "load data" batch controls include:

- **Maintenance Object:** (Required) the maintenance object (contact, usage subscription, etc.) to be processed. This must be set to the Sync Request maintenance object for the batch control (contact for contact synchronization requests, usage subscription for usage subscription synchronization requests, etc.)
- **Restrict By Batch Code:** Restricts processing to synchronization requests whose current state is linked to this batch code.
- **Restrict By Business Object:** Restricts processing to synchronization requests linked to this business object.
- **Max Errors:** Specifies the maximum number of errors allowed before the process exits.

The table below lists the batch controls used by initial synchronization requests:

Batch Code	Name / Description
D1-SIIER	Initial Sync Request - Error
D1-SILCN	Initial Sync Request - Load Data Contact
D1-SILUS	Initial Sync Request - Load Data US
D1-SIKCN	Initial Sync Request - Resolve Keys Contact
D1-SIKUS	Initial Sync Request - Resolve Keys US
D2-SIKUS	Initial Sync Request - Resolve Keys US
D2-SILUS	Initial Sync Request - Load Data US

## Batch Control Scheduling

The following table specifies the order in which the batch controls on the Initial Sync Request BO life cycle should be executed. The first row identifies the maintenance object for which the synchronization request is intended and the first column specifies the type of process.

	Contact	Usage Subscription	Dynamic Option	Dynamic Option Event	Bill Cycle/Schedule
Transformation / Schema Validation Job	1	1	1	1	1
Key Allocation Job	2	2	2	2	2
Foreign Key Resolution / BO Validation Job (dependent on ALL Key Allocation Jobs finishing)	3	7	3	5	5
Load Job	4	8	4	6	6

Note that before the Key Resolution job is run, all the Key Allocation Jobs need to finish. This ensures that all foreign key references can be subsequently resolved.

Some business object-level validation is dependent on other entities being completely loaded first. The sequence numbers above allow for this. For example, usage subscriptions business object validation is dependent on contacts existing; Dynamic Option Event business object validation is dependent on Dynamic Options existing.

## Example Initial Synchronization Process Steps

This section provides an overview of the processing that takes place when an initial synchronization request is sent. For each step in the process, the table below provides a brief description of the processing that takes place, and lists the specific objects involved.

Step	Process	Objects
1	Data in Customer Care and Billing is created or changed, triggering a synchronization request.  For example, several service agreements are created , and corresponding usage subscriptions must be created.	
2	An outbound synchronization request is created.	Outbound Synchronization Request business object:  C1-MDM2SASyncRequest
3	When the synchronization requests enters the "Send Request" status, an Enter algorithm invokes the inbound synchronization service script to create an inbound sync request.	Inbound Synchronization Service Script:  X1-InSyUS
4	The service script creates the appropriate inbound synchronization request. In this case, it's an ongoing synchronization request.	Inbound Synchronization Request business object:  D2-InitialSyncRequestUS
5	For initial synchronization requests, background processing creates master data for each synchronization request, including the following steps: <ul style="list-style-type: none"> <li>• Data Transformation / Schema</li> <li>• Validation</li> <li>• Allocate Keys</li> <li>• Resolve Foreign Keys / Validate Business Object</li> <li>• Load Data</li> </ul>	

## Operational Device Management Data Synchronization

This section describes the master data synchronization processes used to synchronize data between Oracle Utilities Operational Device Management and Oracle Utilities Meter Data Management, including:

- Asset and Device Synchronization
- Install Event and Asset Disposition Synchronization
- Contact and Contact Type Synchronization

### Asset and Device Synchronization

When assets are created (or updated ) in Operational Device Management, a related Meter Data Management device is created / updated. This synchronization is performed in a manner very similar to the process outlined in [Customer To](#)



**Meter Master Data Synchronization.** The primary difference in how asset-device synchronization works is that instead of triggering the process based on the Asset maintenance object, the synchronization is triggered via the Generic Change Data Capture (W1-GCHG-CDCP) Audit algorithm on the following asset business objects:

- Smart Meter (W2-SmartMeter)
- Analog Meter (W2-ManualMeter)
- Communication Component (W2-CommunicationComponent)

For asset-device synchronization, the specific synchronization objects used include the following:

- **Outbound Data Synchronization Business Object:** MDM Asset Synchronization Request (W1-MDMAssetSyncRequest)
- **Inbound Data Synchronization Service Script:** Inbound Device Sync (X1-InSyDvc)
- **Inbound Data Synchronization Business Object:** Device Ongoing Sync Request (D1-OngoingSyncRequestDevice)

## Install Event and Asset Disposition Synchronization

When a device is installed at a service point, the disposition of its related asset is updated to “Installed”. The update to the device’s install event triggers the update to the asset disposition, changing its **Status** and **Asset Disposition** to “Installed” and its **Location** to the service point with an effective date matching the install event’s **Installation Date/Time**. This synchronization is performed in a manner very similar to the process outlined in [Customer To Meter Master Data Synchronization](#). In this case, the synchronization is triggered via the Generic Change Data Capture (W1-GCHG-CDCP) Audit algorithm on the Install Event maintenance object (D1-INSTLEVT).

For install event / asset disposition synchronization, the specific synchronization objects used include the following:

- **Outbound Data Synchronization Business Object:** ODM Install Event Sync request (D1-InstallEventSyncRequest)
- **Inbound Data Synchronization Service Script:** Inbound Asset-Node Sync (X1-InSyAstNd)
- **Inbound Data Synchronization Business Object:** Asset-Node Ongoing Sync Request (W1-OngoingSyncRequestAssetNode)

## Contact and Contact Type Synchronization

Contacts in Operational Device Management can be associated to asset locations (service points). Operational Device Management contacts are created when a Meter Data Management service point has a contact associated with it via the Maintain ODM Service Point (X1-ODMSPMNT) algorithm on the Service Point - MDM (X1D-ServicePoint) business object (see [Service Point Merged Maintenance](#) for more information about how service points are maintained).

Operational Device Management contacts and contact types are maintained via Pre-Processing algorithms on the following Meter Data Management business objects:

Meter Data Management Business Object	Pre-Processing Algorithm	Operational Device Management Business Object
Business (D1-Business)	Maintain ODM Business (X1-MNTODMBUS)	Business (W1-Business)
Person (D1-Person)	Maintain ODM Person (X1-MNTODMPER)	Person (W1-Person)
Contact Type (D1-ContactType)	Maintain ODM Contact Type (X1-MNTODMCTY)	Contact Type (W1-ContactType)

**NOTE:** Out of service locations reference Meter Data Management contacts.

## Lookup Value Mapping

Oracle Utilities Customer to Meter service points and other records reference field and lookup values from Oracle Utilities Customer Care and Billing, Oracle Utilities Meter Data Management, and Oracle Utilities Operational Device Management. This section describes how field and lookup values used by Customer Care and Billing are mapped to similar field and lookup values used by Oracle Utilities Meter Data Management, and how field and lookup values used by Oracle Utilities Operational Device Management are mapped to similar field and lookup values used by Oracle Utilities Meter Data Management

### Customer Care and Billing / Meter Data Management Mapping

Mapping of field and lookup values between Oracle Utilities Customer Care and Billing and Oracle Utilities Meter Data Management is supported through the use of two extendable lookups:

- **C2M Mapping Field List** (X1-CCBMDM-MDMCCB-MappingField): used to capture the fields that require translation mapping between Customer Care and Billing and Meter Data Maintenance maintenance objects in Customer to Meter. Values in this extendable lookup are identified by a field or lookup used by Customer Care and Billing, such as Disconnect Location (DISCON\_LOC\_CD) or Life Support / Sensitive Load (LS\_SL\_FLG).
- **C2M Mapping Field Values** (X1-CCBMDM-MDMCCB-Lookup): used to capture the mapping values for the fields and lookups defined in the C2M Mapping Field List extendable lookup. Values in this extendable lookup are identified by a Customer Care and Billing field or lookup defined in the C2M Mapping Field List extendable lookup. Each value also defines the specific value mappings for the field or lookup.

#### Examples

Value Mappings for the Disconnect Location (DISCON\_LOC\_CD) field are as follows:

CCB Value	MDM Value
Disconnected at meter	Device
Disconnected at pole	Source

Value Mappings for the Life Support / Sensitive Load (LS\_SL\_FLG) lookup are as follows:

CCB Value	MDM Value
None	Not on life support
LS/SL	On life support

### Operational Device Management / Meter Data Management Mapping

Mapping of field and lookup values between Oracle Utilities Operational Device Management and Oracle Utilities Meter Data Management is supported through the use of two extendable lookups:

- **ODM—MDM Mapping Field List** (X1-ODMMDM-MDMODM-MappingField): used to capture the fields that require translation mapping between Operational Device Management and Meter Data Management maintenance objects in Customer to Meter. Values in this extendable lookup are identified by a field or lookup used by Meter Data Management, such as the Life Support / Sensitive Load (LIFE\_SUPPORT\_SENS\_LOAD\_FLG) or Ok to Enter (OK\_TO\_ENTER\_FLG).
- **ODM—MDM Mapping Field Values** (X1-ODMMDM-MDMODM-Lookup): used to capture the mapping values for the fields and lookups defined in the C2M Mapping Field List extendable lookup. Values in this extendable lookup are identified by a Operational Device Management field or lookup defined in the ODM—MDM Mapping Field List extendable lookup. Each value also defines the specific value mappings for the field or lookup.

## Examples

Value Mappings for the Life Support / Sensitive Load (LIFE\_SUPPORT\_SENS\_LOAD\_FLG) lookup are as follows:

ODM Value	MDM Value
Life Support/Sensitive Load	LS/SL
None	None

Value Mappings for the Ok to Enter (OK\_TO\_ENTER\_FLG) field are as follows:

ODM Value	MDM Value
No	False
Yes	True

## Data Audit Maintenance

Different functions in Customer Care and Billing and Meter Data Management use similar types of data when calculating usage and billing charges, and it's critical that the data be consistent between the applications. For example, both Usage Rules in Meter Data Management and Calculation Rules in Customer Care and Billing make use of TOU Groups, TOU Map Templates, TOU Map Types, etc., and when calculating usage and billing charges for an account, the data used by both systems should be effectively identical. The process of maintaining similar sets of data usable by each system is called Data Audit Maintenance.

When specific types of Meter Data Management data is created or updated, Audit algorithms create or update corresponding Customer Care and Billing data. For instance, when a TOU Map Type usable by Meter Data Management Usage Rules is created, data auditing creates a similar TOU Map Type usable by Customer Care and Billing Calculation Rules.

Data audit maintenance is used with several types of Meter Data Management data in Customer to Meter, including:

- TOU Group
- TOU Map Template
- TOU Map Type
- TOU Map
- Device Type (Item Type)

The table below outlines the business objects and algorithms used by data audit maintenance:

Data Type	Business Object	Audit Algorithm
TOU Group	D2-TOUGroup	Maintain CCB TOU Group (X1-MCCBTOUGP)
TOU Map Template	D2-TOUMapTemplate	Maintain CCB TOU Map Template (X1-MCCBTOUTM)
TOU Map Type	D2-TOUMapType	Maintain CCB TOU Map Type (X1-MCCBTOUMT)
TOU Map	D2-TOUMap	Maintain CCB TOU Map (X1-MCCBTOUMP)
Device Type (Item Type)	D1-ItemType	Maintain CCB Item Type (X1-MCCBITEMT)

Refer to the Business Object and Algorithm portals to view additional details regarding these audit algorithms.

## Other Data Auditing

In addition to the objects listed above, Customer To Meter uses data auditing with other objects in Customer Care and Billing to ensure that changes to data reflected in related data in Meter Data Management. These objects use Audit algorithms on their maintenance objects to capture any changes and update the corresponding data. The objects that make use of this approach include the following:

- **Account:** When service agreement-related account data is changed in Customer Care and Billing, the audit algorithm creates a Service Agreement outbound data synchronization request to captures the change and update the corresponding usage subscription in Meter Data Management.
- **Premise:** When a Customer Care and Billing premise is changed, the audit algorithm updates the address information in the service point in Meter Data Management.

The table below outlines the data types, maintenance objects, and algorithms used by these.

Data Type	Maintenance Object	Audit Algorithm
Account	ACCOUNT	C2M Account Change Data Capture (SA-Based) (X1-ACCTDCSA)
Premise	PREMISE	Update MDM SP from CCB Premise (X1-UPSPFRPR)

Refer to the Maintenance Object and Algorithm portals to view additional details regarding these audit algorithms.

## Transactional Data Mapping

Certain types of transactional data created in Customer Care and Billing result in related transactional data in Meter Data Management (and vice-versa). This section describes these transactional mappings.

### Usage Requests / Usage Transactions

Customer Care and Billing creates usage requests during the billing process to request usage calculations in Meter Data Management. These requests in turn create Meter Data Management usage transactions, which perform the usage calculations.

Customer Care and Billing usage requests use the following business objects:

- MDM Cyclical Usage Request (C1–UsageRequestCyclicalBilling): Used with usage requests created from the cyclical or batch billing process.
- MDM Non-Cyclical Usage Request (C1–UsageRequestNonCyclical): Used with usage requests created from non-cyclical or online bill generation.
- MDM Usage Request (C1–UsageRequest): Parent business object that defines the lifecycle for Cyclical and Non-Cyclical usage requests.

When a usage request enters the “Send Request” state, the “Send Usage Request Message to MDM” (X1–SENDUSGR) Enter algorithm invokes the “Usage Transaction Request Inbound” (X1–UsgTrRqIn) service script which uses the Usage Transaction Seeder (D1–UsgTranSeeder) business object to create a usage transaction.

When a Meter Data Management usage transaction enters a “Subsequent Correction” state, the “X1–SEND-SUBC” Enter algorithm invokes the “Call Subsequent Correction Notification” (X1–SendSubC) service script to process a corrected read notification for Customer Care and Billing by finding the account associated with the corrected read and creating an off cycle bill generator to handle associated correction processing.

Refer to [The Big Picture of Usage Requests](#) for more information about usage requests and usage transactions.

## Field Activity Requests / Service Order Activities

Customer Care and Billing creates Field Activity Requests to initiate service orders to perform tasks at a service point. Most field activity requests are created:

- When a customer service representative starts or stops service at a premise. When this happens, the system automatically creates field activity requests for each service point.
- When service is cut due to lack of payment or reconnected for sufficient payment or arrangement.

When Customer Care and Billing creates a field activity request, a corresponding Service Order Activity is created to orchestrate the various activities required to fulfill the service order by continuously monitoring the status of the service point, device installation, and related measurements. This orchestration can include field activities to instruct a field crew to install, remove, or exchange a meter, as well as eligible smart meter command activities to connect or disconnect the meter, etc.

Service Order Field Activities are specific activities that typically exist only in Service Order Management and not Customer Care and Billing. However, field activity remarks notification, appointment notification (if required by the service order field activity), a missed appointment (which can create an adjustment) and create customer contact actions can be invoked in Customer Care and Billing when triggered from service order field activities.

Refer to [Understanding Service Order Management](#) for more information about service order activity processing.

## Customer To Meter Table Setup Sequence

This section provides guidelines for setting up control tables and administrative data used with Oracle Utilities Customer To Meter.

## Customer Care and Billing Control Table Setup Sequence

The topics in this section describe the order in which the control tables should be set up.

### Core Control Table Setup Sequence

To implement the system, you must set up your organization's business rules in "control tables". Setting up these tables is time-consuming because we allow you to tailor many aspects of the system to meet your organization's requirements. We strongly recommend that you take the time to document how you plan to set up all of these tables before you use the following roadmap to enter the core control data. Time spent understanding the interrelationships between this data will reap the rewards of a clean system that meets your current and long term needs.

While we describe the transactions and options in more detail in other sections of this manual, use the following chart (and the remaining sections of this chapter) as your roadmap. Here we list the order in which you perform tasks and the pages you'll use to set up your system. The order is important because some information must exist before other information can be defined (i.e., many dependencies exist).

---

**NOTE: Auto setup.** The Auto Setup column in the following table contains suggestions to save you time. It also indicates if a control table contains information when the system is installed.

---

**NOTE: You don't have to set up every control table.** You need only set up those control tables that govern functions that are applicable to your organization.

---

Function	Menu	Auto Setup
Global Context		

---

Algorithm	Admin, Algorithm. You will need to set up an algorithm that populates global context values. The global context is used by various zones in the system to display relevant data. This algorithm is plugged-in on the <a href="#">installation record</a> .	
<b>Accounting Environment</b>		
Country and State	Admin, Country	
Currency Codes	Admin, Currency Code	USD is automatically populated
Accounting Calendar	Admin, Accounting Calendar	
GL Division	Admin, General Ledger Division	
<b>Security Environment</b>		
Application Service	Admin, Application Service	All base package transactions are automatically populated
Security Type	Admin, Security Type	
User Group	Admin, User Group Note, you won't be able to set up users at this point	One user group, ALL_SERVICES, is automatically setup. It references all other application services and a single user called SYSUSER.
Language	Admin, Language	ENG is automatically populated
Display Profile	Admin, Display Profile	Two display profiles are automatically setup: NORTHAM displays currencies and dates in a classic American format; EURO displays information in a classic European format
Data Access Role	Admin, Data Access Role	
Access Group	Admin, Access Group	
User	Admin, User	SYSUSER is automatically set up. Note that you may import your users (and user groups) from an <a href="#">external source</a> .
Return to User Group	You must return to your user groups and define all of their users	
<b>Customer Class Environment</b>		
Customer Class	Admin, Customer Class. At this point, you'll only be able to set up your customer class codes. You will return to these customer classes throughout the setup process to populate additional information.	
<b>Financial Transaction Environment</b>		
Work Calendar	Admin, Work Calendar	
CIS Division	Admin, CIS Division	
Revenue Class	Admin Revenue Class	
Algorithm	Admin, Algorithm. You will need to set up the algorithm that constructs a distribution code's corresponding GL account when it is interfaced to the general ledger	

Distribution Code	Admin, Distribution Code
Bank and Bank Accounts	Admin, Bank
Billable Charge Template	Admin, Billable Charge Template. Note, if you want the system to default service quantities onto billable charges created using this template, you must setup the appropriate unit of measure code, time-of-use code and/or service quantity identifier.
Billable Charge Upload Line Type	Admin, Billable Charge Line Type
Algorithm	Admin, Algorithm. You will need to set up several algorithms. These algorithms: 1) retrieve a bill segment's consumption, 2) calculate a bill segment's bill lines, 3) construct a bill segment's financial transaction, 4) cancel previously estimated bill segments
Bill Segment Type	Admin, Bill Segment Type
Algorithm	Admin, Algorithm. You may want to set up an algorithm that formats the Bill Segment information that is displayed throughout the system for a specific Bill Segment Type. This algorithm is plugged-in on the Bill Segment Type.
Algorithm	Admin, Algorithm. You will need to set up the algorithm that constructs a payment segment's financial transaction
Payment Segment Type	Admin, Payment Segment Type
Algorithm	Admin, Algorithm. You will need to set up the algorithm that constructs an adjustment's financial transaction
Algorithm	Admin, Algorithm. Several plug-in spots are available to perform additional logic when processing adjustments. For example, if you have the system calculate adjustments, you must set up an adjustment generation algorithm. Refer to <a href="#">Adjustment Type</a> for other available plug-in spots that may be used by your implementation.
Algorithm	Admin, Algorithm. You may want to set up an algorithm that formats the Adjustment information that is displayed throughout the system for a specific Adjustment Type. This algorithm is plugged-in on the <a href="#">Adjustment Type</a> .
Algorithm	Admin, Algorithm. You may want to set up an algorithm that formats the Adjustment information that is displayed throughout the system. This algorithm is plugged-in on the <a href="#">installation record</a> .

Adjustment Type	Admin, Adjustment Type
Adjustment Type Profile	Admin, Adjustment Type Profile
Approval Profile	Admin, Approval Profile. Note, an approval profile references a To Do type and one or more To Do Roles; these must be set up before you can set up the approval profile. After the approval profile(s) are set up, they must be referenced on the adjustment types that they govern.
Cancel Reason - Bill	Admin, Bill Cancel Reason
Cancel Reason - Payment	Admin, Payment Cancel Reason
Cancel Reason - Adjustment	Admin, Adjustment Cancel Reason
Tender Type	Admin, Tender Type
Tender Source	Admin, Tender Source
A/P Request Type	Admin, A/P Request Type
Issuing Center	Admin, Issuing Center. You will need to set up issuing centers if your organization assigns document numbers to bills.
Installation	Admin, Installation Options - Framework and Admin, Installation Options. Many fields on the installation record impact the financial transaction environment. Refer to the description of the <a href="#">Billing</a> and <a href="#">Financial Transaction</a> tabs and the <a href="#">Messages</a> tab in the Framework page for more information.
Algorithm	Admin, Algorithm. You will need to set up an algorithm that distributes payments.
Algorithm	Admin, Algorithm. You will need to set up an algorithm that handles overpayment situations.
Algorithm	Admin, Algorithm. You may need to set up an algorithm if specific customers can have individual bill due dates.
Algorithm	Admin, Algorithm. You may need to set up an algorithm if you want the system to delete bills that contain only information about historical payments.
Algorithm	Admin, Algorithm. You may need to set up an algorithm if you want the system to levy a non-sufficient funds charge if a payment is canceled due to non-sufficient funds.
Algorithm	Admin, Algorithm. You will need to set up an algorithm that formats the bill information that is displayed throughout the system. This algorithm is plugged-in on the <a href="#">installation record</a> .



Algorithm	Admin, Algorithm. You will need to set up an algorithm that formats the payment information that is displayed throughout the system. This algorithm is plugged-in on the <a href="#">installation record</a> .
Algorithm	Admin, Algorithm. You will need to set up an algorithm that defaults the amount when a payment is manually added. This algorithm also calculates the amount of an automatic payment for a bill for an account with an active auto pay option. This algorithm is plugged-in on the <a href="#">installation record</a> .
Algorithm	Admin, Algorithm. Refer to <a href="#">Customer Class</a> for other available plug-in spots that may be used by your implementation to perform additional logic when processing payments and bills.
Return to Customer Class	Admin, Customer Class. You will need to plug-in the algorithms defined above on your customer classes.
<b>Budget Environment</b>	
Algorithm	Admin, Algorithm. You will need to set up several algorithms at this time: How To Calculated The Recommended Budget Amount, How To Periodically True Up A Customer's Budget Amount, The Circumstances When The System Should Highlight A Customer As Having An Anomalous Budget.
Budget Plan	Admin, Budget Plan
Algorithm	Admin, Algorithm. Budget eligibility is set at the SA type level. You will need to set up an override budget eligibility algorithm if some service agreements for an SA type are not eligible for budget based on certain conditions.
<b>Customer Environment</b>	
Account Management Group	Admin, Account Management Group. Note, you will probably have to set up To Do Type and To Do Roles before you can setup account management groups. Refer to <a href="#">Assigning A To Do Role</a> for more information on how account management groups may be used to define an entry's role.
Account Relationship	Admin, Account Relationship Type
Alert Type	Admin, Alert Type
Bill Message	Admin, Bill Message
Algorithm	Admin, Algorithm. If you have software that's capable of reconstructing an image of a bill in a PDF (for the purpose of online display), you

will need to create an algorithm that formats the extract records that are sent to your bill image software.

Bill Route Type	Admin, Bill Route Type
Contract Quantity Type	Admin, Contract Quantity Type
Algorithm	Admin, Algorithm. If you have software that's capable of reconstructing an image of a letter in a PDF (for the purpose of online display), you will need to create an algorithm that formats the extract records that are sent to your letter image software.
Letter Template	Admin, Letter Template
Customer Contact Class	Admin, Customer Contact Class
Customer Contact Type	Admin, Customer Contact Type
Conservation Programs	Admin, Conservation Program. You will need to set up conservation programs if your organization provides rebates to customers based on eligibility and verification of newly purchased appliances and hardware that are rated to conserve the demand for energy.
Algorithm	Admin, Algorithm. You may need to set up the algorithms that determine if person ID's are in a predefined format.
Identifier Type	Admin, Identifier Type
SICs	Admin, SIC Code
Tax Exempt Type	Admin, Tax Exempt Type
Algorithm	Admin, Algorithm. You may need to set up the algorithms that determine if phone numbers are in a predefined format.
Phone Type	Admin, Phone Type.
Person Relationship Type	Admin, Person Relationship Type.
Algorithm	Admin, Algorithm. You will need to set up an algorithm that formats the person information that is displayed throughout the system. This algorithm is plugged-in on the <a href="#">installation record</a> .
Algorithm	Admin, Algorithm. You will need to set up an algorithm to validate a person's name. This algorithm is plugged-in on the <a href="#">installation record</a> .
Algorithm	Admin, Algorithm. You can override the system's standard account information string by setting up an algorithm that produces this string of information. This algorithm is plugged-in on the <a href="#">installation record</a> .
Algorithm	Admin, Algorithm. If you have software that's capable of reconstructing an image of a bill in

a PDF for the purpose of online display, you will need to create an algorithm that renders this PDF. This algorithm is plugged-in on the [installation record](#).

---

Installation	Admin, Installation Options. Many fields on the installation record impact the Customer Environment. Refer to the description of the <a href="#">Main</a> , <a href="#">Person</a> , and <a href="#">Account</a> tabs for more information.
--------------	---

---

Statements	
------------	--

---

Algorithm	Admin, Algorithm. If you have software that's capable of reconstructing an image of a statement in a PDF (for the purpose of online display), you will need to create an algorithm that formats the extract records that are sent to your statement image software.
-----------	---

---

Statement Route Type	Admin, Statement Route Type
----------------------	-----------------------------

---

Statement Cycle	Admin, Statement Cycle
-----------------	------------------------

---

Algorithm	Admin, Algorithm. If you have software that's capable of reconstructing an image of a statement in a PDF for the purpose of online display, you will need to create an algorithm that renders this PDF. This algorithm is plugged-in on the <a href="#">installation record</a> .
-----------	---

---

Automatic Payment (EFT) Environment	
-------------------------------------	--

---

Algorithm	Admin, Algorithm. You will need to set up an algorithm to create automatic payments. This algorithm is plugged-in on the <a href="#">installation record</a> .
-----------	--

---

Tender Source	Admin, Tender Source  Note: earlier, you created tender sources for the remittance processor and your cash drawers. At this point, you'll need to add at least one tender source for automatic payments. Why? Because automatic payments get linked to a tender control (which, in turn, gets linked to a tender source) when they are interfaced out of the system.
---------------	--

---

Algorithm	Admin, Algorithm. You will need to set up the appropriate automatic payment date calculation algorithm to populate the extract, GL interface and payment dates on automatic payments.
-----------	---

---

Auto Pay Route Type	Admin, Auto Pay Route Type
---------------------	----------------------------

---

Tender Type	Admin, Tender Type  Note: earlier, you created tender types for things like cash, checks, etc. At this point, you'll need to add a tender type for each type
-------------	--

---

of automatic payments (e.g., direct debt, credit card, etc.).

---

Work Calendar	Admin, Work Calendar. You need only set up additional work calendars if the auto pay sources (i.e., the financial institutions) have different working days than does your organization
Algorithm	Admin, Algorithm. If you need to validate the customer's bank account or credit card number, you will need to set up the appropriate validation algorithms.
Auto Pay Source Type	Admin, Auto Pay Source Type
Algorithm	Admin, Algorithm. You may need to set up an algorithm if your customers can define a maximum withdrawal limit on their autopay options.
Return to Customer Class	Admin, Customer Class. You should plug-in the Autopay Over Limit Algorithm in each appropriate customer class.
Deposit Environment	
Algorithm	Admin, Algorithm. You will need to set up several algorithms at this time: The Definition Of A Good Customer, When To Refund A Deposit To A Customer, When To Recommend An Additional Deposit, How / When To Calculate Interest, How To Generate The Recommended Deposit Amount.
Deposit Class	Admin, Deposit Class
Non Cash Deposit Type	Admin, Non Cash Deposit Type
Field Work Environment	
Field Activity Type and Steps	Admin, Field Activity Type
Field Activity and Field Order Cancellation Reason	Admin, Fieldwork Cancel Reason
Field Activity Type Profiles	Admin, Field Activity Type Profile
Algorithm	Field activities for Start/Stop will only be created if the SA Type linked to the service point has a SASP field work creation algorithm. Refer to the SA Type section below.
Algorithm	Admin, Algorithm. If you have software that's capable of reconstructing an image of a field order in a PDF for the purpose of online display, you will need to create an algorithm that renders this PDF. This algorithm is plugged-in on the <a href="#">installation record</a> .
Credit & Collections Environment (if you collect on overdue bills (as opposed to overdue debt), you will NOT set up these tables; refer to <a href="#">Overdue Processing - Set Up Tasks</a> for the list of control tables required to collect on overdue bills)	

---

Algorithm	Admin, Algorithm. You may need to set up algorithms if you have non-standard collection events.
Collection Event Type	Admin, Collection Event Type
Algorithm	Admin, Algorithm. You may need to set up a collection process cancellation algorithm if your organization allows individual service agreements to be removed from a collection process if they are paid (rather than performing cancellation based on all SAs in a debt class).
Collection Process Template	Admin, Collection Process Template
Collection Class	Admin, Collection Class
Algorithm	Admin, Algorithm. You will need to set up several algorithms at this time: Collection process cancellation criteria, Severance process cancellation criteria, and Override arrears due to pay plans.
Debt Class	Admin, Debt Class
Write Off Debt Class	Admin, Write Off Debt Class
Algorithm	Admin, Algorithm. You will need to set up Collection Condition algorithms.
Collection Class Control	Admin, Collection Class Control
Algorithm	Admin, Algorithm. You may need to set up algorithms if you have non-standard severance events.
Severance Event Type	Admin, Severance Event Type
Algorithm	Admin, Algorithm. You may need to set up a severance process cancellation algorithm if your organization allows a severance process to be canceled when the related service agreement is paid (rather than performing cancellation based on all SAs in a debt class).
Severance Process Template	Admin, Severance Process Template
Algorithm	Admin, Algorithm. You will need to set up several algorithms at this time: How to refer debt to a collection agency, How to transfer debt to another active service agreement, How to write down small amounts of debt, and How to refund credit balances to a customer.
Algorithm	Admin, Algorithm. You may need to set up algorithms if you have non-standard write-off events.
Write Off Event Type	Admin, Write Off Event Type (Note, you'll have to wait until you have defined your SA Types before you can set up the Write Off Events because SA Type is a necessary parameter to write off debt).

Write Off Process Template	Admin, Write Off Process Template	
Write Off Control	Admin, Write Off Control	
Collection Agency	Admin, Collection Agency. Note, each collection agency references a person therefore you must set up a person for each agency before you can enter collection agency information.	
Algorithm	Admin, Algorithm. You may need to set up algorithms if you have special logic that should be executed when a pay plan is canceled.	
Pay Plan Type	Admin, Pay Plan Type	
Payment Method	Admin, Payment Method	
Third Party Payor	Admin, Third Party Payor. Note, you must create an account before you can create a third party payor.	
Installation	Admin, Installation. Several fields on the <a href="#">installation record</a> impact the Credit & Collections Environment.	
Algorithm	Admin, Algorithm. You will need to setup an algorithm that's called when a user write-off debt real time.	
Return to Customer Class	Admin, Customer Class. You should plug-in the Autopay Over Limit Algorithm in each appropriate customer class.	
Services and Characteristics		
Service Type	Admin, Service Type	
Algorithm	Admin, Algorithm. If you have ad hoc characteristic types, you may need to set up the algorithms that control how they are validated	
Foreign Key Reference	Admin, FK Reference. If you have foreign key characteristic types, you may need to set up foreign key references to control how the user selects the characteristic values (and how the foreign key values are validated).	All base package FK references are automatically populated
Characteristic Type and Values	Admin, Characteristic Type	
Meter and Item Environment	Refer to the <a href="#">Meter Data Management Table Setup Sequence</a> for control tables used with Meter Data Management, and configure the control tables as specified in this section.	
Premise and Service Point Environment		
Premise Type	Admin, Premise Type	
Algorithm	Admin, Algorithm. You will need to set up an algorithm to format the standard premise info that appears throughout the system. This algorithm is plugged-in on the <a href="#">installation record</a> .	

Algorithm	Admin, Algorithm. You will need to set up an algorithm that formats the service point information that is displayed throughout the system. This algorithm is plugged-in on the <a href="#">installation record</a> .	
Algorithm	Admin, Algorithm. You may need to set up the algorithms that determine if geographic ID's are in a predefined format.	
Geographic Type	Admin, Geographic Type	
Service Point Type	Admin, SP Type. [Note - you won't be able to define the SP Type's SA Types until after you define the SA Types or the FA Type Profiles until after you define the Field Activity Type Profiles.]	
Bill and Service Cycle Environment		
Bill Cycle, Bill Cycle Schedule	Admin, Bill Cycle	
Bill Period, Bill Period Schedule	Admin, Bill Period	
Rate Environment		
Frequency	Admin, Frequency	
Service Quantity Identifier	Admin, Service Quantity Identifier	
Algorithm Type	Admin, Algorithm Type. If you create new pre-processing calculation rules, you must set up an algorithm type for each such rule (the algorithm type defines the types of parameters that are passed to the calculation rule).	All base package algorithm types are automatically populated
Bill Factor	Main, Rates, Bill Factor	
Algorithm Type	Admin, Algorithm Type. If you create new Register Rules you must set up an algorithm type for each such rule (the algorithm type defines the types of parameters that are passed to the register rule).	All base package algorithm types are automatically populated
Rate	Main, Rates, Rate Schedule	
Calculation Group	Main, Rates, Calculation Group	
Algorithm	Admin, Algorithm. If you use algorithms to dynamically change step boundaries, calculate prices, or implement calculation rule eligibility rules, you must set up these algorithms.	
Calculation Rule	Main, Rates, Calculation Rule	
Bill Factor Value	Main, Rates, Bill Factor Values	
Bill Factor Interval Values	Main, Rates, BF Interval Values	
Item Type SQ Estimate	Admin, Item Type SQ Estimate	
Degree Day	Admin, Degree Days	
Late Payment Environment		

Algorithm	Admin, Algorithm. You will need to set up the algorithm that determine if customers in a customer class are eligible for late payment charges
Algorithm	Admin, Algorithm. You will need to set up the algorithm that levies late payment charges for customers in a customer class
Return to Customer Class	Admin, Customer Class. You will need to plug-in the late payment charge algorithms set up above.
SA Configuration	
Algorithm	Admin, Algorithm. You will need to set up the algorithms that determine: <ul style="list-style-type: none"> <li>• How to calculate the late payment charge amount for service agreements of a given type</li> <li>• Special criteria to be tested before a service agreement is severed.</li> <li>• How to create field activities for service agreements of a given type.</li> <li>• Special processing that should take place prior to the completion of a bill that references service agreements of a given type.</li> <li>• Special processing that should take place during completion of a bill that references service agreements of a given type.</li> <li>• Special processing that should take place when service agreements of a given type are created.</li> <li>• Special processing that should take place when a financial transaction is frozen for service agreements of a given type.</li> </ul>
Algorithm	Admin, Algorithm. You may want to set up an algorithm that formats the SA information that is displayed throughout the system. This algorithm is plugged-in on the <a href="#">installation record</a> .
Algorithm	Admin, Algorithm. You may want to set up an algorithm that formats the SA information that is displayed throughout the system for a specific SA Type. This algorithm is plugged-in on the <a href="#">SA Type</a> .
Algorithm	Admin, Algorithm. If you want a Control Central alert to highlight when the current account has any stopped service agreement(s), you will need to set up the algorithm that does this. This algorithm is plugged-in on the <a href="#">installation record</a> .
Service Agreement Type	Admin, SA Type



Terms and Conditions	Admin, Terms and Conditions
SA Type Start Options	Admin, SA Type Start Option
Update SP Types with initial SA types and with FA Type Profiles	Admin, SP Type
SA Relationships	
SA Relationship Type	Admin, SA Relationship Type
Service Provider	Admin, Service Provider. Note, you must create a person before you can create a service provider. If you have financial relationships (you bill for them or they bill for you), you must also create an account and a financial settlement service agreement before you can create the service provider.
SA Type / SA Relationship	Admin, SA Type SA Relationship Type
Service Provider.	Admin, Service Provider. Note, you must create a person before you can create a service provider.
Sales and Marketing	
Order Hold Reason	Admin, Order Hold Reason
Order Cancel Reason	Admin, Order Cancel Reason
And more...	Refer to <a href="#">Campaign and Package Setup Sequence</a> for additional setup requirements
Service Credit Membership	
Algorithm	Admin, Algorithm. You may need to set up algorithms for the service credit membership type and service credit event type to control behavior for the service credit membership and its events.
Credit Unit	Admin, Credit Unit. If your service credits record non-monetary units.
Service Credit Membership Type	Admin, Service Credit Membership Type
Service Credit Event Type	Admin, Service Credit Event Type
Membership Inactive Reasons	Admin, SC Membership Inactive Reason
Wrap Up	
Algorithm	Admin, Algorithm. You will need to set up the algorithms that determine:  #x2022; Special alerts on Control Central (assuming you have special alerts)
Installation Options	Admin, Installation Options - Framework and Admin, Installation Options. At this point, it's a good idea to double-check everything on the installation record.
Postal Default	Admin, Postal Code Default

If you have cash drawers you will also need to set up the following information:

- Create a person / account to which you will link your over / under service agreement. Refer [How To Get An Unbalanced Tender Control In Balance \(Fixing Over/Under\)](#) for more information.
- Create a service agreement to which your over/under payments will be linked. This service agreement will reference your over / under SA type. Refer to [Over / Under Cash Drawer Segmentation](#) for more information.

If you upload payments from an external source (e.g., a remittance processor or lock box), you must set up the following information:

- Create a person and account to which the system will link payments with invalid account. Refer to [Phase 3 - Create Payment Events, Tenders, Payments and Payment Segments](#) for information about the process that books invalid payments to this account. Refer to [How To Transfer A Payment From One Account To Another](#) for how a user transfers the payment from the invalid account to the correct account (once known).
- Create a service agreement for this account. This service agreement will reference your payment suspense SA type. The system needs this service agreement so that it can distribute the invalid account's payment (and this is necessary so that cash will reflect the payment). Refer to [Payment Upload Error Segmentation](#) for more information.
- Update the tender source associated with the respective source of payments to indicate the service agreement created in the previous step should be used for payments with invalid accounts. Refer to [Setting Up Tender Sources](#) for more information.
- Because the payment upload process simply books payments that reference invalid accounts to the account associated with the suspense service agreement on the payment's tender source, this account should belong to a customer class with the appropriate payment distribution algorithms. This may entail creating a new customer class that will only be used on suspense accounts. This customer class would need the following algorithms:
- We'd recommend using a simple payment distribution algorithm like [PYDIST-PPRTY](#) (distribute payment based on SA type's payment priority).
- We'd recommend using an overpayment distribution algorithm like [OVRPY-PPRTY](#) (distribute overpayment to highest priority SA type).

The remaining sections describe additional control tables that must be set up for specific functional areas.

## Cross-Reference To The Remaining Chapters

The table in the previous section describes the order in which you should enter your control tables. These tables are described at length in the following chapters.

- Refer to [Defining General Options Addendum](#) and [Defining General Framework Options](#) for a discussion of the control tables associated with general functionality (e.g., country codes, state codes, etc.).
- Refer to [Defining Financial Transaction Options](#) for a discussion of the tables affecting your financial transactions (e.g., bill segment types, payment segment types, etc.)
- Refer to [Defining Customer Options](#) for a discussion of the control tables affecting persons, accounts and service agreements.
- Refer to [Defining Service Order Options](#) for a discussion of the control tables affecting fieldwork.
- Refer to [Defining Credit and Collections Options](#) for a discussion of the control tables affecting your collection activities.
- Refer to [Defining Device Options](#) for a discussion of the control tables affecting your meters and items.
- Refer to [Defining Device Installation Options](#) for a discussion of the control tables affecting your premises and service points.
- Refer to [Defining Cycles and Schedules](#) for a discussion of the control tables affecting your cyclical processes.
- Refer to [Rates](#) for a discussion of the control tables affecting your rates.
- Refer to [Defining SA Type Options](#) for a discussion of the control tables affecting your service agreement types.

- Refer to [Defining Background Process](#) for a discussion of the control tables affecting your background processes.
- Refer to [Defining Algorithms](#) for a discussion of the control tables affecting the algorithms referenced on many control tables.
- Refer to [Defining SA Relationships](#) for a discussion of the control tables affecting the relationships between service providers.
- Refer to [Statements](#) for a discussion of the tables affecting the statement setup options for your customers.
- Refer to [Defining Service Credit Options](#) for a discussion of the tables affecting the service credit membership setup options for your customers.

## Open-Item Accounting Table Setup Sequence

Open-item accounting tables need only be set up if your organization practices [Open Item Accounting](#). Refer to [Setting Up The System To Enable Open Item Accounting](#) for a description of the tables that must be set up to enable this functionality.

## Fund Accounting Table Setup Sequence

Fund accounting tables need only be set up if your organization practices [Fund Accounting](#). Refer to [Setting Up The System To Enable Fund Accounting](#) for a description of the tables that must be set up to enable this functionality.

## Payment Event Distribution Table Setup Sequence

Payment event distribution tables need only be set up if your organization opted to use the distribution rules method to create payment events. Refer to [Setting Up The System To Use Distribution Rules](#) for a description of the tables that must be set up to enable this functionality.

## Loans Table Setup Sequence

Loans need only be set up if your organization offers [loans](#) to your customers. Refer to [Setting Up The System To Enable Loans](#) for a description of the tables that must be set up to enable this functionality.

## Quotes Table Setup Sequence

Quotes need only be set up if your organization sends quotes to customers or prospects. Refer to [Defining Quotation Options](#) for a description of the tables that must be set up to enable this functionality.

## Non-Billed Budget Table Setup Sequence

[Non-Billed Budgets](#) need only be set up if your organization allows your customers to pay set amounts at specified intervals (e.g. every two weeks). Refer to [Setting Up The System To Enable Non-Billed Budgets](#) for a description of the tables that must be set up to enable this functionality.

## Scripting Table Setup Sequence

Scripts need only be set up if your organization opts to create [scripts](#) to step your users through business processes. Refer to [Defining Script Options](#) for information about scripting and the tables that must be set up to enable this functionality.

## Reports Setup Sequence

In order to use the reporting tool, you will need to set up reporting options. Refer to [Configuring The System To Enable Reports](#) for more information.

## External Messages Setup

To configure the system to communicate with an external system, refer to [External Messages](#).

## Case Management Setup Sequence

Case management options need only be set up if your organization uses cases to manage issues. Refer to [Setting Up Case Types](#) for more information.

## Umbrella Agreement Management Setup Sequence

Umbrella agreement management options need only be set up if your organization uses umbrella agreements to manage contracts. Refer to the integration documentation for more information.

## Outage Management Setup Sequence

Outage management options need only be set up if your organization interfaces with Oracle Utilities Network Management System. Refer to the integration documentation for more information.

## Prepaid Metering Setup Sequence

Prepaid metering options need only be set up if your organization offers prepaid metering service to your customers. Refer to [Defining Prepaid Metering Options](#) for more information.

## Zone Set Up

Most zones are delivered with the base-package and do not require any configuration. However, some zones are only available if configured by your implementation. Refer to [Configuring Zones](#) for more information.

## To Do Options Setup

Refer to [Setting Up To Do Options](#) for more information on how to configure the system to match your organization's To Do management needs.

## Meter Data Management Table Setup Sequence

This section provides the suggested order for the setup of Meter Data Management administrative data.

Sequence	Entity	Description
1	<a href="#">Unit of Measure</a>	Quantities measured and recorded by the system (CCF, KWH, KW, etc.).
1	<a href="#">Service Quantity Identifier</a>	Used to further distinguish between measured quantities that have identical UOM/TOU combinations.
1	<a href="#">Time of Use</a>	Modifiers for a given unit of measure that indicate a period of time during which a quantity has been used (On- Peak, Off-Peak, etc.).
1	<a href="#">Factor</a>	Centrally stored sets of values for use in validation rules, bill determinants calculations, and other processes.
1	<a href="#">Market</a>	Defines jurisdictions or regulatory environments in which a Service Point participates.
1	<a href="#">Measurement Cycle</a>	Defines the schedule for manual meter reading of devices at Service Points in that cycle
1	<a href="#">Measurement Cycle Schedule</a>	Define the dates on which devices are scheduled to be read for a given measurement cycle.
1	<a href="#">Outbound Message</a>	Defines messages sent to external systems.
1	<a href="#">Processing Timetable Type</a>	Defines types of schedules that can be referenced by different processes and objects.
2	<a href="#">External System</a>	Defines External Systems with which Oracle Utilities Meter Data Management should be able to communicate.
3	<a href="#">Head End Systems</a> <a href="#">External Applications</a> <a href="#">Market Participants</a>	External entities that serve various roles relative to the application (head-end systems, billing systems, market participants, outage management systems, etc.).
3	<a href="#">Contact Type</a>	Defines properties of a class of entities (businesses, persons).
4	<a href="#">Activity Type</a>	Defines properties common to a specific type of activity.
4	<a href="#">Communication Type</a>	Define properties common to a specific type of communication.
4	<a href="#">Service Task Type</a>	Defines specific types of tasks performed by external users (self-service meter reads, self-service outage notifications, etc.)
4	<a href="#">Dynamic Option Type</a>	Defines information common to dynamic options of a specific type.
4	<a href="#">Manufacturer</a>	Individual companies that makes devices. Manufacturers also reference models.
4	<a href="#">Exception Type</a>	Defines properties common to VEE Exceptions of a specific type.

5	VEE Group	Collections of VEE Rules that are applied to initial measurement data.
6	VEE Rule	Standard and custom VEE Rules that perform checking and/or manipulation of initial measurement data.
7	VEE Eligibility Criteria	Dictates whether a VEE Rule can execute based on a set of defined criteria.
8	Measuring Component Type	Defines the most important properties of a measuring component.
8	Measuring Component Comparison Type	Defines details by which measuring component data can be compared to determine the days that most closely resemble a specific day being evaluated.
9	Device Configuration Type	Defines properties of Device Configurations of a given type.
10	Device Type	Defines information about a class of devices.
11	Service Point Type	Defines specific types of points at which service is delivered.
11	Service Point Quantity Type	Defines types of quantities that can be stored for a service point.
12	TOU Group	Used to limit the set of Time Of Uses that are usable in a TOU schedule.
13	TOU Map Template	Schedules used for TOU map data generation.
14	TOU Map Type	Define important properties of TOU maps of a given type.
15	Usage Transaction Exception Type	Defines properties common to Usage Transaction Exceptions of a specific type.
15	Usage Calculation Group	Collections of usage calculation rules that are applied to measurement data to calculate bill determinants for usage subscriptions.
16	Usage Calculation Rule	Defines rules that perform calculations on measurement data to generate bill determinants and other values used by external systems.
17	Usage Calculation Rule Eligibility Criteria	Dictates whether a usage calculation rule can execute based on a set of defined criteria.
18	Usage Subscription Type	Defines collections of properties common to a set of Usage Subscriptions.
19	Data Source	Defines the source of data for dynamic aggregation, such as measurement data from usage subscriptions linked to a service point, badged or unbadged items, or measuring component sets
19	Dynamic Aggregation Measuring Component Type	Define the most important properties of a measuring component used with dynamic aggregation.
19	Measuring Component Set	Define the dimensions and criteria by which dynamic aggregation will be performed.
19	Aggregation Group	Define the ordering of a series of related aggregations based on a set of configured measuring component Sets.
20	Processing Methods	Control various behaviors for external applications, head end systems, and market participants within the system such as which message is sent, how an external value is translated, among others.
20	Master Configuration	Configuration that applies to series of modules that acts as a central point of configuration rather than embedding repetitive configuration throughout a set of algorithms.

Information Lifecycle Management (ILM) is designed to address data management issues, with a combination of processes and policies so that the appropriate solution can be applied to each phase of the data's lifecycle.

Defines the extract parameters, the bucket configurations and configuration snapshots used for extracting data for Oracle Utilities Analytics

## Operational Device Management Table Setup Sequence

This section provides the suggested order for the setup of Operational Device Management administrative data.

Sequence	Entity	Description
1	Configuration Type	Defines the information required for various asset configurations with other assets, components, firmware, and other data.
1	Service History Type	Defines the main attributes for service history of a certain type. Types might include maintenance, inspection, service, test, measurement, and so on.
1	Organization Type	Defines the main attributes for organizations of a certain type.
2	Asset Location Type	Defines the details of asset or component locations of a certain type. Valid types of asset locations can include service points, other locations for installed assets, or any other location as defined by your organization.
2	Out of Service Location Type	Defines attributes of types of locations where assets that are out of service are stored and maintained. Examples of out of service locations include warehouses, storerooms, and repair shops.
2	Organization	Used for categorization and reporting for locations
2	Configuration	Documents and manages valid setups for assets and components. This includes a specification for each asset or component in the configuration as well as the valid value for each parameter, such as the firmware version of each asset.
3	Out of Service Location	Defines physical locations where assets are stored or repaired such as a storeroom, warehouse, or service facility. When assets are changed to statuses such as "In Repair" or "Pending Disposition" the asset location is typically moved to an out of service location.
3	Configuration Reports	Provides a summary of currently installed configurations.
4	Asset Type	Defines the attributes for assets and components of a certain type, including information such as the valid location types and service history types for the assets and whether or not such assets can have attached components.

## Customer To Meter Batch Processing

This section provides guidelines for configuring batch processing with Oracle Utilities Customer To Meter.

### Batch Process Dependencies

The contents of this section illustrate the periodicity and dependencies between the various background processes described above.

### Batch Schedulers and Return Codes

If you use a batch scheduler (e.g., Control-M, Tivoli) to control the execution of your batch processes, it will be interested in the possible values of each process's return code. The return code is a number that indicates if the process ended successfully. All product processes will return one of the following return code values:

- 0 (zero). A value of zero means the batch process ended normally.
- 2. A value of 2 means the batch process detected a fatal error and aborted.

### The Nightly Processes

The following diagram illustrates the dependencies between the batch processes.



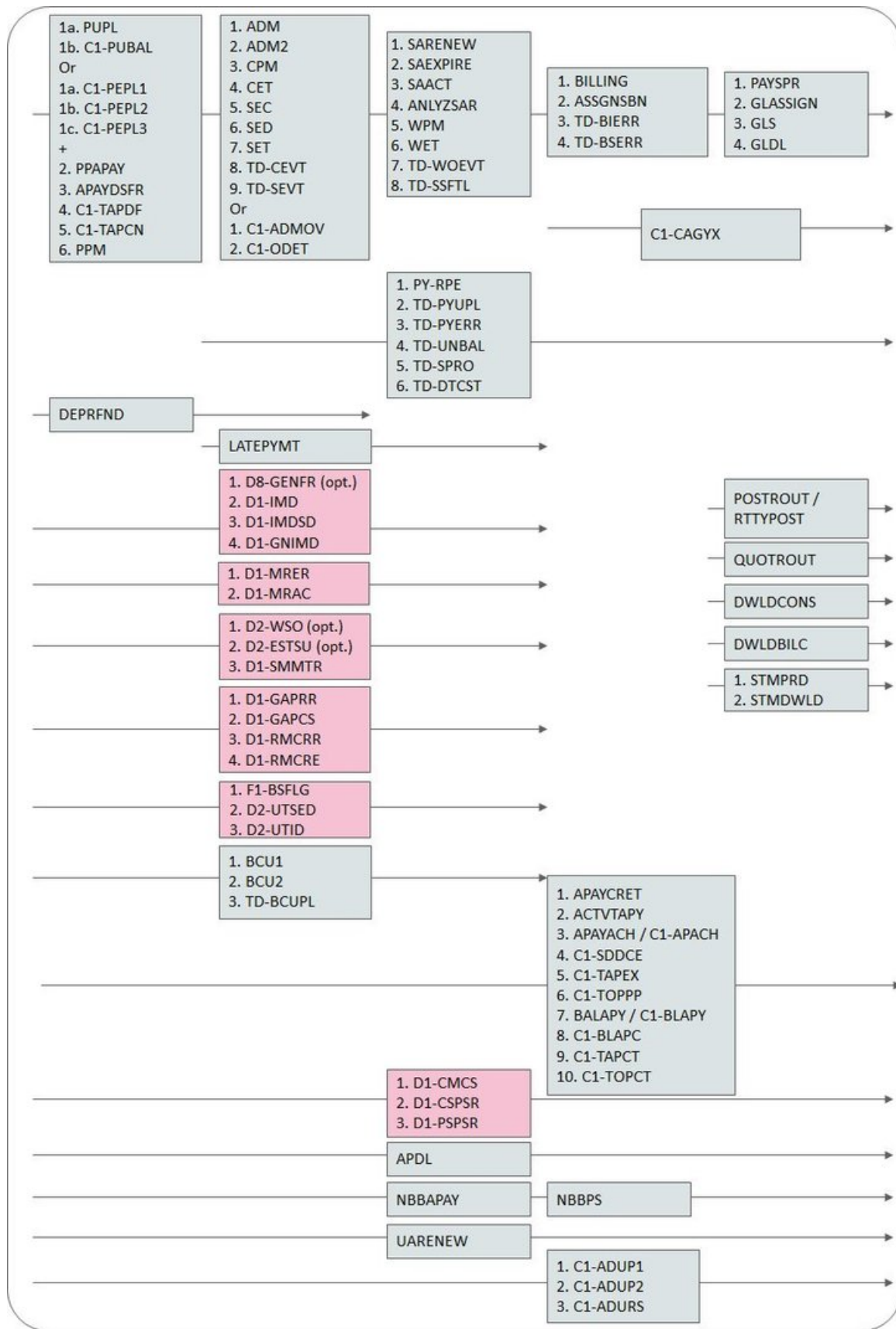

The mnemonics in the boxes refer to the individual batch processes described above. When a box contains multiple processes, these processes must be run sequentially. When multiple boxes exist on a timeline, all processes in an earlier box must execute before the subsequent box is executed. Those timelines that appear beneath the Main Job Stream's timeline indicate when the timeline's respective processes can be executed in respect of the Main Job Stream.

The following diagram illustrates the daily batch processes for which there are no dependencies.

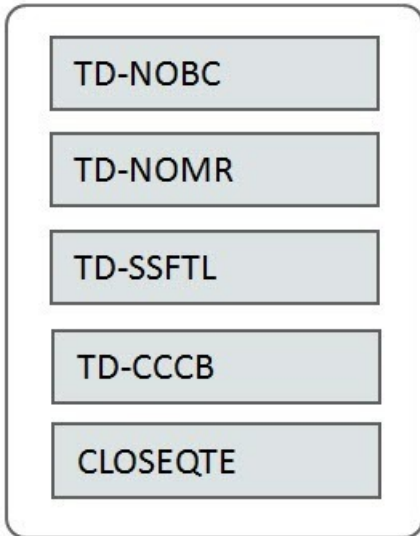

The mnemonics in the boxes refer to the individual batch processes described above.

---

**NOTE:**

**No dependencies exist.** As you can see, there are no dependencies between the boxes (meaning they may be run in parallel).

---

## The Ongoing or Hourly Processes

The following diagram illustrates the dependencies between the ongoing or hourly batch processes.

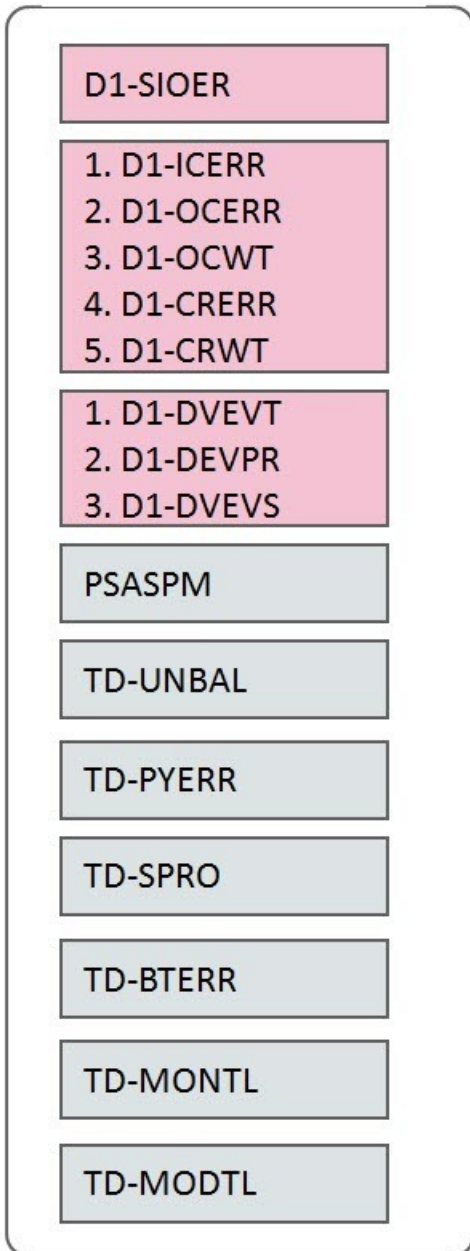

The mnemonics in the boxes refer to the individual batch processes described above. When a box contains multiple processes, these processes must be run sequentially.

**NOTE:**

**No dependencies exist.** As you can see, there are no dependencies between the boxes (meaning they may be run in parallel).

Throughout the course of the day, you will likely want to run jobs to bring measurement and event data in from the various metering / head-end systems and other external systems. To accompany this, you should consider running the following batch processes:

- **Ongoing Master Data Sync Processing**

With the Oracle Utilities Customer to Meter deployment, data synchronization is used to keep certain objects synchronized. Refer to the C2MIntegration section for further details. Cleaning out synch staging records in error by running [D1-SIOER](#) may be necessary.

- **Command Processing**

If using Oracle Utilities Smart Grid Gateway to process device commands, it's important to keep communications flowing to and from smart meters to provide the most accurate picture of the state of a given meter. This would include:

- Retrying inbound communications in error ([D1-ICERR](#))
- Retrying outbound communications in error ([D1-OCERR](#))
- Processing outbound communications waiting for a response ([D1-OCWT](#)) to see if they should be timed out.
- Processing command request activities in error ([D1-CRERR](#)) and those that are waiting ([D1-CRWT](#))

---

**NOTE:** Base package business objects for communications and command activities are designed to trap any processing errors encountered and transition the object into an Error state. To deal with unexpected errors that can't be trapped, which could leave communications / command activities in unmonitored states, implementations can choose to configure their own batch controls based on the delivered [D1-ACTVY](#) and [D1-COMM](#) batch controls, restricting records processed by business object or maintenance object as needed

---

- **Initial Measurement Processing**

For initial measurement processing, the following batch processes should be scheduled on an ongoing basis per business requirements:

- Processing initial measurements in the pending state ([D1-IMD](#)).
- Processing initial measurements seeders in error ([D1-IMDSD](#)).
- Processing initial measurements in the exception state ([D1-GNIMD](#)).

These processes are also highlighted in the Nightly Processes stream to reflect the need to bring in as much measurement data as possible prior to running billing, both up-to-date data from late-reporting meters and corrected readings from the head-end system.

- **Event Processing**

The base package is configured such that device events are processed immediately upon receipt, since they might need to be sent to some other application such as an outage system. This can be changed by configuring a monitor process on the device event business object to stop records in a specified state, and then use a batch process to process the events all at once. Beyond this type of batch-oriented processing for events, other event processing could include:

- Re-processing device event "seeders" in error ([D1-DVEVS](#))
- Processing all device events that can come in as pairs ([D1-DEVPR](#))
- Picking up device events for processing if they've stopped in any state ([D1-DVEVT](#))

If device events are configured to be held from being sent onto downstream applications, such as to prevent "flicker" outage events (an outage event and a restore event received in rapid succession) from being sent, device event monitoring ([D1-DEVPR](#) and [D1-DVEVT](#)) should be set up to be run periodically to ensure timely transmission of events.

## The Letter Processes

To extract information for your various letters, only one background process, LTRPRT, is required regardless of the different types of letters you have. This process simply calls an algorithm plugged-in on the respective letter template to construct its flat-file content.

The following diagram illustrates the dependencies for the letter background process. While this process should be run at least on a daily basis, you may want to consider running it more frequently (depending on how frequently you produce letters).

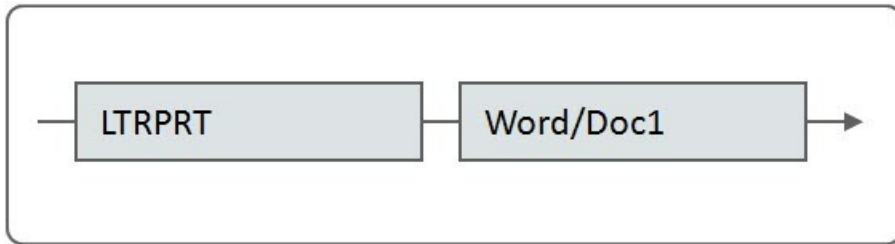

The mnemonics in the boxes refer to the individual batch processes described above. When a box contains multiple processes, these processes must be run sequentially. When multiple boxes exist on a timeline, all processes in an earlier box must execute before the subsequent box is executed.

## The Periodic Processes

The following diagrams illustrate the dependencies between the periodic background processes. You may want to consider running these processes more or less frequently than suggested (depending on business requirements).

### Periodic Processes: Weekly

The following processes should be run roughly once a week, or as per business requirements.

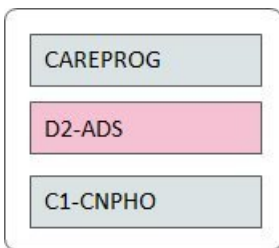

### Periodic Processes: Monthly

The following processes should be run at least once a month, or as per business requirements.

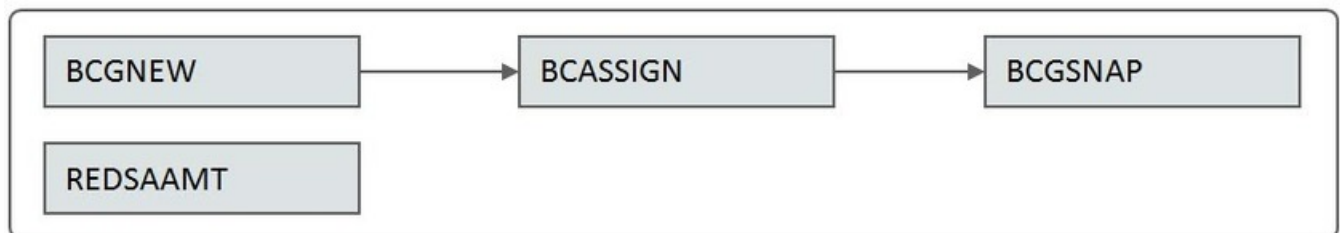

### Periodic Processes: Annually

The following processes should typically be run once a year, or as per business requirements.

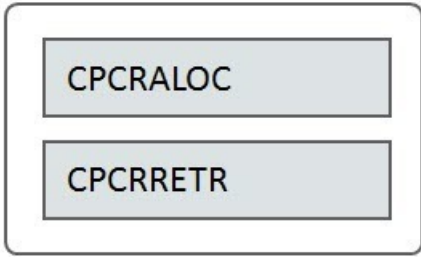

**Periodic Processes: Per Business Requirements**

The following processes should be run as frequently as dictated by business requirements.

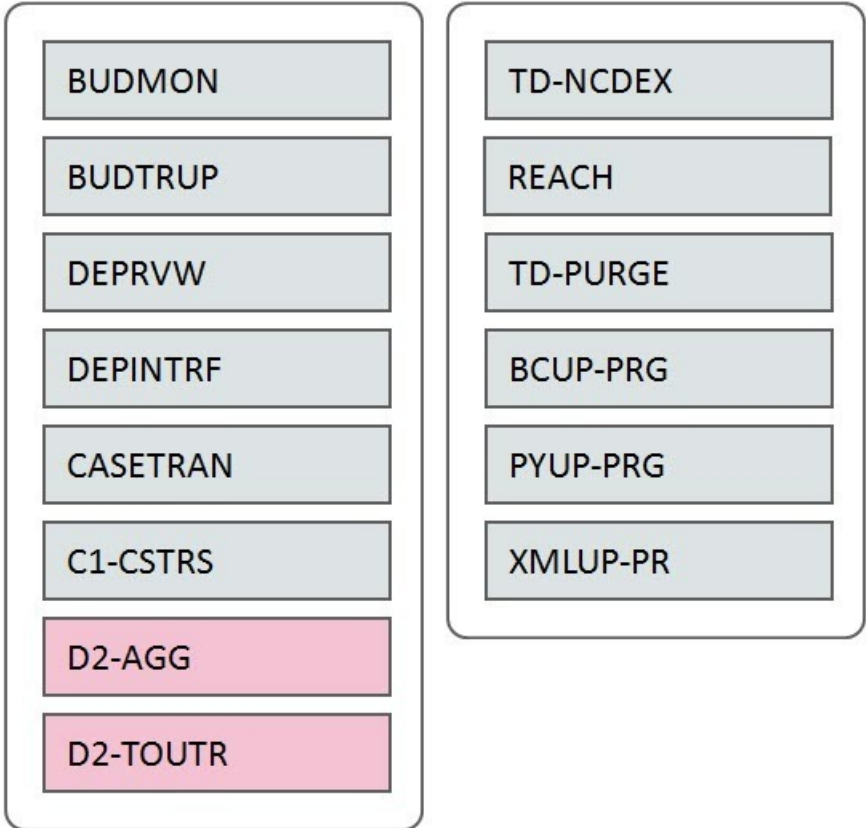

The mnemonics in the boxes refer to the individual batch processes described above.

**NOTE:**

**Few dependencies exist.** As you can see, there are few dependencies between the boxes (meaning they may be run in parallel).

**TOU Map Data Generation**

TOU map data must be in place for all TOU maps used in usage calculations. Generation of this data is performed using the “Time of Use Map Data Generation Monitor” batch control (D1-TOUTr). This process can be performed for long time periods, such as a year, generating data for all time-of-use maps for the entire following year, or it could be done more frequently, such as whenever schedules are updated via the TOU map templates

# Defining General Options

This section describes control tables that are used throughout Oracle Utilities Customer Care and Billing.

## Defining Installation Options

The topics in this section describe the various installation options that control various aspects of the system that are specific to the Oracle Utilities Customer Care and Billing product.

---

**FASTPATH:**

Refer to [Installation Options - Framework](#) for options that are common to products on the same framework.

---

## Installation Options - Main

Select **Admin > General > Installation Options** and use the **Main** page to define system-wide installation options.

### Description of Page

Use **Quick Add Tender Type** to define the tender type [defaulted on payments added using the Payment Quick Add transaction](#).

Use **Starting Balance Tender Type** to define the tender type of the starting balance recorded on your tender controls (this will almost always be the tender type associated with "cash"). This value is used during tender control balancing as a separate balance is required for each tender type in order to balance a tender control. Refer to [The Lifecycle Of A Tender Control](#) for more information.

---

**FASTPATH:**

For more information, refer to [Setting Up Tender Types](#).

---

Turn on the **Create Field Activity Start Stop** if field activities should be created when a start or stop is recorded (as opposed to shortly before the start/stop date). You might want to turn this switch off if it's possible for the state of the service point (or its meter / item) to change between the time service is requested and the actual service date. Why? Because the state of the service point and the state of its meter / item affects the type of field activity that is created. For example, if a customer wants to start service and there is no meter at the metered service point, an "install meter" field activity is created. However, if by the time the install date comes around, a meter has been installed by some other means; this field activity is inappropriate. This is why you might want to setup the system to wait until shortly before the service date to create the field activity (i.e., it reduces the likelihood that an inappropriate field activity is created). Refer to [Starting Service and Field Activities](#) for more information.

If you use orders to create new customers, define the **Campaign** that should be defaulted on orders created when the order transaction is opened for a new customer. Refer to [Real time Marketing of Services to a New Customer](#) for more information.

Use the **Premise Geo Type** to indicate whether at least one geographic identifier (e.g., GPS coordinate) is Required or Optional on a premise. Refer to [Defining Geographic Types](#) for more information.

The **Alternate Representation** flag should be set to None unless your organization uses multiple character sets for a person's main name and / or a premise's address. Alternate representations are typically only used in countries where multiple character sets are used. For example,

- In Hong Kong, a person's name may be written in both Chinese characters and in English.
- In Japan, a person's name may be written in both Kanji and Katakana.

In both of the above situations, users need to be able to use both representations to find a customer or a premise.

---

**NOTE:**

**Spouses.** If your organization doesn't use multiple character sets, you might want to consider using this functionality for spousal relationships. For example, rather than setup a person for each party in a spousal relationship, you could simply define one party using the person's main name and the spouse using the alternate name. While this is a bit of a "hack", it might be sufficient for your implementation as it will be much easier for an end user to use.

**Alerts that should appear adjacent to a person's name or address.** If your organization doesn't use multiple character sets, you might want to consider using this functionality to implement critical person or premise alerts. For example, if you have a customer who's supported by a specific account representative, you could enter the account rep's name as the person's alternate name. If you do this, the account rep's name would appear in parenthesis following the customer's name. In addition, you can search for the customers supported by the account rep on Control Central by entering the account rep's name. This is a bit of a "hack", but it might prove useful for a variety of functions.

---

If your organization uses alternate representations of person name or address, set this flag to one of the following values:

- Use a value of Address if you only use alternate representations for premise addresses.
- Use a value of Name if you only use alternate representations for a person's primary names.
- Use a value of Name & Address if you use alternate representations for both premise addresses and person names.

The following points describe the ramifications of this flag in the system:

- If you support alternate representations of a person's primary name,
- The name grid on [Person - Main](#) allows you to specify an Alternate name for the person.
- If you use the base package [name formatting algorithm](#), a person's name will be shown throughout most of the system in the format AAA (BBB), where AAA is the person's primary name and BBB is the person's alternate name. Note, this format does not apply to names that appear in search results (i.e., the alternate name is not concatenated to the main name in search results; however you can search for information using the alternate name).
- Most of the system's person name-oriented searches will allow users to use both a person's primary and alternate names to search for information.
- If you support alternate representations of a premise's address,
- A new tab is available on the [Premise](#) page that allows a user to define an alternate address for a premise.
- If you use the base package [address formatting algorithm](#), a premise's address will be shown throughout most of the system in the format AAA (BBB), where AAA is the premise's primary address and BBB is the premise's alternate address.
- Most of the system's premise-oriented searches will allow users to use both a premise's primary and alternate addresses to search for information.

If the CTI Integration flag has been enabled, set the **CTI Integration** flag to Yes if your organization integrates with an external computer telephony integration (CTI) system that supports a "get next caller in the queue" function.

The **Control By CIS Division** flag affects system behavior in many areas. This flag should be set if your business operates in different jurisdictions and CIS Division is used to delineate accounts and premises that users can access. When this flag is set, all users must be associated with at least one CIS division. See [Users and CIS Division](#) for more information.

The following system behaviors are affected by this flag:

- On Person, CIS Division is presented and is required when adding an account. Customer class is defaulted after CIS Division is set.



- On Order, CIS Division is presented when a new account is being added and is required. Customer class is defaulted after CIS Division is set..
- On Person, Order, Account and Premise, the list of CIS Divisions that can be chosen is restricted to the CIS Divisions associated with the user. The user's primary CIS Division is defaulted.
- On Account, CIS Division is presented before customer class. Customer class is defaulted after CIS Division is set.

The **Premise/SP Search** flag is used to provide access security to premises and service points that are not linked to an account.

- When the flag is set to Not Restricted, access to premises and service points that are not linked to an account is not secured.
- When the flag is set to Restricted by CIS Division, access to premises and service points that are not linked to an account is secured by the user's CIS Divisions. If the premise has a CIS Division, then only users that have access to that CIS division can access that premise or its service points. See Users and CIS Division for more information. Premise and service points belonging to premises without a CIS Division. Are not secured. A Premise Type setting can control whether premises of that type require a CIS Division.

---

**NOTE:** Premises and service points that are linked to an account are secured by the account access group

---

**WARNING:**

In order to improve response times, installation options are cached the first time they are used after a web server is started. If you change this field's option and you don't want to wait for the cache to rebuild, you must clear the cached information so it will be immediately rebuilt using current information. Refer to [Caching Overview for information](#) on how to clear the system login cache (this is the cache in which installation options are stored).

---

## Installation Options - Person

Select **Admin > General > Installation Options** and use the **Person** page to define person-specific installation options.

### Description of Page

Use the **Person ID Usage** to indicate whether or not at least one form of identification is Required or Optional when a new person is added.

Each form of identification has an identifier type. For persons that are humans (as defined by the person type), the system defaults the identifier type defined in **Identifier Type (Person)**. For persons that are businesses (as defined by the person type), the system defaults the identifier type defined in **Identifier Type (Business)**.

## Installation Options - Account

Select **Admin > General > Installation Options** and use the **Account** page to define account-specific installation options.

### Description of Page

When a new account is added, the system requires it have a customer class. If the main customer linked to the account is a human (as defined by the customer's person type), the system defaults the customer class defined in **Customer Class (Person)**. For persons that are businesses (as defined by the person type), the system defaults the customer class defined in **Customer Class (Business)**. For more information, refer to [Setting Up Customer Classes](#).

In addition to requiring a customer class when a new customer is added, the system also requires a "main customer" (i.e., a reference to a person who is identified as the main customer for the account). Enter the default **Account Relationship Type Code** to be used to define the main customer relationship. For more information, refer to [Setting Up Account Relationship Codes](#).

Enter the default **Bill Route Type** to be used to define how bills should be routed to a customer. For more information, refer to [Setting Up Bill Route Types](#).

Enter the default **Quote Route Type** to be used to define how quotes should be routed to a customer. For more information, refer to [Setting Up Quote Route Types](#).

If the number of pending start and pending stop service agreements exceeds the **Start Stop Detail Threshold** for an account, it is considered a large account for start stop purposes. Refer to [Start/Stop Maintenance](#) for more information.

## Installation Options - Billing

Select **Admin > General > Installation Options** and use the **Billing** page to define billing-specific installation options.

### Description of Page

The **Bill Segment Freeze Option** controls when a service agreement's balance and the general ledger is affected by bill segments and certain types of adjustments. Refer to [Preventing SA Balances And The GL From Being Impacted Until Bill Completion](#) to understand the significance of this option.

The **Accounting Date Freeze Option** controls how the accounting date defined on financial transactions is populated. Refer to [Forcing The Freeze Date To Be Used As The Accounting Date](#) to understand the significance of this option.

Define the **Rollover Threshold Factor** used by billing to determine if a register's consumption is sensible. This value is used as follows:

- Whenever billing calculates a meter's register's consumption, it compares it to a value equal to X times the register's maximum capacity (where X is the Rollover Threshold Factor).
- If consumption exceeds this value, a bill segment error is generated. If this consumptive value is correct, a user will need to override the consumption value billed on the bill segment (billing will never use such a read).

Define the **Minimum Amount for Final Bill**. If a final bill is less than this amount, the bill is still produced; it's just not printed.

Typically, the system sets a bill's Bill Date equal to the date on which it is completed. If you want to be able to specify a bill's Bill Date when you complete a bill, turn on **User Can Override Bill Date**. You would only want to override the bill date if you are setting up sample bills from historical period whose bill date needs to reflect the respective historical period.

Turn on **Use High Low Failures on Bill** if the system should mark meter reads that fail high / low checks as billable. Turn off this switch if such reads should not be used by billing. Users may override this default value on a specific read. Refer to [Validations](#) for more information.

**Base Time** is used by billing algorithms to determine the effective start and end times for a given period. The **Start Day Option** further defines how to use the base time, indicating whether the base time is for the Current Day or for the Previous Day.

Turn on **Use Alternative Bill ID** if your implementation uses assigned document numbers or sequential bill numbers. In the **Alternative Bill ID Option** list:

- Select **Document Numbers** if you require a system-assigned document number for each bill in addition to the Bill Id, which is a system-assigned random number used as the bill's primary identifier. Refer to [Document Numbers](#) for more information.
- Select **Sequential Bill Numbers** if you require a system-assigned unique sequential number for each bill in addition to the Bill Id, which is a system-assigned random number used as the bill's primary identifier. Refer to [Sequential Bill Numbers](#) for more information

---

### NOTE:

**Document Number Algorithms.** In addition to turning on **Use Alternative Bill ID** and specifying the **Alternative Bill ID Option**, the **Document Number** and **Document Number Details** algorithms must be enabled on the **Installation** record. These algorithms contain the logic used by the system to assign a document number to a bill.

---

The **Bill Correction** option lets you control whether your implementation uses Credit Notes or Correction Notes. Select the **Credit Note** option if you require bill segment cancellation details to be presented to the customer on a separate bill (referred to as a credit note). Refer to **Credit Notes** for more information. Select the **Correction Note** option if you require bill segment cancellation details and bill segment rebill details to be presented to the customer on a separate bill (referred to as a correction note). Refer to **Correction Notes** for more information.

---

**NOTE:**

**Credit Notes or Correction Notes.** The Bill Correction option on the Installation record controls whether Credit Notes or Correction Notes are allowed. If your implementation uses Correction Notes, the override label on the following should be customized accordingly:

Lookup value CRNT on the customizable lookup field TXN\_FLTR\_TYPE\_FLG (this lookup value is used on the Match Event Page and Account Bill History transactions)

Lookup value CR on the customizable lookup field PYCAN\_SYS\_DFLT\_FLG (this lookup value is used on the Pay Cancel Reason transaction)

Metadata field CR\_NOTE\_FR\_BILL\_ID (this field is used on the Bill Search Page)

---

The **Autopay Creation Option** controls when automatic payments are created, distributed, and frozen. This option allows you to control when automatic payments will affect customer's balances and when their financial impact affects the general ledger. Refer to **How And When Are Automatic Payments Created** to understand the significance of this option.

## Installation Options - C&C

Select **Admin > General > Installation Options** and use the **C&C** page to define credit and collections-specific installation options.

### Description of Page

When you look at an account or service agreement's debt, the system shows the respective age of each piece of outstanding debt. The **Oldest Bucket Age (Days)** defines the debt age after which the system groups all outstanding debt together. For example, if this field is 180:

- The exact age of each element of debt that is less than 180 days old would be shown as a separate line item in the aged debt information.
- All debt older than 180 days would be amalgamated into a single "bucket".

**Oldest Bucket Age (Days)** also has another use - it defines the age of financial transactions that are considered by the background process that marks old debt as "redundant". This batch process is referred to by the batch code of REDSAAMT.

---

**WARNING:**

If you change the value of **Oldest Bucket Age (Days)** after debt has been marked as "redundant" by REDSAAMT, the system will NOT re-age the old debt (i.e., once a financial transaction has been marked as "redundant", it is "redundant" forever).

---

Enter what you consider to be an excellent credit rating in **Beginning Credit Rating**. Collection events can cause an account's credit rating to decrease. When an account's credit rating falls below a certain level, different collection processes may ensue.

---

Use **Beginning Cash-Only Score** to define the cash-only score for accounts with a perfect payment history (i.e., one without non-sufficient funds). When you cancel a payment tender and use a cancellation reason marked as NSF, the system will cause the account's cash-only score to increase by the value on the payment cancellation reason.

Use **Credit Rating Threshold** to define when an account's credit rating becomes risky. When an account's credit rating falls beneath the Credit Rating Threshold, the system will:

- Assuming you've enabled the Control Central alert algorithm, [C1-CRRT-ACCT](#), an alert displays when an account's credit rating falls below the credit rating threshold on the installation record. This algorithm is plugged-in on the [installation record](#).
- Subject the account's debt to different collection criteria. For more information, refer to [Designing Your Collection Class Control Overrides](#).

Use **Cash-Only Threshold** to define the number of cash-only points a customer must have before the system warns the CSR accepting payments that the account is cash-only.

## Installation Options - Financial Transaction

Select **Admin > General > Installation Options** and use the **Financial Transaction** page to define financial transaction installation options.

### Description of Page

Use **G/L Batch Code** to define the batch process that is used to interface your financial transactions to your general ledger. The process is snapped on FT download records by the GLS background process.

Use **A/P Batch Code** to define the batch process that is used to interface your check requests (initiated with adjustments with an adjustment type that reference an A/P request type) to you accounts payable system.

Use **Fund Accounting** to indicate if [fund accounting](#) is Practiced or Not Practiced at your organization.

Use **Alternate Currency** to indicate if your organization accepts customer payments in currencies other than the account's currency.

---

#### FASTPATH:

Refer to [Alternate Currency Payments](#) to understand the significance of this option.

---

## Installation Options Framework - Algorithms

Select **Admin > General > Installation Options - Framework** and use the **Algorithms** page to define specific system events.

The following table describes each **System Event**.

System Event	Optional / Required	Description
Account Information	Optional	We use the term "Account information" to describe the basic information that appears throughout the system to describe an account. The data that appears in "account information" is constructed using this algorithm.  Plug an algorithm into this spot to override the system default "Account information".  Click <a href="#">here</a> to see the algorithm types available for this system event.

Adjustment Information	Optional	<p>We use the term "Adjustment information" to describe the basic information that appears throughout the system to describe an adjustment. The data that appears in "Adjustment information" is constructed using this algorithm.</p> <p>Plug an algorithm into this spot to override the system default "Adjustment information".</p> <p>Note: This algorithm may be further overridden by an "Adjustment information" plug-in on the Adjustment Type. Refer to <a href="#">Adjustment Type</a> for how algorithms of this type are used.</p> <p>Click <a href="#">here</a> to see the algorithm types available for this system event.</p>
Appointment Information	Required	<p>We use the term "Appointment information" to describe the basic information that appears throughout the system to describe an appointment. The data that appears in "appointment information" is constructed using this algorithm.</p> <p>Click <a href="#">here</a> to see the algorithm types available for this system event.</p>
Auto Pay Creation	Required if you allow customers to <a href="#">pay automatically</a>	<p>This algorithm is executed to create automatic payments whenever the system creates automatic payments. Refer to <a href="#">How And When Are Automatic Payments Created</a> for the details.</p> <p>Click <a href="#">here</a> to see the algorithm types available for this system event.</p>
Bill Cycle Selection	Optional	<p>This algorithm is only used if your organization has specific rule for assign a bill cycle to an account. This plug-in spot is invoked by the SA Activate/Stop common routine. The spot is called right after the system has updated the account.</p>
Bill Information	Required	<p>We use the term "Bill information" to describe the basic information that appears throughout the system to describe a bill. The data that appears in "bill information" is constructed using this algorithm.</p> <p>Click <a href="#">here</a> to see the algorithm types available for this system event.</p>
Bill Segment Information	Optional	<p>We use the term "Bill segment information" to describe the basic information that appears throughout the system to describe a bill segment. The data that appears in "bill segment information" is constructed using this algorithm.</p>

		Click <a href="#">here</a> to see the algorithm types available for this system event.
Case Information	Optional	<p>We use the term "Case information" to describe the basic information that appears throughout the system to describe a case. The data that appears in "case information" is constructed using this algorithm.</p> <p>Plug an algorithm into this spot to override the system default "Case information".</p> <p>Note: This algorithm may be further overridden by a "Case information" plug-in on the Case Type. Refer to <a href="#">Case Type</a> for how algorithms of this type are used.</p> <p>Click <a href="#">here</a> to see the algorithm types available for this system event.</p>
Collection Agency Referral Information	Optional	<p>We use the term "Collection Agency Referral information" to describe the basic information that appears throughout the system to describe a collection agency referral.</p> <p>Plug an algorithm into this spot to override the system default "collection agency referral information".</p> <p>Click <a href="#">here</a> to see the algorithm types available for this system event.</p>
Collection Process Information	Optional	<p>This algorithm displays additional information related to a collection process in a special field on the <a href="#">collection process</a> main page.</p> <p>Click <a href="#">here</a> to see the algorithm types available for this system event.</p>
Control Central Alert	Optional	<p>There are two types of alerts that appear in the <a href="#">Alert Zone</a> and on <a href="#">Payment Event - Main</a>: 1) hard-coded system alerts and 2) alerts constructed by plug-in algorithms. You cannot change the hard-coded alerts (see the <a href="#">Alert Zone</a> for the complete list). However, by plugging in this type of algorithm you can introduce additional alerts.</p> <p>An error displays if more than 60 alerts are generated for an account by plug-in algorithms.</p> <p>Click <a href="#">here</a> to see the algorithm types available for this system event.</p>
Credit Rating 'Created By' Information	Required	<p>The data that appears in the credit rating "created by" information is constructed using this algorithm.</p> <p>Refer to <a href="#">Account - C&amp;C</a> for more information about the credit rating.</p> <p>Click <a href="#">here</a> to see the algorithm types available for this system event.</p>

Credit Rating History Information	Optional	<p>We use the term Credit Rating History information to describe the basic information that appears throughout the system to describe a <a href="#">credit rating history</a> entry.</p> <p>Plug an algorithm into this spot to override the system default "credit rating history information".</p> <p>Click <a href="#">here</a> to see the algorithm types available for this system event.</p>
Digital Signature	Optional	<p>This algorithm is only used if your organization generate and store digital signatures for each bill.</p> <p>Refer to <a href="#">Digital Signatures</a> for the details.</p>
Document Number	Optional	<p>If document numbers have been enabled on the installation record, this algorithm type assigns a document number to a bill or payment event.</p> <p>Click <a href="#">here</a> to see the algorithm types available for this system event.</p>
Document Number Details	Optional	<p>If document numbers have been enabled on the installation record, this algorithm type is responsible for returning the details used to construct the document number.</p> <p>Click <a href="#">here</a> to see the algorithm types available for this system event.</p>
Determine Open Item Bill Amounts	Required if you use overdue functionality to <a href="#">collect on bills</a>	<p>This algorithm is responsible for determining the unpaid amount of an open-item bill. It can also be used to return the unpaid amount for a specific SA on a bill.</p> <p>Click <a href="#">here</a> to see the algorithm types available for this system event.</p>
Document Sequence Number	Optional	<p>If document numbers have been enabled on the installation record, this algorithm type is responsible for generating document sequence number only. Click <a href="#">here</a> to see the algorithm types available for this system event.</p>
FA Additional Information	Optional	<p>This algorithm displays additional information related to a field activity in a special field called Additional Info on the <a href="#">field activity</a> main page.</p> <p>For example, contact information linked to the field activity's field order may be displayed.</p> <p>Click <a href="#">here</a> to see the algorithm types available for this system event.</p>
FA Information	Required	<p>We use the term FA information to describe the basic information that appears throughout the system to describe a <a href="#">field activity</a>. The</p>

data that appears in "FA information" is constructed using this algorithm.

Click [here](#) to see the algorithm types available for this system event.

---

Item Information	Required if you have items	<p>We use the term "Item info" to describe the basic information that appears throughout the system to describe an item. The data that appears in "Item info" is constructed using this algorithm.</p> <p>Click <a href="#">here</a> to see the algorithm types available for this system event.</p>
Meter Information	Required if you have meters	<p>We use the term "Meter info" to describe the basic information that appears throughout the system to describe a meter. The data that appears in "Meter info" is constructed using this algorithm.</p> <p>Click <a href="#">here</a> to see the algorithm types available for this system event.</p>
Meter Read High Low Limits	Not used with Customer To Meter	<p>Click <a href="#">here</a> to see the algorithm types available for this system event.</p>
Online Bill Display	Optional	<p>This algorithm constructs a PDF that contains the image of a bill. This algorithm is executed when the Display Bill button is clicked on the <a href="#">Bill</a> page. Refer to <a href="#">Technical Implementation of Online Bill Display</a> for more information.</p> <p>Click <a href="#">here</a> to see the algorithm types available for this system event.</p>
Online Field Order Display	Optional	<p>This algorithm constructs a PDF that contains the image of a field order.</p> <p>Click <a href="#">here</a> to see the algorithm types available for this system event.</p>
Online Letter Display	Optional	<p>This algorithm constructs a PDF that contains the image of a letter. This algorithm is executed when the Display Letter button is pressed on <a href="#">Customer Contact - Main</a>. Refer to <a href="#">Technical Implementation of Online Letter Display</a> for more information.</p> <p>Click <a href="#">here</a> to see the algorithm types available for this system event.</p>
Online Quote Display	Optional	<p>This algorithm constructs a PDF that contains the image of a quote. This algorithm is executed when the Display Quote button is pressed on <a href="#">Quote - Main</a>. Refer to <a href="#">Technical Implementation of Online Quote Display</a> for more information.</p> <p>Click <a href="#">here</a> to see the algorithm types available for this system event.</p>
Online Statement Display	Optional	<p>This algorithm constructs a PDF that contains the image of a statement. This algorithm is</p>

---



executed when the Display Statement button is pressed on [Statement - Main](#). Refer to [Technical Implementation of Online Statement Display](#) for more information.

Click [here](#) to see the algorithm types available for this system event.

---

Override Proration Factors	Optional	<p>This algorithm is only used if your organization has unusual rate proration requirements that necessitate the overriding of the base package proration logic. For example, you may have certain calculation rules whose charges should never be prorated. Refer to <a href="#">Overriding Proration Factors</a> for more information.</p> <p>Click <a href="#">here</a> to see the algorithm types available for this system event.</p>
Override Seasonal Proration	Optional	<p>This algorithm is only used if your organization has unusual method of determining the seasons for your calculation rules. For example, you may determine the seasonal boundaries for a calculation rule based on the scheduled meter read date associated with the bill cycle.</p> <p>Click <a href="#">here</a> to see the algorithm types available for this system event.</p>
Payment Amount Calculation	Required	<p>This algorithm is executed to calculate the amount of an automatic payment for a bill for an account with an active auto pay option. Refer to <a href="#">How And When Are Automatic Payments Created</a> for more information on automatic payments. This algorithm is also executed to default the amount of a manually added payment. Refer to <a href="#">How To Add A New Payment Event</a> for more information on adding a payment manually.</p> <p>Click <a href="#">here</a> to see the algorithm types available for this system event.</p>
Payment Event Information	Optional	<p>We use the term "payment event information" to describe the basic information that appears throughout the system to describe a payment. The data that appears in "payment information" is constructed using this algorithm.</p> <p>Click <a href="#">here</a> to see the algorithm types available for this system event.</p>
Payment Information	Required	<p>We use the term "payment information" to describe the basic information that appears throughout the system to describe a payment. The data that appears in "payment information" is constructed using this algorithm.</p>

---

		Click <a href="#">here</a> to see the algorithm types available for this system event.
Person Information	Required	<p>In most parts of the system, a person's Main name is displayed to describe a person. However, several transactions do not use this method. Rather, these transactions call the algorithm that's plugged into this spot to construct the person's name. Refer to the description of the <b>Alternate Representation</b> flag on the <b>Main</b> tab for a list of these transactions and for the rationale behind this algorithm.</p> <p>Click <a href="#">here</a> to see the algorithm types available for this system event.</p>
Person Name Format	Required	<p>The format of names entered on <a href="#">Person - Main</a> and <a href="#">Order - Main</a> is validated using this algorithm.</p> <p>Click <a href="#">here</a> to see the algorithm types available for this system event.</p>
Premise Information	Required	<p>We use the term "premise info" to describe the basic information that appears throughout the system to describe a premise. The data that appears in "premise info" is constructed using this algorithm.</p> <p>Click <a href="#">here</a> to see the algorithm types available for this system event.</p>
SA Information	Optional	<p>We use the term "SA information" to describe the basic information that appears throughout the system to describe a service agreement. The data that appears in "SA information" is constructed using this algorithm.</p> <p>Plug an algorithm into this spot to override the system default "SA information".</p> <p>Note: This algorithm may be further overridden by an "SA information" plug-in on the SA Type. Refer to <a href="#">SA Type - Algorithms</a> for how algorithms of this type are used.</p> <p>Click <a href="#">here</a> to see the algorithm types available for this system event.</p>
Severance Process Cancellation	Optional	<p>This algorithm is executed to perform additional processing when the system cancels a severance process.</p> <p>Note: This algorithm is executed before the <a href="#">Severance Process Template - Post Cancel Algorithm</a> is executed. Canceling a severance process on-line manually does not execute this algorithm.</p> <p>Click <a href="#">here</a> to see the algorithm types available for this system event.</p>

We use the term "SP info" to describe the basic information that appears throughout the system to describe a service point. The data that appears in "SP info" is constructed using this algorithm.

Click [here](#) to see the algorithm types available for this system event.

---

## Defining Customer Languages

As described under [Defining Languages](#), you define the language in which each user see the system. In addition to defining each user's language, the system allows you to define each customer's preferred language. For example, one customer can receive bills in English whereas another customer could receive their bills in Chinese.

Each customer's language is defined by the [language code](#) on their [person record](#). Bills, adjustments and other system-generated records will then be done in the language of the main customer of the account. In addition, the language code is passed on to all customer-facing interfaces, such as letter requests and bill print.

---

**NOTE:**

You can define Rates in multiple languages - when a bill is generated, the line-item descriptions are generated and stored in the account's main customer's language of choice. Anyone who subsequently views these bills can only see the descriptions in that language.

To support bills and other correspondence, you must also provide translations of standard bill stock and letters. This must be handled by your printing software vendor.

---

## Defining Accounting Calendars

Accounting calendars determine the accounting period to which a financial transaction will be booked. The following points describe how the system determines a financial transaction's account period:

- Every financial transaction references an accounting date and its service agreement
- Every service agreement references a service agreement type
- Every service agreement type references a GL division
- Every GL division references an accounting calendar
- The accounting calendar contains the cross-reference between the accounting date specified on the financial transaction and related accounting period in your general ledger

---

**WARNING:**

This information must be the same as the information in your financial database.

---

To add or review an accounting calendar, choose **Admin > General > Accounting Calendar > Search**.

### Description of Page

Enter a unique **Calendar ID** and **Description** for the calendar.

Enter the **Number Of Periods** for the calendar. Don't count the adjustment period, if you use one, or any special "system" periods.

Specify the **Fiscal Year**, each **AccountingPeriod** in that year, a **Period Description**, the **Begin Date** and the **End Date**.

When you enter begin and end dates, you can define monthly calendar periods or any fiscal period that matches your accounting calendar (weekly, bimonthly) as long as the begin and end dates of successive periods do not overlap. Every day of the year must be included in a period; do not leave gaps between period dates.

For each fiscal period, enter the **Open From Date** and **Open To Date**. These dates define when that particular business dates are open for posting financial transactions to that fiscal period. For example, you might calculate a bill on Sept 1 for usage recorded on 31 August. To post this financial transaction in the August period, you must keep it open through Sept 1.

As time passes, you will need to return to this transaction to manually enter ensuing years. You can enter several years at a time or incorporate the task into end-of-year system maintenance.

#### Where Used

Follow this link to open the data dictionary where you can view the tables that reference [CI\\_CAL\\_GL](#)

## Defining General Ledger Divisions

There are two types of Divisions referenced in the system: a CIS Division and a GL Division. This is a rather powerful structure, but it can be confusing.

- General Ledger divisions typically comprise individual entities (e.g., companies) in your general ledger. You must set up a GL division for each such entity. The GL division's sole purpose in the system is to define the accounting period associated with financial transactions linked to service agreements associated with the GL division (service agreements are associated with GL divisions via their SA type). The system cares about accounting periods in order to prevent a user from booking moneys to closed periods. It also uses accounting periods when it produces the flat file that contains the consolidated journal entry that is interfaced to your general ledger (refer to [The GL Interface](#) for more information).

---

#### NOTE:

When determining how many GL Divisions you need, be sure to consider your general ledger and how your chart-of-accounts is structured. You will typically have one GL division for each "company" in your general ledger.

- A CIS division is typically associated with a jurisdiction. The definition of a jurisdiction is a geographic-oriented entity with unique business rules. For example, if you conduct business in California and Nevada, and each state has different collection rules, you will need a separate jurisdiction for each state. You must set up a CIS division for each jurisdiction in which you conduct business.

---

#### FASTPATH:

Refer to [CIS Division Portal](#) for information about CIS Divisions.

---

To define a general ledger division, select **Admin > General > General Ledger Division**.

#### Description of Page

Enter a unique **GL Division** for the general ledger division.

Enter a **Description** of this general ledger division.

Define the accounting **Calendar ID** that controls how to convert an FT's accounting date into an accounting period. Refer to [Defining Accounting Calendars](#) for more information.

You may define a **Currency Code** for the GL division. Note that the system does not use this currency code.

#### Where Used

Follow this link to open the data dictionary where you can view the tables that reference [CI\\_GL\\_DIVISION](#).

## Defining Banks & Bank Accounts

The topics in this section describe how to maintain your implementation's bank accounts.

### Bank - Main

To review Banks choose **Admin > Financial > Bank > Search**.

#### Description of Page

Enter a unique **Bank Code** and **Description** for the bank.

The **Bank Accounts** collection displays the bank accounts currently linked to this bank code. Use the drill down button to view more details or to modify the bank account details. Alternatively, you may navigate to the Bank Account tab and scroll to the desired bank account.

### Bank - Bank Account

To review Bank Accounts for a Bank, choose **Admin > Financial > Bank > Search** and then navigate to the **Bank Account** page.

#### Description of Page

Use the **Bank Accounts** tab to define the attributes of each bank account. For each account, enter the following information:

- Enter a **Bank AccountKey** to identify an Account at a Bank. You may have more than one account at a given bank, and you may have accounts at more than one bank. This code will allow the system to easily identify a specific account.
- Enter a **Description** to appear on prompt lists, inquiries, and reports.
- Enter the **Account Number**, **Check Digit** and if needed, the **Branch ID** of the bank where the account is held.
- Enter the **CurrencyCode** for the currency in which the account is denominated.
- Use **DFI ID** to define the Depository Financial Institution ID that is interfaced to the automatic payment-processing agent as part of the automatic payment interface.
- Enter the **Distribution Code** to be used for cash GL distributions when a payment is frozen or canceled.

#### Where Used

Follow this link to open the data dictionary where you can view the tables that reference [CI\\_BANK\\_ACCOUNT](#).

## Defining Issuing Centers

This section provides information about defining issuing centers that are used to assign document numbers to bills and payment events. An issuing center should be configured for each location that issues bills. The installation record [Document Number](#) and [Document Number Details](#) algorithms contain the logic used by the system to assign a document number to a bill. To set up an issuing center, open **Admin > General > Issuing Center > Add**.

---

#### FASTPATH:

Refer to [Document Numbers](#) for information about document number assignment.

---

---

**NOTE:**

**This section is only relevant for some organizations.** The information in this section is only relevant if your organization indicated on the installation record that it uses document numbers as an alternative bill id. If your organization does not use document numbers as an alternative bill id, then no other setup is required.

---

The topics in this section describe the base-package zones that appear on the Issuing Center portal.

## Actions

This is a standard [actions zone](#).

If the issuing center is in a state that has valid next states, buttons to transition to each appropriate next state are displayed.

## Issuing Center List

The Issuing Center [List zone](#) lists every issuing center. The following functions are available:

- Click a [broadcast](#) button to open other zones that contain more information about the adjacent issuing center.
- Click the Add link in the zone's title bar to add a new issuing center.

## Issuing Center

The Issuing Center zone contains display-only information about an issuing center, including its current and historic branches. This zone appears when an issuing center has been broadcast from Issuing Center List zone or if this portal is opened via a drill down from another page.

Please see the zone's help text for information about this zone's fields.

## Issuing Center Log

This is a standard [log zone](#).

## Defining Service Tasks Options

This section describes concepts and procedures related to service tasks.

## About Service Tasks

Service tasks are records that can be used to perform a variety of tasks. Examples include:

- Task-related records performed by users of other Oracle Utilities applications, such as Oracle Utilities Customer Self Service.
- Task-related records performed by Oracle Utilities Customer Care and Billing to manage specific processing, such as net energy metering true-ups, or prepaid billing to create bill segments for smart meter prepaid service agreements.

The main attribute used to define a service task is service task type. The service task type defines properties common to specific types of service tasks.

For more information, see [Searching and Viewing Service Tasks](#).

## About Service Task Types

Service task types define properties common to specific types of service tasks. Service task types represent different types of tasks that can be performed by:

- Users of other Oracle Utilities applications, such as Oracle Utilities Customer Self Service. An example of a service task includes self service meter reads, in which users enter their own meter reads via the Customer Self Service application.
- Oracle Utilities Customer Care and Billing to manage specific processing. Examples include net energy metering true-ups, or prepaid billing to create bill segments for smart meter prepaid service agreement.

Service task types can be defined by the following attributes:

- **Service Task Type:** the name of the task type.
- **Service Task Type Business Object:** the business object that defines the behavior of the service task type.
- **Service Task Business Object:** the business object instantiated when service tasks of this type are created.
- **Service Task Class:** the category used to define service task types for reporting purposes (self-service, miscellaneous, etc).
- Other data based on the specific type of service task (such as minimum days in true-up period, billing frequency, or default payment method.)

For more information about defining service task types, see [Defining Service Task Types](#).

For more information about the service task types delivered with the application, see [Base Package Service Task Types](#).

## Defining Service Task Types

To maintain existing service task event types, select **Admin > Customer > Service Task Type**, then use standard actions to edit, duplicate, or delete a service task type.

To define a new service task type, follow these steps:

1. Select **Admin > Customer > Service Task Type**.
2. Enter a name and a meaningful description for the service task type.
3. If needed, select the business object to use when creating service tasks of this type.
4. Select the service task class applicable to service tasks of this type, if applicable.  
Some service tasks types used solely by Oracle Utilities Customer Care and Billing have a default class of **Miscellaneous**.
5. Enter a detailed description for the service task type.
6. Complete the remaining fields and sections, as needed.
7. If applicable, select a To Do type and corresponding To Do role to use when creating To Do entries related to service tasks of this type.
8. Click **Save**.

This service task type can now be used when service tasks are received from other Oracle Utilities applications, such as Oracle Utilities Customer Self Service, or service tasks created specifically by Oracle Utilities Customer Care and Billing. For more information about service task types, see [About Service Task Types](#).

For more information about the service task types delivered with the application, see [Base Package Service Task Types](#).

## Base Package Service Task Types

This section provides descriptions of the service task types provided with the base package.

Service Task Type	Business Object	Detailed Description	Related Transaction Business Object
Appointment Notification Task Type	C1-NotifyAppointmentTaskType	This business object is used to capture the information to use in appointment notification processing.	Appointment Notification Task
Create Customer Contact Task Type	C1-CreateCustContactTaskType	This business object is used to capture the information to use in create customer contact task processing.	Customer Contact Request Task
Direct Debit Task Type	C1-DirectDebitMandateTaskType	This business object defines configuration information that is used for processing Single Euro Payments Area (SEPA) direct debit transactions.	Direct Debit Mandate Task
FA Completion Task Type	C1-FACompletionTaskType	This business object captures the attributes used in field activity completion task processing.	FA Completion Task
Field Activity Remark Task Type	C1-FieldActivityRemarkTaskType	This business object is used to capture the information to use in create field activity remark task processing.	Field Activity Remark Task
Form Task Type	C1-FormTaskType	This business object captures attributes relevant for a particular form type to be used when a self-service customer creates a form.	Form Task
Missed Appointment Notification Task Type	C1-NotifyMissedApptTaskType	This business object is used to capture the information to use in missed appointment processing.	Missed Appointment Notification Task
Notification Task Type	C1-NotifyTaskType	This business object captures information about a notification that is made available for sign-up by self-service users.	Notification Preferences
Net Energy Metering Task Type	C1-NEMTrueUpTaskType	This business object is used to maintain the various configuration options that are used by the true up monitor (TUM) business object's algorithms. It defines the length of the true up period as well as the adjustments types used during the true up process. For true up reversals, the adjustment cancel reason to use is also captured here.	True Up Monitor Task



Outage Call Type	C1-OutageCallType	This business object defines the behavior of an outage call type used to support trouble calls captured in CCB and integrated to NMS.	Outage Call
Payment Arrangement Task Type	C1-PATaskType	This business object defines the expected behavior for when a self-service user requests a payment arrangement.	Payment Arrangement Task
PPB Payment Notification Task Type	C1-PPBPaymentNotifyTaskType	This business object captures information about the Prepaid Billing Payment Request notification that is made available for sign-up by self-service users.	Notification Preferences
Prepay Biller Task Type	C1-PrepayBillerTaskType	This business object defines the behavior of a prepay biller task type used in smart meter prepay billing.	Prepay Biller Task
Product Offer Publish	C1-ProductOffer	This business object contains the product offer elements that are relevant when publishing product offers to Siebel Energy. It is used to read product offer information when building the initial and final snapshots for the sync request.	Not defined
Product Offer Task Type	C1-ProductOfferTaskType	This business object is used to define the behavior of a product offer. Product offers are configured in CCB and published to Siebel Energy.	Not defined
SA Creation Rule Publish	C1-SACreationRule	This business object contains the SA creation rule elements that are relevant when publishing product offers to Siebel Energy. It is used to read SA creation rule information when building the initial and final snapshots for the sync request.	Not defined
SA Creation Rule Task Type	C1-SACreationRuleTaskType	This business object defines the behavior of the SA creation rules for a product offer. Each SA creation rule indicates the type of service agreement to create for the product offer.	Not defined
Service Request Task Type	C1-ServiceRequestTaskType	This business object is used as a parent service task type business object for service request related task types such as appointment notification, missed appointment and customer contact creation requests.	Not defined

Siebel Customer Maintenance Task Type	C1-CustomerMaintenanceTaskType	This business object is used in the Siebel integration. When a customer maintenance request is received from Siebel, an inbound service determines the service task type to use for the event.	Siebel Customer Maintenance Task
Start/Stop Task Type	C1-StartStopTaskType	This business object defines the expected behavior for when a self-service user requests to start, stop or transfer service.	Start/Stop Request Task

## System-wide Options

### Installation Options - Framework

#### Configuring Installation Options - Framework

Installation options define the individual applications installed on your system and identify algorithms used to implement core system functions. These options also define global parameters such as the administrative menu style (alphabetical or functional), the country, language, currency code, as well as the base time zone to use for this implementation.

Installation options are stored in the installation record for your system. Use the Installation Options - Framework portal to configure these options. This portal is part of the OUAF and is described in detail in the Framework documentation.

#### Base Time Zone

The time zone setting of the Installation Options - Framework determines the time zone for all date/times stored within the system. Each date/time, based on the configuration of that field, is stored in either standard or legal time within this base time zone.

Refer to the [Glossary of Terms](#) in the *Oracle Utilities Meter Solution Business User Guide* for definitions Standard Time and Legal Time

Note: The installation record does not dictate the server time zone, but rather must match it.

#### Installation Algorithms

Installation algorithms implement global system functions and can be customized for each implementation. The base package supports the following installation options for Meter Data Management-related system events:

- **Geocoding Service:** Responsible for geocoding an address (converting an address to a geocode latitude/longitude pair).
- **Global Context:** Sets global contexts (displayed in the Global Context dashboard zone) based on the value of existing global contexts. For example, if the Service Point is specified, this algorithm sets the Device by finding the most recently installed Device on the service point. It then sets the Measuring Component by finding the most effective Device Configuration and retrieving any measuring component linked to it. It then sets the Usage Subscription by finding the most recent active usage subscription linked to the service point. The contact is set by finding the main contact for the usage subscription.

Additional detail on how global context is populated can be found in the detailed description of the [D1-GBCTX-DF](#) Algorithm Type.

- To Do Pre-creation: Associates a To Do entry via characteristic to the related the related Device, Measuring Component, Service Point, Contact, Usage Subscription, Activity Type and Activity based on the drill keys of the To Do entry.

---

**NOTE:**

Additional detail on how the To Dos are associated to related data can be found in the detailed description of the [D1-TDPRCRE](#) algorithm type.

See [Installation Options](#) in the Oracle Utilities Application Framework *Administrative User Guide* for related information on the installation portal.

---

## Feature Configurations

### Configuring Feature Configurations

Some of the features in Oracle Utilities Application Framework based applications are configured by populating options on a "feature configuration". For example, if your implementation uses Oracle Utilities Customer Care and Billing's batch scheduler, you must populate a variety of options on the batch scheduler's feature configuration.

---

**NOTE:** Refer to [Defining Feature Configurations](#) in the Oracle Utilities Application Framework *Administrative User Guide* for additional information.

---

Oracle Utilities Meter Data Management uses the following types of feature configurations (please note that more information can be found on each of these options by viewing their detailed description in the Feature Configuration portal):

#### Measurement Data Options

Measurement Data Options are used to define behavior related to periodic estimation of initial measurement data, including:

- **No of Hours in Past to Retrieve Last Usable Measurement:** This option is leveraged by scalar periodic estimation to restrict how far into the past it will search for existing measurements when the last contiguous measurement is being initialized on the measuring component. This is to ensure that the first time scalar period estimation is executed on a large number of measuring components that have not been initialized for periodic estimation the system does not execute a large number of unbounded queries into the past which would result in poor performance.

#### Business Intelligence Configuration

Business intelligence configuration is used to define external data source indicators used when Oracle Utilities Meter Data Management is integrated with Oracle Utilities Business Intelligence. External data source indicators allow business intelligence extracts to properly link the external identifiers to the source external system. The Value of the Data Source Indicator option should match the Environment ID on the Installation Option of the external system.

#### General System Configuration

This feature configuration is owned by Oracle Utilities Application Framework but there are several important option types that have been created specific to Oracle Utilities Meter Data Management:

- **Multi Time Zone Support:** By default the system assumes an installation operates within a single time zone. In order to enable multiple time zone functionality this option must be defined and set to "DIYS".
- **CCB Link URL:** this option is used to provide the destination URL for hyperlinking into Oracle Utilities Customer Care and Billing.
- **Trace On Flag:** can be set to automatically trace any initial measurement being processed. Note: if the initial measurement has had trace explicitly turned off then no tracing will occur. This is useful for tracing initial measurements created through automated processes where you are unable to set the trace flag directly.

- **System Override Date:** this option type is provided by OUAF but it is highly useful in testing prior to production. When set it will override the system date/time for all users. The format must be entered as: YYYY-MM-DD. For example January 1st 2010 would be 2010-01-01.

---

**NOTE:**

Refer to [Configuring Multi-Time Zone Support](#) for additional information on setting up multi-time zone support.

---

## Time Zones

### Configuring Time Zones

To support businesses spanning across multiple time zones, the system stores all date and time information in a single common time zone known as the base time zone or the server time zone. Furthermore, date and time information is stored in either standard time (i.e. independent of any Daylight Savings Time adjustments, if applicable, in that time zone) or legal time (i.e. shifted according to Daylight Savings Time).

The system also allows data to be entered and displayed in a different time zone in legal time ( i.e. adjusted for Daylight Savings Time, managing the conversion back and forth between the data entry time zone and the storage time zone).

Entities associated with a physical location such as measurements (initial and final), measuring components, device configurations, devices, installation events, service points, and usage subscriptions are entered and displayed in the specific time zone where they occur, the entity time zone. The rest of the application uses the base time zone to display date and time information.

When configuring time zones the following fields are of high importance:

- **Time Zone Name:** identifies the Olson time zone and as such defines the appropriate offset from Greenwich Mean Time as well as the schedule for shifting into and out of Daylight Savings Time.
- **Default Time Zone Label:** will be appended to date times that do not fall within Daylight Savings Time
- **Shifted Time Zone Label:** will be appended to date times that do fall within Daylight Savings Time

---

**NOTE:** The server time zone must be correctly specified on the installation options record for the system to work properly.

---

For additional information see [Defining Time Zones](#) in the *Oracle Utilities Application Framework Administrative User Guide*.

### Configuring Multi-time Zone Support

As a default the system assumes operations are in a single time zone. This has a few high level impacts:

- All master data must have a time zone that is equal to the base time zone. As such all master data will have the same time zone and that time zone will be the base time zone
- Certain logical complexities are avoided during high volume processing given the knowledge that all master data time zones are equal to the base time zone.

If your implementation resides within multiple time zones then the Multi Time Zone Support feature configuration must be enabled. Doing so will allow master data to be defined with any time zone configured in the system. It will also enable logic to convert time zones between the master data time zones and the base time zones.

You can access the feature configuration portal from the **Admin > General > Feature Configuration**.

From the list of results returned select the feature name for the feature type General System Configuration. For the option type Multi Time Zone Support supply "D1YS" as the value to turn multiple time zones on.

Refer to [Multiple Time Zone Support](#) for information about how functional processing is impacted by multiple time zone support.

## Defining Financial Transaction Options

Bills, payments and adjustments share one very important trait - they affect how much your customers owe. This section explains the financial design of the system and describes how to set up the tables that control the financial impact of these transactions.

---

**NOTE:**

The tables in this section are the first of many that must be set up before you can create bills and apply payments. In this section, we limit the discussion to those tables that control the financial impact of bills, payments and adjustments. In later sections, we describe the tables that control other billing-related functions like meter reading and rates. It is only after all of these tables are set up that you will be able to generate the various financial transactions.

---

## The Financial Big Picture

This section provides an overview of the relationship between an account and the various financial transactions that influence how much a customer owes.

---

**WARNING:**

If your organization practices cash accounting for payables (i.e., you only pay the taxing authority when you get paid), refer to [Payables Cash Accounting](#). If your organization practices open-item accounting (i.e., payments must be matched to bills), refer to [Open Item Accounting](#).

---

## Bills, Payments & Adjustments

The following diagram illustrates the relationship between an account and its financial transactions:

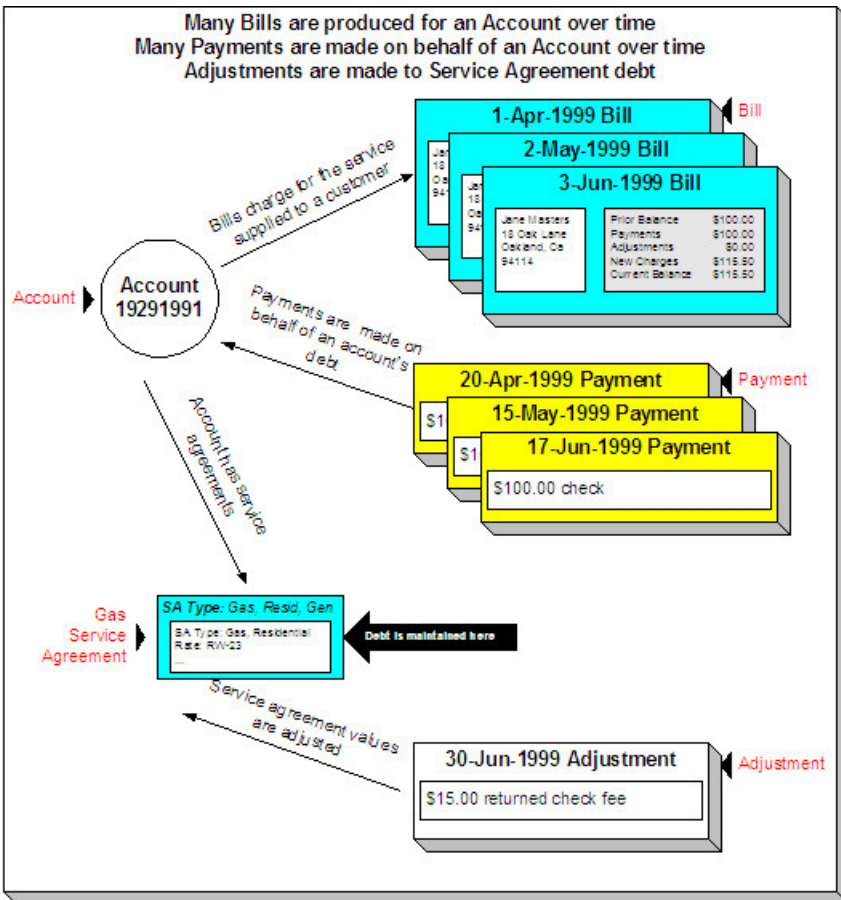

The following concepts are illustrated above:

**Bills are produced for accounts** Over time, many bills may be produced for an account. For more information about a bill, see [Bill Details](#).

**Payments are made for accounts** Over time, many payments may be applied to an account's debt. For more information about a payment, see [Payment Details](#).

**Service agreements have debt** The system maintains debt on each individual service agreement. An account's debt is the sum of its service agreements' debt.

**Service agreements are adjusted** Over time, the debt that is stored on an account's service agreement(s) may be adjusted. For more information about an adjustment, see [Adjustment Details](#).

## Bill Details

The following diagram illustrates the relationship between an account and its bills:

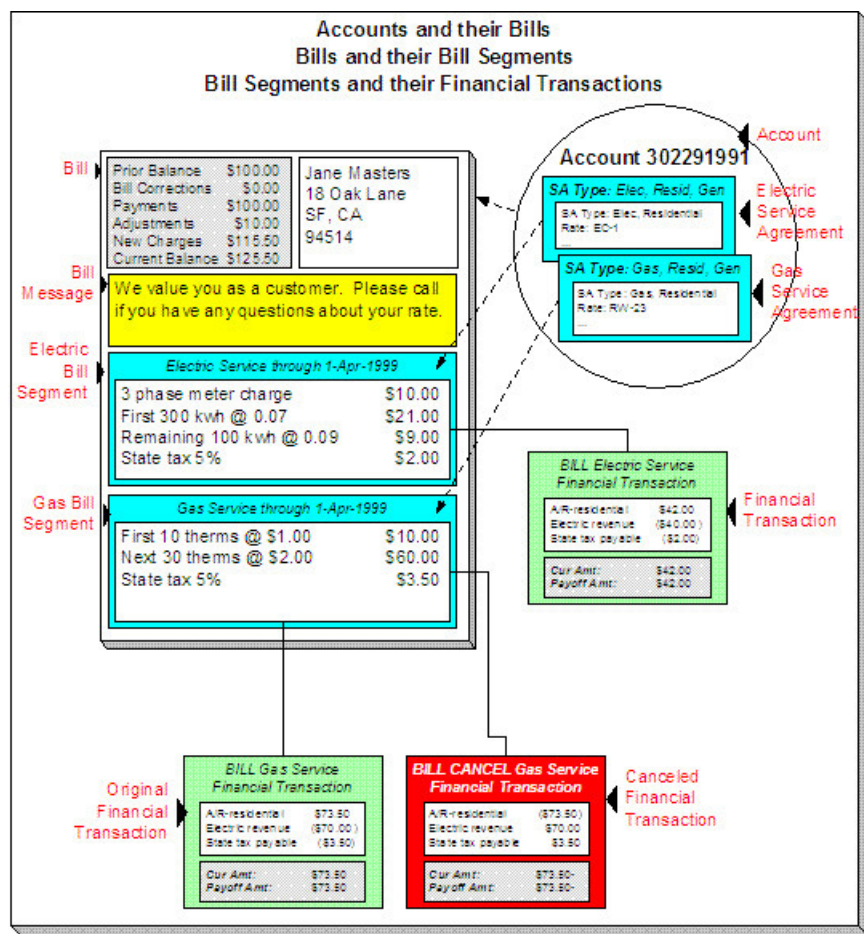

The following concepts are illustrated above:

**A bill is produced for an account** Over time, many bills are produced for an account. Bills charge for the services supplied to a customer. The above illustration shows a single bill.

**Bills contain bill segments** A bill typically contains one bill segment for every active service agreement linked to its account. The only time this is not true is when service agreements for different frequencies exist. For example, an account with a monthly and a quarterly service agreement will only have 4 bills a year that contain both bill segments; the other months' bills will contain a single bill segment for the monthly service agreement.

**Bill segments contain calculation details** A bill segment contains information showing how the segment was calculated and how it should be printed on the customer's bill.

**A bill segment has a financial transaction** A bill segment has a related financial transaction. A financial transaction contains the financial effects of the bill segment on the service agreement's current and payoff balances and on the general ledger.

**Canceling a bill cancels the financial tran.** If the bill segment is eventually cancelled, another financial transaction will be linked to the bill segment to reverse its original financial transaction. The cancellation financial transaction appears on the next bill produced for the account as a bill correction.

## Payment Details

The following diagram illustrates the relationship between an account and its payments:



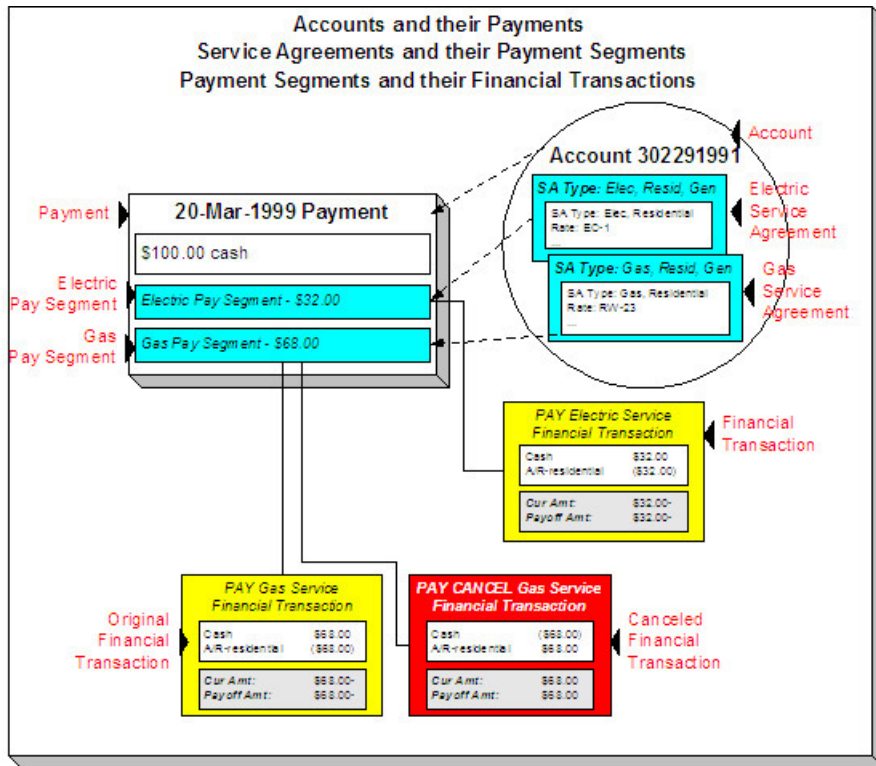

The following concepts are illustrated above:

**Payments are made for accounts** Over time, many payments may be applied to an account's debt. The above illustration shows a single payment.

**Payments contain payment segments** A payment contains one payment segment for every service agreement to which the payment is distributed. For a customer who pays in full, the number of payment segments will coincide with the number of bill segments on the bill being paid.

**A pay. segment has a financial transaction** A payment segment has a related financial transaction. A financial transaction contains the financial effects of the segment on the service agreement's current and payoff balances and on the general ledger.

**Canceling a payment cancels the fin. tran.** If the payment is eventually cancelled, another financial transaction will be linked to the related payment segment(s) to reverse their financial effect. The cancellation financial transaction appears on the next bill produced for the account as a negative payment.

**FASTPATH:**

A payment cannot be applied to an account's debt without an associated payment event. Refer to [The Big Picture of Payments](#) for more information.

## Adjustment Details

The following diagram illustrates the relationship between an account and its adjustments:



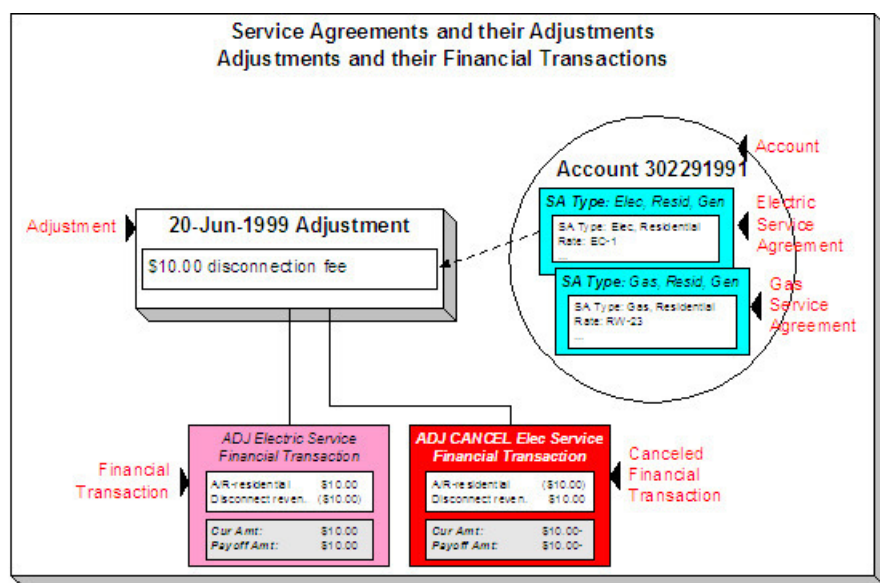

The following concepts are illustrated above:

**Service agreements have adjustments** Over time, a service agreement may have many adjustments. The above illustration shows a single adjustment to one of the account's service agreements.

**An adjustment has a financial transaction** An adjustment has a related financial transaction. The financial transaction contains the financial effects of the adjustment on the service agreement's debt and on the general ledger.

**Canceling an adjust. cancels the fin. tran.** If the adjustment is eventually canceled, another financial transaction will be linked to the adjustment to reverse its financial effect. The cancellation financial transaction appears on the next bill produced for the account as an adjustment.

## Current Amount versus Payoff Amount

A financial transaction contains two very important attributes: payoff amount and current amount. These attributes contain the grand total of how much the customer owes.

- Current amount contains how much the customer THINKS THEY OWE.
- Payoff amount contains how much the customer REALLY OWES.

You may be wondering when these two values can be different? Well, for most financial transactions, these values are the same. These values differ under the following situations:

- When a bill segment charges a customer for a charitable contribution, payoff amount will be zero because the customer doesn't really owe anything (they don't have to contribute if they don't want to). Current amount will be equal to the agreed charitable contribution amount (the customer thinks they owe the contribution).
- When a bill segment charges a customer for a deposit, payoff amount will be zero because the customer doesn't really owe anything (billed deposits are typically not viewed as being a receivable). Current amount will be equal to the amount billed (the customer thinks they owe the deposit amount).
- When a bill segment charges a customer who participates in a levelized payment program (e.g., budget billing or non-billed budgets) the two "amounts due" will contain different values. Payoff amount is equal to how much the customer really owes for the service they consumed; current amount is equal to how much they think they owe in accordance with their monthly budget.

A perhaps easier way to view these two attributes is to consider payoff amount as the "cash out amount", i.e., the amount the customer would owe the utility if they wanted to clear up all debt. The current amount contains the amount the customer

thinks they owe. If you're still struggling with the difference, think about your monthly Visa bill: it contains a monthly minimum payment and the total amount owed. The minimum payment is the current amount; the total amount owed is the payoff amount.

The topics in this section provide more information about these two fields.

## What Controls What Gets Booked To Current And Payoff Amount?

As described in [Bill Details](#), every bill segment has a sibling financial transaction. The financial transaction defines the bill segment's affect on current and payoff amounts due. The system populates these two fields as per the Financial Transaction Algorithm defined on the bill segment's bill segment type.

---

**FASTPATH:**

For more information, refer to [Billing - Current Balance versus Payoff Balance](#) and [Designing and Defining Bill Segment Types](#).

---

As described in [Payment Details](#), every payment segment has a sibling financial transaction. The financial transaction defines the payment segment's affect on current and payoff amounts due. The system populates these two fields as per the Financial Transaction Algorithm defined on the payment segment's payment segment type.

---

**FASTPATH:**

For more information, refer to [Payment - Current Balance versus Payoff Balance](#) and [Setting Up Payment Segment Types](#).

---

As described in [Adjustment Details](#), every adjustment has a sibling financial transaction. The financial transaction defines the adjustment's affect on current and payoff amounts due. The system populates these two fields as per the Financial Transaction Algorithm defined on the adjustment's adjustment type.

---

**FASTPATH:**

For more information, refer to [Adjustments - Current Balance versus Payoff Balance](#) and [Setting Up Adjustment Types](#).

---

## Arrears

The system keeps track of the age of each customer's debt to the day. For example, if a customer hasn't paid their last two bills, the customer's aged debt might look as follows:

- \$124.50: 22 days old
- \$213.41: 51 days old

Please be aware that it is the current balance (i.e., what the customer thinks they owe) that is aged. Also keep in mind that the moment an FT is frozen, it impacts a customer's current balance.

The system represents aged debt in a variety of ways of the various transactions in the system. On the [Current Context Zone](#) and the [Financial Information Zone](#) arrears are shown in a colorful bar (where each color corresponds to different aged buckets):

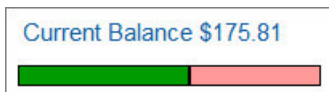

Whereas on [Service Agreement - Main](#), aged debt is shown in a grid:

### Debt Class Arrears

Days Old	Arrears Amount
4	\$99.45
32	\$76.36

The grid method is used on many pages throughout the system. The following rows *may* appear in the grid:

- A row labeled New Charge highlights all debt that hasn't started aging yet. For example, if you've created a late payment charge and it hasn't appeared on one of the customer's bills, it will be classified as a New charge until the next bill is completed for the customer (unless a user overrides the late payment charge's arrears date by drilling into the financial transaction).
- A row with a label containing n Future (where n is the number of days) appears if there is "future debt". Future debt is very rare and can only exist if a debit financial transaction has a future arrears date. Financial transactions can receive a future arrears date if a bill is completed with a future date or if a user overrides a financial transaction's arrears date with a future date).
- A row that contains a number (and nothing else) represents debt that has started aging. The number is the age of the respective debt. In the above example, the customer has 1 day old debt, and debt that is more than 150 days old. Notice that the 150 day old debt is prefixed with a +. This means that the related debt is more than 150 days old. This age limit is controlled by a field on [Installation Options - CC](#) called "Oldest Bucket Age". This field limits the number of days the system will age debt. For example, if you set this field to 150, the system will never age an FT more than 150 days (and all debt that's older than 150 days will be classified as 150 day old debt). Also note, the aged debt bar that appears on [Current Context Zone](#) only ages debt a maximum of 60 days.
- A row with a label of Disputed appears if the account is an [open-item](#) customer and this customer has [disputed](#) financial transactions.

---

**FASTPATH:**

Refer to [Financial Transactions And Aged Debt](#) for more information.

---

## GL Accounting Information

Be aware that if payoff amount is non-zero, the financial transaction has general ledger detail lines.

There are unusual financial transactions whose payoff amount is zero, but still affect the general ledger:

- Bill segments for company usage do not impact payoff amount (because your organization doesn't really owe itself anything). However, the GL is affected.
- Payment segments for charitable contributions (created when your customers contribute extra money to a charity) do not impact payoff amount. Why? Because payoff amount is never debited when a charitable contribution is billed (the customer doesn't truly owe you for this receivable). It's only when the customer pays the contribution that the GL is impacted (debit cash, credit charitable contribution payable).
- If the SA has a special role of Loan, the financial transaction algorithms supplied with the base package transfer the current amount between the long-term receivables and the short-term receivables in the GL. This allows the general ledger to differentiate between unbilled loan receivables (long term) and billed loan receivables (short term). Refer to [Payoff Balance and Current Balance for Loans](#) for more information.

The effect on your GL is controlled by the financial transaction algorithm defined on your bill segment and payment segment types.

---

**FASTPATH:**

Refer to [The GL Interface](#) for how GL account information is interfaced to the general ledger.

## A Complicated Example

The financial ramifications of a revolving charge account are predictable (if you're an accountant). The following table outlines the different financial events and their impact on the general ledger, arrearage history, and the amounts due (both current and payoff).

Event	GL Accounting	Arrearage Rule	Effect On Payoff Amt	Effect On Current Amt	Payoff Balance	Current Balance
Merchandise purchased	A/R 1000 Revenue <1000>	n/a (current amount is zero)	+1000	0	1000	0
Monthly bill	A/R 10 Int. Rev <10>	\$120 aged accordingly	+10	+120	1010	120
Payment received	Cash 120 A/R <120>	\$120 relieved accordingly	-120	-120	890	0

The following points describe the events in the above table:

- **Merchandise purchased.** When a customer purchases an air conditioner:
  - The system generates an adjustment to book the purchase.
  - The customer doesn't really think they owe the entire \$1,000 (because they've purchased it on credit), therefore no moneys are booked to current amount. However, if the customer wanted to cash out, they would owe your organization \$1,000, therefore the entire amount of the purchase is booked to payoff amount.
  - Because no money was booked to current amount, this event has no impact on the arrearage history.
- **Customer billed.** Monthly, the system calculates how much the client owes. In this example, interest is calculated to be \$10 and the minimum monthly payment is set at \$120.
  - The interest is posted to the GL, but principal isn't since it was booked when the merchandise was purchased.
  - The customer really thinks they owe the minimum payment amount, \$120. Therefore, current amount is affected. However, if the customer were to cash out, they would owe your organization \$1,000 + \$10 (the interest); therefore payoff amount is affected by only \$10.
  - Because current amount changed by \$120, arrearage history is affected accordingly.
- **Payment received.** With any luck, the client will pay the \$120 that was billed (note, they could obviously pay more).
  - The payment has a normal affect on the GL (debit cash, credit A/R).
  - The amount the customer thinks they owe decreases by \$120, therefore current amount is affected by the payment amount. And, if the customer was to cash out, they would owe the utility \$120 less, therefore payoff amount is affected by the payment amount.
  - Because current amount changed by \$120, arrearage history is affected accordingly.

## Financial Transactions Created Between Bills

The following diagram illustrates how frozen financial transactions (FT's) accumulate between bills and are swept onto the next bill produced for the account (when the bill is completed ). This example assumes

After the last bill is completed, the account's service will have no unbilled financial transactions

SA Type: Elec, Resid, Gen No unbilled financial transactions	SA Type: Gas, Resid, Gen No unbilled financial transactions
---	--

When an account is levied a late payment charge, FT's are created and linked to the account's service

SA Type: Elec, Resid, Gen ADJ Electric Service Cur Amt: \$10.00 Payoff Amt: \$10.00	SA Type: Gas, Resid, Gen ADJ Gas Service Cur Amt: \$5.00 Payoff Amt: \$5.00
--	--

When a payment is applied to the account's debt, two FT's are created and linked to the account's service

SA Type: Elec, Resid, Gen ADJ Electric Service Cur Amt: \$10.00 Payoff Amt: \$10.00	SA Type: Gas, Resid, Gen ADJ Gas Service Cur Amt: \$5.00 Payoff Amt: \$5.00
PAY Electric Service Cur Amt: \$32.00- Payoff Amt: \$32.00-	PAY Gas Service Cur Amt: \$68.00- Payoff Amt: \$68.00-

When a bill is generated for an account, two bill FT's are created and added to the account's service

SA Type: Elec, Resid, Gen ADJ Electric Service Cur Amt: \$10.00 Payoff Amt: \$10.00	SA Type: Gas, Resid, Gen ADJ Gas Service Cur Amt: \$5.00 Payoff Amt: \$5.00
PAY Electric Service Cur Amt: \$32.00- Payoff Amt: \$32.00-	PAY Gas Service Cur Amt: \$68.00- Payoff Amt: \$68.00-
BILL Electric Service Cur Amt: \$42.00 Payoff Amt: \$42.00	BILL Gas Service Cur Amt: \$73.50 Payoff Amt: \$73.50

When a bill is generated for account, it sweeps all unbilled FT's onto itself

Prior Balance	\$100.00
Bill Corrections	\$0.00
Payments	\$100.00
Adjustments	\$15.00
New Charges	\$115.50
Current Balance	\$130.50
...	

When any type of financial transaction is frozen, it impacts the related service agreement's **current and payoff balances**. If you do not want adjustments and bill segments to affect the customer's balance until they appear on the customer's next bill, refer to [Preventing SA Balances And The GL From Being Impacted Until Bill Completion](#).

Notice the balances in the financial summary of the above bill:

- The **Prior Balance** is the ending balance from the customer's prior bill.
- The **Bill Corrections** portion is blank. It contains a value if you cancel / rebill a bill segment that appeared on an earlier bill.
- The **Payments** portion shows payment financial transactions (both new payments and cancellations) that have been created since the last bill.
- The **Adjustments** portion shows adjustment financial transactions (both new adjustments and cancellations) that have been created since the last bill.
- The **New Charges** portion shows bill financial transactions that were created when the bill was created.
- The **Current Balance** is the total amount owed.

**FASTPATH:**

If you practice [Open Item Accounting](#), refer to [Open Item Versus Balance Forward Accounting](#) for more information about financial transactions and bills.

---

## Financial Transactions And Aged Debt

The system keeps track of how old a service agreement's current balance is in order to determine if the customer is in arrears (and therefore credit and collections processing should start).

A financial transaction (FT) impacts the related service agreement's current and payoff balances the moment it is frozen. However, some types of frozen FTs have no impact on a customer's aged debt until the next bill is completed for the account associated with the service agreement.

As described in the previous section, a frozen financial transaction (FT) waits in limbo until the customer's next bill is produced. This limbo period could be several weeks if the customer is billed infrequently. When the customer's next bill is completed, all such frozen FT's are linked to the bill. It is important to stress the following in respect of these FT's:

- If the FT decreases the amount of debt, the customer's aged debt is affected immediately regardless of whether the FT appears on a bill.
- If the FT increases the amount of debt, the amount the customer owes from an aged debt perspective may or may not be affected by the FT. There is a switch on an FT called New Charge that controls the arrears behavior.
  - If this switch is on, the amount of debt will be reflected as a "new charge" when you look at the customer's aged debt. This amount will remain classified as a "new charge" until the FT is swept onto a bill. The moment the FT is swept onto the customer's bill, the debt starts aging. This logic exists because you probably don't want to start aging an FT until the customer has actually seen it.
  - If this switch is off, the date on which the FT starts aging must be defined in the Arrears Date field. The Arrears Date is used to compute how many days old the debt is.

---

### NOTE:

**Aged debt limitations.** It's important to be aware that there's a field on [Installation Options - CC](#) called "Oldest Bucket Age" that limits the number of days old the system will age debt. For example, if you set this field to 360, the system will never age an FT more than 360 days (and all debt that's older than 360 days will be classified as 360 day old debt). Also note, the aged debt bar that appears on [Control Central - Account Information](#) only ages debt a maximum of 60 days.

---

### FASTPATH:

If you practice [Open Item Accounting](#), refer to [Open Item Versus Balance Forward Accounting](#) for information about how open-item FT's affect aged debt.

---

## Preventing SA Balances And The GL From Being Impacted Until Bill Completion

It's important to understand that when any type of financial transaction is frozen, the related service agreement's balance is affected. For example:

- When a payment is frozen, the customer's balance is reduced.
- When an adjustment is frozen, the customer's balance is impacted.
- When a bill segment is frozen, the customer's balance is increased (typically).

For payments, there is no issue. However, for bill segments and certain types of adjustments, you may NOT want the customer's balance to be impacted until the next bill is completed. Consider the following scenarios:

- Late payment charges:
  - You can setup the system to create a late payment charge (i.e., an adjustment) say 5 days after an unpaid bill is due.
  - If the related adjustment is frozen, the customer's balance will be impacted. However, its impact will not affect [aged debt](#) until the next bill is completed. In other words, the amount of the frozen adjustment segment will appear as a "New Charge" until the bill is completed.
- Batch billing:
  - If a customer has multiple service agreements, it's possible for one of the service agreements to have a bill segment that's in error and the other service agreement's bill segment to be error-free.
  - If this happens and you have setup the bill cycle schedule to freeze bill segments if they're error-free, then you could have one bill segment frozen and another in error.
  - The frozen bill segment will impact the customer's balance. However, its impact will not affect [aged debt](#) until the bill is completed (and a bill cannot be completed until all of its bill segments are error-free). In other words, the amount of the frozen bill segment will appear as a "New Charge" until the bill is completed.

---

**WARNING:**

We'd like to stress that while a frozen financial transaction impacts a customer's balance the moment it is frozen, the amount of the financial transaction appears as a "New Charge" when viewing a customer's [aged-debt](#). This amount will remain classified as a "New Charge" until the next bill is completed (i.e., the customer's debt doesn't start aging until the next bill is sent to the customer).

---

While [aged-debt](#) isn't impacted by frozen FT's, the general ledger is. This is because a financial transaction is marked for [interface](#) to the general ledger when it is frozen. This can be problematic if you have a long period between FT freeze and bill completion (you could impact the general ledger but not impact the customer's balance). If this is unacceptable, you can setup the system to not allow certain types of FT's to be frozen until the next bill is completed. This means that neither the customer's balance nor the general ledger will be impacted until bill completion time. To do this:

- Choose the Freeze At Bill Completion option on [Installation Options - Billing](#).
- Examine each of your [adjustment types](#). Select Freeze At Bill Completion for those that should not impact the customer's balance or the general ledger until the next bill is completed. Select Freeze At Will for those that should impact the customer's balance and the GL when they are frozen. Typically, the only adjustment types for which you'd choose Freeze At Will option are those that cause a customer's balance to be reduced, those that are used to refund money to a customer, and those that are created at bill completion. Adjustment types for adjustments created during bill completion (e.g., by a bill completion algorithm) must have their adjustment freeze option set to Freeze At Will. Otherwise (i.e., if the option is Freeze At Bill Completion ) they will not be frozen until a subsequent bill is completed.

Please be aware of the following in respect of the Freeze At Bill Completion options:

- If you turn on Freeze At Bill Completion on [Installation Options - Billing](#):
  - Users will not be allowed to freeze bill segments online. This means that the freeze button will be disabled on [Bill - Main](#), [Bill - Bill Segments](#) and [Bill Segment - Main](#).
  - The Billing background process will not freeze bill segments until all segments on a bill are error free (and permission has been granted on the bill cycle schedule to complete bills).
  - Bill segments will exist in the freezable state until the bill is completed.
- If you turn on Freeze At Bill Completion on [Adjustment Type - Main](#):
  - Users will not be allowed to freeze adjustments of this type online. This means that the freeze button will be disabled on [Adjustment - Main](#).



- Background processes that create adjustments will not freeze this type of adjustment. Rather, the adjustments will be frozen when the next bill is completed.
  - Adjustments of this type will therefore exist in the freezable state until the next bill is completed.
- 

**NOTE:**

**Alerts highlight freezable FT's.** Please be aware that messages appear in the [Account Information - Financial Information Zone](#) and in the [Dashboard - Financial Information Zone](#) to highlight the existence of freezable financial transactions.

---

Please be aware of the following in respect of the Freeze At Will options:

- If you turn on Freeze At Will on [Installation Options - Billing](#):
  - Users will be allowed to freeze bill segments online. This means that the freeze button will be enabled on [Bill - Main](#), [Bill - Bill Segments](#) and [Bill Segment - Main](#).
  - The Billing background process will freeze bill segments when the individual segment is error-free (and permission has been granted on the bill cycle schedule to freeze bill segments).
  - Bill segments will exist in the frozen state regardless of whether the bill is completed.
  - The frozen bill segment's FT will be interfaced to the GL when the interface next runs.
  - All adjustment types must be also be set to Freeze At Will (otherwise they wouldn't get frozen).
- If you turn on Freeze At Will on [Adjustment Type - Main](#):
  - Users will be allowed to freeze adjustments of this type online. This means that the freeze button will be enabled on [Adjustment - Main](#).
  - Background processes that create adjustments will freeze this type of adjustment.
  - Adjustments of this type will exist in the frozen state prior to bill completion.
  - The frozen adjustment's FT will be interfaced to the GL when the interface next runs.

## Forcing The Freeze Date To Be Used As The Accounting Date

Every financial transaction references an accounting date. The accounting date controls the accounting period to which the financial transaction is booked as described below:

- Every financial transaction references an accounting date and a service agreement
- Every service agreement references a service agreement type
- Every service agreement type references a GL division
- Every GL division references an [accounting calendar](#)
- The accounting calendar contains the cross-reference between the accounting date specified on the financial transaction and the related accounting period in your general ledger

The accounting date is populated on financial transactions when they are initially generated. The following points describe the source of the accounting date:

- The user who creates or cancels a bill segment online defines the accounting date as part of the generation/cancel dialog (note, the current date defaults).
- Bill segments that are produced by the [BILLING](#) background process have their accounting date defined on the [bill cycle schedule](#) that caused the bill to be created.



- The user who creates or cancels an adjustment online defines the accounting date as part of the generation / cancel dialog (note, the current date defaults).
- Payments are unusual in that their financial transaction is only created when they are frozen (rather than when the payment is first distributed amongst the account's service agreements). At payment freeze time, the accounting date is set to the current date.

For payments, there is no issue because the accounting date is only populated on the financial transaction when a payment is frozen. However, for bill segments and adjustments, your business practice may dictate that the freeze date should be used as the accounting date rather than the original accounting date. Alternatively, your business practice may dictate that the accounting date that's originally stamped on bill segments / adjustments should be used (unless this associated period is closed at freeze time). It's really a question of the interpretation of the local accounting rules. After you've decided on your approach, populate the **Accounting Date Freeze Option** on [Installation Options - Billing](#) with one of the following values:

- Choose Always change if the accounting date on your financial transactions should be populated with the freeze date (i.e., the current date when the financial transaction is frozen).
- Choose Change if period is closed if the accounting date defined when the financial transaction is generated should be used (unless the associated accounting period is closed).

Please be aware of the following in respect of your choice:

- If you choose Always change:
  - When a user freezes a bill segment online, they will be prompted to supply an accounting date. The current date will default, but the user can override this value.
  - When a user freezes an adjustment online, they will be prompted to supply an accounting date. The current date will default, but the user can override this value.
  - The **BILLING** background process will use the current business date as the accounting date on bill segments that it freezes.
  - Also note, if you have chosen the Freeze At Bill Completion **Bill Segment Freeze Option** on the [installation record](#), bill segments and certain types of adjustments are frozen when a bill is completed. This means that the accounting date on the related financial transactions will be set to the completion date (because the completion date is the freeze date with this setting). Refer to [Preventing SA Balances And The GL From Being Impacted Until Completion](#) for more information.
- If you choose Change if period is closed:
  - When a user freezes a bill segment online, they will only be prompted to supply an accounting date if the related accounting period is closed (because the accounting period closes after the bill segment is generated but before it's frozen). The current date will default, but the user can override this date.
  - When a user freezes an adjustment online, they will only be prompted to supply an accounting date if the related accounting period is closed (because the accounting period closes after the adjustment is generated but before it's frozen). The current date will default, but the user can override this date.
  - The **BILLING** background process will use the accounting date defined on the related bill cycle schedule as the accounting date on the bill segments that it creates and freezes.

---

**NOTE:**

The above installation option only controls the final accounting date for GL recording purposes. Rate and bill factor value selection based on accounting date uses the date as initially determined.

---

## How Late Payment Charges Get Calculated

Late payment charges are system-generated adjustments used to penalize a customer for late (or no) payments. This section describes how to set up the tables that control how and when late payment charges are generated. The following points describe how and when late payment charges are calculated.

- When a bill is completed, the system marks it with the date on which late payment charges will be calculated if the bill is not paid.
  - This date is calculated by adding grace days to the bill's due date. Grace days are defined on the account's [Customer Class / Division](#).
  - This date will be zero if the account's [Customer Class / Division](#) indicates the account is not eligible for late payment charge processing.
- The late payment charge background process (referred to by the batch ID of [LATEPYMT](#) ) selects all bills on or after their late payment charge date.
  - For each such bill, the system determines if its account satisfies the late payment charge eligibility criteria defined on the account's [Customer Class / Division](#). The eligibility criteria are defined in an algorithm and can therefore be as flexible as required.
  - If an account is eligible for late payment charges, the system checks each of the account's service agreements to determine if it is eligible for late payment charges (as defined on the service agreement's [SA Type](#) ).
  - If a service agreement is eligible for late payment charges, the system calls the SA type's late payment charge calculation algorithm. This algorithm should calculate the late payment charge amount, if applicable and return the calculated amount and an appropriate adjustment type to use. If this algorithm returns this information, an adjustment is generated to levy the late payment charge.

---

**FASTPATH:**

Refer to [Setting Up Customer Classes](#) for more information about how to set up an account's due days and grace period. Refer to [SA Type - Main Information](#) for more information about enabling late payment charges calculations for your service agreements.

You can update the **Late Payment Charge Details** section on the Bill - Main Information page to indicate if and when late payment charges may be levied. For more information, see [Bill - Main Information](#).

---

## Service Agreement Type Controls Everything

The previous section illustrated three important concepts:

The true financial impact of the three financial events - bills, payments, adjustments - is at the service agreement level, not at the account level. This means that bills and payments are meaningless on their own. It's the service agreements' bill segments, payment segments and adjustments that affect how much a customer owes.

- Every bill segment, payment segment, and adjustment has a related financial transaction. These financial transactions contain the double-sided journal entries that will be interfaced to your general ledger. They also contain the information defining how the customer's debt is affected by the financial event (i.e., current amount and payoff amount).
- A single bill can contain many bill segments, each of which may have a different frequency. For example, a bill could contain future charges, monthly retroactive charges based on measurement cycle, quarterly charges that must end on a quarter-end boundary.

You control the financial effects of the various financial events using a single field on the service agreement. This field is called the service agreement (SA) Type. In this section, we describe many of the tables that must be set up before you can create a SA type.

---

**NOTE:**

**Foreshadowing.** You will notice that we don't explain how to set up SA types in this section. This is because SA type controls numerous aspects of a service agreement's behavior in addition to its financial behavior. The non-financial

aspects are discussed in later chapters. It's only after you have set up all of the control tables in this manual that you'll be able to finally define your SA types. Refer to [Setting Up SA Types](#) for more information.

---

**WARNING:**

Take the time to define how you will record the various financial events in your general ledger before you attempt to set up these control tables. If you have simple accounting needs, this setup process will be straightforward. However, if you sell many services and use sophisticated accounting, this setup process will require careful analysis.

---

## Understanding CIS Divisions

There are two types of Divisions referenced on a SA type: a CIS Division and a GL Division. This is a rather powerful structure, but it can be confusing.

- General Ledger divisions typically comprise individual entities (e.g., companies) in your general ledger. You must set up a GL division for each such entity. The GL division's sole purpose in the system is to define the accounting period associated with financial transactions linked to service agreements associated with the GL division (service agreements are associated with GL divisions via their SA type). The system cares about accounting periods in order to prevent a user from booking moneys to closed periods. It also uses accounting periods when it produces the flat file that contains the consolidated journal entry that is interfaced to your general ledger (refer to [The GL Interface](#) for more information).
- A CIS division is associated with a jurisdiction. The definition of a jurisdiction is a geographic-oriented entity with unique business rules. For example, if you conduct business in California and Nevada, and each state has different collection rules, you will need a separate jurisdiction for each state. You must set up a CIS division for each jurisdiction in which you conduct business.
- CIS division is also referenced on service agreement, premise and account.
  - The CIS division on SA is actually part of the SA's SA type. Because SA type controls many business rules, all business rules that are on the SA type can be thought of as being defined for a given jurisdiction and SA type combination. For example, you could define your valid rates for electric residential service in California which differ from the valid rates for electric residential service in Nevada. Refer to [Defining Service Agreement Types](#) for more information. In addition to controlling the business rules defined on the SA's SA type, the SA's CIS division also controls the type of collection criteria used to determine if and how to collect overdue debt. Refer to [Setting Up Collection Class Control](#) for more information.
  - The CIS division on premise defines the jurisdiction in which the premise is located. This jurisdiction controls the types of service agreements that can be associated with the premise's service points (e.g., you can only link California-oriented service agreements to premises governed by the California jurisdiction). You can also set up your field activity types to execute special algorithms when a field activity is completed at a service point located in specific jurisdiction.
  - The CIS division on account when combined with the account's customer class defines the jurisdiction that governs financial business rules (e.g., the bill's due date, when and how late payment charges are calculated, etc.). Refer to [Setting Up Customer Classes](#) for more information about these rules. The CIS division on account can also play a part in the addressee of To Do entries associated with the account. To assign To Do entries to a role based on the division, simply link the To Do type to the division. Refer to [To Do Entries Reference A Role](#) for more information.

## CIS Division Overrides

Some configuration values in the system, such as those defined on the installation record, are global and applied to the entire system. CIS Division allows some of these values to be specified by CIS division, overriding the system-wide default configuration. The system processes check the CIS Division for the override before checking the default configuration. CIS Division allows for overrides to be specified for **customer class** (by person and business), and **credit rating** and **cash-only** beginning and threshold values.

The bill route type and quote route type are used to define the background process and extract algorithm for each route type. CIS Division allows overrides to be specified for the extract batch control and/or extract algorithms. These can be defined for any or all each bill route types and quote route types. While bill route type and quote route type allow many of each type to be configured, one of each type is defaulted from the installation record. This override allows CIS Division specific value for a common route type.

## Users and CIS Division

When the installation option Control By CIS Division flag is set, it is necessary to associate the system users with CIS Division. This feature is applicable if your organization expects users to work on designated CIS Divisions only (as opposed to allowing users to serve customers across all CIS Divisions). Users can be associated with CIS Division(s) even if the above flag is not set. Some system functions take advantage of this such as defaulting CIS Division on control central searches. User - CIS Division is maintained in the user portal.

To navigate there, select **Admin > User > Search** and navigate to the **Miscellaneous** page.

### How Does the System Use User CIS Division

Refer to [Installation Options – Main](#) for information on how this is used in conjunction with the Control By CIS Division and Premise/SP Search flags

The user's CIS Divisions are used in some circumstances to restrict case type and customer contact type by CIS Division.

The user's Primary CIS Division is used to default the CIS Division on the Control Central search that is provided with the system.

## Restricting CIS Division

CIS Division appears through much of the system. The primary objects that reference a CIS Division are account, service agreement, and premise. It is also referenced on secondary objects such as orders and on pages that interact with the primary objects such as start/stop and payment arrangement.

A flag on CIS Division, Restrict to Account CIS Division, can be used to restrict service agreements and premise to the account's CIS Division. It is important to note that it is the account's CIS Division that matters. When this flag is set, many of the system pages default CIS Division and restrict the user for changing the value. The following rules are enforced in addition to the visible changes:

- Service agreement's CIS Division must match its account's CIS Division.
- Account CIS Division cannot be changed if the account has non-canceled service agreements.
- Account Protect CIS Division switch is turned on and is protected. This is done because the switch becomes irrelevant since all service agreements match the account's CIS Division and the account CIS Division would not change.
- When starting service, only premises that match the account CIS Division or do not have a CIS Division maybe chosen. This rule is applied when choosing a premise via start/stop or order.
- While most SA/SPs are created by the system when service is started, it is possible to manually maintain SA/SPs. When searching for a service point from Service Agreement - SA/SP, the search is limited to SPs whose premise matches the account CIS Division or does not have a CIS Division.
- As mentioned, this setting applies to the account CIS Division. When changing a premise's CIS Division, the system checks all accounts ever linked to the premise, to see if any of the accounts' CIS Division has set the Restrict to Account CIS Division option to **Restricted**.

---

**NOTE:** The Premise to Account association is checked through the relationship from Premise to Service Point to SA/SP to Service Agreement to Account.

---

- If the Account's CIS Division is set to restrict the CIS Division, then the Premise's CIS Division is restricted to remain the same as the Account's CIS Division. It can also be set to blank unless the premise type requires it.
- The characteristic premise on a service agreement is restricted to premises linked to the account if the service agreement requires an SP. For other service agreements the premise search is restricted to the account CIS Division.

---

**WARNING:** Do not turn on this flag without reviewing your existing data to ensure that it adheres to the rules enforced when the flag is set. The above rules are enforced on not just current data, but historic data as well such as closed service agreements. It is intended to ensure a consistency over the life of the objects associated with the CIS Division. This flag is configurable for each CIS Division, but consider the implications of setting it on some, but not all CIS Divisions.

---

## Using CIS Division for Operational Segmentation

CIS Division is found throughout many of the entities in the system and there are many configuration settings related to CIS Division. When these configuration settings are used in conjunction with each other, it is possible to operate distinct business entities or jurisdictions that are segmented by CIS division. The following summary describes the different settings and uses of CIS Division that you can configure if your organization operates in multiple jurisdictions and needs to segment data and business processes by CIS Division. Details about each of these can be found in the section of the document where the functionality is configured.

### Associate CIS Divisions with Users

CIS Divisions can be associated with users and one can be denoted as the primary.

### Control By CIS Division

Setting the Control By CIS Division flag on the installation record drives many system changes. On the account it makes CIS Division required. The flag drives functionality changes on other pages such as person, premise, and order.

### Premise/SP Access

Setting the Premise/SP Search flag on the installation record restricts access to premise and SPs not link to an account. The access is restricted to the user's CIS Division(s).

### CIS Division

CIS Division provides the configuration of a work calendar, default customer classes for persons and businesses, credit rating and cash only beginning and threshold values, and To Do role assignment for each CIS Division. Additionally, bill route type, quote route type, and auto pay route type configuration can be overridden.

### Restrict CIS Division

The Restrict to Account CIS Division flag is a setting on CIS Division. It is used to ensure that service agreements and premises match the account CIS Division and is a main component of segmenting data by CIS Division.

### Customer Class

Customer class is used to default collection class on accounts.

### Customer Class Control

Customer Class Control defines many business rules directly or through algorithms. These rules are specified per CIS Division. As noted above, Customer Class can be defaulted from CIS Division so there is a lot of flexibility in the configuration of these two entities. Some of the business rules are defaults such as access group and budget plan. Others such as payment distribution and billing days until due define the rule that apply to the account Customer Class/CIS Division combination.

## SA Type

CIS Division is part of the SA Type key. SA Type defines the valid values for SAs of that type and also defines attributes such as debt class and write off debt class for of SAs of that type.

## Collections

As noted above, Collection Class is defaulted on the account from customer class and SAs inherit their debt class from their SA Type. Collection Class Controls are defined for the unique combination of collection class and debt class. Collection class controls define the business rule and collection processes. Through configuration, collection rules can be defined for specific CIS Divisions.

## Write Off

As noted above, collection class is defaulted on the account from customer class and SAs inherit their write off debt class from their SA Type. Write off controls are defined for the unique combination of collection class and write off debt class. Write off control define the business rule and write off processes. Through configuration, write off rules can be defined for specific CIS Divisions.

## Premise Type

Premise Types can control if CIS Divisions are required, optional or not allowed for premise of that type. When starting service, if the premise has a premise type, only SA Types with the same CIS Division as the premise that are identified to start for SP Types for SPs at the premise will start. This allows more generic SP Types that start SA Types specific for the premise CIS Division.

## Restricting Types by CIS Division

Adjustment type, budget plan, bill cycle, case type, and customer contact type allow a CIS Division to be specified if the type is used for a specific CIS Division. Types without a CIS Division are not restricted.

## Background Processing By CIS Division

Batch billing and the collection, severance, and write off background processes can all be configured to select records by CIS Division. See [Choosing Which Records Are Selected](#) for more information

## Setting Up CIS Divisions

This portal is used to display and maintain CIS Divisions.

Refer to [Understanding CIS Divisions](#) for more information.

You can access the portal from **Admin > General > CIS Division**.

The following zones may appear as part of the portal's **Main** page:

- **CIS Division List:** This zone lists all CIS division records. Broadcast a record to display the details of the selected record.
- **CIS Division:** This zone provides information about the selected CIS Division.

## Where Used

Follow this link to open the data dictionary where you can view the tables that reference [CI\\_CIS\\_DIVISION](#).

## Setting Up Revenue Classes

Every service agreement references a service agreement (SA) type. Amongst other things, the SA type defines a service agreement's revenue class. The revenue class is used when the service agreement's rate books revenue to different GL distribution codes based on the service agreement's revenue class.

---

### FASTPATH:

See [Designing Calculation Groups and Rules](#) for more information about how revenue class is used to determine the GL revenue accounts referenced on a bill. See [Revenue Segmentation](#) for more information about how revenue class affects the number of SA types you will need.

---

To set up revenue classes, choose **Admin > Financial > Revenue Class**.

### Description of Page

Enter an easily recognizable **Revenue ClassID** and **Description** for every revenue class.

### Where Used

Follow this link to open the data dictionary where you can view the tables that reference [CI\\_REV\\_CL](#).

## Setting Up Distribution Codes

Distribution codes simplify the process of generating accounting entries by defining valid combinations of chart of account field values.

---

### FASTPATH:

Refer to [The Source Of GL Accounts On Financial Transactions](#) for more information about the accounting entries associated with bills, payments and adjustments.

---

To set up distribution codes, open **Admin > Financial > Distribution Code > Add**.

### Description of Page

Enter a unique **Distribution Code** and **Description** for the distribution code.

If this distribution code is a holding account used for payables cash accounting, check the **Use For Non-Accrual Accounting** switch and select the accounting method from the **Accounting Method** list. Select the priority level for the distribution code from the **Accounting Priority** list and enter the actual payable **Accounting Code**. The system will transfer monies from the holding account to the distribution code when the cash event occurs. Transfers will occur based on priority and debt age. For more information, refer to [Payables Cash Accounting](#) and [Deferred Accrual Accounting](#).

Define the **GL Account Algorithm** used by the system when it interfaces financial transactions that reference this distribution code to your general ledger (refer to [GLDL - Create General Ledger Download](#) for more information about the download process). The logic embedded in this algorithm constructs the actual GL account number. If you haven't done so already, you must set up this algorithm in the system. To do this:

- Create a new algorithm (refer to [Setting Up Algorithms](#) ).
- On this algorithm, reference an Algorithm Type that constructs your general ledger account number. Click [here](#) to see the algorithm types available for this plug-in spot.

The **Write Off Controls** control how the system writes off debt associated with the distribution code. Refer to [The Ramifications of Write Offs in the General Ledger](#) for an explanation of how these fields are used at write-off time.

- Define the **Division** and **SA Type** of the service agreement to which bad debt associated with this distribution code should be transferred at write-off time. Note: only SA Types with a special role of Write Off may be selected.



- When the system transfers debt to the write-off service agreement defined above, the distribution code defined on this **Division / SA Type** will be debited unless you turn on the **Override Switch**. When this switch is turned on, the system overrides the distribution code of the transfer to side of the adjustment with the distribution code associated with the debt being written off. You'd typically turn this switch on for liability distribution codes because you want to debit the original liability account when the debt is written off. Note: if this switch is on the system also overrides the characteristic type / value with the respective value associated with the debt that is being written off.

Use the **GL Account Details** scroll to define how the system constructs the GL account associated with the distribution code when it interfaces the financial transaction to your general ledger. For each distribution code, enter the following information:

- Enter the **Effective Date** of the following information.
- Define whether, on the **Effective Date**, the following information is Active or Inactive. The system will only use effective-dated information that is Active.
- Enter the **GL Account** that the general ledger uses to process financial transactions tagged with this distribution code.
- Enter the **Statistics Code** that should be passed to the general ledger during the GL interface for this **GL Account**. For example, if this **Distribution Code** is used to record electric, residential revenue, the **Statistics Code** would be kWh if you record the number of kWh in you general ledger along with the dollar value of the revenue.
- If you have configured your installation options to indicate that **fund accounting** is practiced, define the **Fund** associated with this distribution code. If your installation options indicate that fund accounting is not practiced, the field is not visible.
- Use the characteristics grid to define characteristic values for the **Distribution Code**. This grid supports all standard characteristic types (such as, Adhoc, Predefined, File Location, and Foreign Key) from the **Distribution Code GL Account Characteristics** table.. To modify a characteristic, simply move to a field and change its value. The following fields display:
  - **Characteristic Type**. Indicate the type of characteristic.
  - **Characteristic Value**. Indicate the value of the characteristic.

---

**NOTE:**

You can only choose characteristic types defined as permissible on the distribution code record. Refer to [Setting Up Characteristic Types & Their Values](#) for more information.

---

### Where Used

Follow this link to open the data dictionary where you can view the tables that reference [CI\\_GL\\_DIVISION](#).

## Setting Up Billable Charge Templates

A user creates a billable charge whenever a customer should be levied an ad hoc charge. For example, you would create a billable charge to charge a contractor for the repair of a ruptured gas line.

---

**NOTE:**

**Interfacing billable charges from an external system.** In addition to being entered manually, billable charges can also be interfaced from an external system. You would interface billable charges if your organization provides "pass through" billing services for a service provider. Refer to [Uploading Billable Charges](#) for more information.

---

A billable charge must reference a service agreement. This service agreement behaves just like any other service agreement:

- **Bill segments are created for the service agreement.** Whenever billing is performed for an account with billable charge service agreements, the system creates a bill segment for each unbilled billable charge.



- **Payments are distributed to the service agreement.** Payments made by an account are distributed to its billable charge service agreements just like any other service agreement.
- **Overdue debt is monitored.** The credit and collections process monitors billable charge service agreements for overdue debt and responds accordingly when overdue debt is detected.

---

**NOTE:**

**Rates can be applied to billable charges.** Billable charges can be connected to a service agreement that also specifies a rate. The rate will be applied and lines added to the bill segment after the billable charge lines are added. For example, a rate can insert flat charges or be applied to service quantities associated with the billable charge.

**Taxes on top of billable charges.** Rates cannot be applied to billable charge lines. If you need to perform a calculation such as applying taxes on top of the existing lines, add a service quantity (SQ) that contains the taxable amount with an SQ identifier that describes it as a taxable amount. A calculation rule can apply the tax to this SQ.

---

**FASTPATH:**

Refer to [How To Create A One-Time Invoice](#) for instructions describing how to create a bill for a billable charge outside of the normal bill creation process.

---

Billable charge templates exist to minimize the effort required to create a billable charge for a customer. A billable charge template contains the default bill lines, amounts and distribution codes used to levy a one-off charge.

The information on the template may be overridden by a user when the billable charge is created. For example, you can create a billable charge template to levy tree-trimming charges. This template would contain the bill lines, amounts and distribution codes associated with a tree trimming activities. Then, when you trim a tree for a customer, a user can create a billable charge using the template and override the amount to reflect the actual amount (if it differs from the norm).

---

**NOTE:**

**Templates aren't required.** A billable charge can be created without a template for a truly unexpected charge.

---

After setting up the billable charge templates, you must indicate the SA types that can use each template. Obviously, only billable charge SA types (as defined on the SA type's special role) will reference billable charge templates.

## Billable Charge Template - Main

Open **Admin > Billing > Billable Charge Template > Add** to define your billable charge templates.

### Description of Page

Enter a unique **Billable Charge Template ID** and **Description** for the billable charge template.

Use **Description on Bill** to define the verbiage that should print on the customer's bill above the billable charge's line item details.

Use **Currency Code** to define the currency in which the billable charge's amounts are expressed.

Use the grid to define the line item details associated with the billable charge (note, the **Total Line Amount** field is automatically calculated. It is the sum of the **Charge Amount** on each of the Line Sequence items). The following fields are required for each entry in the grid.

**Sequence** Line sequence controls the order in which the line items appear on the bill segment.

**Description on Bill** Specify the verbiage to print on the bill for the line item.

**Charge Amount** Specify the default amount to charge for the line item.

**Show on Bill** Turn this switch on if the line item should appear on the customer's printed bill. It would be very unusual for this switch to be off.

**Appears in Summary** Turn this switch on when the amount associated with this line also appears in a summary line.

**Memo Only, No GL** Turn this switch on when the amount associated with this line does not affect the GL (or the total amount owed by the customer).

**Distribution Code** Specify the default distribution code associated with this line item.

If you use the drill down button on the left most column in the grid, you will be taken to the Line Characteristics tab with the selected line displayed.

---

**FASTPATH:**

For more information about creating a billable charge, refer to [Maintaining Billable Charges](#). For more information about billing billable charges, refer to [How To Create A One-Time Invoice](#).

---

## Billable Charge Template - Line Characteristics

Open **Admin > Billing > Billable Charge Template > Search** and navigate to the **Line Characteristics** page to define your billable charge templates line characteristics.

### Description of Page

The **Line Sequence** scroll defines the billable charge template line to which you wish to assign characteristic values.

The characteristics grid supports all standard characteristic types (such as, Adhoc, Predefined, File Location, and Foreign Key) from the Billable Charge Template Line Characteristics table.

To modify billable charge template line characteristics, simply move to a field and change its value. To add characteristics, press + to insert a row and then fill in the information for each field. The following fields display:

**Characteristic Type** The type of characteristic.

**Characteristic Value** The value of the characteristic.

## Billable Charge Template - SQ Details

Open **Admin > Billing > Billable Charge Template > Search** and navigate to the **SQ Details** page to define your billable charge templates service quantities.

### Description of Page

To modify a template's service quantity, simply move to a field and change its value. To add a new service quantity to the billable charge template, press the + button to insert a row and fill in the information for each field. The following fields display:

**Sequence** Specify the sequence number of the SQ.

**UOM** Select the unit of measure of this SQ. One or more of UOM, TOU, or SQ identifier must be selected.

**TOU** Select the time of use period.

**SQ Identifier** Select the SQ identifier.

**Service Quantity** Specify the number of units of this service quantity.

### Where Used

Follow this link to open the data dictionary where you can view the tables that reference [CI\\_B\\_CHG\\_TMPLT](#).

## Designing and Defining Bill Segment Types

Every service agreement references a service agreement (SA) type. Amongst other things, the SA type references a bill segment type. The bill segment type controls how bill segments and their related financial transactions are created.

### WARNING:

We strongly recommend understanding the concepts described in [The Big Picture of Billing](#) before setting up your bill segment types.

The topics in this section describe how to design and set up bill segment types.

## What Do Bill Segment Types Do?

Bill segment types control how bill segments and their related financial transactions are created. The following illustration will help you understand how the system uses bill segment types during the bill segment creation process:

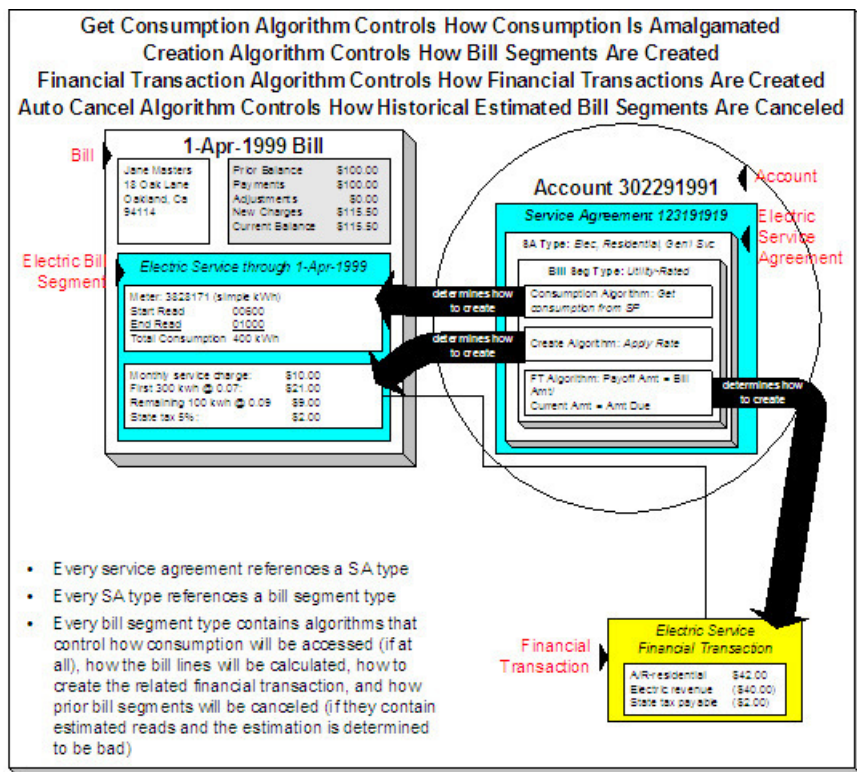

## Designing Your Bill Segment Types

The following table contains a subset of the SA types listed under [Defining Service Agreement Types](#) and [Designing Your SA Types And Start Options For Sub SAs](#) and [Designing SA Types For Service Provider Financial Settlements](#). However, if you are reading this document from top to bottom, you probably don't know what your SA types are (they are only designed much later) and will have to forestall this task until that time.

We're going to cheat and assume you know what your SA types are and fill in the algorithms necessary to create bill segments for each SA type. After this table is complete, we will look for unique combinations of the 4 algorithms and create a bill segment type for each one.

**NOTE:**

Before you can fill in the columns for your own SA types, you should be comfortable with the descriptions of the algorithms described under [Setting Up Bill Segment Types](#).

Div. SA Type	Calculation Algorithm	FT Algorithm	Consumption Algorithm	Auto Cancel Algorithm
CA/G-RES	<a href="#">Apply Rate To Usage Request</a>	<a href="#">Payoff = Bill Amount / Current = Amount Due</a>	<a href="#">Get Consumption Using Usage Request</a>	NA - can't estimate consumption.
CA/G-COM	<a href="#">Apply Rate To Usage Request</a>	<a href="#">Payoff = Bill Amount / Current = Amount Due</a>	<a href="#">Get Consumption Using Usage Request</a>	NA - can't estimate consumption.
CA/G-IND	<a href="#">Apply Rate To Usage Request</a>	<a href="#">Payoff = Bill Amount / Current = Amount Due</a>	<a href="#">Get Consumption Using Usage Request</a>	NA - can't estimate consumption.
CA/CABLE	<a href="#">Apply Rate To Usage Request</a>	<a href="#">Payoff = Bill Amount / Current = Amount Due</a>	<a href="#">Get Consumption Using Usage Request</a>	NA - can't estimate consumption.
CA/E-COY	<a href="#">Apply Rate To Usage Request</a>	<a href="#">Payoff = 0 / Current = 0</a>	<a href="#">Get Consumption Using Usage Request</a>	NA - can't estimate consumption.
CA/E-RESU	<a href="#">Apply Rate To Usage Request</a>	<a href="#">Payoff = Bill Amount / Current = Amount Due</a>	<a href="#">Get Consumption Using Usage Request</a>	NA - can't estimate consumption.
CA/E-COMU	<a href="#">Apply Rate To Usage Request</a>	<a href="#">Payoff = Bill Amount / Current = Amount Due</a>	<a href="#">Get Consumption Using Usage Request</a>	NA - can't estimate consumption.
CA/WO-STD	N/A - non billable	N/A - non billable	N/A - non billable	N/A - non billable
CA/WO-LIA	N/A - non billable	N/A - non billable	N/A - non billable	N/A - non billable
CA/CHARITY	<a href="#">Recurring Charge</a>	<a href="#">Payoff = 0 / Current = Bill Amount</a>	N/A - no consumption is needed	N/A - no consumption is needed
CA/PA-REGU	<a href="#">Recurring Charge With Auto Stop</a>	<a href="#">Payoff = 0 / Current = Bill Amount</a>	N/A - no consumption is needed	N/A - no consumption is needed
CA/MERCH-I	<a href="#">Recurring Charge For Amount To Bill</a>	<a href="#">Payoff = 0 / Current = Bill Amount</a>	N/A - no consumption is needed	N/A - no consumption is needed
CA/DEP-I	<a href="#">Recurring Charge For Amount To Bill</a>	<a href="#">Payoff = 0 / Current = Bill Amount</a>	N/A - no consumption is needed	N/A - no consumption is needed
CA/ONETIME	<a href="#">Billable Charge</a>	<a href="#">Payoff = Bill Amount / Current = Amount Due</a>	N/A - no consumption is needed	N/A - no consumption is needed
CA/OVR UNDR	N/A - non billable	N/A - non billable	N/A - non billable	N/A - non billable
CA/E-SUB ENR	<a href="#">Apply Rate</a>	<a href="#">Payoff = Bill Amount / Current = Amount Due</a>		
CA/E-SUB BC	<a href="#">Billable Charge</a>	<a href="#">Payoff = Bill Amount / Current = Amount Due</a>	N/A - no consumption is needed	N/A - no consumption is needed
<b>CA/E-FIN SETTLE</b>	N/A - non billable	N/A - non billable	N/A - non billable	N/A - non billable

Now, we'll extract unique combinations of the four algorithms and create a bill segment type for each.

Bill Segment Type	Calculation	FT	Consumption	Auto Cancel
-------------------	-------------	----	-------------	-------------

	Algorithm	Algorithm	Algorithm	Algorithm
BD RATED	Apply Rate To Usage Request	Payoff = Bill Amount / Current = Amount Due	Get Consumption Using Usage Request	NA - can't estimate consumption.
BILLCHRG	Billable Charge	Payoff = Bill Amount / Current = Amount Due	N/A - no consumption is needed	N/A - no consumption is needed
COMPUSAG	Apply Rate To Usage Request	Payoff = 0 / Current = Bill Amount	Get Consumption Using Usage Request	N/A - no consumption is needed
RECUR	Recurring Charge	Payoff = 0 / Current = Bill Amount	N/A - no consumption is needed	N/A - no consumption is needed
RECUR AS	Recurring Charge With Auto Stop	Payoff = 0 / Current = Bill Amount	N/A - no consumption is needed	N/A - no consumption is needed
RECURATB	Recurring Charge For Amount To Bill	Payoff = 0 / Current = Bill Amount	N/A - no consumption is needed	N/A - no consumption is needed
SUB RATE	Apply Rate	Payoff = Bill Amount / Current = Amount Due	Get Consumption From Master Bill Segment	N/A - rated sub service agreements are cancelled when their master is canceled.
SUB BC	Billable Charge	Payoff = Bill Amount / Current = Amount Due	N/A - no consumption is needed	N/A - no consumption is needed

Just to make sure everything has been designed appropriately, we will return to our SA type samples and specify their respective bill segment types:

Div.	Calculation	FT	Consumption	Auto Cancel	Bill Segment Type
SA Type	Algorithm	Algorithm	Algorithm	Algorithm	
CA/G-RES	Apply Rate To Usage Request	Payoff = Bill Amount / Current = Amount Due	Get Consumption Using Usage Request	NA - can't estimate consumption.	BD RATED
CA/G-COM	Apply Rate To Usage Request	Payoff = Bill Amount / Current = Amount Due	Get Consumption Using Usage Request	NA - can't estimate consumption.	BD RATED
CA/E-RES	Apply Rate To Usage Request	Payoff = Bill Amount / Current = Amount Due	Get Consumption Using Usage Request	NA - can't estimate consumption.	BD RATED
CA/E-COM	Apply Rate To Usage Request	Payoff = Bill Amount / Current = Amount Due	Get Consumption Using Usage Request	NA - can't estimate consumption.	BD RATED
CA/G-IND	Apply Rate To Usage Request	Payoff = Bill Amount / Current = Amount Due	Get Consumption Using Usage Request	NA - can't estimate consumption.	BD RATED
CA/CABLE	Apply Rate To Usage Request	Payoff = Bill Amount / Current = Amount Due	Get Consumption Using Usage Request	NA - can't estimate consumption.	BD RATED
CA/E-COY	Apply Rate To Usage Request	Payoff = 0 / Current = Bill Amount	Get Consumption Using Usage Request	N/A - no consumption is needed.	COMPUSAG
CA/WO-STD	N/A - non billable	N/A - non billable	N/A - non billable	N/A - non billable	

CA/WO-LIA	N/A - non billable	N/A - non billable	N/A - non billable	N/A - non billable	
CA/CHARITY	Recurring Charge	Payoff = 0 / Current = Bill Amount	N/A - no consumption is needed	N/A - no consumption is needed	RECUR
CA/PA-REGU	Recurring Charge With Auto Stop	Payoff = 0 / Current = Bill Amount	N/A - no consumption is needed	N/A - no consumption is needed	RECUR-AS
CA/MERCH-I	Recurring Charge For Amount To Bill	Payoff = 0 / Current = Bill Amount	N/A - no consumption is needed	N/A - no consumption is needed	RECUR-AS
CA/DEP-I	Recurring Charge For Amount To Bill	Payoff = 0 / Current = Bill Amount	N/A - no consumption is needed	N/A - no consumption is needed	RECURATB
CA/ONETIME	Billable Charge	Payoff = Bill Amount / Current = Amount Due	N/A - no consumption is needed	N/A - no consumption is needed	BILLCHRG
CA/OVR UNDR	N/A - non billable	N/A - non billable	N/A - non billable	N/A - non billable	
CA/E-SUB ENR	Apply Rate	Payoff = Bill Amount / Current = Amount Due	Get Consumption From Master Bill Segment	N/A - rated sub service agreements are cancelled when their master is canceled.	SUB RATE
CA/E-SUB BC	Billable Charge	Payoff = Bill Amount / Current = Amount Due	N/A - no consumption is needed	N/A - no consumption is needed	SUB BC
CA/E-FIN SETTLE	N/A - non billable	N/A - non billable	N/A - non billable	N/A - non billable	

And now you're ready to set up your bill segment types.

## Setting Up Bill Segment Types

To set up bill segment types, open **Admin > Billing > Bill Segment Type > Add**.

### Description of Page

Enter an easily recognizable **Bill Segment Type** and **Description** for every type of bill segment.

For each bill segment type, define the **Create Algorithm**. The logic embedded in this algorithm creates the bill segment. Refer to [Designing Your Bill Segment Types](#) for examples.

If you haven't done so already, you must set up this algorithm in the system. To do this:

- Create a new algorithm (refer to [Setting Up Algorithms](#) ).
- On this algorithm, reference an Algorithm Type that creates a bill segment in the appropriate manner. Click [here](#) to see the algorithm types available for this plug-in spot.

### WARNING:

The **BS Create Algorithm** is a very important field as it controls how the system creates bill segments. There are some restrictions in respect of the values of certain fields on the SA type and the bill segment algorithm used on a SA type. Refer to [Require Total Amount Switch versus Bill Segment Creation Algorithm, Allow Recurring Charge Switch](#)

versus [Bill Segment Creation Algorithm](#), and [Rate Required Switch versus Bill Segment Creation Algorithm](#) for more information.

---

For each bill segment type, define the **Financial Algorithm**. The logic embedded in this algorithm constructs the financial transaction associated with the bill segment. Refer to [Designing Your Bill Segment Types](#) for examples.

If you haven't done so already, you must set up this algorithm in the system. To do this:

- Create a new algorithm (refer to [Setting Up Algorithms](#) ).
  - On this algorithm, reference an Algorithm Type that constructs the bill segment financial transaction in the appropriate manner. Click [here](#) to see the algorithm types available for this plug-in spot.
- 

**FASTPATH:**

For more information about current and payoff amounts, refer to [Current Amount versus Payoff Amount](#).

---

If the bill segment requires consumption (e.g., meter reads) to be retrieved, define the **Get Consum Algorithm**. The logic embedded in this algorithm retrieves the consumption that is billed on the bill segment. Refer to [Designing Your Bill Segment Types](#) for examples.

If you haven't done so already, you must set up this algorithm in the system. To do this:

- Create a new algorithm (refer to [Setting Up Algorithms](#)).
- On this algorithm, reference an Algorithm Type that retrieves consumption in the appropriate manner. Click [here](#) to see the algorithm types available for this plug-in spot.

The **Auto Cancel Algorithm** is used by the system when it detects that a prior bill segment contains an estimated read that meets certain conditions when a non-estimated read is used on the current bill.

**NOTE:** This is typically not used when usage is requested from Oracle Utilities Meter Data Management.

---

Examples include:

- The prior bill segment contains a bad estimated read (by "bad" we mean that the current bill has a non-estimated reading that is less than the estimated end read on the prior bill segment).
- The prior bill segment contains an estimated read (there may be situations where you want to cancel an estimated bill segment when a non-estimated read is also higher than the end read on the prior bill segment. For example, when tiered rates may cause a customer to be penalized by consumption being charged at a higher rate).

For detecting a bad estimated read on the prior bill segment, if you haven't done so already, you must set up this algorithm in the system. To do this:

- Create a new algorithm (refer to [Setting Up Algorithms](#)).
- On this algorithm, reference an Algorithm Type that cancels bill segments that contain poorly estimated consumption. Click [here](#) to see the algorithm types available for this plug-in spot.

For detecting an estimated read on the prior bill segment, if you haven't done so already, you must set up this algorithm in the system and configure a feature configuration option. To do this:

- Create a new algorithm for the Auto Cancel Algorithm.
- On this algorithm, reference an Algorithm Type that cancels bill segments that contain estimated consumption. Click [here](#) to see the algorithm types available for this plug-in spot (refer to [Setting Up Algorithms](#)).
- Configure the **Always Call Auto Cancel** option type on the Financial Transactions Option feature configuration and set the option type value to 'Y'. For more information about Feature Configurations, see [Defining Feature Configurations](#).

The **Bill Segment Information Algorithm** is used by the system to format the bill segment information that appears throughout the system. If the information you'd like displayed differs for bill segment types, you must set up this algorithm in the system. To do this:



## Where Used

Follow this link to open the data dictionary where you can view the tables that reference [CI\\_BILL\\_SEG\\_TYP](#).

## Designing and Defining Deposit Classes

If you bill for deposits, you must set up one or more deposit classes. If your company does not bill for deposits, you can skip this section.

---

### FASTPATH:

We strongly recommend familiarizing yourself with the concepts described in [The Big Picture Of Deposits](#) before tackling the information in this section.

---

The topics in this section describe how to design and set up deposit classes.

## What Do Deposit Classes Do?

A deposit class contains the business rules that govern:

- How and when deposit interest is calculated.
- How the recommended deposit amount is calculated.
- When a deposit will be automatically refunded to a customer.
- When the system will recommend a new or additional deposit.

When you link a deposit class to a SA type, you are indicating that the SA type's service agreements are governed by the deposit class' business rules.

In addition to linking a deposit class to the SA types used to bill for a deposit, you must also define a deposit class on SA types whose debt is covered by a deposit. Consider the following examples:

- Assume your company sells electricity, gas, and water; but deposits are only held only for electric service. In this situation, you'd need one deposit class - Electric - and you'd associate it with both the electric deposit SA type and the electric usage SA type(s) (the gas and water SA types would NOT reference a deposit class).
- If your company can apply a deposit to any type of debt, then you'd have just one deposit class - General Deposit. You'd link this deposit class to the deposit SA type, and to the other SA types whose debt is covered by the deposit.

---

### NOTE:

**Non-cash deposits.** You can also use the system to manage non-cash deposits (e.g., letters of credit, surety bonds, 3rd party deposits). Non-cash deposits are held in respect of an account (and an account may have an unlimited number of non-cash deposits). Each non-cash deposit must reference a deposit class. Why? Because the system amalgamates cash and non-cash deposits when it determines if an account is holding an adequate deposit. Refer to [3rd Party Deposits](#) for more information.

---

## Designing Your Deposit Classes

A deposit class contains the business rules that govern:

- How and when deposit interest is calculated.
- How the recommended deposit amount is calculated.



- When a deposit will be automatically refunded to a customer.
- When the system will recommend a new or additional deposit.

You will need multiple deposit classes if any of the above rules / conditions differ for different types of customers. For example, if residential customers use a different recommended deposit algorithm as compared to commercial customers, you'd need one deposit class for residential and another for commercial.

You will need additional deposit classes if your customers can have multiple deposits where each deposit is restricted to a specific type of debt. For example, if separate deposits are held for regulated and unregulated debt (and a customer could hold a combination of regulated and unregulated debt), you'd need one deposit class for regulated debt and another for unregulated debt.

We'll design deposit classes to satisfy the needs of a theoretical company to help you understand how to design your deposit classes. The following points describe the deposit requirements of our theoretical company:

- The recommended deposit amount is 2 times the average bill (averaged over the last 12 months). This is true regardless of the type of customer or debt.
- The system should automatically refund a deposit to a customer after:
  - The deposit has been held for at least 6 months; and
  - The account's credit rating is greater than the credit rating threshold defined on the installation record or the account's CIS Division (i.e., the credit rating is no longer considered bad)
- This is true regardless of the type of customer or debt.
- Interest is calculated every 6 months. The interest rate is defined using a bill factor (refer to [Setting Up Bill Factors](#) for more information). This is true regardless of the type of customer or debt.
- When it's time to refund a deposit, all outstanding debt will be paid off first. If any moneys remain, a check should be sent to the customer for the remainder. This is true regardless of the type of customer or debt.
- A customer could have both regulated and unregulated debt under a single account. When this happens, separate deposits will be held for each type of debt (where the regulated deposit can only be used to satisfy regulated debt and the unregulated deposit can only be used to satisfy unregulated debt).

You'd need the following deposit classes to satisfy the above requirement:

Deposit Class	Recommended Amount Rule	Auto Refund Condition	Interest Rules	Deposit Refund Method
Regulated	2 x Average Bill	Held for 6 months and credit rating is good	Simple interest every 6 months	Apply to outstanding debt first, refund remainder with a check
Unregulated	2 x Average Bill	Held for 6 months and credit rating is good	Simple interest every 6 months	Apply to outstanding debt first, refund remainder with a check

You may wonder why two deposit classes are needed when the rules are the same for both? Well, besides defining the applicable business rules for a deposit service agreement, a deposit class is defined on the SA types whose debt is covered by the deposit class' deposit. So, if you have two different types of debt where each type of debt can have its own deposit, you'd need at two deposit classes. Each deposit class would be associated with the service agreements that are being secured by the deposit.

Refer to [Setting Up Deposit Classes](#) for a description of the various algorithms defined in respect of a deposit class.

## Setting Up Deposit Classes

In the previous section, *Designing Your Deposit Classes*, we presented a case study that illustrated a mythical organization's deposit classes. In this section, we explain how to maintain your Deposit Classes.

## Deposit Class - Main

To set up deposit classes, select **Admin > Credit & Collection > Deposit Class > Add**.

### Description of Page

Enter an easily recognizable **Deposit Class** and **Description**.

Use **Refund Description on Bill** to define the information that appears on the bill segment produced when it's time to refund the customer's deposit.

The remaining information on this page is used by the various deposit-oriented processes.

Refer to [Deposit Class - Good Customer](#) for information about the **Good Customer Algorithm**.

Refer to [Deposit Class - Recommendation](#) for information about the **Recommendation Algorithm** and **Review Tolerance Percentage**.

Refer to [Deposit Class - Refund Method](#) for information about the **Refund Method Algorithm**.

Refer to [Deposit Class - Refund Criteria](#) for information about the **Refund Criteria Algorithm**.

Refer to [Deposit Class - Refund Interest](#) for information about the **Interest Refund Algorithm** and **Months Between Interest Refund**.

Refer to [Deposit Class - Review Method](#) for information about the **Review Method Algorithm**.

### Where Used

Follow this link to open the data dictionary where you can view the tables that reference [CI\\_DEP\\_CL](#).

## Deposit Class - Good Customer

On [Deposit Class - Main](#) you must define the **Good Customer Algorithm** used by the system when it determines if a customer is considered good (the system recommends new / additional deposits for bad customers). Refer to [Deposit Review](#) for a description of the background process that reviews customers for adequate deposits.

If you haven't done so already, you must set up this algorithm in the system. To do this:

- Create a new algorithm (refer to [Setting Up Algorithms](#) ).
- On this algorithm, reference an Algorithm Type that determines if a customer is considered good. Click [here](#) to see the algorithm types available for this plug-in spot.

## Deposit Class - Recommendation

On [Deposit Class - Main](#) you must define the **Recommendation Algorithm** used by the system when it calculates a customer's recommended deposit amount.

If you haven't done so already, you must set up this algorithm in the system. To do this:

- Create a new algorithm (refer to [Setting Up Algorithms](#) ).
- On this algorithm, reference an Algorithm Type that recommends deposits. Click [here](#) to see the algorithm types available for this plug-in spot.

The system uses the **Review Tolerance Percentage** to prevent the recommendation of small deposits by the Deposit Review background process. For example, if this field contains 10(%), the system would only recommend an additional deposit if the recommended amount was more than 10% of the existing deposit.

## Deposit Class - Refund Method

On [Deposit Class - Main](#) you must define the **Refund Method Algorithm** used by the system when it refunds a deposit to the customer.

If you haven't done so already, you must set up this algorithm in the system. To do this:

- Create a new algorithm (refer to [Setting Up Algorithms](#) ).
- On this algorithm, reference an Algorithm Type that refunds a deposit to a customer. Click [here](#) to see the algorithm types available for this plug-in spot.

## Deposit Class - Refund Criteria

On [Deposit Class - Main](#) you must define the **Refund Criteria Algorithm** used by the system when it determines if it should automatically refund a deposit to a customer. Refer to [Deposit Review](#) for a description of the background process that reviews deposits for refunds.

If you haven't done so already, you must set up this algorithm in the system. To do this:

- Create a new algorithm (refer to [Setting Up Algorithms](#) ).
- On this algorithm, reference an Algorithm Type that determines if a customer qualifies for a deposit refund. Click [here](#) to see the algorithm types available for this plug-in spot.

## Deposit Class - Refund Interest

On [Deposit Class - Main](#) you must define the **Interest Refund Algorithm** to define how the system calculates interest and how it refunds the interest to the customer.

If you haven't done so already, you must set up this algorithm in the system. To do this:

- Create a new algorithm (refer to [Setting Up Algorithms](#) ).
- On this algorithm, reference an Algorithm Type that calculates interest on a deposit. Click [here](#) to see the algorithm types available for this plug-in spot.

Interest will be automatically calculated every X months where X is defined in **Months Between Interest Refund**. Refer to [Deposit Interest](#) for a description of the background process that calculates interest on deposits. Also note that interest is calculated when a [deposit service agreement is stopped](#).

## Deposit Class - Review Method

On [Deposit Class - Main](#) you must define the **Review Method Algorithm** used by the system to determine what action to take if the system recommends a deposit (or additional deposit) amount for an account. Refer to [Review Deposits](#) for a description of the background process that reviews deposits for refunds. The algorithm supplied with the base product highlights new deposits and deposit amounts on the [Deposit Review](#) page.

If you haven't done so already, you must set up this algorithm in the system. To do this:

- Create a new algorithm (refer to [Setting Up Algorithms](#) ).

- On this algorithm, reference an Algorithm Type that determines the review method the system uses if it recommends a deposit or additional deposit be applied to an account. Click [here](#) to see the algorithm types available for this plug-in spot.

## Setting Up Non-Cash Deposit Types

Non-cash deposit types are used to indicate the type of monetary instrument used for non-cash deposits. Refer to [Non-Cash Deposits](#) for more information.

To define your non-cash deposit types, select **Admin > Credit & Collection > Non-Cash Deposit Type**.

### Description of Page

To modify a non-cash deposit type, move to a field and change its value.

To add a new non-cash deposit type, insert a row, then fill in the information for each field. The following fields display:

**Non-Cash Deposit Type** The unique identifier of the non-cash deposit type.

**Description** The description of the non-cash deposit type.

**Review Before Expiration** This switch indicates if the system will create a To Do entry when non-cash deposits of this type are close to expiration.

**Third Party Deposit** This switch indicates if the system requires a reference to a 3rd party's deposit service agreement for this type of non-cash deposit. Refer to [3rd Party Deposits](#) for more information.

### Where Used

Follow this link to open the data dictionary where you can view the tables that reference [CI\\_NCD\\_TYPE](#).

## Setting Up Payment Segment Types

Every service agreement references a service agreement (SA) type. Amongst other things, the SA type references a payment segment type. The payment segment type controls how payment segments and their related financial transactions are created. To set up payment segment types, open **Admin > Payment Segment Type**.

### Description of Page

Enter an easily recognizable **Payment Segment Type** and **Description** for every type of payment segment.

---

#### FASTPATH:

For more information about the source of the distribution codes on financial transactions, see [The Source Of GL Accounts On Financial Transactions](#).

---

For each payment segment type, define the **Payment Segment Fin Algorithm**. The logic embedded in this algorithm constructs the actual financial transaction associated with the payment segment. Refer to [Examples of Common Payment Segment Types](#) for examples of how algorithms are used on common payment segment types.

If you haven't done so already, you must set up this algorithm in the system. To do this:

- Create a new algorithm (refer to [Setting Up Algorithms](#) ).
- On this algorithm, reference an Algorithm Type that constructs the payment segment financial transaction in the appropriate manner. Click [here](#) to see the algorithm types available for this plug-in spot.

---

#### FASTPATH:

For more information about current and payoff amount, see [Current Amount versus Payoff Amount](#).

---

## Examples of Common Payment Segment Types

The following table shows several classic payment segment types used by many organizations:

Payment Segment Type	Payment Segment Financial Transaction Algorithm
Normal payment (if you practice accrual accounting). Refer to <a href="#">Accrual versus Cash Accounting</a> for more information.	$\text{Payoff} = \text{Pay Amount} / \text{Current} = \text{Pay Amount}$ (no cash accounting)
Normal payment (if you practice cash accounting). Refer to <a href="#">Accrual versus Cash Accounting</a> for more information.	$\text{Payoff} = \text{Pay Amount} / \text{Current} = \text{Pay Amount}$ (plus Cash Accounting)
Charity payment	$\text{Payoff} = 0 / \text{Current} = \text{Pay Amount}$ (the GL is affected)
Non-CIS Payments (When the FT is created, the distribution code and GL account to credit is retrieved from the pay). Refer to <a href="#">Non CIS Payments</a> for more information	$\text{Payoff} = \text{Pay Amount} / \text{Current} = \text{Pay Amount}$ (no cash accounting)

### Where Used

Follow this link to open the data dictionary where you can view the tables that reference [CI\\_PAY\\_SEG\\_TYPE](#).

## Designing And Defining Adjustment Types

A service agreement's debt may be changed with an adjustment. Every adjustment must reference an adjustment type. The adjustment type contains a great deal of information that is defaulted onto the adjustment, including whether the adjustment amount is calculated. It also controls many business processes associated with the adjustment. The topics in this section describe how to design and set up adjustment types.

### What Do Adjustment Types Do?

An adjustment type contains the business rules that govern how its adjustments are managed by the system. Please refer to [The Big Picture Of Adjustments](#) for a complete description of how adjustment types impact the lifecycle of adjustments.

### Setting Up Adjustment Types

The topics in this section describe how to set up adjustment types.

#### NOTE:

**When a new adjustment type is added.** When you introduce a new adjustment type, you must update one or more adjustment profiles with the new adjustment type. Why? Because adjustment profiles define the adjustment types that may be levied on service agreements (adjustment profiles are defined on SA types). If you don't put the adjustment type on an adjustment profile, the adjustment type can't be used on any adjustment.

### Adjustment Type - Main

To set up adjustment types, open **Admin > Financial > Adjustment Type > Add.**

### Description of Page

Enter a unique **Adjustment Type ID** and **Description** for the adjustment type.

If your implementation requires restricting the list of adjustments types that users are able to select by CIS Division, specify a **CIS Division** on the adjustment type.

The **Adjustment Amount Type** indicates whether the adjustment amount is calculated or not. Select **Calculated Amount** when you want to use a rate to perform calculations to generate the adjustment amount otherwise select **Non-Calculated Amount**. Refer to [Setting Up Calculated Adjustment Types](#) for more information about calculated adjustments.

Enter the **Distribution Code** that references the GL account associated with the adjustment. For example, if this adjustment type is used to levy a charge for a bad check, the distribution code would reference the revenue account to which you associate such revenue. Note, the offsetting distribution code is kept on the SA type.

---

#### NOTE:

**Distribution Code for Calculated Adjustments.** Depending on the algorithm used for the [calculated adjustment](#), the distribution code may come from the adjustment type or the calculation lines of the algorithm. If the adjustment's calculation algorithm gets the distribution code from the calculation lines, you do not need to specify a distribution code on the adjustment type.

---

#### FASTPATH:

For more information about the source of the distribution codes on financial transactions, see [The Source Of GL Accounts On Financial Transactions](#).

---

Enter the **Currency Code** for adjustments of this type.

Turn on **Sync. Current Amount** if adjustments of this type exist to force a service agreement's current balance to equal its payoff balance. These types of adjustments are issued before a service agreement's funds are transferred to a write-off service agreement. If this switch is on, choose an **Adjustment Fin Algorithm** that does not impact payoff balance or the GL, but does affect the SA's current balance (refer to [ADJT-CA](#) for an example of such an algorithm).

Enter a **Default Amount** if an amount should be [defaulted](#) onto adjustments of this type.

---

#### FASTPATH:

For more information about current and payoff amounts, refer to [Current Amount versus Payoff Amount](#).

---

If the AP Adjustment should be recorded in respect of the customer's 1099 amounts, indicate the **A/P 1099 Flag**. This would typically be used on the adjustment used to credit the deposit service agreement with accrued interest. The values of this field are Interest and Miscellaneous. This type of adjustment would also have an **A/P Request Type Code** selected, as 1099 reporting is handled in A/P.

Turn on **Print By Default** if information about adjustments of this type should print on the account's next bill.

Choose an **A/P Request Type Code** if this adjustment is interfaced to accounts payable (i.e., it's used to send a refund check to a customer). Refer to [A/P Check Request](#) for more information.

The **Adjustment Freeze Option** defines when adjustments can be frozen and therefore when a service agreement's balance and the general ledger are affected by an adjustment. Refer to [Preventing SA Balances And The GL From Being Impacted Until Bill Completion](#) to understand the significance of this option. Also note, if the [installation option's](#) Bill Segment Freeze Option is Freeze At Will, this field is defaulted to Freeze At Will and cannot be changed.

---

#### WARNING:

Adjustment types for adjustments created during bill completion (e.g., by a bill completion algorithm) must have their adjustment freeze option set to Freeze At Will. Otherwise (i.e., if the option is Freeze At Bill Completion ) they will not be frozen until a subsequent bill is completed.

---

If adjustments of this type require approval, define an **Approval Profile**. For more information, refer to [The Big Picture of Adjustment Approvals](#).

Enter the verbiage to appear on the printed bill in **Description on Bill**.

Use the characteristics collection to define a **Characteristic Type** and **Characteristic Value** common to all adjustments of this type. These can be used for reporting purposes or in your algorithms.

## Adjustment Type - Adjustment Characteristics

To define characteristics that can be defined for adjustments of a given type, open **Admin > Financial > Adjustment Type > Search** and navigate to the **Adjustment Characteristics** page.

### Description of Page

Use the **Adjustment Characteristics** collection to define characteristics that can be defined for adjustments of a given type. Turn on the **Required** switch if the **Characteristic Type** must be defined on adjustments of a given type. Enter a **Characteristic Value** to use as the default for a given **Characteristic Type** when the **Default** switch is turned on. Use **Sequence** to control the order in which characteristics are defaulted.

## Adjustment Type - Algorithms

To define algorithms for adjustments, open **Admin > Financial > Adjustment Type > Search** and navigate to the **Algorithms** page.

### Description of Page

The grid contains **Algorithms** that control important adjustment functions. If you haven't already done so, you must [set up the appropriate algorithms](#) in your system. You must define the following for each algorithm:

- Specify the **System Event** with which the algorithm is associated (see the table that follows for a description of all possible events).
- Specify the **Sequence Number** and **Algorithm** for each system event. You can set the **Sequence Number** to 10 unless you have a **System Event** that has multiple **Algorithms**. In this case, you need to tell the system the **Sequence** in which they should execute.

The following table describes each **System Event**.

System Event	Optional / Required	Description
Adjustment Cancellation	Optional	When an adjustment is canceled an algorithm of this type may be called to do additional work.  Refer to <a href="#">The Lifecycle Of An Adjustment</a> for more information about canceling an adjustment.  Click <a href="#">here</a> to see the algorithm types available for this system event.
Adjustment Freeze	Optional	When an adjustment is frozen an algorithm of this type may be called to do additional work.

Refer to [The Lifecycle Of An Adjustment](#) for more information about freezing an adjustment.

Click [here](#) to see the algorithm types available for this system event.

---

Adjustment Information	Optional	<p>We use the term "Adjustment information" to describe the basic information that appears throughout the system to describe an adjustment. The data that appears in "Adjustment information" is constructed using this algorithm.</p> <p>Plug an algorithm into this spot to override the "Adjustment information" algorithm on installation options or the system default "Adjustment information" if no such algorithm is defined on installation options.</p> <p>Click <a href="#">here</a> to see the algorithm types available for this system event.</p>
Adjustment FT Creation	Required	<p>Algorithms of this type are used to construct the actual financial transaction associated with the adjustment. The financial transaction controls the adjustment's affect on the service agreement's payoff and current balances. It also constructs the information that is eventually interfaced to your general ledger. Refer to <a href="#">Examples of Common Adjustment Types</a> for examples of how algorithms are used on common adjustment types.</p> <p>Click <a href="#">here</a> to see the algorithm types available for this system event.</p>
Default Adjustment Amount	Optional	<p>Algorithms of this type are used to default the adjustment amount. Refer to <a href="#">Default the Adjustment Amount</a> for more information.</p> <p>Click <a href="#">here</a> to see the algorithm types available for this system event.</p>
Determine SA	Optional	<p>Algorithms of this type are used to find a service agreement for which the adjustment can be posted. This plug-in is used particularly during adjustment upload when a staging record does not identify the SA ID. Refer to <a href="#">Interfacing Adjustments From External Sources</a> for more information.</p> <p>Click <a href="#">here</a> to see the algorithm types available for this system event.</p>
Resolve Suspense	Optional	<p>Algorithms of this type are used to automatically resolve adjustments that are in suspense. Refer to <a href="#">Suspense Adjustments</a> for more information</p> <p>Click <a href="#">here</a> to see the algorithm types available for this system event.</p>

---



Generate Adjustment	Optional	Algorithms of this type are used to calculate the adjustment amount if an adjustment type indicates that the adjustment amount is calculated. Refer to <a href="#">Setting Up Calculated Adjustment Types</a> for more information.  Click <a href="#">here</a> to see the algorithm types available for this system event.
Validate Adjustment	Optional	Algorithms of this type are used to validate information for the adjustment after it is generated.  Click <a href="#">here</a> to see the algorithm types available for this system event.

## Setting Up Calculated Adjustment Types

You can use an algorithm to calculate an adjustment amount for example if you need to calculate tax on a base amount or calculate a non-sufficient funds charge based on the customer's credit rating. Because the base package algorithm calculates adjustment amounts by calling the rate application, calculated adjustments are sometimes referred to as ratable adjustments.

**NOTE:**

**Ratable Adjustments Appear Deceptively Simple.** But, they are not. Calculated adjustments that use the base package algorithm have all the power and flexibility (and complexity) of the rate application. Anything that you can do with a rate can be applied to a calculated adjustment. For examples that illustrate the flexibility of the rate application (and therefore calculated adjustments), refer to [Rate Examples](#).

Adjustment types that indicate they are calculated have a generate adjustment algorithm. The base package algorithm defines the rate schedule used to calculate the adjustment as well as any UOM, TOU or SQI parameters.

To set up calculated adjustment types using the base package generate adjustment algorithm type:

- Define the rate that performs the calculations, including the rate schedule, calculation groups, and calculation rules. Refer to [Rates](#) for information.

**NOTE:**

If you create your own Generate Adjustment algorithm type, you may not need to set up a rate that performs the calculations. It depends on the needs of your algorithm type.

- Create a Generate Adjustment algorithm (refer to [Setting Up Algorithms](#) ) that references the base package algorithm type that generates calculated adjustments (see the table above).
- If you want the generation algorithm's calculation lines to provide the distribution codes when the adjustment is posted to the GL, create an Adjustment Financial Transaction algorithm (refer to [Setting Up Algorithms](#) ) that references an algorithm type that creates the adjustment's financial transactions using the calculation lines. A parameter of the adjustment financial transaction algorithm determines whether the distribution codes are taken from the adjustment type (AT) or calculation lines (CL). The system comes supplied with several sample algorithm types that [create adjustment financial transactions](#).
- Create an adjustment type where the **Adjustment Amount Type** is Calculated Amount, the Generate Adjustment event references the generation algorithm created above, and the Adj. Financial Transaction event references the adjustment financial transaction algorithm created above.

## Examples of Common Adjustment Types

The following table shows several classic adjustment types used by many organizations:

Adjustment Type	Typical Distribution Code	Default Amount	Financial Transaction Algorithm	Print On Bill	A/P Adjust-ment	1099
NSF	NSF revenue	Your NSF fee	Payoff = Current = Adj. Amt Refer to <a href="#">ADJT-NM</a> for an example of such an algorithm type	Yes	No	No
LPC	Late payment charge revenue	N/A	Payoff = Current = Adj. Amt Refer to <a href="#">ADJT-NM</a> for an example of such an algorithm type	Yes	No	No
CONNECT	Connection charge revenue	Your connection charge	Payoff = Current = Adj. Amt Refer to <a href="#">ADJT-NM</a> for an example of such an algorithm type	Yes	No	No
CUSTREL	Customer relationship expense	N/A	Payoff = Current = Adj. Amt Refer to <a href="#">ADJT-NM</a> for an example of such an algorithm type	Yes	No	No
ADDCHARG	Misc Revenue	N/A	Payoff = Current = Adj. Amt Refer to <a href="#">ADJT-NM</a> for an example of such an algorithm type	Yes	No	No
XFER	Balance transfer clearing	N/A	Payoff = Current = Adj. Amt Refer to <a href="#">ADJT-NM</a> for an example of such an algorithm type	Yes	No	No
WO SYNC	N/A	N/A	Payoff = 0 / Current = Adj. Amt	No	No	No

			Refer to <a href="#">ADJT-CA</a> for an example of such an algorithm type			
REFUNDAP	A/P clearing	N/A	Payoff = Current = Adj. Amt Refer to <a href="#">ADJT-NM</a> for an example of such an algorithm type	Yes	Yes	No
DPA FIX	N/A	N/A	Payoff = 0 / Current = Adj. Amt Refer to <a href="#">ADJT-CA</a> for an example of such an algorithm type	Yes	No	No
CHARITFX	N/A	N/A	Payoff = 0 / Current = Adj. Amt Refer to <a href="#">ADJT-CA</a> for an example of such an algorithm type	Yes	No	No
BUDG ON	N/A	N/A	Payoff = 0 / Current = Adj. Amt Refer to <a href="#">ADJT-CA</a> for an example of such an algorithm type	Yes	No	No
BUDG OFF	N/A	N/A	Payoff = 0 / Current = Adj. Amt Refer to <a href="#">ADJT-CA</a> for an example of such an algorithm type	Yes	No	No
BUDG FIX	N/A	N/A	Payoff = 0 / Current = Adj. Amt Refer to <a href="#">ADJT-CA</a> for an example of such an algorithm type	Yes	No	No
DEPOSREF	N/A	N/A	Payoff = 0 / Current = Adj. Amt	Yes	No	No

			Refer to <a href="#">ADJT-CA</a> for an example of such an algorithm type			
DEPOSINT	Interest expense	N/A	<p>Payoff = Current = Adj. Amt. Refer to <a href="#">ADJT-NM</a> for an example of such an algorithm type.</p> <p>Or</p> <p>Payoff Amt = Adj Amt / Current Amt = 0. Refer to <a href="#">ADJT-TA</a> for an example of such an algorithm type.</p> <p>Use the first method if you want to have the interest reflected as a credit balance on the customer's bill.</p> <p>Use the second method if you roll the interest amount into the customer's existing deposit on hand.</p>	Yes	No	Yes
DEPFXCR	N/A	N/A	<p>Payoff = 0 / Current = Adj. Amt</p> <p>Refer to <a href="#">ADJT-CA</a> for an example of such an algorithm type</p>	No	No	No

### Where Used

Follow this link to open the data dictionary where you can view the tables that reference [CI\\_ADJ\\_TYPE](#).

## Setting Up Adjustment Type Profiles

Adjustment type profiles categorize your adjustment types into logical groups. When you link a profile to a SA type, you limit the type of adjustments to be linked to the SA type's service agreements. The creation of adjustment profiles and their linkage to SA types prevents inappropriate adjustments from being linked to your service agreements. More than one adjustment type profile may be linked to a SA type.

For example, you can create an adjustment type profile called Miscellaneous Fees and link to it the miscellaneous fee adjustment types. Then, you would link this profile to those SA types that are allowed to levy such fees.

**NOTE:**

**Bottom line.** An adjustment can only be linked to a service agreement if its adjustment type is part of an adjustment type profile that is valid for the service agreement's SA type. If an adjustment type is not linked to a profile, it could never be levied.

To set up adjustment type profiles, open **Admin > Financial > Adjustment Type Profile > Add.**

**Description of Page**

Enter a unique **Adjustment Type Profile** and **Description** for the adjustment type profile.

Indicate the **Adjustment Types** that are part of the profile.

**Examples Of Common Adjustment Profiles**

The following table shows several classic adjustment profiles used by many organizations (we've displayed some attributes from the adjustment type in the following table to help make it more understandable):

Adjustment Profile	Adjustment Type	Typical Distribution Code	Default Amount	Financial Transaction Algorithm
FEES	NSF	NSF revenue	Your NSF fee	Payoff Amt = Adj Amt / Current Amt = Adj Amt
	LPC	Late payment charge revenue	Your LPC	Payoff Amt = Adj Amt / Current Amt = Adj Amt
	CONNECT	Connection charge revenue	Your connection charge	Payoff Amt = Adj Amt / Current Amt = Adj Amt
MISCEXP	CUSTREL	Customer relationship expense	N/A	Payoff Amt = Adj Amt / Current Amt = Adj Amt
XFER	TRANSBAL	Balance transfer clearing	N/A	Payoff Amt = Adj Amt / Current Amt = Adj Amt
REFUND	REFUND	A/P clearing	N/A	Payoff Amt = Adj Amt / Current Amt = Adj Amt
DPA	ADJCURR	N/A	N/A	Payoff Amt = 0 / Current Amt = Adj Amt
	SYNCCURR	N/A	N/A	Payoff Amt = 0 / Current Amt = Adj Amt
CHARITY	CHAR FIX	N/A	N/A	Payoff Amt = 0 / Current Amt = Adj Amt
BUDGET	BUDG ON	N/A	N/A	Payoff Amt = 0 / Current Amt = Adj Amt
	BUDG OFF	N/A	N/A	Payoff Amt = 0 / Current Amt = Adj Amt
	BUDG FIX	N/A	N/A	Payoff Amt = 0 / Current Amt = Adj Amt
	FIX PAY	Customer relationship expense	N/A	Payoff Amt = Adj Amt / Current Amt = 0

DEPOSIT	DEPOSBILL	N/A	Your standard deposit amount	Payoff Amt = 0 / Current Amt = Adj Amt
	DEPOSINT	Interest expense	N/A	Payoff Amt = Adj Amt / Current Amt = Adj Amt
	SYNCCURR	N/A	N/A	Payoff Amt = 0 / Current Amt = Adj Amt
	ADJCUR	N/A	N/A	Payoff Amt = 0 / Current Amt = Adj Amt

### Where Used

Follow this link to open the data dictionary where you can view the tables that reference [CI\\_ADJ\\_TYP\\_PROF](#).

## The Big Picture Of Adjustment Approval

Some implementations require adjustments to be approved by one or more managers before they impact a customer's debt and the general ledger. For example, an adjustment used to rebate a credit balance may require managerial approval before the rebate is sent to the customer. The topics in this section describe how to set up the system to support the approval of adjustments.

### Approval Is Controlled By Approval Profiles

An approval profile contains the rules that define if and how an adjustment is approved. If an adjustment type does not reference an approval profile, the related adjustments do not require third-party approval before they impact a customer's debt. If an adjustment type references an approval profile, the approval profile's approval hierarchy defines if the adjustment requires approval and who the authorized approvers are. For example, an approval profile can be configured with the following approval hierarchy:

- Adjustments < \$0 require approval by the "credit approvers role"
- Adjustments >= \$0 and <= \$10 do not require approval
- Adjustments > \$10 and <= \$100 require the approval of a user that belongs to the "level 1 approvers role"
- Adjustments > \$100 require two levels of approval: first a user that belongs to the "level 1 approvers role" must approve the adjustment; afterwards, the adjustment must be approved by a user that belongs to the "level 2 approvers role"

#### NOTE:

**Transfer adjustments.** The term "transfer adjustment" refers to two adjustments that are used to transfer moneys between two service agreements. The adjustment with the positive amount is considered to be the debit adjustment; the other adjustment is considered the credit adjustment. When a transfer adjustment requires approval, only one of the adjustments needs to be approved. You control whether the debit side or the credit side of a transfer adjustment is used to control the approval process when you set up the approval profile.

### Approval Profiles Can Be Linked To Multiple Adjustment Types

Approval hierarchies are frequently the same for many adjustment types. The system allows an approval profile to be linked to multiple adjustment types to simplify the definition and maintenance of the rules over time.

## Adjustments Created In Batch Are Not Approved

The system assumes that no approval is necessary for adjustments created by batch processes even those whose adjustment type references an approval profile.

## Approval Inserts A Step Into An Adjustment's Lifecycle

[The Lifecycle Of An Adjustment](#) explains how an adjustment is transitioned from the Freezable state to the Frozen state when it should impact the general ledger and the customer's balance. If an adjustment's adjustment type references an approval profile, the user cannot freeze the adjustment directly. Rather, the user must submit the adjustment for approval when it's ready and only when the last applicable approver approves the adjustment will it become Frozen.

---

**NOTE:**

**Freeze during bill completion.** You can configure the system to only freeze certain types of adjustments when the next bill is completed for the adjustment's account. When the last approver approves such adjustments, they remain in the Freezable. When the next bill is completed for the account, these adjustment become Frozen. Such adjustments that have not been approved at the time of bill completion will remain in the Freezable state. Refer to [Preventing SA Balances And The GL From Being Impacted Until Bill Completion](#) for more information.

---

## Approval Requests Manage And Audit The Approval Process

Users submit an adjustment for approval using a dedicated button on the [Adjustment](#) page. When an adjustment is submitted for approval, the system creates an "approval request". The approval request determines if the adjustment requires approval and, if so, the list of approvers. If the adjustment does not require approval, the approval request is updated to indicate such and the adjustment is Frozen immediately (if freezing is allowed prior to bill completion). If the adjustment requires approval, the approval request's state becomes Approval In Progress and the approver(s) are notified.

---

**NOTE:**

**Approval submission logic is customizable.** The previous paragraph describes how the base-package works when an adjustment is submitted for approval. This logic resides in an algorithm that's plugged in on the C1-AdjustmentApprovalProfile business object in the Determine Approval Requirements system event. Your implementation can change this logic by developing a new algorithm and plugging it into this business object. If your logic is meant to supersede the base-package algorithm, remember to inactivate the base-package algorithm by adding an appropriate inactivation option to this business object.

---

## To Do Entries Are Created To Notify Approvers

When an approval request detects an adjustment requires approval, it notifies the first approver by creating a To Do entry. The To Do entry is created using the To Do type and To Do role defined on the approval profile. All users who belong to the approving To Do role can see the entry. When a user drills down on an adjustment approval To Do entry, the [Adjustment - Approval](#) portal is opened. This portal contains summary information about the adjustment and the approval history of the adjustment. This portal is also where the user approves or rejects the adjustment.

When the first user in the To Do role approves an adjustment, the To Do entry is Completed and the approval request's audit log is updated. If there are no higher levels of approval required, the adjustment is Frozen (if freezing is allowed prior to bill

completion) and the approval request is moved to the Approved state. If there are higher levels of approval required, a new To Do entry is created to the next To Do role in the approval hierarchy.

---

**NOTE:**

**To Do entries can create email.** A To Do entry can be configured to create an email message for every user in the To Do role to inform the user(s) of new adjustments requiring their attention. Refer to [To Do Entries May Be Routed Out Of The System](#) for the details.

---

## Monitoring and Escalating Approval Requests

The base-package is supplied with an algorithm that your implementation can use to monitor approval requests that have been waiting too long for approval. This algorithm can complete the current To Do entry and create a new one for a different role when the timeout threshold defined on the algorithm's parameters is exceeded. If you've configured the system to send email for approval, this algorithm can also send x reminder emails (where x is defined on the algorithm's parameters) before the approval request is escalated to the new To Do role. Refer to [C1-APR-TMOUT](#) for more information about this algorithm. If you plan to enable this functionality, plug-in your configured algorithm on the Approval In Progress state on the C1-AdjustmentApprovalRequest business object.

## Rejecting Deletes The Adjustment

When an adjustment is being approved, anyone with access to the adjustment can reject it by using the [Adjustment - Approval](#) portal. Users other than the current approver are allowed to reject an adjustment to allow an "in process" an adjustment to be withdrawn.

When an adjustment is rejected, the following takes place:

- The user is prompted for a reject reason.
- The approval request's audit log is updated with the reject reason and the approval request is moved to the Rejected state.
- The adjustment is deleted.

## Designing Your Approval Profiles

The following points describe a recommended design process:

- Create logical groups of adjustment types where each group has the same monetary hierarchy and approvers. An approval profile will be required for each of these groups.
- The number of To Do types (if any) that need to be created is dependent on how the adjustment approval To Do entries should be organized on To Do lists. For example, if all approval request To Do entries can appear in the same To Do list, you can use the base-package adjustment approval To Do type. However, if your organization prefers each approval profile's To Do entries to appear in a distinct To Do list, a separate To Do type will be needed for each list. Note that the base-package is supplied with a To Do type called [C1-ADAPP](#) that should be used as the basis for any new approval request To Do type.
- The number of To Do roles is dependent on who approves your adjustments. At a minimum, you will require a separate To Do role for each level in your approval profiles. Remember that every user in a To Do role will see its entries (and receive email if you've configured the system to do such).
- Refer to [Monitoring and Escalating Approval Requests](#) for how to configure the system to escalate approval requests that have been waiting too long.
- If your implementation requires email notification when an adjustment requires approval, the following setup is required:



- Set up an outbound message type, external system, and message sender. Refer to [To Do Entries May Be Routed Out Of The System](#) for the details.
- Every To Do type referenced on your approval profiles should be configured as follows:
- Define the [F1-TDEER](#) batch process as the To Do type's routing process
- Set up an algorithm that references the [C1-ADJAREQEM](#) algorithm type and plug it in the External Routing system event.

## Exploring Adjustment Approval Data Relationships

Use the following links to open the application viewer where the physical tables and data relationships behind the approval functionality are documented:

- Click [C1-APPR PROF](#) to view the approval profile maintenance object's tables.
- Click [C1-APPR REQ](#) to view the approval request maintenance object's tables.

## Implementing Other Approval Paradigms

The above sections describe how the base-package adjustment approval process works. Because adjustment approval has been implemented using the C1-AdjustmentApprovalProfile and the C1-AdjustmentApprovalRequest business objects, your implementation can add additional business rules and change the approval user interface as required. Alternatively, if your implementation has a radically different approval process, you can create a different business objects with their own business rules. To learn how to do this, please enroll in the Configuration Tools training class.

## Setting Up Approval Profiles

Approval profiles contain the rules that control how adjustments are approved. To set up an approval profile, open **Admin > Financial > Approval Profile > Add**.

---

### FASTPATH:

Refer to [The Big Picture Of Adjustment Approval](#) for a detailed description of how approval profiles govern the adjustment approval process.

---

The topics in this section describe the base-package zones that appear on the Approval Profile portal.

## Approval Profile List

The Approval Profile [List zone](#) lists every approval profile. The following functions are available:

- Click a [broadcast](#) button to open other zones that contain more information about the adjacent approval profile.
- Click the Add link in the zone's title bar to add a new approval profile.

## Approval Profile

The Approval Profile zone contains display-only information about an approval profile. This zone appears when an approval profile has been broadcast from the Approval Profile List zone or if this portal is opened via a drill down from another page. The following functions are available:

- Click the **Edit** button to start a business process that updates the approval profile.
- Click the **Delete** button to start a business process that deletes the approval profile.
- Click the **Duplicate** button to start a business process that duplicates the approval profile.

Please see the zone's help text for information about this zone's fields.

## Approval Profile's Adjustment Types

The Approval Profile's Adjustment Types zone lists every [adjustment type](#) that is governed by this approval profile. This zone appears when there is at least one adjustment type governed by the approval profile displayed in the Approval Profile zone:

To add an adjustment type to this list:

- Navigate to the Adjustment Type page and display the desired adjustment type.
- Specify the governing approval profile and update the adjustment type.

To remove an adjustment type from this list:

- Navigate to the Adjustment Type page and display the desired adjustment type.
- Change or remove its approval profile and update the adjustment type.

## Designing and Defining Budget Plans

If you allow your customers to pay a budget amount each month (as opposed to their actual bill amount), you must set up one or more budget plans. If your company does not offer budget billing options, you can skip this section.

The topics in this section describe how to design and set up budget plans.

## The Financial Impact Of Budget Plans

The only difference between a customer who participates in budget billing and one who doesn't is that budget billing customer have bill segments where payoff amount differs from current amount. Why? Because the payoff amount is the actual amount of the bill. The current amount is the amount the customer is expected to pay (i.e., their budget amount).

Let's run through an example of a customer on a budget to illustrate a service agreement where these two balances are not the same. The values in the payoff balance and current balance columns reflect the amount due after the financial transaction has been applied:

Date	Financial Transaction	Payoff Balance	Current Balance
1-Jan-99	Bill: \$125, Budget \$150	125	150
15-Jan-99	Payment: \$150	-25	0
2-Feb-99	Bill: \$175, Budget \$150	150	150
14-Feb-99	Payment: \$150	0	0
3-Mar-99	Bill: \$200, Budget \$150	200	150

**FASTPATH:**

For more information about current and payoff amounts, refer to [Current Amount versus Payoff Amount](#).

## What Do Budget Plans Do?

A budget plan contains the business rules that govern:

- How the recommended budget amount is calculated.
- When and how a customer on an ongoing budget plan will have their budget amount periodically trued up.
- The conditions under which the system will highlight an existing budget amount as being anomalous with the customer's current use patterns.

You may have different budget plans for different customer segments. For example, customers with large bills may have their budget amount recalculated every month, whereas small customers may have their budget amount only recalculated annually. You define which budget plans govern a customer's bills via a **budget plan on the customers' accounts**. An account's initial budget plan is defaulted from its customer class. You may override an account's budget plan at will.

## Designing Your Budget Plans

**FASTPATH:**

Refer to [Budget Billing](#) for background information about budget billing.

A budget plan contains the business rules that govern:

- How the recommended budget amount is calculated.
- When and how a customer on an ongoing budget plan will have their budget amount periodically trued up.
- The conditions under which the system will highlight an existing budget amount as being anomalous with the customer's current use patterns.

You will need multiple budget plans if any of the above rules / conditions differ for different types of customers. For example, if residential customers use a different recommended budget algorithm as compared to commercial customers, you'd need one budget plan for residential and another for commercial.

We'll design budget plans to satisfy the needs of a theoretical company to help you understand how to design your budget plans. The following points describe the budget requirements of our theoretical company:

- The recommended budget amount is the last year's real bill amounts plus any existing debit/credit balance divided by 12. This is true regardless of the type of customer.
- The frequency of budget true up is monthly for commercial customers and annually for residential customers.
- The system should highlight when a residential customer's budget is more than 30% out of whack with what their budget amount would be if it was recalculated.
- The system should highlight when a commercial customer's budget is more than 20% out of whack with what their budget amount would be if it was recalculated.

You'd need the following budget plans to satisfy the above requirement:

Budget plan	Recommended Amount Algorithm	True Up Algorithm	Monitor Algorithm
-------------	------------------------------	-------------------	-------------------

Residential	Average Bill	True up every 12 months	Highlight when more than 30% out
Commercial	Average Bill	True up every month	Highlight when more than 20% out

Refer to the Page Controls under [Setting Up Budget Plans](#) for a description of the various algorithms defined in respect of a budget plan.

## Setting Up Budget Plans

In the previous section, *Designing Your Budget Plans*, we presented a case study that illustrated a mythical organization's budget plans. In this section, we explain how to maintain your Budget Plans.

### Budget Plan - Main

To set up budget plans, select **Admin > Credit & Collection > Budget Plan > Add**.

#### Description of Page

Enter an easily recognizable **Budget Plan** and **Description**.

If your implementation requires restricting budget plans to accounts by CIS Division, specify a **CIS Division** on the budget plan.

The remaining information on this page is used by the various budget-oriented processes.

Refer to [Budget Plan - Calculation Algorithm](#) for information about the **Calculation Algorithm**.

Refer to [Budget Plan - Monitor Algorithm](#) for information about the **Monitor Algorithm**.

Refer to [Budget Plan - True Up Algorithm](#) for information about the **True Up Algorithm** and **Months for True Up**.

#### Where Used

Follow this link to open the data dictionary where you can view the tables that reference [CI\\_BUD\\_PLAN](#).

### Budget Plan - Calculation Algorithm

On [Budget Plan - Main](#) you must define the **Calculation Algorithm** used by the system when it calculates a customer's recommended budget amount.

If you haven't done so already, you must set up this algorithm in the system. To do this:

- Create a new algorithm (refer to [Setting Up Algorithms](#) ).
- On this algorithm, reference an Algorithm Type that calculates recommended budget amounts. Click [here](#) to see the algorithm types available for this plug-in spot.

### Budget Plan - Monitor Algorithm

On [Budget Plan - Main](#) you must define the **Monitor Algorithm** used by the [Budget Monitor](#) background process when it determines if a customer's budget plan is out-of-sync with their consumption patterns.

---

#### NOTE:

**What happens?** If the algorithm determines that a customer's budget plan is out-of-sync with its current recommended amount, an entry is added to the [Budget Review](#) page.

---

If you haven't done so already, you must set up this algorithm in the system. To do this:

- Create a new algorithm (refer to [Setting Up Algorithms](#) ).
- On this algorithm, reference an Algorithm Type that highlights if a customer's current budget amount is out-of-sync with their consumption patterns. Click [here](#) to see the algorithm types available for this plug-in spot.

## Budget Plan - True Up Algorithm

On [Budget Plan - Main](#) you must define the **True Up Algorithm** used by the [Budget True Up](#) background process when it periodically true's up a customer's budget.

If you haven't done so already, you must set up this algorithm in the system. To do this:

- Create a new algorithm (refer to [Setting Up Algorithms](#) ).
- On this algorithm, reference an Algorithm Type that true's up budget amounts. Click [here](#) to see the algorithm types available for this system event.

The system will automatically true up a customer's budget amount every X months (X is defined in **Months for True Up**).

## Tender Management

When a payment is received, a tender is created to record what was remitted (e.g., cash, check, credit card). The topics in this section describe control tables that must be set up in order to remit tenders.

---

### **FASTPATH:**

We strongly recommend [Tender Management and Workstation Cashiering](#) before setting up the control tables described in this section.

---

## Setting Up Tender Types

Tender types are used to indicate the method in which the tender was made. A unique **Tender Type** must exist for every type of tender that can be remitted. For example, if you allow cash, checks, direct debits from a checking account, and direct debits from a credit card to be tendered, you'd need the following tender types:

Tender Type	Description	Like Cash	Generate Auto Pay	Require External Source ID	Require Expiration Date	External Type
CASH	Cash	Yes	No	N/A	N/A	N/A
CHEC	Check	No	No	N/A	N/A	N/A
OVUN	Cash drawer - over/under	No	No	N/A	N/A	N/A
DDCH	Direct debit - checking	No	Yes	Yes	No	Checking withdrawal

CRED	Direct debit - credit card	No	Yes	No	Yes	Credit card withdrawal
------	-------------------------------	----	-----	----	-----	---------------------------

Go to **Admin > Financial > Tender Type** to define your tender types.

### Description of Page

Enter a unique **Tender Type** and **Description** for the tender type.

Turn on the **Like Cash** switch if this tender type is cash or the equivalent of cash. This indicator controls if the system generates a warning if a cash-only account remits a tender other than cash. It is also used to generate a warning for online cashiers to turn in their tenders when the cash-like amount exceeds the maximum amount balance defined for the [tender source](#).

Turn on **Generate Auto Pay** if this type of tender causes an automatic payment request to be routed to a financial institution. For example, this switch will be on if this tender type is used for direct debits from a customer's checking account (because every tender of this type will have an automatic payment request created when the tender is created).

The following fields are only used for tender types associated with automatic payments:

**External Type** This field is used by the background process that creates the information that is interfaced to the automatic payment source. Specifically, it controls the record type associated with the different types of automatic payments that are routed to the automated clearinghouse (ACH).

---

#### NOTE:

The values for this field are customizable using the Lookup table. This field name is EXT\_TYPE\_FLG.

---

**Require Ext. Src. ID** This switch indicates if an Auto-Pay Source that references this type of tender must contain an External Source ID. The External Source ID is the unique identifier of the financial institution to which the automatic payment will be routed.

This switch is typically turned on for tender types associated with checking / saving direct debits. It is turned off for tender types associated with credit card debits (you don't need an external source for a credit card debit, you just need the credit card number).

**Expiration Date Required** Turn this switch on if an Auto-Pay Option that references an auto-pay source that references this type of tender must also contain an expiration date (e.g., automatic debit / credit cards).

Turn this switch off for tender types associated with checking / saving direct debits.

**Tender Authorization** Indicates that tenders of a particular type require authorization prior to being created.

**Business Object** If Tender Authorization has a value of Required, a Business Object must be specified for the tender type. The primary function of this Business Object is to manage the authorization of payment tenders.

---

#### FASTPATH:

For more information on authorizing credit card payments, refer to the Tender Type - Credit Card with Authorization business object.

---

Turn on **Allow Cash Back** if the system should automatically calculate a cash back amount when a tender is remitted for this tender type and the amount tender exceeds the amount being paid.

### Where Used

Follow this link to open the data dictionary where you can view the tables that reference [CI\\_TENDER\\_TYPE](#).

## Setting Up Tender Sources

A unique **Tender Source** must exist for every potential source of funds. For example,

- Every cashiering station will have a unique tender source.

---

**NOTE:**

If your organization accepts alternate currency payments online, then a tender source must exist for each currency code accepted at the cashiering station.

---

- Every lock box will have a unique tender source.
- Your remittance processor will have a unique tender source.
- If you allow customers to pay bills automatically (e.g., via EFT), you'll need a tender source for each institution to which you route automatic payment requests. For example, if you route automatic payment requests to the automated clearinghouse (ACH), you'll need a tender source for the ACH.

For example, if you have 3 lock boxes, 2 cash drawers at an area office A, 2 cash drawers at area office B, and a single remittance processor, you'd need the following tender sources:

Tender Source	Type	External Source ID (Lockbox ID)	Default Starting Balance	Currency Code	Suspense Service Agreement
CASH-A01	Cashiering	N/A	150.00	USD	N/A
CASH-A02	Cashiering	N/A	150.00	USD	N/A
CASH-B01	Cashiering	N/A	150.00	USD	N/A
CASH-B02	Cashiering	N/A	150.00	USD	N/A
LB-INDUS	Lockbox	112910-A	N/A	USD	9291019281
LB-COMM	Lockbox	938219-C	N/A	USD	4739837372
LB-RESID	Lockbox	372829-B	N/A	USD	1912910192
REMIT	Lockbox	N/A	N/A	USD	1920038437
ACH	Auto Pay	N/A	N/A	USD	N/A

To set up a tender source, select **Admin > Financial > Tender Source > Add**.

### Description of Page

Enter an easily recognizable **Tender Source** and **Description** for the tender source.

Define the **TenderSource Type**. Valid values are: Ad Hoc, Auto Pay, Online Cashiering and Lockbox. The system uses this information to prevent tender controls from different sources from being included under the same deposit control. In other words, you can't mix ad hoc, automatic payment, cashiering and lockbox tenders under the same deposit control.

---

**FASTPATH:**

For more information, refer to [Maintaining Deposit Controls](#).

---

If the source is an external system (e.g., a lockbox or an automatic payment destination), use **External Source ID** to define the unique identifier of the source. The background process that interfaces tenders from this source uses this information to create the appropriate tender control when it interfaces payments from external sources.

If this source is a cash drawer, define the **Default Starting Balance**. This balance is defaulted onto new tender controls and may be overridden.

---

**NOTE:**

The tender type of the **Start Balance** is defined on the installation record.

---

If this source is a cash drawer, define the **Max Amount Balance**. When the amount of [cash-like](#) tenders in a cash drawer exceeds this balance, a warning is issued to remind the cashier to turn in some of the funds to a tender control.

Define the **Currency Code** of tenders linked to this source. All tenders in a source must be of the same currency.

If this tender source is associated with payments that are [interfaced from an external source](#) (e.g., a lockbox or a remittance processor), use Suspense **Service Agreement** to define the service agreement whose account will hold uploaded payments with an invalid account. Refer to [Payment Upload Error Segmentation](#) for more information about suspense service agreements. Also note, because the payment upload process simply books payments that reference invalid accounts to the account associated with this service agreement, this account should belong to a customer class with the appropriate payment distribution algorithms. This may entail creating a new customer class that will only be used on these "suspense accounts". This customer class would need the following algorithms:

- We'd recommend using a simple payment distribution algorithm like [PYDIST-PPRTY](#) (distribute payment based on SA type's payment priority and the age of the debt).
- We'd recommend using an overpayment distribution algorithm like [OVRPY-PPRTY](#) (distribute overpayment to highest priority SA type).

Define the **Bank Code** and **Bank Account** into which the tender source's moneys will be deposited. The bank account defines the distribution code used to build the GL details for the payment. Refer to [The Source of GL Accounts on Financial Transactions](#) for more information. Note that the bank code and bank account can later be overwritten when entering Tender Deposits on [Deposit Control](#).

If this tender source is associated with payments that are [interfaced from an external source](#), for example tender sources associated with Auto Pay and Lockbox **Tender Source Types**, the information is also used as follows:

- The [payment upload process](#) uses this information to populate the bank and bank account when it creates deposit control records for the tender controls it creates during the interface. Refer to [Managing Payments Interfaced From External Sources](#) for more information.
- The [automatic payment interface](#) uses this information to populate the bank and bank account when it creates deposit control records for the tender controls it creates during the interface.

### Where Used

Follow this link to open the data dictionary where you can view the tables that reference [CI\\_TNDR\\_SRCE](#).

---

#### NOTE:

If your organization accepts alternate currency payments online, then a tender source must exist for each currency code accepted at the cashiering station. When a user adds a tender control the system attempts to default a tender source based on the currency of the deposit control and the tender source(s) define on the user's record.

---

#### FASTPATH:

Refer to [Alternate Currency Payments](#) for more information.

---

## Automatic Payment Options

If your customers can pay their bills automatically (via direct debit or credit card debits), you'll need to set up the various control tables described in this section.

---

#### IMPORTANT:

Besides the tables described in this section, additional values must also be added to control tables defined under [Tender Management](#). Specifically, refer to [Setting Up Tender Types](#) and [Setting Up Tender Sources](#).

---

#### FASTPATH:



Refer to [Automatic Payments](#) for more information about how automatic payments are handled in the system.

---

## Setting Up Auto Pay Route Types

This portal is used to display and maintain an Auto Pay Route Type.

Auto Pay Route Types are used to control when and how automatic payment requests are routed to a financial institution, and when the general ledger is impacted.

You can access the portal from **Admin > Financial > Auto Pay Route Type**.

The information captured on the auto pay route type depends on the business objects supported by your implementation. Refer to the embedded help for more information.

### Where Used

Follow this link to open the data dictionary where you can view the tables that reference [CI\\_APAY\\_RT\\_TYPE](#).

## Setting Up Auto Pay Source Codes

A unique **Auto Pay Source** must exist for every bank / credit card company / bill payment service that your customer's use as the source of the funds when they sign up for automatic payment. For example,

- Every bank will have a unique auto pay source.
- Every credit card company will have a unique auto pay source.

To set up an auto pay source, select **Admin > Financial > Auto Pay Source Type > Add**.

### Description of Page

Enter an easily recognizable **Auto Pay Source Code** and **Description** for the auto pay source.

The **Source Name** is the name of the financial institution.

When the system creates an automatic payment request, it also creates an associated payment tender. This tender (like all tenders) must have a tender type. This field defines the **Tender Type** associated with this auto pay source's tenders. Refer to [Setting Up Tender Types](#) for more information.

The **External Source ID** is the unique identifier of the financial institution to which the automatic payment will be routed (e.g., the bank routing ID of the bank). This field is typically blank on automatic payments routed to credit card companies because the credit card company doesn't have an external source ID (whereas direct debits from banks must have a bank routing number). Whether this field is required is controlled by the **Tender Type**.

The **Auto Pay Route Type** controls when and how automatic payment requests get routed to a financial institution. It also controls when the general ledger is impacted by the automatic payments financial transaction. Refer to [Setting Up Auto Pay Route Types](#) for more information.

The **Work Calendar** defines the financial institution's workdays. This information is used to determine the date on which automatic payment requests will be sent to the financial institution. Refer to [Setting Up External Workday Calendars](#) for more information.

The **Validation Algorithm** defines how the system validates the customer's account ID at the financial institution. If you haven't done so already, you must set up this algorithm in the system. To do this:

- Create a new algorithm (refer to [Setting Up Algorithms](#) ).
- On this algorithm, reference an Algorithm Type that validates the customer's account ID at the financial institution. Click [here](#) to see the algorithm types available for this plug-in spot.

Refer to [Account - Auto Pay](#) for more information.

## Where Used

Follow this link to open the data dictionary where you can view the tables that reference [CL\\_APAY\\_SRC](#).

## SEPA Payments

The topics in this section provide background information about the Single Euro Payments Area (SEPA) payment functionality.

---

**NOTE: This section is only relevant for some organizations.** The system configuration requirements described in this section are only relevant if your organization is participating in SEPA payment transactions such as direct debit collection.

---

## What Is SEPA?

SEPA (Single Euro Payments Area) is a European Union (EU) integration initiative that is aimed at streamlining processes that are related to cross-border payments. SEPA consists of the EU member states plus a few additional countries. In SEPA, customers can make electronic Euro payments within and across these countries under the same rights and obligations. SEPA payment services are based on global ISO (International Organization for Standardization) standards.

## SEPA Direct Debit

The SEPA Direct Debit (SDD) scheme allows a creditor to collect money from the debtor, with prior approval from the debtor. The direct participants are the following:

- Creditor
- Creditor's bank
- Debtor
- Debtor's bank

The debtor and creditor must each hold an account with a payment service provider located within SEPA. The accounts may be in Euro or in any other SEPA currency. However, the transfer of funds between the debtor's bank and the creditor's bank always takes place in the Euro currency. The indirect participants are the following:

- Clearing and Settlement Mechanisms (CSMs) such as an automated clearinghouse
- Intermediary Banks that offer intermediary services to debtor banks and/or creditor banks

## SEPA Direct Debit Mandate

The mandate is the consent and authorization that the debtor gives to the creditor, to allow the creditor to initiate direct debit collections. The creditor is responsible for storing the original mandates, together with any amendments relating to the mandate or information regarding its cancellation or lapse. The contents of this section describe how mandates are issued and canceled.

## Issuing a Mandate

The creditor initiates the issuance of a mandate by sending the mandate form (either paper or electronic) to the debtor with the creditor information filled in. The creditor information includes the creditor's unique identifier as a SEPA creditor. An ISO standard specifies the structure of the creditor identification, which includes country code, a check digit, the creditor's business code and a country-specific identifier for the creditor. The creditor ensures that the mandate form contains the mandatory legal wording and the mandatory set of information, as specified in the standards. The debtor must ensure that the required information is supplied and that the mandate is signed, either in writing or electronically. The mandatory debtor

information includes the debtor's international bank account number (IBAN) and bank identifier code (BIC). The creditor assigns a unique reference for the mandate and provides that reference to the debtor before the first initiation of a collection. The debtor can then use both the unique mandate reference and the creditor identification to verify the bank transactions.

## Canceling a Mandate

A mandate can be canceled by either the debtor or the creditor, without the involvement of either bank.

## The Lifecycle of a Direct Debit Mandate Task

The following diagram shows the possible lifecycle of the Direct Debit Mandate Task business object:

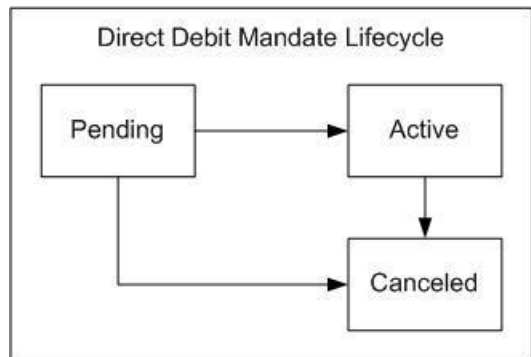

**Pending State:** The direct debit mandate starts out in a pending state.

**Active State:** The direct debit mandate is transitioned manually by a user to the active state. Once a mandate is created and activated in the system, the account's auto pay information must be updated to reflect information on the mandate. This process may be automated within the mandate's lifecycle and a sample algorithm exists in the demo database to achieve this. This algorithm is also included in the export bundle in the demo database.

**Canceled State:** The direct debit mandate is transitioned manually by a user to the canceled state.

## Configuring the System for SEPA Direct Debits

The following sections describe the setup required if your organization intends to process SEPA direct debit transactions.

### Define Auto-Pay Route Type

Configure an auto-pay route type for routing direct debit requests to a financial institution. This auto-pay route type must reference the SEPA Direct Debit Payment Extract (C1-SDDCE) batch process.

Refer to [Setting Up Auto-Pay Route Types](#) for more information.

### Define Auto-Pay Source Type

Ensure that your auto-pay source codes reference the above auto-pay route type. You must also configure a validation algorithm on the auto-pay source type to ensure the International Bank Account Number (IBAN) defined on the Auto-pay Source of the Account has the correct format.

Refer to [Setting Up Auto Pay Source Codes](#) for more information.

## Define a Direct Debit Task Type

Your implementation must configure a **Direct Debit Task Type**. This service task type captures general information that the SEPA extract process needs to create the output file. The base product provides a business object for direct debit task type, **C1-DirectDebitMandateTaskType**.

Note that the direct debit task type is maintained on the Service Task Type portal.

## Define SEPA Country Codes

The list of countries and territories that are part of the Single Euro Payment Area (SEPA) must be defined on extendable lookup **C1-SEPACountryCodeLookup**. These country codes are used by the system to validate the creditor identification entered on a direct debit task type.

Note that an export bundle exists in the demo database that includes a sample list of SEPA country codes. This list must be verified by your implementation for accuracy.

## Define Mandate Cancel Reasons

A cancel reason is required when canceling a direct debit mandate. Ensure that these status reasons have been configured for the direct debit task business object, **C1-DirectDebitMandateTask**.

## Define Navigation Options

The base product includes navigation options for easy access to query and maintain an account's direct debit mandate. To access these portals, add a new menu item to the account context menu (**CI\_CONTEXTACCOUNT**). This menu item should include two menu lines:

- A context menu line for navigation to the direct debit mandate that references a navigation option of **c1DirectDebitMandate**. The system uses the account in context and attempts to find the most recent active mandate for the account. If a mandate exists, navigation is to the service task maintenance portal. If an active mandate does not exist, navigation is to the service task query portal.
- A context menu line for adding a new direct debit mandate that references a navigation option of **c1AddDirectDebitMandate**.

## Setting Up Account Auto Pay

The SEPA direct debit extract process retrieves banking details from the account's auto pay record. Once a mandate is created and activated in the system, the account's auto pay information must be updated to reflect information on the mandate. This process may be automated within the mandate's lifecycle and a sample algorithm exists in the demo database to achieve this. This algorithm is also included in the export bundle in demo.

## Third Party Payment Processing Options

If you allow customers to make one time payments and/or pay bills automatically through a third party payment processing system, you will need to set up a number of control tables to enable these functions in the system.

---

**IMPORTANT:** Aside from the tables mentioned in these sections, control tables defined under [Automatic Payment Options](#) must also be configured. Additional values must also be added to control tables defined under [Tender Management](#). Specifically, refer to [Setting Up Tender Types](#) and [Setting Up Tender Sources](#).

---

---

**FASTPATH:** Refer to [Third Party Payment Processing](#) for the big picture of third party payment processing.

---

## Define Service Task Types

The web services used to process one time payment notifications, automatic payment setup and account verification create a corresponding service task record to perform the needed actions.

The following service task types need to be configured and defined on the Third Party Payment Processing Integration master configuration:

- A **Third Party One Time Payment** service task type is used to create an immediate or scheduled third party one time payment. The base product supplies the following service task type and service task business objects: **C1-ThirdPartyOneTimePyTaskType** and **C1-ThirdPartyOneTimePyTask**. Refer to these business objects for details on schemas and processing logic.
- A **Third Party Account Verification** service task type is used to verify an account, which is typically done prior to capturing and processing a one time payment within the third party payment processing system. The base product supplies the following service task type and service task business objects: **C1-ThirdPartyAcctVerifTaskType** and **C1-ThirdPartyAcctVerifTask**. Refer to these business objects for details on schemas and processing logic.
- A **Third Party Auto Pay Setup** service task type is used to add or update an account's ongoing automatic payment option. The base product supplies the following service task type and service task business objects: **C1-ThirdPartyAutoPayTaskType** and **C1-ThirdPartyAutoPayTask**. Refer to these business objects for details on schemas and processing logic.

Refer to [Defining Service Task Types](#) for details on setting up service task types

## Define Auto Pay Sources and Auto Pay Route Types

Configure specific auto pay sources for the payment types that your third party payment processing system accepts for one time payment processing and ongoing automatic payment processing. Base-supplied Payment Type values are: Checking Withdrawal, Savings Withdrawal and Credit Card Withdrawal. Your implementation can add payment types. In the Third Party Payment Processing Integration master configuration, each accepted payment type is associated with a Tender Type that is used to create the payment tender associated with a third party one time payment. For checking and savings payment types, the tender type and routing number are used to identify the auto pay source.

Auto pay sources used for ongoing automatic payment processing (i.e. ACH) should be associated with an auto pay route type that specifies C1-TAPEX as the Extract Batch. This ensures that the correct extract batch code is stamped on bill-related auto pay staging records during auto pay activation.

## Define Tender Cancel Reason

Configure a Tender Cancel Reason that will indicate that a payment tender was canceled from the third party payment processing system. This cancel reason is configured in the Third Party Payment Processing Integration master configuration and used when a scheduled or processed one time payment is canceled.

## Third Party Processing DateTime

The services used in third party payment processing allow for the possibility that the third payment processing system is processing in a different time zone as the utility's. The Third Party Payment Processing Integration master configuration includes the third party's Processing Cutoff Time and Processing Cutoff Time Zone, as well as the local equivalent of the processing cutoff time, based on the Time Zone defined on the Installation record.

The payment datetime that is sent by the third party payment processing system with one time payment notifications and auto pay confirmations is stored as-is as a characteristic on the one time payment's tender. This is done for the purposes of tender controls processing and payments reconciliation (*i.e.*, with reports generated from the third party payment processing system).

As a standard, inbound and outbound communications external systems must use the standard xsd datetime format (yyyy-MM-dd'T'hh:mm:ss[+ or -]hh:mm). The payment datetimes sent with third party one time payment notifications and auto pay confirmations should follow this format.

The Third Party One Time Payment Task also stores the local equivalent of the payment datetime, based on the Time Zone defined on the Installation record. This local datetime is used anywhere third party one time payments (and their payment dates) are displayed in the system (*e.g.*, in the [Scheduled Payments Log](#) in Control Central - Account Information).

## Third Party Payment Processing Master Configuration

The integration with a third party payment processing system requires the setup of master configuration data that controls the processing of one time payments and ongoing automatic payments.

To set up the third party payment processing master configuration, navigate using **Admin > General > Master Configuration**. You are brought to an all-in-one portal with options to add/edit the Third Party Payment Processing Integration master configuration record.

Refer to the master configuration's embedded help for more details on how each section in this record is configured.

## Payment Advices

The topics in this section provide background information about payment advice functionality.

---

**NOTE:**

**This section is only relevant for some organizations.** The system configuration requirements described in this section are only relevant if your organization issues payment advices to the customer instead of initiating electronic funds transfer directly to the customer's bank.

---

## What Is A Payment Advice?

Payment advice is a money order that is established at the initiative of the utility. When a bill is completed, the utility sends the customer a document that indicates a payment amount and the customer's bank details. If the customer agrees to the information on the payment advice, he/she signs it and returns it to the clearinghouse address that is indicated on the payment advice. The clearinghouse, in turn, sends the dated and signed payment advice to the customer's bank, which completes the payment.

## Payment Advice vs. Direct Debit

The existing functionality that creates automatic payments is referred to as direct debit processing. Payment advice processing differs from direct debit processing in the way that automatic payments get initiated. With payment advice processing, the usual automatic payment records - *i.e.* payment event, payment, tender and auto pay clearinghouse staging - are not created. Instead, a payment advice is printed and sent to the customer. The customer sends the approved payment advice directly to the clearinghouse.

---

**NOTE:**

The system does not provide sample processes for extracting and printing payment advice information. Your implementation team would have to create these.

---

## Setting Up The System To Enable Payment Advices

You must set up a Financial Transaction Options [Feature Configuration](#) to define parameters that control payment advice functionality.

The following points describe the various **Option Types** that must be defined:

- **Payment Advice Functionality Supported.** This option controls whether the system allows for payment advice processing.
  - Enter Y if the system should allow for both direct debit and payment advice processing.
  - Enter N if the system should only allow for direct debit processing.
- **Default Auto Pay Method.** This option is used for defaulting the auto pay method on new account auto pay records.

Refer to [Account - Auto Pay](#) for more information on auto pay method.

---

**NOTE:**

The system assumes direct debit processing if the above feature options are not defined.

---

## Credit Card Payments

If your organization accepts credit card payments, you can configure the system to authorize customers' credit card charges in real-time, and perform an authorization reversal (also in real-time) when the credit card payment is canceled. When the authorization web service is not available, you can permit users to enter authorization codes manually so that they can continue processing payments.

## Configuring the System for Tender Authorization

The following sections describe the setup required if your organization intends to use the base CyberSource integration tender authorization functionality.

### Define the Outbound Message Type

An outbound message type is required for the CyberSource authorization outbound message. This outbound message type must reference the base CyberSource - Credit Card Authorization business object.

An outbound message type is required for the CyberSource reversal outbound message. This outbound message type must reference the base CyberSource - Credit Card Reversal business object.

### Define the Message Sender

A Message Sender is required to define how to send messages to CyberSource. Use the context of the Message Sender to define the web service interface.

## Define the External System and Configure the Messages

Define an external system and configure the valid outbound message types and the method of communication for each (XAI, Batch or Real Time; Real Time is generally the appropriate choice for credit card authorization). You will also need to select the appropriate XSLs to format both the request and response to the outbound message types for CyberSource.

## Define a User

Add a user to hold details required for CyberSource communication. Security information (e.g. Merchant Id, Merchant Reference Code, CyberSource User Name and Password) needed to interface with CyberSource is stored as user characteristics.

## Set up the Tender Authorization Algorithm

A Tender Type (BO) - Tender Authorization algorithm must be configured. This algorithm performs a tender authorization or a tender authorization reversal through CyberSource.

## Define a Business Object

A business object (BO) must be created for the TENDER TYPE maintenance object. This BO must reference the tender authorization algorithm created.

## Define Tender Types

Update the appropriate tender type(s) to denote that authorization is required. The new business object must be specified on the tender type(s).

## Tender Authorization - Feature Configuration

If your implementation has a need to prevent users from overriding the automatic tender authorization, then you must set up the Allow Manual Tender Authorization Override option type on the Financial Transaction Options [Feature Configuration](#). The Allow Manual Tender Authorization Override option must have a value of N in order to suppress the Authorization Override checkbox.

---

**FASTPATH:**

For more information on credit card payment authorization refer to the Tender Type - Credit Card with Authorization business object.

---

## Non CIS Payments



Payment Templates can be configured for common types of non CIS payment allocations. These templates are used to default the payment distribution and allow non CIS payments to be directly allocated to specific distribution codes.

## Setting Up Payment Templates

Payment templates contain the rules that control how non CIS payments are created. You can use a payment template to default the payment distribution for common types of non CIS payments. To set up a payment template, open **Admin** > **Financial** > **Payment Template** > **Add**. The topics in this section describe the base-package zones that appear on the Payment Template portal.

### Payment Template List

The Payment Template [List zone](#) lists every payment template. The following functions are available:

- Click a [broadcast](#) button to open other zones that contain more information about the adjacent payment template.
- Click the Add link in the zone's title bar to add a new payment template.

### Payment Template

The Payment Template zone contains display-only information about a payment template. This zone appears when a payment template has been broadcast from the Payment Template List zone or if this portal is opened via a drill down from another page. The following functions are available:

- Click the **Edit** button to start a business process that updates the payment template.
- Click the **Delete** button to start a business process that deletes the payment template.
- Click the **Duplicate** button to start a business process that duplicates the payment template.
- Click the **Activate** or **Deactivate** button to start a business process that updates the status of the payment template.

Please see the zone's help text for information about this zone's fields.

## Alternate Currency Payments

The topics in this section provide background information about alternate currency payments.

---

**NOTE:**

**This section is only relevant for some organizations.** The system configuration requirements described in this section are only relevant if your organization accepts payments tendered in a currency other than the customer's currency. If your organization does not accept alternate currency payments, you need only indicate such on the [Installation Record](#); no other setup is required.

---

### What Is An Alternate Currency Payment?

The currency code on the customer's account defines the currency in which the account's financial transactions are expressed. If the customer remits a payment in a different currency, this is referred to as an alternate currency payment. The system enables conversion of the tendered amount to the account's currency and captures the alternate currency and amount,

as well as the exchange rate used in the conversion on the payment tender. The payment tender is linked to a tender control that references the alternate currency.

## Configuring the System for Alternate Currency Payments

### Allowing Alternate Currency Payments

You must set the **Alternate Currency** flag on the [Installation Record](#) to Allowed if your organization accepts alternate currency payments. This option controls whether the **Currency Converter** button is displayed when a payment is processed on the payment portal.

### Payment Event Business Object

A business object (BO) must be created for the PAY EVENT maintenance object. You must specify this BO as the option value for the CIS Payment Event Add BO option type on the Financial Transaction Options [Feature Configuration](#). This BO must have the Currency Conversion Script BO option defined. This BPA script is invoked when the user clicks on the **Currency Converter** button during CIS payment processing on the payment portal.

---

**NOTE:**

**Currency conversion logic is customizable.** The base product includes a script for currency conversion called C1-ConvCurr that's plugged in on the C1-CISPaymentEvent business object. This script converts an alternate currency amount to the account's currency using a bill factor value. The bill factor to use is derived by concatenating the alternate currency code and the account's currency code. For example, if converting US Dollars (USD) to Barbados Dollars (BBD) the bill factor code to use would be USDBBD. Your implementation can change this logic by developing a new script and plugging it into the payment event business object.

---

### Define the User's Tender Sources

Define the tender source(s) for the location (e.g., the specific cash drawer) in which a user's payment tenders are stored during the day. A tender source should be specified for each currency that payments are accepted in. The tender source(s) on the user record are used by the system when a user adds a new tender control. The system attempts to default a tender source on a new tender control based on the deposit control's currency and the tender source(s) defined on the user's record.

### Payment Event Distribution

The base-package, by default, creates a single payment for a payment event. If your business requires potentially many payments to be created when payment events are added, you'll need to set up the various control tables described in this section.

---

**FASTPATH:**

Refer to [Distributing A Payment Event](#) for more information about how payment event distribution is handled in the system.

---

## Making Payments Using Distribution Rules

As part of this method, one or more distribution details are provided at payment time along with the usual payment and tender information. Each distribution detail record references a distribution rule and a corresponding value. The distribution rule encapsulates the business rules that govern the distribution of the payment amount into payments using the specified value.

The type of value being captured on the distribution detail and the logic that uses it to create payments are defined on the [distribution rule](#).

### Rule Value

The primary use of the rule value is to identify the business entity whose balance is to be relieved by creating payment(s). In most cases where the payor account is the same as the payee account it may also be used to identify the tender account associated with the payment(s).

### Determine Tender Account

The very first step in processing a distribution detail is to identify the tender account (i.e. the payor) associated with the payment. To do that the system calls the Determine Tender Account [algorithm](#) defined on the distribution rule providing it with the rule value and other tender information.

### Creating Payment(s)

The business logic that distributes a payment amount into one or more payments(s) targeted towards the entity identified by a rule value is held in designated Create Payment [algorithms](#) defined on the distribution rule.

### Rule Value Can Capture Additional Information

A rule value can also be used to capture additional information provided at payment time, like address information, comments, etc. Obviously payment distribution details with this type of rule value should have a zero payment amount, as they are not real payments. These distribution details end up being linked to a payment event, but unlike other distribution details they do not contribute any payments. You can think of these details as payment event characteristics.

You don't have to set up a Create Payment algorithm for distribution rules intended solely to capture additional payment information.

## Setting Up The System To Use Distribution Rules

### Setting Up Distribution Rules

Define a Distribution Rule for each payment event distribution method practiced by your business.

## Distribution Rule - Main

To set up a distribution rule, navigate to **Admin > Financial > Distribution Rule > Add**.

### Description of Page

Enter a unique **Distribution Rule** and **Description** for the distribution rule.

Provide a short and unique **Distribution Rule Label** to be used as rule's name throughout the system.

**Characteristic Type** defines the type of entity whose balance is relieved by the payment(s) this rule creates. For example, if this rule targets payments(s) towards a specific service agreement, you'd reference a characteristic that its value identifies a service agreement. We use the term "rule value" for the characteristic value.

### Where Used

Follow this link to open the data dictionary where you can view the tables that reference [CI\\_DST\\_RULE](#)

## Distribution Rule - Algorithms

Navigate to **Admin > Financial > Distribution Rule > Search** and navigate to the **Algorithms** page to set up the algorithms appropriate for your distribution rule.

### Description of Page

The **Algorithms** grid contains algorithms that control important functions. You must define the following for each algorithm:

- Specify the algorithm's **System Event** (see the following table for a description of all possible events).
- Specify the **Algorithm** to be executed when the System Event executes. Set the **Sequence** to 10 unless you have a **System Event** that has multiple **Algorithms**. In this case, you need to tell the system the **Sequence** in which they should execute.

The following table describes each **System Event** (note, all system event's are optional and you can define an unlimited number of algorithms for each event).

System Event	Optional / Required	Description
Create Payment	Optional	This algorithm is executed to distribute a payment distribution detail payment amount into one or more payments.  Click <a href="#">here</a> to see the algorithm types available for this system event.
Determine Tender Account	Optional	This algorithm is executed to determine the tender account associated with the payment distribution detail.  Only one such algorithm may be specified.  Click <a href="#">here</a> to see the algorithm types available for this system event.

## Feature Configuration

You must set up a Financial Transaction Options [Feature Configuration](#) to define parameters that control various payment event distribution options.

The following points describe the various **Option Types** that must be defined:

- **Always Enable Distribution Rule.** This option controls whether the system should only use the distribution rule method to add payment events or rather allow both the default method and the distribution rule method to coexist.
  - Enter Y if the system should always use distribution rules. With this setting, navigation to the Payment Event page in add mode opens up the [Payment Event Quick Add](#) page (defaulting it to the single payment event dialog). This dialog is designed to create a payment event using distribution rules
  - Enter N if the system should allow both methods. With this setting, navigation to the Payment Event page in add mode opens up the standard [Payment Event - Add Dialog](#) that uses the default method to create a payment event. If you want to use the distribution rule method, navigate to the Payment Event Quick Add page from the menu.
- **Default Distribution Rule.** This option states your default distribution rule that appears throughout the system.

## Cancel Reasons

As described in [The Financial Big Picture](#), the various types of financial transactions can be canceled if their financial impact needs to be reversed from the system. Whenever a financial transaction is canceled, a cancel reason must be specified. This section describes the control tables that contain the cancel reason codes.

## Setting Up Bill (Segment) Cancellation Reasons

Open **Admin > Billing > Bill Cancel Reason** to define your bill segment cancellation reason codes.

### Description of Page

Enter an easily recognizable **Bill Cancel Reason** and **Description** for the bill cancellation reason.

Only use **System Default** on those reason codes that are placed on bill segments that are automatically canceled by the system. Valid values are: Turn off auto-cancel, Bad estimated read auto-cancel, MDM Corrected Read, and Mass Cancel. The reason code identified as Turn off auto-cancel is placed on bill segments that are automatically canceled when the final bill segment ends before the prior bill (and therefore we have to cancel the prior bill). The reason code identified as Bad estimated read auto-cancel is placed on bill segments that are automatically canceled by the system when it detects that it used an estimated read whose consumption is greater than the next actual read (and therefore we have to cancel the estimated bill segment). The reason code identified as Mass Cancel is placed on bill segments that are canceled as a result of the execution of the Mass Cancellation background process. The reason code identified as MDM Corrected Read is placed on bill segments that are automatically canceled by the system when processing a corrected read notification. Corrected read notifications are received from MDM when reads that were used in bill determinant calculation requests (usage requests) are replaced or modified. This notification may result in the rebill of frozen bill segments. Refer to [Usage Requests](#) for more information.

---

**NOTE:**

**Required values.** You must have one reason code defined for each of the System Default values.

---

## Setting Up Payment Cancellation Reasons

Open **Admin > Financial > Pay Cancel Reason** to define your payment cancellation reason codes.

### Description of Page

Enter an easily recognizable **Cancel Reason** and **Description** for the payment cancellation reason.

Turn on the **NSF Charge** switch if the system should invoke the non-sufficient funds (NSF) algorithm when a tender is cancelled using this reason code. Refer to [NSF Cancellations](#) for more information.

The next several fields are used to change an account's credit rating or cash-only points if a tender is canceled using the respective reason code.

- Use **Affect Cash-Only Score By** to define how tenders canceled using this reason will affect the account's cash-only score. This should be a positive number. When a customer's cash-only points exceed the cash-only threshold amount defined on the installation record or the account's CIS Division, the account is flagged as cash only during payment processing and on Control Central.
- Use **Affect Credit Rating By** to define how tenders canceled using this reason will affect the account's credit rating. This should be a negative number. A customer's credit rating is equal to the start credit rating amount defined on the installation record or the account's CIS Division plus the sum of credit rating demerits that are currently in effect.
- Use **Months Affecting Credit Rating** to define the length of time the demerit remains in effect. This information is used to define the effective period of the credit rating demerit record.

---

**FASTPATH:**

For more information, refer to [Account - Credit Rating](#).

---

**NOTE:**

**The payor gets the credit rating / cash only hit.** When you cancel a tender you must specify a cancellation reason. If the cancellation reason indicates a credit rating / cash only demerit should be generated, the system levies the credit rating transaction on the PAYOR's account.

---

The **System Default Flag** is specified on those cancellation reasons that are placed on payment segments that are automatically cancelled by the system. Valid values are: Re-opened Bill. The Re-opened Bill value is used as follows:

- Payments are automatically created for accounts who pay their bills automatically when their bills are completed.
- If such a bill is reopened before the automatic payment is interfaced to the paying authority, the system automatically cancels the payment. The Re-opened Bill cancellation reason is placed on such payments.

## Setting Up Adjustment Cancellation Reasons

Open **Admin > Financial > Adjustment Cancel Reason** to define your adjustment cancellation reason codes.

### Description of Page

Enter an easily recognizable **Cancel Reason** and **Description** for each adjustment cancellation reason.

## Miscellaneous Financial Controls

This section describes miscellaneous control tables.

### A/P Check Request

Adjustments whose adjustment type is marked with an A/P check request code are interfaced to your A/P system. Your A/P system then cuts the checks.

---

**FASTPATH:**

Refer to [Controls The Interface To A/P](#) for more information about the accounts payable interface.

---

You must set up at least one A/P check request code if you want A/P to cut checks.

To set up A/P check request types, open **Admin > Financial > A/P Request Type**.

**Description of Page**

Enter an easily recognizable **A/P Request Type** for the accounts payable request type.

Use **Due Days** to define when the check is cut. The cut date is equal to the adjustment date plus due days.

Select a **Payment Method**. Choose from these options:

System Check System check

**Where Used**

Follow this link to open the data dictionary where you can view the tables that reference [CI\\_APREQ\\_TYPE](#).

## Billable Charge Line Type

---

**NOTE:**

**Background information.** Before using this page, you should be comfortable with the topics described under [Setting Up Billable Charge Templates](#) and [Uploading Billable Charges](#).

---

Billable charge line types will simplify the effort required to interface billable charges from an external system. Each line type contains values that will be defaulted onto the line details associated with the uploaded billable charges. Obviously, this defaulting is possible only if you specify a billable charge line type on the billable charge upload staging lines.

To set up billable charge line types, select **Admin > Billing > Billable Charge Line Type > Add**.

**Description of Page**

Enter an easily recognizable **Billable Charge Line External Type** and **Description**.

Use **Currency Code** to define the currency to be defaulted onto billable charge upload lines that reference this line type.

Use **Show on Bill** to define the value to be defaulted into the Show on Bill indicator on billable charge upload lines that reference this line type.

Use **App in Summary** to define the value to be defaulted into the App in Summary indicator on billable charge upload lines that reference this line type.

Use **Memo Only, No GL** to define the value to be defaulted into the Memo Only, No GL indicator on billable charge upload lines that reference this line type.

Use **Distribution Code** to define the values to be defaulted into the Distribution Code field on billable charge upload lines that reference this line type.

**Where Used**

Follow this link to open the data dictionary where you can view the tables that reference [CI\\_BCHG\\_UP\\_XTYP](#).

## Payables Cash Accounting

In some areas, taxes and other 3rd party liabilities are not truly payable until the customer remits payment. We refer to this as "payables cash accounting". This practice should be contrasted with "payables accrual accounting" in which the liability is realized when the bill is created (as opposed to when it is paid).

If your organization does not practice payable cash accounting, you may skip this section as accrual accounting is the system default. If you practice payables cash accounting, the contents of this section describe how to configure the system appropriately.

## Accrual versus Cash Accounting Example

The following is an example of the financial events that transpire when a customer is billed and payment is received using accrual accounting.

Event	GL Accounting	Tax Payable Balance
Bill segment created	A/R 110	(10)
	Revenue <100>	
	Tax Payable <10>	
Payment received	Cash 110	(10)
	A/R <110>	

In the above example, you'll notice that the payable is booked when the bill is created. Let's contrast this with what takes place if the payable is subject to payables cash accounting.

Event	GL Accounting	Tax Payable Balance	Tax Holding Balance
Bill segment created	A/R 110	0	(10)
	Revenue <100>		
	Tax Holding <10>		
Payment received	Cash 110	(10)	0
	A/R <110>		
	Tax Holding 10		
	Tax Payable <10>		

Notice that when the bill segment is produced, the liability is not booked, rather, the amount of the liability is placed in a "holding" GL account. When the customer pays, the moneys are transferred from the "holding" GL account to the true tax payable account.

**NOTE:**

**Cash accounting is only applicable for liabilities.** In the above example, you'll notice that only the tax payable account had cash accounting implications. This is because organizations that practice cash accounting only do it for liability accounts; they never do it for assets, revenue or expenses.

If the above seems simple, consider the following complications that must be considered:

- What happens if a partial payment is received?
- What happens if there are multiple taxes subject to cash accounting rules?
- What happens if the A/R is relieved via a deposit seizure (or transference of a credit balance from another SA)?



- What if, after payment, the original bill segment is cancel/rebilled resulting in a different amount of tax (keep in mind that the payable got booked when the payment was received)?
- What happens if the payment is cancelled?
- What if the payment isn't received and we have to write-off debt?
- What happens if the customer overpays?
- What happens if the customer is allowed to prepay their tax (this is a common practice in the United Kingdom) and then the tax rate changes at billing time?

The above points, and more, are discussed below.

## Distribution Code Controls Cash Accounting For A GL Account

---

**NOTE:**

If you do not understand the significance of distribution codes, please refer to [Setting Up Distribution Codes](#).

---

Whether or not cash accounting is used for a specific GL account is defined on HOLDING GL account's distribution code (i.e., the holding GL account references the true payable account).

It is very important that unique payable and holding distribution codes be used for each type of tax subject to cash accounting rules. For example, if you have cash accounting requirements for both value-added tax (VAT) and a climate levy, you would need four distribution codes:

- VAT Payable.
- VAT Holding.
- Climate Levy Payable.
- Climate Levy Holding.

Without unique distribution codes for each payable and holding account, the system cannot keep track of how much of a given tax is being held, awaiting payment.

## Bill Segments and Cash Accounting

The contents of this section describe how cash accounting is implemented when bill segments are created.

## Bill Segment Financial Transactions Are Not Affected By Cash Accounting

There are NO changes to rate calculation associated with cash accounting. This is because the rate components that calculate tax reference the HOLDING payable distribution codes.

---

**NOTE:**

**Prepaid taxes - future functionality.** If your organization allows customers to prepay taxes in anticipation of a future tax increase (the customers receive the lower rate if they pay in advance), please speak to your account manager for information about when corresponding functionality will be available.

---

## Payment Segments and Cash Accounting

The contents of this section describe how cash accounting is implemented when payment segments are created.

### Payment Segment Financial Transaction Algorithms Transfer Holding Amounts to Payable GL Accounts

Logic exists in the pay segment's FT algorithm that transfers amounts from payable holding distribution codes to their respective payable real distribution codes.

---

**FASTPATH:**

Refer to [Setting Up Payment Segment Types](#) for how to define the appropriate FT algorithm.

---

The following table shows what happens to the financial transaction associated with the payment segment for a cash accounting customer.

Event	GL Accounting
Bill segment is created	A/R 110
	Revenue <100>
	Tax Holding <10>
Payment segment relieves receivables	Cash 110
	A/R <110>
Additional GL details created when the payment segment FT algorithm transfers the holding amount to a payable account	Tax Holding 10
	Tax Payable <10>
Net effect of the above	Cash 110
	A/R <110>
	Tax Holding 10
	Tax Payable <10>

---

---

### How Does The System Know What Amounts To Transfer From Holding To Payables?

When a payment segment is created for an account that is subject to cash accounting processing, the system determines if there is a CREDIT balance for any holding distribution code in respect of the service agreement. If so, it generates additional GL details to transfer moneys from the holding distribution code to the payable distribution code in proportion to the amount of receivables relieved by the payment. Therefore, if 100% of receivables are relieved by the payment segment, 100% of the holding amounts will be transferred to payable distribution codes. Refer to [Partial Payments Result In Partial Payables](#) for an example of what happens when a partial payment is created.

### Partial Payments Result In Partial Payables

The previous example showed the entire tax holding amount being transferred to the tax payable account. The entire holding amount was transferred because the service agreement was paid in full. If a partial payment is received, only part of the holding amount will be transferred to the payable amount (proportional to the amount of receivables reduced by the payment). An example will help make the point.

Event	GL Accounting	Tax Payable Balance	Tax Holding Balance
Bill segment created	A/R 110	0	(10)
	Revenue <100>		
	Tax Holding <10>		
Partial payment received	Cash 27.50	(2.50)	(7.50)
	A/R <27.50>		
	Tax Holding 2.50		
	Tax Payable <2.50>		

The above example assumes the use of the base product payment segment FT creation algorithm [PSEG-AC](#) to transfer the holding amount to the tax payable account. If multiple holding accounts are used, you may want to specify which holding amounts are relieved first. The base product includes an additional payment segment FT creation algorithm [C1-FTGL-PSAC](#) that handles booking holding amounts based on a priority.

## Partial Payments Using Accounting Priority

To book holding amounts based on a priority, each holding distribution code must be assigned an **Accounting Priority**. When a partial payment is posted, only part of the holding amount will be transferred to the payable amount (proportional to the amount of receivables reduced by the payment). When the holding amount consists of various holding distribution codes with different accounting priorities, the amount to transfer is allocated as follows:

- Holding distribution codes associated with the oldest debt are settled first
- Within the same debt age, holding distribution codes with a higher accounting priority are booked first. If more than one distribution code shares the same priority, the settlement is distributed among them in proportion to the holding account balance

The above logic is handled by the payment segment FT creation algorithm [C1-FTGL-PSAC](#). As an example of how these rules apply, let's assume an implementation practices cash accounting; i.e. revenue, taxes and other third party liabilities are not recognized until payment is received. Also assume the following distribution codes have been configured:

Holding Distribution Code	Description	Cash Accounting Distribution Code	Accounting Priority
HLD-LPC	Late Payment Charge	R-MISC	10
HLD-RGEN	Revenue - Generation Charge	R-GEN	20
HLD-RDIS	Revenue - Distribution Charge	R-DIST	30
HLD-RTRN	Revenue - Transmission Charge	R-TRAN	30
HLD-THRD	3 rd Party Charges	R-THRD	40
HLD-VAT	VAT	A/P-VAT	90

Assume a customer has an outstanding third party charge with an arrears date of 2/Jan/2009:

Event	GL Accounting	SA's Payoff Balance	Holding Balances					
			HLD-LPC	HLD-RGEN	HLD-RDIS	HLD-RTRN	HLD-THRD	HLD-VAT

Unpaid Amount	A/R 50 HLD-HRD <45> HLD-VAT <5>	50	0	0	0	0	(45)	(5)
---------------	---	----	---	---	---	---	------	-----

A bill is created for a customer and the result of the bill's financial transactions (an LPC adjustment in the amount of 10 and a bill segment in the amount of 127) include the following FT GL lines (both financial transactions have an arrears date of 15/Jan/2009):

Event	GL Accounting	SA's Payoff Balance	Holding Balances					
			HLD-LPC	HLD-RGEN	HLD-RDIS	HLD-RTRN	HLD-THRD	HLD-VAT
Bill segment created	A/R 127 HLD-RGEN <15> HLD-RDIS <20> HLD-RTRN <55> HLD-THRD <10> HLD-VAT <27>	177	0	(15)	(20)	(55)	(55)	(32)
Adjustment created	A/R 10 HLD-LPC <10>	187	(10)	(15)	(20)	(55)	(55)	(32)

No payment is received prior to the next bill. The result of the next bill's financial transaction (a bill segment in the amount of 100) includes the following FT GL lines (this financial transaction has an arrears date of 16/Feb/2009):

Event	GL Accounting	SA's Payoff Balance	Holding Balances					
			HLD-LPC	HLD-RGEN	HLD-RDIS	HLD-RTRN	HLD-THRD	HLD-VAT
Bill segment created	A/R 100 HLD-RGEN <15> HLD- RDIS <20> HLD- RTRN <45> HLD- THRD <10> HLD-VAT <10>	287	(10)	(30)	(40)	(100)	(65)	(42)

The following shows the result if a customer makes a payment on 20/Feb/2009. At payment time we'll build a table of holding amounts by accounting priority and debt age as follows:

Distribution Code & Priority	HLD-LPC	HLD-RGEN	HLD-RDIS	HLD- RTRN	HLD-THRD	HLD- VAT
	(10)	(20)	(30)	(30)	(40)	(90)
<b>Debt Age</b>						
4 days old		(15)	(20)	(45)	(10)	(10)
36 days old	(10)	(15)	(20)	(55)	(10)	(27)
49 days old					(45)	(5)

## Examples of Partial Payments Using Accounting Priority

The examples below assume a customer has the financial history described above and attempts to illustrate the financial effect when a payment is made.

- [Example 1 - Customer Pays In Full](#)
- [Example 2 - Customer Makes a Partial Payment](#)
- [Example 3 - Customer Makes a Partial Payment](#)

### Example 1 - Customer Pays In Full

Assume the customer makes a payment in the amount of 287. This amount is sufficient to satisfy all holding amounts, so the payment will have the following financial effect:

Event	GL Accounting	SA's Payoff Balance	Holding Balances					
			HLD-LPC	HLD-RGEN	HLD-RDIS	HLD-RTRN	HLD-THRD	HLD-VAT
Payment received	Cash 287	0	0	0	0	0	0	0
	A/R <287>							
	HLD-LPC 10							
	R-MISC <10>							
	HLD-RGEN 30							
	R-GEN <30>							
	HLD- RDIS 40							
	R-DIST <40>							
	HLD- RTRN 100							
	R-TRAN <100>							
	HLD- THRD 65							
	R-THRD <65>							
	HLD-VAT 42							

[Top of the Page](#)

**Example 2 - Customer Makes a Partial Payment**

Assume the same financial history described above for a customer and a partial payment in the amount of 70 is made. This amount is not sufficient to satisfy the total holding amounts of 287, so the system will start settling held amounts starting with distribution codes with the oldest debt first from highest priority until the payment amount is exhausted.

A payment in the amount of 70 will be applied in the following sequence

Distribution Code & Priority	HLD-LPC (10)	HLD-RGEN (20)	HLD-RDIS (30)	HLD-RTRN (30)	HLD-THRD (40)	HLD-VAT (N/A)
<b>Debt Age</b>						
4 days old		(15.00)	(20.00)	(45.00)	(10.00)	(10.00)
36 days old	④ (10.00)	④ (15.00)	(20.00)	(55.00)	(10.00)	(27.00)
49 days old					① (45.00)	② (5.00)

The following describes how the holding amounts will be booked as a result of this partial payment:

- Settle oldest debt first (49 days old), i.e. 3rd Party Charges (HLD-THRD) and VAT (HLD-VAT). Note that even though these holding accounts have the lower accounting priorities, they are booked first because they have the oldest debt. An amount of 20 now remains on the partial payment.
- Next, we'll settle the 36 days old debt from the highest priority:
  - Late Payment Charge (HLD-LPC) in the amount of 10. An amount of 10 now remains on the partial payment
  - Revenue - Generation Charge (HLD-RGEN) gets the remaining payment amount of 10
- So, this partial payment in the amount of 70 will result in the following financial effect:

Event	GL Accounting	SA Balance	Holding Balances					
			HLD-LPC	HLD-RGEN	HLD-RDIS	HLD-RTRN	HLD-THRD	HLD-VAT
Payment received	Cash 70	217	0	(20)	(40)	(100)	(20)	(37)
	A/R <70>							
	HLD-LPC 10							
	R-MISC <10>							
	HLD-RGEN 10							
	R-GEN <10>							
	HLD- THRD 45							
	R-THRD <45>							
	HLD-VAT 5							
	A/P-VAT <5>							

[Top of the Page](#)

### Example 3 - Customer Makes a Partial Payment

Assume the same financial history described above for a customer and a partial payment in the amount of 220 is made. This amount is not sufficient to satisfy the total holding amounts of 287, so the system will start settling held amounts starting with distribution codes with the oldest debt first from highest priority until the payment amount is exhausted.

A payment in the amount of 220 will be applied in the following sequence

Distribution Code & Priority	HLD-LPC (10)	HLD-RGEN (20)	HLD-RDIS (30)	HLD-RTRN (30)	HLD-THRD (40)	HLD-VAT (NA)
<b>Debt Age</b>						
4 days old		9 (15.00)	10 (20.00)	10 (45.00)	(10.00)	(10.00)
36 days old	3 (10.00)	4 (15.00)	5 (20.00)	5 (55.00)	7 (10.00)	8 (27.00)
49 days old					1 (45.00)	2 (5.00)

The following describes how the holding amounts will be booked as a result of this partial payment:

- Settle oldest debt first (49 days old), i.e. 3rd Party Charges (HLD-THRD) and VAT (HLD-VAT). Note that even though these holding accounts have the lower accounting priorities they are booked first because they have the oldest debt. An amount of 170 now remains on the partial payment.
- Next, we'll settle the 36 days old debt from the highest priority, i.e. Late Payment Charge (HLD-LPC), Revenue - Generation Charge (HLD-RGEN), Revenue - Distribution Charge (HLD-RDIS), Revenue - Transmission Charge (HLD-RTRN), 3rd Party Charges (HLD-THRD) and VAT (HLD-VAT). An amount of 33 now remains on the partial payment.
- Next we'll settle the 4 day old debt from the highest priority:
  - Revenue - Generation Charge (HLD-RGEN) in the amount of 15. An amount of 18 now remains on the partial payment
  - The two holding accounts at the next priority have an outstanding amount of 65. Since the remainder of the payment is not enough to satisfy this amount, the remainder of the payment is prorated amongst HLD-RDIS and HLD-RTRN as follows:
    - $(\text{Remaining Pay Amount} / \text{Total Outstanding Holding Amount}) * \text{Holding Account Amount}$
    - So for the Revenue - Distribution Charge (HLD-RDIS) holding account the amount booked will be  $(18/65 * 20) = 5.54$
- So, this partial payment in the amount of 220 will result in the following financial effect:

Event	GL Accounting	SA Balance	Holding Balances					
			HLD-LPC	HLD-RGEN	HLD-RDIS	HLD-RTRN	HLD-THRD	HLD-VAT
Payment received	Cash 220	67	0	0	(14.46)	(32.54)	(10)	(10)
	A/R <220>							
	HLD-LPC 10							
	R-MISC <10>							
	HLD-RGEN 30							

R-GEN  
<30>  
HLD-  
RDIS  
25.54  
R-DIST  
<25.54>  
HLD-  
RTRN  
67.46  
R-TRAN  
<67.46>  
HLD-  
THRD  
55  
R-THRD  
<55>  
HLD-  
VAT32  
A/P-VAT  
<32>

---

---

## Adjustments That Behave Like Payments

There are several types of adjustments that behave just like payments (in respect of payables cash accounting). Consider the following events:

- Seizing a deposit (i.e., transferring a credit from a deposit service agreement to a regular service agreement)
- Overpayments transferred from one service agreement to another

The above events should cause the system to transfer holding amounts to true payable amounts (notice that the above examples are all transfer adjustments).

However, there are many other adjustments that should NOT behave like payments. You control how the adjustment works by selecting the appropriate FT algorithm when you [set up adjustment types](#) (refer to [ADJT-AC](#) and [ADJT-TC](#) for a description of the base package algorithms that cause the holding amounts to be manipulated in proportion to the amount of receivable being adjusted; and to [C1-FTGL-ADAC](#) and [C1-FTGL-ADTC](#) for the base package algorithms that take **Accounting Priority** into consideration). In other words, there are adjustment FT algorithms that cause the transference of holding payable amounts to real payable amounts when the A/R balance is decreased by the adjustment.

---

**NOTE:**

**Cash refunds can behave like "anti-payments"**. In addition to the above examples of transfer adjustments behaving like payments, you should be aware that cash refunds may impact your holding and true payable balances. Refer to [Cash Refunds](#) for more information.

---

## Overpayment Of Taxes Due To Cancel/Rebills



Let's assume a cancel / rebill occurs after a payment is received and the net effect of the cancel / rebill is that the customer has overpaid their taxes.

Event	GL Accounting	Tax Payable Balance	Tax Holding Balance
Bill segment created	A/R 110	0	(10)
	Revenue <100>		
	Tax Holding <10>		
Payment received	Cash 110	(10)	0
	A/R <110>		
	Tax Holding 10		
	Tax Payable <10>		
Cancel	A/R <110>	(10)	10
	Revenue 100		
	Tax Holding 10		
Rebill	A/R 27.50	(10)	7.50
	Revenue <25>		
	Tax Holding <2.50>		

You'll notice that the amount payable to the taxing authority still indicates \$10 (the amount of tax that was paid by the customer). However, you'll notice that the tax holding balance is 7.50 (debit). This looks a bit odd, but it's correct. Remember that at this point, the customer has a credit balance of \$75 and this will be whittled down as successive bills are produced as shown below. Note: refer to [Cash Refunds](#) for an example of what happens if you refund the credit with a check rather than letting it whittle down.

Event	GL Accounting	Tax Payable Balance	Tax Holding Balance
		(10)	7.50
Bill segment created	A/R 55	(10)	2.50
	Revenue <50>		
	Tax Holding <5>		
Bill segment created	A/R 110	(10)	(7.50)
	Revenue <100>		
	Tax Holding <10>		

In the unlikely event of a payment being received while the tax holding has a debit balance, nothing will be done in respect of transferring funds from holding to payable (there is nothing to transfer).

## Cash Refunds

If you refund moneys to a cash accounting customer, it's important to do the opposite of what was done when the payment was received (i.e., you need to transfer the payable back to the holding account). The following example should help clarify this situation (this example shows a refund due to a credit balance that occurred as a result of a cancel/rebill).

Event	GL Accounting	Tax Payable Balance	Tax Holding Balance	SA's Payoff Balance
Bill segment created	A/R 110	0	(10)	110

	Revenue <100>			
	Tax Holding <10>			
Payment received	Cash 110	(10)	0	0
	A/R <110>			
	Tax Holding 10			
	Tax Payable <10>			
Cancel	A/R <110>	(10)	10	(110)
	Revenue 100			
	Tax Holding 10			
Rebill	A/R 27.50	(10)	7.50	(82.50)
	Revenue <25>			
	Tax Holding <2.50>			
Payment refunded (via an A/P adjustment)	Cash <82.50>	(2.50)	0	0
	A/R 82.50			
	Tax Holding <7.50>			
	Tax Payable 7.50			

We understand this is tricky, but consider this - when a cash accounting customer makes a payment, the system transfers tax holding CREDIT balances to tax payable distribution codes in proportion to the amount of the receivable DEBIT amount that was reduced by the payment. Therefore, when cash is returned to the customer, the system should transfer tax holding DEBIT balances to tax payable distribution codes in proportion to the amount of the receivable CREDIT that was reduced by the refund.

**NOTE:**

The above takes place when an A/P adjustment is created if the related adjustment type references the appropriate FT algorithm (refer to [ADJT-AC](#) and [C1-FTGL-ADAC](#) for a description of the adjustment FT algorithms used for adjustments that behave like payments).

## Overpayments

An overpayment, by definition, does not "match" to open items. However, the match type algorithms supplied with the base package will result in a balanced match event if an overpayment is made. The following points explain how this is achieved:

- The base package's match type algorithms will distribute the payment until the customer's current debt is satisfied.
- The amount of the overpayment will be kept on a separate SA (this only happens if you plug-in the appropriate Overpayment Distribution algorithm on your customer classes). Refer to [Overpayment Segmentation](#) for more information.
- When the payment is frozen, the payment segments that satisfy current debt will be matched against their respective open-items. The payment segment used to book the overpayment (on the overpayment SA) will not be matched.
- When future bills are completed, the credit balance on this "overpayment SA" will be transferred to the "real SAs" when future bills are completed (if you have plugged in the appropriate bill completion algorithm on the overpayment SA's SA type). If the overpayment satisfies all newly calculated charges, a match event is created that matches the new charges against the funds transferred from the overpayment SA. Refer to [When Are Match Events Created](#) for information about how the system creates match events at bill completion time when the new charges on the bill are satisfied by other credits (overpayments, deposit refunds, etc.).

- At some point in the future, the overpayment will be exhausted (i.e., all funds will be transferred to "real SAs"). At that point in time, the overpayment SA will close (assuming you set up the overpayment SA's SA type as a "one time"). At close time, the system creates a match event that matches the original overpayment payment segment with the adjustments that were used to transfer funds to the "real SAs". Refer to [When Are Match Events Created](#) for information about how the system creates match events when a SA closes.

## Write Down Adjustment

Writing down debt is very different from [writing off debt](#). When you write down debt, you are removing the receivable with no expectation of it being paid. For example, most organizations write down small debit and credit balances as part of their write-off process (e.g., they don't send a very small amount to a collection agency).

Let's run through an example to illustrate this:

Event	GL Accounting	Tax Payable Balance	Tax Holding Balance	SA's Payoff Balance
Bill segment created	A/R 110	0	(10)	110
	Revenue <100>			
	Tax Holding <10>			
Payment received	Cash 109.50	(9.95)	.05	0.50
	A/R <109.50>			
	Tax Holding 9.95			
	Tax Payable <9.95>			
Write down cash accounting debt	Tax Holding 0.05	(9.95)	0	0
	Write Down Expense 0.45			
	A/R <0.50>			

In order to achieve the above, you must set up an adjustment type that references a special financial transaction algorithm (refer to non-accrual accounting write down algorithms [ADJT-AD](#) and [C1-FTGL-AD](#) for more information). This algorithm will reduce / increase the receivable balance accordingly AND cause any holding amounts to be set to zero. This adjustment type should be referenced on your write-down algorithm that is referenced on your write-off controls.

## Write-Offs

At write-off time we may refund credit balances. The refunding of credit balances is handled by A/P adjustments and these have cash accounting processing as described under [Cash Refunds](#).

If we have to write-off debt, holding balances are relieved in proportion to the amount of debt that is written off (as usual). It's important to understand that for this to work, you must set up the system as follows:

- The tax holding distribution codes must have their override distribution switch turned on.
- The distribution code on the SA type associated with the service agreement to which the written-off payables are transferred must be the REAL payable distribution codes. This is important so that if the customer pays after the payables are reversed, we will be able to debit cash and credit the REAL payable distribution code.

Let's run through an example to illustrate this.

Event	Normal SA GL Accounting	Write Off Revenue SA GL Accounting	Reverse Liabilities SA GL Accounting

Bill segment created	A/R 110		
	Revenue <100>		
	Tax Holding <10>		
<hr/>			
Write Off Time			
Reverse the held payables	Xfer 10		Tax Holding 10
	A/R <10>		Xfer <10>
			Note, the tax holding only gets debited if you have turned on the override at write-off switch on its distribution code
<hr/>			
Write off revenue	Xfer 100	Write Off Expense 100	
	A/R <100>	Xfer <100>	
<hr/>			
If the customer subsequently pays		Cash 100	Cash 10
		Write Off Exp <100>	Tax Payable <10>
			Note, the tax payable only gets credited if the SA type's distribution code has been defined as such

## Deferred Accrual Accounting

Some implementations use a hybrid accounting method that combines cash and accrual accounting. In this case revenue, taxes, etc. are recognized on the earlier of the bill due date or the date payment is received. In this scenario, the cash accounting method is used up until the bill's due date, at which time the accrual method is enforced (let's call this "deferred accrual accounting"). A simpler flavor of deferred accrual accounting is when the revenue and liability recognition is done solely at bill due date regardless of when the payment is made.

Deferred accrual accounting affects distribution codes identified as **Use For Non-Accrual Accounting** with an associated **Accounting Method** of either Payable on Earlier of Payment or Due Date or Payable on Due Date. The system accomplishes the holding amount settlement on the bill due date using a customer class post bill completion algorithm **C1-CR-BLRVWS** that creates a bill review record to be processed on the bill's due date. The bill review batch process then analyzes these bill review records on the bill due date. If a bill review record is due for processing, the algorithm checks the outstanding balance of the holding accounts on each SA linked to the bill and creates a settlement adjustment for each SA.

## Deferred Accrual Accounting Examples

The examples below illustrate the financial transactions that transpire under these different scenarios.

### Example 1 - Payable On Due Date, Customer Pays In Full

The following is an example of the financial events that transpire when a customer is billed and full payment is received prior to the bill due date. The accounting method in this case is Payable On Due Date.

Event	GL Accounting	Tax Payable Balance	Tax Holding Balance
-------	---------------	---------------------	---------------------

Bill segment created	A/R 110	0	(10)
	Revenue <100>		
	Tax Holding <10>		
Payment received	Cash 110	0	(10)
	A/R <110>		
Adjustment created on bill due date	Tax Holding 10	(10)	0
	Tax Payable <10>		

## Example 2 - Payable On Due Date, Customer Does Not Pay

In the following example a customer is billed and no payment is received prior to the bill due date. The bill review batch process is responsible for creating the settlement adjustment for any outstanding holding amounts on the bill's due date. The accounting method in this case is Payable On Due Date.

Event	GL Accounting	Tax Payable Balance	Tax Holding Balance
Bill segment created	A/R 110	0	(10)
	Revenue <100>		
	Tax Holding <10>		
Adjustment created on bill due date	Tax Holding 10	(10)	0
	Tax Payable <10>		

## Example 3 - Payable On Due Date, Customer Makes A Partial Payment

In the following example a customer is billed and a partial payment is received prior to the bill due date. The bill review batch process is responsible for creating the settlement adjustment for any outstanding holding amounts on the bill's due date. The accounting method in this case is Payable On Due Date.

Event	GL Accounting	Tax Payable Balance	Tax Holding Balance
Bill segment created	A/R 110	0	(10)
	Revenue <100>		
	Tax Holding <10>		
Payment received	Cash 27.50	0	(10)
	A/R <27.50>		
Adjustment created on bill due date	Tax Holding 10	(10)	0
	Tax Payable <10>		

## Example 4 - Payable On Earlier Of Payment Or Due Date, Customer Pays In Full

In the following example a customer is billed and full payment is received prior to the bill due date. The accounting method in this case is Payable On Earlier Of Payment Or Due Date.

Event	GL Accounting	Tax Payable Balance	Tax Holding Balance
Bill segment created	A/R 110	0	(10)
	Revenue <100>		
	Tax Holding <10>		
Payment received	Cash 110	(10)	0
	A/R <110>		
	Tax Holding 10		
	Tax Payable <10>		

### Example 5 - Payable On Earlier Of Payment Or Due Date, Customer Does Not Pay

In the following example a customer is billed and no payment is received prior to the bill due date. The bill review batch process is responsible for creating the settlement adjustment for any outstanding holding amounts on the bill's due date. The accounting method in this case is Payable On Earlier Of Payment Or Due Date. Note that if a payment is subsequently received after the settlement adjustment has been created, it's financial transaction(s) will not have any impact on the holding or liability accounts as these have already been booked.

Event	GL Accounting	Tax Payable Balance	Tax Holding Balance
Bill segment created	A/R 110	0	(10)
	Revenue <100>		
	Tax Holding <10>		
Adjustment created on bill due date	Tax Holding 10	(10)	0
	Tax Payable <10>		

### Example 6 - Payable On Earlier Of Payment Or Due Date, Customer Partially Pays

In the following example a customer is billed and a partial payment is received prior to the bill due date. The bill review batch process is responsible for creating the settlement adjustment for any outstanding holding amounts on the bill's due date. The accounting method in this case is Payable On Earlier Of Payment Or Due Date. Note that if a payment is subsequently received after the settlement adjustment has been created, it's financial transaction(s) will not have any impact on the holding or liability accounts as these have already been booked.

Event	GL Accounting	Tax Payable Balance	Tax Holding Balance
Bill segment created	A/R 110	0	(10)
	Revenue <100>		
	Tax Holding <10>		
Payment received	Cash 27.50	(2.50)	(7.50)
	A/R <27.50>		

	Tax Holding 2.50		
	Tax Payable <2.50>		
Adjustment created on bill due date	Tax Holding 7.50	(10)	0
	Tax Payable <7.50>		

## Payment Cancellations and Deferred Accrual Accounting

If a payment was responsible for transferring moneys from the holding distribution code to the payable distribution code, it stands to reason that if the payment is cancelled, it results in the reversal of this transfer from the holding distribution code to payable distribution code. If deferred accrual accounting is used and the payment is cancelled after the bill due date, the holding amounts that were transferred should remain booked.

Assume, for example, that the payment below was cancelled after the bill due date:

Event	GL Accounting
Payment received	Cash 110
	A/R <110>
	Tax Holding 10
	Tax Payable <10>

At cancellation, the above entry will be reversed, reinstating the balance in the holding account:

Event	GL Accounting
Payment cancelled after bill due date	Cash <110>
	A/R 110
	Tax Holding <10>
	Tax Payable 10

However, since the bill's due date has passed, the holding account needs to be booked. For open item accounts, the system comes with a customer class FT freeze algorithm ( [C1-PR-CA-RVS](#)) that creates a bill review schedule for the affected bill, if one does not already exist. When the bill review batch process next runs, it checks the outstanding balance of the holding accounts on each SA linked to the bill and creates a settlement adjustment for each SA.

Event	GL Accounting
Adjustment created	Tax Holding 10
	Tax Payable <10>

Note that this solution is only applicable to open item accounting where the bill matched to the payment can be determined. If balance forward accounting is practiced, the bill or bills that the payment applied to cannot be determined. In this case, the next bill review record created for the account as part of billing will cause the balances of the holding accounts to be analyzed and the settlement will catch up at that point.

## Open Item Accounting

The topics in this section provide background information about open-item accounting.

**NOTE:**

**This section is only relevant for some organizations.** The system configuration requirements described in this section are only relevant if your organization practices open-item accounting. If your organization practices balance-forward accounting, you need only indicate such on your [customer classes](#); no other setup is required. Refer to [Open Item Versus Balance Forward Accounting](#) for more information about these two accounting practices.

## Open-Item Versus Balance-Forward Accounting

If you practice open-item accounting, you match payments against bills. The term "open-item accounting" is used to describe this accounting practice because:

- Payments are matched against "open items" (i.e., unpaid bills and adjustments)
- Only unmatched bills and adjustments (i.e., open items) affect aged debt.

Contrast open-item accounting with "balance-forward" accounting - in a balance-forward world, payments are not matched to bills. Rather, payments implicitly relieve a customer's oldest debt. For example, consider the following unpaid financial transactions that exist for an account and the resultant aged debt.

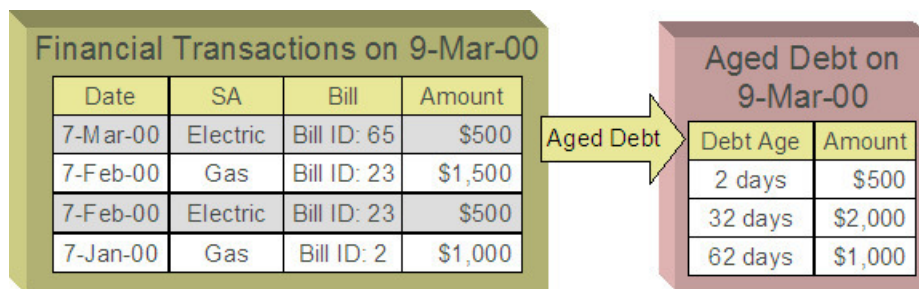

In a balance-forward world, if a \$1,000 payment was made on 9-Mar-00, the customer's aged debt would look as follows:

Aged Debt on 9-Mar-00	
Debt Age	Amount
2 days	\$500
32 days	\$2,000

Notice how the \$1,000 payment relieves the 62 day old debt - it does this because, in a balance-forward world, payments payoff oldest debt first.

However, let's assume the customer wants the payment to settle his electric debt (e.g., because he disagrees with the gas bills). If you could match the \$1,000 payment to the two electric bills (i.e., open-item accounting exists), the customer's aged debt would look as follows:

Aged Debt on 9-Mar-00	
Debt Age	Amount
32 days	\$1,500
62 days	\$1,000

In sum,



- In an open-item world, payments are matched to bills and only unpaid bills and adjustments (i.e., open items) affect aged debt.
- In a balance-forward world, payments are not matched to bills and therefore a customer's aged debt is computed by aging debits (bills and adjustments) and then relieving the oldest debits using credits (payments and adjustments).

**NOTE:**

**Financial Transactions and Bills.** In an open-item world, only bill segments and adjustments are presented on a bill. When a bill is completed, only those bill segments and adjustments to be presented are swept onto a bill. Payment and payment cancellation FTs, bill segment FTs canceled before bill completion together with their corresponding bill segment cancellation FTs, and adjustment FTs marked as do not show on bill are not swept onto a bill. An adjustment's adjustment type and its algorithms determine if its FT will show on a bill by default.

## Accounting Method Defined On Your Customer Classes

You define the type of accounting method that is practiced ( [balance-forward versus open-item](#) ) on your [customer classes](#). For example, residential customers can practice balance-forward accounting whereas industrial / commercial customers can practice open-item accounting.

## Match Events

Match events are used to match open-items (i.e., debit and credit financial transactions) together. The topics in this section provide an overview of match events.

### Match Events Match Debit FTs To Credit FTs

For open-item customers, the system matches credit financial transactions (FT's) to debit FT's under a [match event](#). The following is an example of a match event associated with two \$500 payments that satisfy the debt associated with one bill (on February 2000).

### Match Event

Account: 10291011

Status: Balanced

Credit FT's: \$1,000

Date	SA	FT Info	Amount
7-Mar-00	Electric	None	\$500
1-Mar-00	Electric	None	\$500

Debit FT's: \$1,000

Date	SA	FT Info	Amount
15-Feb-00	Electric	Bill ID: 22	\$1,000

Notice the following:

- The match event matches 2 credit FT's against a single debit FT. A match event may contain an unlimited number of FT's.
- The match event contains FT's associated with a single account. While the FT's under a match event may belong to multiple service agreements, all FT's under a match event must belong to the same account.
- The match event only contains bill segments that belong to a single bill. If you mix multiple bills under a single match event, then an individual bill balance cannot be properly determined when partial payments exist.
- The status of the match event is balanced. This is because the sum of the debits equals the sum of the credits. If debits do not equal credits, the status of the match event would be open and the various FT's would still affect the customer's aged debt. Refer to [Match Event Lifecycle](#) for more information.

---

**WARNING:**

It is strongly encouraged that you refrain from mixing multiple bills on a single match event. If you stick by the rule of "just one bill per match event" you will then be able to determine the outstanding balance of a partially paid bill (see the [bill page](#), bill summary section). However, if you mix more than one bill under a match event, a particular bill's balance may become indeterminate. Algorithm types have been provided which help to enforce this rule of "one bill per match event", please refer to [Match By Bill, Pay Oldest Bill First](#) for an example of a matching algorithm that enforces this notion.

---

## When Are Match Events Created?

The following points describe when match events are created for open-item accounts:

---

**NOTE:**

Match events are only created for open-item accounts (i.e., those accounts with a customer class that indicates open-item accounting is practiced). Match events may not be created for balance-forward accounts.

---

- The system can create one or many match events when a payment is added. This match event matches the payment's credit FT's with the debit and credit FT's from bill segments and adjustments. The FT's that are linked to the match event are controlled by the payment's **match type** and **match value** (payments made by open-item customers must reference a match type and match value). Refer to [Payments And Match Events](#) for more information.
- The system may create a match event when any type of financial transaction is cancelled. This match event groups together the original FT with its cancellation FT. Refer to [How Are Match Events Cancelled?](#) for more information.
- The system creates a match event when a bill is completed for customers that pay automatically (i.e., direct debit customers). The match event groups together the bill's new charges against the automatic payment's payment segments.
- The system creates a match event when a bill is completed where the new charges are offset by other financial transactions. For example,
  - Consider a bill that contains a deposit refund. If the sum of the deposit refund equals or exceeds the amount of the bill, the bill's FT's can be matched against the debit refunds FT's. Refer to [Refunding Deposits](#) for more information about deposit refunds.
  - Consider a bill whose new charges are offset by a previous overpayment. Refer to [Over Payments](#) for more information about overpayments.

---

**FASTPATH:**

Refer to [Bill Lifecycle](#) for more information about what happens during bill completion.

---

- The system creates a match event when a service agreement closes and the service agreement has unmatched FT's. For example,
  - Consider a deposit service agreement that closes when the deposit is refunded to the customer. The system will create a match event with the deposit SA's FT's (the original credit and the debits used to refund the deposit) when the deposit SA closes (i.e., when its credit balance falls to zero). Refer to [Refunding Deposits](#) for more information about deposit refunds.
  - Consider a service agreement for utility debt that is written off. This service agreement closes when the system creates transfer adjustments to transfer the utility debt to a write-off service agreement (or writes down the debt). The system creates a match event to match the original debt to the transfer adjustments used to write-off the debt. Refer to [How Is Debt Financially Written Off](#) for more information about write-off processing.
- A user can create a match event manually at any time. Manual match events would be created under a variety of situations. For example:
  - If a customer disputes a charge. Refer to [Disputing Items](#) for more information about disputes.
  - To handle unusual situations when the system is unable to automatically match FT's together.

## Match Event Lifecycle

The following diagram shows the possible lifecycle of a match event:

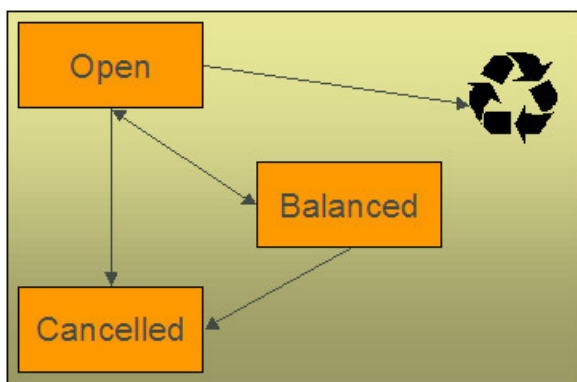

Match events are initially created in the open state. Financial transactions (FT's) linked to open match events affect arrears, but not in an open-item fashion. Rather, FT's linked to open match events affect arrears in a balance-forward fashion. Refer to [Open Item Versus Balance Forward Accounting](#) for more information about these two accounting methods.

A user may delete an open match event. When an open match event is deleted, its FT's may be linked to other match events.

The system automatically changes an open event's status to balanced when the sum of the debit financial transactions (FT's) equals the sum of the credit FT's for each SA on the match event. It's worth stressing that a match event may contain FT's from many SAs and each SA's FT's must sum to zero before the match event can become balanced.

A user may re open a balanced event (by adding / removing FT's so that the match event becomes unbalanced).

A user may cancel a balanced or open match event. Refer to [How Are Match Events Cancelled?](#) for more information about cancellation.

## Payments And Match Events

As described under [When Are Match Events Created?](#), the system creates a match event when a payment is added for an open-item account. The system uses the payment's **match type** and **match value** to determine the FT's (e.g., bill segments and adjustments) that will be matched with the payment's FT's (i.e., the payment segments).

Another way to think of this is as follows:

- When most payments are distributed, the system calls the payment distribution algorithm that is plugged-in on the account's customer class.
- However, a payment that is made in respect of a specific bill requires a different distribution algorithm because the payment should only be distributed amongst the debt associated with the specific bill being paid. This is accomplished by referencing a match type / match value on the payment. The match type references the appropriate payment distribution algorithm. This algorithm is used rather than the customer class distribution algorithm.

For example, if a payment were made in respect of bill ID 192910192101, this payment would reference a match type of bill ID and a match value of 192910192101. At payment distribution time, the system calls the override payment distribution algorithm associated with this match type. The base package bill ID distribution algorithm does several things:

- It distributes the payment amongst service agreements associated with the bill.
- It creates a match event and links the bill's bill segment and adjustment FT's to it.
- Refer to the [Bill ID Match Type Algorithm](#) for more information about this algorithm.

---

**NOTE:**

**The match type's distribution logic is not "hard coded".** Because the match type's payment distribution logic is embedded in a plug-in algorithm, you can introduce new algorithms as per your company's requirements.

---

It's worth noting that payment *distribution* and *freezing* are two separate steps that typically happen in quick succession. The system's standard match event algorithms create the match event during payment distribution. This match event exists in the open state (because the payment segment's FT's have not yet been linked to the match event and therefore debit FT's do not equal credit FT's). The open match event references the debit FT's (the bill segments and adjustments) for which it pays. It is only at payment freeze time that the credit FT's (the payment segments) are linked to the match event thus allowing the match event to become balanced.

If, at freeze time, the payment's credit FT's do not equal the debit FT's on the match event, the match event is left in the open state. An alert will appear on Control Central to highlight the existence of open match events (if the appropriate alert algorithm is plugged in the installation record). In addition, you can also set up a To Do entry to highlight the existence of open match events.

## Payments Are Matched To Debit Credit FTs

While the above discussion dealt with the typical situation where the payment's credit FT's are matched against a bill's debit FT's, we want to note that a payment's FT's may be matched against debit and credit FT's. Consider the following example:

### Match Event

Account: 10291011

Status: Balanced

Bill 1929: \$2,900

Date	SA	FT Info	Cur Amount
7-Mar-00	Electric	Bill seg	\$1,500
6-Mar-00	Gas	Bill seg	\$1,500
1-Mar-00	Gas	Adj-Credit	\$-100

Pay: \$2,900

Match Type: Bill ID 1929

Date	SA	FT Info	Cur Amount
15-Mar-00	Electric	Pay seg	\$-1,500
15-Mar-00	Gas	Pay seg	\$-1,400

Notice that:

- The \$2,900 payment is distributed amongst two service agreements (electricity and gas).
- The FT's to which the payment segments are matched are both debit and credit FT's. Notice that the debit FT's (the bill segments) and the credit FT (the adjustment) sum to \$2,900.

Credits may result in a situation where the total amount on a bill for an SA is negative. This would be the case if in the above example the credit adjustment were for \$-1600 resulting in the total amount for the Gas SA on this bill to be \$-100 (credit). Assume a full payment of \$1400 is made towards this bill. The [Bill ID Match Type Algorithm](#) first allocates negative payment amounts to any SA credit amount on the bill being paid. It then carries over the credit amount to pay off other bill amounts. In this example, a "negative" payment segment is created to match the \$-100 credit of the Gas SA. Using the carried over credit a \$1500 payment segment is created to match the \$1500 debit of the Electric SA.

## How Are Match Events Cancelled?

A user can cancel an open or balanced match event at any time. When a match event is cancelled, the event's FT's again effect arrears (and they can be associated with new match events). In other words, when a match event is cancelled, its FT's are released from the match event and become open-items.

In addition to manual cancellation, the system may automatically cancel a match event when the last of its payment FT's, if any, is cancelled (if you plug-in the appropriate FT freeze plug-in on your open-item customer classes).

For example, consider a match event that was created when a payment was made. If the payment is subsequently cancelled, the match event is also cancelled (thus releasing the match event's FT's) if no other payment FT's are linked to the match event. Please be aware that FT cancellation also causes a new match event to be created. This match event matches the original FT (the payment segment) and its cancellation FT. This means that the only "open items" that will exist after a payment is cancelled are the debit FT's that were originally paid.

### NOTE:

**Reopening bills associated with automatic payment customers.** While many payments are cancelled due to non-sufficient funds, please be aware that if you reopen a bill for which an automatic payment was created, the system will cancel the associated payment. If this payment is associated with a match event (because the account is an open-item account), the match event will be cancelled and a new match event will be created to match the original

automatic payment with its cancellation details. This is necessary because a new payment will be created with the bill is subsequently completed and this payment's FT's will be matched to the bill's FT's.

**Canceling a payment can result in many match events being created.** If a cancelled payment has multiple payment segments, a separate match event will be created for each payment segment.

While payment cancellation is the most common type of FT cancellation, be aware that bill segment or adjustment cancellation may also cause a new match event to be created. We don't necessarily want to always link the cancellation FT and its original FT to the same match event. For example, when the cancellation FT is swept on to the next bill it affects the next bill and not the original FT's bill. For cancellations that will not be swept on to the next bill (payment cancellation, cancellation of an adjustment that is not shown on bill, credit notes, and bill segment cancellation before the bill is completed) the system creates a new match event that matches the original FT and its cancellation FT. This way, neither FT affects aged debt. If the original FT was linked to an existing match event and no other FTs are left on this match event it is automatically canceled.

## Current Amount Is Matched, Not Payoff

The system matches the current amount of financial transactions, not the payoff amount.

### FASTPATH:

Please refer to [Current Amount versus Payoff Amount](#) for more information about current and payoff amounts.

## Disputing Items

Open-item customers may dispute FT's that they are not comfortable paying. For example, a customer who receives a bill with an anomalous charge may decide to dispute it.

When an open-item customer disputes a charge, a user creates a match event and links the disputed FT(s) to it. This match event will be in the open state (because it does not contain FT's that sum to zero). In addition, the match event's "disputed switch" is turned on.

### NOTE:

**Alerts.** An alert is displayed on control central to highlight the existence of disputed match events (if the appropriate alert algorithm is plugged in). In addition, you can also set up a To Do entry to highlight the existence of disputed match events.

While the dispute is being researched, the disputed amount will not affect aged debt, but it still forms part of the customer's balance. For example, consider the following unpaid financial transactions that exist for an account:

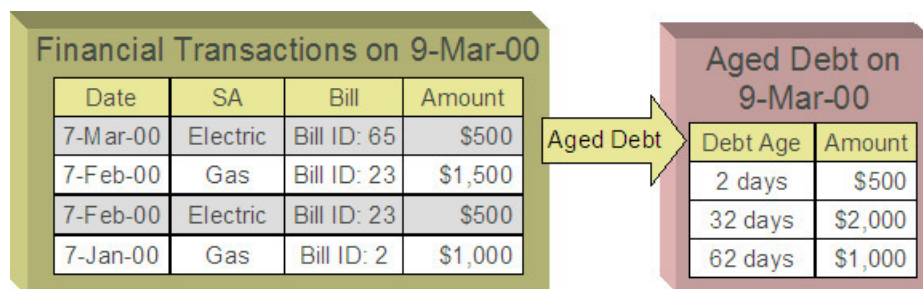

If the customer disputes the two electric bill segments, the customer's aged debt will look as follows:

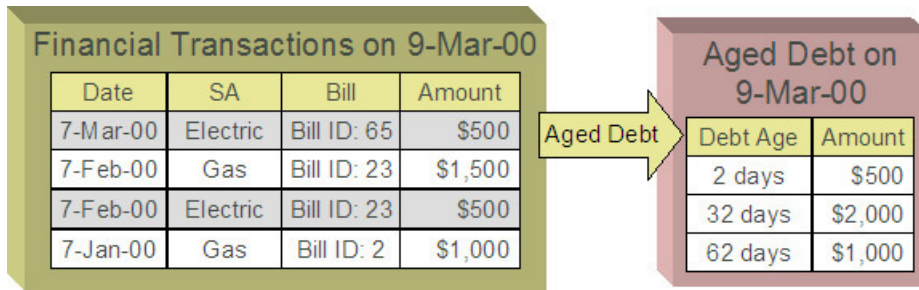

Notice how a new category of debt appears - Disputed. Also notice how the 2 day old debt disappears and the 32 day old debt is reduced by the disputed amount.

The system shows disputed debt on Control Central. In addition, in all places where aged debt appears in the system, disputed debt is shown as a separate debt category.

If the dispute goes in your company's favor, the disputed match event should be cancelled (thus allowing the FT's to again impact aged debt). For example, if we assume 3 days have passed and the dispute match event is cancelled, the customer's aged debt will look as follows:

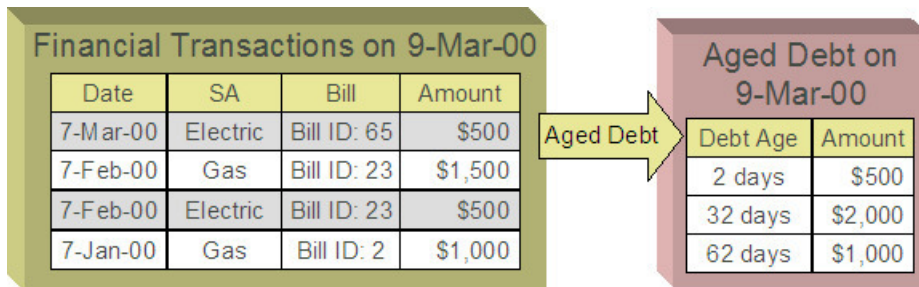

If the dispute goes in the customer's favor:

- You may decide to issue a credit note to cancel the offending bill or bill segment(s). As described above, the system in this case will automatically create new match events that match the original FTs with their cancellation FTs and cancel the disputed match event when the last item is unlinked from it.
- You may decide to cancel the offending bill segment(s) / adjustment(s). As described above, these cancellations are going to be swept on to the next bill. The system therefore will not automatically cancel the disputed match event. Notice that the cancellation effect of the disputed items is carried over on to the next bill. This means that the previously disputed items still need to be paid.

**NOTE:**

**Cancel / rebill.** If you cancel / rebill an offending bill segment, both the cancel and the rebill will become open-items that will be matched when the next bill is paid.

- You may decide to issue an adjustment to counter the effect of the disputed FT's. In this situation, you would simply link the adjustment FT to the disputed FT's (thus allowing the match event to become balanced ). It is important to use in this case an adjustment that does not show on bill.

## Pay Plans

You create a [pay plan](#) when a customer agrees to make one or more scheduled payments to satisfy past (or future) debt. These payments cannot be matched to open items because it is unlikely that debit FT's exist that equal the amount of each scheduled payment. However, you must specify a match type on all payments made by open-item customers. Therefore, a conundrum exists - the system requires a match type on payments made by open item accounts, but payments made for



pay plans cannot be matched to existing FT's. This conundrum is solved by the fact that match types do not have to specify an override payment distribution algorithm. The customer class's standard distribution algorithm is used for payments that reference such a match type.

You may wonder how these payments will eventually get matched to open items? If ALL payments associated with a pay plan occur before the next bill is paid (or if the pay plan exists to satisfy future debt), these payments will be swept onto the match event that is created when the customer pays their next bill. However, if the pay plan exists to payoff historical debt and this debt has not been entirely paid by the time of the next bill, an unmatched event will exist when the customer pays their subsequent bills (if the payment amount doesn't match the amount of new charges on the bill). Why? Because, the customer is not paying the entire amount of the bill and therefore the system will not be able to match the payment to open items. If this occurs, we recommend canceling the match events that are created when the customer pays their subsequent bills. When the customer finally pays off all outstanding debt, the system will create a single match event that will contain all payments and bill segments.

## Over Payments

If a customer overpays a bill (i.e., we receive more cash than receivables), we strongly recommend you set up the system to NOT keep the excess credit on the customer's regular service agreements. Rather, we recommend you segregate the receivable onto an "excess credit" service agreement. If you do this, the system will transfer any excess credits to the regular service agreements at bill completion time. When this transfer occurs, the same accounting described under [Payments Segment Financial Transaction Algorithms Transfer Holding Amounts To Payable GL Accounts](#) occurs as shown in the following example. Note: this example assumes an excess credit of \$110 was transferred to a normal service agreement and the normal service agreement had \$10 of held payables.

---

### FASTPATH:

Refer to [Overpayment Segmentation](#) for how to set up the system to segregate overpayments on a separate service agreement.

---

### NOTE:

**Why not keep excess credits on a customer's regular service agreement?** Because the system can't differentiate between a credit that exists as a result of an overpayment and a credit that exists because of cancel/rebills, it would be impossible for the system to know if payables should be realized as a result of the reduced credit balance. However, if you keep overpayments on an excess credit service agreement, the system knows to treat any transference of these credits as "payments" and therefore it can transfer holding balances to true payables.

---

Event	Normal SA GL Accounting	Excess Credit SA GL Accounting
Bill segment created	A/R 110	
	Revenue <100>	
	Tax Holding <10>	
Payment of \$300 is received	Cash 110	Cash 190
	A/R <110>	Overpay <190>
	Tax Holding 10	
	Tax Payable <10>	
Bill segment created	A/R 110	
	Revenue <100>	
	Tax Holding <10>	



Transfer excess credit amount to normal service agreement (when bill is completed).	Xfer 110 A/R <110>	Overpay 110 Xfer <110>
Because the transfer adjustment is the equivalent of a cash relief outstanding tax holding is relieved in proportion to the amount of receivables that are reduced by the transfer	Tax Holding 10 Tax Payable <10>	
Net effect of the transfer	Xfer 110 A/R <110> Tax Holding 10 Tax Payable <10>	Overpay 110 Xfer <110>

**NOTE:**

**Prepaid taxes - future functionality.** If your organization allows customers to prepay taxes in anticipation of a future tax increase (the customers receive the lower rate if they pay in advance), we do not consider this prepayment to be an overpayment. Rather, it is a payment of future taxes that will be remitted to the taxing authorities at payment time (due to cash accounting). Please speak to your account manager for when corresponding functionality will be available.

## Setting Up The System To Enable Open Item Accounting

The following section provides an overview of how to enable open-item accounting.

### Match Type Setup

The number of match types that you will need is dependent on the number of ways you want payments to be matched to open items. At a minimum, you will probably need the following match types:

- **Bill ID.** This match type should reference an override payment distribution algorithm that distributes the payment based on the bill ID specified on the payment (in match value). Refer to [Payments And Match Events](#) for more information.
- **SA ID.** This match type should reference an override payment distribution algorithm that distributes the payment based on the SA ID specified on the payment (in match value). Refer to [Payments And Match Events](#) for more information.
- **Pay Plan.** This match type should NOT reference an override payment distribution algorithm (if this algorithm is blank, the customer class's payment distribution algorithm is used). Refer to [Pay Plans](#) for more information.

### Match Event Cancellation Reason Setup

The number of match event cancellation reasons that you will need is dependent on the number of ways your organization can justify the cancellation of a match event. At a minimum, you will probably need the following match event cancellation reasons:

- **FT Cancellation.** This cancel reason should be referenced on the Customer Class FT Freeze algorithm that is responsible for canceling match events when one of its financial transactions is cancelled.
- **Incorrect Allocation.** This cancel reason should be specified by users when they cancel match events that were created by the system erroneously.

## Customer Class Setup

The following points describe [customer class](#) oriented set up functions:

- Turn on the open-item accounting switch.
- Set up the following algorithms for each CIS division:
  - Specify a **payment freeze** algorithm that causes a payment's FT's to be linked to the match event that was created when the payment was distributed. Refer to [Payments And Match Events](#) for more information.
  - Specify a **FT freeze** algorithm that causes match events to be cancelled (and a new match event to be created) when a FT is cancelled. Refer to [How Are Match Events Cancelled](#) for more information about cancellation.
  - We strongly recommend specifying an **overpayment** algorithm that causes overpayments to be segregated onto an "excess credit / overpayment" SA. Refer to [Overpayments](#) for more information.

## Overpayment SA Type Setup

Specify a **bill completion** algorithm that causes the credit amount on overpayment SAs to be transferred to newly create debt (created when the bill is created). This algorithm transfers an overpayment SA's balance to regular SAs and creates a match event if the overpayment covers the entire bill. Refer to [Overpayments](#) for more information.

## Installation Record Setup

Specify an **automatic payment** algorithm that causes a match event to be created when automatic payments are created for open-item accounts. The base package algorithm will do this for you if you specify the appropriate parameter on the algorithm. Refer to [APAY-CREATE](#) for more information about this algorithm.

If you want a Control Central alert to highlight when the current account has any open match events, plug in the appropriate **control central alert** algorithm on your installation record. Refer to [C1-OPN-MEVT](#) for more information about this algorithm.

If you want to enable manual pay segment distribution for open item accounts, along with other functions, you will need to plug in an installation algorithm for bill balance calculation. Refer to [C1-OI-BI-AMT](#) for more information about this algorithm.

## To Do Entry Setup

Two To Do types are supplied with the base package:

- **TD-MODTL**. This To Do type highlights the presence of open, disputed match events.
- **TD-MONTL**. This To Do type highlights the presence of open, non-disputed match events.

Each of the above To Do types should be configured with the roles that work on entries of each type.

In addition, the account management group and/or divisions from which the default roles are extracted should be updated to define the role that should be defaulted for each of the above To Do types.

---

### FASTPATH:

Refer to [The Big Picture Of To Do Lists](#) for more information about To Do lists.

---

## Setting Up Match Types

Most payments are distributed amongst service agreements using the payment distribution algorithm specified on the payment's account's customer class. This algorithm decides how to distribute a payment amongst an account's existing debt if the customer doesn't specify how the payment should be distributed.

A customer can specify how a payment is distributed by specifying a match type and match value on their payments. Consider the following examples:

- Customers that are subject to open-item accounting (this is defined on the account's customer class) tell the system exactly which debt is covered by their payments. For example, an open-item customer might make a payment in respect of bill ID 123919101919.
- Even non open-item customers can direct payments to specific SAs. For example, the system allows a balance-forward customer's payment to be directed to a specific service agreement (however, they cannot direct payments to specific bills as only open-item customers can do this).

Match types are used to define the specific type of debt that is covered by a payment. The match type contains the algorithm that effectively overrides the standard payment distribution algorithm defined on the account's customer class.

---

**NOTE:**

**Background information.** Please refer to [Payments And Match Events](#) and [Match Type Setup](#) for more information about how match types are used.

---

To set up match types, select **Admin > Financial > Match Type**.

### Description of Page

Enter an easily recognizable **Match Type** and **Description**.

Define the **Pay Dist Override Algorithm** used to distribute payments that reference this match type. If you haven't done so already, you must set up this algorithm in the system. To do this:

- Create a new algorithm (refer to [Setting Up Algorithms](#) ).
- On this algorithm, reference an Algorithm Type that overrides the normal payment distribution algorithm.

### Where Used

Follow this link to open the data dictionary where you can view the tables that reference [CI\\_MATCH\\_TYPE](#).

## Setting Up Match Event Cancellation Reasons

When a match event is canceled, a cancel reason must be supplied.

---

**NOTE:**

**Background information.** Refer to [How Are Match Events Cancelled?](#) and [Setting Up Match Event Cancellation](#) for more information about cancellation.

---

To set up match event cancellation reasons, select **Admin > Financial > Match Event Cancel Reason**.

### Description of Page

Enter an easily recognizable **Match Event Cancel Reason** and **Description**.

### Where Used

Follow this link to open the data dictionary where you can view the tables that reference [CI\\_MEVT\\_CAN\\_RSN](#).

## Fund Accounting

The topics in this section provide background information about fund accounting.

**NOTE:**

**This section is only relevant for some organizations.** The system configuration requirements described in this section are only relevant if your organization practices fund accounting (this type of accounting is typically performed by municipal utilities). If your organization does not practice fund accounting, you need only indicate such on the [Installation Record](#); no other setup is required.

## Fund Accounting Overview

Municipal utilities, and not-for-profit organizations in general, often use a form of accounting different from that used by for-profit corporations. Municipal utilities typically practice fund accounting, whereas corporations practice corporate accounting.

Regulations or other restrictions may require a municipal utility to account for the finances of each of its departments as a separate entity. If a municipal utility provides both water and wastewater service, a municipal utility may need to track the receivables, revenue, and liabilities for water service separately from those of wastewater. In contrast, a corporation is free to co-mingle the moneys of the two services.

To track the services separately, the municipal utility sets up a fund for each department. A fund is an accounting entity with its own self-balancing set of accounts. Each fund has its own "sub general ledger" with its own chart of accounts, and within each fund, its debits equal its credits at all times. This allows the utility to report on the financial state of each fund independently.

In addition to having a fund for each department, there is also a general fund, which is used to handle inter-fund transfers as well as shared accounts.

## Fund Accounting Example

Consider a municipal utility which provides water and wastewater service. The utility has two departments: water and wastewater. Each department must track their finances separately therefore a fund is setup for each department:

- Water (fund 01).
- Wastewater (fund 02).

In addition, with fund accounting, there is always a general fund (fund 99).

Assume the following bill is generated.

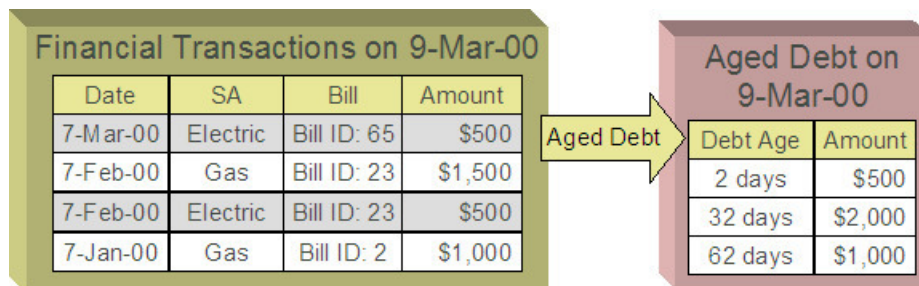

The bill would produce the following GL entries:

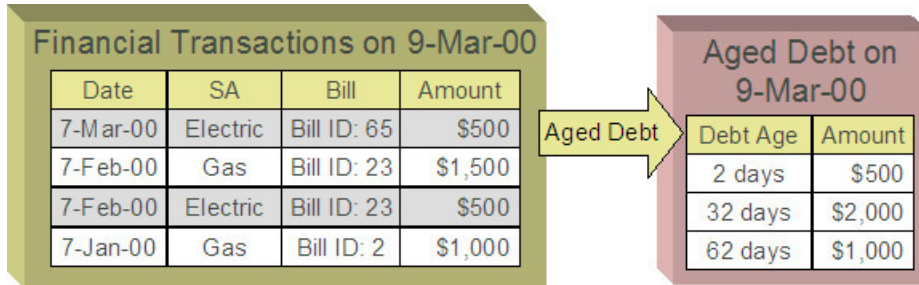

For each fund, the GL details of the bill will include a debit to the accounts receivable (A/R) account and credits to the revenue and taxes payable accounts. In organizational terms, each department is owed a portion of the overall bill by the customer, part of which is sales by the department and part of which is owed to the taxing authorities by the department. Each fund is balanced.

Note that the accounting could be identical under corporate accounting if each service is its own division with its own chart of accounts.

The following diagram illustrates the initial GL accounting that would occur when the payment arrives:

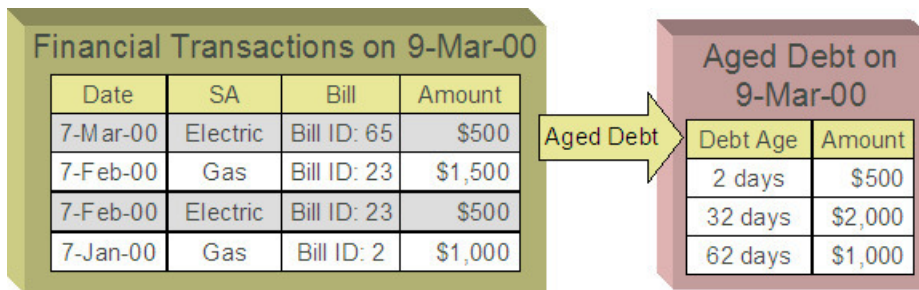

The utility's general cash account is debited, and the departmental funds' A/R accounts are credited. In other words, the cash is held by the utility as a whole but the receivables are reduced for the individual departments.

If the accounting were left in this state, the fund accounting principal - that each fund represents an independent entity with a self-balancing chart of accounts - would be violated. This violation is caused due to the fact that cash is recorded on the general fund, not the departmental funds, causing the general fund to have an excess debit and the departmental funds to have an excess credit.

From an organizational viewpoint, to make each department whole, the departments need to note what portion of the cash they own, and correspondingly, the utility needs to note what portion of the cash is owed to each department. The following diagram illustrates this point.

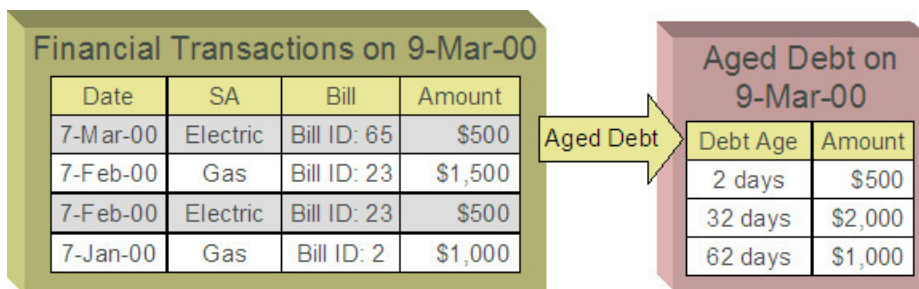

To maintain a balance of debits and credits within each fund, the departmental funds have an "equity in pooled cash" (EPC) account and the general fund has a liability account for each departmental fund. In addition to debiting the general fund's cash account and crediting the departmental funds' A/R accounts, the departmental funds' EPC accounts are debited and the general funds liability accounts are credited.

And so, with the additional GL entries, all funds have matching debits and credits.

## An Example Of A Bill Segment That References Multiple Funds

Consider a municipal utility that primarily supplies water service but is also responsible for maintaining the city's fire hydrants. The costs for fire hydrant maintenance are borne by the water customers and make up just a small portion of the overall bill. These costs are simply added to the water bill as a line item. The utility has two departments:

- Water service (fund 01)
- Hydrant maintenance (fund 39).

In addition, there is a general fund (fund 99).

Assume the following bill is generated for water and hydrant services.

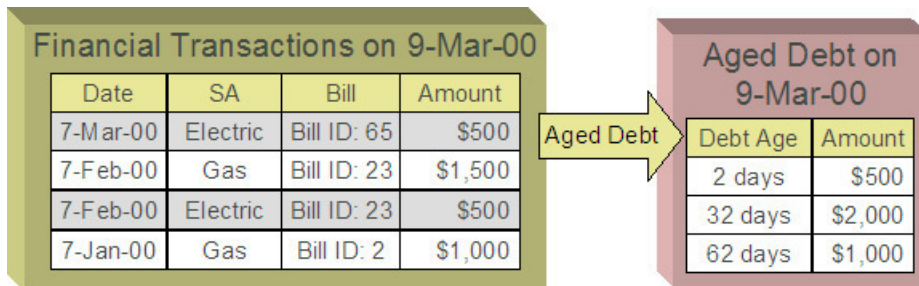

The following diagram illustrates the initial GL entries for the bill:

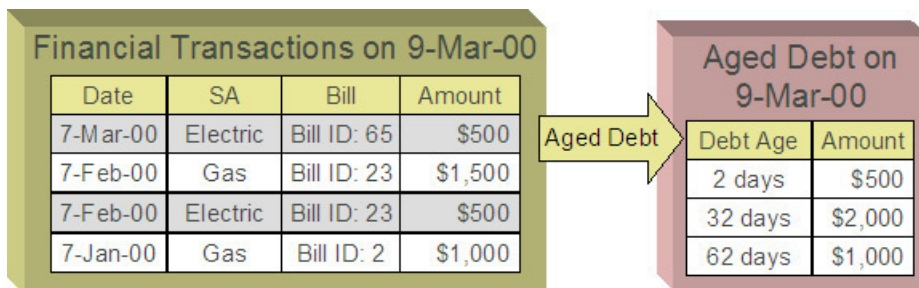

In accounting for the bill, the water fund's A/R is debited, the water and hydrant funds' revenue accounts are credited, and the water's taxes payable account is credited.

If left at this, the funds would be out of balance; the water fund would have an overall excess debit and the hydrant fund would have an equal excess credit. In organizational terms, the hydrant fund has recorded sales but that amount is recorded as being owed to the water department.

To balance each department, the water department accepts the responsibility for collecting the hydrant charges from the customer but immediately remunerates the charges to the hydrant fund.

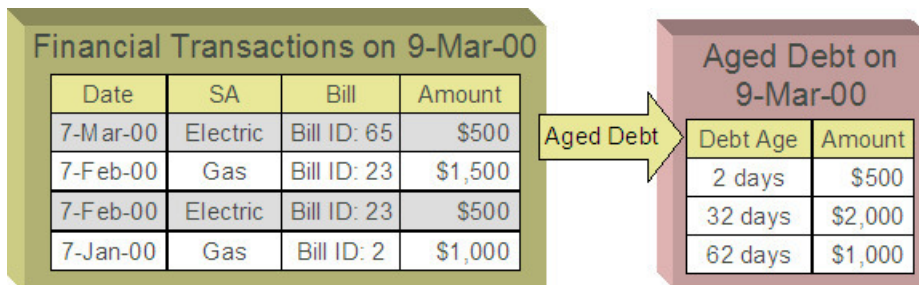

This transfer is done using the general fund. The water fund's EPC account is credited and the liability to water is debited with the amount of the hydrant revenue. Also, the hydrant fund's EPC account is debited and the general fund's liability to



hydrant account is credited by the hydrant revenue. In effect, the water department owes the hydrant charges to the general fund, and the general fund owes the hydrant charges to the hydrant fund.

The following diagram illustrates the initial GL accounting that would occur when the payment arrives:

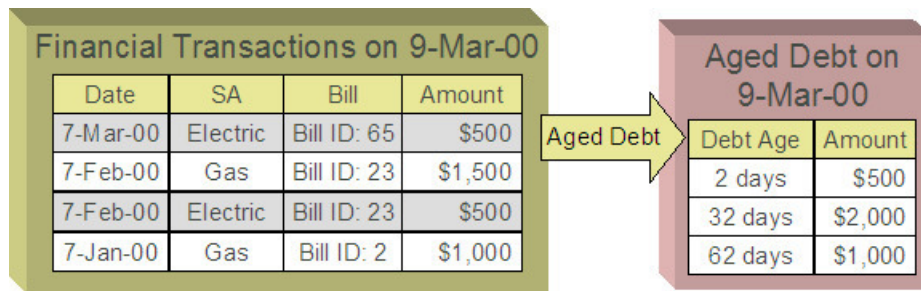

When the payment arrives, the cash is debited to the general fund's cash account, and the water fund's A/R is relieved. Again, the funds would be unbalanced if left in this condition; the water fund would have an excess of credits and the general fund would have an excess of debits.

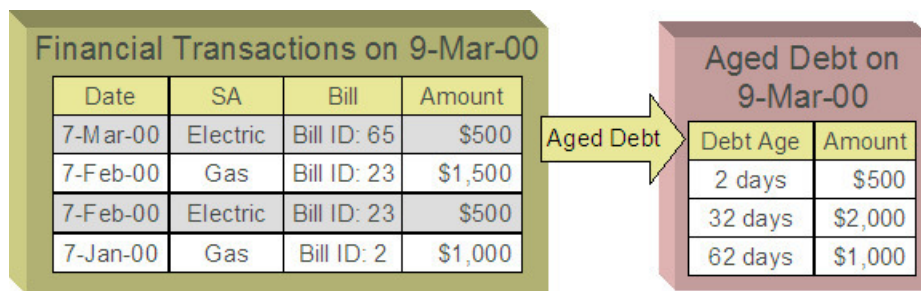

To maintain each fund's balance of debits and credits, the general fund's liability to the water fund is credited by the amount of the department's share of the cash, and the water fund's EPC is debited. Note that the payment has no effect on hydrant fund's EPC and the general fund's liability to the hydrant fund. The hydrant department "received" its money from the water department when the bill was created.

And so, all funds have matching debits and credits.

## Accounting Method Is Defined On The Installation Options

You must turn on a switch on the [Installation Record](#) to enable fund accounting.

## Fund Controls Fund-Balancing Entries

There are two levels of debit and credit balancing in fund accounting. There is the balancing required by double entry accounting: the total debits in the entire GL must equal the total credits. This is required regardless of whether fund or corporate accounting is used. The distribution codes for these entries come from varying sources, depending on the type of financial event.

### FASTPATH:

Refer to [The Source Of GL Accounts On Financial Transactions](#) for information on the sources of the distribution codes.

The second level of balancing is specific to fund accounting. Within each fund-not just across the GL-the total debits must equal the total credits. The original distribution code from the financial event has a fund specified. For example, a bill would

cause a debit to a fund's A/R distribution code, and included in that A/R distribution code is the fund. It is the definition of the fund that specifies whether fund-balancing entries are required and provides the distribution codes for these entries.

For a departmental fund, the fund-balancing debit and credit would be specified. When a debit is applied to a departmental fund's GL account, an additional account (typically the general fund's liability to the departmental fund) is debited and an account (typically the departmental fund's EPC) is credited. When a credit is applied to a departmental fund's account, an additional account (typically the general fund's liability to the departmental fund) is credited and an account (typically the department's EPC) is debited.

For the general fund, no fund-balancing debits and credits are specified.

## Building Fund-Balancing GL Details

Building the GL details for a financial event is a two-step process.

- First, the system generates the regular GL details for a financial transaction (FT). This is done regardless of whether corporate or fund accounting is used.
- Second, if fund accounting is activated (by turning on a switch on the [Installation Record](#)), the system analyzes the distribution code on each GL detail associated with the FT. If a **fund** is specified on a distribution code, the system checks the definition of the fund. If fund-balancing entries are specified on the fund, two additional GL entries are added to the FT:
- An offsetting entry to the Equity in Pooled Cash account is created for the departmental fund (e.g., if the FT is debiting a given fund, an offsetting credit is created in the funds EPC account).
- Another entry to the departments Liability account is created for the general fund.

The result is a consolidated set of GL entries for the FT, incorporating the regular entries as well as the fund-balancing entries.

The topics in this section illustrate the generation of the GL details for the earlier examples.

## FTs Whose GL Details All Reference The Same Fund Do Not Impact the General Fund or EPC Accounts

In [Fund Accounting Example](#), where the bill's bill segments reference a single fund, the system creates a fund-balancing GL entry for each GL entry applied to a departmental fund:

- A debit to a departmental GL account triggers a debit to the general fund's liability-to-departmental-fund account and a credit to the departmental fund's equity-in-pending-cash account.
- A credit to a departmental GL account triggers a credit to the general fund's liability-to-departmental-fund account and a debit to the departmental fund's equity-in-cash account.

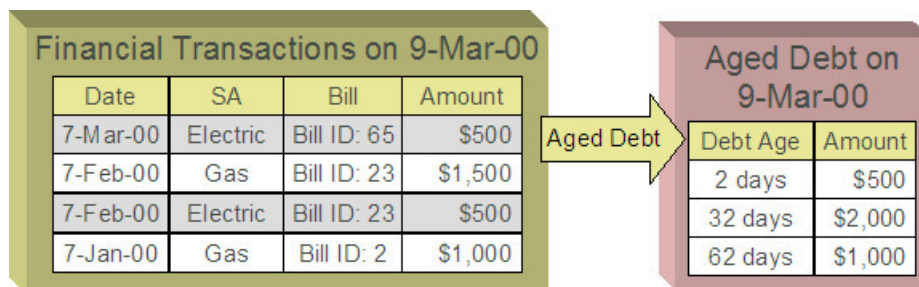



The net effect on the individual equity-in-cash and general fund's liability accounts is zero because the debits and credits net to zero for each GL account. In other words, the yellow boxes net to zero and therefore fund accounting does not impact the bill segment's financial transactions. Refer to [Fund Accounting Example](#) for the resulting consolidated GL entries.

## An FT Whose GL Details Reference Multiple Funds

In [An Example Of A Bill Segment That References Multiple Funds](#), where the bill's bill segments reference multiple funds (water and hydrant), the system also creates fund-balancing GL entries for the financial transaction:

- A debit to a departmental GL account triggers a debit to the general fund's liability-to-departmental-fund account and a credit to the departmental fund's equity-in-pending-cash account.
- A credit to a departmental GL account triggers a credit to the general fund's liability-to-departmental-fund account and a debit to the departmental fund's equity-in-cash account.

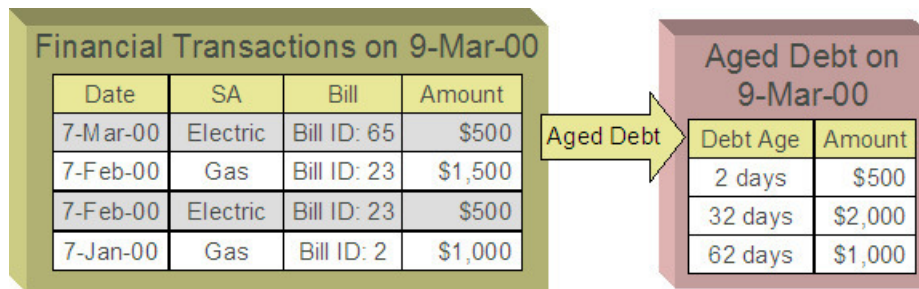

The net effect of the bill on the GL is that the water fund's EPC has a credit of \$0.80, the hydrant fund's EPC has a debit of \$0.80, the general fund's liability to the water fund has a debit of \$0.80, and the general fund's liability to the hydrant fund has a credit of \$0.80. Note that, overall, the general fund's overall liability to the departmental funds nets to zero. Refer to [An Example Of A Bill Segment That References Multiple Funds](#) for the resulting consolidated GL entries.

## Setting Up The System To Enable Fund Accounting

The following section provides an overview of how to enable fund accounting.

### Turn On Fund Accounting

On the [Installation Record](#), indicate that fund accounting is Practiced.

### Defining Funds

A fund must be setup for each specific fund in your organization. Don't forget to also set up a fund for the general fund. Navigate using **Admin > Financial > Fund**.

#### Description of Page

Enter a **Fund** and a **Description** to identify the fund.

If this fund is used to balance other funds or to hold cash, indicate a **Fund Type** of General, otherwise indicate that it is Specific.

If the fund type is Specific, specify the **Equity Distribution Code** and **Liability Distribution Code**. These codes are used to balance financial transactions that span funds. The equity distribution code should belong to the same **Fund** as the one you are defining. The liability distribution code should belong to the general fund.

## Distribution Codes Must Include Fund ID

All of your distribution codes must include their respective fund ID.

---

**FASTPATH:**

For more information, refer to [Setting Up Distribution Codes](#).

---

## Update Your Funds With Their Respective Equity and Liability Distribution Codes

After distribution codes have been setup, you must update your funds to indicate the equity and liability accounts used to balance inter-fund financial transactions.

## Bill Taxation Threshold

Some implementations only apply taxes if the accumulated tax amount at the bill level exceeds some specified threshold amount.

## Taxation Threshold Examples

The following examples show how taxation thresholds affect a customer's bill. In the examples a tax rate of 5% and a threshold amount of \$21.30 is used.

### Example 1 - Account With Taxes Under Threshold

This example shows the bill for an account where the accumulated tax amount is less than the threshold amount. Since the accumulated tax amount of \$10.50 is less than the threshold amount, taxes are not applicable and the account's bill should be adjusted to exclude the tax amount of \$10.50.

---

Bill Line	Amount
Standing Charge	10.00
2,000 units @ \$0.10	200.00
Tax @ 5% on \$210.00	10.50
Total	220.50
Adjusted Total	210.00

---

## Example 2 - Account With Taxes Above Threshold

This example shows the bill for an account where the accumulated tax amount is greater than the threshold amount. Since the accumulated tax amount of \$27.92 is greater than the threshold amount, taxes are applicable and the account should be billed for the total amount.

Bill Line	Amount
Standing Charge	10.00
4,000 units @ \$0.10	400.00
Additional Charge	148.45
Tax @ 5% on \$558.45	27.92
<b>Total</b>	<b>586.37</b>

## Example 3 - Account With Rounding Discrepancy

This example shows the resulting bill segment calc lines for an account with 3 service agreements. Here the accumulated tax amount at the bill level is \$21.29 with taxes calculated and rounded for each SA's bill segment. However, if the same taxes were calculated for each SA's bill segment and then accumulated and rounded at the bill level, the accumulated tax amount would be \$21.30 implying that taxes are applicable and the account should be billed for the tax amount of \$21.30 accounting for the discrepancy of \$0.01.

Bill Segment	Bill Line	Amount	Pre-rounding Amount
Bill segment for SA 1	964.70 units @ \$0.10	96.47	96.47000
	Tax @ 5% on \$96.70	4.82	4.82350
	<b>Bill Segment Total</b>	<b>101.29</b>	
Bill segment for SA 2	2222.90 units @ \$0.10	222.29	222.29000
	Tax @ 5% on \$222.29	11.11	11.11450
	<b>Bill Segment Total</b>	<b>233.40</b>	
Bill segment for SA 3	1072.40 units @ \$0.10	107.24	107.24000
	Tax @ 5% on \$107.24	5.36	5.36200
	Tax Discrepancy	0.01	
	<b>Bill Segment Total</b>	<b>112.61</b>	

**NOTE:**

**Pre-rounding amount.** Rate application captures two calculated amounts on the resulting bill segment calc lines. The first is the calculated amount rounded to two decimal places, and the second is a raw calculated amount with a five decimal precision. The base package algorithm that calculates taxation thresholds uses both amounts to account for any rounding discrepancy; however, only the raw calculated amount is used to compare against the taxation threshold.

## Billing and Taxation Thresholds

The following sections describe how taxation threshold rules are implemented when a bill is produced.

### Calculation of Taxation Thresholds

When taxation thresholds are applied at the account's bill level, it means that the system must calculate taxes for each of the account's service agreements, then sum these tax amounts and apply any applicable rounding rules. This accumulated tax amount is compared to a threshold amount and if the accumulated tax amount is less than the threshold amount, then taxes should not be applied to the customer's bill. To ensure the accumulated tax amount is accurate, all service agreements for an account whose tax amounts should be taken into consideration when comparing to the specified threshold should be billed together and the threshold comparison should take place after the bill segments have been generated. In addition, all bill segments whose tax amounts should be taken into consideration when comparing to the specified threshold must be for the same bill period.

---

**NOTE:**

**Bill segments from different periods may not appear on the same bill.** If a bill segment is canceled, all bill segments associated with that bill must be canceled and re-billed together. You cannot re-bill the bill segment on a bill for a different period.

---

An algorithm type is supplied with the base package that checks for taxation thresholds at bill completion time. The base bill completion algorithm type accumulates identified tax calc line amounts (accomplished using a bill segment calc line characteristic), and compares this to a specified threshold amount to determine if taxes apply for the account. If taxes do not apply, it sets a bill characteristic indicating this and regenerates the bill segment. Refer to the algorithm type [C1-CPBC-TAXT](#) for more information on how this type of algorithm operates.

---

**NOTE:**

**Calculated adjustments are included in the evaluation against taxation thresholds.** Adjustments that use a rate to calculate the adjustment amount may be included in the taxation threshold evaluation if their rate's components are set up to do so. The base algorithm [C1-CPBC-TAXT](#) looks at adjustments that are about to be swept onto the bill and, if applicable, includes them in the calculation.

---

The calculation rule(s) that calculate taxes make use of calculation rule eligibility criteria to ensure that taxes are only computed if the bill does not have the characteristic indicating that taxes are not applicable. Note that during the initial generation of each bill segment, the characteristic will not exist and taxes will be applied. This means that if you look at a bill before it is complete, taxes may not be accurately reflected.

### Tax Amount Discrepancies

Since tax calculation rules are calculated and rounded at the bill segment level, it's possible that rounding discrepancies may occur if rounding of these tax amounts occurs at the bill level instead as illustrated in the example above. To account for this, the system uses both the two decimal precision and the five decimal precision calculated amounts that rate application captures on bill segment calc lines; however, only the raw calculated amount is used to compare against the taxation threshold. If there is a discrepancy in the tax amount (as shown in example 3 above), the system captures this amount as an entry in one of the bill segment's SQ collections prior to regenerating the bill segments. This is depicted in example 3 above where the tax discrepancy SQ resulted in an additional bill segment calc line on one of the bill segments for the rounding amount of 0.01. Note that a calculation rule is configured to bill for this discrepancy amount SQI.

---

**NOTE:**

**Pre-rounding amount.** Rate application captures two calculated amounts on the resulting bill segment calc lines. The first is the calculated amount rounded to two decimal places, and the second is a raw calculated amount with a five decimal precision. The base package algorithm that calculates taxation thresholds uses both amounts to account for any rounding discrepancy; however, only the raw calculated amount is used to compare against the taxation threshold.

---

## Setting Up The System For Bill Taxation Thresholds

This section provides an overview of how to configure the system to calculate taxes at the account's bill level.

### Installation Option

Select Freeze at Bill Completion as the bill segment freeze option. The system compares tax amounts calculated to a specified threshold amount and based on this determines if taxes should apply at bill completion time. If taxes should not be applied for the account, the system has to regenerate the bill segments as necessary.

### Adjustment Types

Select Freeze at Bill Completion as the adjustment freeze option. The system compares tax amounts calculated to a specified threshold amount and based on this determines if taxes should apply at bill completion time. If taxes should not be applied for the account, the system has to regenerate the adjustments as necessary.

### Bill Factors

Tax Threshold. Set up a separate bill factor for each distinct tax threshold amount.

### Characteristic Type

Set up a characteristic type and value to identify the tax calculation rules and bill segment calculation lines that the system will use to compare to the specified threshold amount. Specify this characteristic type and value as parameters to the algorithms that apply the taxation threshold. This characteristic type and value must also be specified on each of your tax calculation rules that should be included in the threshold comparison.

Set up a characteristic type and value to use for the bill characteristic that indicates when bill level taxes apply. Specify this characteristic type and value as parameters to the algorithms that apply the taxation threshold.

### Service Quantity Identifiers

Optional service quantity identifiers may be configured to capture the following:

- **Tax Amount.** The system compares the accumulated bill's tax amount to the specified threshold amount to determine if taxes are applicable. If taxes should not be applied for the account, the system regenerates the bill segments as necessary. If you wish to capture the tax amount computed for informational purposes, then a tax amount SQI should be set up and specified as a parameter on the algorithms that apply the taxation threshold.

- **Tax Discrepancy Amount.** Since tax calculation rules are calculated and rounded at the bill segment level, it's possible that rounding discrepancies may occur if rounding of these tax amounts should take place at the bill level. If you wish to account for these rounding discrepancies, then a tax discrepancy amount SQI should be set up and specified as a parameter on the algorithms that apply the taxation threshold. Your rates should also be configured to cater for this rounding discrepancy. The system adds an entry for the discrepancy amount to one of the bill segment's SQ collections prior to regenerating the bill segments.

## Algorithms

**Apply Taxation Threshold.** Define an algorithm for each distinct tax threshold amount. Plug the algorithm(s) in on the appropriate customer class for the Pre Bill Completion system event. Refer to the [C1-CPBC-TAXT](#) algorithm type for more information about the base package algorithm.

**Adjustment Generation - Apply Rate.** Define an algorithm for each rate to be used by calculated adjustment types that are to be included in the tax threshold evaluation. Plug the algorithm(s) in on the appropriate adjustment type for the Generate Adjustment system event. Refer to the [ADJG-RT](#) algorithm type for more information about the base package algorithm.

## Calculation Rules For Bill Taxation Thresholds

Your calculation rules that bill for taxes require the following:

- A characteristic that identifies them as calculation rules to include in taxation threshold comparisons
- Calculation rule eligibility criteria to ensure that taxes are not calculated if the taxation threshold algorithm dictates this

Only one eligibility group on the calculation rule is required. It would look as follows:

Group No.	Group Description	If Group is True	If Group is False
1	Tax applies if total accumulated tax amount at the account's bill level exceeds the threshold amount	Apply calculation rule	Skip calculation rule

The following criteria will be required for this group:

Seq	Field to Compare	Comparison Method	If True	If False	If Insufficient Data
10	Bill characteristic: Characteristic type = Tax Not Applicable indicator	= YES	Group is false	Check next condition	Group is true
20	Characteristic Collection: Characteristic type = Tax Not Applicable	= YES	Group is false	Group is true	Group is true

### NOTE:

The second criterion included above is used to evaluate the applicability of the tax on calculated adjustments. Since these adjustments are not yet linked to the bill, the first criterion cannot be used to evaluate the applicability of the tax threshold. The pre-bill completion algorithm [C1-CPBC-TAXT](#) instead adds the characteristic to the characteristic

collection for use by the rate application when evaluating the adjustment's rate's eligibility rules. Refer to the [ADJG-RT](#) algorithm type for more information about the base package algorithm.

---

**FASTPATH:**

For more information, refer to [Designing Calculation Groups and Rules](#).

---

An additional calculation rule is required to bill for the tax rounding discrepancy as follows

- Calculation Rule type = Service Quantity
- UOM/TOU/SQI = the identifier of the service quantity containing the tax discrepancy amount
- Value Type = Unit Rate
- Value Source = Value
- Value = 1

## Other Financial Transaction Topics

Various topics about financial transactions are discussed in this section.

## The Source Of GL Accounts On Financial Transactions

The following table lists the major financial events, their standard accounting, and the source of distribution codes used to derive the GL accounts sent to your general ledger.

Financial event	GL Accounting	Source Of Distribution Code
Create a normal utility bill segment. Bill Segment FT Algorithm is Payoff Amt = Bill Amt / Current Amt = Amt Due	Debit: A/R	SA Type
	Credit: Revenue / Taxes Payable	Calculation Rule
Create a bill for company usage. Bill Segment FT Algorithm is Payoff Amt = 0 / Current Amt = 0	Debit: Company Usage Expense	SA Type
	Credit: Revenue / Taxes Payable	Calculation Rule
Create a bill for charity. Bill Segment FT Algorithm is Payoff Amt=0 / Current Amt = Bill Amt	N/A - charity bills have no effect in the GL	N/A
	N/A	N/A
Create a payment segment for a normal utility service agreement	Debit: Cash	Bank Account on the Tender Source of the Tender Control for the Payment Segment's Tender.
	Credit: A/R	SA Type
Create a payment segment for a charitable contribution service agreement	Debit: Cash	Bank Account on the Tender Source of the Tender Control for the Payment Segment's Tender.

	Credit: Charity Payable	SA Type
Create a payment segment for auto-pay at bill completion time	Debit: Cash	Bank Account on the Tender Source on the Auto-pay Route Type of the Auto-pay Source.
	Credit: A/R	SA Type
Canceling a payment	Debit: A/R	SA Type
	Credit: Cash	Bank Account specified by the user on the cancel tender page. Note that this defaults to the original tender's bank account.
Create an adjustment to levy a charge	Debit: A/R	SA Type
	Credit: Revenue	Adjustment Type

The bottom line is as follows:

- If a bill segment has a financial effect, the distribution code to debit comes from the distribution code on the SA Type, the distribution code to credit comes from the calculation rule(s) used to calculate the bill segment.
- Payment segments always have a financial effect; the distribution code to debit comes from the bank account on the tender source of the tender control of the tender, the distribution code to credit comes from the SA type.
- If an adjustment has a financial effect, the distribution code to debit and credit comes from the SA type and adjustment type. If the adjustment is positive (i.e., the customer owes your organization more money), the distribution code to debit comes from the SA type; the distribution code to credit comes from the adjustment type. Vice versa if the adjustment is negative.

## Defining Customer Options

The definition of a customer is someone (or something) with financial obligations with your company. These obligations ensue because the customer has agreed to purchase goods or services at an agreed price.

You may be surprised to learn that there is no "customer" record in the system. Rather, the system subdivides customer information into the following records:

- **Person.** The person record holds demographic information about your customers and every other individual or business with which your company has contact. For example, in addition to customers, person records also exist for landlords, contractors, accountants at corporate customers, guarantors of customers, energy distributors, collection agencies, etc.
- **Account.** Accounts are the entities for which bills are produced and therefore you must create at least one account for every person who has financial obligations with your company. The account record contains information that controls when the bills are created and how the bills are formatted.
- **Service Agreement.** Think of a service agreement as a contract between your company and the customer. The service agreement contains the terms and conditions controlling how the bill details are created. Every account will have at least one service agreement (otherwise, nothing will appear on the account's bills).

Before you can define persons, accounts, and service agreements, you must set up the control tables defined in this section.

### FASTPATH:

For more information about how persons, accounts and premises are used by your customer service reps, refer to [Understanding The "V"](#).

### NOTE:

The tables in this section are only some of many tables that must be set up before you can bill your customers for the service(s) they consume. In this section, we limit the discussion to those tables that control basic demographic



and financial information. In later sections, we describe the tables that control other billing-related functions like bill creation algorithms, meter reading and rates. It is only after all of these tables are set up that you will be able to generate bills and record payments.

## Customer Overview

This section describes how the person, account, and service agreement records are used to record your customers' demographic and billing options.

### A Simple Example Of Two Customers

The following picture illustrates two customers: Joe Smith and Pam Jones. Joe is the "main customer" on his account. Pam is the "main customer" on her account. Pam is also the "third party guarantor" on Joe's account.

## A Simple Example Of Two Customers

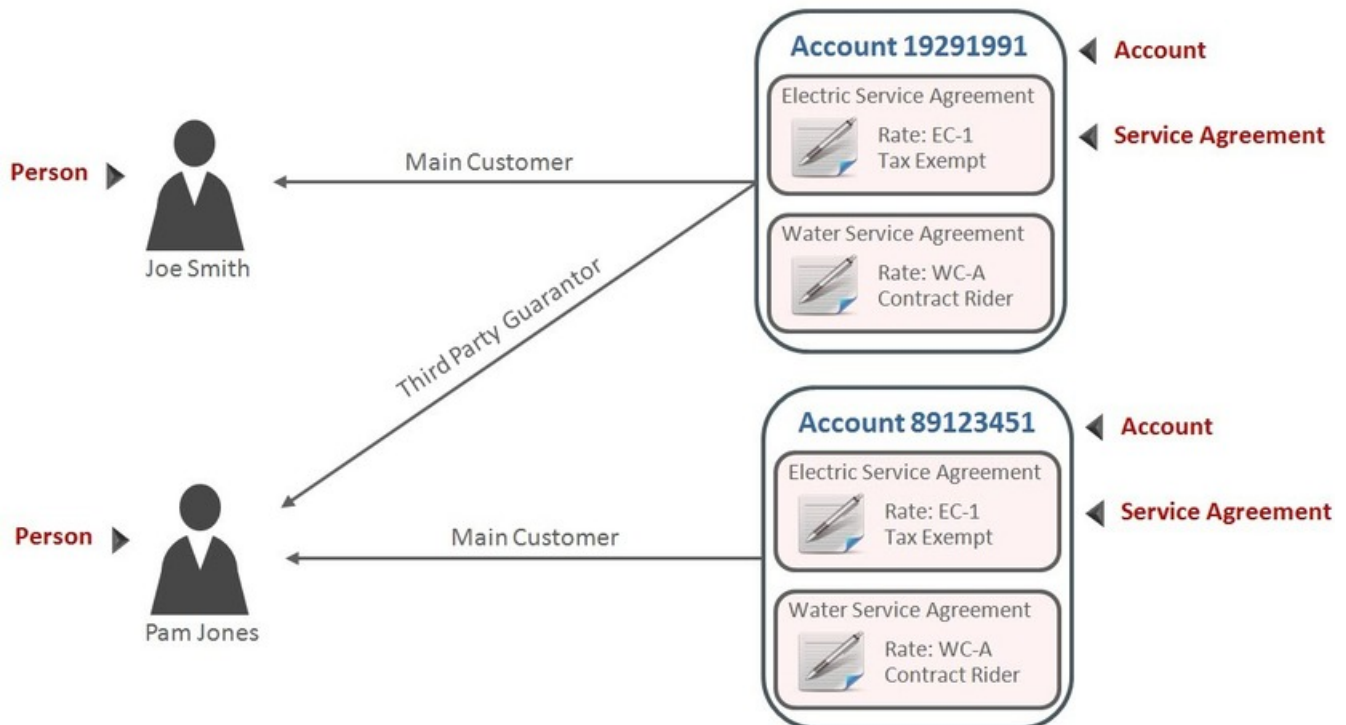

## Persons

Person records hold demographic information about the individuals and businesses with whom your organization communicates. Demographic information includes phone number(s), names and aliases, identification numbers, life support equipment needs, employment information, etc.

In the above example, 2 person records would be needed; one for Pam Jones and another for Joe Smith.

A new person is added when you first have contact with a person; the person does not have to be a customer before it is added. So, for example, if your company is starting a new marketing campaign, you can add information about potential customers the moment they are identified.

---

**NOTE:**

**Businesses are persons too.** In addition to humans, you use person records to maintain basic information about the businesses with which your organization has contact.

---

**FASTPATH:**

For a description of the control tables that must be set up before you can define a person, refer to [Setting Up Person Options](#).

---

## Accounts

An account is analogous to an account at a bank:

- A person or business with no financial dealings with a bank will have no account (but the bank may choose to keep demographic information about the person as part of their marketing efforts). The exact analogy exists in this system.
- Individuals with financial dealings with a bank will have one or more accounts. The number of accounts is up to the customer. The exact analogy exists in this system.

A simple way to determine the number of accounts a customer will have is to ask "how many bills do they want each period?" because a customer receives one bill for each account. For example:

- A residential customer who also owns a small business may choose to receive two bills each month; one for the residence, the other for the business. This way, the charges for their business would be segregated from their personal charges. This customer would have two accounts.
- A conglomerate that owns several factories may want their transportation gas charges to appear on a single bill rather than have a separate bill for each factory. This customer would have a single account.

## Account ID Is Non-Intelligent

The unique number of an account is referred to as the "account ID". You are probably very comfortable with this concept. You may, however, have difficulty dealing with the fact that the account id in this system has no intelligence built into it (e.g., many systems include the bill cycle and geographic location in the account id). In this system, the account ID is a random, system-assigned value.

Because the account ID contains no meaning, it can remain with a customer for life, regardless of where they live, when they are billed, the type of service they receive, etc. This is important because it means that all of the financial history linked to the account remains with the customer for life.

---

**NOTE:**

The non-intelligence of the account ID is also important from the perspective of the parallel processing that takes place when the system creates bills. Because the collection of accounts to be billed in any given bill cycle will be randomly

distributed through the number spectrum, the system can distribute account number ranges to parallel threads and each thread will process roughly the same number of accounts.

---

## Account / Person Cross-Reference

A person may be linked to zero or more accounts. A person won't be linked to an account when they have no financial relationship with your organization. A person will be linked to multiple accounts when they have financial relationships with more than one account.

An account must reference at least one person (i.e., the main customer), but may reference an unlimited number of individuals. Multiple persons are linked to an account when several parties have some type of financial relationship with the account (e.g., third party guarantors, account contact, bill copy recipients, etc.).

## When Is An Account Created?

A person can exist without an account until such time as the person formally requests the commencement of service. The moment the customer requests service, an account must be created (and the person must be linked to the account).

## When Is An Account Expired?

Accounts never expire. Once a customer has an account, the account remains in the system forever. Linked to the account are service agreements that define the price and conditions of a service supplied to the customer. When an account has active service agreements, the system produces bills for it. If the account doesn't have active service agreements, the system will not produce a bill for it. You can think of an account without active service agreements as being "dormant", waiting for the day when the customer again starts service. If the customer never restarts, the account (along with its financial history) remains dormant forever.

## Service Agreements

A service agreement is a contract (either formal or implied) between your organization and a customer. Every service agreement contains the price and conditions of a service supplied to a customer.

A service agreement is linked to an account. There is no limit to the number of service agreements that may be linked to an account.

## When Is A Service Agreement Created?

A service agreement is created when the customer requests service (not when service commences). Typically, service agreements are created in the pending state and field activities are generated to connect service. When the field activities are complete, the service agreement becomes active and the billing process starts generating bill segments for the service agreement.

---

### **FASTPATH:**

For more information about starting service, refer to [The Big Picture Of Starting Service](#). For more information about bill segments, refer to [Bill Details](#).

---

## Financial Transactions Are Linked To Service Agreements

---

### **FASTPATH:**

For more information about how financial transactions are linked to service agreements, refer to [The Financial Big Picture](#).

---

## When Is A Service Agreement Expired?

A service agreement is expired when the customer requests service be stopped. At that time, the service agreement is transitioned to the pending stop state and field activities are generated to stop service (these activities might involve simply reading the meter or they could involve disconnecting or removing the meter). When the field activities are complete, the system transitions the service agreement to the stopped state and the billing process generates a final bill for the service agreement. When the customer pays the final bill, the system transitions the service agreement to the closed state

---

### **FASTPATH:**

For more information about stopping service, refer to [The Big Picture Of Stopping Service](#).

---

## Setting Up Person Options

This section describes tables that must be set up before you can define persons.

## Setting Up Identifier Types

When you set up a person, you may define the various types of identification associated with the person, e.g., their driver's license number, their tax identity, etc. Every piece of identification associated with a person has an identification type. These identifier type codes are defined using **Admin > Customer > Identifier Type**.

---

### **NOTE:**

**How are person identifiers used?** The reason why identifiers are defined on a person is so that users you can look for a customer using one of their person identifiers (see [Control Central - Search Facilities](#) for more information). In addition, person identifiers help prevent duplicate persons from being added to the database. This is because the system warns a user before they add a new person when a person exists with the same identifier.

**Person identifier types are optional.** An [installation option](#) controls whether at least one identifier type is required on every person.

---

### **Description of Page**

Enter an easily recognizable **ID Type** and **Description** for the Identifier Type.

If the identifier type has a format against which validation can be performed, use **Identifier Format** to define the algorithm. To do this:

- Create a new algorithm (refer to [Setting Up Algorithms](#) ).
- On this algorithm, reference an Algorithm Type that validates identifier types. Click [here](#) to see the algorithm types available for this plug-in spot.

## Where Used

Follow this link to open the data dictionary where you can view the tables that reference [CI\\_ID\\_TYPE](#).

## Setting Up Person Relationship Types

It is possible to associate persons to other person. For example,

- You might want to define the subsidiaries of a parent corporation
- You might want to define spouses as separate persons and then link each person to another person

When you link a person to another person, you must define in what way the person is related to the other person by using a person relationship type code. These codes are defined using **Admin > Person Relationship Type**.

### Description of Page

Enter the following for each relationship type:

- Enter an easily recognizable **Relationship Type** code.
- Use **Description (Person1=>Person2)** to describe how the first person is related to the second person.
- Use **Description (Person2=>Person1)** to describe how the second person is related to the first person.

---

#### NOTE:

**Person1 versus Person 2.** When you link persons together, you do it in respect of one of the persons (which we call Person 1). For example, if you want to link the subsidiaries to a parent company, you do this in respect of the parent company (i.e., you define the parent company's subsidiaries using the [Person - Persons](#) transaction).

---

## Where Used

Follow this link to open the data dictionary where you can view the tables that reference [CI\\_PER\\_REL\\_TYPE](#).

## Setting Up Contact Routings

Base values for Contact Routing are supplied. You can add your specific contact routings using the **Contact Routing** extendable lookup. You can add more contact routings, but the ones supplied with the system cannot be edited or deleted.

---

**NOTE:** Person contacts that reference the CSS routing type cannot be added by a user, and are not permitted to be edited or deleted. As well, records with this contact routing are only visible in the Person - Main page and are not displayed in the Account Portal or other places in the system.

---

Refer to [Defining Extendable Lookups](#) and for more information on lookups.

If your implementation is using notification preferences, you may need to set up delivery types before setting up contact routings. Refer to [Setting Up Delivery Types](#) for more information.

## Setting Up Person Contact Status

Person contacts can have a status; for example, the status of an email contact could be pending, verified, or bounced. The product is delivered with statuses that are used in conjunction with opt-in functionality. When new person contacts are added, the initial status can be defaulted from the person contact type. See [The Person Contact Status Can Be Controlled By A Process](#), [System Person Contact Statuses](#) and [Opt-in Process](#) sections for more information.

Your implementation may choose to introduce other logic to update the status. See [The Person Contact Status Can Be Controlled By A Process](#) for more information. You can add your specific person contact statuses by updating the value for the CND\_VERIF\_STATUS\_FLG lookup field.

When new person contacts are added, the initial status can be defaulted from the person contact type. Refer to the Person Contact zone's help text for more information.

## Setting Up Person Contact Type Algorithms

### Format Validation

Person contact information can be subject to format validation such as ensuring a phone number is entered in a particular format.

Click [here](#) to see the algorithm types available for this system event.

The base product provides the algorithms [C1-VALEMFMT](#) (Validate Email Format), [C1-VALPHFMT](#) (Validate Phone Format), and [C1-VALANYFMT](#)(Any Format Valid), which your implementation may use (and if so, no further configuration is needed). If your implementation's business rules require additional format validation algorithms, you may introduce your own.

---

**NOTE:** These algorithms confirm that a specific format exists and do not reformat or apply formatting to the corresponding field; for example, the *C1-VALEMFMT* (Validate Email Format) algorithm confirms that the email address contains required features (such as an @ symbol and domain). It will not, however, insert these features.

---

If your implementation's business rules require additional format validation algorithms, you may introduce your own.

## Setting Up Person Contact Types

Person contact types define the format for entering person contacts and information about the person contact.

To set up contact types, select **Admin > Customer > Person Contact Type > Add**.

The [Person Contact Type portal](#) contains the following zones:

- [Person Contact Type List](#)
- [Person Contact Type Zone](#)

## Person Contact Type Portal

This section describes the zones associated to the Person Contact Type Portal:

- [Person Contact Type List](#)
- [Person Contact Type Zone](#)

## Person Contact Type List

The Person Contact List zone lists all person contact types. The following functions are available:

- Click a [broadcast](#) button to open other zones that contain more information about the adjacent person contact type.
- The standard actions of Edit, Delete and Duplicate are available for each person contact type.
- Click the Add link in the zone's title bar to add a new person contact type.

## Person Contact Type Zone

The Person Contact Type zone contains display-only information about the Person Contact Type. This zone appears when a Person Contact Type has been broadcast from the Person Contact Type List zone or if this portal is opened via drill down from another page.

Please see the zone's help text for information about this zone's fields.

### Where Used

Follow this link to open the data dictionary where you can view tables that reference [CI\\_PER\\_CONTDDET](#).

## Choosing to Use Person Contact or Person Phone

Person contact is an updated and more configurable alternative to person phone and email. In this release, a feature is introduced that some system processes use to determine if person contact or person phone and email is being used. Person phone and email are referred to as legacy behavior. Legacy behavior is enabled when the Legacy Person Phone and Email **Option Type** on the Customer Information Options is set to Y. When set to N or not set legacy behavior is not enabled.

If your implementation uses functionality that has not been updated to use the feature, such as campaigns and order, you may wish to enable legacy behavior and continue to use person phone and email. It is important to note that Person Contacts are required for notifications.

The following system processes have been updated to alter functionality based on whether legacy behavior is enabled or not.

System Process	Behavior When Feature is Not Set	Behavior When Feature is Set
Person	The Person Phone Grid and the Person Email field are not shown	The Person Phone Grid and the Person Email field are shown. Person Contact is always shown.
Person	The functionality to maintain person contacts from person phone is not triggered even when a person contact type is associated with a phone type.	The functionality to maintain person contacts from person phone is enabled.
Account/ Person	When an email or fax bill or quote route type is chosen, then information displayed is related to person contacts.	When an email or fax bill or quote route type is chosen, then information displayed is related to person phone or email.
Start/Stop	The Person Contact collection is shown and can be edited.	The Person Phone collection and Person Email are shown and can be edited.
Case	The Preferred Contact Methods associated with legacy person phone and email are not shown.	The Preferred Contact Methods associated with legacy person phone and email are available. Person Contact is always available.
Customer Contact	The Preferred Contact Methods associated with legacy person phone and email are not shown.	The Preferred Contact Methods associated with legacy person phone and email are available. Person Contact is always available.

## Person Contact Status Can Be Controlled By A Process

### Overview

Person contact types can be configured to allow a status. For some person contact types, your implementation may want to control the status through a process instead of allowing the status to be set manually. An example of this is using person contact status to capture opting in for receiving text messages, which is required in some jurisdictions. Opt-in is seeking permission from a customer to use a person contact for a purpose such as sending a customer text messages.

Opt-in works in conjunction with the functionality to enable opt-in for a delivery type. Each can function independently, but together they offer a complete solution. Since they can function apart from each other, each is described independently. See [Enabling Opt-in for a Delivery Type](#) for more detail on this logic.

To control a person contact status with a process, the person contact type must first be configured to allow status. The person contact type must then be set up in the opt-in section of the **Notification Preferences** [master configuration](#). By defining a Status Script, the person contact status can only be changed by the logic contained in or initiated from the script. The product is delivered with a script that creates an opt-in service task. This is designed specifically to support opting in to receiving notifications via text messages (SMS).

## Opt-In Process

To use the delivered functionality, configure a new service task type for opt-in. This task type should reference the Notification Preference Opt-In Task Type Business Object (C1-NotifPrefOptInTaskType). The product is delivered with a service task business object The service task is responsible for initiating an opt-in request, updating the person contact status, and logging the user response. An inbound web service receives responses and transitions the service task. These components are designed to integrate with Notification Center. When a customer is sent an opt-in request, they are asked to confirm. The content of the message explains the commands to the user. Examples are CONFIRM or STOP. Notification Center is configured to interpret the specific commands and map them to those expected by the inbound service, which transitions the service task appropriately.

Aside from the initial opt-in request, users can stop or unsubscribe from notifications at any time. The delivered solution supports two modes for this functionality: unsubscribing from all notifications for a particular person contact or unsubscribing from a specific notification type for a particular person contact. This is controlled through configuration, and relies on the external system such as Notification Center to determine the notification type.

The **Notification Preferences** [master configuration](#) help text contains detailed information about the configuration required to control person contact status and setting up opt-in processes.

It is important to note that while the delivered process to control person contact status was designed to work in conjunction with the opt-in process, your implementation can design a custom process that can create a service task or do something completely different. Also, it can be independent of opt-in and notifications. For example, the process can be used to verify that an email address is valid by sending the customer a verification request.

There is another concept, which is enabling opt-in for a delivery type. This is closely related to the functionality described here, but has different implications in the system. See [Enabling Opt-in for a Delivery Type](#) for more information.

There is a limitation worth noting. A person contact type may be set up to allow multiple delivery types, however the delivered solution only allows a single delivery type to be associated with the process used to automate person contact status. Without this limitation, different processes would be responsible for updating a single person contact status and those updates could be conflicting.

## The System Person Contact Statuses

The opt-in solution delivered with the product utilizes the three delivered status values. They are: **Pending**, **Approved**, and **Rejected**. Your implementation can add your own person contact statuses, but they will not work with the solution delivered with the product. See [Setting Up Person Contact Status](#).

## How the System Automates Person Contact Status

There are many ways that the process that controls person contact status can be invoked. For all of these, the person contact type must be set up in the **Notification Preferences** [master configuration](#) to have its status controlled by a process and, unless noted otherwise, the person contact is not already *Approved*.

- The primary way to initiate the process to control person contact status is when a person contact is used to add a contact preference and the contact preference's delivery type matches the delivery type associated with the person contact type as defined in the Notification Preferences master configuration. This method relies on enabling opt-in for a delivery type. This is how the two processes work with each other. See [Enabling Opt-in for a Delivery Type](#) for more information. An example of this scenario is that a person contact exists and is of a type that can receive text messages, such as "Mobile Phone". Until the person contact is used on a contact preference to receive a notification, there is no reason to initiate an opt-in process.



- This process can be automatically initiated by configuring a person contact to default to an initial status of *Pending*. When a person contact is added, the process is initiated. An example of this scenario is an email person contact initiating a process to verify the email address as soon as it is added to the system.
- When the value of an approved person contact is changed, the process is reinitiated. For example, even though the approval is attached to a specific person contact in the system, which has a unique ID, externally the approval was for a particular phone number or email address. When the person contact value (i.e. the phone number or email address) is changed, the prior approval is no longer valid. The person contact status is changed to *Pending*.

A user can manually initiate the process. A button is provided on the Person Contact row on Person - Main. The button can be used to reinitiate the process when the customer does not have the request and needs it resent. It can also be used to manually initiate the process upfront - before the person contact is used on a contact preference.

## Maintaining Person Contact via Person Phone

Person phone is referenced extensively throughout the system. All system processes have been updated to determine if phone data and email data is being maintained on person contacts or being maintained on person phone and email. See [Choosing to Use Person Contact or Person Phone](#) for more information.

To keep person contacts records in sync with a person phone, you should consider which phone types should be stored as contacts, configure the person contact type corresponding to each phone type, and update the person contact type to reference the corresponding phone type. Many phone types may be associated with a single person contact type, but a single phone type may only be associated with one person contact type.

The base product provides a batch process [C1-INPUS](#) (Create Person Contact from Person Phone/Email) that creates a person contact for all person phone records whose phone type is associated with a person contact type. The batch process can also create person contact records for the email address on the person. You would run this process to create person contact records if you already have phone or email data for persons, and you wanted to start leveraging person contact as the repository for phone and email information. See the batch process description for more information.

---

### NOTE:

There is a primary switch on person contact records; one person contact for each unique contact routing must be set as the primary contact. When the batch process creates person contacts from person phone data, the first person contact added for each unique contact routing is set as primary. This can be controlled to some extent by your implementation by associating phone types with person contact types sequentially and running the batch process multiple times. For example, you may prefer that a home phone be the primary over a cell phone if both exist. To ensure this happens, associate the home phone with a person contact type and run the batch process. Then associate the cell phone with a person contact type and run the batch process again. This will force all home phone records to be processed first. It is recommended that regardless of how many times the batch processes run, they are run back to back. This should be thought of as a conversion of data and should be treated as such.

---

When a phone type is associated with a person contact type the following occurs:

- When a phone record is added, a corresponding person contact is added if one does not already exist.
- When a phone record is updated, corresponding updates are made to the person contact.
- When a phone record is deleted, the system tries to delete the corresponding person contact. All business rules for person contacts are enforced. If the person contact is associated with a contact preference, the person contact cannot be deleted, and in turn the phone record cannot be deleted.
- Person contacts associated with phone types cannot be deleted directly. The delete function is disabled.
- Contact information on person contacts associated with phone types cannot be updated directly. The contact information and extension are disabled.
- Person contacts whose person contact type is associated with a phone type cannot be added from the account contact information zone in the account portal. These need to be added through person phone.

There is no direct association between a person phone record and person contact (i.e. there are no foreign keys on either record pointing to the other). The system uses the association between phone type and person contact type and the specific phone number in order to find the associated person contact.

Your implementation may decide to use person contacts to store phone data and not associate them with phone types. Functionality related to the system use of person phone will not be available such as updating a phone number through an order.

If your implementation associates phone types with person contact types and wishes to remove this association, it is best to remove all phone types from all person contact types.

---

**WARNING:** Making changes to the association of phone type to person contact type can have serious implications for your data. Changing the person contact type associated to a phone type will likely result in difficulty maintaining both person phone and person contact data.

---

## Setting Up Statement Construct Options

This section describes tables that must be set up before a statement construct can be set up for a person to begin receiving financial statements.

---

**FASTPATH:**

For more information, refer to [The Big Picture of Complex Statements](#).

---

## Setting Up Statement Route Types

Statement route types define the method used to route statements to persons. To define a statement route type, open **Admin > Billing > Statement Route Type**.

### Description of Page

Enter a unique **Statement Route Type**, **Description** and **Statement Routing Method** for every statement route type.

---

**NOTE:**

The values for Statement Routing Method are customizable using the Lookup table. This field name is STM\_RTG\_METH\_FLG.

---

The next two fields control how statements that are routed using this route type are printed (both in batch and online). Refer to [Technical Implementation Of Batch Statement Production](#) for more information about producing statements in batch. Refer to [Technical Implementation Of Online Statement Production](#) for more information about online statement production.

- Use **Batch Control** to define the process that creates the flat file that is passed to your statement printing software. If you use an **Extract Algorithm** to construct the downloaded information, you can use the STMDWLD process.
- Use **Extract Algorithm** to define the plug-in component that constructs the "flat file records" that contain the information to be merged onto statements routed using this route type. This algorithm is called when a user requests an online image of a statement on [Statement - Main](#) and it may also be called by the batch statement extraction process defined above. Click [here](#) to see the algorithm types available for this plug-in spot.

### Where Used

Follow this link to open the data dictionary where you can view the tables that reference [CI\\_STM\\_RTE\\_TY](#).

## Setting Up Account Options

This section describes tables that must be set up before an account can receive a bill.

## Setting Up Account Management Groups

Users are informed that something requires their attention by entries that appear in To Do lists. For example, consider what happens when billing can't find a reading (and it's not allowed to estimate):

- The billing process creates a bill segment that is in error - meter read cannot be found.
- This error bill segment, in turn, triggers the creation of a To Do entry.
- The To Do entry is addressed to a role. A role is one or more users who can "action" the To Do entry.
- When a user views their To Do entries, they see all entries addressed to all roles of which they are part.

You can optionally use account management groups (AMG) to define the respective role to be assigned to To Do entries that are associated with an account and a given To Do type. For example, you can create an AMG called Credit Risks and assign this to accounts with suspect credit. Then, whenever an account-oriented To Do entry is created for such an account, it will be assigned a role based on the Credit Risks AMG. Refer to [Assigning A To Do Role](#) for more information..

---

**NOTE:**

**Account management groups are optional.** You need only set up account management groups (and link them to accounts) if you wish to address specific To Do entries associated with specific accounts to specific roles.

---

Account management groups are defined using **Admin > Customer > Account Management Group > Add.**

### Description of Page

Enter an easily recognizable **Account Management Group** code and **Description** for each account management group. Use the grid to define the **To Do Role** to be assigned to entries of a given **To Do Type** that are associated with accounts that reference the **Account Management Group**.

---

**NOTE:**

Only To Do entries that are account-oriented take advantage of the roles defined for an account management group (because only accounts reference an account management group).

---

### Where Used

Follow this link to view the tables that reference [CI\\_ACCT\\_MGMT\\_GR](#) in the data dictionary schema viewer.

## Setting Up Account Relationship Codes

When you link a person to an account, you must define in what way the person is related to the account by using an account relationship code. These codes are defined using **Admin > General > Account Relationship Type**.

### Description of Page

Enter an easily recognizable **Relationship Type** and **Description** for each relationship type.

### Where Used

Follow this link to open the data dictionary where you can view the tables that reference [CI\\_ACCT\\_REL\\_TYP](#).

## Setting Up Alert Types

Account based alerts that appear in control central have an **AlertType**. To define valid alert types, navigate to **Admin > Customer > Alert Type**.

### Description of Page

Enter an easily recognizable **Alert Type Code** and **Description** for each alert type. Specify the **Alert Days** to indicate the amount of time that alerts of this type will be effective by default. Specify a value of zero to indicate that alerts of this type will be effective indefinitely by default.

### Where Used

Follow this link to open the data dictionary where you can view the tables that reference [CI\\_ALERT\\_TYPE](#).

## Setting Up Bill Messages

There are various informational and warning messages that may appear on an account's bills. Each message is identified with a bill message code. To define a bill message code, open **Admin > Billing > Bill Message > Add**.

### Description of Page

Enter a unique **Message Code** and **Description** for every bill message.

The following attributes control how and where the bill message appears on the customer's bill:

**Priority** controls the order in which the message appears when multiple messages appear on a bill.

---

#### NOTE:

The values for this field are customizable using the Lookup table. This field name is MSG\_PRIORITY\_FLG.

---

**Insert Code** controls whether a document should be inserted into the bill envelope when the bill message appears on a bill.

**Message on Bill** is the actual verbiage that appears on the customer's bill. If the message text is not static (e.g., field values need to be substituted into the body of the message), you can use the % *n* notation within the **Message on Bill** to cause field values to be substituted into a message. Refer to [Substituting Field Values Into A Bill Message](#) for more information.

### Where Used

Follow this link to open the data dictionary where you can view the tables that reference [CI\\_BILL\\_MSG](#).

## Setting Up Bill Route Types

Bill route types define the method used to route bills to accounts. To define a bill route type, open **Admin > Billing > Bill Route Type**.

### Description of Page

Enter a unique **Bill Route Type** and **Description** for every bill route type.

**Bill Routing Method** controls the type of information that may be defined when the respective **Bill Route Type** is selected on [Account - Person Information](#). The following options are available:

- Postal: Use this method if the routing is via the postal service.
- Fax: Use this method if the routing is via fax.

- Email: Use this method if the routing is via email.

---

**NOTE:**

The values for **Bill Routing Method** are customizable using the [Lookup](#) table. This field name is BILL\_RTG\_METH\_FLG.

---

The next two fields control how bills that are routed using this method are [printed](#) (both in batch and online).

- Use **Batch Control** to define the background process that performs the actual download of the billing information. Refer to [Technical Implementation of Printing Bills In Batch](#) for more information about these processes.
- Use **Extract Algorithm** to define the algorithm that constructs the records that contain the information that appears on a printed bill. Refer to [Printing Bills](#) for more information.

**Where Used**

Follow this link to open the data dictionary where you can view the tables that reference [CI\\_BILL\\_RT\\_TYPE](#).

## Setting Up Bill Cycles

---

**FASTPATH:**

Refer to [Defining Bill and Measurement Cycles](#) for a description of how to set up bill cycles.

---

## Setting Up Customer Classes

When you set up an account, you must assign it a customer class. The topics in this section describe the customer class control table.

### Customer Class - Main

To set up customer classes, navigate to **Admin > Customer > Customer Class > Add** and use the **Main page** to define your Customer Class.

**Description of Page**

Enter a unique **Customer Class** code and **Description** for every customer class.

Use **Collection Class** to define the collection class that defaults onto new accounts that belong to this customer class. An account's collection class may be subsequently modified if the account has special collection problems or needs.

---

**FASTPATH:**

For more information about the significance of collection class, refer to [Designing Your Collection Classes](#).

---

Turn on **Business Activity Required** if service agreements linked to accounts with this customer class require a Business Activity description to be entered.

Turn on **Open Item Accounting** if accounts belonging to this customer class are subject to open-item account. Refer to [Open Item Accounting](#) for a complete explanation of the significance of this switch.

Turn on **Non CIS Payment** if accounts belonging to this customer class are used for payments made to reduce non-CIS debt. For example, assume your company accepts payments for a county assessor and you don't want to set up a separate

account for each person who pays their assessment bill. You should set up the following information to accept such payments:

- Create a new customer class called "Non CIS Customer".
- Create a SA type for each type of non-CIS payment that customers can make. Make sure to enter a distribution code on each SA type that references the appropriate revenue (or payable) account. Don't forget to indicate that each SA type is not billed.

---

**NOTE:**

Payment Templates can be used for common types of non-CIS payment allocations. These templates are used to default the payment distribution and allow non-CIS payments to be directly allocated to specific distribution codes.

---

**FASTPATH:**

For more information about using Payment Templates to process non-CIS payments, refer to [Non-CIS Payments](#).

---

- Create an account to which you'll book such payments. Have this account reference the new customer class. We recommend creating a separate account for each SA type that you created in the previous step.
- Create and activate a service agreement for the new account(s).

When someone pays for non-CIS debt, the operator will add a payment for the above account. On the payment, the operator should record reference information in order to know exactly why the payment was made. Refer to [Payment Event - Main](#) for more information.

You must define a variety of business rules for every division in which a customer class has customers. For example, if you operate in both California and Nevada AND you have CIS divisions for each state AND you have residential customers in each state, you must define **Customer Class Controls** for each CIS division. You do this on the [Customer Class - Controls](#) page. The grid that follows simply shows the CIS divisions for which business rules have been set up.

**Where Used**

Follow this link to open the data dictionary where you can view the tables that reference [CL\\_CUST\\_CL](#).

## Customer Class - Bill Messages

When a customer class has bill messages, the system will sweep these messages onto bills created for accounts belonging to the customer class. Use this page to define a customer class's bill messages. Navigate to **Admin > Customer > Customer Class > Search** and then navigate to the **Bill Messages** page to maintain this information.

**Description of Page**

Use the bill messages collection to define **Bill Message** codes that should appear on bills that created for accounts that belong to a given customer class. For each message, also specify the **Start Date** and **End Date** when such a message should appear on the bill (leave **End Date** blank if the message should appear indefinitely).

**Where Used**

The system snaps customer class bill messages on a bill during bill completion. For more information about bill messages, refer to [The Source Of Bill Messages](#).

## Customer Class - Controls

You must define a variety of business rules for every division in which a customer class has customers. For example, if you operate in both California and Nevada AND you have CIS divisions for each state AND you have residential customers in each state, you must define **Customer Class Controls** for each CIS division in respect of the residential customer

class. Open **Admin > Customer > Customer Class > Search** and then navigate to the **Controls** page to maintain this information.

### Description of Page

The **Customer Class Controls** scroll contains business rules governing accounts that belong to a **CIS Division** and **Customer Class**. The following fields should be defined for each **CIS Division**:

- Use **Days Till Bill Due** to define the number of days after the bill date that the customer's bill is due. If the due date is a weekend or company holiday, the system will move the due date forward to the next workday (using the workday calendar defined on the account's CIS division).
- Specify the **Budget Plan** that defaults onto new accounts belonging to this customer class. Please note that an account's budget plan may be subsequently modified if the account has special budget processing needs. Refer to [Setting Up Budget Plans](#) for more information.
- Use **Min Credit Review Freq (Days)** to define the maximum number of days that can elapse between the reviews of an account's debt by the [account debt monitor](#). Note, a value of zero ( 0 ) means that accounts in this customer class will be reviewed every day.
- Use **Credit Review Grace Days** to define the number of days after the bill due date that an account should be reviewed by the [account debt monitor](#).
- Turn on the **Late Payment Charge** if customers in the class / division combination are eligible for late payment charges.
- Use **LPC Grace Days** to define the number of days after a bill's due date that a late payment charge will be generated (if the various LPC algorithms allow such - refer to [How Late Payment Charges Get Calculated](#) for the details). If the grace date falls on a weekend or holiday, the system moves the grace date to the next available workday (using the workday calendar defined on the account's CIS division).
- Specify an **Access Group** to default an access group onto an account based on the account's CIS Division and customer class. This will override the access group defaulted from the user's default access group. Note: the access group defined here will not apply if a Customer Class Control - Determine Access Group algorithm is defined and successfully returns an access group.

The grid that follows contains **Algorithms** that control important functions in the system. You must define the following for each algorithm:

- Specify the **System Event** with which the algorithm is associated (see the table that follows for a description of all possible events).
- Specify the **Sequence** and **Algorithm** for each system event. You can set the **Sequence** to 10 unless you have a **System Event** that has multiple **Algorithms**. In this case, you need to tell the system the **Sequence** in which they should execute.

#### WARNING:

These algorithms are typically significant system processes. The absence of an algorithm may prevent the system from operating correctly.

You can define algorithms for the following **System Events**:

System Event	Optional / Required	Description
Auto Pay Amount Over Limit	Optional	<p>This algorithm is called to handle the situation when a system-initiated <a href="#">automatic payment</a> is created that exceeds the customer's <a href="#">maximum withdrawal limit</a>. Specifically, this algorithm is called when:</p> <ul style="list-style-type: none"> <li>- The account has a maximum withdrawal limit on their <a href="#">automatic payment options</a></li> <li>- The system attempts to create an automatic payment that exceeds this amount</li> </ul>

- The automatic payment algorithm that's plugged into the [installation record](#) has logic that invokes this algorithm when the above conditions are true

If you do not plug-in this type of algorithm and the above situation is detected, the automatic payment will be created and no error will be issued.

Refer to [How To Implement Maximum Withdrawal Limits](#) for more information.

Click [here](#) to see the algorithm types available for this system event.

---

Bill Completion	Optional	<p>When a bill for an account is completed, bill completion algorithms are called to do additional work.</p> <p>Refer to the description of the Complete button under <a href="#">Bill Lifecycle</a> for a description of when this algorithm is called during the completion process.</p> <p>Click <a href="#">here</a> to see the algorithm types available for this system event.</p>
Bill Eligibility	Optional	<p>Algorithms for this plug-in spot are called when generating a bill in batch billing. It provides the ability to determine if an account is ineligible for billing and should therefore be skipped from further processing.</p> <p>If an eligibility algorithm is not used, a bill is created for any account in the open bill cycle and is later deleted by the billing process if it detects that there is no information linked to the bill.</p> <p>Click <a href="#">here</a> to see the algorithm types available for this system event.</p>
Bill Segment Freeze/Cancel	Optional	<p>When a bill segment for an account in this customer class / division is frozen or canceled, an algorithm of this type may be called to do additional work.</p> <p>Refer to <a href="#">Bill Segment Lifecycle</a> for more information about freezing and canceling bill segments.</p> <p>Click <a href="#">here</a> to see the algorithm types available for this system event.</p>
Cancel Bill	Optional	<p>This algorithm provides the ability to include additional cancel logic when canceling online.</p> <p>Algorithms of this type can be called in two modes: D (Determine Bill Page Buttons) and X (Cancel Bill). Mode 'D' governs whether an action button to cancel the bill will appear on the Bill page and mode 'X' performs the actual cancellation logic.</p>

---



		Click <a href="#">here</a> to see the algorithm types available for this system event.
Determine Access Group	Optional	<p>When an account is added or an account's CIS Division or customer class is changed, this plug-in spot can be used to determine the appropriate access group. This plug-in spot allows more complex logic to be defined, such as checking the access group on the main person's others account's.</p> <p>If a determine access group is not used, the access group can be defaulted from the customer class control or the user.</p> <p>Click <a href="#">here</a> to see the algorithm types available for this system event.</p>
FT Freeze	Optional	<p>When an FT is frozen, this algorithm is called to do additional work.</p> <p>For example, if you practice <a href="#">Open Item Accounting</a>, you will need such an algorithm to handle the cancellation of match events when a financial transaction is canceled that appears on a match event. Refer to <a href="#">How Are Match Events Cancelled?</a> for more information about cancellation.</p> <p>Click <a href="#">here</a> to see the algorithm types available for this system event.</p>
LPC Eligibility	Required if the customer class / division is eligible for late payment charges	<p>This algorithm is called by the late payment process to determine eligibility for late payments.</p> <p>Just because an account's customer class allows late payment charges to be calculated doesn't mean the account's delinquent service agreements will be levied late payment charges. In addition, a delinquent service agreement's SA type must reference a late payment charge algorithm. Refer to <a href="#">SA Type - Main</a> for more information about SA type late payment charge issues. Refer to <a href="#">How Late Payment Charges Get Calculated</a> for more information about late payment charges in general.</p> <p><b>NOTE:</b>  <b>Only One Algorithm.</b> Only one late payment charge eligibility algorithm may be defined for a customer class / CIS division combination.</p> <p>Click <a href="#">here</a> to see the algorithm types available for this system event.</p>

Levy NSF Charge

Optional

This algorithm is called when a payment is canceled with a cancellation reason that indicates an NSF.

Refer to [NSF Cancellations](#) for more information about what happens when a payment is canceled due to non-sufficient funds.

**NOTE:**

**Only One Algorithm.** Only one algorithm to levy an NSF charge may be defined for a customer class / CIS division combination.

Click [here](#) to see the algorithm types available for this system event.

---

Order Completion

Optional

When an [order](#) is completed for a customer linked to this customer class, this algorithm is called to do additional work (e.g., create a customer contact). You need only specify this type of algorithm if you require additional work to be performed when an order is completed for customers who belong to this customer class.

Click [here](#) to see the algorithm types available for this system event.

---

Overpayment Distribution

Required

When a customer pays more than they owe, this algorithm is called to determine what to do with the excess funds. Refer to [Overpayment Segmentation](#) for a description on how to configure the system to handle your overpayment requirements.

**NOTE:**

**Only One Algorithm.** Only one overpayment distribution algorithm may be defined for a customer class / CIS division combination.

Click [here](#) to see the algorithm types available for this system event.

---

Override Due Date

Optional

An account's bill due date will be equal to the bill date plus its customer class' Days Till Due. If you need to override this method for accounts in a specific customer class, specify the appropriate algorithm here.

**NOTE:**

**Only One Algorithm.** Only one due date override algorithm may be defined for a customer class / CIS division combination.

Click [here](#) to see the algorithm types available for this system event.

---

Payment Cancellation	Optional	<p>Algorithms of this type are called when a payment is canceled.</p> <p>Click <a href="#">here</a> to see the algorithm types available for this system event.</p>
Payment Distribution	Required	<p>This algorithm is called to distribute a payment amongst an account's service agreements. Refer to <a href="#">Payment Distribution</a> for more information about how payment distribution works.</p> <p><b>NOTE:</b>  <b>Only One Algorithm.</b> Only one payment distribution algorithm may be defined for a customer class / CIS division combination.</p> <p>Click <a href="#">here</a> to see the algorithm types available for this system event.</p>
Payment Freeze	Optional	<p>When a payment is frozen, this algorithm is called to do additional work. If you practice <a href="#">Open Item Accounting</a>, you will need such an algorithm to link the payment's financial transactions to the match event that was originally created when the payment was distributed. Refer to <a href="#">Payments and Match Events</a> for more information.</p> <p>Click <a href="#">here</a> to see the algorithm types available for this system event.</p>
Post Bill Completion	Optional	<p>When a customer class has algorithms of this type, they are called after the completion of a bill for an account linked to this customer class.</p> <p>Refer to the description of the Complete button under <a href="#">Bill Lifecycle</a> for a description of when this algorithm is called during the completion process.</p> <p>Click <a href="#">here</a> to see the algorithm types available for this system event.</p>
Pre Bill Completion	Optional	<p>When a customer class has algorithms of this type, they are called immediately before completion starts for an account linked to this customer class. These algorithms have the potential of:</p> <ul style="list-style-type: none"> <li>• Deleting a bill. You might want a pre completion algorithm to delete a bill if a condition is detected that should inhibit the sending of a bill to a customer (e.g., the bill just contains information about recent payments).</li> <li>• Aborting the completion process and creating a bill exception. If the algorithm</li> </ul>

indicates this should be done, the bill is left in the pending state and a bill exception is created describing why completion was aborted. You might want a pre completion algorithm to do this if, for example, integrity checks detect there is something wrong with the account or its service agreements. If the integrity check fails, the bill can be left in the pending state and a bill exception created describing why.

Refer to the description of the Complete button under [Bill Lifecycle](#) for a description of when this algorithm is called during the completion process.

Click [here](#) to see the algorithm types available for this system event.

Quote Completion	Optional	<p>When a <a href="#">quote</a> is completed for a customer linked to this customer class, this algorithm is called to do additional work (e.g., create a customer contact). You need only specify this type of algorithm if you require additional work to be performed when a quote is completed for customers who belong to this customer class.</p> <p>Click <a href="#">here</a> to see the algorithm types available for this system event.</p>
Write Off Method	Required if you allow users to write-off debt real time using the <a href="#">write off transaction</a>	<p>When a user presses the create button on the <a href="#">write off transaction</a>, this algorithm is executed to write-off the selected debt. Refer to <a href="#">The Ramifications of Write Offs in the General Ledger</a> for more information.</p> <p>Click <a href="#">here</a> to see the algorithm types available for this system event.</p>

## Setting Up Collection Classes

### FASTPATH:

Refer to [Setting Up Collection Classes](#) for a description of how to set up collection classes.

## Setting Up Customer Information Options

When you add a new person, the system is set up by default to add an account for the person and go to the Start Service page when you save the new person information. You can change this functionality by configuring the following option types on the Customer Information Options feature configuration:

- **Add Account and Start Service Default:** Indicates whether the Add Account and Start Service option is selected on the person page, by default. If this option is not configured, the Add Account and Start Service option is selected by default.

- **Post Add Person BPA Script:** Indicates a BPA script to invoke when a user successfully adds or changes a person on the person page.

When you use control central to search for accounts, the system limits your search results based on your access rights. You can change this functionality by configuring the following option type.

- **Search All Accounts:** Indicates whether a Control Central search should allow a user to search all accounts without validating the user's access rights. If the user tries to select an account without having the required access, they will not be able to navigate to the Account Information tab on Control Central for the selected account.

For more information about Feature Configurations, see [Defining Feature Configurations](#).

## Setting Up Customer Contact Options

This section describes tables that must be set up before you can define customer contacts.

---

### FASTPATH:

Refer to [The Big Picture Of Customer Contacts](#) for more information about customer contacts.

---

## Setting Up Customer Contact Classes

Every customer contact record has a contact type that classifies the record for reporting purposes. And every contact type, in turn, references a customer contact "class". The class categorizes customer contacts into larger groupings for reporting purposes.

Open **Admin > Customer > Customer Contact Class** to define your customer contact classes.

### Description of Page

Enter a unique **Contact Class** and **Description** for each customer contact class.

After you have created your customer contact classes, you'll be ready to setup your [customer contact types](#).

### Where Used

Follow this link to open the data dictionary where you can view the tables that reference [CI\\_CC\\_CL](#).

## Setting Up Customer Contact Types

Every customer contact record has a contact type that controls the behavior of the customer contact.

---

### FASTPATH:

Refer to [The Big Picture Of Customer Contacts](#) for more information about customer contacts.

---

Open **Admin > Customer > Customer Contact Type > Add** to define your customer contact types.

### Description of Page

Every customer contact type is identified by a unique combination of **Contact Class** and **Contact Type**.

Enter a brief **Description** of the customer contact type.

Only specify a **Contact Shorthand** if customer contacts of this type can be added in the [Customer Contact Zone](#). The value you specify in this field is what the user selects to add a customer contact in this zone.

If your implementation requires restricting customer contact types by CIS Division, specify a **CIS Division** on the customer contact type.

**Person Usage** controls the applicability of a person on customer contacts of this type. Select **Required** if a person must be defined on this type of customer contact. Select **Optional** if a person can optionally be defined on this type of customer contact. Select **Not Allowed** if a person is not allowed on this type of customer contact.

**Account Usage** controls the applicability of an account on customer contacts of this type. Select **Required** if an account must be defined on this type of customer contact. Select **Optional** if an account can optionally be defined on this type of customer contact. Select **Not Allowed** if an account is not allowed on this type of customer contact.

**Premise Usage** controls the applicability of a premise on customer contacts of this type. Select **Required** if a premise must be defined on this type of customer contact. Select **Optional** if a premise can optionally be defined on this type of customer contact. Select **Not Allowed** if a premise is not allowed on this type of customer contact.

---

**NOTE:**

Person usage and premise usage cannot both be set to not allowed, as the customer contact must at least one of them. Account usage is dependent on person usage.

---

**Entity Relationship** controls the validation of relationships on customer contacts of this type. **All** ensures that the account belongs to the person and that the account and premise are related. **Person and Account Only** disables the account and premise validation. **Premise and Account Only** disables the person and account validation. **None** disables all validation and allows any values. This setting only impacts the validation of values entered and works in conjunction with the three usage fields described above.

Use **Contact Action** if something should be triggered when customer contacts of this type are added. The only valid value in this release is Send Letter. If you select this option, you must also specify a **Letter Template**. Refer to [Printing Letters](#) for more information about how letters are produced.

Use the **Customer Contact Type Characteristics** collection to define characteristics that can be defined for contacts of a given type. Use **Sequence** to control the order in which characteristics are defaulted. Turn on the **Required** switch if the **Characteristic Type** must be defined on customer contacts of a given type. Turn on the **Default** switch to default the **Characteristic Type** when customer contacts of the given type are created. Enter a **Characteristic Value** to use as the default for a given **Characteristic Type** when the **Default** switch is turned on.

#### Where Used

Follow this link to open the data dictionary where you can view the tables that reference [CI\\_CC\\_TYPE](#).

## Setting Up Notification Preference Options

The topics in this section provide background information about notification preferences.

### Notification Preferences Overview

The Notification Preferences functionality is comprised of two main components: sending messages out of the system and maintaining customers' communication preferences for receiving these messages.

Notifications are created by an algorithm plugged into the Create Notification plug-in spot on the Notification Type (BO). Click [here](#) to see the algorithm types available for this system event. The base product provides the **CI-CRE-NTF** algorithm, which creates the notification via an outbound message.

The following sections describe specific notification preference concepts and how to configure the system to use notification preferences.

## Push vs. Subscription Notification Types

Notification types are defined as either push – which means that a customer need not sign up to receive notifications of this type, or subscription – which means that a customer must sign up to receive this type of notification. As you can tell, they have different uses and different behaviors.

Push notification types allow users to specify communication preferences for a general type of notification. These preferences include contact preferences and opt-out preferences, which are applied to individual notifications belonging to the general type. For example, “marketing” may be the general type, and the individual notification types may include several different types of marketing notifications that contain different messages and are targeted at different channels. Refer to [Parent vs. Individual Push Notification Types](#) for more information.

In the absence of any contact preference or opt-out preference, push-based notifications can determine a default contact and send the notification using it. The logic to determine a default contact is defined via an algorithm plugged into the Determine Default Contact plug-in spot on the Notification Type (BO). Click [here](#) to see the algorithm types available for this system event. The base product provides the [C1-NTF-DFPRF](#) (Determine Default Contact for Notification Type) algorithm, which looks to retrieve a default contact from the account’s main person.

Subscription notification types define a particular notification and its message. Customers must have an active contact preference to receive these notifications. Subscription-based notification types can use an underlying service task. Refer to [Some Notification Types Use Service Task](#) for more information. A subscription-based notification type can also be set up to allow routing of bills or quotes to multiple destinations.

## Parent vs. Individual Push Notification Types

Push notification types are configured as either a parent or individual notification type. An individual notification type references a parent notification type; a parent cannot reference another parent. Customers define communication preferences for parent push notification types. Notifications are sent out for individual push notification types. The preferences defined for parent push notification types are applied to the associated individual push notification types.

This means that customers do not have to supply their preferences for every individual notification that your implementation may send. Storing customer preferences for a parent notification type permits those preferences to be inherited for individual notification types added later in time under the same parent. The parent push notification types can be thought of as categories of notifications for which your customers define contact preferences and opt-out preferences.

When system processes or your custom processes attempt to send out a push notification, it should be for an individual notification type. The system will retrieve the parent notification type from the individual notification type when checking for communication preferences.

One function available to push-based notifications as described in [Push vs. Subscription Notification Types](#) is the ability to determine a default contact in the absence of a contact preference or opt-out preference. If your implementation wants to take advantage of this function, but would like the customer to supply preferences for receiving an individual notification, a parent push notification type can be set up with only one individual push notification type.

## Delivery Type

Delivery Type is the channel used to send a notification. Examples are email, text message (SMS), fax, and outbound IVR. Delivery type is used throughout notification preferences. If your implementation is not using notification preferences, you would not utilize delivery type.

- Notification types list the supported delivery types. For example, a bill ready notification type may support email and SMS while a notification type to encourage customers to enroll in a budget plan may only support email. The message subject and body are configured for each notification type’s supported delivery type.

- Person contact types list the allowable delivery types. For example, a cell phone person contact type may allow SMS while a home phone person contact type may not allow any delivery types. An email person contact type would allow an email delivery type unless the person contact type exists to capture a customer's email address and not to be used in conjunction with notification preferences. Note: the delivery types that can be specified on a person contact type are restricted to those defined on the person contact types contact routing. Refer to [Setting Up Contact Routings](#) for more information.
- A contact preference for a customer consists of the combination of notification type, delivery type, and person contact.

## Enabling Opt-In for a Delivery Type

### Overview

Opt-in can be enabled for a delivery type and is configured using the [Notification Preferences master configuration](#); for example, opt-in can be enabled for SMS, but not email.

To help clarify some terminology, as explained in [Person Contact Status Can Be Controlled by a Process](#), the product is delivered with a process that initiates a service task to request opt-in or permission to use a person contact. This solution requires that opt-in is enabled for the delivery type associated with the person contact type. In this regard, the two concepts are intertwined, but enabling opt-in for a delivery type can function independently.

Enabling opt-in is centered on the person contact status, while the process that controls the status can vary; therefore, it is possible to use enable opt-in for a delivery type while manually controlling the person contact status. Enabling opt-in for a delivery type has two key impacts system behavior.

- When a contact preference is added and the delivery type is enabled for opt-in, there is logic that checks if the person contact associated with the contact preference is in the *Approved* status. If it is not, and the person contact type is associated with a process to control the status, that process is initiated. If the person contact type is not associated with a process to control its status, a To Do Entry is created. The To Do Type is configured on the [Notification Preferences master configuration](#). The system is delivered with To Do Type Opt-In Errors ([C1-OPTIN](#)) for this purpose.
- Notifications will not be delivered to person contacts that are not *Approved*. When a system process initiates an outbound notification based on an active preference, if the person contact associated with the contact preference is not *Approved*, a flag is set in the notification indicating that it should not be delivered. It is up to the receiving system, such as Notification Center, not to deliver the notification based on this flag. This is designed so that a record of the notification being generated is still captured. Also the [C1-NTF-DFPRF](#) (Determine Default Contact for Notification Type) will not choose a person contact that is not approved.

The [Notification Preferences master configuration](#) help text contains detailed information about the configuration required to enable opt-in for a delivery type.

## Some Notification Types Use Service Task

Prior to the introduction of notification preferences functionality, the system supported notifications set up through self-service. These notifications used service tasks to store customer preferences and in some cases trigger notifications. The destination information for the notification existed outside of the system. Notification preferences, and more particularly communication preferences, define the user's preferences on how to be notified for each notification type and where the notification is to be sent. This reduces, but does not eliminate, the need to use a service task to store a customer's preference. These service tasks will not contain the self-service information when created internally by the system

There are four existing notification types that rely on service tasks to trigger a notification. Additionally, one of the prepaid notifications uses a service task type business object with specific fields for that notification type. Refer to [Designing Notification Types](#) for information regarding the configuration requirements for certain notification types.

Notification Preferences supports configuring notification types with or without a service task and only subscription-based notification types can be configured with an underlying service task.



## Designing Notification Types

Some notification types require a specific configuration in order for the system to create notifications for that type.

### Service Task Based Notification Types

There are system processes that rely on a hard-coded notification type lookup, referred to as notification type (legacy) on the notification type configuration. The system identifies the user-defined notification type from the lookup value.

The following identifies the configuration requirements for the notification types that are supported by existing processes in the system that rely on service tasks.

Notification Type (User Defined)	Push/Subscription	Controlled By	Notification Type (Legacy)	Service Task Type
Prepaid billing new charge	Subscription	Service Task	C1PC	Self-Service Task with BO C1-NotifyTaskType
Prepaid billing payment request	Subscription	Service Task	C1PP	Self-Service Task with BO C1-PPBPaymentNotifyTaskType
Payment Received	Subscription	Service Task	WSPR	Self-Service Task with BO C1-NotifyTaskType
Bill Ready	Subscription	Service Task	WXBR	Self-Service Task with BO C1-NotifyTaskType
Bill Due	Subscription	Service Task	WXBD	Self-Service Task with BO C1-NotifyTaskType
Late Payment	Subscription	Service Task	WSLP	Self-Service Task with BO C1-NotifyTaskType

### Non-Service Task Based Notification Types

The following identifies the configuration requirements for the notification types that are supported by existing processes in the system that rely on the user-defined notification type to be configured.

**NOTE:**

Marketing and forms notification types can be set up one of two ways: as subscription-based or as push-based. For it to be push-based, it would be an individual push, meaning that it references a parent push notification type specified by the implementer.

Notification Type (User Defined)	Push/Subscription	Controlled By	Notes
Marketing Preference (Lead Event)	Subscription or Individual Push	N/A	Notification type configured on lead event type of BO C1-LeadEvtTypeNotificationPref
Forms Update	Subscription or Individual Push	N/A	Notification type configured on form task type of C1-FormTaskTypeForNotification
Forms Closed	Subscription or Individual Push	N/A	Notification type configured on form task type of C1-FormTaskTypeForNotification

### Bill and Quote Routing

Notification types can also be used to define contact preferences for bill and quote routing for email and fax. This can enable a bill or quote to create a routing for each active contact preference. For example for a single person on an account that receives a copy of the bill, the bill can be sent to more than one email address.

Some specific configuration is needed to support this.

The notification types are to be set up as follows:

Notification Type (User Defined)	Push/Subscription	Controlled By	Bill/Quote Route Type
Bill Route	Subscription	Bill Route	Specify the Bill Route Type
Quote Route	Subscription	Quote Route	Specify the Quote Route Type

Configure only the delivery type that corresponds with the bill or quote route's routing method. For example, if the bill route type's routing method is email, configure the email delivery type on the notification type.

Configure only person contact types whose contact routing corresponds with the bill or quote route's routing method. For example, if the bill route type's routing method is email, configure only person contact types with a contact routing of email. Ensure that the person contact type allows only the delivery type specified on the notification type.

This very specific configuration is needed because the system will override the existing logic that creates bill and quote routings when a notification type exists as described above and there are active contact preferences for that notification type with the specified delivery type and the person contact's person contact type.

## Setting Up Notification Type Algorithms

### Suppression Criteria

Notification types can be suppressed from appearing in a list for a particular customer. This is done by plugging in a suppression criteria algorithm on the notification type.

Click [here](#) to see the algorithm types available for this system event.

The base product provides the **C1-ALWY-SUP** (Always Suppressed) algorithm, which suppresses the notification type for all customers. This does not impact active contact preferences for the notification type, nor does it prevent processes from creating notifications of this type. This should be used with business process changes to stop sending notifications of this type. This can also be used temporarily after a notification type has been configured, but before it should be used.

The base product provides the **C1-CKSP-PPB** (Check Prepaid Biller Suppression) algorithm, which suppresses the notification type if the customer does not have an active prepaid biller task. This should be used on prepaid related notification types so that only customers on prepaid billing receive these notifications.

If your implementation's business rules require additional notification type suppression rules, you may introduce your own algorithm.

### Override Do Not Disturb

Do not disturb information can be captured on person contacts. Person contacts are associated with a notification type to define a contact preference. When notifications are sent out, do not disturb information is included in the message to the receiving system. Some notification types might be important enough to not honor the customer's do not disturb information. For example, a notification might be sent to a subset of customers to warn of a gas leak and evacuation and needs to be sent regardless of the customers do not disturb wishes. This is done by plugging in an override do not disturb algorithm on the notification type. Note: this does not actually override the customer's information, but sends an indicator in the message to the receiving system that the do not disturb information should be overridden or ignored.

Click [here](#) to see the algorithm types available for this system event.

The base product provides the **C1-OVR-DND** (Override Do Not Disturb) algorithm, which returns a value of true that is passed to the receiving system in the notification.

If your implementation has more specific business rules related to overriding a customer's do not disturb preference, you may introduce your own algorithm.

## Setting Up Delivery Types

Base values for Delivery Type are supplied. You can add your specific delivery types by updating the value for the C1\_SS\_DELIVERY\_TYPE lookup field.

## Setting Up Notification Types

Each notification type defines the controls and behavior for defining communication preferences and sending out notifications of that type.

There are two main categories of notification types: subscription and push. These behave differently. Refer to [Push vs. Subscription Notification Types](#) for more information.

Push notification types are configured as either parent or individual push notification types. A parent push notification type is used to define communication preferences and an individual push notification type is used to send notifications. Refer to [Parent vs. Individual Push Notification Types](#) for more information.

The base product supplies one Notification Type business objects. For more details, refer to the specifications for this business object.

Some notification types require specific configuration. Refer to [Designing Notification Types](#) for more information.

To set up notification types, select **Admin > Customer > Notification Type +**.

The [Notification Type Portal](#) contains the following zones:

- [Notification Type List](#)
- [Notification Type Zone](#)

## Notification Type Portal

This section describes the zones associated to the Notification Type Portal:

- [Notification Type List](#)
- [Notification Type Zone](#)

## Notification Type List

The Notification Type List zone lists all notification types. The following functions are available:

Click a [broadcast](#) button to open other zones that contain more information about the adjacent notification type.

The standard actions of Edit, Delete, and Duplicate are available for each notification type.

Click the Add link in the zone's title bar to add a new notification type.

## Notification Type Zone

The Notification Type zone contains display-only information about the Notification Type. This zone appears when a Notification Type has been broadcast from the Notification Type List zone or if this portal is opened via drill down from another page.

Please see the zone's help text for information about this zone's fields.

### Where Used

Follow this link to open the data dictionary where you can view tables that reference [C1\\_NTF\\_TYPE](#).

## Setting Up the Outbound Message Type

An outbound message type is required for the notification outbound message. This outbound message type must reference the base [C1-NotifPrefOutboundMessage](#) (Notification Preference Outbound Message) business object.

## Setting Up the Message Sender

A Message Sender is required to define how to send notifications. Use the context of the Message Sender to define the web service interface.

## Setting Up the External System and Configure the Messages

Define an external system and configure the valid outbound message types and the method of communication for each (XAI, Batch, or Real Time); Real Time is generally the appropriate choice notifications).

## Setting Up Notification Preferences Master Configuration

General configuration details for the notification preferences functionality is captured in the **Notification Preferences**[master configuration](#).

For more information about specific fields in the master configuration, refer to the embedded help.

## Other Edge Application Notification

Other applications such as *Oracle Utilities Network Management System* or *Oracle Utilities Meter Data Management* may initiate notifications; for example, the network management product can create notifications for outages or restoration information. The customer's preferences to receive these notifications will reside in Oracle Utilities Customer Care and Billing, since this is where their contact information exists. The other applications need to be notified when an active contact preference is created for one of their notifications. The **Notification Preferences**[master configuration](#) provides the section to indicate if a Notification Type is owned by another edge application. When a contact preference is created or inactivated for one of these notification types, an outbound message is sent to notify the other edge product. When the system event in another edge application occurs that initiates a notification, that application calls and inbound web service that creates the notification.

The **Notification Preferences**[master configuration](#) help text contains detailed information about other edge applications.

## Setting Up Service Agreement Options

This section describes tables that must be set up before you can define service agreements.

## Setting Up Standard Industry Codes (SIC)

A service agreement for non-residential service should reference a standard industry code (SIC). This code is used to categorize service agreements for reporting purposes. To define a SIC, open **Admin > Customer > SIC Code**.

### Description of Page

Enter a unique **SIC Code** and **Description** for the SIC.

## Where Used

Follow this link to open the data dictionary where you can view the tables that reference [CL\\_SIC](#).

## Setting Up Tax Exempt Types

Your rates will probably have provisions for the calculation of taxes of one type or another. Frequently you will have customers who are completely or partially exempt from these taxes. The service agreements for these customers will need to have tax exemption information in order for them to be billed properly. Tax Exempt Type is used to define the precise nature of the applicable exemption. To define the Tax Exempt Types you will use, open **Admin > Customer > Tax Exempt Type**.

### Description of Page

Enter a unique **Tax Exempt Type** and **Description** for each type of tax exemption.

### Where Used

Follow this link to open the data dictionary where you can view the tables that reference [CL\\_TAX\\_EX\\_TYPE](#).

## Setting Up Contract Quantity Types

You may have customers whose contracts (service agreements) have contractual consumption limits. The service agreements for these customers must have information regarding this quantity in order to be billed properly. Contract Quantity Type is used to precisely define the nature of the quantity. To define the Contract Quantity Types, open **Admin > Rates > Contract Quantity Type**.

### Description of Page

Enter a unique **Contract Quantity Type** and **Description** for each type of contract quantity.

### Where Used

Follow this link to open the data dictionary where you can view the tables that reference [CL\\_CONT\\_QTY\\_TYP](#).

## SA Type Controls Everything

Every service agreement references a SA type. The SA type controls all aspects of a service agreement's behavior including how service is started, how bills are created, how its financial transactions are booked in the general ledger, and much more. We don't explain how to set up SA types in this section because it's only after you have set up all of the control tables in this manual that you'll be able to finally define your SA types.

---

### FASTPATH:

For more information about SA types, refer to [Defining Service Agreement Types](#).

---

## Financial Controls

---

### FASTPATH:

There are also a number of control tables that must be set up to control the bills, payments, and adjustments that are linked to a service agreement. For more information about these tables, please refer to [Defining Financial Transaction Options](#).

---

## Setting Up Order Options

This section describes tables that must be set up before orders can be used to start service.

---

### **FASTPATH:**

For more information, refer to [The Big Picture of Campaigns, Packages and Orders](#).

---

## Setting Up Column References

A column reference must be created for each miscellaneous field that's captured on an order that doesn't reside in a characteristic. Refer to [Determine The Properties Of Every Miscellaneous Field](#) for more information.

Open **Admin > Sales & Marketing > Column Reference > Add** to define your column references.

### **Description of Page**

Enter an easily recognizable **Column Reference** code and **Description** for each column reference.

Specify the **FK Reference** to use if this column reference uses field values from another table. Use **Long Description** to describe the data that fields using this column reference capture.

The grid contains **Algorithms** that control important functions in the system. You must define the following for each algorithm:

- Specify the **System Event** with which the algorithm is associated. You can define algorithms for the following system events: Post when order completed, Retrieve current value, Validate field value, Service task order processing, and Pre-process field value. Refer to [Extract Column References](#) for a description of these events.
- Specify the **Sequence** and **Algorithm** for each system event. You can set the **Sequence** to 10 unless you have a **System Event** that has multiple **Algorithms**. In this case, you need to tell the system the **Sequence** in which they should execute.

### **WARNING:**

These algorithms are typically significant processes. The absence of an algorithm may prevent the system from operating correctly.

---

### **Where Used**

Follow this link to open the data dictionary where you can view the tables that reference [CI\\_COL\\_REF](#).

## Setting Up Order Cancellation Reasons

An order cancellation reason must be supplied when an order is cancelled. Open **Admin > Sales & Marketing > Order Cancel Reason** to define your reason codes.

### **Description of Page**

Enter an easily recognizable **Order Cancel Reason** and **Description** for each order cancellation reason.

### **Where Used**

Cancellation reasons are used when an [order is canceled](#).

## Setting Up Order Hold Reasons

An order hold reason must be supplied when an order is held. Open **Admin** > **Sales & Marketing** > **Order Hold Reason** to define your reason codes.

### Description of Page

Enter an easily recognizable **Order Hold Reason** and **Description** for each order hold reason.

### Where Used

Hold reasons are used when an [order is held](#).

## Setting Up Order Feature Configurations

Defining a [feature configuration](#) with a feature type of Order Configuration can increase performance of the Order page when campaigns have a large number of packages or criteria. Open **Admin** > **Feature Configuration** > **Add** to define a configuration for the feature type Order Configuration.

---

**NOTE:**

**Only one.** The system expects only one order configuration feature configuration to be defined.

---

### Description of Page

The following points describe the various **Option Types** that may be defined:

- Eligibility Tree - Suppress Error Packages node. Select this option type and define a value if you would like the [Order Eligibility Tree](#) to suppress the node that contains packages with errors in their eligibility criteria. This is an optional setting. If the option type is not defined, the error packages node is displayed, if applicable.
- Eligibility Tree - Suppress Ineligible Packages node. Select this option type and define a value if you would like the [Order Eligibility Tree](#) to suppress the node that contains packages that are not applicable to the customer based on the eligibility criteria. This is an optional setting. If the option type is not defined, the ineligible packages node is displayed, if applicable.
- Eligibility Tree - Suppress Other Campaigns node. Select this option type and define a value if you would like the [Order Eligibility Tree](#) to suppress the node that contains other eligible campaigns. This is an optional setting. If the option type is not defined, the other campaigns node is displayed, if applicable.

## Setting Up Program Management Options

This section describes how to set up the system for program management.

For more information about program management, see [The Big Picture of Program Management](#)

## Designing Initiative Eligibility Criteria

The following describes guidelines for designing initiative eligibility criteria. These guidelines apply when using the base-supplied business objects and any additional business objects that the implementation defines.

There are two general types of initiative eligibility criteria business objects provided in base: specific and freeform. Your implementation decides whether to use only one of these types or a mixture of both.

---

**NOTE:** Initiative criteria has three categories: eligibility criteria, related object criteria, and participation criteria. (The participation criteria type is currently not used.) During criteria maintenance and lead generation, the system identifies the category to use through a business object option called Initiative Criteria Type. Eligibility criteria business objects are defined with an Initiative Criteria Type of either C1EC (Eligibility Criteria) or C1BT (Both Eligibility Criteria and Participation Criteria).

---

## Specific Criteria Business Objects

Most of the base-supplied business objects are designed to perform comparisons to a specific field. The algorithm type for retrieving/determining the value to compare with is already preset in the business object, such that the Algorithm values that the user sees on the user interface are restricted to the instances of that algorithm type.

Refer to the following base business objects for more details:

- Communication Channel Criteria
- Conservation Program Criteria
- Contract Option Criteria
- Rate Schedule Criteria
- SP Type Criteria
- Service Type Criteria
- Is Account Current Criteria
- Account is on Autopay Criteria
- Account is on Budget Criteria
- Number of Days Since Last Lead Criteria
- Account Customer Class Criteria
- Average Service Quantity Criteria
- Premise Cities Criteria

To add similar business objects:

- Identify the specific value for comparison. This could be a reference to an object or entity in the system, or a character string; such as, true/false.
- Develop the algorithm program to retrieve or determine the comparison value.
- Configure your algorithm type using the Initiative Criteria - Derive Field Value algorithm entity and reference the program you created.
- Configure your business object schema so that the Algorithm field retrieves all algorithm instances of the algorithm type you created.
- Define algorithm instances of your algorithm type.

## Freeform Criteria Business Object

The Freeform Criteria business object, on the other hand, is designed to perform comparisons for different types of values. The comparison value is determined by a Derive Value Algorithm Type that is defined as an option on this business object. A number of these Derive Value Algorithm Types are supplied with this business object and your implementation can add to these, as necessary.

---

**NOTE:** The supplied Derive Value Algorithm Types perform similar comparisons as those in the base-supplied specific criteria business objects (listed above). The Freeform Criteria business object should only be used if the available specific criteria business objects are not sufficient to perform the needed field value comparisons.

---



To add Derive Value Algorithm Types:

- Identify the specific value for comparison. It could be a reference to an object or entity in the system, a character string (such as, true/false), or a scalar value (such as, number of days or number of kwh).
- Develop the algorithm program to retrieve or determine the comparison value.
- Configure your algorithm type using the Initiative Criteria - Derive Field Value algorithm entity and reference the program you created.
- Define an algorithm instance for your algorithm type.
- Update the Freeform Criteria business object to add a Derive Value Algorithm Type business object option referencing your algorithm.

Repeat the above steps for each specific field to compare.

## Designing Related Object Criteria

The following describes guidelines for designing related object criteria. These guidelines apply when using the base-supplied business objects and additional business objects that the implementation defines.

An initiative defines the related object(s) to associate with leads via the Object Nomination algorithm on the initiative business object. The lead generation process executes this object nomination algorithm after executing initiative eligibility criteria. The base supplied parent Initiative business object (C1–Initiative) is configured with an object nomination algorithm that retrieves the premises that are associated with the account’s active and pending start service agreement’s service points. This algorithm applies the related object criteria, which is configured on the initiative, to each premise. If the premise is determined to be eligible, it is returned as a related object for the lead. To override the base object nomination algorithm, add another instance of the Object Nomination System Event and specify your own algorithm.

The base product supplies related object criteria business objects that look for one or more premise to associate with a lead.

There are two general types of related object criteria business objects provided in base - specific and freeform. Your implementation decides whether to use only one of these types or a mixture of both.

---

**NOTE:** Initiative criteria has three categories: eligibility criteria, related object criteria, and participation criteria. (The participation criteria type is currently not used.) During criteria maintenance and lead generation, the system identifies the category to use through a business object option called Initiative Criteria Type. Related object criteria business objects are defined with an Initiative Criteria Type of C1EO (Related Object Criteria).

---

## Specific Criteria Business Objects

The base product supplies two business objects that perform comparisons to a specific premise-related field. The algorithm type for retrieving or determining the comparison value is preset in the business object, such that the Algorithm values that the user sees on the user interface are restricted to the instances of that algorithm type.

Refer to the following base business objects for more details:

- Premise SP Type Criteria
- Geographic Value Criteria

To add similar business objects:

- Identify the specific comparison value. It could be a reference to an object or entity in the system (such as, SP Type), or any other attribute that can be used to find the related object.
- Develop the algorithm program to retrieve or determine the comparison value.
- Configure your algorithm type using the Initiative Criteria - Derive Field Value algorithm entity and reference the program you created.

- Configure your business object schema so that the Algorithm field retrieves all algorithm instances of the algorithm type you created.
- Define algorithm instances of your algorithm type.

## Freeform Premise Criteria Business Object

The Freeform Premise Criteria business object, on the other hand, is designed to perform comparisons to different types of values. The comparison value is determined by a Derive Value Algorithm Type that is defined as an option on this business object. Derive Value Algorithm Types are supplied with this business object and your implementation can add to these, as necessary.

---

**NOTE:** The supplied Derive Value Algorithm Types perform similar comparisons as those in the base-supplied specific criteria business objects (listed above). The Freeform Premise Criteria business object should only be used if the available specific criteria business objects are not sufficient to perform the needed field value comparisons.

---

To add Derive Value Algorithm Types:

- Identify the specific comparison value.
- Develop the algorithm program to retrieve or determine the comparison value.
- Configure your algorithm type using the Initiative Criteria - Derive Field Value algorithm entity and reference the program you created.
- Define an algorithm instance for your algorithm type.
- Update the Freeform Premise Criteria business object to add a Derive Value Algorithm Type business object option referencing your algorithm.

Repeat the above steps for each specific field to compare.

## Setting Up Lead Event Types

Each initiative can define a structured marketing effort for the events that take place during the life of a lead. For example, one event could be that a letter or an email is sent to the customer.

Each event references a lead event type. An initiative defines a lead event type profile that specifies one or more lead event types and the sequence in which those event types should occur. Refer to [The Big Picture of Initiatives](#) for more information.

Some types of lead events may also involve sending outbound messages to an external system (*e.g.*, to notify a third party representative about a customer who has signed up). The lead event type business object can specify the outbound message type(s) to use.

Event types that involve additional workflow activities can define one or more steps; for instance, when work is outsourced to a third party representative (after customer sign-up), the third party lead event includes a list of steps to complete. Each event step has information (such as, completion date) that can be used to track progress.

The base product supplies a number of Lead Event Type business objects. For more details, refer to the specifications for these business objects.

To set up lead event types, select **Admin > Sales & Marketing > Lead Event Type**.

The Lead Event Type portal contains the following zones:

### Lead Event Type List

The Lead Event Type List zone lists all lead event types. The following functions are available:

- Click a [broadcast](#) button to open other zones that contain more information about the adjacent lead event type.
- The standard actions of **Edit**, **Delete** and **Duplicate** are available for each lead event type.

Click the **Add** link in the zone's title bar to add a new lead event type.

## Lead Event Type

The Lead Event Type zone contains display-only information about the Lead Event Type. This zone appears when a Lead Event Type has been broadcast from the Lead Event Type List zone or if this portal is opened via drill down from another page.

Please see the zone's help text for information about this zone's fields.

### Where Used

Follow this link to open the data dictionary where you can view tables that reference [CI\\_LEAD\\_EVT\\_TYPE](#).

## Overriding Initiative Sign Up Options

The behavior of the Sign Up action on Lead maintenance is controlled by two business object options on the initiative:

- Sign Up UI Map
- Sign Up Service Script

When invoking a lead's Sign Up action, the system retrieves these options and displays or executes them accordingly.

The base-owned parent initiative business object, C1-Initiative, is supplied with the Sign Up Service Script option referencing the C1-IntvSignU script. To override this, add another *Sign Up Service Script* option with a higher sequence number.

The Sign Up UI map, on the other hand, is not plugged in on the base BO, because this could vary across implementations. The Sign Up UI map C1-SignUpResponseCh provided in base simply prompts for a Response Channel. Implementations can use this map or their own specific map.

---

**NOTE:** The system does not issue an error if the Sign Up UI map is not specified. It proceeds with executing the Sign Up Service Script and, if there are no problems, displays a sign up confirmation. The base-supplied C1-IntvSignU script includes logic to recheck the account's eligibility for the initiative and update the *Has Signed Up* indicator on the lead.

---

## Program Management Master Configuration

The master configuration business object for Program Management defines general configuration details for the program management functionality.

Navigate using **Admin > General > Master Configuration**. In the Master Configuration list, scroll to Program Management Configuration and click the add icon if there is no record yet or the edit icon to modify an existing record.

For more information about specific fields in the master configuration, refer to the embedded help.

## Setting Up Letter Templates

You can set up a customer contact type to generate a form letter whenever a customer contact of this type is added. In fact, this is the only way to generate a letter in the system.

---

### FASTPATH:

Refer to [Printing Letters](#) for more information about how letters are produced.

---

Every customer contact that causes a letter to be sent must reference a unique letter template. To define a letter template, open **Admin > Customer > Letter Template**.

---

**NOTE:**

**Document composition application users.** If you use the document composition software to produce letters, there will be a template in the software associated with each letter. The name of the template must be the same as the code associated with the letter template set up in the system.

---

Refer to the embedded help for details on the letter template fields.

**Where Used**

Follow this link to open the data dictionary where you can view the tables that reference [CI\\_LETTER\\_TMPL](#).

## Defining Service Order Options

Service orders manage the activities that are required to enable service, disable service, and perform other operations. These activities can range from simple events (such as, a meter read) to complex events (such as, installing a power line and a new meter). They can also include both fieldwork and smart commands.

## Service Orders

This section provides an overview of service order activities.

### Service Order Overview

Service Order Management provides functionality that orchestrates the field activities and smart meter commands that are necessary to change the state of service at a service point. This can involve complicated business logic due to numerous, often continually-changing variables, such as:

- The type of service order request; such as, enable service, disable service, cut, reconnect, and back-to back.
- Whether the service point is connected to the source of power, or not.
- If there is a device installed. If a device is installed, is it a smart meter, non-smart meter, or an item?
- The device's state at the service point; for example, pre-commissioned, connected, or disconnected.
- If it's a smart meters, what is the head-end system that manages the device at the service point/ If it's a non-smart meter (scalar), how close is the scheduled read date to the start date?

Additionally:

- Every implementation performs field work requests differently; for example, a cut service for non-payment is performed differently in every locale.
- Every head-end vendor requires different messages, in terms of the number and type of messages, and they change over releases of *their* software
- Field workers may perform different work than was requested by the system; for example, the system might request a simple reading, and the worker might decide to exchange the meter because the meter is old and broken..
- A service order request may be cancelled after it is scheduled or has been dispatched

Service orders are designed to resolve all of the above concerns, and provide a flexible and configurable solution to meet the challenge of managing customer service requests.

# Understanding Service Order Management

At a high level, service order handles requests for service as follows:

## Receive / Create Service Order Request

A service order request can be as a result of a customer requesting a change to their service such as enabling or disabling service when moving into or out of a residence, but can also be the result of other business processes, such as a request to cut service due to non-payment. Within Oracle Utilities Customer To Meter actions such as start service, stop service, and cut for non-payment result in the creation of a field activity request for each effected service point. These requests are sent to Service Order Management to be performed. In addition to requests that are created with Oracle Utilities Customer To Meter, service order requests can be received from other applications

## Create Service Order Activity

When Service Order Management receives the service order request, it creates a service order activity. This activity will manage and orchestrate the other activities needed to fulfill the original service request.

## Evaluate Service Point and/or Meter

The service order activity evaluates the current state of the service point, meter, or item, and determines the appropriate action(s) to take to fulfill the service request.

## Create Activities as Needed

Based on the evaluation of the service point, meter, or item, the service order activity creates one or more activities perform the required actions.

- Service order field activities involve sending workers into the field to perform service. This can include meter installation, meter replacement, and other activities.
- Command activities are smart meter commands used to remotely change the state of the meter. This can include connect, disconnect, checking the device status (ping), or requesting an on-demand reading.

Following each of activities, the orchestration activity re-evaluates the state of the service point, meter, or item to determine the next appropriate action(s) required to fulfill the original service request.

For example, when enabling service at a service point with a smart scalar meter, a typical scenario might involve the following:

1. Service Order Field Activity - Install Meter
2. Command Activity: Commission Device
3. Command Activity: Remote Connect
4. Command Activity: On Demand Read - Scalar

## Update Field Activity Request or Requesting System

When the orchestration activity determines that everything necessary to satisfy the service order request is ready, the orchestration activity is completed. If the orchestration activity was created by a field activity request, the field activity request is also completed. If, however, the orchestration activity was created due to external system rather than a field activity request the orchestration activity will inform the requester.

## Send Notification to Subscribing Systems

The service order activity can also be configured to send notifications to other subscribing systems regarding the status of the service point, meter, or item.

## Supported Service Order Processes

Service Order Field Activity supports the following service order processes as part of the base package.

- [Enable Service](#)
- [Disable Service](#)
- [Cut for Non-Payment](#)
- [Reconnect for Payment](#)
- [Meter Exchange](#)
- [Back-to-Back](#)
- [Cancellation Service Order Requests](#)
- [Update Service Order Requests](#)

### Enable Service

Enable Service is a request to start service for a particular service point. It is typically initiated by a *Start Service* field activity request, but can also be initiated by another CIS application.

A Start Service field activity request results in the creation of an Enable Service orchestration activity. The Enable Service orchestration activity then initiates the necessary field activities and smart meter commands to change the state of service at a service point to Enabled and confirm that an initial measurement exists; for example, an enable service orchestrating activity could involve the following service order field activities and smart meter commands based on the state of the service point:

- If there is no meter at the service point and the service point is not connected at the source, a service order field activity will be created to connect the service point to its source and install a meter.
- If a smart meter exists at the service point and it is in a disconnected state, a smart meter command will be sent to the appropriate head-end system to connect the meter.
- If there is a non-smart (manual) meter at the service point and it's On, a service order field activity will be created to request a read on or near the start date (depending when the next read is scheduled).

### Disable Service

Disable Service is a request to stop service for a particular service point. It is typically initiated by a *Stop Service* field activity request, but can also be initiated by another CIS application.

A Stop Service field activity request will result in the creation of a Disable Service orchestration activity in Service Orders. The Disable Service orchestration activity will initiate the necessary field activities and smart meter commands to change the state of service at a service point to Disabled and confirm that a final measurement exists; for example, a disable service orchestration activity could invoke the following service order field activities and smart meter commands based on the state of the service point:

- If there is a non-smart (manual) meter at the service point and it's on, a service order field activity will be created to turn off the meter.
- If a smart meter exists at the service point and its state is connected or commissioned, a smart meter command will be sent to the appropriate head-end system to perform a remote disconnect of the meter.

### Cut for Non-Payment

Disconnect for non-payment is a type of field work that is most often initiated from a collections process that has been created from within the Credit & Collection module. A collections process is created when the customer's current balance

has been determined to be past due. One of the methods for eliciting payment is to issue a disconnect. A *Disconnect for Non-Payment* field activity request will result in the creation of a Cut Service for Non-Payment orchestration activity in Service Orders. The Cut Service for Non-Payment orchestration activity will initiate the field activities and/or smart meter commands necessary to change the state of service at a service point to the disabled state.

For a Cut for Non-Payment service order, the orchestrations steps will include determining if a smart meter command can be executed, or if a request to a mobile field work application (such as Oracle Utilities Mobile Workforce Management) to dispatch a truck needs to be executed. Another example might be to determine if a disconnect can be executed for a service point. These rules might include determining if there is life support equipment at the premise, or if the service point can be disconnected at the current time of year or business hours based on utility defined rules taking into account predominant weather conditions (for instance, the utility cannot disconnect someone in the dead of winter or the service point resides at a postal code that is affected by extreme cold weather).

## Reconnect for Payment

Reconnect Service for Payment is a request to restart service for a particular service point after customer has paid off their past due balance. It is typically initiated from the Credit & Collection's Severance Process.

A Reconnect for Payment field activity request will result in the creation of a Reconnect Service for Payment orchestrator activity in Service Orders. The Reconnect for Payment orchestration activity will initiate the field activities and/or smart meter commands necessary to change the state of service at a service point to the enabled state; for example, a service order request to reconnect service could involve the following service order field activities and smart meter commands based on the status of the service point:

- If there is a non-smart (manual) meter at the service point and it's turned off, a service order field activity will be created to turn on the meter.
- If a smart meter exists at the service point and it is in a disconnected state, a smart meter command will be sent to the appropriate head-end system to connect the meter.

## Meter Exchange

Meter Exchange service is basically an exchange of an old meter with a new meter. A meter exchange request may be initiated as the result of:

- A smart meter rollout.
- A customer opting-out of having a smart meter.
- A meter no longer working correctly.
- A meter reaching the end of its life expectancy.
- A customer with a manual meter enrolling in a program that requires a smart meter.
- A need to upgrade measurement capabilities.

Meter exchanges can be initiated in a variety of ways, including:

- Within service order field activities (internally)
- By an external CIS or asset management system such as Oracle Utilities Operational Device Management
- A pick-up order from a field work application such as Oracle Utilities Mobile Workforce Management
- 
- 
- 

Meter Exchanges involving smart meters will include smart meter commands in addition to field activities. A request can optionally include information on the type of meter needed, depending on the requesting system; this information could be specific (the type of configuration) or general (smart or manual).

## Back-to-Back

Back to Back service is service disablement and enablement in single step; for example, one customer moving out while another moves in. The main purpose of this service is to minimize dispatching field work to obtain readings for both a start and stop event.

Another example of a back-to-back scenario would involve an tenant moving out and another moving into the same premise. As long as the gap between tenants (vacancy) is within the utility company's threshold, the change would be considered as a back-to-back event. In this situation, a single field task is used for this event to take the meter reading.

A Back-to-Back Service field activity request will result in the creation of a Back-to-Back Service orchestration activity in Service Orders. The Back-to-Back Service orchestration activity will initiate the field activities and smart meter commands necessary to change the state of the service of both customers at a service point to the desired state and confirm that measurements exists for that period.

## Canceling Service Order Requests

A cancellation request basically cancels any orchestration and/or specific activities that are in progress. If the cancellation request is for an orchestration activity then that orchestration activity along with corresponding activities will be discarded. If the cancellation request is for a specific activity then only that specific activity will be discarded.

Depending on the status of a specific activity, a Cancel orchestration activity will either discard the activity or an outbound communication will be sent to the field work system to request a cancel the specific activity. Once the cancellation sent to the field work system is confirmed as successful, the Cancel orchestration activity will also cancel the parent orchestration activity and/or specific activities. If the cancellation sent to the field work system is not successful then the Cancel orchestration activity will be discarded. When it is discarded, it will send a response message to the requester indicating the cancellation was unsuccessful. A cancellation request can be initiated in a variety of ways, including by cancelling a field activity request , within Service Orders itself (internally), and by an asset management system such as Oracle Utilities Operational Device Management. Cancellation requests can also be created as pick-up orders from a field work application such as Oracle Utilities Mobile Workforce Management.

## Update Service Order Requests

An update request handles requests for updates to an existing enablement, disablement, cut for nonpayment, and reconnect for payment orchestration activity and their related specific field activities.

The types of data available for update include the following:

- Instructions
- Comments
- Start Date/Time
- Contact Name
- Main Phone

Additionally, an update request can check to see if appointment information is different between the specific activity and the update orchestration activity. Depending on the status of the specific activity, direct updates will be made to the activities and communications within Service Orders or an outbound communication will be sent to the field work system to request an update of the specific activity fields that have been changed. Once that update to the field work system is confirmed as successful the Update orchestration activity will update the effected orchestration activity. If the updates are not successful the Update orchestration activity will be discarded. When it is discarded, it will send a response message to the requester indicating the update was unsuccessful.

Update service requests can be initiated by a field activity request or within Service Orders itself (internally).



## Defining Disconnect Locations

When a service point is disconnected from the supply source, a disconnect location must be specified. This location defines where service was severed.

To define disconnect location codes, open **Disconnect Location** page.

### Description of Page

Enter a **Disconnect Location** and **Description** for every disconnect location.

### Where Used

Follow this link to open the data dictionary where you can view the tables that reference [CL\\_DISCON\\_LOC](#).

## Defining Field Activity Profiles and Types

A field activity request initiates a service order to perform a task at a service point. Every field activity request references a field activity type.

Most field activity requests are created:

- When a customer service representative starts or stops service at a premise. When this happens, the system automatically creates field activity requests for each service point.
- When service is cut due to lack of payment.

If you set the system up correctly, your CSRs won't have to create these field activity requests. Rather, the system creates field activity requests based on the information you set up in your field activity type profiles.

- Refer to [Starting Service & Field Activities](#) for a description of how field activity requests are created to start service.
- Refer to [Stopping Service & Field Activities](#) for a description of how field activity requests are created to stop service.
- Field activities used to cut service due to non-payment are created by two modules:
  - If you use severance process to stop a service agreement due to nonpayment, refer to [Field Events And Their Activities](#) for a description of how these field activity requests are created.
  - If you use cut processes to stop a service agreement due to nonpayment, refer to [Field Activities To Cut and Reconnect Service](#) for a description of how these field activity requests are created.

The topics in this section describe how to design your field activity profiles and field activity types.

## How Does A Field Activity Type Profile Get Used?

A field activity type profile contains:

- A list of the types of field activity requests that can be made for service points.
- A matrix defining the specific activity type(s) to generate in order to start service, stop service, or disconnect due to nonpayment.

You may wonder how field activity type profiles get related to your service points. It's a little indirect, but the indirection provides a great deal of flexibility:

- Every service point references an SP type.

- Every SP type references the specific field activity type profile used by the start/stop and credit and collections process to generate field activity requests.

An example will help illustrate how this works:

- When you start service at a specific service point, the system extracts the service point's SP type.
- Then, the system determines the field activity type profile that is to be used on this SP type.
- And finally, it generates the appropriate field activity request.

## Designing Field Activity Type Profiles

With Service Order Management typically only a single field activity type profile will be needed for the meter and item related service points. This profile should have a template for each of the following with a service point condition of *External Fieldwork Orchestration* to indicate that Service Order Management is orchestrating the field work:

- Start Service
- Stop Service
- Start/Stop
- Cut for Non-Payment
- Reconnect for Payment

## Designing Field Activity Types

A field activity type is required for the following events:

- Start service
- Stop service
- Cut for non-payment
- Reconnect for payment
- Back-to-back

## Setting Up Field Activity Types

The topics in this section describe how to set up field activity types.

---

**FASTPATH:**

**For more information** about field activity types, refer to [Defining Field Activity Profiles and Types](#).

---

## Field Activity Type - Main

You begin to define a field activity type by opening **Admin > Field Work > Field Activity Type > Add**.

### Description of Page

Enter an easily recognizable **Activity Type** and **Description** for each field activity type.

Use **Field Activity Priority** to define the priority associated with field activity requests of a given type.

---

**NOTE:**

The values for this field are customizable using the Lookup table. This field name is FA\_PRIORITY\_FLG.

---

**Field Service Class** is not applicable when Service Order Management is used.

Set **Fieldwork Orchestration** to Service Order Management

**Eligible for Dispatch** is not applicable when Service Order Management is used.

**Appointment Booking** is not applicable when Service Order Management is used.

Turn on **Display as Alert** if Control Central should display an alert if its premise has a completed field activity request of this type. If this switch is on,

- Use **Nbr Days Alert Active** to define the number of days the alert should appear on Control Central. The field activity request's scheduled date is used as the start date for the alert period.
  - Enter the **Alert Information** to appear on Control Central.
- 

**NOTE:**

**Recommendation.** We recommend only using this feature on unusual field activity types (e.g., cut for non-payment) so that a CSR is not presented with an alert for every field activity request.

---

Enter the **Business Object** for this FA Type if the FA type will need access to the BO plug-in spots. If the FA type has a business object specified, the system applies the business object's rules when the FA is added, changed, or deleted. This includes the business object's validation algorithms (only executed after the "core validation" specified on the maintenance object is done), post-processing algorithms, and audit algorithms. The maintenance object for the FA should specify an algorithm that finds its business object using its FA Type. Refer to the base package Determine Standard Business Object algorithm for an example of this type of algorithm.

**Field Activity Step** is not applicable when Service Order Management is used.

Use the **Characteristic** collection to define **Characteristic Types** and their respective **Characteristic Values** to describe characteristics that are common to all field activity requests of this type.

---

**NOTE:**

You can only choose characteristic types defined as permissible on the field activity type record.

---

### Where Used

Follow this link to open the data dictionary where you can view the tables that reference [CI\\_FA\\_TYPE](#).

## Field Activity Type - FA Characteristics

### Description of Page

Use the **Characteristics** collection to define characteristics that can be defined for field activity requests of a given type. Use **Sequence** to control the order in which characteristics are defaulted. Turn on the **Required** switch if the **Characteristic Type** must be defined on field activity requests of a given type. Turn on the **Default** switch to default the **Characteristic Type** when field activity requests of the given type are created. Enter a **Characteristic Value** to use as the default for a given **Characteristic Type** when the **Default** switch is turned on.

---

**NOTE:**

**Field activity requests created by the system.** When setting the Required switch, remember that most field activities are created by the system. Only turn on the required switch for these types of activities if a default characteristic value can also be indicated

---

## Field Activity Type - FA Completion Control

### Description of Page

---

**NOTE:**

**These algorithms are optional.** The use of completion algorithms on a field activity type is optional. You would only use them if you have special functions that should be executed when a given field activity type is completed.

---

The **Field Activity Completion Controls** tab is used when an algorithm should be executed when a field activity request is completed. The type of algorithm may differ based on the CIS division in which the service point's premise is located. The following fields must be defined:

**CIS Division** Defines the division associated for which the algorithm will be executed. The system will only execute the algorithm when a field activity request is performed at a service point whose premise is governed by the division.

**FA Completion Algorithm** Defines the algorithm that will be executed when a field activity request is performed at a service point whose premise is governed by the associated division. Click [here](#) to see the algorithm types available for this plug-in spot.

## Field Activity Type - SP Type Review

Not applicable when Service Order Management is being used.

## Setting Up Field Activity Type Profiles

The topics in this section describe the pages used to define a field activity type profile.

---

**NOTE:**

**When a new profile is added.** When you introduce a new field activity type profile, you must define the SP types that use it. Refer to [Understanding Service Point Types](#) for more information.

---

**FASTPATH:**

**For more information** about field activity type profiles, refer to [Designing Your Field Activity Profiles & Types](#).

---

## Field Activity Type Profile - Main

### Description of Page

Enter a unique **Field Activity Type Profile** and **Description** for the activity type profile.

The **FA Type Profile Templates** indicate the templates that exist for this field activity type profile. Use the drill down button to go directly to the desired template. Alternatively, you can go to the **Template** tab and scroll until you find the correct template.

## Field Activity Type Profile - Template

### Description of Page

The information in the **Field Activity Profile Template** collection defines the field activity request(s) created for each situation identified by the **Customer Event**. The possible customer events are Cut for Non-payment, Disconnect Warning, Reconnect for Payment, Reread, Stop Service, Start Service, and Start/Stop.

---

**NOTE:** Field activity requests do not need to be defined for Reread when Service Order Management is being used.

---

Other customer events can be defined on the [Look Up](#) page (search for the CUST\_EVT\_FLG field name). Refer to the following sections for more detail about customer events included with the base product.

The fields defined for each event are common. You define the field activity request(s) to be generated given the condition of the service point. The following fields display:

**SP Field Condition** Define the condition of the service point associated with the field activity. Define *External Fieldwork Orchestration* when Service Order Management is being used.

**Sequence** You will typically have a single field activity request for any specific combination of SP Field Condition and Disconnect Location. Therefore you'll just have a single sequence (say 10) for each combination. If you need to generate multiple field activities based on a given combination, use a unique sequence number for each activity.

**No Activity** Turn on this switch if no field activity should be generated for the condition.

**Disconnect Location** this is not applicable when Service Order Management is being used.

**Activity Type** Define the type of field activity request to be generated. You should take care to ensure that the activity type is defined as valid for the SP type (on the last page).

### Where Used

Refer to the following sections for information about where each template is used.

## Field Activity Requests Initiated To Start Service

Use the customer event Start to define the field activity request(s) used to start service at a service point whose SP type references this profile.

### Description of Page

See [Field Activity Type Profile - Template](#) for a description of the fields.

### Where Used

The start service process uses this information to determine the type of field activity requests to create to start service at a service point.

---

**WARNING:**

Warning. Field activity requests will only be created for starts if you have defined the appropriate field work creation algorithm on the service agreement's SA type. Refer to [SA Type - Algorithms](#) for more information.

---

## Field Activity Requests Initiated To Stop Service

Use the customer event Stop to define the field activity request(s) used to stop service at a service point whose SP type uses this profile.

#### **Description of Page**

See [Field Activity Type Profile - Template](#) for a description of the fields.

#### **Where Used**

The stop service process uses this information to determine the type of field activity requests to create to stop service at a service point.

---

#### **WARNING:**

Warning. Field activity requests will only be created for stops if you have defined the appropriate field work creation algorithm on the service agreement's SA type. Refer to [SA Type - Algorithms](#) for more information.

---

## **Field Activity Requests Initiated For Back-to-Back Service**

Use the customer event Start/Stop to define the field activity request(s) used to stop service for one customer and start service for another at a service point whose SP type uses this profile.

---

#### **NOTE:**

**Terminology.** We use the term **back-to-back** to describe the situation when a single field activity request supports both the stop and start service requests. The system sets up a back-to-back situation by default when it is aware of both the start and stop customers at a premise.

---

#### **Description of Page**

See [Field Activity Type Profile - Template](#) for a description of the fields.

#### **Where Used**

The start/stop service process uses this information to determine the type of field activity requests to create to start service at a service point.

## **Field Activity Requests Initiated To Cut Service Due To Non-Payment**

Use the customer event Cut for Non-Payment to define the field activity request(s) used to cut service at a service point whose SP type uses this profile.

#### **Description of Page**

See [Field Activity Type Profile - Template](#) for a description of the fields.

#### **Where Used**

Severance and cut events use this information to determine the type of field activity requests to create to cut service at a service point.

## **Field Activity Requests Initiated To Place A Disconnect Warning At A Service Point**

Use the customer event Disconnect Warning to define the field activity request(s) used to place a disconnect warning at a service point whose SP type uses this profile.

## Description of Page

See [Field Activity Type Profile - Template](#) for a description of the fields.

## Where Used

Severance and cut events use this information to determine the type of field activity requests to create to leave a disconnect warning at a service point.

## Field Activity Requests Initiated To Reconnect Service At A Service Point

Use the customer event Reconnect for Payment to define the field activity request(s) used to reconnect service (after being cut) at a service point whose SP type uses this profile.

## Description of Page

See [Field Activity Type Profile - Template](#) for a description of the fields.

## Where Used

Severance and cut events use this information to determine the type of field activity requests to create to reconnect service at a service point.

## Field Activity Requests Initiated To Reread A Meter At A Service Point

This template is not applicable when Service Order Management is being used.

## Defining A Profile's Valid Field Activity Types

### Description of Page

The **Field Activity Type** collection shows the field activity requests that may be created for at service points whose SP type references the field activity type profile.

### Where Used

This information is used to control the types of field activity requests that may be created for at a service point.

## Setting Up Fieldwork Cancellation Reasons

### Description of Page

Enter a **Cancel Reason** and **Description** for every field activity request cancellation reason.

Only use **System Default** on those reason codes that are placed on field activity requests that are automatically canceled by the system. The following table lists the valid values and the condition where this cancel reason is used.

System Default	System Condition
Cut Process canceled	Placed on field activity requests that are canceled when a <a href="#">Cut Process</a> is canceled.
SA Start/Stop canceled	Placed on field activity requests that are canceled when a pending start/stop is canceled.

**NOTE:**

**Required values.** You must have one reason code defined for each of the System Default values that corresponds to an event that may occur in your implementation.

**Where Used**

Follow this link to open the data dictionary where you can view the tables that reference [CI\\_FA\\_CAN\\_RSN](#).

## Setting Up Field Activity Remarks

**NOTE:** Field work remarks are typically processed by Service Order Management; therefore, field activity request remarks are not required.

**Description of Page**

Enter a unique **Field Activity Remark** and a **Description** for every field activity request remark.

Turn on **Eligible for Processing** if field activity requests marked with a given remark code should cause one or more algorithm to execute.

The grid contains **Algorithms** associated with the field activity request remark. You must define the following for each algorithm:

- Specify the **System Event** with which the algorithm is associated (see the table that follows for a description of all possible events).
- Specify the **Sequence Number** and **Algorithm** for each system event. You can set the **Sequence Number** to 10 unless you have a **System Event** that has multiple **Algorithms**. In this case, you need to tell the system the **Sequence** in which they should execute.

The following table describes each **System Event**.

System Event	Optional / Required	Description
Field Activity Remark Activation	Optional	<p>These algorithms are executed when there are pending FA remarks linked to a field activity request and the <a href="#">FACT</a> (Field activity remark activation) background process runs.</p> <p>Refer to <a href="#">Field Activity - Characteristics/Remarks</a> for more information.</p> <p>Click <a href="#">here</a> to see the algorithm types available for this system event.</p>

**Where Used**

Follow this link to open the data dictionary where you can view the tables that reference [CI\\_FA\\_REM\\_CD](#).

## Defining Outage Call Options



When you create an outage call, you must supply an outage call type. Outage call types contain a great deal of information that is defaulted onto the outage call, including the outage category group codes or trouble codes. To set up outage call types, select **Admin > Field Work > Outage Call Type > Add**.

---

**NOTE:**

Refer to [The Big Picture of Outage Care Integration](#) for more information about how trouble calls are created and sent to NMS.

---

The topics in this section describe the base-package zones that appear on the Outage Call Type portal.

## Outage Call Type List

The Outage Call Type [List zone](#) lists every outage call type, i.e. every service task type that has a service task type class of Outage Call. The following functions are available:

- Click a [broadcast](#) button to open other zones that contain more information about the adjacent outage call type.
- Click the Add link in the zone's title bar to add a new outage call type.

## Outage Call Type

The Outage Call Type zone contains display-only information about an outage call type. This zone appears when an outage call type has been broadcast from the Outage Call Type [List zone](#) or if this portal is opened via a drill down from another page. The following functions are available:

- **Edit:** to start a business process that updates the outage call type.
- **Delete:** start a business process that deletes the outage call type.
- **Duplicate:** to start a business process that duplicates the outage call type.

Please see the zone's help text for information about this zone's fields.

## Service Order Management External Applications

The external systems used with Service Order Management must be defined as External Applications using the "External Application" (D1-ExternalApplication) business object. Examples of external systems can include:

- A customer information system (such as a separate installation of Oracle Utilities Customer Care and Billing)
- A field work system (such as Oracle Utilities Mobile Workforce Management)
- An asset management system (such as Oracle Utilities Operational Device Management or Oracle Utilities Work and Asset Management)

Information defined for external system service providers used by Service Order Management include:

- **Our Name/ID in Their System:** This is the value that the field work system uses to identify our system.
- **Utility Device ID Type:** This is the Device ID Type that will be used when communicating with the external application and it will be the assumed Device ID Type for any device identifiers sent from the external application.
- **Utility Service Point ID Type:** This is the Service Point ID Type that will be used when communicating with the external application and it will be the assumed Service Point ID Type for any service point identifiers sent from the external application.

Refer to [Understanding External Applications](#) and [Configuring External Applications](#) for more information about external applications.

## Processing Roles

The external application's processing roles define how data relevant to the field work system is sent and/or created.

Field work service providers can use the following processing roles:

- **Activity Notification:** Used to send notifications to subscribing and/or requesting systems about the status of orchestration and/or service order field activities.
- **Appointment Request:** Used to send a request for an appointment to the field work system.
- **Cancellation Activity:** Used to send notifications to requesting systems when canceling orchestration and/or service order field activities.
- **Collection Details:** Used to retrieve details about collections processing (used with "Cut Service for Non-Payment" and "Restore Service for Payment" orchestration activities).
- **Customer Contact:** Used to send a contact to a customer regarding a service request
- **Field Activity:** Used to send a service order field activity to the field work system.
- **Field Activity Completion:** Used to send a notification regarding completion of a service order field activity.
- **Interim Status Update:** Used to send updates regarding the status of orchestration and service order field activities to requesting systems.
- **Meter Exchange Mapping:** Used to define how to define different types of meter exchanges based specific roles and device configurations. This can provide context to field crews to help ensure they install the correct type of device and device configuration when exchanging a meter.
- **Response - Appointment:** Used to send a request for an appointment to the field work system.
- **Response - Fail:** Used to send a response to an external system when Service Order Management fails to respond.
- **Response - Missed Appointment:** Used to send a response to the field work system when notification of a missed appointment is received.
- **Response - Negative Acknowledgement:** Used to send a negative acknowledgement response to an external system in the event that a request is rejected.
- **Response - Received:** Used to send a response to an external system to acknowledge receipt of a request.
- **Response - Success:** Used to send a response to an external system when Service Order Management successfully processes a request.
- **Send Field Activity Remark:** Used to send a service order field activity remark to a subscribing system
- **Update Activity:** Used to send notifications to requesting systems when updating orchestration and/or service order field activities.

## Setting Up Service Order Activities

### Understanding Service Order Activities

This section describes service order activities and how they manage the service order process.

Service order activities coordinate a large number of child transactions that represent the communication to and from an external application. The below diagram depicts a service order activity:

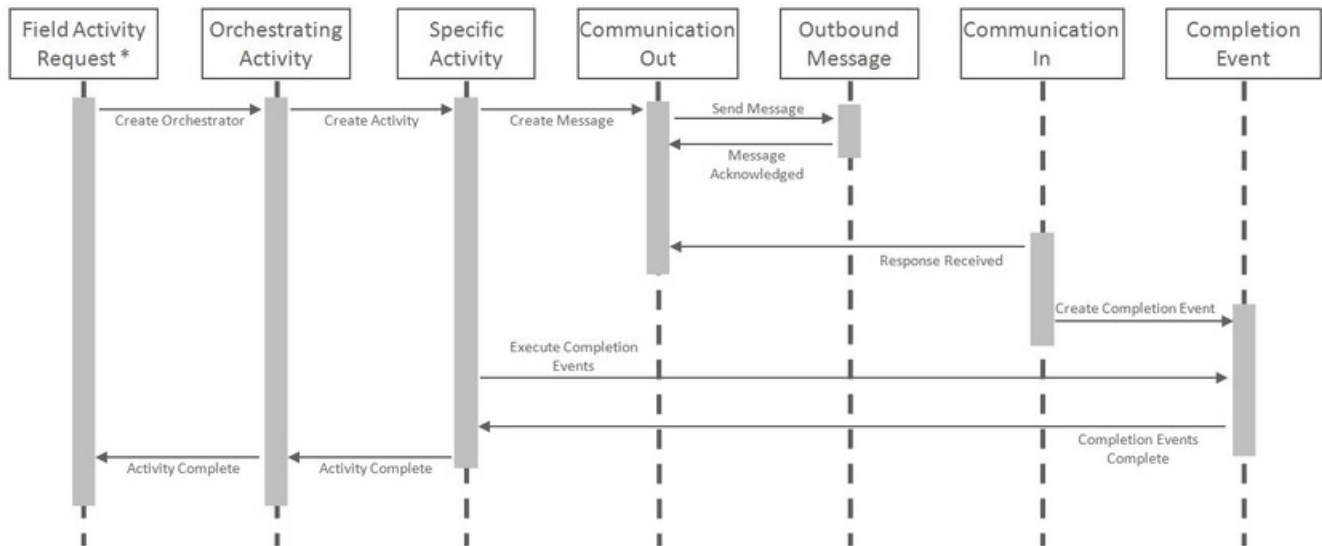

\* **Field Activity Request:** Created by business processes; such as, start service, stop service, and credit & collection. A field activity request initiates an orchestrating activity to fulfill the request. *Note:* orchestrating activities can also be created manually and through external application requests.

Each object in the sequence diagram has a distinct set of duties within the context of the communication:

- **Orchestrating Activity:** controls the overall intent of the communication. For example an "Enable Service" could include initiating one-to-many specific activities to install the meter and begin the flow of the metered commodity to the service point.
- **Specific Activity:** can be initiated from an orchestrating activity or directly. These activities represent a single task to be carried out such as installing a meter or a remote disconnect smart meter command.
- **Communication Out:** orchestrates the communication to the external application and provides robust handling for any errors that might occur during that communication.
- **Outbound Message:** represents the message payload sent to the external system and the synchronous response.
- **Communication In:** orchestrates the handling of an asynchronous or unsolicited response from an external system.
- **Completion Event:** carries out the results of the communication. For example, in the case of a remote connect it would create the appropriate on off history entry for the device's installation event.

The base package provides the following types of service order activities:

- **Enable Service:** Used to enable service at a service point.
- **Disable Service:** Used to disable service at a service point.
- **Cut for Non-Payment:** Used to cut off service at a service point due to non-payment of past due amounts.
- **Reconnect Service for Payment:** Used to restore service at a service point after receipt of past due payment.
- **Exchange Meter:** Used to orchestrate the exchange of meters at service point, such as in the event that a customer upgrades their meter.
- **Back to Back Service:** Used to orchestrate a change of service when the customer at a service point changes (such as when owners/tenants change).

## Service Order Activity Processing

To understand how service order activities manage the service order process, it's important understand the lifecycle of orchestration activity business objects.

## Service Order Orchestration Activity Lifecycle

All service order orchestration activity business objects share a common parent business object that defines their lifecycles. This is the Service Point Activity Orchestration business object (DI-SPActivityOrchestration). The table below outlines the lifecycle for this business object.

State	Description
Pending	<p>The initial state for orchestration activities.</p> <p>An Enter algorithm sends an acknowledgement to the requesting system.</p> <p>The activity is transitioned to the next state via a monitor process.</p>
Validate	<p>Enter algorithms perform the following:</p> <p>Validate Activity Type</p> <p>Validate Service Point</p> <p>Check for a non-final duplicate service order request activity for the same service point.</p>
Validation Error	<p>If the business object fails any of the validations in the Pending state, it enters this state.</p> <p>Activities in this state can be corrected and retried.</p>
Discarded	<p>Activities discarded in other states enter this state.</p> <p>Enter algorithms perform the following:</p> <p>Validate that non-final child activities can be discarded without the need for a cancel activity</p> <p>Cancel non-final child activities</p> <p>Send a failure notification to the requesting system</p>
Waiting for Effective Date	<p>If an orchestration activity has a future effective date, it remains in this state until the effective date is reached.</p> <p>A Monitor algorithm transitions the activity to the next state when the activity's effective date time is reached (process date time &gt;= effective date time).</p>
Are SP and Device Ready?	<p>Each type of orchestration activity business object has a unique set of Enter algorithms that perform operations as appropriate for the type of service order request.</p> <p>See <a href="#">Service Order Activity Algorithm Types</a> for more information about these algorithms.</p>
Activity in Progress	<p>Orchestration activities remain in this state while their child activities are processed.</p> <p>A Monitor algorithm transitions the activity to the "Are the SP and Device Ready?" state if there are no non-final child activities related to the current activity.</p> <p>A Monitor algorithm validates that the orchestration activity has not been in its current state for too long, based on the Expiration Days parameter on the orchestration activity's type and the Expiration Date/Time on the orchestration activity</p> <p>An Exit algorithm resets the Expiration Date/Time on the orchestration activity such that each time the activity exits this state its Expiration Date/Time is updated.</p>
Activity Error	<p>If one or more child activities enters an Error state, the orchestration activity enters this state.</p> <p>Activities in this state can be corrected and retried.</p>
Retry	<p>When an orchestration activity is retried after correction of an error condition, it enters this state.</p> <p>Enter algorithms perform the following:</p> <p>Check to determine if there are child service order field activities in progress that have outbound communications awaiting a response.</p> <p>Transition any non-final child activity to the "Reject" state (the state defined as "Reject" on the child activity business object lifecycle. This is most often the "Discarded" state).</p>

State	Description
Completed	Orchestration activities enter this state when all child activities have successfully completed. An Enter algorithm send a success notification to the requesting system.

Use the Business Object and Algorithm portals to view additional details about this business object and its lifecycle algorithms.

### Cancel / Update Orchestration Lifecycle

The Cancel Orchestration (D1-CancelOrchestration) and Update Orchestration (D1-UpdateOrchestration) business objects have a similar lifecycle, with the following exceptions:

- There is no "Waiting for Effective Date" state.
- In place of the "Are SP and Device Ready?" state, they have "Cancel Specific Activity" / "Update Specific Activity" states. Enter algorithms on these states attempt to cancel or update a specific child activity.
- In the place of "Activity In Progress" and "Activity Error" states, they have "Communication in Progress" and "Communication in Error" states.

Use the Business Object and Algorithm portals to view additional details about this business object and its lifecycle algorithms.

### Service Order Activity Algorithm Types

When an orchestration activity enters the "Are SP and Device Ready?" state, a set of Enter algorithms are used to evaluate the state of the service point / meter / item to determine which actions are required to complete the service request. These algorithms are based on the following algorithm types.

#### Customer-Device Compatibility Check (D1-DVCOMCHK)

Algorithms of this type execute the "Customer-Device Compatibility Algorithm" defined on the orchestration activity's activity type. Algorithms of this type uses the following parameters:

- **Activity BO To Create If Compatibility Detected:** Specifies the activity business object to instantiate if the algorithm detects an in compatibility between the customer/service point and device.

Note: The base package does not include algorithm types for the "Activity Type - Customer Device Compatibility" algorithm entity.

#### Connect Only If Previously Connected (D1-CONPRECON)

Algorithms of this type check if the "Connect New Device" flag has a value. If the flag is not populated, the algorithm sets the value of the flag based on the connection status of the device prior to the meter exchange (used only with Meter Exchange requests).

For additional information, refer to the [D1-CONPRECON](#) Algorithm Type.

#### Create Meter Exchange Field Activity (D1-CREMTREXC)

Algorithms of this type create a service order field activity based on details provided in the algorithm's parameters. Algorithms of this type uses the following parameters:

- **Activity and Specific Field Task to Create:** Specifies the type of activity business object and field task type to create for meter exchange service order field activities, as defined by the following mnemonics:

Mnemonic	Description
activityBOToCreate	Specifies the activity business object to create.

Mnemonic	Description
specificFieldTask	Specifies the Field Task Type when creating a service order field activity. This value comes from the Field Task Type extendable lookup.

For example, to create a service order field activity based on the D1-FieldActivity business object and the Exchange Meter field task type, these mnemonics would be configured as follows:

```
activityBOTOCreate=D1-FieldActivity specificFieldTask=D1-ExchangeMeter
```

For additional information, refer to the [D1-CREMTREXC](#) Algorithm Type.

## Decommission Removed Meter (D1-DCRMMTR)

Algorithms of this type create a decommissioning command for a removed meter (used only with Meter Exchange requests). Algorithms of this type uses the following parameters:

- **Decommission Activity BO to be created:** Specifies the type of activity business object to create when decommissioning a meter. The specific activity is created, as defined by the following mnemonics:

Mnemonic	Description
activityBOTOCreate	Specifies the activity business object to create.

For example, to create a smart meter command activity based on the D1-DeviceDecommission business object, this parameter would be configured as follows:

```
activityBOTOCreate=D1-DeviceDecommission
```

For additional information, refer to the [D1-DCRMMTR](#) Algorithm Type.

## Create Specific Activity (D1-CRSPACT)

Algorithms of this type determine if a specific activity needs to be created based on the state of the service point. Algorithms of this type use the following parameters to specify the conditions and activity to be created:

- **Field Activity BO:** Specifies the activity business object to instantiate if the algorithm creates a field task type (see next parameter).
- **SP State and Activity BO to Create:** Specifies the type of activity business object to create based on the state of the service point. This parameter can be repeated up to 20 times. Instances of the parameter are evaluated one at a time and the first condition matching the state of the service point is used. Parameters should be ordered from the most restrictive condition to the least restrictive. This parameters uses the following mnemonics to indicate the state (any combination of the following) of the service point:

Mnemonic	Description
servicePointConnected	Specifies if the service point is currently connected Valid values are "true" and "false".
disconnectLocation	Specifies the "Disconnect Location" for the service point. Valid values are "D1SR" (source) and "D1DV" (device).
deviceInstalledAtSP	Specifies if there is a device currently installed at the service point. Valid values are "true" and "false".
installationEventStatusOverride	Specifies the value of the "Installation Status" option type of the Install Event's Status ("Pending", "Conn-PreComm", "ManualOff", etc.)

Based on the unique combination of these mnemonics, a specific activity is created, as defined by the following mnemonics:

Mnemonic	Description
activityBOToCreate	Specifies the activity business object to create (used most often to specify a command business object)
specificFieldTask	Specifies the field task type when creating a service order field activity. This value comes from the Field Task Type extendable lookup.  Note: If this mnemonic is specified, the "Field Activity BO" parameter should specify the activity business object to create.
spTypeCategory	Specifies a service point type category. Valid values include "D1MT" (meter), "D1IT" (item), "D1MI" (multi-item), from the SP_CATEGORY_FLG lookup.  Specifying this mnemonic indicates that a service order field activity should be created only if the service point's category match the one specified by this mnemonic.
executeOverrideAlgorithm	Specifies whether or not to execute the algorithm specified for the <b>Override Device/Task Algorithm</b> on the service order orchestration activity type.  This allows the activity business object to be dynamically determined based on an algorithm instead of the "activityBOToCreate" or "specificFieldTask" mnemonics.  Valid values are "true" and "false".

For example, the following parameter configuration would create a "Connect Service Point and Install Meter" service order field activity given the following conditions:

- Service Point Connected: False
- Disconnect Location: Source
- Device Installed at Service Point: False
- Service Point Category: Meter

```
servicePointConnected=false disconnectLocation=D1SR deviceInstalledAtSP=false specificFieldTask=D1-ConnSPAtSrceAndInstMtr spTypeCategory=D1MT
```

For additional information, refer to the [D1-CRSPACT](#) Algorithm Type.

## Update Device (D1-UPDDVC)

Algorithms of this type determine if an activity needs to be created to update the device based on the state of the service point and device installed at the service point. Algorithms of this type use the following parameters to specify the conditions and activity to be created.

- **Error if SP Not Connected or no Device Installed (Default is Yes):** Indicates if the algorithm should return an error if the service point is not connected or if a device is not currently installed. Valid values are "Yes" and "Con" (continue)
- **SP State and Activity BO to Create:** Specifies the type of activity business object to create based on the state of the service point. This parameter can be repeated up to 20 times. Instances of the parameter are evaluated one at a time and the first condition matching the state of the service point is used. Parameters should be ordered from the most restrictive condition to the least restrictive. These parameters use the following mnemonic to indicate the state (any combination of the following) of the service point:

Mnemonic	Description
installationEventStatusOverride	Specifies the value of the "Installation Status" option type of the Install Event's Status ("Pending", "Conn-PreComm", "ManualOff", etc.)

Based on the value of this mnemonic, a specific activity is created, as defined by the following mnemonics:

Mnemonic	Description
activityBOToCreate	Specifies the activity business object to create (used most often to specify a command business object)
specificFieldTask	Specifies the Field Task Type when creating a service order field activity. This value comes from the Field Task Type extendable lookup.  Note: If this mnemonic is specified, the "Field Activity BO" parameter should specify the activity business object to create.
spTypeCategory	Specifies a service point type category. Valid values in include "D1MT" (meter), "D1IT" (item), "D1MI" (multi-item), from the SP_CATEGORY_FLG lookup.  Specifying this mnemonic indicates that a service order field activity should be created only if the service point's category match the one specified by this mnemonic.
alternativeFieldTask	Specifies an alternative Field Task Type to use when creating a service order field activity in the event that the device does not support the command indicated by the "activityBOToCreate" mnemonic.  Note: If this mnemonic is specified, the "Field Activity BO" parameter should specify the activity business object to create.  A value of 'skip' will continue the evaluation of the algorithm's next parameter

For example, the following parameter configuration would create a "Turn On Meter" service order field activity given the following conditions:

- Installation Status: Manual Off
- Service Point Category: Meter

```
installEventStatusOverride=ManualOff specificFieldTask=D1-TurnOnMeter spTypeCategory=D1MT
```

Other parameters used by algorithms of this type include:

- **Field Activity BO:** Specifies the activity business object to instantiate if the algorithm creates a field task type (see above parameter).
- **XPath of Activity Element controlling Activity creation:** Defines an element within the activity business object schema that can be used to control whether or not this algorithm should create an activity. For example, to specify that the value of the "Connect New Device" flag be used to determine whether or not the algorithm should create an activity, this parameter could be set to "connectNewDevice".
- **Element value indication that Activity creation should not proceed:** Specifies a value for the element defined in the "XPath of Activity Element controlling Activity creation" parameter that would indicate that the algorithm should not create an activity. Valid values are based on the element defined for the "XPath of Activity Element controlling Activity creation" parameter. For example, to specify that an activity should not be created if the "Connect New Device" flag is



set to "Do Not Connect / Turn On", this parameter should be set to "D1NC" (from the D1\_CONNECT\_NEW\_DEVICE\_FLG lookup).

For additional information, refer to the [D1-UPDDVC](#) Algorithm Type.

## Remote Turn Off Turn On (D1-REMONOFF)

Algorithms of this type remotely turn a device off and on for a Back to Back service request. Algorithms of this type use the following parameters:

- **Device Incompatibility Detected Activity BO:** Specifies the activity business object the algorithm will look for. If the algorithm finds an activity of this business object, the algorithm terminates.
- **Remote Connect BO:** Specifies the activity business object to instantiate when creating a remote connect command.
- **Remote Disconnect BO:** Specifies the activity business object to instantiate when creating a remote disconnect command.
- **Installation Event Status Override for Connect:** The override status to which the Installation Event Status is set after performing a remote connect command.
- **Installation Event Status Override for Disconnect:** The override status to which the Installation Event Status is set after performing a remote disconnect command.

For additional information, refer to the [D1-REMONOFF](#) Algorithm Type.

## Check for Measurement (D1-CHKMSMT)

Algorithms of this type determine if measurements exist on activity's service point as of the service date/time. If no measurement is found, algorithms of this type create an activity to either obtain or wait for a measurement. The specific type of activity is based on the type and configuration of the device and service point. Algorithms of this type use the following parameters:

- **Activity BO To Wait For Measurement:** Specifies the activity business object to instantiate when the algorithm logic indicates it should wait for a measurement for the service point.
- **Activity BO For Field Read:** Specifies the field activity business object to instantiate when the algorithm logic indicates it should request a meter reading from the field.
- **Specific Field Task:** Specifies the field task type when creating a service order field activity for a meter reading from the field.
- **Activity BO To Wait For Scheduled Read:** Specifies the activity business object to instantiate when the algorithm logic indicates it should wait for a scheduled read for the service point.
- **Activity BO For On Demand Read - Scalar:** Specifies the activity business object to instantiate when the algorithm logic indicates it should issue an on-demand read (scalar) smart meter command.
- **Start Range for Normal Measurement Condition:** The start of the range of conditions that indicate "normal" measurements when the algorithm is searching for measurements for the service point.
- **End Range for Normal Measurement Condition:** The end of the range of conditions that indicate "normal" measurements when the algorithm is searching for measurements for the service point.
- **Minimum Range for bottom Measurement condition:** The minimum measurement condition used when searching for measurements for the service point. Used only when no measurements are found in the "normal" range defined by the "Start/End Range Normal Measurement Condition" parameters.

The following parameters on the orchestration activity type are also used by algorithms of this type when searching for measurements for the service point:

- **Look for Measurement within the Day:** Limits the search to the reference date (the service date).
- **Minimum and Maximum Offset Number of Days:** Numbers of days added to /subtracted from the reference date to expand the search period.

For additional information, refer to the [D1-CHKMSMT](#) Algorithm Type.

## Algorithm Types and Orchestration Activity Business Objects

Each of the orchestration activity business objects uses a different set of these algorithm types. The table below lists which of these algorithm types are defined for each of the service order orchestration activity business objects.

	Enable Service	Disable Service	Cut for Non-Payment	Reconnect for Payment	Meter Exchange	Back-to-Back
Customer-Device Compatibility Check	X					X
Connect Only If Previously Connected					X	
Create Specific Activity	X					
Create Meter Exchange Field Activity					X	
Update Device	X	X	X	X	X	X
Remote Turn Off Turn On						X
Decommission Removed Meter					X	
Check For Measurement:	X	X	X			X

## Cancel / Update Orchestration - Algorithm Types

Enter algorithms on the "Cancel Specific Activity" and "Update Specific Activity" states attempt to cancel or update a specific child activity. These algorithms are based on the following algorithm types.

- **Cancel Specific Activity:** Algorithms of this type cancel the specific activity (either a service order field activity or a smart meter command) that is associated to the Cancel or Update orchestration activity, based on the current status of the specific activity.
- **Update Specific Activity:** Algorithms of this type update the specific activity (either a service order field activity or a smart meter command) that is associated to the Cancel or Update orchestration activity, based on the current status of the specific activity.

Algorithm Type	Algorithm(s)
Cancel Specific Activity (D1-CANSPACT)	Cancel Specific Activity (D1-CANSPACT)
Update Specific Activity (D1-UPDSPAC)	Update Specific Activity (D1-UPDSPAC)

Use the Algorithm Type and Algorithm portals to view additional details about these algorithms.

## Understanding Service Order Field Activity Types

Service order activity types must be configured for each type of service order activity.

Service order activity types are assigned to the following Activity Type Categories:

Service Order Activity	Activity Type Category
Back-to-Back	Service Request Orchestration

Cancel Orchestration	Orchestration Maintenance
Cut Service for Non-Payment	Request Orchestration
Disable Service	Request Orchestration
Enable Service	Request Orchestration
Exchange Meter	Request Orchestration
Reconnect Service for Payment	Request Orchestration
Update Orchestration	Orchestration Maintenance

Refer to [Understanding Activity Types](#) for more information about activity types.

## Configuring Service Order Activity Types

The Activity Type portal is used to display and maintain service order activity types.

Refer to [Understanding Activity Types](#) for more information.

You can access the portal from the **Admin > Communication > Activity Type**.

The following zones may appear as part of the portal's **Main** tab page:

- **Activity Type List:** This zone works differently than the typical zone that list types in that it displays both those activity types that have been configured as well as those activity types that have yet to be configured. Broadcast a record to display the details of the selected record.
- **Activity Type:** This zone provides information about the selected Activity Type

## Service Order Management Configuration

The following table outlines the activity types that must be configured for the service order activity types supported by Service Order Management:

Service Order Activity	Activity Type (Business Object)
Enable Service	Enable Service (D1-EnableServiceType)
Disable Service	Disable Service (D1-DisableServiceType)
Cut Service for Non-Payment	Cut Service for Non-Payment (D1-CutServiceForNonPaymentType)
Reconnect Service for Payment	Reconnect for Payment (D1-ReconnectForPaymentType)
Meter Exchange	Exchange Meter (D1-ExchangeMeterType)
Back-to-Back Service	Back-to-Back Service (D1-BackToBackServiceType)
Cancel Orchestration	Cancel Orchestration (D1-CancelOrchestrationType)
Update Orchestration	Update Orchestration (D1-UpdateOrchestrationType)

The demonstration database contains examples of each of these service order activity types.

## Setting Up Service Order Field Activities

### Understanding Service Order Field Activities

This section describes service order field activities and how they communicate with field work management systems such as Oracle Utilities Mobile Workforce Management.

Service order field activities are activities that involve sending workers into the field to perform service. This can include meter installation, meter replacement, and other activities.

Service order field activities send messages to a field work system, which in turn assigns them to crews to be completed in the field. Service Order Management supports integration with Oracle Utilities Mobile Workforce Management to support field activities, but can also integrate with other field work systems if needed.

## Service Order Field Activity Information

All service order field activities are based on the Field Activity (D1-FieldActivity) business object, and include the following user-accessible information:

- **Status:** The current status of the service order field activity.
- **Service Date/Time:** The date and time the service order field activity was created.
- **Service Point:** The service point associated with the service order field activity.
- **Field Task Type:** The field task type for the service order field activity. This defines the type of task and other processing details regarding how Service Order Management processes the service order field activity. See [Field Task Types](#) for more details about field task types.
- **Recipient:** The field work system service provider to which the service order field activity is sent for scheduling and assignment.
- **Device ID:** The device related to the service order field activity (if applicable).
- **Request Information:** Details of the service order request, including requester and external system information.
- **Contact Details (or Customer Information):** Contact details for the customer associated with the service order request.
- **Address Information:** The address of the service point associated with the service order field activity.

The field activity business object also contains other information that is populated by algorithms and scripts as the service order field activity is processed by the system.

## How Do Service Order Field Activities Work?

At a high level, service order field activities work as follows:

### Create a Service Order Field Activity Request

A service order field activity request can be as a result of a customer requesting a change to their service; such as, enabling or disabling service when moving into or out of a residence. They can also be the result of other business processes; such as, a request to cut service due to non-payment. Within Oracle Utilities Customer To Meter actions (such as start service, stop service, and cut for non-payment) result in a field activity request being created for each affected service point. These requests are sent to Service Order Management to be performed. In addition to requests that are created with Oracle Utilities Customer To Meter, service order requests can be received from other applications.

### Retrieve Required Data

The service order field activity uses a set of pre-processing algorithms to derive and populate data needed by the activity, such as the device, service point, address, effective date, and others.

### Request Appointment (Optional)

If the service order field activity task type specifies that field tasks of this type require an appointment, the service order field activity checks for available appointment slots in the field work system and sends a notification to the appointment handling system.

## Create Outbound Communication

The service order field activity creates an outbound communication to send the service order field activity to the field work system. The outbound communication gathers the information required by the field work system before being sent. This information is retrieved by a set of processing scripts defined on the field task type.

## Receive Inbound Communication

When the service order field activity has been completed, the field work system sends an inbound communication back to Service Order Management.

Inbound communications can contain Field Activity Remarks (entered by field resources when they perform and complete their field work. If the Field Activity Remarks reference completion events, they are executed.

The inbound communications create completion events as defined on the field task type. If the service order field activity was successfully completed, it creates the "Completion Events When Successful" completion events. If the service order field activity was canceled, it creates the "Completion Events When Canceled" completion events.

## Execute Completion Events

After receiving the inbound communication, a service order field activity algorithm transitions any active completion events into their executed state.

## Complete Processing

The service order field activity completes its processing by doing the following:

- Updating the parent orchestration activity
- Sending a success response to the requester
- Transitioning the parent orchestration activity to the next state in its lifecycle
- Sending a service order field activity completion outbound communication to subscribing systems.

## Service Order Field Activity Processing

This section outlines how service order field activities are processed.

### Pre-Processing, Validation, and Post-Processing Algorithms

When service order field activities are first instantiated, a set of pre-processing algorithms populate and derive information needed for the activity, such as the activity type, service point, device, address, effective date, and other information.

Validation algorithms validate this information when first retrieved and when updated.

When service order field activities are completed, a post-processing algorithm populates the activity end date/time:

### Service Order Field Activity Lifecycle

As a service order field activity moves through its lifecycle, it triggers various business processes based on the type of service order field activity. The table below outlines the lifecycle for the Field Activity (D1-FieldActivity) business object.

---

State	Description
Pending	The initial state for service order field activities.
	An Enter algorithm sends an acknowledgement to the requesting system.
	The activity is transitioned to the next state via a monitor process.

---

State	Description
Validate	<p>Enter algorithms perform the following:</p> <ul style="list-style-type: none"> <li>Validate Activity Type (and transition to error if invalid)</li> <li>Derive and validate service order recipient</li> <li>Validate duplicate and conflict service order activities</li> <li>Derive and validate service order service point</li> <li>Derive and validate service order device</li> <li>Validate address constituents</li> <li>Check for any existing cut service restrictions</li> </ul> <p>The activity is transitioned to the next state via a monitor process.</p>
Validation Error	<p>If the business object fails any of the validations in the Pending state, it enters this state.</p> <p>Enter algorithms perform the following:</p> <ul style="list-style-type: none"> <li>Create a To Do based on specified To Do Type and To Do Role</li> <li>Set the "Allow Child to Transition Parent Activity" flag to yes. This allows the service order field activity to transition the parent orchestration activity if needed.</li> </ul> <p>Activities in this state can be corrected and retried.</p>
Waiting to Request	<p>If a service order field activity has a future effective date, it remains in this state until the effective date is reached.</p> <p>A Monitor algorithm transitions the activity to the next state when the activity's effective date time is reached (process date time &gt;= effective date time).</p> <p>An Enter algorithm sets the "Allow Child to Transition Parent Activity Based On Effective Date" flag to yes. This allows the service order field activity to transition the parent orchestration activity if needed.</p>
Waiting for Appointment	<p>If the service order field activity passes its validations and the effective date has been reached, the activity enters this state.</p> <p>Enter algorithms perform the following:</p> <ul style="list-style-type: none"> <li>Evaluate if an appointment is required for field tasks of this type. If not, the activity transitions to the "Communication in Progress" state.</li> <li>Create a To Do if an appointment is necessary but the system is not able to send an appointment request</li> <li>Set the "Allow Child to Transition Parent Activity" flag to yes. This allows the service order field activity to transition the parent orchestration activity if needed.</li> <li>Send a notification to the appointment handling system</li> </ul> <p>Monitor algorithms perform the following:</p> <ul style="list-style-type: none"> <li>Verify if an appointment has been supplied</li> <li>Send a notification to the appointment handling system</li> </ul> <p>The activity is transitioned to the next state via a monitor process.</p> <p>See <a href="#">Waiting for Appointment</a> for more information about this state.</p>
Communication in Progress	<p>Service order field activities enter this state following the "Waiting for Appointment" or "Retry" states.</p>

State	Description
	<p>Enter algorithms perform the following:</p> <p>Create an outbound communication for the service order field activity (see <a href="#">Communication in Progress</a> for more information)</p> <p>Set the "Allow Child to Transition Parent Activity" flag to yes. This allows the service order field activity to transition the parent orchestration activity if needed.</p> <p>Monitor algorithms perform the following:</p> <p>Check for existing child communications</p> <p>Check that the activity hasn't timed out</p>
Discarded	<p>Activities discarded in other states enter this state.</p> <p>Enter algorithms perform the following:</p> <p>Cancel outstanding outbound communications</p> <p>Cancel outstanding completion events</p> <p>Populate the cancel reason</p> <p>Send a failure notification to the requesting system</p> <p>Transition the parent activity to the " Activity Error" state (see <a href="#">Service Order Orchestration Activity Lifecycle</a> for more information)</p> <p>Check if a Cancel Orchestration activity is required</p>
Communication Error	<p>If an outbound or inbound communication an Error state, the service order field activity enters this state.</p> <p>Monitor algorithms perform the following:</p> <p>Check that the activity hasn't timed out</p> <p>Enter algorithms perform the following:</p> <p>Create a To Do based on specified To Do Type and To Do Role</p> <p>Set the "Allow Child to Transition Parent Activity" flag to yes. This allows the service order field activity to transition the parent orchestration activity if needed.</p> <p>Activities in this state can be corrected and retried.</p>
Retry	<p>When a service order field activity is retried after correction of an error condition, it enters this state.</p> <p>Enter algorithms perform the following:</p> <p>Check to determine if there are associated outbound communications in progress.</p> <p>Cancel any outstanding outbound communications</p>
Execute Completion Events	<p>After an inbound communication is received, it enters this state.</p> <p>Enter algorithms perform the following:</p> <p>Executes completion events defined on the field task type (these completion events were initially created by the inbound communication).</p> <p>Evaluates the "Field Activity Completed" flag on the service order field activity. If this is set to "No", the service order field activity is transitioned to the "Canceled In Field" state.</p> <p>The activity is transitioned to the next state via a monitor process.</p> <p>See <a href="#">Execute Completion Events</a> for more information about this state.</p>

<b>State</b>	<b>Description</b>
Completion Event Error	<p>If an error occurs during completion event processing, the service order field activity enters this state.</p> <p>Monitor algorithms perform the following:</p> <p>Check that the activity hasn't timed out</p> <p>Enter algorithms perform the following:</p> <p>Create a To Do based on specified To Do Type and To Do Role</p> <p>Set the "Allow Child to Transition Parent Activity" flag to yes. This allows the service order field activity to transition the parent orchestration activity if needed.</p> <p>Activities in this state can be corrected and retried.</p>
Completed	<p>Service order field activities enter this state when all completion events have successfully completed.</p> <p>Enter algorithms perform the following:</p> <p>Update the parent orchestration activity</p> <p>Send a success response to the requester</p> <p>Transition the parent orchestration activity to the next state in its lifecycle</p> <p>Send a service order field activity completion outbound communication to subscribing systems.</p>
Canceled in Field	<p>If the "Field Activity Completed" flag on the field activity is set to "No", the service order field activity enter this state.</p> <p>Enter algorithms perform the following:</p> <p>Send a failed response to the requester</p> <p>Transition the parent orchestration activity to the "Activity Error" state.</p> <p>Create a To Do to notify users that the service order field activity has been canceled.</p>

## Waiting for Appointment

When a service order field activity enters the "Wait for Appointment" state, it first determines if an appointment is necessary for the service order field activity. If not, the activity moves on to the "Communication in Progress" state (see below).

If an appointment request cannot be sent for some reason, the service order field activity creates a To Do item to alert a user to attempt to manually request an appointment. Otherwise, the service order field activity sends an outbound message to the field work system requesting an appointment. The outbound message type is derived using the processing role defined on the "Send Notification to Appointment Handling System - Enter" algorithm.

<b>Processing Role</b>	<b>Outbound Communication Business Object</b>
Appointment Response (default)	Send Appointment Response Outbound Message (D1-SendApptRespOutboundMsg)
Used if: An appointment is required and needs to be scheduled	Note: An outbound message must be created based on this business object.



**Processing Role****Outbound Communication Business Object**

---

Appointment has been set

---

The response from the field work system can be received by creating an Inbound Web Service that references the "Book selected appointment to Field Activity" (D1-BookAppt) service script.

While in this state, monitor algorithms verify if an appointment has been supplied and send notifications to the field work system.

**Communication in Progress**

Service order field activity communications are records of messages sent between Service Order Management and an external field work system, such as Oracle Utilities Mobile Workforce Management. Communications can flow both outbound and inbound.

See [Service Order Field Activity Communication](#) for more information about service order field activity communication.

**Execute Completion Events**

After receiving the inbound communication, the service order field activity enters the "Execute Completion Events" state.

The inbound communication will have previously created completion events for the service order field activity, based on those defined on the field task type or those referenced by field activity remarks. These creation events begin in the "Pending" state.

An Enter algorithm transitions completion events associated with the service order field activity into their "Executed" state.

**Service Order Field Activity Communication**

This section outlines how service order field activities communicate with field work systems.

When a service order field activity enters the "Communication in Progress" state, it sends an outbound communication to the field work system, and waits for an inbound communication response.

See **Understanding the Service Order Field Activity Communication Process** below for more information about the role of communications in the service order field activity communication process.

**Outbound Communications**

Outbound Communications represent messages sent from Service Order Management to an external field work system. Outbound communications use the following types of objects:

**Outbound Communication Business Objects**

An outbound communication business object exists for each type of message to be sent to an external system. For service order field activities, the following base package outbound communication objects can be used.

---

**Type of Outbound Communication    Outbound Communication Business Object**

---

Initial service order field activity outbound communication	Field Activity Outbound Communication (D1- FieldActivityOBComm)
--	--

---

Modify outbound communication Used to send an update to a service order field activity previously sent to the field work system.	Field Activity Outbound Communication (D1- ActivityModifyOBComm)
---	---

---

## Outbound Message Types

A outbound message type must also be created for each type of message to be sent to an external system. Again, this is based on the types of messages the system is designed to accept. For service order field activities, the following outbound message types are needed:

Type of Outbound Communication	Outbound Message Type
Initial Service Order Field Activity Message	Field Activity Outbound Message
Modify Existing Service Order Field Activity	Modify Field Activity Outbound Message

Refer to the Oracle Utilities Application Framework documentation for more information about outbound message types.

## External Systems

You must also create an External System for each external system to which Service Order Management will send messages. Each external system defines a set of outbound message types that will be sent to that system. Each external system outbound message type also specifies the following:

- The processing method used to send the message (Batch, XAI, or Real-time)
- Message Sender (if Processing Method is set to Real-time or XAI)
- Batch Control (if Processing Method is set to Batch)
- Message XSL, W3C Schema, and Response XSL (as applicable)

To continue the example above, you might create the following external system:

Outbound Message Type	Processing Method	Batch Control
Field Activity Outbound Message	Batch	Sync Request Monitor (F1-SYNRQ)
Modify Field Activity Outbound Message	Batch	Sync Request Monitor (F1-SYNRQ)

Refer to the Oracle Utilities Application Framework documentation for more information about external systems.

## Inbound Communications

Inbound Communications represent messages sent from an external field work system such as Oracle Utilities Mobile Workforce to Service Order Management. Inbound communications are typically sent in response to a service order field activity. Inbound communications use the following types of objects:

### Inbound Communication Business Objects

An inbound communication business object must be created for each type of message to be received from an external system. For service order field activities, the following base package inbound communication object can be used.

Inbound Communication Business Object
Field Activity Inbound Communication (D1-FieldActivityIBComm)

## Inbound Web Service

You must also create an Inbound Web Service for each type of message to be received from an external system. Inbound web services define the details of how messages are received from an external system, including the inbound communication business object (or business service or service script) to be invoked when the response message is received. As in the case of inbound communication business objects, the set of inbound web services you need to create is based on the types of messages the system is designed to send. To continue the example above, you might create the following inbound web services:

Inbound Web Service	Schema (Inbound Communication Business Object)
Field Activity Inbound Communication	Field Activity Inbound Communication D1-FieldActivityIBComm

Refer to the Oracle Utilities Application Framework documentation for more information about Inbound Web Services.

## Field Activity Remarks

Inbound communications can contain activity remarks, which represent notes entered by the field worker as they perform and complete their field work. These can be solely informational, or can reference completion events via the "Remark Processing" section of the Field Activity Remark Type extendable lookup. This allows information sent with the inbound communication to initiate business processing if necessary.

Completion events specified on this extendable lookup are created by the inbound communication, and then executed when the service order field activity enters the "Execute Completion Events" state.

## Understanding the Service Order Field Activity Communication Process

This section provides an overview of the communication process that takes place when a service order field activity is initiated. For each step in the process, the table below provides a brief description of the processing that takes place, and lists the specific base package objects used by Service Order Management

Note that the process outlined below has been simplified for illustrative purposes, and does not reference every step performed in this process.

Step	Process	Base Package Objects
1.	An orchestration activity creates a service order field activity as part of its processing.  A service order field activity business object is instantiated for the command.	Field Activity Business Object: Field Activity (D1-FieldActivity)
2.	When the service order field activity enters the Communication in Progress state, it creates an outbound communication.	Outbound Communication Business Object: Field Activity Outbound Communication (D1-FieldActivityOBComm)
3.	A Enter algorithm on the "Awaiting Response" state of the outbound communication retrieves information needed by the outbound message to be sent to the field work system based on processing scripts specified on the field task type.	Enter Algorithm: Populate Send Detail for Field Activity (D1-POPSNDDTL)
4.	A Enter algorithm on the "Awaiting Response" state of the outbound communication creates an outbound message.	Enter Algorithm: Create Outbound Message (D1-COUTMSG)  Note: An outbound message type for this message is not included in the base package.

Step	Process	Base Package Objects
5.	<p>The outbound message is sent to middleware components via an External System and Batch Control.</p> <p>Middleware components utilize Business Process Execution Language (BPEL).</p>	<p>External System: MWM</p> <p>Batch Control: Sync Request Monitor (F1-SYNRQ)</p>
6.	<p>The middleware converts the outbound message from SOM format into the format used by the field work system, and sends the message to the field work system.</p>	
7.	<p>When the field work system sends a response, the middleware receives the response message from the field work system, and converts it from the format used by the field work system to SOM format and invokes an Inbound Web Service.</p>	<p>Inbound Web Service: D1-FieldActivityIBComm</p>
8.	<p>The Inbound Web Service picks up the message, and creates a corresponding inbound communication.</p> <p>The specific type of inbound communication business object created is determined by the Inbound Web Service.</p>	<p>Inbound Web Service: D1-FieldActivityIBComm</p> <p>Inbound Communication Business Object: Field Activity Inbound Communication</p> <p>(D1-FieldActivityIBComm)</p>
9.	<p>The inbound communication identifies the parent outbound communication.</p>	<p>Outbound Communication Business Object: Field Activity Outbound Communication</p> <p>(D1-FieldActivityOBComm)</p>
10.	<p>The inbound communication creates the completion events defined on the field activity field task type (Successful or Canceled, as appropriate) in the "Pending" state.</p> <p>If the inbound communication contains field activity remarks, it also executes any field activity remark completion events.</p>	<p>Inbound Communication Business Object: Field Activity Inbound Communication</p> <p>D1-FieldActivityIBComm</p>
11.	<p>The inbound communication updates the outbound communication.</p> <p>This update is performed by an Enter algorithm on the "Completed" Status of the inbound communication business object's lifecycle.</p>	<p>Inbound Communication Business Object: Field Activity Inbound Communication</p> <p>D1-FieldActivityIBComm</p> <p>Outbound Communication Business Object: Field Activity Outbound Communication</p> <p>(D1-FieldActivityOBComm)</p>
12.	<p>The outbound communication updates the "Completion Flag" and the original service order field activity business object.</p> <p>This update is performed by an Enter algorithm on the "Completed" Status of the outbound communication business object's lifecycle.</p>	<p>Outbound Communication BO: Initiate Connect Disconnect (D3-InitiateConnectDisconnect)</p> <p>Field Activity Business Object: Field Activity (D1-FieldActivity)</p>

## Unrelated Pickup Orders

When field work crews are out performing field work, it's possible that they will encounter other work unrelated to their current task that needs to be done. This type of work can be as simple as trimming a tree whose branches are too close to power lines, or the replacement of a meter for a different customer or service point. These types of task are referred to as "unrelated pickup activities." Crews can either work the field activity or leave it to be assigned to another crew at a later date.

When the crew creates an unrelated pickup activity in the field work system, it is sent to Service Order Management, and a corresponding service order field activity is created in the system.

Unrelated pickup activities can be created via one of the following Inbound Web Services:

- Field Activity Asynchronous Req Inbound (D1-FARequestAsynchronous)
- Field Activity Synchronous Req Inbound (D1-FARequestSynchronous)

Once created, they are processed like any other service order field activity. If the pickup activity was completed in the field before being sent to Service Order Management, it will quickly move through its lifecycle (as now further action is needed) until it reaches the "Completed" state.

## Retrieving Service Point Information

If the unrelated pickup activity is customer-related it will require service point information to be created. This information can be queried by the field work crew via the "Field Work Service Point Query" (D1-FieldWorkSPQuery) Inbound web service.

This service uses a set of criteria to allow the field crew to search for a service point based upon either service point or device information. The service returns a list of service points that is configurable in length. If the number of results is larger than the configured maximum length the service indicates that additional records exist and the crew can request another set of results allowing them to identify the proper service point to associate to the activity.

There are times when an unrelated pick-up activity is identified but the field crew is out-of-coverage (i.e. no network connection) and they will not be able to immediately verify service point information. In this type of situation, the crew can input the service point criteria fields and create the activity, which, when imported into Service Order Management, will attempt to identify the service point based upon the information provided. If the service point can be uniquely identified everything should operate as normal. If the service point cannot be uniquely identified then the service order field activity is set to the error state.

## Setting Up Service Order Field Activity Types

### Understanding Service Order Field Activity Types

A single service order field activity type must be configured to support communication with external field work systems such as Oracle Utilities Module Workforce Management. Service order activity types are assigned to the "Field Activity" Activity Type Category.

Refer to [Understanding Activity Types](#) for more information about activity types.

### Configuring Service Order Field Activity Types

The Activity Type portal is used to display and maintain service order field activity types.

Refer to [Understanding Activity Types](#) for more information.

You can access the portal from the **Admin > Communication > Activity Type**.

The following zones may appear as part of the portal's **Main** tab page:

- **Activity Type List:** This zone works differently than the typical zone that list types in that it displays both those activity types that have been configured as well as those activity types that have yet to be configured. Broadcast a record to display the details of the selected record.
- **Activity Type:** This zone provides information about the selected Activity Type

## Service Order Management Configuration

The following table outlines the activity types that must be configured for the service order field activity type supported by Service Order Management:

Field Activity	Activity Type (Business Object)
Field Activity	Field Activity (D1-FieldActivityType)

The demonstration database contains examples of each of these service order activity types.

## Setting Up Field Task Types

### Understanding Field Task Types

A service order field activity's field task type defines details about the type of task to be performed and how the system will process the activity.

#### Field Task Type Information

Field task types are values for the Field Task Type (D1-FieldTaskTypeLookup) extendable lookup. Each field task type value includes the following information:

- **Routing:** Indicates if field tasks of this type can only be performed at a service point. Valid values are "SP Required" and "Pass-Through".
- **Appointment Option:** Indicates if an appointment (via a mobile workforce application) is required or applicable to field tasks of this type. Valid values are "Not Applicable", "Optional", and "Required".
- **Completion Events When Successful:** One or more completion events that are executed upon successful completion of field tasks of this type.
- **Completion Events When Canceled:** One or more completion events that are executed upon cancellation of field tasks of this type.
- **Duplicate Task Type Information:** Defines processing rules for handling potential duplicate field tasks, including:
  - **Allow Duplicates:** Specifies whether or not duplicate field tasks are allowed
  - **Duplicate Threshold:** A number of hours used to determine if a newly instantiated field task type should be considered a duplicate.
  - **Field Task Types:** A list of one or more field task types that are considered to be duplicates of the field task type
- **Conflict Task Type Information:** Defines processing rules for handling potentially conflicting field tasks, including:
  - **Allow Conflicts:** Specifies whether or not conflicting field tasks are allowed
  - **Conflict Threshold:** A number of hours used to determine if a newly instantiated field task type should be considered a conflict.

- **Field Task Types:** A list of one or more field task types that are considered to conflict with the field task type
- **Processing Scripts:** Defines one or more processing scripts to extract supplemental information needed by the mobile workforce application to schedule field tasks of this

## Configuring Field Task Types

Field task types are configured using the extendable lookup portal.

You can access the extendable lookup portal from the **Admin > General > Extendable Lookup**.

Use the **Extendable Lookup Search** zone to search for and select the Field Task Type (D1-FieldTaskTypeLookup) extendable lookup.

The following zones may appear as part of the portal's **Main** tab page:

- **Extendable Lookup List:** This zone displays a list of values for the Field Task Type extendable lookup.
- **Extendable Lookup List:** This zone provides information about the selected value.

## Service Order Management Configuration

The following table outlines the field task types that must be configured to support each of the service order activity types supported by Service Order Management:

Service Order Activity	Field Task Types
Enable Service — Meters	Connect SP at Source: D1-ConnectSPAtSource Connect SP at Meter: D1-ConnectSPAtMeter Connect SP at Source and Turn On: D1-ConnectSPAtSourceAndTurnOn Connect SP at Meter and Turn On: D1-ConnectSPAtMeterAndTurnOn Connect SP at Source and Install Meter: D1-ConnSPAtSrceAndInstMtr Connect SP at Meter and Install Meter: D1-ConnSPAtMtrAndInstMtr Install Meter: D1-InstallMeter Turn On Meter: D1-TurnOnMeter
Enable Service — Items	Connect SP at Source: D1-ConnectSPAtSource Item - Connect SP at Device: D1-ConnectSPAtDevice Item - Connect SP at Source and Turn On: D1-ConnSPAtSrceAndTurnOnDvc Item - Connect SP at Device and Turn On: D1-ConnectSPAtDvcAndTurnOn Connect SP at Source and Install Device: D1-ConnSPAtSrceAndInstDvc Connect SP at Device and Install Device: D1-ConnSPAtDvcAndInstDvc Item - Install Device: D1-InstallDevice Turn On Item: D1-TurnOnItem
Disable Service — Meters	Turn Off Meter: D1-TurnOffMeter
Disable Service — Items	Turn Off Item: D1-TurnOffItem
Cut Service for Non-Payment — Meters	Cut for Non-Payment: D1-CutForNonPayment
Cut Service for Non-Payment — Items	Item - Cut for Non-Payment: D1-CutItemForNonPayment

Service Order Activity	Field Task Types
Reconnect Service for Payment — Meters	Reconnect for Payment: D1-ReconnectForPayment
Reconnect Service for Payment — Items	Item - Reconnect for Payment: D1-ReconnectItemForPayment
Meter Exchange	Exchange Meter: D1-ExchangeMeter
Item Exchange	Exchange Device: D1-ExchangeDevice
Back-to-Back — Meters	Read Meter: D1-ReadMeter

## Defining Credit & Collections Options

**NOTE:**

The functionality described in this section is meant to handle the collection of unpaid balances. If your organization practices [open-item accounting](#) and collects on unpaid bills, you will not use this functionality. Rather, you will use the functionality described under [Defining Overdue Processing Options](#).

The system periodically monitors how much your customers owe to ensure they haven't violated your collection criteria. When a violation is detected, the system generates the appropriate responses (e.g., letters, disconnect notices, collection agency referrals, and eventually write off). This section describes how to set up the tables that control your credit & collections processing.

**WARNING:**

Setting up the credit & collections control tables is as challenging as your organization's collection rules. If you have simple rules then your setup process will be straightforward. If your collection rules are complicated (e.g., they differ based on the type of customer, the type of debt, the age of debt, the type of service, etc.), then your setup process will be more challenging.

## The Big Picture Of Credit & Collections

This section provides an overview of important C&C concepts with which you should be familiar before you set up your C&C control tables.

### Collection Criteria vs. Severance Criteria vs. Write Off Criteria

The following diagram introduces important concepts related to the C&C processes:



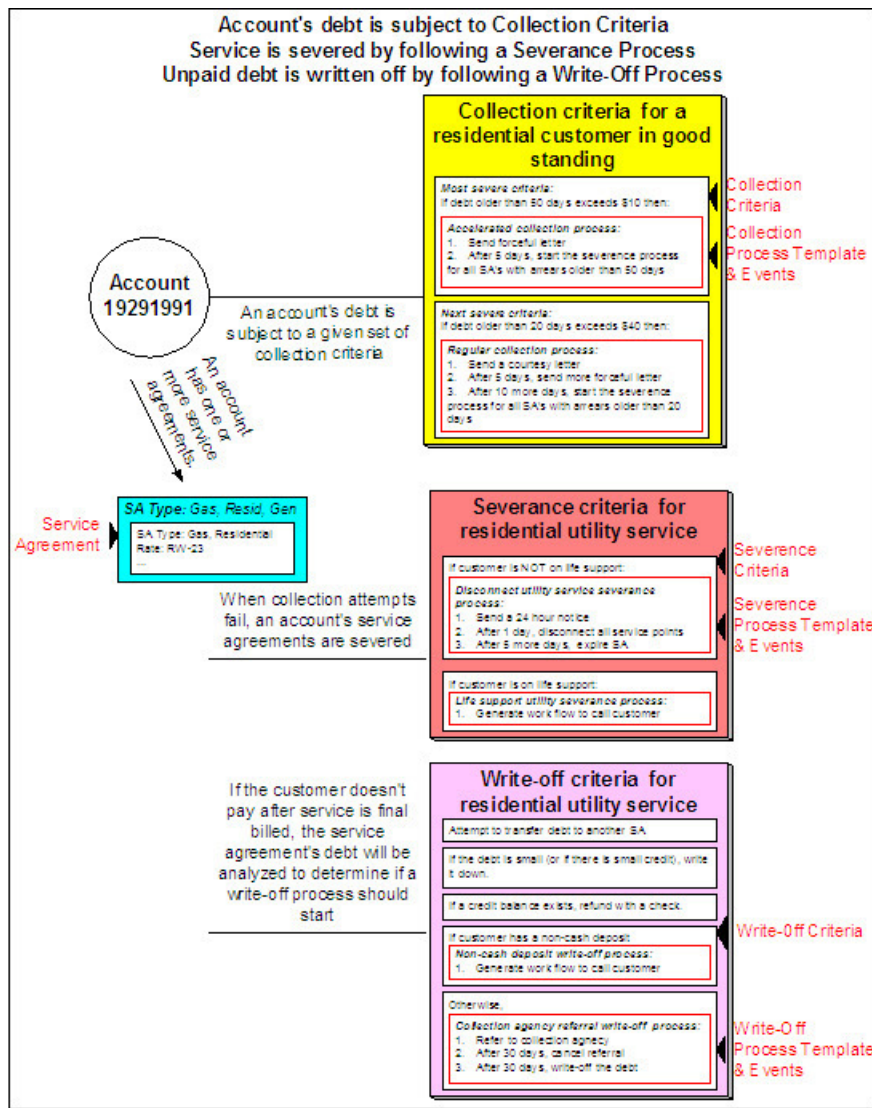

There are many important concepts illustrated above:

An account's debt comes from its service agreements

An account's debt is managed at the service agreement level, i.e., the system keeps track of how much a customer owes in respect of each service agreement. In order to determine an account's balance, the system must add up the debt on each of the account's service agreements.

Collection criteria define intolerable debt

Collection criteria are control data that define intolerable debt. Most criteria are defined using a combination of number of days in arrears and a dollar amount.

Collection criteria may be compared to an account's total debt or to subsets of debt

If your organization has simple collection procedures, you will probably target collection criteria at an account's total debt. However, you have the option of segregating an account's debt into debt classes and targeting the collection criteria at each class. For more information about debt classes, see [Different Collection Criteria For Different Customers And Different Debt](#).

Collection criteria also define what to do when the level of intolerable debt is exceeded

When you define collection criteria, you also define how the system should respond if an account violates your criteria. These collection events are defined in respect of a "collection process template".

There are usually several collection events that take place when criteria are violated

A collection process template usually has several collection events. Each event is meant to prod the customer to pay. The initial collection events are typically letters. If payment is not received after several such attempts, the last collection event typically starts a severance process for each service agreement in arrears.

A severance process template defines how to sever a service agreement

A "severance process template" defines how to sever a given type of service agreement. A severance process template usually contains several severance events. These events are a series of letters and / or disconnection field activities that eventually result in the expiration of a service agreement if payment is not received.

Severance criteria define how to sever service agreements

Severance criteria define the severance process to be executed for service agreements of a given SA type. The severance process may differ depending on some attribute of the customer (or premise). For example, you may have a different severance process if the customer has life support equipment.

After a service agreement is severed, it will be final billed

When the last active service agreement linked to an account is stopped, the system changes the account's bill cycle to bill that evening. If only one of many SAs is stopped, the SA will only be final billed as per the account's original bill cycle schedule.

If a customer doesn't pay their final bill, the account's debt will be analyzed to determine if the system can reduce the debt to zero using a variety of mechanisms

The system will look at an account's finaled debt on its next scheduled credit review date (typically a few days after the bill's due date). The system will attempt to reduce the service agreement's debt to zero using all of the following methods:

- If the account has active service agreements, it will transfer the finaled debt to an active service agreement.
- If the debt or credit amount on the service agreement is small, the system will generate an adjustment to 'write it down' (or up in the case of a small credit).
- If the service agreement has a large credit amount, the system will generate an A/P adjustment (resulting in a check being sent to the customer).

If a customer's finaled debt cannot be reduced via any of the previous methods, the system creates a write-off process

A write-off process contains one or more write-off events. These events can generate a letter, send a To Do entry to a CSR, send a referral to a collection agency, etc.

When you set up the system, you define the type of write-off process to use for every collection class / write-off debt class combination. In addition, you can also indicate when the type of write-off process should differ depending on some attribute of the customer (or premise). For example, you may have a different write-off process if the customer has a non-cash deposit.

The last write-off event typically causes the debt to be written off

Ultimately, if the write-off events fail, the debt will have to be written off. When debt is written-off, the system creates a write-off service agreement and transfers the outstanding debt to it. This means the debt stays with the account for life and will have to be paid off if the customer ever returns.

**NOTE:**

**Checkpoint.** At this point, you should be familiar with the concept that an account's debt is compared to user-defined collection criteria. If the account violates the criteria, a series of events will ensue that prod the customer to pay. If the customer doesn't respond, every service agreement in arrears will be severed (i.e., disconnected). If lack of service doesn't inspire payment, the service agreement will be expired and a write-off process will be created to manage the write-off activities.

## The C&C Monitors

Your collection, severance and write-off criteria described in the previous section exist to support the processes that manage the collection of overdue debt: The following diagram illustrates, at a high level, the major processes that manage the collection of overdue debt:

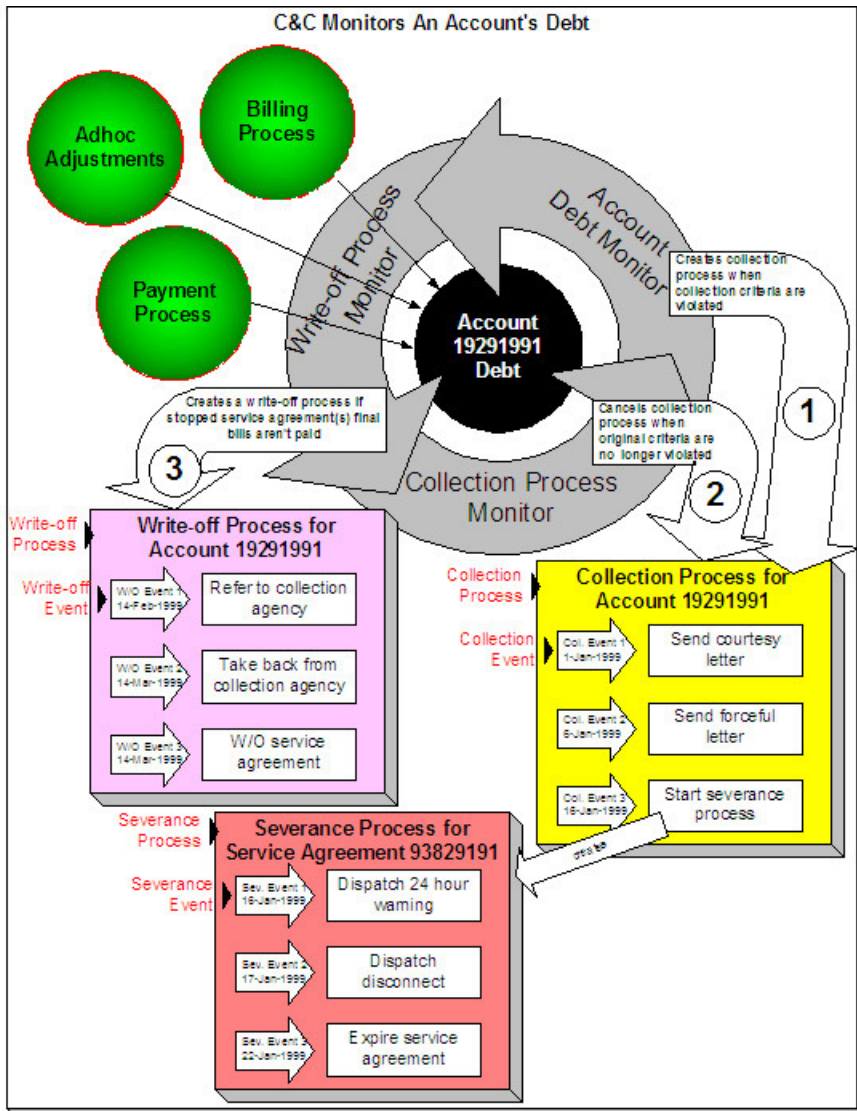

There are many important concepts illustrated above:

Bills, payments and adjustments affect an account's debt	An account's debt is the accumulation of all bills, payments and adjustments.
The Account Debt Monitor creates a collection process when an account violates collection criteria	Periodically, a background process referred to as the Account Debt Monitor determines if an account's debt violates your collection criteria. If so, a collection process is created using the violated criteria's collection process template. Refer to <a href="#">When Is An Account's Debt Monitored?</a> for a description of when an account's debt is compared against collection criteria.
A collection process contains one or more collection events	The collection process contains a series of collection events. These events correspond with the collection event types associated with the collection process template. The initial collection events are typically letters. If payment is not received after several such communications, the last collection event typically starts a severance process for each service agreement in arrears.
The Collection Process Monitor cancels a collection process when warranted	The Collection Process Monitor cancels a collection process when its service agreements satisfy your cancellation criteria (e.g., when the service agreements have less than \$10 of debt older than 20 days). Refer to <a href="#">How Are Collection Processes Cancelled</a> for more information about the cancellation process.
The last collection event starts one or more severance processes	The last collection event typically starts one or more severance processes. A severance process contains the activities necessary to sever a service agreement. The service agreement(s) that are severed may be all SAs that are associated with the collection process. Alternatively, you can nominate a service agreement to act as the primary service to cut (you'd do this if you cut electricity when the customer doesn't pay for their gas). The algorithm on the collection event that starts severance will control which service agreement(s) are severed. Refer to <a href="#">How To Nominate A Single Service Agreement To Sever</a> for more information.
Each service agreement has its own severance process	Every service agreement that is severed has a severance process. The type of process is dependent on the severance criteria linked to the service agreement's SA type.
A severance process contains one or more severance events	The severance process contains a series of severance events. The events correspond with the severance process template's severance events.
The system cancels a severance process when warranted	The system cancels a severance process when its service agreement satisfies your cancellation criteria (note, it is possible to set up the system so that all service agreements in the debt class must satisfy your cancellation criteria before a severance process is cancelled).  It's important to note that the cancellation is real time (as opposed to the cancellation of collection processes, which happens in a background process). Refer to <a href="#">How Are Severance Events Canceled?</a> for more information.
The last severance event should expire the service agreement	The last severance event typically expires its service agreement. When the last service agreement linked to an account is expired, the system will schedule the account for billing (outside of its normal bill cycle schedule).
If you nominate a single SA to sever when multiple SAs are in arrears...	Earlier we indicated that you can nominate a service agreement to act as the primary service to cut (you'd do this if you cut electricity when the customer doesn't pay for their gas). If you do this, you also need

a severance event that will sever all other service agreements in the debt class if the severance of the nominated service agreement doesn't inspire payment. A severance event algorithm to do such is supplied with the base package. Refer to [How To Nominate A Single Service Agreement To Sever](#) for more information.

---

The Write-Off Monitor creates a write off process to collect stopped, unpaid debt

The Write-Off Monitor reviews stopped and reactivated service agreements after their closing bill's due date (plus grace period). The Write-Off Monitor attempts to reduce the service agreement's debt to zero using all of the following methods:

- If the account has active service agreements, it will transfer the finalized debt to an active service agreement.
- If the debt or credit amount on the service agreement is small, the system will generate an adjustment to 'write it down' (or up in the case of a small credit).
- If the service agreement has a large credit amount, the system will generate an A/P adjustment (resulting in a check being sent to the customer).  
If the system is unsuccessful in reducing the account's debt to zero, a write-off process will be created using the appropriate write-off process template. Refer to [The Big Picture Of Write Off Processing](#) for more information about the write-off process.

---

A write-off process contains one or more write-off events

The write-off process contains a series of write-off events. These events correspond with the write-off event types associated with the write-off process template. The initial write-off events are typically collection agency referrals and/or letters. If payment is not received as a result of such efforts, the last write-off event typically writes off the customer's debt.

---

The system cancels a write-off process when warranted

The system cancels a write-off process when its service agreements no longer have debt (i.e., they become closed).

---

Another write-off process will be created if a closed service agreement ever reactivates

If a service agreement becomes reactivated (e.g., because the final payment bounces), the service agreement will be processed by the Write-Off Monitor and the whole write-off process starts again.

---

**NOTE:**

**Checkpoint.** At this point, you should be familiar with the concept that a collection process will be created for an account that violates collection criteria. The collection process consists of a series of events that typically generate letters and / or To Do entries. If the customer doesn't respond, a severance process will be started for one or more service agreements. A severance process consists of a series of events that typically generate letters and/or disconnection field activities. If lack of service doesn't inspire payment, the last severance event expires the service agreement (and a final bill will be scheduled when the last service agreement is expired). If the customer doesn't pay the final bill, a write-off process will be created for each type of unpaid debt. The write-off process consists of a series of events that ultimately result in the write-off of the customer's debt. When debt is written-off, the system creates a write-off service agreement and transfers the outstanding debt to it. This means the debt stays with the account for life (because the write-off service agreement is linked to the account) and will have to be paid off if the customer ever returns.

---

## The Big Picture Of Collection Processes

The topics in this section describe how collection processes are created and cancelled.

**FASTPATH:**

For more information refer to [The Lifecycle Of A Collection Process And Its Events](#).

## How Does The Account Debt Monitor Work?

This section describes how the Account Debt Monitor uses your collection criteria and collection process templates to collect overdue debt.

## Different Collection Criteria For Different Customers And Different Debt

Consider the following:

- You probably have different collection criteria for different jurisdictions (i.e., CIS Divisions). For example, if you have customers in different states / provinces, you may have different regulator-imposed criteria applied to each state's debt. You differentiate your debt in respect of the collection process via the **CIS division code on each customer's account**.
- You probably have different collection criteria for different customer segments. For example, customers with large bills probably have strict criteria, whereas you're probably more lenient with small customers (or vice versa). You differentiate your customers in respect of the collection process via a **collection class code on the customers' accounts**. An account's initial collection class is defaulted from its customer class. You may override an account's collection class at will.
- You probably have different collection criteria for different classes of debt. For example, if a single customer has both regulated and unregulated debt, you probably have commission-imposed criteria to be applied to the regulated debt, but you have the freedom to apply stricter criteria to the unregulated debt. You differentiate your debt in respect of the collection process via a **debt class code on the customers' service agreements** (note: the debt class is actually defined on the service agreement's SA type).
- You will have different criteria for every currency in which you work because the monitoring process always compares a customer's debt against some value and this value must be denominated in the customer's currency. A customer's currency is defined using a **currency code on the account**.

Given the above, you should understand that different collection criteria will exist for every combination of CIS division, collection class, debt class, and currency code. If you're confused, consider the following matrix (where we assume you have a single currency and division and therefore avoid the third and fourth dimensions):

SA's Debt Class	Account's Collection Class:	
	Commercial Customer	Residential Customer
Regulated	N/A - there is no regulated, commercial customer debt.	Highest Priority: If > \$5 in arrears by more than 50 days, create the accelerated collection process for residential customers.  Lower Priority: If > \$25 in arrears by more than 25 days, create the courtesy reminder collection process for residential customers.
Unregulated	Highest Priority: If > \$10 in arrears by more than 50 days, create the accelerated collection process for commercial customers.  Lower Priority: If > \$1000 in arrears by more than 25 days, create the normal collection process for commercial customers.	Highest Priority: If > \$10 in arrears by more than 25 days, create the normal collection process for residential customers.

Charitable Contribution

Highest Priority: If > \$10 in arrears by more than 50 days, create the charitable collection process.

Highest Priority: If > \$10 in arrears by more than 50 days, create the charitable collection process.

---

Also, notice that there can be multiple criteria for each cell in the matrix. What differentiates one collection criteria from another is its priority. The higher priority criteria will be compared first. If the debt meets the criteria, the collection process is initiated and no further comparisons are performed.

---

**FASTPATH:**

For more information about maintaining this matrix, refer to [Setting Up Collection Class Controls](#). For more information about how the system handles an element in this matrix that has multiple criteria, see [How Is An Account's Debt Monitored?](#).

---

## Override Conditions

---

**WARNING:**

Your credit & collection requirements may not require any overrides and therefore this section may not be relevant for your organization.

---

The matrix presented in the previous section showed:

- You can have different collection criteria for different categories of debt and customers.
- When a collection criteria is violated, the system generates a specific collection process.

This works great for many organizations, but if your organization has other factors that affect either the collection criteria OR the collection process that is initiated when the criteria is violated, you may need to use override collection criteria. For example,

- If you have a different collection process for regulated, residential debt during the winter months, you'll need to use override collection criteria (where the override criteria is "if it's winter").
  - If you have different collection criteria for customers with a poor credit score, you'll need to use override collection criteria (where the override criteria is "if the customer's credit rating is poor").
- 

**FASTPATH:**

Refer to [Designing Your Collection Class Control Overrides](#) for more information.

---

This section describes how and when the Account Debt Monitor analyzes an account's debt.

## When Is An Account's Debt Monitored?

The account debt monitor (ADM) analyzes an account's debt at least every X days, where X is defined on the [customer class control](#) associated with the account's customer class and division (in the field Min Credit Review Freq (Days)).

In addition, an account's debt will also be monitored as follows:

- The ADM looks at an account's debt X days after an account's bill due date (X is defined on the account's customer class in the field Collection Grace Days).
- The ADM looks at an account's debt after a payment is canceled when the cancellation reason indicates NSF (non-sufficient funds).



- The ADM looks at an account's debt after a payment arrangement is broken (assuming you use the base package's break payment arrangement plug-in). Refer to [Monitoring Payment Arrangements](#) for more information.
- The ADM looks at an account's debt after a pay plan is broken. Refer to [The Pay Plan Monitor](#) for more information.

## How Is An Account's Debt Monitored?

Assume the following collection control matrix exists for your organization:

SA's Debt Class	Account's Collection Class:	
	Commercial Customer	Residential Customer
Regulated	N/A - there is no regulated, large customer debt	<p>Highest Priority: If &gt; \$5 in arrears by more than 50 days, create the accelerated collection process for residential customers.</p> <p>Lower Priority: If &gt; \$25 in arrears by more than 25 days, create the courtesy reminder collection process for residential customers.</p>
Unregulated	<p>Highest Priority: If &gt; \$10 in arrears by more than 50 days, create the accelerated collection process for commercial customers.</p> <p>Lower Priority: If &gt; \$1000 in arrears by more than 25 days, create the normal collection process for commercial customers.</p>	<p>Highest Priority: If &gt; \$10 in arrears by more than 25 days, create the normal collection process for residential customers.</p>

This matrix contains the information used by the Account Debt Monitor.

### FASTPATH:

For more information about the information in this matrix, refer to [Different Collection Criteria For Different Customers And Different Debt](#).

This matrix can be overwhelming when viewed as a whole. So let's consider how to use it for a specific account's debt and things will become clearer.

First, because an account belongs to a unique collection class, we only have to worry about a single column in the matrix when monitoring an account's debt.

Next, we accumulate the total amount of aged debt for each unique debt class associated with the account's service agreements.

Next, we subject the accumulated aged debt to the override aged debt algorithm (plugged in on the debt class). This algorithm can cause aged debt to be reduced. This is an optional algorithm and is only used if you set up pay plans for customers. Refer to [How Pay Plans Affect The Account Debt Monitor](#) for more information.

Next, we determine if the debt for the debt class violates the collection criteria in the respective matrix element. If so, we kick off a collection process and link the offending service agreements to it. The logic associated with the determination of whether to kick off a collection process is rather sophisticated. The following flowchart explains the exact details.

### NOTE:

**Important.** If a service agreement is part of an ongoing severance process, it will NOT be considered by the Account Debt Monitor (it's already being severed). If a service agreement is stopped, closed, or reactivated, it also will NOT be considered by the Account Debt Monitor (it's already severed).



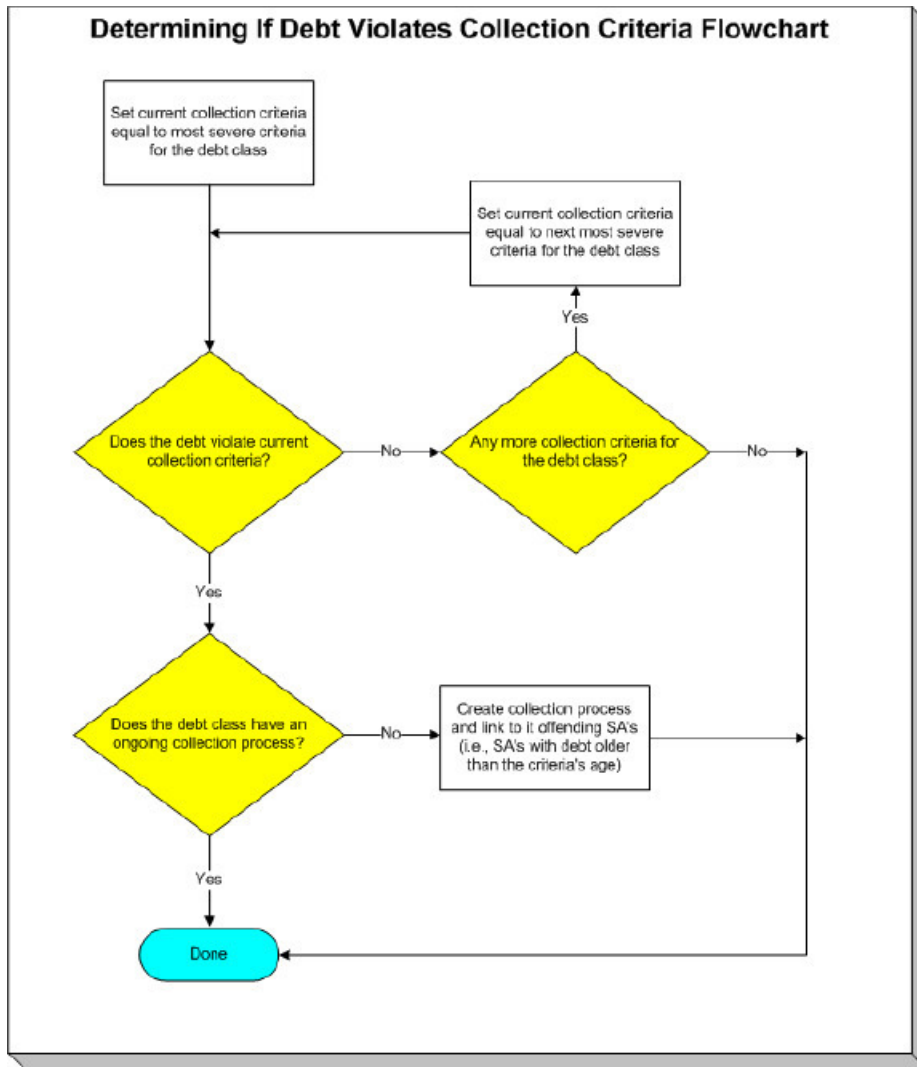

**NOTE:**

**Multiple collection processes may be kicked off.** It's important to be aware that if an account's service agreements reference multiple debt classes, a collection process will be started for each offending debt class.

**One collection process per debt class.** A given debt class for an account may only have one ongoing collection process at any point in time.

## What Happens When A Collection Process Is Started?

When you define collection criteria, you must define the collection process template to use if the criteria are violated. The system uses this template to create the account-specific collection process.

Every service agreement that is part of the offending debt class that has debt older than X days will be linked to the collection process (where X is the debt age on the collection criteria).

Also linked to the collection process will be one or more collection events. These events are typically a series of letters meant to prod the customer (you can also create an event that sends a To Do entry to a user to highlight the offensive debt). You define exactly which letters are generated and when they are generated when you set up the events on your collection process templates.

It's important to note that all of the collection events will be created when the collection process is created. Each of these collection events contains a trigger date. The trigger date of the first event(s) will typically be the current date. The trigger date of the other events will be in the future. Refer to [Calendar vs Work Days](#) for information that describes how the trigger date is set.

A separate process, Activate Collection Events, is responsible for activating collection events whose date is on or before the current date. Activation of an event causes the system to do whatever the event indicates (e.g., send a letter, send a To Do entry to a user, start a severance processes, etc.)

If adequate payments / credits are recorded in the system, the collection process will be cancelled.

---

**FASTPATH:**

For more information about collection process templates, see [Setting Up Collection Process Templates](#). For more information about collection events, see [The Big Picture Of Collection Events](#). For more information about how a collection process is cancelled, see [How Are Collection Processes Cancelled](#).

---

## Experimenting With Alternative Collection Process Templates

The system allows you to determine the efficacy of proposed collection process templates using a small subset of customers before implementing the templates on the entire customer base. We use the term "champion / challenger" to reference this functionality.

We'll use an example to explain. Let's assume your prevailing collection process template for residential customers starts with a "gentle reminder" letter followed 10 days later by a letter threatening collection agency referral if payment is not received. You may want to experiment with the impact of a change to this template. For example, you may want to change the "gentle reminder" to something more assertive and follow this up 5 days later with an even sterner warning. You can use the "champion / challenger" functionality to perform this experiment.

The following points describe how to implement "champion / challenger" functionality:

- Set up a "challenger" collection process template for each template that you want to experiment with.
- Insert a new **Champion/Challenger** option on the Collection Processing [Feature Configuration](#) for every champion template. Each option's value defines:
  - the "champion" collection process template code
  - the "challenger" collection process template code
  - the percentage of the time the system should use the "challenger" template
- Keep in mind that you can only experiment with one challenger template per champion template. For example, let's assume you have two prevailing collection process templates - one for residential customers and another for commercial customers. You can experiment with different challenger templates for the residential and commercial templates. However, you cannot experiment with two different challenger templates for the residential champion template (i.e., a champion template can have 0 or 1 challenger template).

After setting up the above, the [Account Debt Monitor](#) will use the challenger template X% of the time rather than the champion template.

If you are using the Oracle Utilities Analytics product, you can configure analytic zones in innumerable ways to compare the efficacy of the champion versus the challenger. For example,

- You can set up a graph to show the average duration of each type of process.
- You can set up a graph to show the average dollars that were successfully collected.
- You can set up a dimensional scorecard to show how each template performed in different regions (or customer classes or ...).
- Etc (the list is limited by your imagination).

## How Are Collection Processes Cancelled?

A collection process may be cancelled via the mechanisms described in this section.

### The Collection Process Monitor Can Cancel A Collection Process

The Collection Process Monitor (CPM or C1-CPM) is a background process that reviews a collection process when the debt associated with one of its service agreements is reduced. Financial events that can cause service agreement debt to be reduced are:

- The cancellation of a bill segment.
- The creation of a payment segment.
- The creation of an adjustment that credits a service agreement.

The review performed by the CPM occurs as follows:

- **Debt class cancel criteria.** In general, the sum of all debt associated with the collection process's debt class must be less than a given threshold amount for a collection process to be cancelled. If so, the collection process is cancelled.
- Please be aware that, if a [Pay Plan](#) exists for the account and debt class, the customer's debt will be temporarily reduced by the amount of the pay plan's scheduled payments before it is compared to the threshold amount. Please be aware that this temporary reduction will only occur if you have plugged in the appropriate pay plan debt reduction algorithm on the debt class.

---

**NOTE:**

**The above logic is not "hard coded".** The CPM calls the [Collection Process Cancel Criteria Algorithm](#) defined on the debt class that is associated with the collection process. This algorithm will cancel a collection process if the sum of ALL service agreements in the debt class have debt less than a given threshold amount. However, because it's an algorithm, you can introduce whatever cancellation criteria you please.

- 
- **Service agreement cancel criteria.** You can optionally introduce a special quirk to the cancellation logic. This quirk is a bit difficult to understand. To understand it, you should recall:
    - All service agreements that are in arrears in a given debt class are linked to the collection process.
    - The collection event called Start Severance creates a severance process for every service agreement that is in arrears on the collection process (the alternative is to [Nominate A Single Service Agreement To Sever](#)).
    - If you use the Start Severance collection event, you would want to remove a service agreement from a collection process when it no longer has intolerable debt (regardless of the state of the debt class's entire debt). You'd want to do this because, if you don't, the system would start a severance process for the paid up service agreement and if it's paid up, you wouldn't want a severance process created for it.
  - To "remove" service agreements from a collection process when they no longer have intolerable debt, you should plug-in a [Service Agreement-Oriented Cancel Criteria Algorithm](#) on your collection process templates. The CPM will call this algorithm if you've plugged it in.

---

**NOTE:**

When all service agreements are "removed" from a collection process, the CPM cancels all pending collection events and cancels the collection process.

---

**WARNING:**

Checking if individual service agreements should be removed from a collection process is optional (meaning that you don't have to plug one in on the collection process template).

---

## A New Payment Plan Can Cancel A Collection Process

Refer to [Collection Process / Severance Process Cancellation When A Pay Plan Is Created](#) for the details.

---

**NOTE:**

**Real time cancellation.** Please be aware that the system will cancel a collection process real time when a pay plan is created (if the pay plan's scheduled payments are enough to pay-off the customer's outstanding debt).

---

## A User May Cancel A Collection Process At Their Discretion

A user may cancel a collection process at their discretion.

## Stopping A Service Agreement May Cancel A Collection Process

The system will "remove" a service agreement from a collection process when it is stopped (i.e., when the service agreement's status becomes Stopped ). When the last service agreement is "removed" from the collection process, the collection process will be cancelled.

## The Big Picture Of Collection Events

This section describes the various types of collection events and their lifecycle.

## How Are Collection Events Created?

Collection events may be created as follows:

- The Account Debt Monitor creates a collection process when an account violates collection criteria. The collection process has one or more collection event(s). The number and type of events is controlled by the collection process template associated with the collection process.
  - Collection events are created when a user creates an ad hoc collection process. The number and type of events is controlled by the collection process template defined when the collection process is created.
  - An ad hoc collection event may be created and linked to an existing collection process by a user at their discretion.
- 

**NOTE:**

**Bottom line.** Most collection events are created by the system when it creates a collection process for delinquent accounts. If you need to create an ad hoc collection event, you can either create a collection process whose template contains the desired event OR link the desired event to an existing collection process.

---

**FASTPATH:**

---

For more information about the creation of events by the Account Debt Monitor refer to [What Happens When A Collection Process Is Started?](#). For more information about creating ad hoc collection processes, refer to [Collection Process Maintenance](#). For more information about creating ad hoc events, refer to [Collection Process - Events](#).

## Types Of Collection Events

The following table describes the various types of collection events and what happens when they are completed:

Type Of Collection Event	What Happens In The System
Send Letter	<p>A customer contact is created for every financially responsible person linked to the account. The customer contact causes a letter to be produced.</p> <p>The type of letter is defined on the customer contact's contact type.</p> <p>The recipient of each letter is defined on <a href="#">Account / Person</a> (those persons marked as <b>Receiving Notifications</b>).</p>
Create To Do Entry	A To Do entry is created. Refer to <a href="#">The Big Picture of To Do Entries</a> for more information about To Do entries.
Affect Credit Rating/Cash-Only	An account credit rating demerit record is created. The number of demerits is defined on the collection event type.
Cancel Budget	Every service agreement linked to the account that is on a budget is "removed" from the budget (i.e., the recurring charge amount for the service agreement is set to zero). In addition, a syncing adjustment is issued to cause each SA's current balance to be set equal to their payoff balance (the adjustment type is defined on the SA's SA type). Also, the Budget Plan field on the Account - Budget page is cleared.
Generic Algorithm	The algorithm defined on the event's event type is executed.
Start Severance Process	A severance process is created for every service agreement linked to the collection process. The type of severance process is defined on the SA type table (every service agreement references an SA type).

**FASTPATH:**

Refer to [Setting Up Collection Event Types](#) for more information.

## Collection Event Lifecycle

The following diagram shows the possible lifecycle of a collection event:

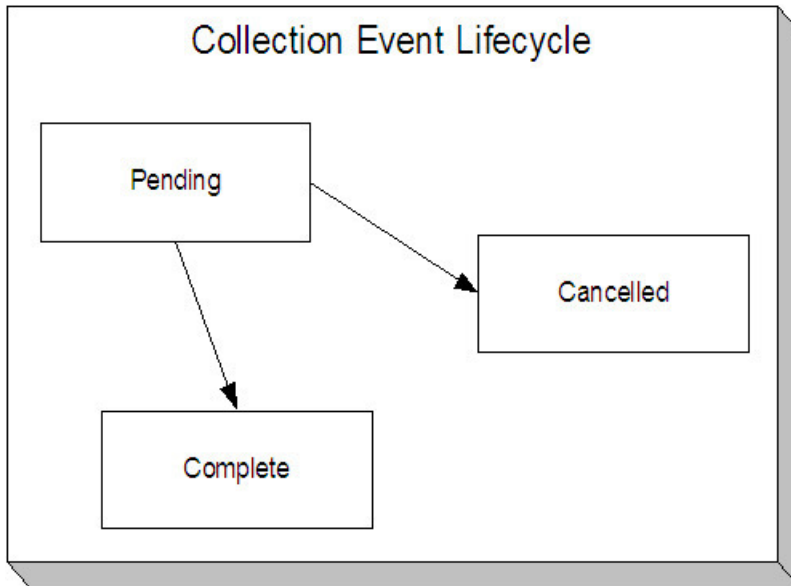

Collection events are initially created in the pending state.

When the system sees a pending event with a trigger date on or before the current date, the system executes the event's activity and completes the event.

---

**FASTPATH:**

For more information about a collection event's trigger date, see [Collection Event Trigger Date](#).

---

A pending event will be cancelled automatically by the system when the account's debt no longer violates the collection criteria that sparked the event's collection process. A pending event may also be cancelled by a user at their discretion. Refer to [How Are Collection Processes Cancelled](#) for more information about how the system will cancel a collection process (and its events).

## Collection Event Trigger Date

When a collection event is created by the system, its trigger date is set in accordance with your date arithmetic preferences. Refer to [Calendar vs. Work Days](#) for more information.

## How Are Collection Events Completed

A background process runs periodically (at least daily) that looks for collection events with a trigger date on or before the current date. For each triggered event, the system executes its activity and then completes it. Refer to [Collection Event Activator](#) for more information.

## The Last Collection Event Should Kick Off Severance Process(es)

The last collection event will typically kick off the severance process for every service agreement linked to the collection process. This will only happen if you set up the collection process template accordingly (i.e., the last event type in the process template is the kind that starts a severance process for every service agreement linked to the collection process).

---

**NOTE:**

**Nominating a service agreement to sever.** Many organizations that have multiple services in arrears will NOT sever every service agreement that's in arrears. Rather, they will nominate one service agreement and use it to encourage the customer to pay for the other services. If your organization works this way, then your last collection event should call the [Nominate A Service Agreement To Sever Algorithm](#).

---

## How Are Collection Events Canceled?

Users can cancel a collection event at their discretion. In addition, the system can cancel a collection event when it automatically cancels a collection process. Refer to [How Are Collection Processes Cancelled](#) for the details.

## The Big Picture Of Severance Process Cancellation

The topics in this section provide high level information about the cancellation of severance processes.

---

**FASTPATH:**

For more information refer to [The Lifecycle Of A Severance Process And Its Events](#).

---

## How Are Severance Processes Cancelled?

A severance process may be cancelled via the mechanisms described in this section.

---

**FASTPATH:**

Refer to [What Happens When A Severance Process Is Cancelled?](#) for what happens when a severance process is cancelled.

---

## The Freezing Of Certain Financial Transactions Can Cancel A Severance Process

**NOTE:**

The system will only cancel a severance process if its severance process template indicates that **Auto Cancel** is allowed. Typically, this switch is set on all severance process templates except for the odd ones that are used to [reconnect service](#).

---

The system reviews a severance process real-time whenever its service agreement's debt is reduced. Financial events that can cause service agreement debt to be reduced are:

- The cancellation of a bill segment.
  - The creation of a payment segment.
  - The creation of an adjustment that credits a service agreement.
- 

**NOTE:**

**Real time cancellation.** Unlike collection processes, the system cancels severance processes real time (i.e., there is no background process that monitors severance processes). Why are severance processes canceled real time? Because a severance process may have events that create field activities to sever service. These events need to be canceled the moment the FT is frozen, we can't wait until a background process runs. This means that if a customer pays in person

for a service agreement that is pending severance, the system will cancel the process and its field activities (if any) the moment the payment is entered.

---

The review takes place as follows:

- **Debt class cancel criteria.** In general, the sum of all debt associated with the severance process's debt class must be less than or equal to a given threshold amount for a severance process to be cancelled. If so, the severance process is cancelled.
- Please be aware that, if a [Pay Plan](#) exists for the account and debt class, the actual debt will be temporarily reduced by the amount of the pay plan's scheduled payments before it is compared to the threshold amount. Note: this temporary reduction will only occur if you have plugged in the appropriate pay plan debt reduction algorithm on the debt class.

**NOTE:**

**The above logic is not "hard coded".** The system calls the Severance Process Cancel Criteria Algorithm defined on the [debt class](#) that is associated with the severance process. This algorithm cancels a severance process if the sum of ALL service agreements in the debt class have debt less than or equal to a given threshold amount. However, because it's an algorithm, you can introduce whatever cancellation criteria you please.

---

- **Service agreement cancel criteria.** You can optionally introduce a special quirk to the cancellation logic. This quirk is a bit difficult to understand. To understand it, you should recall:
  - The collection event called Start Severance creates a severance process for every service agreement that is in arrears. Note: you would only use this type of collection event if you do not [Nominate A Single Service Agreement To Sever](#).
  - If you use the Start Severance collection event, then you would want to cancel a severance process when its service agreement no longer has intolerable debt (regardless of the state of the debt class's entire debt).
- To cancel a severance process when its related service agreement no longer has intolerable debt, you should plug-in a Cancel Criteria Algorithm on your [severance process templates](#). The system will call this algorithm if you've plugged it in.

**NOTE:**

**Manual Creation.** A user can create a severance process for an account that does not qualify to be on severance according to the cancel criteria algorithm. For example, perhaps your cancel criteria algorithm cancels a severance process when the account's debt falls below a threshold amount. A user can create a severance process for an account whose debt is already below this threshold. Because cancellation is real time, there is no action that will cause this severance process to be canceled. When a manual severance process is created, the system executes the appropriate cancellation criteria algorithm. If the algorithm indicates that the system would have canceled this severance process, a warning is issued.

---

## A New Payment Plan Can Cancel A Severance Process

Refer to [Collection Process / Severance Process Cancellation When A Pay Plan Is Created](#) for the details.

---

**NOTE:**

**Real time cancellation.** Please be aware that the system will cancel a severance process real time when a pay plan is created that pays off enough debt.

---

## A User May Cancel A Severance Process At Their Discretion



A user may cancel a severance process at their discretion.

## Stopping A Service Agreement Will Cancel A Severance Process

The system will cancel a severance process if its service agreement is stopped (i.e., when the service agreement's status becomes Stopped).

## What Happens When A Severance Process Is Cancelled?

The following takes place when a severance process is canceled by the system:

- The system cancels all pending severance events and deactivates the severance process.
- If there are any field activities linked to the severance process, an optional plug-in spot defined on the installation record allows you to plug in an algorithm to cancel these field activities.
  - The base package [Severance Process Cancellation Algorithm](#) will cancel all pending field activities that were created as a result of the severance process that are not linked to a dispatched field order.
- If there are any pending field activities left associated with the severance process, it is marked to trigger the creation of a To Do entry to highlight that field activities exist for a canceled severance process. (This happens if you have not plugged in an algorithm to perform the cancellation or if the algorithm detected a condition that prevented cancellation.) To create the To Do entry, you must run the background process [TD-SPRO](#).
- There is an optional plug-in spot defined on the severance process' template. If an algorithm is plugged-in, it is called. The base package algorithm will create a reconnect process if there are completed field activities for a cut for nonpayment severance event associated with the severance process. Refer to [Severance Post Cancellation Algorithm](#) for more information about this algorithm.

## The Big Picture Of Severance Events

This section describes the various types of severance events and their lifecycle:

## How Are Severance Events Created?

Severance events may be created as follows:

- The process that completes (i.e., executes) collection events creates a severance process when it completes a "start severance process" collection event. The severance process has one or more severance event(s). The number and type of events is controlled by the severance process template associated with the severance process. Refer to [The Collection Event Activator](#) for more information about this process.
- Severance events will be created when a user creates an ad hoc severance process. The number and type of severance events is controlled by the severance process template associated with the severance process.
- An ad hoc severance event may be created and linked to an existing severance process by a user at their discretion.

---

### NOTE:

**Bottom line.** Most severance events are created by the system when it creates a severance process for delinquent service agreements. If you need to create an ad hoc severance event, you can either create a severance process whose template contains the desired event OR link the desired event to an existing severance process.

---

---

**FASTPATH:**

For more information about creating ad hoc severance processes and events, refer to [How To Perform Common Severance Process Functions](#).

---

## Types Of Severance Events

The following table describes the various types of severance events and what happens when they are completed:

Type Of Severance Event	What Happens In The System
Send Letter	<p>A customer contact is created for every financially responsible person linked to the service agreement's account. It is the customer contact that causes a letter to be produced.</p> <p>The type of letter is defined on the customer contact's contact type.</p> <p>The recipient of each letter is defined on <a href="#">Account / Person</a> (those persons marked as <b>Receiving Notifications</b>).</p>
Create To Do Entry	<p>A To Do entry is created. Refer to <a href="#">The Big Picture of To Do Entries</a> for more information about To Do entries.</p>
Create Field Activities	<p>A field activity is created for each service point associated with the service agreement being severed. The type of activity is defined on the service point's SP type's field activity type profile.</p>
Generic Algorithm	<p>The algorithm defined on the event's event type is executed.</p>
Expire Service Agreement	<p>The service agreement is expired and, if earlier severance events created "cut for non-payment" field activities, these field activities will be used as the basis for stopping service. Refer to <a href="#">Finalizing Pending Stops</a> for how the system use the meter reads on these field activities as the "stop reads" on the service agreement. Note, you can see the field activities that are used to "cut" and "stop" service by viewing the Field Activities grid on <a href="#">Service Agreement - Service Point</a>.</p>
Affect Credit Rating/Cash-Only	<p>An account credit rating demerit record is created. The number of demerits is defined on the collection event type.</p>

---

**FASTPATH:**

Refer to [Setting Up Severance Event Types](#) for more information.

---

## Field Events Versus Office Events

Severance events are considered either field or office events. Office events are just like collection events in that they don't involve any type of field activity in their completion. Field events, however, are not like collection events because they create one or more field activities. These activities cause these events to have a different lifecycle. Refer to [Severance Event Lifecycle](#) for more information.

## Severance Event Lifecycle

The following diagram shows the possible lifecycle of a severance event:

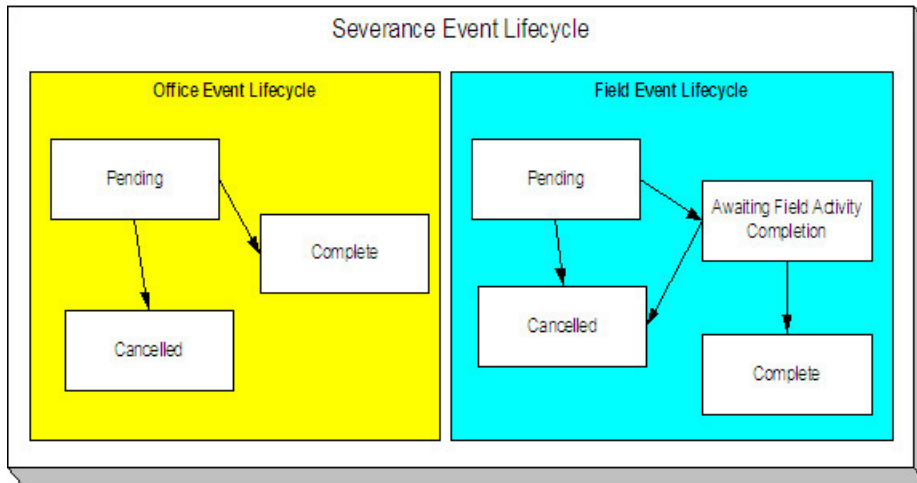

The following points explain the lifecycle of severance events of the office variety:

- Office events are initially created in the pending state.
- A pending office event becomes complete when the system sees that its trigger date is on or before the current date. At this time, the system executes the event's activity (e.g., create a letter, create To Do entry).

**FASTPATH:**

For more information about a severance event's trigger date, see [Severance Event Dependencies & Trigger Date](#).

- A pending office event will be cancelled automatically by the system when the debt associated with the severance process's service agreement is sufficiently reduced. A pending office event may also be cancelled by a user at their discretion. Refer to [How Are Severance Processes Cancelled](#) for more information about how the system will cancel a severance process (and its events).

The following points explain the lifecycle of severance events of the field variety:

- Field events are initially created in the pending state.
- A pending field event becomes awaiting field activity completion when the system sees that its trigger date is on or before the current date. At this time, the system creates the field activities associated with the given event (e.g., disconnection warning, disconnect for nonpayment, etc.).

**FASTPATH:**

For more information about a severance event's trigger date, refer to [Severance Event Dependencies & Trigger Date](#). For more information about the field activities that are created for a field severance event, refer to [Field Events And Their Activities](#).

- An awaiting field activity completion field event becomes complete when the system sees that its field activities are all complete or cancelled.
- A pending field event will be cancelled automatically by the system when the service agreement associated with the severance event's severance process has sufficient credits. A pending field event may also be cancelled by a user at their discretion.
- An awaiting field activity completion field event will be cancelled automatically by the system when the service agreement associated with the severance event's severance process has sufficient credits if the field activity has not been dispatched (refer to [Designing Your Reconnection Procedures](#) for information on how the system handles the situation if the field activity is completed or dispatched). An awaiting field activity completion event may also be cancelled by a user at their discretion.

## Severance Event Dependencies and Trigger Date

When a severance event is created by the system, its trigger date cannot be set. This is because, unlike collection events, the trigger date on severance events can only be set when ALL of the preceding severance events on which it depends are complete. An example will help explain why this design is necessary. Consider the following example that shows a standard severance process and its events:

Event Number	Severance Event	Dependent On Event(s)	Trigger Date Set To X Days After Completion Of Preceding Events
10	Field activity - Disconnect for non-payment warning	N/A - first event	0
20	Field activity - Disconnect for non-payment	10	2
30	Create To Do entry	20	0
40	Send letter to customer	20	0
50	Expire service agreement	20	10

This severance process is meant to execute as follows:

- On the first day, generate a 48-hour warning of impending disconnection. This is a field event as most organizations deliver this warning in person.
- After 2 days (i.e., 48 hours) have passed, create a field activity to disconnect for non-payment.
- When this is completed, generate a To Do entry to let a CSR know about the cutoff. Also, send a letter to the customer.
- If after 10 days from the cutoff, we still don't have payment, expire the service agreement.

As can be seen from the above example, the later events are dependent on the completion of the field activities in the earlier events. This means that when you set up a severance event, you must indicate the events on which it depends (and the number of days after their completion that the event should be triggered).

---

### NOTE:

**Bottom line.** The system sets the trigger date on severance events when it detects that all of its dependent events are complete (this is the responsibility of the SED background process). Refer to [Calendar vs Work Days](#) for a description of your choices in respect of how the trigger date is calculated.

---

## Field Events And Their Activities

When the system is told to start a severance event that creates field activities (e.g., disconnect for non-payment), it will generate a field activity for every service point linked to the service agreement.

The question is, where does it get the field activity type associated with the field activities? The answer is explained below:

- Every service point has an SP type.
- Every SP type references a field activity type profile.
- A field activity type profile contains a matrix defining activity types to generate under various situations. Some of these situations are those associated with severance.

---

### FASTPATH:

For more information, refer to [Setting Up Field Activity Type Profiles](#).

---

## Severance Event Activation & Completion

A background process runs periodically (at least daily) that looks for severance events with a trigger date on or before the current date. This process executes the activity associated with each event. If the event is an office event, the event then becomes complete. If the event is a field event, the event becomes "awaiting field activity completion" until the field activities are complete. At this time, the severance event is completed. Refer to [Severance Event Activator](#) for more information.

## How Are Severance Events Canceled?

Users can cancel a severance event at their discretion. In addition, the system can cancel a severance event when it automatically cancels a severance process. Refer to [How Are Severance Processes Cancelled](#) for the details.

## The Big Picture Of Write Off Processing

Before you financially write-off debt, most companies go to some effort to collect the past due funds. You control exactly what happens by setting up the various write-off control tables. The topics in this section provide background information that will help you understand how the information in these control tables is used.

## How Is Debt Financially Written-Off?

Before debt can be written-off, a write-off service agreement must exist for the account. Why? Because when you write-off a normal service agreement's debt, you are actually transferring its debt to a write-off service agreement.

A write-off service agreement is just like other service agreements in that:

- It holds debt.
- When a payment is received, the service agreement's debt is reduced.

Debt is transferred to a write-off service agreement (WO SA) from the customer's uncollectable service agreements (SAs). The following points highlight important characteristics about the uncollectable SAs and the WO SA:

- The WO SA and the uncollectable SAs should be linked to the same account (note: this isn't a strict rule, it just makes sense because an account's written off funds should be linked to the account).
- Debt may be transferred to a WO SA from any type of service agreement regardless of debt class, i.e., a WO SA can contain debt that originated in any debt class.
- When you transfer debt from the uncollectable SAs to the WO SA, the debt is removed from the uncollectable SAs (and their status becomes closed - assuming their balance becomes zero).
- If you use the system's automated write-off processing, the system will create WO SAs for you. The system's automated write-off processing can write-off revenue in a different manner than is used to write-off liabilities. Refer to [The Ramifications of Write Offs in the General Ledger](#) for more information.
- WO SAs are immune from the account debt monitor (assuming their debt class is marked as not being subject to collection activities).
- WO SAs are not billed (assuming their SA type is marked as being not billable).

- WO SAs start their life with a non-zero payoff and current balances (i.e., they have debt when first started). This debt is transferred from the normal service agreement(s) whose uncollectable debt necessitated the creation of the WO SA.
- If the customer pays off the write-off debt, the WO SA remains active in case you ever need to write-off debt in the future. If you don't like the WO SA remaining active after it's paid off, you can indicate on the WO SA's SA Type that it is a "one time charge", this will cause the WO SA to be automatically closed when it's paid off.
- You can transfer additional uncollectable debt to the WO SA.

**NOTE:**

**Bankruptcy write-offs.** If you have to write-off debt because a customer declares bankruptcy, everything stated above is true. The only thing you have to do is use a different SA type for bankruptcy write-offs as compared to "normal" write-offs. On the bankruptcy write-off SA type, simply leave the payment segment type blank - this way the system will never distribute a payment to the bankrupt debt (because bankrupt debt is legally uncollectable).

## The Ramifications of Write Offs in the General Ledger

**WARNING:**

If you practice cash accounting, refer to [Cash Accounting and Write-Offs](#).

When you write-off unpaid debt, you shouldn't book it all to a write-off expense account. Why? Because the debt that you're writing off typically contains both revenue and liabilities. At write-off time, you typically want to:

- Book the written off revenue to a write-off expense account, and
- Reduce the liabilities (you don't owe the liability if you don't get paid).

Consider the following example of a simple electric service agreement with two financial transactions:

Event	GL Accounting
Customer is billed	A/R 1000
	Revenue <900>
	State Tax Payable - Taxing State - California <80>
	City Tax Payable - Taxing City - San Francisco <20>
Customer is levied a late payment charge	A/R 50
	Late Payment Revenue <50>

After these two financial transactions are booked, the customer has debt of \$1050. Of this \$1,050; \$950 is revenue and \$100 is liability (money you owe the taxing authorities).

If the customer doesn't pay, you will eventually have to write-off this debt. Most organizations would issue the following types of financial transactions to do this:

Event	GL Accounting
Write-off the bill	Write-off Expense 900
	State Tax Payable - Taxing State - California 80
	City Tax Payable - Taxing City - San Francisco 20
	A/R <1000>
Write-off the late payment charge	Write-off Expense 50

Notice in the above transactions, the two separate revenue accounts are written off by booking to an expense account. However, the liability accounts are reversed. Why is revenue treated differently from liabilities at write-off time? There's a good reason for it (if you're an accountant), for the time being, just accept that this is how it works.

And finally, we need to worry about what happens if the customer eventually pays off his written off debt. If this happens, most organizations would pay off the write-off first, and, if there was still money left, they'd reimburse the taxing authorities. If we assume the customer pays off the entire written off debt, the following financial transactions would be issued:

Event	GL Accounting
Pay off the written off debt	Cash 900
	Write-off Expense <900>
Reinstate the liabilities	Cash 100
	State Tax Payable - Taxing State - California <80>
	City Tax Payable - Taxing City - San Francisco <20>

While the reinstatement of liabilities at payment time is possible in the system, the ramifications of doing such make this approach impracticable (the ramifications are a) if the check bounces, we would not be able to reduce the liabilities, and b) if there was a partial payment of the liabilities, the remaining unpaid amount could get written down). Therefore, when a write-off is paid the following financial transactions should be issued:

Event	GL Accounting
Pay off the written off debt	Cash 900
	Write-off Expense <900>
Reinstate the liabilities	Cash 100
	Reinstated liabilities <100>

Notice that rather than reinstating the individual liabilities, we simply reinstate all liabilities into a single account. This means your accountants will have to distribute this money to the appropriate liabilities manually.

So, how do we achieve the above in the system? This explanation is a little complicated, but it'll make sense if you keep the above financial transactions in mind:

- First of all, you'll need two different SA types - one to hold the written off revenue and another to hold the reduced liabilities.
  - On the SA type that holds written off revenue, indicate that it is not billable, indicate that it cannot have excess credits, and give it a high payment distribution priority. The distribution code on this SA type should reference your Write-off Expense account.
  - On the SA type that holds the reduced liabilities, indicate that it is not billable, indicate that it cannot have excess credits, and give it a high payment distribution priority. The distribution code on this SA type should reference a the "reinstated liabilities" GL account.

Next, you need to understand how the system's standard write-off logic works:

- The system accumulates the distribution codes from GL details associated with recent financial transactions linked to the service agreement being written-off.
- When the system has accumulated enough distribution codes (i.e., where the amount associated with the distribution code equals or exceeds the amount to write off), the debt will be transferred to a new or existing write-off service agreement(s). The number and type of service agreements to which the bad debt is transferred is defined on the distribution codes. Refer to [Setting Up Distribution Codes](#) for how to define the type of write-off service agreement

associated with a distribution code. In our example, we'd need the two SA types described above - one for the revenue accounts, the other for the liability accounts.

- At write-off time, for those distribution codes associated with revenue, the system will create a transfer adjustment from the normal service agreement to the write-off revenue service agreement. This will reduce (credit) the receivable on the normal service agreement and increase (debit) the expense account defined on the write-off revenue service agreement.
- However, if we do the above for the distribution codes associated with liabilities, we have a problem. The problem is a bit hard to explain unless you understand tax accounting, but it basically comes down to this - if we simply transfer the portion of the receivable balance associated with the liabilities to the write-off liability SA, we will always be debiting the distribution code defined on the SA type. This isn't correct because we really want to debit the liability account (and reference the characteristic type and value from the original credit) when we reduce the liability. So how do we do this? For those distribution codes associated with liabilities, you need to indicate that you want to override the distribution code on the "transfer to" side of the transfer adjustment with the distribution code / characteristic type / characteristic value that was originally booked. Refer to [Setting Up Distribution Codes](#) for how to indicate you want to override the distribution code at write-off time. If you do the above, then at write-off time the transfer adjustment will reduce (credit) the receivable on the normal service agreement and increase (debit) the original liability accounts from the original financial transactions.

If you followed the above, you'll see that we now have everything debited and credited appropriately. And, if a payment materializes for the written off debt, we will simply debit cash and credit the distribution code on the respective SA (either Write Off Expense or Reinstated Liabilities).

---

**NOTE:**

**Batch and real-time write-offs may use the above processing.** The above logic is executed real time when a user writes off debt using the [write-off transaction](#) (assuming the base package [write off algorithm](#) is plugged into the account's [customer class](#)). The above logic is executed in batch when a write-off event that references a Write Off Using Distribution Codes [event type](#) is executed. Write-off events are described in detail below.

---

## Automated versus Manual Write Offs

The system will automatically create write-off SAs and transfer uncollectable debt to them during the automated write-off processing described below.

If necessary, you can write-off debt outside of the automated write-off process using either of the following methods:

- You can transfer bad debt from any service agreement to a write-off service agreement using a transfer adjustment.
- You can use the [write-off transaction](#) to write-off debt real-time. When this transaction is used, the system executes the logic embedded in the Write Off Method algorithm that's plugged in on the account's [customer class](#).

## How Does The Write-Off Monitor Work?

This section describes how the [Write Off Monitor](#) uses your write-off criteria and write-off process templates to collect overdue debt.

## Different Write-Off Criteria For Different Customers And Different Debt

Consider the following:

- You probably have different write-off criteria for different customer segments. For example, customers with large bills probably have strict criteria, whereas you're probably more lenient with small customers (or vice versa). You differentiate your customers in respect of the collection process via a **collection class code on the customers' accounts**.



An account's initial collection class is defaulted from its customer class. You may override an account's collection class at will.

- You probably have different write-off criteria for different classes of debt. For example, if a customer has both regulated and unregulated debt, you probably have commission-imposed criteria to be applied to the regulated debt, but you have control over how to write-off unregulated debt. You differentiate your debt in respect of the collection process via a write-off **debt class on the customers' service agreements** (note the write-off debt class is actually defined on the SA type and every service agreement has a SA type).

**NOTE:**

**Write Off Debt Class vs. Regular Debt Class.** It's important to be aware that a SA type references both a regular debt class and a write-off debt class. The regular debt class controls the collection criteria applied against an account's service agreements. The regular debt class is also used to segregate an account's outstanding balance on several queries in the system. The write-off debt class controls the write-off criteria applied against an account's stopped service agreements. The reason the system supports two different debt classes is because you may categorize your service agreements differently when you try to collect overdue debt versus when you write-off debt.

Given the above, you should understand that different write-off criteria will exist for every combination of collection class and write-off debt class. If you're confused, then consider the following matrix:

SA's Write-Off Debt Class	Account's Collection Class:	
	Commercial Customer	Residential Customer
Regulated	N/A - there is no regulated, commercial customer debt.	Attempt to reduce the SA's balance to zero using the following methods:  Synchronize current balance with payoff balance.  Attempt to transfer debt to another active service agreement linked to the account.  If the debt is < \$10 and > \$-1, write down the debt using a write-down adjustment.  If the debt is <= \$-1, create an A/P adjustment to refund the credit to the customer.  If debt remains, create the default write-off process for regulated debt.
Unregulated	Attempt to reduce the SA's balance to zero using the following methods:  Synchronize current balance with payoff balance.  Attempt to transfer debt to another active service agreement linked to the account.  If the debt / credit is < \$10 and > \$-10, write down the debt using a write-down adjustment.  If the debt / credit is <= \$-10, create an A/P adjustment to refund the credit to the customer.  If debt still remains:  Highest priority: If customer has a non-cash deposit, create the non-cash deposit write-off process.	Attempt to reduce the SA's balance to zero using the following methods:  Synchronize current balance with payoff balance.  Attempt to transfer debt to another active service agreement linked to the account.  If the debt is < \$10 and > \$-1, write down the debt using a write-down adjustment.  If the debt is <= \$-1, create an A/P adjustment to refund the credit to the customer.  If debt remains, create the default write-off process for unregulated residential debt.

Otherwise, create the default write-off process  
for unregulated commercial debt.

---

Notice that each cell in the matrix has the same pattern:

- The system first attempts to reduce the SA's current and payoff balances to zero using the following methods (assuming you have set up the write-off control appropriately):
  - Sync the current balance with the payoff balance. If the SA's payoff balance is zero, this will cause the current balance to become zero and therefore close the SA.
  - If there's a debit balance, transfer the debt to any pending start or active SA in the same write-off debt class.
  - If there's a credit balance, transfer the debt to any non-closed / non-cancelled SA in the same write-off debt class
  - If the remaining debit / credit balance is within a user-defined tolerance (this is defined on the respective algorithm on the write-off control), create an adjustment to write-down the small balance.
  - If a credit balance remains, create an A/P adjustment to refund the balance with a check (the adjustment type is defined on the respective algorithm on the write-off control).
- All of the above points will cause the SA to close. If debt remains, the system starts some type of write-off process. The type of process is dependent on the respective criteria. What differentiates one write-off criteria from another is its priority. The higher priority criteria will be compared first. If the customer / debt meets the criteria, the write-off process is initiated; no further comparisons are performed.

---

**FASTPATH:**

For more information about maintaining this matrix, refer to [Setting Up Write-off Control](#).

---

## When Is Debt Monitored For Write Off Purposes?

The write-off monitor only reviews a service agreement when the following conditions are true:

- The service agreement is stopped and reactivated.
- If the service agreement is a "billable charge" SA (as identified on its SA type), all of its billable charges must appear on a bill segment AND the bill segment's bill's due date plus grace period must be on or before the business date.
- If the service agreement is not a "billable charge" SA AND it is billable (as identified on its SA type), the SA must have a closing bill segment (i.e., it must be final billed) and the bill segment's bill's due date plus grace period must be on or before the business date.
- If the service agreement is a sub SA, its master SA must abide by the above conditions.
- If the service agreement is not billable, it is possible that adjustments, which affect the SA's debt, exist. The write-off monitor will only review a non-billable SA if all FTs for this SA that have been marked to include on a bill have been swept onto a bill and the bill for any of these FTs has a bill due date plus grace period on or before the business date.

---

**NOTE:**

**Postponing write-off processing.** You can prevent the write-off process from processing an eligible service agreement by populating the account's C&C Postpone Date with a future date.

---

## Attempt To Close The SA Before Creating A Write Off Process

Before the write-off monitor creates a write-off process for a stopped and reactivated service agreement, it attempts to reduce the service agreement's debt to zero using all of the following methods:

- If the account has active service agreements, it will transfer the finalized debt to a pending start or active service agreement.
- If the debt or credit amount on the service agreement is small, the system will generate an adjustment to 'write it down' (or up in the case of a small credit).
- If the service agreement has a large credit amount, the system will generate an A/P adjustment (resulting in a check being sent to the customer).

---

**NOTE:**

**Plug-in algorithms do the work.** Algorithms that are plugged-in on the [write-off control](#) responsible for managing the service agreement's debt actually perform the above effort. You can customize these algorithms to behave exactly how your collections staff desires.

---

If the algorithms responsible for the above effort are successful in reducing the service agreement's debt to zero, then the service agreement closes and will not be subject to write-off processing. If the above algorithms don't result in the service agreement's debt being reduced to zero, a write-off process will be started (as describe below).

## What Happens When A Write-Off Process Is Started?

When you define write-off criteria, you must define the write-off process template to use if the criteria are violated. The system uses this template to create the account-specific write-off process.

Every stopped or reactivated service agreement that is part of the offending write-off debt class will be linked to the write-off process.

Also linked to the write-off process will be one or more write-off events. These events are meant to prod the customer. You define the types of events and when they are generated when you set up your write-off process templates.

It's important to note that all of the write-off events will be created when the write-off process is created. Each of these write-off events contains a trigger date. The trigger date of the first event(s) will typically be the current date. The trigger date of the other events will be in the future. Refer to [Calendar vs Work Days](#) for a description of how the trigger date is calculated.

A separate process, Activate Write-off events, is responsible for activating write-off events whose date is on or before the current date. Activation of an event causes the system to do whatever the event indicates (e.g., send a letter, send a To Do to an operator, refer debt to a collection agency, etc.)

---

**NOTE:**

**Multiple write-off processes may be kicked off.** It's important to be aware that if an account's service agreements reference multiple write off debt classes, a write-off process will be started for each offending write off debt class that has stopped or reactivated service agreements.

---

**FASTPATH:**

For more information about write-off process templates, see [Setting Up Write Off Process Templates](#). For more information about write-off events, see [The Big Picture Of Write-off Events](#). For more information about how a write-off process is cancelled, see [How Does A Write-Off Process Get Cancelled?](#).

---

## How Does A Write-Off Process Get Cancelled?

The system "removes" a service agreement from a write-off process when its status becomes closed (i.e., when its balance is zero). When all service agreements are removed, the system cancels all pending write-off events and deactivates the write-

off process. When the write-off process is deactivated, all collection agency referrals associated with the write-off process are cancelled.

---

**NOTE:**

**Removing closed service agreements from a write-off process.** Service agreements aren't actually removed from the process. Rather, they are inactivated so a proper audit exists.

---

## How Do Collection Agency Referrals Work?

The following points describe how collection agency referrals work.

- A write-off process has one or more events. One type of event causes overdue debt to be referred to a collection agency.
- When a referral write-off event is activated, the system marks the event for processing by the event's Collection Agency Referral Algorithm (refer to [Setting Up Write Off Event Types](#) for more information).
- The next time the Collection Agency Referral process executes (the frequency is dependent on your background process schedule), it will refer the process' debt to a collection agency. The specific agency to which the debt is referred is controlled by the event type's Collection Agency Referral Algorithm. The sample algorithm supplied with the system simply refers debt to the collection agency with the least amount of referred debt. If you prefer different logic, you must write your own algorithm.
- Regardless of the manner in which a collection agency is selected for an account's debt, the referral involves the creation of a collection agency referral history record. Refer to [Collection Referral](#) for more information.
- A collection agency referral history record is linked to an account. It contains the amount of debt referred to the collection agency. It is the creation of this record that, in turn, triggers the interface of information to the collection agency. The method used to interface the information to the agency is defined on the collection agency's record. Refer to [Setting Up Collection Agencies](#) for more information.
- If the collection agency is successful in obtaining the funds, simply add a payment. If the payment causes the SA's balance to become zero, the system will automatically close the service agreement. When the system closes a service agreement, it is "removed" from the write-off process. When a write-off process no longer contains active service agreements, the system cancels the write-off process. When a write off process is cancelled, all collection agency referrals are automatically cancelled.
- Collection agency referrals get cancelled by the creation of a new collection agency referral history record (with a type of cancel ). This record will be interfaced to the agency in the same manner used to interface a new referral (see above).
- If the collection agency is not successful in obtaining your funds after a given amount of time, you probably want to cancel the referral and write-off the debt. The cancellation of the referral will happen automatically if you design your write-off process to generate a collection agency cancellation X days after the referral. Refer to [Setting Up Write Off Process Templates](#) for how to do this. You can cancel a referral manually by simply creating a new collection agency referral history record (with a type of cancel ).

---

**FASTPATH:**

When you enable the Control Central alert algorithm, [C1-COLL-REF](#), an alert displays when an account has an active collection agency referral. This algorithm is plugged-in on the [installation record](#).

---

## The Big Picture Of Write-off Events

This section describes the various types of write-off events and their lifecycle.

## How Are Write-off Events Created?

Write-off events may be created as follows:

- The Write-Off Monitor creates a write-off process when an account has unpaid, final billed service agreements. The write-off process has one or more write-off event(s). Refer to [How Does The Write-Off Monitor Work?](#) for more information about how the system creates write-off processes and their events.
- Write-off events are created when an operator creates an ad hoc write-off process. The number and type of events is controlled by the write-off process template defined when the write-off process is created.
- An ad hoc write-off event may be created and linked to an existing write-off process by an operator at their discretion.

---

### NOTE:

**Bottom line.** Most write-off events are created by the system when it creates a write-off process for unpaid, finalized service agreements. If you need to create an ad hoc write-off event, you can either create a write-off process using a template that contains the desired event OR link the desired event to an existing write-off process.

---

### FASTPATH:

For more information about creating ad hoc write-off processes and events, refer to [How To Perform Common Write-off Maintenance Functions](#).

---

## Types Of Write-off Events

The following table describes the various types of write-off events and what happens when they are completed:

Type Of Write-off Event	What Happens In The System
Affect Credit Rating/Cash-Only	An account credit rating demerit record is created. The number of demerits is defined on the write-off event type.
Cancel Agency Referral	All collection agency referrals associated with the write-off process will be cancelled.
Refer to Agency	The debt associated with the SAs linked to the write-off process will be referred to a collection agency.
Send Letter	A customer contact is created for every financially responsible person linked to the account.  The customer contact causes a letter to be produced. The type of letter is defined on the customer contact type control table.  The recipient of each letter is defined on <a href="#">Account / Person</a> (those persons marked as <b>Receiving Notifications</b> ).
Send To Do	A To Do entry is created. Refer to <a href="#">The Big Picture of To Do Entries</a> for more information about To Do entries.
Write Off using Distrib Code	This type of event is used to write-off bad debt in accordance with the distribution codes associated with the financial transactions that caused the debt in the first place. You'd use this method for example if you want to write-off revenue differently than you write-off liabilities.  The system accumulates the distribution codes from GL details associated with recent financial transactions linked to each write-

off service agreement. When the system has accumulated enough distribution codes (i.e., where the amount associated with the distribution code equals or exceeds the amount to write off), the debt will be transferred to a new or existing write-off service agreement. The type of service agreements to which the debt is transferred is defined on the distribution codes.

---

Write Off using SA Type

The service agreements linked to the process will be written-off by transferring their debt to a new or existing write-off service agreement. Note: the SA type of the write-off service agreement is defined on the algorithm defined on events of this type.

---

Generic Algorithm

The system calls the algorithm defined on the write-off event type. This type of event is used when what you need to do isn't handled by one of the above event types.

---

**FASTPATH:**

Refer to [Setting Up Write Off Event Types](#) for more information.

---

## Write-off Event Lifecycle

The following diagram shows the possible lifecycle of a write-off event:

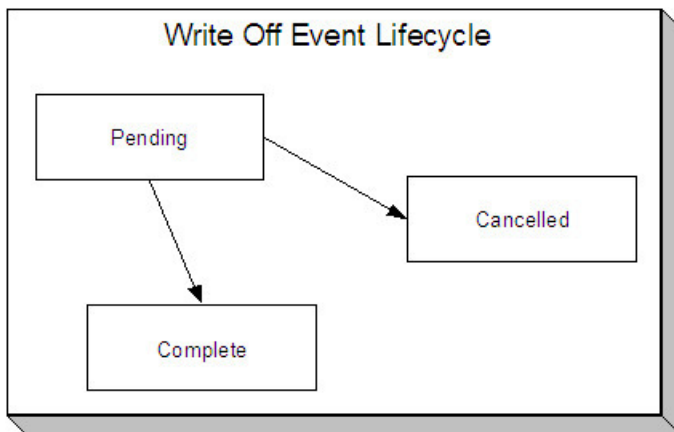

Write-off events are initially created in the pending state.

When the system sees a pending event with a trigger date on or before the current date, the system executes the event's activity and completes the event.

---

**FASTPATH:**

For more information about a write-off event's trigger date, see [Write-off Event Trigger Date](#).

---

A pending event will be cancelled automatically by the system when the service agreements linked to the process are all closed (i.e., they no longer have debt - either because it was paid or transferred to a write-off service agreement). A pending event may be cancelled by an operator at their discretion.

## Write-off Event Trigger Date

When a write-off event is created by the system, its trigger date is set in accordance with your date arithmetic preferences. Refer to [Calendar vs. Work Days](#) for more information.

## How Are Write-off Events Completed

A background process runs periodically (at least daily) that looks for write-off events with a trigger date on or before the current date. For each triggered event, the system executes its activity and then completes it. Refer to [Write Off Event Activator](#) for more information.

## The Last Write-off Event Should Write Off All Debt Associated With All SAs

The last write-off event will typically transfer all debt from the service agreement's linked to the process to a write off service agreement (linked to the account). This will only happen if you set up the write-off process template accordingly (i.e., the last event in the write-off process template is the kind that writes off debt for every service agreement linked to the write-off process).

## How Are Write-off Events Canceled?

The system removes a service agreement from a write-off process when its status becomes closed (i.e., when its balance is zero). Be aware that any type of financial event could cause an SA's balance to fall to zero (e.g., the creation of an adjustment, the application or cancellation of a payment, the cancellation of a bill, ...). When all service agreements are removed, the system cancels all pending write-off events and deactivates the write-off process.

---

**NOTE:**

**Real time cancellation.** Unlike collection processes, the system cancels write-off processes real time when the service agreement becomes closed (i.e., there is no background process that monitors write-off processes).

---

Besides the automated cancellation process, an operator may cancel a write-off event at will.

---

**NOTE:**

**Removing closed service agreements from a write-off process.** Service agreements aren't actually removed from the process. Rather, they are inactivated so a proper audit exists.

---

## Calendar vs. Work Days

When you set up your collection, severance and write-off process templates, you supply information that controls how the system determines the trigger date of each event in the related process. There are two different mechanisms for doing this:

- When you set up your severance process templates, you must define the number of days between each event. For example, the second event (send cutoff warning) may need to be triggered 7 days after the first event (send reminder letter).
- When you set up your collection and write-off process templates, you must define the number of days after the start of the process when each event should be triggered. For example, the second event (send cutoff warning) may need to be triggered 7 days after the start of the collection process.

The system uses this information in conjunction with the account's division's work calendar when it allocates a trigger date to the various collection, severance, and write-off events in your processes. The system offers you the following choices in respect of how it calculates an event's trigger date:

- You can indicate that the trigger date should be set to the next possible workday. For example, if you indicate that the second event is triggered 7 days after the first event, the system will add 7 days to the first event's completion date. It then checks if this is a workday (and not a holiday), if so, this is the trigger date of the event; if not, it assigns the trigger date to the next workday.
- You can indicate that the trigger date should be calculated by counting workdays. For example, if you indicate that the second event is triggered 7 days after the first event, the system will count 7 workdays (using the account's division's work calendar), and set the trigger date accordingly.

You must define which of the above methods is used in the following processes:

- Account Debt Monitor (ADM). Refer to [The Account Debt Monitor](#) for more information.
- Collection Event Trigger (CET). Refer to [The Collection Event Activator](#) for more information.
- Severance Event Set Trigger Date (SED). Refer to [Set Trigger Date](#) for more information.
- Write-off Monitor (WPM). Refer to [The Write Off Monitor](#) for more information.

## The Big Picture Of Payment Arrangements and Pay Plans

The topics in this section describe two different mechanisms that allow a customer to payoff overdue debt in installments.

### The Big Picture Of Pay Arrangements

A payment arrangement is an agreement with a customer to payoff severely overdue debt in **billed** installments. Bills sent to customers with payment arrangements contain charges for both their current services and their payment arrangement installment amount.

---

**NOTE:**

**Nomenclature.** Some people refer to payment arrangements as "current bill plus" agreements because the customer's bills contain charges for both their current debt plus their installment amount. After the customer has paid off their overdue debt, the customer's bill only contains charges for their current debt.

---

The topics in this section describe how to set up a payment arrangement and how the system monitors the ongoing arrangements.

### Creating Payment Arrangements

When you create a payment arrangement, you are actually creating a service agreement. This service agreement is just like other service agreements in that:

- It holds debt.
- It is periodically billed.
- When a payment is received, the service agreement's debt is reduced.
- If the service agreement becomes delinquent, a collection process is initiated to collect the overdue debt.

Debt is transferred to a payment arrangement service agreement (PA SA) from the customer's delinquent service agreements (SAs) at the inception of the payment arrangement.



When you transfer delinquent debt from the delinquent SAs to the PA SA, the debt is removed from the delinquent SAs. If you transfer all debt from the delinquent SAs, the customer will no longer be in arrears in a given debt class (and if the customer is no longer in arrears, active collection and severance processes will be cancelled).

**NOTE:**

**Use the Payment Arrangement Transaction.** You could do the above functions by adding a new service agreement and creating transfer adjustments. However, this is tedious. Rather, use the [Payment Arrangement](#) transaction. This transaction creates the PA SA, transfers debt to it, and sets up the installment amount. This transaction is also used if you need to break or cancel the payment arrangement.

## Installment, Payoff and Current Amounts

**WARNING:**

If you do not understand the difference between payoff balance and current balance, refer to [Current Amount versus Payoff Amount](#).

When you set up a payment arrangement service agreement (PA SA), you transfer delinquent debt to the PA SA using transfer adjustments. After moneys are transferred, the system sets the PA SA's current balance to zero. At this point, neither the original service agreements nor the PA SA have delinquent debt. If the customer neglects to pay their payment arrangement, the PA SA will fall into arrears and a collection process will ensue. If the customer neglects to pay their previously delinquent SAs, they will again fall into arrears and a collection process will ensue.

PA SAs start their life with a non-zero payoff balance (i.e., they have debt when first started). This debt is transferred from the normal service agreement(s) whose outstanding debt necessitated the creation of the PA SA.

The installment amount that the customer is billed is determined by the number of installments used to payoff the debt. For example, if the customer owes \$500 on their electric and water service agreements and they want to pay this off in 10 installments, you'd set up the installment amount to be \$50. The installment amount is saved on the PA SA's recurring charge amount. If the customer again falls into arrears on their normal service agreements, you can transfer additional delinquent debt to the PA SA. You can also change the installment amount as needed.

A PA SA's payoff balance typically differs from its current balance. The payoff balance is the amount of debt remaining to be paid off under the terms of the payment arrangement. The current balance is the installment amount that has been billed but not paid. For example, a customer who is paying off \$500 with 10 installments of \$50 would have an initial payoff balance of \$500 and a current balance of \$0. After the first bill, the PA SA would still have a payoff balance of \$500, but its current balance would be \$50. When the customer pays, the PA SA's payoff balance would fall to \$450 and its current balance would return to \$0.

The following table contains a financial example of a customer who sets up a payment arrangement to payoff \$1,000 of debt in \$10 installments.

Event	Normal SA's GL Accounting	PA SA's GL Accounting	Normal SA's Current Balance	Normal SA's Payoff Balance	PA SA's Current Balance	PA SA's Payoff Balance
Prior to creation of payment arrangement	N/A	N/A	1000	1000	N/A	N/A
Transfer debt from normal SA(s) to PA SA	Xfer 1000 A/R <1000>	PA A/R 1000 Xfer <1000>	0	0	1000	1000
Set current balance to zero on PA SA	N/A	N/A	0	0	0	1000

Customer is billed (\$50 for new debt and \$10 of payment arrangement debt)	A/R 50 Revenue <50>	N/A	50	50	10	1000
Customer pays \$60	Cash 50 A/R <50>	Cash 10 PA A/R <10>	0	0	0	990

When the customer pays off the payment arrangement debt, the system automatically closes the PA SA after it final bills (assuming the PA SA's SA type references a bill segment type that has a bill segment creation algorithm of Recurring Charge With Auto Stop ).

## Monitoring Payment Arrangements

The PA SA should belong to its own debt class (let's call it Payment Arrangement Debt) so that you can have stricter collection criteria for payment arrangement debt (as compared to normal SAs). Because there will be a new debt class, there will be a unique collection class control (CCC) for payment arrangements. This CCC will have debt criteria associated with payment arrangement debt. If these criteria are violated, we will kick off a collection process that should have 1 collection event - Start Severance.

The severance process template for PA SAs will have 1 severance event that calls the Break Payment Arrangement Event algorithm. This algorithm does the following:

- Cancels ALL adjustments that were used to transfer the debt to the payment arrangement (identified by the XFER adjustment type on the PA SA's SA type). When these are cancelled, the original arrearage will be reinstated under the original SAs - this debt should be rather old by this point.
- Syncs up current balance with payoff balance on the PA SA.
- Makes the PA SA pending stop (SA activation will stop the SA when it next runs).
- If there is a credit left on the PA SA (because payments were made against the arrangement), the credit will be distributed amongst the account's debt using the standard distribution algorithm. Because the payment arrangement debt that was reinstated should be rather old, it should get relieved first. This relief will occur via transfer adjustments from the PA SA to the original SAs.
- If there is a debit left (e.g., because LPC were issued or some other type of adjustment was created by an operator), the debt will be transferred back to one of the SAs from which the arrangement was originally created.
- Inserts a characteristic under the PA SA to indicate that it has been broken (we need this for the account debt monitor (ADM) a few steps down).
- Inserts a row on the account debt monitor trigger. This trigger will cause the account to be reviewed by the ADM the next time it runs.

**NOTE:**

**The PA SA must final bill before it closes.** The PA SA will only close after the PA SA is final billed. This is OK as it won't have any money left on it.

When the ADM next runs, it will analyze the account's reinstated debt. We recommend creating a new override collection criteria for the normal debt class that will return a value of true if the account has a closed payment arrangement that has been broken in the last X days (where X is a parameter of the override collection criteria's algorithm). If this algorithm returns a true, kick off a unique collection process template (that has nasty events). A sample algorithm of this type is supplied in the base package - COLL COND PA.

To complete this discussion, we have to worry about the situation when the final bill of a payment arrangement goes unpaid. In this situation, the payment arrangement is stopped and will therefore not be processed by the ADM. In this case, the write off monitor will process the PA SA after its final bill's due date and a write-off process will start. This write off process will have a single event that calls the Break Payment Arrangement algorithm (described above). After the FT's are issued in this event, the SA will close (because it's been final billed and its balance will go to zero).

## The Big Picture Of Pay Plans

A pay plan (PP) is an agreement with a customer to make payments on specific dates. Pay plans differ from payment arrangements in that pay plans have user-defined scheduled payment dates, which are independent from the customer's billing dates. In other words, payment arrangements appear on the customer's bills, pay plan scheduled payments do not.

If a customer is in arrears and you want to receive payments on specific dates (as opposed to with the customer's regular bills), you would set up a pay plan and define the dates on which you expect the payments.

The topics in this section describe how pay plans work.

### A Pay Plan Has One Or More Scheduled Payments

When you create a pay plan for an account, you must define the number of scheduled payments and their respective amounts. There is no limit to the number of scheduled payments that may be set up under a pay plan.

### Automatic Payments Can Be Created On The Scheduled Payment Dates

The system will create automatic payments on a pay plan's scheduled payment dates if:

- The account is set up for automatic payment (as described under [How To Set Up A Customer To Pay Automatically](#)), and
- The payment method defined on the pay plan indicates automatic payment is being used

The background process called PPAPAY is responsible for creating these automatic payments. It does this by calling the automatic payment creation algorithm plugged in on the installation record.

---

**NOTE:**

If the **Autopay Creation Option** on the [installation record](#) is set to Create On Extract Date, the automatic payment is NOT distributed and frozen when the automatic payment is initially created. Rather, a separate background process ([APAYDSFR](#)) distributes and freezes the automatic payment on the automatic payment GL distribution date (refer to [Automatic Payment Dates](#) for more information on how this date is calculated). Refer to [Automatic Payments](#) for more information.

---

### A Pay Plan Insulates Overdue Debt From The Account Debt Monitor

A pay plan's scheduled payments are used by the account debt monitor as "pseudo payments" that relieve the account's debt before it is subjected to the collection criteria (refer to [How Does The Account Debt Monitor Work](#) for more information about collection criteria).

It's important to understand that a pay plan only insulates the account's debt that belongs to the pay plan's debt class. Therefore, if a customer has debt that belongs to two debt classes (e.g., normal debt and 3 rd party pass through debt), you would need to set up a separate pay plan for each debt class (assuming both types of debt are covered by a pay plan). Refer to [Different Collection Criteria For Different Customers and Different Debt](#) for more information about debt classes.

## A Pay Plan Must Reference A Pay Plan Type

When you create a pay plan, you must define its pay plan type. The pay plan type controls the following functions:

- The debt class whose debt is insulated by the pay plan.
- The type of algorithm (if any) that is executed when the pay plan is broken. You might use such an algorithm to affect the customer's credit rating when the pay plan is broken.

## A Pay Plan May Reference A Third-Party Payor

In addition to referencing the account whose debt is insulated by the pay plan, the pay plan must also reference the account that is responsible for making the payments. We refer to this second account as the pay plan's "payor".

While the payor's account is typically the same as the account whose debt is insulated by the pay plan, you can indicate a third-party payor (e.g., a social service agency) is responsible for making the pay plan's scheduled payments.

If your organization allows third-party payors, you can define each on the third-party payor control table. This control table exists to simplify the data-entry effort when you create a pay plan (as it defines the account associated with the third-party payor).

---

### NOTE:

If a pay plan does not reference a third-party payor, any non-third-party payor (i.e., any account that is not defined in the third-party payor control table) can make payments on behalf of the customer. If a pay plan references a third-party payor, only payments made by the third party on behalf of the customer are counted towards the fulfillment of the pay plan.

---

## The Lifecycle Of A Pay Plan

The following diagram shows the possible lifecycle of a pay plan:

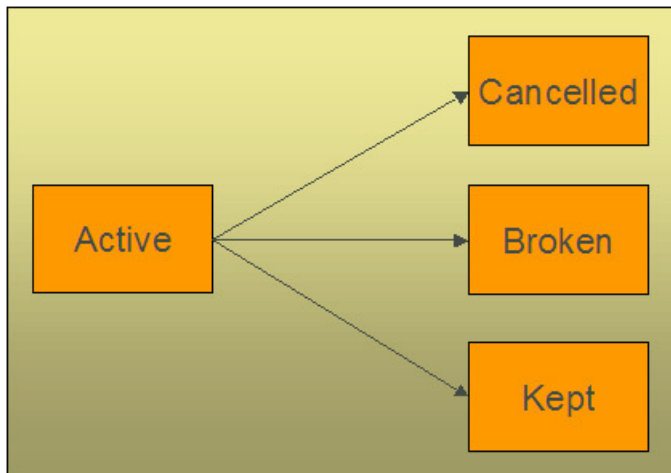

The following points explain this lifecycle:

- Pay plans are initially created in the active state. Active pay plans are monitored for compliance by [The Pay Plan Monitor](#).

- A pay plan may be cancelled as follows:
  - A user can cancel a pay plan at will.
  - When a SA is stopped AND there are no other active SAs in the same debt class, all **Active** pay plans associated with the account and debt class will be will be **Canceled** .
  - The activation of a collection event that calls the "cancel pay plan" algorithm will cancel all active pay plans associated with the collection process's debt class. You may want to use such a collection event if your organization cancels active pay plans when new debt causes a collection process to kick-off. Note, the base package algorithm that performs this function will not cancel the pay plan if it's associated with a 3rd party payor.
- [The Pay Plan Monitor](#) causes active pay plans to become broken if sufficient payments have not been made to satisfy the pay plan's scheduled payments.
- [The Pay Plan Monitor](#) causes active pay plans to become kept when it detects that sufficient payments have been made to satisfy the pay plan's scheduled payments.

## Highlighting The Existence Of Broken / Kept / Active and Denied Pay Plans

You can define on the installation record plug-in algorithms that format alert messages. (Refer to [Installation Options - Algorithms](#) for additional information.) We recommend that you take advantage of the following algorithms to highlight pay plans:

- Highlight pay plans in a given status. This algorithm is used to highlight pay plans in a given state (broken, kept, cancelled) that were started within the last X days.
- Highlight customer contacts of a given type. This algorithm would be used to highlight customer contacts of a given type that were created within the last X days. This would be useful if you create a specific type of customer contact when you deny a pay plan. Some utilities do this to prevent customers from shopping around.

In addition, you can define account-specific alerts to highlight customers that should never be allowed to have a pay plan (for whatever reason).

## A Pay Plan Must Reference A Payment Method

When you create a pay plan, you must define how the customer will make the payments be referencing a payment method. Examples of payment methods include: In Person , Wire Transfer, By Post, Express Mail, etc.

The payment method is more than just documentation as it defines the number of grace days the customer has to make the pay plan's scheduled payments. For example, if you set up the payment method control table to indicate that payments made By Post have 3 grace days, then the customer has up to 3 days after each scheduled payment date to make the payment. If payment is not received by the scheduled payment date plus the grace days, the pay plan will be marked as broken (and the ADM will be triggered).

## The Pay Plan Monitor

---

### **FASTPATH:**

Please understand the concepts described in [The Lifecycle Of A Pay Plan](#) and [The Tendering Account May Differ From The Account Whose Debt Is Relieved](#) before reading this section.

---

The Pay Plan Monitor background process (referred to as PPM ) is responsible for monitoring active payment plans. This process can cause a pay plan (PP) to become kept or broken (or being left as active ).

---

**NOTE:**

**When is a pay plan marked as broken / kept?** It's important to understand that only the PPM can cause a pay plan to become kept or broken. This means that if a customer makes a payment that satisfies a pay plan, the pay plan will only be marked as kept when the pay plan monitor next runs. Analogously, if a payment is cancelled, nothing will happen to an active pay plan until the PPM next runs. When the PPM next runs, it will see that the scheduled payment was not kept and it will break the pay plan and schedule the ADM to be executed. When the ADM next executes, it will create a collection process (because the customer's debt will no longer be insulated by the pay plan's scheduled payments).

**NSF Cancellations After A Pay Plan Is Kept.** If a payment is cancelled due to non-sufficient funds (NSF) after a pay plan is marked as kept, the pay plan will remain kept. But keep in mind that the pay plan's account is scheduled for review by the ADM when a payment is cancelled due to NSF. When the ADM reviews the account's debt, it will no longer have an active pay plan to insulate it and the account's debt will likely trigger a new collection process. Refer to [How Pay Plans Affect The Account Debt Monitor](#) for more information.

---

The following points describe, at a high level, how the PPM monitors a pay plan (PP) for compliance.

- The system selects all frozen, non-cancelled payment segments associated with the PP's account and debt class where:
    - The payment date is after the start date of the pay plan, and
    - The payment's pay event has at least one tender that references the pay plan's payor.
  - The system logically reduces / removes past and current scheduled payments (starting with the earliest scheduled payment) until the total amount of payment segments is exhausted (or there are no more historical / current scheduled payments).
- 

**NOTE:**

**Paying pay plans in advance.** Scheduled payments with a future date are not logically removed / reduced. This means that if a customer makes advance payments on a pay plan, it will not be marked as kept until all scheduled payment dates are in the past.

---

- If all scheduled payments have been logically removed, the pay plan is marked as kept.
  - If there exist scheduled payments where the pay date + grace days (grace days are defined on the pay plan's payment method) is before the current date (i.e., a payment doesn't exist for a scheduled payment):
    - The pay plan is marked as broken.
    - The PP's break algorithm (if any) is called (note, for European / Australian pay plans, there are scenarios where the break algorithm can cause the pay plan to become unbroken - when there aren't at least two missed, historical scheduled payments).
    - An ADM trigger is stored for the PP's account. This will cause the account to be reviewed by the ADM the next time it runs. And because the pay plan is broken, its scheduled payments will no longer insulate the account's arrearage.
- 

**IMPORTANT:**

It's important that you schedule the PPM to run before the ADM so that it can break unpaid payment plans prior to the ADM subjecting the account's debt to collection criteria. Refer to [How Pay Plans Affect The ADM](#) for more information.

---

## How Pay Plans Affect The Account Debt Monitor

As described under [A Pay Plan Insulates Overdue Debt From The Account Debt Monitor](#), a pay plan's scheduled payments insulate an account's debt from the ADM. This section describes how this is accomplished.

---

**WARNING:**

You should understand the concepts in [How Does The Account Debt Monitor Work](#) and [The Tendering Account May Differ From The Account Whose Debt Is Relieved](#) before reading the following.

**NOTE:**

**The ADM will be triggered when a pay plan is broken.** Refer to [The Pay Plan Monitor](#) for an explanation of how the ADM is triggered when a pay plan is broken.

Before the ADM subjects an account's debt to the collection criteria, it calls the debt's debt class's Override Arrears Algorithm (this is an optional plug-in spot on [Debt Class](#)). This algorithm is passed the debt class's aged debt and manipulates it as follows:

- First, a list of all past, present and future scheduled payments associated with the account and debt class's active pay plans is constructed.
  - If multiple payors are encountered (because the customer has multiple pay plans and these have different payors), a separate list of scheduled payments is maintained for each payor.
- Next, for each payor, retrieve the total amount of frozen, non-cancelled payment segments made on behalf of the pay plan's account and debt class.
  - Select all frozen, non-cancelled payment segments associated with the pay plan's account and debt class whose pay date is  $\geq$  pay plan's start date and the pay segment's event has at least one tendering account associated with the pay plan's payor.
- Next, logically reduce / remove past and current scheduled payments (starting with the earliest scheduled payment) until the payor's payment amount is exhausted (or there are no more historical / current scheduled payments). Future scheduled payments cannot be remove / reduced.
- Finally, reduce the passed in aged debt with any unpaid scheduled payments.

**NOTE:**

**This logic is not "hard coded".** Rather, the mechanism used to use a pay plan's scheduled payments to reduce debt is defined in an algorithm defined on the pay plan's debt class. The contents in this section describe how a base package algorithm works. Because it's an algorithm, you can introduce whatever logic you please.

The following is an example of how pay plans affect aged debt.

Date	Event	SA's Arrears	SA's Balances	Scheduled Payments
Prior to creation of the PP 1/18/2000		\$1,000 - 90 days old	Current: \$4,500	
		\$1,600 - 60 days old	Payoff: \$4,500	
		\$1,900 - 30 days old		
1/18/2000	Pay Plan created.	\$1,000 - 90 days old	Current: \$4,500	1/20/2001 \$1,500
	The \$4,500 in future scheduled payments offsets the existing \$4,500 of aged debt.	\$1,600 - 60 days old	Payoff: \$4,500	2/01/2001 \$1,500
		\$1,900 - 30 days old		2/07/2001 \$1,500
		<b>De facto ADM debt: \$0</b>		
1/20/2001	The customer pays \$1,500. There exists \$3,000 of future scheduled payments that offset the arrears	\$1,100 - 62 days old	Current: \$3,000	1/20/2001 \$1,500 "Paid"
		\$1,900 - 32 days old	Payoff: \$3,000	2/01/2001 \$1,500 Future
		<b>De facto ADM debt: \$0</b>		2/07/2001 \$1,500 Future
1/20/2001	ADM runs. The \$3000 in future scheduled	\$1,100 - 62 days old	Current: \$3,000	1/20/2001 \$1,500 "Paid"
		\$1,900 - 32 days old	Payoff: \$3,000	2/01/2001 \$1,500 Future

	payments offsets the Current Balance of \$3000, so CC events not created.	<b>De facto ADM debt: \$0</b>		2/07/2001 \$1,500 Future
1/24/2001	A new bill is created for \$400	\$1,100 - 62 days old \$1,900 - 32 days old \$400 - 1 day old	Current: \$3,400 Payoff: \$3,400	1/20/2001 \$1,500 "Paid" 2/01/2001 \$1,500 Future 2/07/2001 \$1,500 Future
		<b>De facto ADM debt: \$400 - 1 day old</b>		
2/2/2001	Pay Plan Monitor runs. PP marked as Broken because the 2/1/2001 scheduled payment has not been paid (assuming no grace period on the pay plan's payment method)	\$1,100 - 74 days old \$1,900 - 44 days old \$400 - 8 days old	Current: \$3,400 Payoff: \$3,400	1/20/2001 \$1,500 "Paid" <b>2/01/2001 \$1,500 "Late"</b> 2/07/2001 \$1,500 Future
2/2/2001	ADM runs. There are no active pay plans and therefore there is nothing to insulate the customer's debt. Therefore the aged debt will be subjected to the collection criteria and an appropriate collection process will be created.	\$1,100 - 74 days old \$1,900 - 44 days old \$400 - 8 days old	Current: \$3,400 Payoff: \$3,400	<b>Pay plan is broken and therefore its scheduled payments cannot be used.</b>
		<b>De facto ADM debt is the same as above (i.e., rather old)</b>		

## Collection Process / Severance Process Cancellation

When a pay plan (PP) is created, the system determines if it can cancel active collection and severance processes associated with the pay plan's account and debt class. It does this because a pay plan's scheduled payments act as "pseudo payments" that relieve the account's debt (temporarily). The following points describe how this works:

- The system attempts to cancel collection processes by calling the [Collection Process Cancel Criteria Algorithm](#) defined on the debt class that is associated with the collection process. This algorithm is meant to cancel a collection process if the sum of ALL service agreements in the debt class have debt less than a given threshold amount. Because of the existence of the pay plan, the actual debt will be temporarily reduced by the amount of the pay plan's scheduled payments before it is compared to the threshold amount (see [How Pay Plans Affect The Account Debt Monitor](#) for more information about how debt is reduced). Note: this temporary reduction will only occur if you have plugged in the appropriate pay plan debt reduction algorithm on the debt class.
- It attempts to cancel severance processes by calling the [Severance Process Cancel Criteria Algorithm](#) defined on the debt class that is associated with the severance process. This algorithm is meant to cancel a severance process if the sum of ALL service agreements in the debt class have debt less than a given threshold amount. Because of the existence of the pay plan, the actual debt will be temporarily reduced by the amount of the pay plan's scheduled payments before it is compared to the threshold amount (see [How Pay Plans Affect The Account Debt Monitor](#) for more information about how debt is reduced). Note: this temporary reduction will only occur if you have plugged in the appropriate pay plan debt reduction algorithm on the debt class.

If collection / severance processes still exist for the account / debt class associated with the pay plan, a warning is issued.



## Interesting Pay Plan Facts

The following points describe a variety of interesting facts about pay plans (PP):

- An account may have many active pay plans. However, only 1 pay plan may be active for a given account / debt class / payor at any point in time.
- The existence of a pay plan has no impact on payment distribution.
- When a SA is stopped, if the SA's debt class has an active PP AND there are no other active SAs in the same debt class, the PP will be cancelled
  - The cancel reason will be "cancelled by system" (as opposed to "cancelled by user")
- If necessary, different collection / severance processes can be triggered if a broken PP is detected (via the override algorithms on CCC and write-off control - we do NOT provide such algorithms).

## Setting Up Pay Plan Control Tables

This section describes the control tables needed to set up pay plans.

## Setting Up Pay Plan Types

Pay plan types control what is done by a given pay plan. Open **Admin > Credit & Collection > Pay Plan Type** to define your pay plan types.

---

### FASTPATH:

For more information refer to [The Big Picture Of Pay Plans](#) for more information.

---

### Description of Page

To modify a pay plan type, simply move to a field and change its value. To add a new pay plan type, press + to insert a row, then fill in the information for each field. The following fields display:

**Pay Plan Type** The name of the pay plan type.

**Description** A meaningful description of the pay plan type.

**Broken Algorithm** This algorithm is called when a pay plan is broken. Refer to [The Pay Plan Monitor](#) for more information about how pay plans are broken.

If you haven't done so already, you must set up this algorithm in the system. To do this, create a new algorithm (refer to [Setting Up Algorithms](#)). On this algorithm, reference an Algorithm Type that breaks a pay plan. Click [here](#) to see the algorithm types available for this plug-in spot.

**Debt Class** The debt class covered by pay plans of this type. Refer to [Setting Up Debt Classes](#) for more information.

### Where Used

Follow this link to open the data dictionary where you can view the tables that reference [CI\\_PP\\_TYPE](#).

## Setting Up Payment Methods

Payment methods are used to describe how a customer intends to make their pay plan's scheduled payments. Open **Admin > Credit & Collection > Pay Method** to define your payment methods.

---

**FASTPATH:**

For more information refer to [A Pay Plan Must Reference A Payment Method](#) for more information.

---

**Description of Page**

To modify a pay method, simply move to a field and change its value. To add a new pay method, press + to insert a row, then fill in the information for each field. The following fields display:

**Pay Method** The name of the payment method.

**Description** A meaningful description of the payment method.

**Grace Days** The number of days added to the scheduled payment date. The ADM will consider the pay plan to be broken if payment is not made by the scheduled date plus the grace days.

**Auto Pay** If the pay method is marked as being for **Auto Pay**, the PPAPAY background process will automatically create an automatic payment on the pay plan's scheduled payment dates IF the account has been set up for automatic payment.

**Where Used**

Follow this link to open the data dictionary where you can view the tables that reference [CI\\_PAY\\_METH](#).

## Setting Up Third Party Payors

Pay plans support optional third-party payors. Open **Admin > Credit & Collection > Third Party Payor** to define your third-party payors.

---

**NOTE:**

A third-party payor refers to an account. You must set up the account before you can create a third-party payor.

---

**FASTPATH:**

Refer to [A Pay Plan May Reference A 3rd Party Payor](#) for more information.

---

**Description of Page**

The following fields display for each third party payor:

**Third Party Payor** Provide a meaning id for the third-party payor that can be easily recognized when setting up a pay plan.

**Description** A meaningful description of the payor.

**Account ID** The account that is used for this payor. It is this account that is tracked as the "payee" of any payments made towards a third party payor's pay plan.

**Active** Check this box if the payor is currently available to participate in pay plans.

**Where Used**

Follow this link to open the data dictionary where you can view the tables that reference [CI\\_THRD\\_PTY](#).

## Creating Collection, Severance & Write-Off Procedures

Your collection procedures define how your organization collects overdue debt. Your severance procedures define how your organization severs service agreements when collection attempts fail. Your write-off procedures define how your organization writes off finalized debt. In this section, we describe how to set up the data that controls these procedures.

**FASTPATH:**

For more information about collection, severance and write-off procedures, see [The Big Picture Of Credit & Collections \(C&C\)](#).

**WARNING:**

There are innumerable ways to design your collection, severance and write-off procedures. Some designs will result in easy long-term maintenance, others will result in maintenance headaches. In this section, we provide information to help you understand the ramifications of the various options. Before you set up your production collection, severance and write-off procedures, we encourage you to gain an intuitive understanding of these options by using the system to prototype the alternatives.

## Designing Your Collection Procedures

The design of your collection procedures is an iterative process. Over time, you will develop intuitive skills that will allow you to skip some iterations. However, when you're starting out, we recommend you use the following matrix as your guide. When the matrix is complete, you're ready to set up the collection process control tables.

SA's Debt Class	Account's Collection Class:	Account's Collection Class:

The topics discussed below will gradually complete this matrix using a simple case study.

**FASTPATH:**

For more information about how the information in this matrix is used to monitor your customers' debt, refer to [Different Collection Criteria For Different Customers And Different Debt](#).

## Designing Your Debt Classes

Multiple debt classes are needed when you have different collection procedures for different types of service agreements. If all service agreement debt is collected the same way, then you'll have just one debt class (call it Generic ). However, if you're like many organizations, you will have multiple debt classes. The following points will help you understand why:

- If you have both regulated and unregulated service, you probably have different debt classes for each type of service. Why? Because your local regulators control how you collect and cutoff overdue, regulated debt. For unregulated debt, your organization controls how overdue debt is collected.
- If your customers make charitable donations, you will have a charitable contribution debt class. Why? Because you probably send a different type of letter when the customer falls into arrears on their charitable contributions. You also can't cut off their water service if they don't make their charitable contributions.
- If you levy deposits, you will probably have a deposit debt class. Why? Because you probably respond differently if the customer doesn't pay their deposit (e.g., you may decide to cut off their electric service until the deposit is paid).
- If you allow customers to make payments on Non-Billed Budgets, you will probably have a Non-Billed Budget debt class. Why? Because you probably respond differently if the customer doesn't pay their Non-Billed Budget (e.g., you may decide to expire the Non-Billed Budget but not affect their other service since the Non-Billed Budget is a way for customers to prepay for upcoming bills).

- If you write-off uncollectable debt, you will need another debt class for write-off service agreements. Why? Because when you write-off debt in the system, you transfer the uncollectable debt from the original service agreement(s) to a write-off service agreement. The write-off service agreement holds this debt forever (or until it is paid). You need to use a different debt class for the write-off service agreements because they aren't subject to collection criteria.
- If you use the system to charge your organization's company usage, you'll need another debt class (we refer to it as the "N/A" debt class below). Why? Because all service agreements must have a debt class, even those that will never have debt.

<b>SA's Debt Class</b>	<b>Account's Collection Class</b>	<b>Account's Collection Class</b>
Regulated		
Unregulated		
Charitable Contribution		
Deposit		
Non-Billed Budget		
Write Off		
N/A		

## Designing Your Collection Classes

Multiple collection classes are needed when any debt class has different collection rules depending on the type of customer. If all customers within all debt classes are collected the same way, then you'll just have a single collection class (call it Generic ). However, if you're like many organizations, you will have multiple collection classes.

Consider unregulated debt. For commercial/industrial customers, you probably don't worry until they owe you more than, say, \$100 after 20 days. For residential customers, you probably don't worry until they owe you more than, say, \$5 after 20 days. In this situation, you will have at least two collection classes: one for large customers, the other for residential customers.

In our example, we are assuming you have two collection classes: Residential and Commercial/Industrial.

<b>SA's Debt Class</b>	<b>Account's Collection Class:</b>	<b>Account's Collection Class:</b>
	<b>Residential</b>	<b>Commercial/Industrial</b>
Charitable Contribution		
Regulated		
Unregulated		
Write Off		
Company Usage		

## Designing Collection Class Controls

At this point we have the rows and columns defined in our matrix. Now it's time to work on the individual cells.

Each cell should have a "collection class control" that defines its collection criteria and what to do if the criteria are violated. If a cell doesn't have a collection class control, this means you don't have any debt associated with that combination of collection class and debt class. So, we'll mark each cell without debt with "N/A".

SA's Debt Class	Account's Collection Class:	
	Residential	Commercial/Industrial
Regulated		N/A
Unregulated		
Charitable Contribution		N/A
Deposit		
Write Off		
N/A		

Next, we'll mark each cell for debt classes whose debt isn't collectable (i.e., the write-off and N/A debt classes).

SA's Debt Class	Account's Collection Class:	
	Residential	Commercial/Industrial
Regulated		N/A
Unregulated		
Charitable Contribution		N/A
Deposit		
Write Off	N/A	N/A
N/A	N/A	N/A

**NOTE:**

If the Account Debt Monitor encounters debt associated with a non-existent collection class control, it will issue an error.

Determining the collection criteria in each remaining cell can be straightforward or complicated; it depends on how your organization works. Our case study assumes the following:

- For charitable debt, if the customer is more than \$0 in arrears by more than 20 days, kick off the "charity reminder" collection process. We'll talk more about this collection process later.
- For regulated / residential debt, if the customer is more than \$15 in arrears by more than 20 days, kick off the Normal Regulated collection process. We'll talk more about this collection process later.
- For unregulated / residential debt, if the customer is more than \$5 in arrears by more than 20 days, kick off the Normal Unregulated collection process. We'll talk more about this collection process later.
- For unregulated / commercial-industrial debt we have multiple criteria:
  - Highest priority. If the customer is more than \$10,000 in arrears by more than 20 days, kick off the Large Overdue Debt collection process. We'll talk more about this collection process later.
  - Lower priority. If the customer is more than \$100 in arrears by more than 20 days, kick off the Normal Unregulated collection process. We'll talk more about this collection process later.
- For deposit debt (regardless of collection class) we have multiple criteria:
  - Highest priority. If the customer is more than \$5 in arrears by more than 50 days, kick off the Deposit Severely Overdue collection process. We'll talk more about this collection process later.
  - Lower priority. If the customer is more than \$15 in arrears by more than 20 days, kick off the Deposit collection process. We'll talk more about this collection process later.

Given the above, our matrix will look as follows:

SA's Debt Class	Account's Collection Class:	Account's Collection Class:
	Residential	Commercial/Industrial
Charitable Contribution	If > \$0 is older than 20 days, start Charity Reminder collection process.	N/A
Regulated	If > \$15 is older than 20 days, start Normal Regulated collection process.	N/A
Unregulated	If > \$5 is older than 20 days, start Normal Unregulated collection process.	Highest priority: If > \$10,000 is older than 20 days, start Large Overdue Debt collection process. Lower priority: If > \$100 is older than 20 days, start Normal Unregulated collection process.
Deposit	Highest priority: If > \$5 is older than 50 days, start Deposit Severely Overdue collection process. Lower priority: If > \$15 is older than 20 days, start Deposit collection process.	Highest priority: If > \$5 is older than 50 days, start Deposit Severely Overdue collection process. Lower priority: If > \$15 is older than 20 days, start Deposit collection process.
Write Off	N/A	N/A
N/A	N/A	N/A

## Designing Your Collection Class Control Overrides

### WARNING:

Your collection needs may not require any overrides for your collection class control matrix and therefore this section may not be relevant.

The following matrix will help you design your collection class overrides. When the matrix is complete, you're ready to set up the collection class control tables.

Notice that the matrix has two dimensions: one is dependent on collection condition algorithms; the other is dependent on the collection class controls designed in the previous section. Collection condition algorithms are confusing. Think of them as optional conditions that, if met, will subject the collection class control's debt to different collection criteria.

Each cell in the matrix contains the collection criteria that will be applied to the account's debt when the collection condition is met (i.e., the same type of criteria - dollars and days and collection process - are defined in each cell).

We label the first collection condition as the Default. The collection criteria associated with this column will be used to analyze an account's debt when none of the other conditions applies. We'll start by indicating the Default collection criteria (this was defined in the previous section).

SA's Debt Class	Account's Collection Class:	Account's Collection Class:
	Default	Credit Rating < Threshold
Residential Charitable Contribution	See default collection criteria defined in previous section.	
Residential Regulated	See default collection criteria defined in previous section.	
Residential Unregulated	See default collection criteria defined in previous section.	

Commercial-Industrial Unregulated	See default collection criteria defined in previous section.
Residential Deposit	See default collection criteria defined in previous section.
Commercial-Industrial Deposit	See default collection criteria defined in previous section.

If a different collection process OR criteria should be used when other conditions are met, you should indicate such by defining the collection criteria in the cell. For example, if we assume that all unregulated residential debt has a different collection process when the account's credit score is less than the threshold credit rating on the installation record or the account's CIS Division, our matrix will look as follows:

SA's Debt Class	Account's Collection Class:	Account's Collection Class:
	Default	Credit Rating < Threshold
Residential Charitable Contribution	See default collection criteria defined in previous section.	
Residential Regulated	See default collection criteria defined in previous section.	
Residential Unregulated	See default collection criteria defined in previous section.	Override: If Credit Rating is lower than the credit rating threshold: If > \$5 is older than 15 days, start Risky Unregulated collection process.
Commercial-Industrial Unregulated	See default collection criteria defined in previous section.	
Residential Deposit	See default collection criteria defined in previous section.	
Commercial-Industrial Deposit	See default collection criteria defined in previous section.	

Once the matrix is complete, you're ready to design your collection process and collection event types.

**NOTE:**

**The collection conditions are limited by your imagination (and business requirements).** We have provided the collection conditions you see above as an example; we don't expect you'll be able to use the exact conditions we supply. Your conditions will be based on any number of factors. For example, if you have different collection criteria that apply during winter months, you should add a new collection condition (called Winter Season ). Or if you have different criteria based on years of service, you could have another condition.

**New collection conditions may require programming.** See [How To Add A New Algorithm](#) for more information.

## Designing Collection Process Templates & Collection Event Types

The following table shows the collection process templates referenced in the previous section's matrix. Adjacent to each process are its events and an indication of when they are triggered.

Collection Process Template	Collection Event Template	Triggered X Days From Start Of Collection Process
Charitable Contribution Reminder	Charity courtesy reminder letter	0

	Start severance	15
Normal Regulated	Regulated courtesy reminder letter	0
	Regulated second notice letter	10
	Start severance	15
Large Overdue Debt	Large debt courtesy reminder letter	0
	To Do for large overdue debt	3
	Large debt second notice letter	10
	Start severance	15
Normal Unregulated	Unregulated courtesy reminder letter	0
	Unregulated second notice letter	5
	Start severance	10
Risky Customer Unregulated	Unregulated risky letter	0
	Start severance	5
Deposit	Deposit reminder	0
Deposit Severely Overdue	Create To Do entry	0

If we extract each unique event type from the above table, we end up with the following:

Collection Event Type	Event Type
Charity courtesy reminder letter	Send Letter - CHARIT REMIN
Start severance	Start Severance Process
Regulated courtesy reminder letter	Send Letter - REGUL REMIN
Regulated second notice letter	Send Letter - REGUL second
Large debt courtesy reminder	Send Letter - LARGE REMIN
Risky debt courtesy reminder	Send Letter - RISKY REMIN
To Do for large overdue debt	Issue To Do
Large debt second notice letter	Send Letter - LARGE second
Unregulated courtesy reminder letter	Send Letter - UNREG REMIN
Unregulated second notice letter	Send Letter - UNREG second
Deposit reminder	Send Letter - DEPOS REMIN
To Do for deposit severely overdue	Issue To Do

Now you're (almost) ready to set up your collection procedures.

## Defining Cancellation Process Auto Cancellation Criteria

The topics in the section [How Are Collection Processes Cancelled](#) describe the two algorithms that play a part in the cancellation of a collection process. It also describes when to use what type of algorithm. Please read this section and then set up the appropriate cancellation criteria on your [Debt Classes](#), and optionally, on your [Collection Process Templates](#).



## Setting Up Collection Procedures

In the previous section, [Designing Your Collection Procedures](#), we presented a case study that illustrated a mythical organization's collection procedures. In this section, we'll explain how to set up the control tables to implement these procedures:

### Setting Up Collection Event Types

Collection event types control what is done by a given collection event. Open **Admin > Credit & Collection > Collection Event Type > Add** to define your collection event types.

#### Description of Page

Enter a unique **Collection Event Type** and **Description** for the collection event type.

Enter the **Collection Event Type**. Permissible values are: Affect Credit, Rating/Cash-Only, Cancel Budget, Generic Algorithm, Send Letter, Create To Do Entry, Start Severance Process. The following discussion describes the parameters that must be defined for each type of collection event.

The Affect Credit Rating/Cash-Only collection event type causes a credit rating demerit record to be linked to the account. This record is constructed using the following **Parameters**:

- Use **Credit Rating Points** to define this event's affect on the account's credit rating. This should be a negative number. An account's credit rating is equal to the beginning credit rating amount defined on the installation record or the account's CIS Division plus the sum of credit rating demerits that are currently in effect. When an account's credit rating is less than the credit rating threshold defined on the installation record or the account's CIS Division, the account's credit rating is displayed as an alert on Control Central.
- Use **Cash-Only Points** to define this event's affect on the account's cash-only score. This should be a positive number. When an account's cash-only score exceeds the cash-only threshold score defined on the installation record or the account's CIS Division, the account is flagged as cash-only during payment processing and on Control Central.
- Use **Credit Rating Months** to define the length of time the demerit remains in effect. This information is used to define the effective period of the credit rating demerit record.

---

#### FASTPATH:

For more information, refer to [Account - Credit Rating](#).

---

The Send Letter collection event type causes a customer contact to be generated that, in turn, generates a letter. Enter the following **Parameters** for this type of event:

- Select the **Contact Class** used to categorize the customer contact.
- Use **Contact Type** to define the type of customer contact to create. The type of customer contact controls the type of letter that is generated.

---

#### NOTE:

**Letter creation is triggered via a customer contact.** You must set up a customer contact type for each type of letter you generate. You specify the necessary customer contact type on the collection event. Refer to [Setting Up Letter Templates](#) for more information.

---

The Cancel Budget collection event type cancel an account's budget plan (if the account is on such a plan). When a budget plan is cancelled, adjustments are issued to synchronize every service agreement's current balance with its payoff balance and each applicable SA's recurring charge amount (i.e., budget amount) is set to zero.

The Generic Algorithm collection event type causes the algorithm defined in the **Collection Event Alg** to be executed. You use this type of algorithm when the standard types of collection events won't do what you need done. If you haven't done so already, you must set up this algorithm in the system. To do this:

- Create a new algorithm (refer to [Setting Up Algorithms](#)).
- On this algorithm, reference an Algorithm Type that determines the algorithm that will be called when events of this type of activated. Click [here](#) to see the algorithm types available for this plug-in spot.

The Create To Do Entry collection event type causes a To Do entry to be issued. A good example of where this is used is when the collection event requires that the customer be called on the phone. Refer to [The Big Picture of To Do Entries](#) for more information about To Do entries (refer to the To Do type TD-CEVT for the type of To Do entry that's created).

The Start Severance Process type will start a severance process for every service agreement linked to the collection process. No parameters are needed for this type of event.

Enter a **Long Description** to fully describe the collection event type.

#### Where Used

Follow this link to open the data dictionary where you can view the tables that reference [CI\\_COLL\\_EVT\\_TYP](#).

## Setting Up Collection Process Templates

Collection process templates define the collection events that will be executed when a collection criteria rule is violated. Open **Admin > Credit & Collection > Collection Process Template > Add** to define your collection process templates.

#### Description of Page

Enter a unique **Collection Process Template** and **Description** for the collection process template.

Select a **Cancel Criteria Algorithm** if your organization allows individual service agreements to be "removed" from a collection process regardless of the debt associated with all service agreements in the debt class. In other words, if your cancel criteria are based on the debt associated with ALL service agreements in a debt class DO NOT SPECIFY THIS ALGORITHM. If this algorithm is specified, it is executed by the collection process monitor when it detects that a credit has been applied to a service agreement linked to an active collection process. This algorithm will indicate if the specific service agreement that has been credited no longer has debt that warrants a collection process. Refer to [How Are Collection Processes Cancelled](#) for more information. If you haven't done so already, you must set up this algorithm in the system. To do this, create a new algorithm (refer to [Setting Up Algorithms](#) ). On this algorithm, reference an Algorithm Type that "removes" a service agreement from a collection processes if the service agreement's debt so warrants. Click [here](#) to see the algorithm types available for this system event.

The **Response** grid contains an entry for every collection event that will be created when a collection process that references this template is created. The following information must be defined for each event:

**Event Sequence** controls the order in which the collection event types appear under the collection process template. The sequence number is system-assigned and cannot be changed. If you have to insert a collection event type between two existing templates, you'll have to remove the latter events, insert the new event, and then re-specify the removed events.

**Collection Event Type** Specify the type of collection event to be generated.

**Days After Process Creation** Specify the number of days after the creation of the collection process that the related collection event will be triggered. Refer to [Calendar vs Work Days](#) for a description of how this system uses this information to set the trigger date on the respective collection events.

---

#### FASTPATH:

For more information about collection event types, see [Setting Up Collection Event Types](#). For more information about trigger dates, see [Collection Event Trigger Date](#).

---

#### Where Used

Follow this link to open the data dictionary where you can view the tables that reference [CI\\_COLL\\_PROC\\_TM](#).

## Setting Up Collection Classes

Every account has a collection class. This class is one of several fields that control the collection method applied to the account's debt. Open **Admin > Credit & Collection > Collection Class** to define your collection classes.

---

**FASTPATH:**

For more information about collection classes, see [Designing Your Collection Classes](#).

---

### Description of Page

Enter a unique **Collection Class** code and **Description** for each collection class.

Indicate which method is used to monitor the member accounts' unpaid debt:

- If you practice [balance-forward accounting](#) for accounts belonging to this collection class, select Collection, Severance & Write-Off. This method of collection is described throughout this chapter.
- If you practice [open-item accounting](#) for accounts belonging to this collection class, select Overdue. This method of collection is described under [Defining Overdue Processing Options](#).
- If accounts belonging to this collection class are not subject to either of the above collection methods, select Not Eligible For Collection. Please be aware that these accounts will NOT be reviewed for overdue debt.

### Where Used

Follow this link to open the data dictionary where you can view the tables that reference [CI\\_COLL\\_CL](#).

## Setting Up Debt Classes

Every SA type has a debt class. This class is one of several fields that control the collection criteria applied to the service agreement's debt. Open **Admin > Credit & Collection > Debt Class > Add** to define your debt classes.

---

**FASTPATH:**

For more information about debt classes, see [Designing Your Debt Classes](#).

---

### Description of Page

Enter a unique **Debt Class** and **Description** for the debt class.

Turn on **Eligible for Collection** if service agreements belonging to this debt class have their debt monitored by the collection process. This should only be turned off if this debt cannot be collected, e.g., write-off debt.

The grid that follows contains **Algorithms** that control important functions in the system. You must define the following for each algorithm:

- Specify the **System Event** with which the algorithm is associated (see the table that follows for a description of all possible events).
- Specify the **Sequence** and **Algorithm** for each system event. You can set the **Sequence** to an arbitrary number as only one algorithm for each system event is allowed in this case.

---

**WARNING:**

These algorithms are typically significant system processes. The absence of an algorithm may prevent the system from operating correctly.

---

You can define algorithms for the following **System Events**:

System Event	Optional / Required	Description
Collection Process Cancellation	Required if debt class is eligible for collection	<p>This algorithm determines if a collection process can be canceled, and if so, it cancels it. Refer to <a href="#">How Are Collection Processes Cancelled</a> for more information.</p> <p>Click <a href="#">here</a> to see the algorithm types available for this system event.</p>
Severance Process Cancellation	Required if debt class is eligible for collection	<p>This algorithm determines if a severance process can be canceled, and if so, it cancels it. Refer to <a href="#">How Are Severance Processes Cancelled</a> for more information.</p> <p>Click <a href="#">here</a> to see the algorithm types available for this system event.</p>
Override Arrears Due to Pay Plan	Required if you use Pay Plans	<p>This algorithm is called to temporarily override a customer's arrears using a pay plan's scheduled payments when the system looks at an account's debt from a credit &amp; collections perspective (i.e., the ADM calls this algorithm before it subjects a customer's debt to the collection criteria and when a pay plan is created). It does not actually change any data, but overlays the current arrears with the pay plan scheduled payments.</p> <p>This algorithm is also called by the above algorithms when a pay plan is created in order to evaluate if the scheduled payments actually cover the arrears (if so, the collection / severance processes are cancelled). It is also called periodically by the ADM in order to establish if the current state of the pay plan still covers the arrears. Refer to <a href="#">How Pay Plans Affect The Account Debt Monitor</a>.</p> <p>Click <a href="#">here</a> to see the algorithm types available for this system event.</p>

### Where Used

Follow this link to open the data dictionary where you can view the tables that reference [CI\\_DEBT\\_CL](#).

## Setting Up Collection Class Controls

The topics in this section describe the windows on which you set up your collection class control information.

### WARNING:

The information in this page is what controls how the system analyzes your customer's debt. The flexibility of this control information provides you with almost unlimited options. This is very powerful, but it requires careful analysis. Refer to [Designing Your Collection Procedures](#) for more information.

## Collection Class Control - Main Information

The information on this transaction defines the conditions that will be checked by the [Account Debt Monitor](#) when it checks if an account has violated your debt criteria.

Open **Admin > Credit & Collection > Collection Class Control > Add** to define this information.

---

### **FASTPATH:**

For more information about collection class control, refer to [Designing Collection Class Controls](#).

---

### **Description of Page**

Enter a unique **Collection Class Control** code and **Description** for the collection class control (CCC).

Enter the **CIS Division** to which the CCC's criteria applies.

Enter the **Collection Class** to which the CCC's criteria applies.

Enter the **Debt Class** to which the CCC's criteria applies.

Enter the **Currency Code** in which the CCC's criteria are denominated.

Use **Long Description** to further describe the CCC.

---

### **FASTPATH:**

The information in the following grid is not intuitively obvious. Refer to [Designing Collection Class Controls](#) and [Designing Your Collection Class Control Overrides](#) for more information.

---

The grid which follows contains the conditions that are checked by the [Account Debt Monitor](#) (ADM) to determine the type of criteria (defined on the next tab) that will be applied against an account's debt. In other words - the ADM will check each condition (from highest to lowest **Priority**). The first condition that returns a value of true will cause the system to compare the account's debt against the debt criteria defined on the next tab.

Multiple conditions may be defined if different conditions result in a different type of debt thresholds (or a different type of collection process). The following fields are required for each condition:

**Collection Condition Priority** The priority controls the order in which the ADM checks if a collection condition applies (the lower the number, the higher the priority). Higher priorities are checked before lower priorities.

---

### **NOTE:**

The values for this field are customizable using the Lookup table. This field name is COLL\_CAT\_PRIO\_FLG.

---

**Condition Algorithm** Define the algorithm used to check if an account should be subject to the collection criteria defined on the next tab. If the algorithm returns a value of true (i.e., the condition is met), the ADM will compare the account's debt against the **Debt Criteria** (defined on the next tab) and start a collection process if the account has debt that violates these criteria.

You must have at least one collection condition; otherwise the system will not have criteria against which to compare the account's debt. This entry should have the lowest priority code and reference the "default" algorithm. If you haven't done so already, you must set up this algorithm in the system. To do this, create a new algorithm (refer to [Setting Up Algorithms](#)). On this algorithm, reference an Algorithm Type that references the "default" collection condition algorithm type ([COLL COND DF](#)).

If you have other conditions that should be checked before the default condition, you must create an entry for each in this grid. Each entry should have a priority consistent with your business requirements (and this priority should be higher than the default condition's priority). In addition, you should reference an algorithm that contains the conditions that will be checked to determine if the account should be subject to the debt criteria (defined on the next tab). The system is supplied

---

with many additional algorithm types. In order to take advantage of them, you will need to create an algorithm (refer to [Setting Up Algorithms](#) ). On this algorithm, reference an Algorithm Type that references one of the collection condition algorithm types. Click [here](#) to see the algorithm types available for this system event.

### Where Used

Collection class controls contain the data that controls the Account Debt Monitor. Refer to [How Does The Account Debt Monitor Work?](#) for more information.

## Collection Class Control - Debt Criteria

The information on this page defines the debt and age thresholds used by the [Account Debt Monitor](#) when it checks if an account has violated your acceptable levels of debt. Open **Admin > Credit & Collection > Collection Class Control > Search** and navigate to the **Debt Criteria** page to define this information.

---

### NOTE:

**The information on this page is not intuitively obvious.** Refer to [Designing Collection Class Controls](#) and [Designing Your Collection Class Control Overrides](#) for more information.

---

### Description of Page

The **Debt Criteria** scroll contains an entry for each collection criteria algorithm defined on the **Main** tab. The following information appears

The **Collection Condition Priority** controls the order in which the Account Debt Monitor (ADM) checks if a collection condition applies. Higher priorities are checked before lower priorities.

The **Condition Algorithm** is called by the ADM to determine which collection criteria should be applied to the account's debt. If this algorithm returns a value of true (i.e., the condition is met), the ADM will compare the account's debt against the **Debt Criteria** defined below. If the account violates any criteria, a collection process will be started (using the respective **Collection Process Template**).

The grid that follows contains the debt age and amount of debt that must be violated by the account in order for the ADM to create a collection process template. The following fields should be defined:

**Arrears Priority** controls the order in which the arrears criteria will be checked by the Account Debt Monitor (the lower the number, the higher the priority). The first criteria, if any, that is met will cause a collection process to be created (using the **Collection Process Template**).

**Collection Process Template** If the Account Debt Monitor determines that the account's debt violates the corresponding criteria, it creates a collection process using the specified collection process template.

**Arrears Amount** When the Account Debt Monitor checks an account's debt, it determines if the account has debt older than "> Number of Days" (the next field) AND the debt exceeds "> Arrears Amount". If so, a collection process is started.

**Days** When the Account Debt Monitor checks an account's debt, it determines if the account has debt older than **Days** AND the debt exceeds **Arrears Amount**. If so, a collection process is started.

### Where Used

Collection class controls contains the data that controls the [Account Debt Monitor](#).

## Designing Your Severance Procedures

The following matrix will help you design your severance procedures. When the matrix is complete, you're ready to set up the severance process control tables.

Notice that the matrix has two dimensions: one is dependent on severance criteria algorithms; the other is dependent on the SA type of the service agreement being severed. The number and type of SA types is dependent on how your organization sets up the SA type table (the SA types shown below are characteristic of those used by a simple utility).

<b>SA Type</b>	<b>Severance Criteria Algorithm:</b> Default	<b>Severance Criteria Algorithm:</b> <b>Customer On Life Support</b>
Electric Residential		
Electric Commercial		
Gas Residential		
Gas Commercial		
Charitable Contribution		

Once you know the values of each dimension, you fill in each cell with its respective severance events. We've completed the sample matrix with some characteristic events.

<b>SA Type</b>	<b>Severance Criteria Algorithm:</b> Default	<b>Severance Criteria Algorithm:</b> <b>Customer On Life Support</b>
Electric Residential	<p>Create a 48-hour warning field activity.</p> <p>2 days after completion, create a disconnect service field activity.</p> <p>Immediately after completion of the disconnect field activity, send a letter to the customer.</p> <p>10 days after completion of disconnection, expire the service agreement.</p>	<p>Create a To Do entry asking a collection rep to call the customer.</p> <p>5 days later, create a 72-hour warning field activity.</p> <p>2 days after completion, create a To Do entry telling collection rep of impending life support cutoff.</p> <p>3 days after completion of warning, create a disconnect service field activity AND generate a To Do entry informing a collection agent of such.</p> <p>Immediately after completion of the disconnect field activity, send a letter to the customer.</p> <p>10 days after completion of disconnection expire the service agreement.</p>
Electric Commercial	<p>Create a 48-hour warning field activity.</p> <p>2 days after completion, create a disconnect service field activity.</p> <p>Immediately after completion of the disconnect field activity, send a letter to the customer.</p> <p>10 days after completion of disconnection, expire the service agreement.</p>	N/A
Gas Residential	<p>Create a 48-hour warning field activity.</p> <p>2 days after completion, create a disconnect service field activity.</p> <p>Immediately after completion of the disconnect field activity, send a letter to the customer.</p>	<p>Create a 48-hour warning field activity.</p> <p>2 days after completion, create a disconnect service field activity.</p> <p>Immediately after completion of the disconnect field activity, send a letter to the customer.</p>

	10 days after completion of disconnection, expire the service agreement.	10 days after completion of disconnection, expire the service agreement.
Gas Commercial	Create a 48-hour warning field activity.  2 days after completion, create a disconnect service field activity.  Immediately after completion of the disconnect field activity, send a letter to the customer.  10 days after completion of disconnection, expire the service agreement.	N/A
Charitable Contribution	Expire service agreement	Expire service agreement

Once the matrix is complete, you determine the severance process templates needed to implement your severance procedures. The following table shows the severance process templates referenced in the previous section's matrix. Adjacent to each process are its events and an indication of when they are triggered.

Severance Process Template	Event Number	Severance Event Template	Dependent On Event(s)	Trigger Date Set To X Days After Completion Of Dependent Events
Utility severance - default	10	Field activity - 48 hour disconnect for non-payment warning	N/A - first event	0
	20	Field activity - disconnect for non-payment	10	2
	30	'Service has been disconnected' letter	20	0
	40	Expire service agreement	20	10
Electric life support residential severance	10	Generate delinquent life support customer To Do entry	N/A - first event	0
	20	Field activity - 72 hour disconnect for non-payment warning	10	5
	30	Generate impending life support cutoff To Do entry to C&C rep	20	2
	40	Field activity - cut for non-payment	20	3
	50	Service has been disconnected letter	40	0
	60	Expire service agreement	40	10
Just expire severance	10	Expire service agreement	N/A - first event	

If we extract each unique severance event type from the above table, we end up with the following:

Severance Event Template	Event Type



48-hour warning	Generate Field Activity - Disconnect Warning
72-hour warning	Generate Field Activity - Disconnect Warning
Disconnect for non payment	Generate Field Activity - Cut For Non-Payment
Delinquent life support customer	Create To Do Entry - C&C Rep Role
Impending life support cutoff	Create To Do Entry - C&C Rep Role
Service has been disconnected letter	Send Letter - Customer Contact Type is Disconnect Letter
Expire service agreement	Expire Service Agreement

**WARNING:**

The field activity types are NOT specified directly on the severance event type. Why? Because each service point linked to the service agreement being severed could necessitate a different type of field activity. Therefore, the system uses the type of service point, its state (e.g., connected, meter is off.) and the desired customer event (e.g., Disconnect Warning, Cut For Non-Payment) to determine which field activity type(s) to generate. Refer to [Setting Up Field Activity Type Profiles](#) for how to set up the specific disconnect field activity types for your various types of service points.

Now you're (almost) ready to set up your severance procedures.

## Defining Severance Process Auto Cancellation Criteria

The topics in the section [How Are Severance Processes Cancelled](#) describe the two algorithms that play a part in the cancellation of a collection process. It also describes when to use what type of algorithm. Please read this section and then set up the appropriate cancellation criteria on your [Debt Classes](#), and optionally, on your [Severance Process Templates](#).

## Designing Your Reconnection Procedures

If a customer pays for a service agreement after the service has been cut for non-payment AND BEFORE THE SA HAS BEEN EXPIRED, they need to be reconnected. Counter-intuitively, you must set up a severance process to initiate the field activities to reconnect service.

**NOTE:**

**Why do you use a severance process to reconnect service?** Because a severance process is nothing more than a series of events that take place one after another. Some of the events create field activities, others send letters, others create To Do entries. So, why not use a severance process? You just have to send different letters and perform different field activities.

**WARNING:**

The system will automatically create a reconnection process if a severance process is cancelled as a result of a payment (or other credits). Please note that this will only happen if you plug-in the appropriate post cancellation algorithm on your severance process templates. Refer to [What Happens When A Severance Process Is Cancelled?](#) **for more information.**

While you don't define the reconnect procedures for an SA type, we recommend you think about the reconnection steps for each of your SA types that can be disconnected for nonpayment. We've completed the sample matrix with some characteristic events.

SA Type	Steps
---------	-------

Electric Residential	Create a reconnect service field activity. Immediately after completion of the reconnect, send a letter to the customer.
Electric Commercial	Create a reconnect service field activity. Immediately after completion of the reconnect, send a letter to the customer.
Gas Residential	Create a reconnect service field activity. Immediately after completion of the reconnect, send a letter to the customer.
Gas Commercial	Create a reconnect service field activity. Immediately after completion of the reconnect, send a letter to the customer.

Once the matrix is complete, you determine the severance process templates needed to implement your reconnection procedures. Notice each SA type has the same reconnection steps. This means you just need one severance process. The following table shows this severance process template and its events.

Severance Process Template	Event Number	Severance Event Template	Dependent On Event(s)	Trigger Date Set To X Days After Completion Of Dependent Events
Reconnect	10	Field activity - reconnect service	N/A - first event	0
	20	Service has been reconnected letter	10	0

If we extract each unique severance event type from the above table, we end up with the following:

Severance Event Template	Event Type
Reconnect	Generate Field Activity - Reconnect
Service has been reconnected letter	Send Letter

**WARNING:**

The field activity types are NOT specified directly on the severance event type. Why? Because each service point linked to the service agreement being severed could necessitate a different type of field activity. Therefore, the system uses the type of service point, its state (e.g., connected, meter is off.) and the desired customer event (e.g., Disconnect Warning, Cut For Non-Payment) to determine which field activity type(s) to generate. Refer to [Setting Up Field Activity Type Profiles](#) for how to set up the specific disconnect field activity types for your various types of service points.

**IMPORTANT:**

If you want the system to automatically create a reconnection process if a customer pays after they have been cut, you must specify the appropriate post cancellation algorithm on your severance process templates.

And now you're ready to set up your severance (and reconnection) procedures.

## Setting Up Severance Procedures

In the previous section, [Designing Your Severance Procedures](#), we presented a case study that illustrated a mythical organization's severance procedures. In this section, we'll explain how to set up the control tables to implement these procedures:

## Setting Up Severance Event Types

Severance event types control what is done by a given severance event. Open **Admin > Credit & Collection > Severance Event Type > Add** to define your severance event types.

---

**FASTPATH:**

For more information refer to [Designing Your Severance Procedures](#).

---

### Description of Page

Enter a unique **Severance Event Type** code and **Description** for the severance event type.

Enter the Severance **Event Type**. Permissible values are: Affect Credit Rating/Cash-Only, Send Letter, Generic Algorithm, Create To Do Entry, Create Field Activities, Expire Service Agreement. The following discussion describes the parameters that must be defined for each type of severance event.

The Affect Credit Rating/Cash-Only collection event type causes a credit rating demerit record to be linked to the account. This record is constructed using the following **Parameters**:

- account debt monitor.
- Use **Cash-Only Points** to define this event's affect on the account's cash-only score. This should be a positive number. When an account's cash-only score exceeds the cash-only threshold score defined on the installation record, the account is flagged as cash-only during payment processing and on Control Central.
- Use **Cash-Only Points** to define this event's affect on the account's cash-only score. This should be a positive number. When an account's cash-only score exceeds the cash-only threshold score defined on the installation record or the account's CIS Division, the account is flagged as cash-only during payment processing and on Control Central.

The Send Letter severance event type causes a customer contact to be generated that, in turn, generates a letter. Enter the following **Parameters** for this type of event:

- Select the **Contact Class** used to categorize the customer contact.
- Use **Contact Type** to define the type of customer contact to create. The type of customer contact controls the type of letter that is generated.

The Generic Algorithm severance event type causes the algorithm defined in the **Sev. Event Algorithm** to be executed. You use this type of algorithm when the standard types of severance events won't do what you need done.

The Create To Do Entry severance event type causes a To Do entry to be created. Refer to [The Big Picture of To Do Entries](#) for more information about To Do entries (refer to the To Do type TD-SEVT for the type of To Do entry that's created).

The Generate Field Activities severance event type causes one or more field activities to be generated. Enter the following **Parameters** for this type of event:

- Select the **Customer Event** associated with the field activity. Valid values are: Cut For Non-Payment (CNP), Disconnect Warning (Disc Warn), Reconnect for Payment (Reconn), Start Service (Start) , Start/Stop Service (Start/Stop), Stop Service (Stop), Reread (Reread).

- The system uses the **Customer Event** to select the appropriate field activity type(s) from the field activity type profile associated with the service points linked to the service agreement.

---

**WARNING:**

The field activity types are NOT specified directly on the severance event type. Why? Because each service point linked to the service agreement being severed could necessitate a different type of field activity. Therefore, the system uses the type of service point, its state (e.g., connected, meter off) and the desired customer event (e.g., Disconnect Warning, Cut For Non-Payment) to determine which field activity type(s) to generate. Refer to [Setting Up Field Activity Type Profiles](#) for how to set up the specific disconnect field activity types for your various types of service points.

---

The Expire Service Agreement severance event type causes the service agreement to be moved to the pending stop state (it also populates the service agreement's stop date). Refer to [Finalizing Pending Stops](#) for how the system will eventually stop the service agreement (and then final bill it). There are no parameters for this type of event.

---

**NOTE:**

**Cut for non-payment field activities are special.** The Expire Service Agreement severance event type also makes any "cut for non-payment" field activities created by earlier severance events available to stop service. Specifically, it changes the linkage type of the field activities from Severance Activity to Stop Activity. You can see a service agreement's service points' field activities and their respective linkage type on [Service Agreement - Service Point](#).

---

Enter a **Long Description** to fully describe the severance event type.

**Where Used**

Follow this link to open the data dictionary where you can view the tables that reference [CI\\_SEV\\_EVT\\_TYPE](#).

## Setting Up Severance Process Templates

Severance process templates define the severance events that will be executed when a service agreement is severed. Open **Admin > Credit & Collection > Severance Process Template > Add** to define your severance process templates.

**Description of Page**

Enter a unique **Severance Process Template** and **Description** for the severance process template.

If severance processes of this type should be automatically canceled when the customer pays the collection amount on the severance, turn on **Auto Cancel**. This switch would typically only be turned off for severance processes used to reconnect a cut service because you don't want such a reconnection process to be canceled when a payment is made. Refer to [Designing Your Reconnection Procedures](#) for more information.

In addition to turning on the **Auto Cancel** switch, specify a **Cancel Criteria Algorithm** if your organization allows a severance process to be cancelled regardless of the debt associated with all service agreements in the debt class. In other words, if your cancel criteria are based on the debt associated with ALL service agreements in a debt class DO NOT SPECIFY THIS ALGORITHM.

If the **Cancel Criteria Algorithm** is specified, it is executed when a credit is posted to the service agreement associated with a severance process. This algorithm will indicate if the service agreement no longer has debt that warrants a severance process. Refer to [How Are Severance Processes Cancelled](#) for more information. If you haven't done so already, you must set up this algorithm in the system. To do this, create a new algorithm (refer to [Setting Up Algorithms](#)). On this algorithm, reference an Algorithm Type that cancels a severance process if the service agreement's debt so warrants. Click [here](#) to see the algorithm types available for this plug-in spot.

If you wish to perform any special processes after a severance process is canceled, specify a **Post Cancel Algorithm**. This can be used to start a reconnection in case the severance process was canceled too late to stop the disconnection. If you haven't done so already, you must set up this algorithm in the system. To do this, create a new algorithm (refer to [Setting](#)

[Up Algorithms](#)). On this algorithm, reference an Algorithm Type that cancels a severance process if the service agreement's debt so warrants. Click [here](#) to see the algorithm types available for this plug-in spot.

When a service agreement is to be severed due to non-payment, the system creates a severance process and links to it one or more severance events based on the **Event Types** entered here. The information in the scroll defines these events and the date on which they will be triggered. The following fields are required for each event:

**Event Sequence** controls the order in which the severance event types appear under the severance process template. The sequence number is system-assigned and cannot be changed. If you have to insert a severance event type between two existing templates, you'll have to remove the latter events, insert the new event, and then re-specify the removed events.

**Severance Event Type** Specify the type of severance event to be generated.

**Dependent On Other Events** Turn this indicator on if the trigger date of the event can only be determined after earlier events are complete. For example, you would turn this switch on for the event that initiates the field activity to disconnect service. Why? Because you only want to disconnect service after the preceding event that warned the client of impending disconnection is complete.

**Days After Prev Response** Specify the number of days after the completion / cancellation of the dependent events on which the severance event will be triggered. If this event is not dependent on the completion of other events, this field contains the number of days after the creation of the severance process that the related severance event will be triggered. Refer to [Severance Event Dependencies and Trigger Date](#) and [Calendar vs Work Days](#) for a description of how the system uses this information to set the trigger date on the respective severance events.

When the **Dependent On Other Events** switch is on, use the grid to define the events on which this event is dependent. If multiple events are specified in the grid, all such events must be completed or cancelled before the event will be triggered.

**Sequence** is system-assigned and cannot be specified or changed.

**Dependent On Sequence** Specify the sequence number of the severance event on which the above severance event depends.

---

**FASTPATH:**

For more information about severance event types, see [Setting Up Severance Event Types](#). For more information about trigger dates, see [Severance Event Dependencies & Trigger Date](#).

---

## Where Used

Follow this link to open the data dictionary where you can view the tables that reference [CI\\_SEV\\_PROC\\_TMP](#).

## Designing Your Write-Off Procedures

The design of your write-off procedures is relatively straightforward. Simply follow the instructions in the following topics.

## Designing Your Write-Off Debt Classes

Multiple write-off debt classes are needed when you have different write-off procedures for different types of service agreements. If all service agreement debt is written-off the same way, then you'll have just one write-off debt class (call it Generic ). However, if you're like many organizations, you will have multiple write-off debt classes. The following points will help you understand why:

- If you bill for 3<sup>rd</sup> parties, you probably have different write-off debt classes for the 3<sup>rd</sup> party service agreements. Why? Because you probably treat 3<sup>rd</sup> party uncollectable debt differently from your own debt.
- You will need a separate write-off debt class for service agreements whose debt cannot be written off. Why? Because there is a switch on the write-off debt class control table that controls if service agreements in the write-off debt class are eligible for write-off processing. Given that you will have some service agreements that hold debt that aren't eligible for

write-off processing (e.g., service agreements that hold written-off debt and service agreements that overpayments), you will need at least one other write-off debt class.

- If you use the system to calculate charges for your organization's company usage, you'll need another write-off debt class (we refer to it as the "N/A" write-off debt class below). Why? Because all service agreements must have a write-off debt class, even those that will never have debt.

SA's Write-Off Debt Class	Account's Collection Class	Account's Collection Class
Normal W/O		
N/A		

## Designing Write-Off Controls

Set up a matrix using the collection classes you designed when you were designing your collection procedures ( [Designing Your Collection Procedures](#) ).

SA's Write-Off Debt Class	Account's Collection Class	Account's Collection Class
	Residential	Commercial/Industrial
Normal Write Off		
N/A		

Each cell should have a "write-off control" that defines what to do when the system detects finalized debt that hasn't been paid. This is true even of the "N/A" write-off debt class. Why? Because you may want the system to write-down these stopped SAs when they have a small balance. For example, if you have a write-off service agreement that subsequently receives a partial payment that leaves a small amount owing, you probably want the system to generate a write-down adjustment (so that the write-off service agreement will close). We'll initially fill in the matrix for the "N/A" write-off debt class.

SA's Write-Off Debt Class	Account's Collection Class	Account's Collection Class
	Residential	Commercial/Industrial
Normal Write Off		
N/A	Attempt to reduce the SA's balance to zero using the following methods:  Synchronize current balance with payoff balance.  If the debt is < \$10 and > \$-1, write down the debt using a write-down adjustment.	Attempt to reduce the SA's balance to zero using the following methods:  Synchronize current balance with payoff balance.  If the debt is < \$10 and > \$-1, write down the debt using a write-down adjustment.

**NOTE:**

If the Write Off Monitor encounters debt associated with a non-defined collection class and write-off debt class, it will issue an error.

For each cell that isn't designated as N/A, you need to answer the following questions:

- Are you allowed to transfer debt to other non-closed service agreements linked to the account? If so, you need to define the algorithm used to do such. Refer to [Setting Up Write-off Control](#) for more information about this algorithm.

- Are you allowed to write-down small amounts of debt (or small credits)? If so, you need to define the algorithm used to do such. Refer to [Setting Up Write-off Control](#) for more information about this algorithm.
- Should you refund credit balances with a check? If so, you need to define the algorithm to do such. Refer to [Setting Up Write-off Control](#) for more information about this algorithm.
- If debt remains after doing the above, how do you write it off (e.g., do you first refer the debt to a collection agency and only write it off after waiting 30 days)?

We'll fill in the above matrix with our assumptions:

SA's Write-Off Debt Class	Account's Collection Class	
	Residential	Commercial/Industrial
Normal Write-Off	<p>Attempt to reduce the SA's balance to zero using the following methods:</p> <p>Attempt to transfer debt to another active service agreement linked to the account.</p> <p>If the debt is &lt; \$10 and &gt; \$-1, write down the debt using a write-down adjustment.</p> <p>If the debt is &lt;= \$-1, create an A/P adjustment to refund the credit to the customer.</p> <p>If debt remains:</p> <p>Highest priority: If customer has a non-cash deposit, create the non-cash deposit write-off process.</p> <p>Otherwise, create the default write-off process for residential debt.</p>	<p>Attempt to reduce the SA's balance to zero using the following methods:</p> <p>Attempt to transfer debt to another active service agreement linked to the account.</p> <p>If the debt / credit is &lt; \$10 and &gt; \$-10, write down the debt using a write-down adjustment.</p> <p>If the debt / credit is &lt;= \$-10, create an A/P adjustment to refund the credit to the customer.</p> <p>If debt remains:</p> <p>Highest priority: If customer has a non-cash deposit, create the non-cash deposit write-off process.</p> <p>Otherwise, create the default write-off process for commercial debt.</p>
N/A	<p>Attempt to reduce the SA's balance to zero using the following methods:</p> <p>Synchronize current balance with payoff balance.</p> <p>If the debt is &lt; \$10 and &gt; \$-1, write down the debt using a write-down adjustment.</p> <p>Because this debt class isn't eligible for further write-off processing, criteria used to process debt are not necessary.</p>	<p>Attempt to reduce the SA's balance to zero using the following methods:</p> <p>Synchronize current balance with payoff balance.</p> <p>If the debt is &lt; \$10 and &gt; \$-1, write down the debt using a write-down adjustment.</p> <p>Because this debt class isn't eligible for further write-off processing, criteria used to process debt are not necessary.</p>

We can now use the information in the above matrix to design the necessary Write Off Process Templates and Write Off Event Types.

## Designing Write Off Process Templates & Write Off Event Types

The following table shows the write-off process templates referenced in the previous section's matrix. Adjacent to each process are its events and an indication of when they are triggered.

Write Off Process Template	Write Off Event Type	Triggered X Days From Start Of Write Off Process
Residential	Refer to collection agency	0
	Letter notifying customer of referral	0

	Cancel collection agency referral	60
	Write off	60
Non-Cash Deposit Exists	To Do for non-cash deposit redemption	0
	To Do to highlight unpaid SA(s) still exist (and they will be reconsidered for write-off processing)	10
Commercial	Refer to collection agency	0
	Letter notifying customer of referral	0
	To Do to check up on collection agency's efforts	30
	Cancel collection agency referral	60
	Write off	60

If we extract each unique event type from the above table, we end up with the following:

Write Off Event Type	Event Type
Notification of write-off referral	Send letter - Debt referred to a collection agency
Refer to collection agency	Refer to collection agency
Cancel collection agency referral	Cancel collection agency referral
Write off	Write off
To Do for non-cash deposit redemption	Generate To Do - Redeem non-cash deposit
To Do to highlight unpaid SA(s) still exist	Generate To Do - SA(s) linked to a non-cash deposit remain unpaid (and will be reconsidered for write-off processing)
To Do to check up on collection agency's efforts	Generate To Do - Check up on collection agency's efforts

And now you're ready to set up your write-off procedures.

## Setting Up Write-Off Procedures

In the previous section, [Designing Your Write-Off Procedures](#), we presented a case study that illustrated a mythical organization's write off procedures. In this section, we'll explain how to set up the control tables to implement these procedures:

### Setting Up Write Off Debt Classes

Every SA type has a write-off debt class. This class is one of several fields that control the write off criteria applied to the service agreement's debt. Select **Admin > Credit & Collection > Write Off Debt Class** to define your debt classes.

**FASTPATH:**

For more information about debt classes, see [Designing Your Write-Off Debt Classes](#).

#### Panel controls

To modify a write-off debt class, simply move to a field and change its value. To add a new write-off debt class, click + to insert a row, then fill in the information for each field. The following fields display:



**Write Off Debt Class Code** The unique identifier of the write off debt class.

**Eligible for Write Off** Indicates if service agreements belonging to this write off debt class are eligible for write-off processing. This should only be turned off if this debt cannot be written off, e.g., write off debt.

**Description** The description of the write off debt class.

#### Where Used

Follow this link to open the data dictionary where you can view the tables that reference [CI\\_WO\\_DEBT\\_CL](#).

## Setting Up Write Off Event Types

Write-off event types control what is done by a given write-off event. Select **Admin > Credit & Collection > Write Off Event Type > Add** to define your write-off event types.

#### Description of Page

Enter a unique **Write Off Event Type Code** and **Description** for the write-off event type.

Enter the **Write Off Event Type**. Permissible values are: Affect Credit Rating/Cash-Only, Cancel Agency Referral, Generic Algorithm, Refer to Agency, Send Letter, Create To Do Entry, Write Off using Distrib Code, and Write Off using SA Type. The following discussion describes the parameters that must be defined for each type of write-off event.

The Affect Credit Rating/Cash-Only write-off event type causes a credit rating demerit record to be linked to the account. This record is constructed using the following **Parameters**:

- Use **Affect Credit Rating By** to define this event's affect on the account's credit rating. This should be a negative number. An account's credit rating is equal to the beginning credit rating amount defined on the installation record or the account's CIS Division plus the sum of credit rating demerits that are currently in effect. When an account's credit rating is less than the credit rating threshold defined on the installation record or the account's CIS Division, the account's credit rating is displayed as an alert on Control Central.
- Use **Affect Cash-Only Score By** to define this event's affect on the account's cash-only score. This should be a positive number. When an account's cash-only score exceeds the cash-only threshold score defined on the installation record or the account's CIS Division, the account is flagged as cash-only during payment processing and on Control Central.
- Use **Months Affecting Credit Rating** to define the length of time the demerit remains in effect. This information is used to define the effective period of the credit rating demerit record.

---

#### FASTPATH:

For more information, refer to [Account - Credit Rating](#).

---

The Cancel Agency Referral event type will cancel previous collection agency referrals. No parameters are needed for this type of event.

The Generic Algorithm write-off event type causes the algorithm defined in the **Generic Algorithm** to be executed. You use this type of algorithm when the standard types of write off events won't do what you need done. If you haven't done so already, you must set up this algorithm in the system. To do this:

- Create a new algorithm (refer to [Setting Up Algorithms](#)).
- On this algorithm, reference an Algorithm Type that determines the algorithm that will be called when events of this type are activated. Click [here](#) to see the algorithm types available for this plug-in spot.

The Refer to Agency event type will refer the debt associated with the process' SAs to a collection agency. You must supply the **Agency Selection Algorithm** that is used to determine the collection agency associated with the referral. If you haven't done so already, you must set up this algorithm in the system. To do this:

- Create a new algorithm (refer to [Setting Up Algorithms](#)).

- On this algorithm, reference an Algorithm Type that determines the collection agency to which bad debt should be referred. Click [here](#) to see the algorithm types available for this plug-in spot.

---

**NOTE:**

**Letters.** You must set up a customer contact type for each type of letter you generate. You specify the necessary customer contact type on the write off event type. Refer to [Setting Up Letter Templates](#) for more information.

---

The Send Letter write-off event type causes a customer contact to be generated that, in turn, generates a letter. Enter the following parameters for this type of event:

- Select the **Contact Class** used to categorize the customer contact.
- Use **Contact Type** to define the type of customer contact to create. The type of customer contact controls the type of letter that is generated.

The Create To Do Entry write-off event type causes a To Do entry to be issued. Refer to [The Big Picture of To Do Entries](#) for more information about To Do entries (refer to the To Do type TD-WOEV for the type of To Do entry that's created).

The Write Off using Distrib Code event type causes bad debt to be written off in accordance with the distribution codes associated with the financial transactions that caused the debt in the first place. Use this method if, for example, you want to write-off revenue differently than you write-off liabilities. When this type of event is activated, the system accumulates the distribution codes from GL details associated with recent financial transactions linked to each write-off service agreement. When the system has accumulated enough distribution codes (i.e., where the amount associated with the distribution code equals or exceeds the amount to write off), the debt will be transferred to a new or existing write-off service agreements. The type of service agreements to which the debt is transferred is defined on the distribution codes. Refer to [Setting Up Distribution Codes](#) for more information.

The Write Off using SA Type event type causes all debt associated with the process' SAs to be transferred to a write-off service agreement linked to the account. Enter the following **Parameters** for this type of event:

- **CIS Division / SA Type** is the type of write-off service agreement to which the debt will be transferred. Note well,
  - The system will reuse an existing service agreement if an active SA of this type is already linked to the account; otherwise the system will create a new service agreement of this type.
  - The adjustment type used to set the offending service agreement's current balance equal to its payoff balance is defined on the write-offable SA Type. Refer to [SA Type - Main Information](#) for more information.
  - The adjustment type used to transfer the delinquent debt to the write-off service agreement is defined on the write off SA type. Refer to [SA Type - Detail](#) for more information.

Enter a **Comment** to fully describe the write-off event type.

**Where Used**

Follow this link to open the data dictionary where you can view the tables that reference [CI\\_WO\\_EVT\\_TYP](#).

## Setting Up Write Off Process Templates

Write-off process templates define the write-off events that will be executed when a write-off criteria rule is violated. Select **Admin > Credit & Collection > Write Off Process Template > Add** to define your write-off process templates.

**Description of Page**

Enter a unique **Write Off Process Template** code and **Description** for the write-off process template.

The rows in the following grid define the events that will be created when a write off process is created using this template. The following fields display:

**Event Sequence** controls the order in which the write-off event is executed. The sequence number is system assigned and cannot be changed. If you need to insert a write-off event between two existing events, you must remove the latter events, insert the new event, and then re-enter the removed events.

**Write-off Event Type Code** Specify the type of write-off event to be generated. The event type's description is displayed adjacent.

**Days After Process Creation** Specify the number of days after the creation of the write-off process that the related write-off event will be triggered. Refer to [Calendar vs Work Days](#) for a description of how this system uses this information to set the trigger date on the respective write-off events.

---

**FASTPATH:**

For more information about write-off event types, see [Setting Up Write Off Event Types](#). For more information about trigger dates, see [Write-off Event Trigger Date](#).

---

### Where Used

Follow this link to open the data dictionary where you can view the tables that reference [CI\\_WO\\_PROC\\_TMPL](#).

## Setting Up Write Off Control

Write-off controls define how the system handles finalized, unpaid debt belonging to a given collection class and write off debt class.

### Write Off Control - Main

Select **Admin > Credit & Collection > Write Off Control > Add** to define basic information about a write-off control. After entering basic information, navigate to the **Criteria** tab to define the type of write-off process to start when given criteria are met.

---

**FASTPATH:**

For more information about write-off control, refer to [Designing Write-Off Controls](#).

---

### Panel controls

Enter a **Write Off Control** code and **Description** for the write-off control (WOC).

Enter the **Collection Class** to which the WOC applies.

Enter the **Write Off Debt Class Code** to which the WOC applies.

Enter general **Comments** to further describe the WOC.

Define the **Synch All Algorithm** used by the system to generate adjustments that cause current balance to equal payoff balance on the service agreements to be written off. This type of algorithm is issued before you actually start a write-off process as current balance is meaningless at write-off time (the customer owes you the payoff balance). If you haven't done so already, you must set up this algorithm in the system. To do this:

- Create a new algorithm (refer to [Setting Up Algorithms](#)).
- On this algorithm, reference an Algorithm Type that synchronizes current and payoff balances. Click [here](#) to see the algorithm types available for this plug-in spot.

Define the **Debt Transfer Algorithm** used by the system when it attempts to transfer the unpaid debt to another active service agreement linked to the stopped SA's account. If you haven't done so already, you must set up this algorithm in the system. To do this:

- Create a new algorithm (refer to [Setting Up Algorithms](#)).
- On this algorithm, reference an Algorithm Type that transfers unpaid balances. Click [here](#) to see the algorithm types available for this plug-in spot.

Define the **Write Down Algorithm** used by the system when it attempts to write-down small debt and/or credit balances. If you haven't done so already, you must set up this algorithm in the system. To do this:

- Create a new algorithm (refer to [Setting Up Algorithms](#)).
- On this algorithm, reference an Algorithm Type that writes down small amounts. Click [here](#) to see the algorithm types available for this plug-in spot.

Define the **Credit Refund Algorithm** used by the system when it refunds a credit balance to a customer. If you haven't done so already, you must set up this algorithm in the system. To do this:

- Create a new algorithm (refer to [Setting Up Algorithms](#)).
- On this algorithm, reference an Algorithm Type that refunds credit balances. Click [here](#) to see the algorithm types available for this plug-in spot.

## Write Off Control - Criteria

Select **Admin > Credit & Collection > Write Off Control > Search** and navigate to the **Criteria** page to define the type of write-off process to start when given criteria are met.

---

### FASTPATH:

The following information is not intuitively obvious. Refer to [Designing Write-Off Controls](#) for more information.

---

### Panel controls

The information in the grid defines the write-off process to be executed for debt belonging to the previously defined collection class and write off debt class. The type of write-off process may differ depending on some condition. For example, you may have a different write-off process if the customer has a non-cash deposit. You must have at least one entry in this collection otherwise the system will not start a write-off process. This entry should have the lowest priority code and should reference a **Write Off Criteria Algorithm** that references the WO CRIT DFLT the algorithm type.

The following fields display:

**Priority** controls the order in which the criteria will be checked by the Write Off Monitor (higher priorities are checked before lower priorities). The first criteria algorithm that is met (i.e., returns a value of *True*) will cause the associated write-off process to be initiated.

---

### NOTE:

The values for this field are customizable using the Lookup table. This field name is CRIT\_PRIO\_FLG. Be aware that this field is used for multiple tables: [Collection Class Control](#), [Severance Criteria](#), and [Write Off Control](#) .

---

**Write Off Criteria Algorithm** The Write Off Monitor checks if the condition defined by the W/O Condition Algorithm applies to the account whose debt is being analyzed. If a condition is met, a write-off process is created using the associated write-off process template.

If you haven't done so already, you must set up this algorithm in the system. To do this:

- Create a new algorithm (refer to [Setting Up Algorithms](#)).
- On this algorithm, reference an Algorithm Type that determines if a customer's bad debt should be processed using the associated **Write Off Process Template**. Click [here](#) to see the algorithm types available for this plug-in spot.

---

### IMPORTANT:

You must have at least one entry in this grid otherwise the system will not start a write-off process. This entry should have the lowest priority code and should reference a **W/O Criteria Algorithm** that references the [WO CRIT DFLT](#) algorithm type.

---

**Write Off Process Template** If the Write Off Monitor determines the condition defined by the w/o condition algorithm applies, a write-off process is created using the associated write-off process template.

#### Where Used

Write-off controls contain the data that controls the Write Off Monitor. Refer to [How Does The Write-Off Monitor Work?](#) for more information.

## Setting Up Collection Agencies

You must set up a collection agency for each such organization to which you refer delinquent debt. To define a collection agency, select **Admin > Credit & Collection > Collection Agency**.

#### Description of Page

Enter an easily recognizable **Collection Agency** code and **Description** for each collection agency.

A collection agency must be associated with a Person. Choose the **Person ID** of the organization from the prompt.

---

#### FASTPATH:

Information about how to set up persons is discussed in [Maintaining Persons](#).

---

Turn on the **Active** switch if the collection agency is actively receiving referrals.

Specify the **Batch Control** that's used to route new and cancelled referrals to the collection agency. The batch control's description is displayed adjacent.

#### Where Used

Collection agencies get assigned to collection agency referrals when the collection agency referral background process executes. Refer to [How Do Collection Agency Referrals Work?](#) for more information.

## Setting Up Feature Configuration

You must set up a [Feature Configuration](#) if you use the [champion / challenger](#) functionality.

The following describes the various **Option Types** that must be defined:

Champion Template\$Challenger Template\$Percentage(1-100). You need only set up options of this type if your implementation implements [Champion / Challenger](#) functionality. Options of this type are entered in the format A\$B\$nnn where A is the collection process template of the champion template, B is the collection process template of the challenger template, and C is the percent of the time that the system should create the challenger template. The collection monitor uses this option to override the champion collection process template X% of the time with the challenger template. You may enter any number of these options (but only one per Champion Template).

## How To

The contents of this section describe how to set up various credit and collections scenarios.

# How To Nominate A Single Service To Sever (Rather Than Sever Everything That's In Arrears)

Some organizations that offer multiple services do not sever all services when the customer falls into arrears. Rather, they nominate a single service agreement to sever in the hopes that the lack of service will cause the customer to remit payment. The following diagram illustrates the control tables values required to implement this type of requirement.

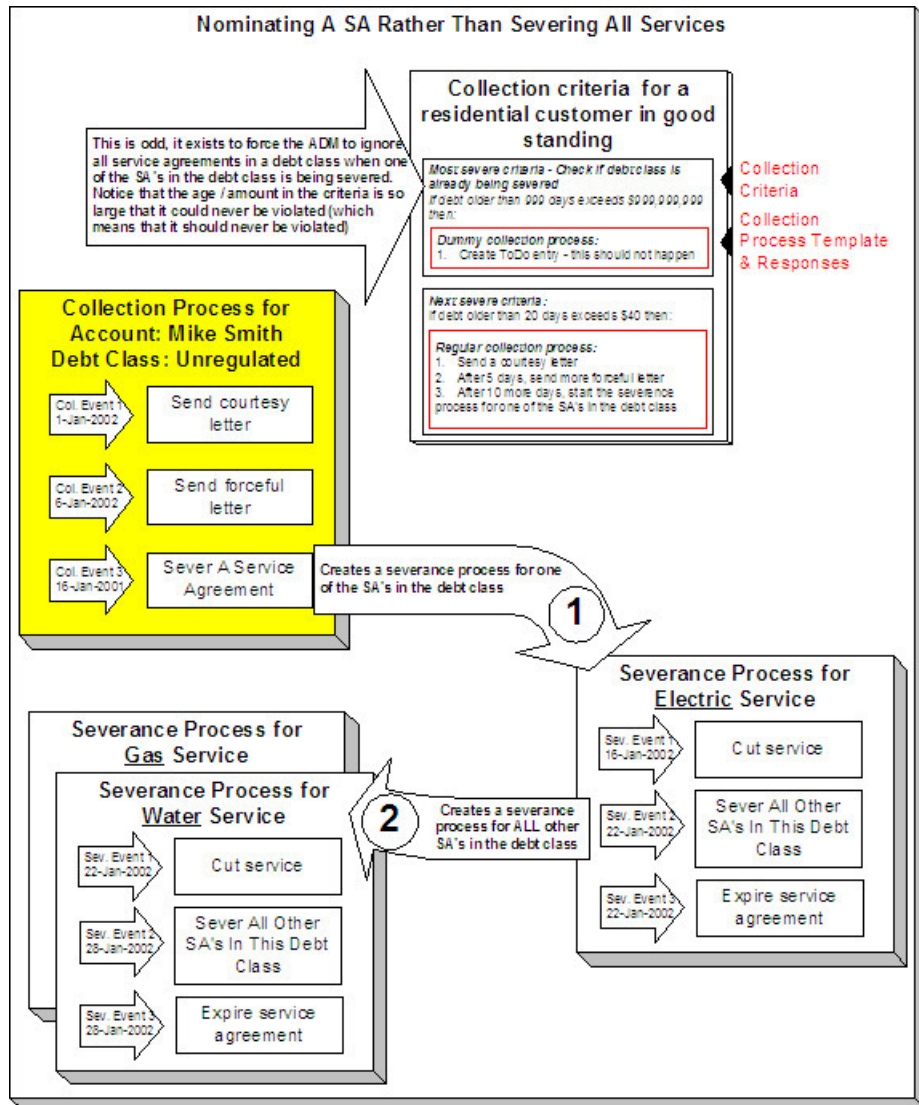

The following important concepts are illustrated above:

- The collection process's last event does NOT sever all services. Rather, it calls an algorithm that selects a single service to sever. A base package algorithm allows you to define the primary service to sever and a secondary service to sever (if the customer does not have the primary service). If you sold electricity and gas, you would probably define the primary service as electricity and the secondary as gas (because electricity is easier to cutoff than gas).
- The severance process that is started for the primary service cuts service. If the customer doesn't remit what is owed, the second severance event calls an algorithm that severs all other service agreements in the debt class.

- Because you are nominating a single service to sever, you must set up a special value in collection class control to force the ADM to ignore all service agreements in a debt class when one of the SAs in the debt class is being severed. Notice that the age / amount in the criteria is so large that it could never be violated.
- In addition, because the entire debt class must no longer be in arrears to stop the collection and severance processes, you must plug-in the appropriate collection process and severance process cancellation criteria on the debt class. Refer to [How Are Collection Processes Cancelled](#) and [How Are Severance Processes Cancelled](#) for more information about how these algorithms are used. Also note, you do not need service agreement cancellation criteria defined on your collection process templates and severance process templates (because cancellation is controlled at the debt class level).

## Defining Asset Options

### Asset Types

#### Understanding Asset Types

Asset types define the attributes for assets and components of a certain type including information such as the valid location types and service history types for the assets and whether or not such assets can have attached components.

Asset types are defined by:

- **Component Relationship:** A flag that indicates if components can be installed on assets or components of this type
- **Asset Business Object:** The business object used for assets or components based on this asset type
- **Valid Location Types:** A list of location types where assets or components of this type can be located
- **Valid Attached To Asset Types:** A list of valid asset types where components of this type can be attached (applicable to components only)
- **Valid Service History Types:** A list of valid service history types that can apply for assets or components of this type

Refer to [Defining Asset Types](#) for more information about setting up asset types.

#### Asset Classes

Assets are defined by classes, each of which is based on a specific business object, and determines the type of asset: an asset or a component.

The table below lists the asset classes and the business object for each.

Asset Class	Business Object
Asset	W1-AssetType (Operational Device Asset Type)
Component	W1-ComponentType (Operational Device Component Type)

### Defining Asset Types

You use the **Asset Type** portal to display and maintain asset types.

Refer to [Understanding Asset Types](#) for more information.



You can access the portal from **Admin > Asset Management > Asset Type**. You are brought to a query portal with options for searching. Once your record has been selected you are brought to the maintenance portal to view and maintain the selected record.

The following zones may appear as part of the portal's **Main** tab page:

- **Asset Type** : This zone provides information about the asset type.
- **Asset Type Statistics**: This zone displays statistics for the asset type.

## Where Used

Follow this link to open the data dictionary where you can view the tables that reference [WI\\_ASSET\\_TYPE](#).

# Service History Types

## Understanding Service History Types

Service history types define the main attributes for service history of a certain type. Types might include maintenance, inspection, service, test, measurement, and so on.

Service history types are defined by the following:

- **Service History Business Object**: The business object used to create service history records of this type.
- **Category**: The category to which service history records of this type belong. The base package includes the following categories:
  - Downtime
  - Failure
  - Inspection
  - Maintenance
  - Repair
- **Service Schedules**: One or more template work orders and time intervals that should be used to schedule work order generation for service history records of this type

If service histories of a certain service history type need follow-up actions, such as work orders or work order activities, users can configure those follow-up actions on the service history type. Note that you will need to specify a compliance type if a regulatory compliance requirement is associated with your follow-up action.

For example, if you have a Service History Type of “Grade 2 Gas Leak”, users could define a follow-up action of “Recheck” which could be configured with a “30 day” Compliance Type and a follow-up action of “Repair” which could be configured with a “1 year” Compliance Type.

## Defining Service History Types

You use the **Service History Type** portal to display and maintain service history types.

Refer to [Understanding Service History Types](#) for more information.

You can access the portal from **Admin > Asset Management > Service History Type**. You are brought to a query portal with options for searching. Once your record has been selected you are brought to the maintenance portal to view and maintain the selected record.

The following zones may appear as part of the portal's **Main** tab page:



- **Service History Type** : This zone provides information about the service history type.

## Where Used

Follow this link to open the data dictionary where you can view the tables that reference [W1\\_SVC\\_HIST\\_TYPE](#).

# Configuration Types

## Understanding Configuration Types

Configuration types define the information required for various asset configurations with other assets, components, firmware, and other data.

Configurations are referenced on specifications which are then referenced on assets and components to indicate the best way that these entities can work with the other entities that they are connected to in the field.

Configuration types are defined by the following:

- **Configuration Class**: The class for configurations of this type
- **Configuration Category**: The category of configurations of this type
- **Configuration Business Object**: The business object used for configurations of this type

## Configuration Classes

In general configuration classes define the types of connections that are being configured. Each configuration class is based on a specific business object, which is the business object used for configurations of each class and type.

The table below lists the configuration classes and the business object for each.

Configuration Class	Business Object
Single Asset	W1-SingleAssetConfig (Single Asset Configuration)
Asset/Component	W1-AssetCompConfig (Asset/Component Configuration)
Asset to Asset	W1-AssetToAssetCompConfig (Asset to Asset/Component Configuration)
Asset/Component to Asset	W1-AssetCompToAssetConfig (Asset/Component to Asset Configuration)
Asset to Asset/Component	W1-AssetToAssetConfig (Asset to Asset Configuration)
Asset/Component to Asset/Component	W1-AssetCompToAssetCompConfig (Asset/Component to Asset/Component Config)

## Defining Configuration Types

You use the **Configuration Type** portal to display and maintain configuration types.

Refer to [Understanding Configuration Types](#) for more information.

You can access the portal from **Admin > Asset Management > Configuration Type**.

The following zones may appear as part of the portal's **Main** tab page:

- **Configuration Type:** This zone lists all configuration type records. Broadcast a record to display the details of the selected record.
- **Configuration Type :** This zone provides information about the selected configuration type.

## Where Used

Follow this link to open the data dictionary where you can view the tables that reference [WI\\_CONFIG\\_TYPE](#).

# Configurations

## Understanding Configurations

Configurations document and manage valid setups for assets and components. This includes a specification for each asset or component in the configuration as well as the valid value for each parameter, such as the firmware version of each asset.

Configurations are defined by the following:

- **Configuration Type:** The [configuration type](#) upon which the configuration is based
- **Status:** The current status of the configuration
- **Configuration Detail:** Specific information related to the configuration such as the assets and components involved, the firmware, characteristics, identifiers and other important information

## Defining Configurations

You use the **Configuration** portal to display and maintain configurations.

Refer to [Understanding Configurations](#) for more information.

You can access the portal from **Admin > Configuration Report > Configuration**. You are brought to a query portal with options for searching. Once your record has been selected you are brought to the maintenance portal to view and maintain the selected record.

The following zones may appear as part of the portal's **Main** tab page:

- **Configuration:** This zone provides information about the selected configuration.
- **Configuration Attachments:** This zone lists any attachments defined for the configuration.

## Where Used

Follow this link to open the data dictionary where you can view the tables that reference [WI\\_CONFIG](#).

# Configuration Reports

## Understanding Configuration Reports

Configuration reports provide a summary of any currently installed configurations.

These reports show whether the configuration in an installation is valid or invalid, the identifiers and values being used, and display all of the assets/components and other elements that make up the installed configuration.

Configuration reports are defined by the following:

- **Reporting Mode:** The mode in which the report is run (One Time or Recurring)
- **Status:** The current status of the report (Pending or Submitted)
- **Report Criteria:** Specific information used to establish the filter criteria when generating the report, such as the assets and components involved, the firmware, characteristics, identifiers and other important information.
- **Report Result:** Specific information for each configuration, including the number of configurations, the assets and components involved, and the specifications and firmware versions of each. If the configuration is invalid, the **Configuration** column is blank in the report results. Users can navigate to specific valid configurations to review and edit the setup as needed. In addition, users can generate a work order to correct, reconfigure, or otherwise maintain any of the configurations by clicking **Generate Activity**.

## Base Package Configuration Reports

The base package includes a number of configuration reports, each based on one of the support configuration classes (see [Understanding Configuration Types](#)).

The table below lists the configuration reports and the business object for each.

Configuration Report	Business Object
Single Asset Configuration Report	W1-SingleAssetCfgRpt
Asset/Component Configuration Report	W1-AssetCompCfgRpt
Asset to Asset Configuration Report	W1-AssetToAssetCfgRpt
Asset/Component to Asset Configuration Report	W1-AssetCompToAssetCfgRpt
Asset to Asset/Component Configuration Report	W1-AssetToAssetCompCfgRpt
Asset/Component to Asset/Component Configuration Report	W1-AssetCompToAssetCompCfgRpt

## Defining Configuration Reports

You use the **Configuration Report** portal to display and maintain configuration reports.

Refer to [Understanding Configuration Reports](#) for more information.

You can access the portal from **Admin > Configuration Report > Configuration Report**. You are brought to a query portal with options for searching. Once your record has been selected you are brought to the maintenance portal to view and maintain the selected record.

The following zones may appear as part of the portal's **Main** tab page:

- **Configuration Report:** This zone provides information about the selected configuration report.

### Where Used

Follow this link to open the data dictionary where you can view the tables that reference [W1\\_CONFIG\\_RPT](#).

## Defining Asset Location Options

### Asset Location Types

## Understanding Asset Location Types

Asset location types define the details of asset or component locations of a certain type. Valid types of asset locations can include service points, other locations for installed assets, or any other location as defined by your organization.

Asset location types are defined by the following:

- **Class:** The general class for asset locations of this type, such as commercial or residential, a shop or warehouse, etc.
- **Location Business Object:** The business object used for asset locations of this type
- **Number of Assets Allowed:** A flag that indicates whether or not asset locations of this type can accommodate a single or multiple assets
- **Service Type:** The type of service (electric, water, etc.) that asset locations of this type support
- **Allow Related Work Locations:** A flag that indicates whether asset locations of this type should be allowed to be connected to a work location
- **Valid Parent Location/Organization Types:** One or more valid parent locations and parent organizations that can be referenced on asset locations of this type. Used primarily for reporting.
- **Valid Communicate-To Location Types:** One or more asset location types to which asset locations of this type can communicate. The **Tree View** tab of any asset or location will display other related assets with a visual indication of their relationship.

---

**NOTE:** In Oracle Utilities Customer To Meter, asset location types are maintained via [Merged Maintenance](#).

---

## Defining Asset Location Types

You use the **Asset Location Type** portal is used to display and maintain asset location types.

Refer to [Understanding Asset Location Types](#) for more information.

You can access the portal from **Admin > Location > Asset Location Type**.

The following zones may appear as part of the portal's **Main** tab page:

- **Asset Location Type List:** This zone lists all asset location type records. Broadcast a record to display the details of the selected record.
- **Asset Location Type:** This zone provides information about the selected asset location type.

---

**NOTE:** In Oracle Utilities Customer To Meter, asset location types are maintained via [Merged Maintenance](#).

---

### Where Used

Follow this link to open the data dictionary where you can view the tables that reference [WI\\_NODE\\_TYPE](#).

## Organization Types

### Understanding Organization Types

Organization types define the main attributes for organizations of a certain type.

Organization types are defined by the following:

- **Class:** The general class organization. Parent organizations have a class of “Parent”.

- **Organization Business Object:** The business object used for organizations of this type
- **Valid Parent Organization Types:** One or more valid parent organizations that can be referenced on organizations of this type. Used primarily for reporting.

## Defining Organization Types

You use the **Organization Type** portal is used to display and maintain organization types.

Refer to [Understanding Organization Types](#) for more information.

You can access the portal from **Admin > Location > Organization Type**.

The following zones may appear as part of the portal's **Main** tab page:

- **Organization Type List:** This zone lists all organization type records. Broadcast a record to display the details of the selected record.
- **Organization Type:** This zone provides information about the selected organization type.

### Where Used

Follow this link to open the data dictionary where you can view the tables that reference [WI\\_NODE\\_TYPE](#).

## Organizations

### Understanding Organizations

Organizations are used for categorization and reporting for locations.

For example, your reporting may include a hierarchy that groups locations by a structure of parent and child organizations.

Organizations are defined by the following:

- **Organization Type:** The organization's type. [Understanding Organization Types](#) for more information.
- **Organization Disposition:** The current status of the organization (Active or Inactive)
- **Parent Organization:** The parent organization, if applicable.
- **Main Contact:** A contact for the organization

### Defining Organizations

You use the **Organization** portal to display and maintain organizations.

Refer to [Understanding Organizations](#) for more information.

You can access the portal from **Admin > Location > Organization**. You are brought to a query portal with options for searching. Once your record has been selected you are brought to the maintenance portal to view and maintain the selected record.

The following zones may appear as part of the portal's **Main** tab page:

- **Organization:** This zone provides information about the organization.
- **Child Locations / Organizations:** This zone lists any child locations and/or organizations for the current organization.

## Where Used

Follow this link to open the data dictionary where you can view the tables that reference [WI\\_NODE](#).

# Out of Service Location Types

## Understanding Out of Service Location Types

Out of service location types define attributes of types of locations where assets that are out of service are stored and maintained. Examples of out of service locations include warehouses, storerooms, and repair shops.

Out of service location types are defined by the following:

- **Class:** The general class (storeroom, meter shop, etc.) of out of service locations of this type
- **Location Business Object:** The business object used for out of service locations of this type
- **Valid Parent Location/Organization Types:** One or more valid parent locations and parent organizations that can be referenced on out of service locations of this type. Used primarily for reporting.

## Defining Out of Service Location Types

You use the **Out of Service Type** portal is used to display and maintain out of service location types.

Refer to [Understanding Out of Service Location Types](#) for more information.

You can access the portal from **Admin > Location > Out of Service Type**.

The following zones may appear as part of the portal's **Main** tab page:

- **Out of Service Location Type List:** This zone lists all out of service location type records. Broadcast a record to display the details of the selected record.
- **Out of Service Location Type:** This zone provides information about the selected out of service location type.

## Where Used

Follow this link to open the data dictionary where you can view the tables that reference [WI\\_NODE\\_TYPE](#).

# Out of Service Locations

## Understanding Out of Service Locations

Out of service locations are physical locations where assets are stored or repaired such as a storeroom, warehouse, or service facility. When assets are changed to statuses such as “In Repair” or “Pending Disposition” the asset location is typically moved to an out of service location.

Out of service locations are defined by the following

- **Location Type:** The out of service location's type. See [Understanding Out of Service Location Types](#) for more information.
- **Location Disposition:** The current status of the out of service location (Active or Inactive)
- **Parent Location/Organization:** The out of service locations' parent location or organization (if applicable)

- **External ID:** An ID used to identify the out of service location in external systems
- **Address Information:** The physical address of the out of service location
- **Contacts:** The primary contact for the out of service location. See [About Contacts](#) and [Maintaining Contacts](#) for more information about creating and maintaining contacts used with out of service locations.
- **Field Information:** Additional information about the physical location, such as GPS coordinates

## Defining Out of Service Locations

You use the **Out of Service Location** portal to display and maintain out of service locations.

Refer to [Understanding Out of Service Locations](#) for more information.

You can access the portal from **Admin > Location > Out of Service Location**. You are brought to a query portal with options for searching. Once your record has been selected you are brought to the maintenance portal to view and maintain the selected record.

The following zones may appear as part of the portal's **Main** tab page:

- **Out of Service Location:** This zone provides information about the out of service location.
- **Current Activities:** This zone provides a summary of the activities that are currently associated to the location.
- **Asset Summary:** This zone provided statistics about the number of assets, by asset type, that are currently associated with the location.
- **Owned Attachments:** This zone lists attachments owned by the location.
- **Referenced Attachments:** This zone lists attachments related to the location.

---

**NOTE:** See [About Contacts](#) and [Maintaining Contacts](#) for more information about creating and maintaining contacts used with out of service locations.

---

### Where Used

Follow this link to open the data dictionary where you can view the tables that reference [W1\\_NODE](#).

## Defining Device Options

### Command Sets

#### Understanding Command Sets

Command sets are used to define a group of commands that are not eligible for a particular device. For instance, if Commission or Decommission commands should be considered ineligible for a particular device model, a command set that references the Device Commission and Device Decommission business objects could be created and associated with that device model.

Command sets are specified for individual device models via the Manufacturer portal.

Individual devices of a particular model can be configured to override ineligibility if needed.

## Configuring Command Sets

This portal is used to display and maintain a Command Set.

Refer to [Understanding Command Sets](#) for more information.

You can access the portal from the **Admin > Device > Command Set**.

The following zones may appear as part of the portal's **Main** tab page:

- **Command Set List:** This zone lists all Command Set records. Broadcast a record to display the details of the selected record.
- **Command Set:** This zone provides information about the selected Command Set.

### Where Used

Follow this link to open the data dictionary where you can view the tables that reference [DI\\_COMMAND\\_SET](#).

## Head End Systems

### Understanding Head End Systems

Head end systems are systems that collect measurement data and meter events for eventual submission to the application. Many devices can communicate to the application through a single head-end system, but a utility may have numerous head-end systems through which they communicate with devices.

Head end systems utilize processing methods that specify the type of initial measurement data and device events to create for devices (and their related measuring components) based on measuring component type. Head end systems also utilize processing methods that specify how smart meter commands are processed.

Refer to [Understanding Process Methods](#) for more information about processing methods.

### Head End Systems Impact Data Import and Export

Head end systems are configured to identify how a particular external system communicates data with Oracle Utilities Meter Data Management. This includes:

- The identifier type used to locate devices and measuring components. These are used both on import and export of data.
- The date/time format used in various data imports (i.e. whether or not the date/time format includes time zone information).

Please refer to the embedded help for more information about these fields.

Each head end system can be associated to an [external system](#) which is used to define the messages that can be sent to that service provider and how each message is sent.

### Understanding Processing Methods

Head end systems, external applications, and market participants can have one or more associated processing methods that define the format or means by which it receives or sends data from or to the application, such as bill determinants, interval data, or meter events. Processing methods are also used to define how to create information internal to the application such as initial measurement data and usage transactions. Processing methods can also be used to define the information an external system wishes to subscribe to receive from our application.



At the lowest level processing methods are used to identify an outbound message type, business object, batch control, or message category and number.

Each processing method is comprised of a business object that defines what is being mapped as well as how it should be mapped.

## Important Processing Method System Events

The actual logic to determine the appropriate output for a given head end system, external application, or market participant and processing role for a processing method is executed by the following system event:

- **Determine Processing Method(s):** is a business object algorithm system event that takes in a head end system, external application, or market participant, a processing role, and a list of relevant input data aka related object (e.g. a measuring component, device, etc). For the head end system or external application and the input data it will analyze the selection criteria to determine the appropriate output.

## How Processing Methods Work

Processing methods perform two basic tasks:

- They define the criteria for selecting the appropriate output. This can be as simple as providing a single object in return without qualification or in more involved situations it could support determining the appropriate return object based on characteristics of the data being processed. This is accomplished through the data structure defined on the processing method business object.
- They evaluate the criteria for selecting the appropriate output given a specific head end system, external application, or market participant. This is accomplished through the Determine Processing Method system event on the processing method business object.

Each processing method business object can be associated to one or more processing roles. This is done by adding the Applicable Processing Role business object option. It is these processing roles that actually create the association between a head end system, external application, or market participant, the processing method, and the functional event that is being executed. For example, when initial measurement data is processed through the IMD Seeder the processing role Initial Measurement Creation is used to identify the processing method "How to Create MC Related Information" which maps a particular measuring component type to the appropriate initial measurement business object to be used for processing.

When system logic requires the results of a processing method the service Determine Service Providers and Methods is used. This service is available to call via Java or from within scripting through the business service of the same name. It can be called in one of two ways:

With a head end system, external application, or market participant: identifies the appropriate output for a single head end system, external application, or market participant being processed for the input processing role and related objects

Without a head end system, external application, or market participant: used to identify subscribing systems. This will provide a list of any head end system, external application, or market participant that has the input processing role and an appropriate output given the related objects.

## Processing Methods Available

There are the following processing methods provided by the base package:

Name	Details	Business Object
How to Create OB COMM/Send OB Message	Identifies Message Number/Category, Business Object, Outbound Message Type and allows for an override by a device type.	D1-HowToCreateActivityOBComm
How to Create MC Related Information	Identifies a business object and allows for an override by measuring component type.	D1-HowToCreateMCInformation
How to Process Device Event Related Info	Identifies a business object, outbound message type, and batch control by device	D1-HowToProcDvcEvtsInformation

	event category allowing for an override by device event type.	
How to Process Device Related Information	Identifies a business object and allows for an override by device type.	D1-HowToProcessDeviceInfo
How to Send Activity Related Information	Identifies a batch control and business object by activity type and allows for an override by device type.	D1-HowToSendActInformation
How to Send Activity Related O/B Messages	Identifies an outbound message type, message category, and message number and allows for override by activity type.	D1-HowToSendActivityResponse
How To Create US Related Information	Identifies a business object and allows for override by usage subscription type.	D2-HowToCreateUSInformation
How To Send US Related Information	Identifies a batch control, business object, and outbound message type and allows for override by usage subscription type.	D2-HowToSendUSInformation
How to Process Service Point Related Info	Identifies a business object and allows for override by service point type.	D1-HowToProcSPRelatedInfo
How to Send Field Activity Related Info	Identifies a outbound message type and allows for an override by field task type.	D1-HowToSendFARelatedInfo
How to Send Field Activity Remark Info	Identifies an outbound message type for an activity remark type.	D1-HowToSendActivityRemarkInfo
How to Translate External Value	Identifies a business object and allows for override by identifier.	D1-HowToTranslateExternalValue
How to Request Customer Notification	Identifies a list of outbound message types.	D1-HowToRequestCustomerNotific
How to Process Business Flag Related Info	Identifies an outbound message type and allows for an override by business flag type.	D1-HowToProcessBusinessFlagInf

## Understanding SGG Adapter Configuration

This section describes how to use a head end system's SGG Adapter Configuration portal.

You can use the SGG Adapter Configuration portal to view configuration information and access configuration components for an SGG adapter head end system.

Note: This portal displays configuration information for head-end systems that reference an SGG Adapter Configuration Sheet extendable lookup..

To use the configuration information portal for an SGG adapter head end system:

Select **Admin > Device > Head End System**.

In the Head End system List zone, click the Broadcast icon for the head-end system you wish to view.

Click the SGG Adapter Configuration tab to view the configuration information.

The SGG Adapter Configuration portal contains the following zones:

- **SGG Adapter Configuration Tracker:** This zone displays the configuration details of the adapter, as defined by the SGG Adapter Configuration Sheet extendable lookup referenced on the head end system. The configuration details include:

The components required for usage and event processing and command processing. To view more details about the components, you can click the component name to go to the business object for the component. For example, you can click

the business object "SSN - Connect or Disconnect" to go to the business object portal for the SSN - Connect or Disconnect business object.

Status messages describing the configuration status of components. The following table lists the status messages that may be displayed and the possible actions you can take:

If the status message is...	You can...
Set up this processing method	Click the processing role to set up the processing method.
This processing method has been configured	Click the processing role to view the configured processing method.
Update your processing method with a communication BO	Click the status message to set up the processing method.
Update your external system / outbound message type with an Message sender	Click the status message to go to the external system.
Update your processing method with an outbound message type	Click the status message to set up the processing method.
Add a value to get started	Click the status message to go to the extendable lookup.
Values Existing: (number)	Click the status message to go to the extendable lookup.
Add a communication type	Click the status message to go to the communication type portal.
Add a device event type	Click the status message to go to the device event type business object for the communication type. This message appears only for Echelon type adapters.
Master Configuration has been added	Click the status message to view the Master Configuration portal.
Add Master Configuration for this adapter	Click the status message to view the Master Configuration portal.

**Upload Statistics Aggregators:** This zone lists the IMD Upload Statistics Aggregator measuring components associated with the head-end system.

## Configuring Head End Systems

This portal is used to display and maintain Head End Systems.

Refer to [Understanding Head-End Systems](#) for more information.

You can access the portal from the **Admin > Device > Head End System**.

The following zones may appear as part of the portal's **Main** tab page:

- **Head End System List:** This zone lists all Head End System records. Broadcast a record to display the details of the selected record.
- **Head End System:** This zone provides information about the selected Head End System.
- **Processing Method List:** This zone provides the list of processing methods defined for the Head End System.
- **Translation Methods List:** This zone provides the list of translation methods defined for the Head End System.
- **Inbound BOs Send By Service Provider:** This zone lists inbound Business Objects that are sent by this Head End System. The identification is driven by the Business Object having a Business Object Option of type "Sent By Service Provider" that references the current Head End System.

### Where Used

Follow this link to open the data dictionary where you can view the tables that reference [D1\\_SPR](#).

## Manufacturers

### Understanding Manufacturers

Manufacturers are the companies that makes devices.

A device's manufacturer is defined as an attribute of the device itself.

Each manufacturer can have zero or more models defined. Models for a single manufacturer can have diverse service types.

- Models can specify an **Exclude Command Set** that references commands that are not eligible for that model. Refer to [Understanding Command Sets](#) for more information.
- The **Device Command Set Override** field indicates if a command set defined by in **Exclude Command Set** field may be can be overridden and specified at the device.

## Configuring Manufacturers

This portal is used to display and maintain a Manufacturers.

Refer to [Understanding Manufacturers](#) for more information.

You can access the portal from the **Admin > Device > Manufacturer**.

The following zones may appear as part of the portal's **Main** tab page:

- **Manufacturer List:** This zone lists all Manufacturer records. Broadcast a record to display the details of the selected record.
- **Manufacturer:** This zone provides information about the selected Manufacturer.

### Where Used

Follow this link to open the data dictionary where you can view the tables that reference [DI\\_MANUFACTURER](#).

## Measuring Component Types

### Understanding Measuring Component Types

Measuring component types define the most important properties of a measuring component.

Measuring component types define what a measuring component measures (KWH, temperature, etc.), how regularly it measures it, and whether it should be connected to a physical device, or if it's used as a scratchpad measuring component or an aggregator measuring component. Measuring component types also specify how the measuring component's final measurements should be stored, how the measuring component's user-defined values should be calculated, and specific rules governing validation, editing, and estimation (VEE) for measuring components of the type. In addition, measuring component types define display properties and valid attribute values for measuring components belonging to the type.

The following configurable items are available for most measuring component types:

- **Value Identifiers:** These store the values of UOM, TOU, and SQI that identify the measured amounts for measuring components of this type. Value identifiers specify the quantities stored on the measurement records for measuring components of this type. Please refer to the Measuring Component Type Value Identifiers topic later in this section for more information.
- **Valid VEE Groups:** These define the VEE groups considered valid for measuring components of this type. Each group supplied here will be available to be selected on measuring components of this type and act as an override to the Fallback VEE Groups.
- **Fallback VEE Groups:** These define default VEE groups for a specific VEE Group Role that can be used with all measuring components of this type. This alleviates the need to specify the same VEE groups on multiple measuring components of the same type. Changes made to these groups will automatically apply to all measuring components of this type unless they have specified their own VEE groups for that particular VEE Group Role. Each VEE group

is designated a VEE group role that indicates when and how the VEE group is used (for initial load, manual override, estimation, etc.).

- **Eligible Profile Factors (interval only):** These define the profile factors that are considered to be eligible for interval measuring components of this type. One profile factor can be identified as the default. The default profile factor will be automatically selected in system processing when a profile factor is required.
- **Valid Profile Factors for Conversion from Scalar to Interval (scalar only):** These define the profile factors that are considered to be eligible for scalar measuring components of this type when converting scalar measurements to interval measurements. These profile factors are used to produce a curve of interval data from a scalar value. Without one of these factors defined scalar to interval conversion will use a flat line method (i.e. evenly divide the scalar value across the intervals). One profile factor can be identified as the default. The default profile factor will be automatically selected in system processing when a conversion profile factor is required.
- **Valid Scratchpad Measuring Component Types:** These define the scratchpad measuring component types considered valid for measuring components of this type.
- **Related Statistics Measuring Component Types:** These define the measuring component types that will be used to store statistical information about the historical usage of measuring components of this type. Please refer to [Configuring Measuring Component Statistics](#) for more information on how this list is used.
- **Display Properties:** Defines how measurement data for measuring components of this type is displayed, including:
  - *Display Configuration:* Details related to how measurements are displayed, including the 360 chart rendering method, number of hours of data to display, the maximum days to search for measurements, the default TOU map used, the TOU by Day Profile factor used, and default measurement condition.
  - *Event Bar Profiles:* The event bar profiles used when displaying measurement data for measuring components of this type. Event bar profiles are defined as values for the 360 View Event Bar Profile extendable lookup.
  - *Final Values Overlay Profiles:* The final values overlay profiles used when displaying measurement data for measuring components of this type. Final values overlay profiles are defined as values for the Final Values Overlay Profile extendable lookup.
  - *Measurement Conditions Not Shown on Chart:* The measurement conditions that should be omitted from rendering onto 360 Degree charts. Measurements whose conditions match these values will be rendered as gaps. For example, many 360 Degree charts use the condition "No Read - System" to represent the lack of a measurement, by adding this condition to this list it a gap will be rendered instead of a line with a 0 quantity measurement and a condition of "No Read - System".

When creating a measuring component type the following options are available:

Name	Details	Business Object
Interval Channel Type - Physical	Provides the configuration for a physical interval channel (e.g. interval size). This is recommended for measuring components that measure consumptive usage.	D1-IntervalChannelTypePhysical
Interval Channel Type - Scratchpad	Provides the configuration for a scratchpad interval measuring component.	D1-IntervalChannelTypeScratchp
Interval Channel Type - Physical Subtractive	Provides the configuration for a physical subtractive interval channel. In addition to standard interval configuration (e.g. interval size) it also provides additional subtractive specific configuration (e.g. rollover validation, estimate reevaluation, etc). This is recommended for measuring components that measure subtractive usage.	D1-IntrvlChanTypPhysSubtractiv
Register Type	Provides the configuration for a physical register that is manually read (e.g. rollover validation). These can be either consumptive or subtractive but are expected to be read infrequently (e.g. once a month).	D1-RegisterTypePhysical
Auto-Read Register Type	Provides the configuration for a physical register that is automatically read. In addition	D1-AutoReadRegisterType

to the standard register configuration (e.g. rollover validation) it also provides details around the schedule of expected readings (e.g. first daily measurement time and expected hours between measurements). These can either be consumptive or subtractive but are expected to be read frequently (e.g. at least once per day).

Note: these measuring component types can also be used to model interval data that is received with a large interval size (e.g. 24 hours).

---

Refer to [Configuring an Out-of-the-box Aggregation](#) for more information about aggregation configuration

## Measuring Component Type Value Identifiers

Measuring components are configured to measure specific types of quantities this is defined by the list of value identifiers on the measuring component type. Up to eleven value identifiers can be specified. The primary measured quantity should be identified using the Value Identifier Type of Measurement. An additional ten derived values can be computed based on the primary measurement, these are identified with the Value Identifier Type of Value 01 through Value 10. Each value identifier is constructed of:

- **Unit of Measure:** The unit of measure for the quantity being recorded. Examples include kilo-watt hours (kWh), kilowatts (kW), therms, cubic feet (CCF), temperature (Fahrenheit or Celsius), etc. Refer to [Understanding Units of Measure](#) for more information.
- **Time of Use:** Modifiers for a given unit of measure that indicate a period of time during which a quantity has been used, such as On-Peak (meaning during a time when the greatest quantity of some consumable is being used), Off-Peak (meaning during a time when the least amount of some consumable is being used), etc. Refer to [Understanding Time of Use](#) for more information.
- **Service Quantity Identifiers:** Used to further distinguish between measured quantities that have identical UOM/TOU combinations, including situations in which the distinguishing identifier of a UOM is not accurately described as a TOU. Generally, SQI is only used when multiple measuring components measure the same thing, but in different ways. A meter that measures both generation KWH and consumption KWH could use SQIs to differentiate between the two. Refer to [Understanding Service Quantity Identifiers](#) for more information.
- **Value Derivation Algorithm:** Unlike UOM, TOU, and SQI this is not used in the identification of what is measured but rather is used to calculate a derived value based on the primary measurement. An algorithm from the list should be selected that contains the appropriate logic for calculating the derived value. This is applicable for those value identifiers with a Value Identifier Type of Value 01 through Value 10. More information on how derived values are calculated can be found in the Important Measuring Component Type System Events topic in this chapter. For more functional information about derived values please refer to [About Final Measurements](#).

The combination of UOM, TOU and SQI define what a measuring component measures. TOU and SQI are optional, but UOM must be defined for all value identifiers. For example, consider a meter (as illustrated in the image below) with two measuring components, both measuring the same unit of measure (kWh), but each measuring component measures consumption in different time of use (TOU) periods (peak and off-peak).

**42293921**



**kWh Peak Hours**



**kWh Off-peak Hours**

General Electric  
Model: 12-A

Another example might be a meter that records both generated KWH and consumed KWH. This meter would be configured to measure both UOM and SQL.

**42293921**



**kWh Generated**



**kWh Consumed**

General Electric  
Model: 12-A



A measurement is recorded each time a measuring component is read. This means that for a meter with two measuring components that is read once a month, two measurements, one for each measuring component, would be recorded each month.

## Important Measuring Component Type System Events

The measuring component type supports several business object algorithm system events that relate to calculating the consumption for measuring components of that type:

- **Calculate Interval Consumption:** receives the interval list and performs any necessary calculations on that interval data to compute consumption. Since interval data is already received as consumption data algorithms for this system event are typically limited to application of the appropriate multipliers. Refer to the algorithm type Calculate Interval Consumption ([D1-IN-CNSUMP](#)) as an example.
- **Calculate Scalar Consumption:** receives information about the scalar reading and calculates the consumption as appropriate. Algorithms for this event typically support calculating the consumption using a stop and start reading or backing into a reading using consumption and a start reading. Much like the interval counterpart it will apply the appropriate multipliers. Refer to algorithm type Calculate Scalar Consumption ([D1-SC-CNSUMP](#)) as an example.
- **Calculate Subtractive Interval Consumption:** receives the interval list and supporting information (e.g. the start reading for the first interval) and either calculates the consumption by subtracting the interval's reading from the prior interval's reading or calculates the reading by adding the current interval's consumption to the prior interval's reading. Refer to algorithm type Calculate Subtractive Interval Consumption ([D1-SIN-CNSUM](#)) as an example.
- **Condition Mapping:** receives the details of a single subtractive interval along with the details for its start reading and computes the applicable final condition and reading condition. This is leveraged solely for subtractive interval measuring component types. Refer to algorithm type Subtractive Interval - Condition Mapping ([D1-SIN-CNMAP](#)) as an example.

These system events are typically called from within initial measurement processing during the initial stages of the initial measurement lifecycle (e.g. the Pre VEE status of most initial measurement business objects).

In addition to the measuring component type business object algorithms there is an additional system event provided on measuring component type itself:

- **Value Derivation:** receives details of an initial measurement and an associated final measurement. Using these inputs it can compute a value derived either from the primary measurement or one of the other derived values. Refer to algorithm type Derive a quantity using a formula ([D1-DERIVAQTY](#)) as an example.

## Important Measuring Component System Events

The measuring component business object that is associated to a given measuring component type supports a special system event that is used in the periodic estimation process:

- **Periodic Estimation:** this system event will scan the measuring component's final measurement history to identify missing measurements and create either a To Do, or an estimation initial measurement, or both. More detail about this system event can be found by visiting the following algorithm types: Refer to algorithm type Create Interval IMD and To Do Based Upon Install History ([D1-CIITBIH](#)) and Auto-Read Scalar Periodic Estimation ([D1-ARSPE](#)) as an example.

## Measuring Component Business Object Options Drive Functionality

The device business object that is associated to a given device type plays an important role in how a device is processed in a system beyond defining the data associated to that device. Below are a list of business object options that are defined on the device business object and their impact on system processing:

- **Estimation Initial Measurement Data BO:** Is used to identify the appropriate estimation IMD to create.
- **Manual Override IMD BO:** Is used to identify the appropriate manual override IMD to create.
- **System IMD BO:** Is used to identify the appropriate system IMD to create.
- **Measuring Component Consumption Function:** identifies a function that can be executed from any compatible measuring component 360 Degree zone. Each measuring component can support 0 to many of these functions.



- **Interval Initial Measurement Function:** identifies a function that can be executed from any compatible initial measurement zone. Each measuring component can support 0 to many of these functions.

More detail about these options can be found by visiting a measuring component business object and inspecting the business object options.

## Configuring Measuring Component Types

This portal is used to display and maintain a Measuring Component.

Refer to [Understanding Measuring Component Types](#) for more information.

You can access the portal from the **Admin > Device > Measuring Component > Search**.

The following zones may appear as part of the portal's **Main** tab page:

- **Measuring Component Type:** This zone provides information about the selected Measuring Component Type.

### Where Used

Follow this link to open the data dictionary where you can view the tables that reference [DI\\_MEASR\\_COMP\\_TYPE](#).

## Measuring Component Comparison Types

### Understanding Measuring Component Comparison Types

Measuring component comparison types define the details by which measuring component data can be compared to determine the days that most closely resemble a specific day being evaluated. For example, measuring component comparison types can be used on measuring components that store weather data so that comparisons can be made based on temperature. These are used when performing “proxy day” estimations, allowing the application to search for days that are similar to historical data (for instance, the same date from the previous month or previous year ) to use as the basis for estimation.

Measuring component comparison types use the following parameters:

- A specific metric to be calculated to enable data comparisons. The “Calculate Comparison Coefficient - Pearson Correlation Coefficient” algorithm, included with the base package can be used to calculate a coefficient based on the linear correlation between two data sets (specifically between weather data stored on a measuring component and on the comparison object).
- The specific object to be compared. This can be either the same measuring component (to compare against historical data for the same measuring component), or a factor profile (to compare against profile data)
- The date range for the comparison period, including the start of the comparison period (current date, same date last year, or both), the time each day through which the comparison will be calculated, and the number of days prior to and after the start date that will be compared with the comparison object.
- Average Difference Eligibility: An average value either above or below the average for the current date that will be eligible for comparison. For example, assume the current date’s average is 75, and the prior day’s average is 72. If the Average Difference Eligibility is set to 3 then the prior day value of 72 will be eligible for comparison to the current day average of 75.
- The maximum number of resulting calculations that should be stored as measuring component comparable periods.
- A template that defines which days are considered like each day of the week (for example, weekdays are like other weekdays, weekend days are like other weekend days). This template is defined as a record for the “Like Day Eligibility Template” extendable lookup.

- Work calendars used to determine if specific data should be compared to other weekend days or to the same date in prior years, and which dates, if any, should be excluded from historical data used for comparison.

## Configuring Measuring Component Comparison Types

Refer to [Understanding Measuring Component Comparison Types](#) for more information.

You can access the portal from **Admin > Device > Measuring Component Comparison Type**.

The following zones may appear as part of the portal's **Main** tab page:

- **Measuring Component Comparison Type List:** This zone lists all measuring component comparison type records. Broadcast a record to display the details of the selected record.
- **Measuring Component Comparison Type:** This zone displays details for the selected measuring component comparison type.

### Where Used

Follow this link to open the data dictionary where you can view the tables that reference [DI\\_MC\\_COMPAR\\_TYPE](#).

## Device Configuration Types

### Understanding Device Configuration Types

Device Configuration types define the measurements a given device can record. It should be noted that the device configuration type itself does not specify this information but rather the device configuration type will identify the valid list of measuring component types that can be referenced associated to a device.

When creating a new device configuration type there are the following options:

Name	Details	Business Object
Device Configuration Type	This represents configurations for physical meters and communication components. It identifies a list of valid measuring components types.	D1-DeviceConfigurationType
Item Configuration Type	This represents badged items that are installed at a particular service point. Given the nature of items there are no measuring component types associated to this type.	D1-ItemConfigurationType

Refer to [Configuring Consumption Synchronization](#) for more information on how a device configuration type can be set up to synchronize consumption between two related channels of measurement data.

### Configuring Device Types

This portal is used to display and maintain a Device Type.

Refer to [Understanding Device Types](#) for more information.

You can access the portal from the **Admin > Device > Device Type**.

The following zones may appear as part of the portal's **Main** tab page:

- **Device Type List:** This zone lists all Device Type records. Broadcast a record to display the details of the selected record.
- **Device Type:** This zone provides information about the selected Device Type.

- **Device Type Service Quantity:** This zone displays the list of effective dated service quantities supported by the selected Device Type. This applies only to Items.

## Where Used

Follow this link to open the data dictionary where you can view the tables that reference [DI\\_DVC\\_TYPE](#).

## Device Types

### Understanding Device Types

Device types define information about a class of devices, including properties that apply to all devices of a type. Properties defined for a device type can be overridden for an individual device

Specifically, device types provide information about:

- How a device can be configured by defining the valid list of device configuration types
- How a device communicates by defining a fallback head end system and a list of valid head end systems.
- How a device records measurement data through the fallback incoming data shift which plays an important role in daylight savings processing. Refer to [Daylight Savings Time Support](#) for more information.
- The consumption profile of an item: the unit of measure consumed and method of calculation (profile or straight line)

When creating a new device type there are the following options:

Name	Details	Business Object
Smart Meter Device Type	These devices measure consumption for a given service point, support remote commands, and remote collection of measurement and event data. These devices are associated to a head end system.	D1-SmartMeterType
Manual Meter Device Type	These devices measure consumption for a given service point but require a visit to the service point to collect the measurement data. They are not associated to head end systems.	D1-ManualMeterType
Item Device Type	These devices represent various items that consume consumption at a constant rate which are not directly metered. As consumption is calculated rather than measured so there is no need for an association to a head end system. Devices of this type can either be created individually for "badged" items or can be listed directly on a service point for "unbadged items."	D1-ItemType
Communications Component Device Type	These devices provide remote collection of consumption data measured by a manual meter to which they are attached. These devices are associated to a head end system.	D1-CommunicationCompMeterType

### Device Business Object Options Drive Functionality

The device business object that is associated to a given device type plays an important role in how a device is processed in a system beyond defining the data associated to that device. Below are a list of business object options that are defined on the device business object and their impact on system processing:

- **Device Category:** This defines the type of device and correlates to the core device types that are supported (i.e. smart meter, AMR meter, manual meter, item, or communication component). This value is used by smart meter commands, service order management, and other system processes to make processing decisions.

- **Install Event BO:** This identifies the appropriate install event business object to use when this device is being installed at a service point. Refer to [About Install Events](#) for more information about install events.
- **Valid Command Request BO:** This identifies the commands that are valid for any device of this type. This option can be repeated for as many commands as the device supports. Note: the combination of the device and service provider (aka head end) define the true list of available commands by device.
- More detail about these options can be found by visiting a device business object and inspecting the business object options.

## Device Type - Service Quantity

For "badged" and "unbadged" items consumption is not directly measured. Instead, for each item type, the average daily consumption amount is provided. The commodity represented by the daily consumption amount is defined by the item type's unit of measure.

The average daily consumption amount can be effective dated over time to support changes in the consumption profile. This is used in conjunction with the item's calculation method to derive the consumed amount per interval.

Refer to [Multiple Time Zone Support](#) for additional information on how device type service quantities are impacted by multiple time zones.

## Configuring Device Types

This portal is used to display and maintain a Device Type.

Refer to [Understanding Device Types](#) for more information.

You can access the portal from the **Admin > Device > Device Type**.

The following zones may appear as part of the portal's **Main** tab page:

- **Device Type List:** This zone lists all Device Type records. Broadcast a record to display the details of the selected record.
- **Device Type:** This zone provides information about the selected Device Type.
- **Device Type Service Quantity:** This zone displays the list of effective dated service quantities supported by the selected Device Type. This applies only to Items.

## Where Used

Follow this link to open the data dictionary where you can view the tables that reference [DI\\_DVC\\_TYPE](#).

## Defining Device Installation Options

### Service Point Types

### Understanding Service Point Types

Service point types define a specific type of point at which service is delivered.

Specifically, service point types define how the application manages many aspects of the service point's behavior. A service point type may have one or more valid device types defined that limit the types of devices that can be installed at service

points of this type. A service point type may also have one or more service agreement types (SA Types) that define the types of service agreements that may be linked to service points of this type.

The "Service Point Category" field defines the types of devices that can be installed at service points of this type. Valid values include:

- **Meter:** Indicates that a single meter can be installed at service points of this type.
- **Item:** Indicates that a single "badged" item can be installed at service points of this type.
- **Multi-Item:** Indicates that one or more "unbadged" items can be installed at service points of this type.

---

**NOTE:** In Oracle Utilities Customer To Meter, Service Point Types are maintained via [Merged Maintenance](#).

---

## Configuring Service Point Types

This portal is used to display and maintain a Service Point Type.

Refer to [Understanding Service Point Types](#) for more information.

You can access the portal from **Admin > Geographic > Service Point Type**.

The following zones may appear as part of the portal's **Main** tab page:

- **Service Point Type List:** This zone lists all Service Point Type records. Broadcast a record to display the details of the selected record.
- **Service Point Type:** This zone provides information about the selected Service Point Type.

---

**NOTE:** In Oracle Utilities Customer To Meter, Service Point Types are maintained via [Merged Maintenance](#).

---

## Where Used

Follow this link to open the data dictionary where you can view the tables that reference [DI\\_SP\\_TYPE](#).

## Service Point Quantity Types

### Understanding Service Point Quantity Types

Service point quantity types define types of quantities that can be stored for a service point. These quantity types are often infrequently calculated descriptors of a given customer and how they relate, at an aggregate level, to either the customer base as a whole or their particular rate class. For example, a customer quantity may be used to store a scaling factor that describes how a given customer's usage compares to the profiled usage for their rate class.

In a settlement implementation, service point quantity types can be used to define values calculated monthly, annually, etc., such as annual peak load contribution (PLC).

Service quantity types use the following parameters:

- The service type (electric, gas, water, etc.) for service point quantities of this type
- Quantity identifiers related to the current service point quantity type (used to provide shorthand descriptions of the various types of values measured by service point quantities of this type)

### Configuring Service Point Quantity Types

Refer to [Understanding Service Point Quantity Types](#) for more information.

You can access the portal from **Admin > Device Installation > Service Point Quantity Type**.

The following zones may appear as part of the portal's **Main** tab page:

- **Service Point Quantity Type List:** This zone lists all service point quantity type records. Broadcast a record to display the details of the selected record.
- **Service Point Quantity Type:** This zone displays details for the selected service point quantity type.

## Where Used

Follow this link to open the data dictionary where you can view the tables that reference [DI\\_SP\\_QTY\\_TYPE](#).

# Measurement Cycles

## Understanding Measurement Cycles

Measurement cycles define the schedule for manual meter reading of devices at Service Points in that cycle. Measurement cycles can have one or more associated routes used to collect measurements.

Measurement cycles can also be configured to define when to [create usage transactions](#) for Usage Subscriptions associated to Service Points in the cycle.

For a deeper functional understanding, refer to the [About Route Management](#) section of the *Oracle Utilities Meter Solution Business User Guide*.

## Configuring Measurement Cycles

This portal is used to display and maintain a Measurement Cycle.

Refer to [Understanding Measurement Cycles](#) for more information.

You can access the portal from the **Admin > Device Installation > Measurement Cycle**. You are brought to a query portal with options for searching. Once your record has been selected you are brought to the maintenance portal to view and maintain the selected record.

The following zones may appear as part of the portal's **Main** tab page:

- **Measurement Cycle List:** This zone lists all Measurement Cycle records. Broadcast a record to display the details of the selected record.
- **Measurement Cycle Type:** This zone provides information about the selected Measurement Cycle.
- **Measurement Cycle Route List:** This zone lists the measurement cycle routes related to the measurement cycle.
- **Measurement Cycle Schedule List:** This zone lists the measurement cycle schedules related to the current measurement cycle.

## Where Used

Follow this link to open the data dictionary where you can view the tables that reference [DI\\_MSRMT\\_CYC](#).

# Measurement Cycle and Bill Determinants

The system can be configured to periodically push bill determinants to subscribing systems. In this case, measurement cycles can be configured to define when to create usage transactions for Usage Subscriptions associated to Service Points in the cycle. Even Service Points whose meters are read automatically may reference measurement cycles.

Creating bill determinants (by creating a usage transaction) is performed by an algorithm on the "Complete" state of the SP/ Measurement Cycle Schedule Route business object (similar to creating activities as described above).

When the Pending SP/Measurement Cycle Schedule Route records are processed by the D1-PSPSR batch, rather than create a handheld download activity, the algorithm can create a usage transaction (usage transactions are transactions that cause bill determinants to be calculated for the Service Point's Usage Subscription).

If the implementation needs to both manually read the meter and push bill determinants, both algorithms would be plugged in on the SP/Measurement Cycle Schedule Route business object.

Measurement cycle processing is managed by the following three batch processes:

- **Create Pending Measurement Cycle Schedule Routes (D1-CMCS):** This batch process creates Schedule Routes for Measurement Cycle Schedules whose schedule selection date is on or before the batch business date. This process is used if routes have the same schedule each month, quarter, etc. This process simply copies the routes from the Measurement Cycle to the Measurement Cycle Schedule on/after the scheduled selection date.
- **Create Pending SP / Measurement Cycle Schedule Route Records (D1-CSPSR):** This batch process creates a "SP/ Measurement Cycle Schedule Route" transaction for every Service Point in the Measurement Cycle Schedule Route that is ready for processing.
- **Process Pending SP / Measurement Cycle Schedule Route Records (D1-PSPSR):** This batch process transitions the Pending "SP/Measurement Cycle Schedule Route" transactions to their Complete state. Custom algorithms can be configured to do any additional necessary work, such as creating a "Meter Read Download" activity. This custom algorithm would be configured as an Enter algorithm on the "Complete" state of the SP/ Measurement Cycle Schedule Route business object.

For a deeper functional understanding, refer to the [About Route Management](#) section of the *Oracle Utilities Meter Solution Business User Guide*.

## Measurement Cycle Schedules

### Understanding Measurement Cycle Schedules

Measurement cycle schedules define the dates on which devices are scheduled to be read for a given measurement cycle and the routes used to collect measurements for the measurement cycle.

For a deeper functional understanding, refer to the [About Route Management](#) section of the *Oracle Utilities Meter Solution Business User Guide*.

### Configuring Measurement Cycle Schedules

This portal is used to display and maintain a Measurement Cycle Schedule.

Refer to [Understanding Measurement Cycle Schedules](#) and [Understanding Measurement Cycles](#) for more information.

You can access the portal from the **Admin > Device Installation > Measurement Cycle Schedule**. You are brought to a query portal with options for searching. Once your record has been selected you are brought to the maintenance portal to view and maintain the selected record.

The following zones may appear as part of the portal's **Main** tab page:

- **Measurement Cycle Schedule Query:** This zone allows you to query for Measurement Cycle Schedules based on Measurement Cycle and select the desired record.
- **Measurement Cycle Schedule:** This zone provides information about the selected Measurement Cycle Schedule.

## Where Used

Follow this link to open the data dictionary where you can view the tables that reference [DI\\_MSRMT\\_CYC\\_SCHED](#).

## Setting Up Metered Premise Options

This section describes tables that must be set up before you can define premises.

## Setting Up Meter Read Instructions

When you set up a premise you may define instructions to be supplied to the individuals who read the meters located at the premise. To define meter read instruction codes, open **Admin > Geographic > Meter Read Instruction**.

### Description of Page

Enter a unique **Meter Read InstructionCode** and **Description** for every meter read instruction.

### Where Used

Follow this link to open the data dictionary where you can view the tables that reference [CI\\_MR\\_INSTR](#).

## Setting Up Meter Read Warnings

When you set up a premise you may define warnings to be supplied to the individuals who read the meters located at the premise. To define meter read warning codes, open **Admin > Geographic > Meter Read Warning**.

### Description of Page

Enter a unique **Meter Read Warning** and a **Description** for every meter read warning.

### Where Used

Follow this link to open the data dictionary where you can view the tables that reference [CI\\_MR\\_WARN](#).

## Setting Up Consumption Estimation Parameters

The system estimates consumption under the following situations:

- At billing time, when "real" consumption cannot be computed due to the lack of a meter read, the system estimates how much the customer used assuming the following conditions are true:
  - The service agreement allows estimation.
  - The rate schedule allows estimation.
  - The bill cycle schedule (if one is being used) allows estimation.
  - The register is not a peak register (this is an artificial constraint, but most organizations do not estimate peak consumption). Note that the base product estimation algorithms may attempt to estimate peak registers.
  - The register is subtractive. This is because only subtractive registers are self-correcting. For example, assume we estimate a reading of 100 and the next real read is 102, the customer will only be charged for 2 units. But consider what would happen if we estimated a consumptive register, the consumption associated with the next real read will be billed in its entirety.



- When a meter read is added, the system verifies that the resultant consumption is congruous with historical consumption trends (i.e., high / low checks are performed).

This section describes the tables that must be set up to estimate consumption.

## Defining Device Measurement Options

### Units of Measure

#### Understanding Units of Measure

Units of Measure (UOM) identify quantities measured and recorded, such as KWH, KW, cubic feet, degrees Celsius, etc. UOMs are based on a specific service type.

---

**NOTE:** In Oracle Utilities Customer To Meter, Units of Measure are maintained via [Merged Maintenance](#).

---

#### Important Unit of Measure System Events

Unit of Measure supports the following business object algorithm system events:

- **Axis Conversion:** this event receives a list of measurements along with a source UOM and interval size and a target UOM and interval size. It should then perform the necessary actions to convert the source UOM and interval size into the target UOM and interval size. Refer to the algorithm Axis Conversion algorithm ([DI-AXIS-CONV](#)) as an example.

#### Configuring Units of Measure

This portal is used to display and maintain a Unit of Measure.

Refer to [Understanding Units of Measure](#) for more information.

You can access the portal from the **Admin > Rates > Units of Measure**.

The following zones may appear as part of the portal's **Main** tab page...

- **Unit of Measure List:** This zone lists all units of measure. Broadcast a record to display the details of the selected record.
- **Unit of Measure:** This zone provides information about the selected unit of measure.

---

**NOTE:** In Oracle Utilities Customer To Meter, Units of Measure are maintained via [Merged Maintenance](#).

---

#### Where Used

Follow this link to open the Application Viewer data dictionary where you can view the tables that reference [D1\\_UOM](#) and [UOM](#).

### Service Quantity Identifiers

## Understanding Service Quantity Identifiers

Service Quantity Identifiers (SQI) are used to further distinguish between measured quantities that have identical UOM/TOU combinations, including situations in which the distinguishing identifier of a UOM is not accurately described as a TOU. Some examples include: Generated, Consumed, etc.

SQIs can also be used as a stand-alone representation of a service quantity that is not measured (one that is not properly described as a UOM) within a usage service quantity collection (such as a billing determinant).

---

**NOTE:** In Oracle Utilities Customer To Meter, Service Quantity Identifiers are maintained via [Merged Maintenance](#).

---

## Configuring Service Quantity Identifiers

This portal is used to display and maintain a Service Quantity Identifier.

Refer to [Understanding Service Quantity Identifiers](#) for more information.

You can access the portal from **Admin > Rates > Service Quantity Identifier**.

The following zones may appear as part of the portal's **Main** tab page:

- **Service Quantity Identifier List:** This zone lists all Service Quantity Identifiers. Broadcast a record to display the details of the selected record.
- **Service Quantity Identifier:** This zone provides information about the selected Service Quantity Identifier.

---

**NOTE:** In Oracle Utilities Customer To Meter, Service Quantity Identifiers are maintained via [Merged Maintenance](#).

---

### Where Used

Follow this link to open the data dictionary where you can view the tables that reference [DI\\_SQI](#) and [SQI](#).

## Time of Use

### Understanding Time of Use

Time of Use (TOU) periods are modifiers for a given unit of measure that indicate a period of time during which a quantity has been used, such as On-Peak (meaning during a time when the greatest quantity of some consumable is being used), Off-Peak (meaning during a time when the least amount of some consumable is being used), etc.

---

**NOTE:** In Oracle Utilities Customer To Meter, Time of Use periods are maintained via [Merged Maintenance](#).

---

### Configuring Time of Use

This portal is used to display and maintain a Time of Use.

Refer to [Understanding Time of Use](#) for more information.

You can access the portal from **Admin > Rates > Time of Use**.

The following zones may appear as part of the portal's **Main** tab page:

- **Time Of Use List:** This zone lists all Time Of Use records. Broadcast a record to display the details of the selected record.

- **Time Of Use:** This zone provides information about the selected Time Of Use.

---

**NOTE:** In Oracle Utilities Customer To Meter, Time of Use periods are maintained via [Merged Maintenance](#).

---

## Where Used

Follow this link to open the data dictionary where you can view the tables that reference [D1\\_TOU](#) and [TOU](#).

## Service Types

### Understanding Service Types

Service Types define specific types of service for which usage can be recorded and captured, such as electric, gas, steam, etc.

---

**NOTE:** In Oracle Utilities Customer To Meter, Service Types are maintained via [Merged Maintenance](#).

---

### Configuring Service Types

This portal is used to display and maintain a Service Type.

Refer to [Understanding Service Types](#) for more information.

You can access the portal from **Admin > General > Service Type**.

The following zones may appear as part of the portal's **Main** tab page:

- **Service Type List:** This zone lists all Service Type records. Broadcast a record to display the details of the selected record.
- **Service Type:** This zone provides information about the selected Service Type.

---

**NOTE:** In Oracle Utilities Customer To Meter, Service Types are maintained via [Merged Maintenance](#).

---

## Where Used

Follow this link to open the data dictionary where you can view the tables that reference [D1\\_SVC\\_TYPE](#) and [SERVICE TYPE](#).

## Factors

### Understanding Factors

Factor are a centrally stored set of values for use in validation rules, bill determinants calculations, and other processes.

A factor can have different values depending upon some definable attribute of a system object, such as customer size associated with a service point. Examples of factors can include minimum and maximum thresholds, loss factors, etc. Classes of factors are defined that can have numeric values (as in the above examples), or values pointing to profile measuring components, or VEE groups.

A factor's values are effective-dated values - either a number, a profile measuring component, a temperature profile measuring component, a VEE group, or some custom-defined value - assigned to a factor and associated to the value of

some attribute of a system object. For example, consider a service point that can be classified as residential, commercial, or industrial. The tolerance percentage by which a customer's consumption can exceed last month's consumption can be based on the service point category.

For this example, factor values for a single factor called "tolerance percentage" could be:

- Residential - 20%
- Commercial - 10%
- Industrial - 5%.

## Configuring Factors

This portal is used to display and maintain Factors and Factor Values.

Refer to [Understanding Factors](#) for more information.

**Prerequisites:** You must define factor characteristic source algorithms, factor characteristic types, and factor characteristic values before you can create a factor. Refer to the Oracle Utilities Application Framework online help for more information about algorithms, characteristic types, and characteristic values.

You can access the portal from the **Admin > General > Factor > Search**.

The following zones may appear as part of the portal's **Main** tab page:

- **Factor List:** This zone lists all factor records. Broadcast a record to display the details of the selected record.
- **Factor:** This zone provides information about the selected factor.
- **Factor Char Value and Factor Value List:** This zone lists the characteristic values associated to the factor characteristic. For each characteristic value it will display the related factor values. From this zone you can click the **Factor Value** link to see the factor value in more detail on the **Factor Value** portal.

## Where Used

Follow this link to open the data dictionary where you can view the tables that reference [DI\\_FACTOR](#).

## Processing Timetable Types

### Understanding Processing Timetable Types

Processing timetable types define types of schedules that can be referenced by different processes and objects in Oracle Utilities applications such as Oracle Utilities Meter Data Management and Oracle Utilities Market Settlements Management. For example, if a process requires requesting data from an external system on a daily basis, a daily processing timetable type could be used to define the details of this schedule.

Processing timetable types are used by standalone data request measuring components to control the schedule by which requests for data are processed (for example, in a settlement process in which zonal load is requested on a daily basis).

The base package includes two processing timetable type business objects used with specific scheduling patterns:

- **Daily Processing Timetable:** Used for daily schedules
- **Defined Dates Processing Schedule:** Used for schedules that should execute on specific dates.

Parameters used to define processing timetable types include:

- **Scheduling Information:** Details about how the schedule is executed, including period cut-off time, earliest execution time, lead/lag time, and a work calendar (used to control the days on which the process can be executed)

- **Workflow Information:** Details about how the processing timetable aligns with process workflows, including warning time and target due time
- **Processing Dates:** A list of specific dates on which the process should be executed (used with Defined Dates Processing Schedule only)

## Configuring Processing Timetable Types

Refer to [Understanding Processing Timetable Types](#) for more information.

You can access the portal from **Admin > General > Processing Timetable Type**.

The following zones may appear as part of the portal's **Main** tab page:

- **Processing Timetable Type List:** This zone lists all processing timetable type records. Broadcast a record to display the details of the selected record.
- **Processing Timetable Type:** This zone displays details for the selected processing timetable type.

### Where Used

Follow this link to open the data dictionary where you can view the tables that reference [D1\\_PROC\\_TIMETABLE\\_TYPE](#).

## Initial Measurement Data

### Configuring the Initial Measurement Algorithms

The behavior of initial measurement data processing can be adjusted by updating parameters in several key algorithms in the lifecycle.

---

**NOTE:** This is not a list of all algorithms and algorithm parameters that can be customized in the initial measurement processing lifecycle. Rather, it is a selection of some of the more impactful parameters.

---

#### Initial Measurement Data Seeder Algorithms

- Derive Service Provider and Measuring Component ([D1-DER-SPRMC](#)):
  - Enabling a standalone measuring component search allows initial measurement data to be processed without a device identifier. This is useful when profile or temperature data is loaded through the IMD Seeder and a match must be made on measuring component identifiers alone.
  - If measuring component identifiers can be repeated across measuring components for the same device then the error for duplicate measuring components being found can be turned off. This is useful for certain head end systems that will have multiple channels with the same channel identifier. When a duplicate is found the search will fall back on other means for identifier the correct measuring component.
- Perform Date/Time Adjustments and Undercount/Overcount Check ([D1-DODTTMADJ](#)):
  - Undercount validation can be turned off completely or left enabled. When left enabled the automatic filling of gaps can be turned off separately.
  - The overcount check can be turned off.
  - The automatic adjustment of the individual interval date/times to an interval boundary can be turned on.

---

**NOTE:**

If your implementation receives initial measurement data with date/times that do not include an explicit time zone and the devices report date/times in standard time, you may need to add the following configuration:

- Navigate to **Admin > Integration > Message Option**
- In the **XAI compliance** option, ensure that the following text is provided:  
`xsd:strict:dstGapInStandardTime`

This will prevent a date/time reported in standard time that falls on the missing hour of the day Daylight Savings Time is entered from being misinterpreted.

---

## Specific Initial Measurement Data Algorithms

- Normalize measurements (overwrite identical existing Measurements) ([D1-NORM-IMD](#)):
  - When the initial measurement data includes measurements that match exactly with the existing final measurements they can either be overwritten or skipped.
  - If logging of changes to final measurements is desired then it must be indicated as such in this algorithm. It is suggested to keep this turned off for high volume initial measurement data such as initial load. See [Configuring Measurement Logging](#) for more details.

**NOTE:** Refer to [Configuring Consumption Synchronization](#) for additional parameters that can be adjusted on specific initial measurement data algorithms.

---

## Configuring Measurement Logging

There are two components to logging changes to final measurements:

- **Initial Measurement Finalization:** the "normalization" algorithm on a particular initial measurement data business object will determine how final measurements are updated. For performance reasons certain types of initial measurement data (e.g. initial load) are delivered with a final measurement update method that will skip any logging. This can be controlled by parameters on the algorithm that implements the algorithm type Normalize Measurements for Initial Measurement Data ([D1-NORM-IMD](#)). Specifically the "Create Measurement Log on Update (Y/N)" parameter should be set to "Y". As mentioned creating these logs has a performance impact and it is not recommended for use on initial load.
- **Measurement Business Object:** there must be an algorithm for the audit system event configured. The base package delivers the algorithm type Add Measurement Log Record ([D1-AMSRMTLOG](#)). It is this algorithm that actually records the log entries.

## Logging User Updates to Manual Initial Measurements

By default, manual edits made by users of these zones are not logged on the Log tab. Logging of manual edits to manual initial measurements can be enabled by adding a logging algorithm on an appropriate lifecycle state of the manual initial measurement business objects. The Log User Transaction ([D1-LOGUSRTRN](#)) base package algorithm can be used for this. This Enter algorithm is designed to be defined on the Initial state of the manual initial measurement business objects, but it can also be defined on any (non-transitory) Interim or Final state as well.

To ensure logging of any or all manual edits made to manual initial measurements, this algorithm should be specified on any state in which users will make manual edits. This will most often be the Pending or VEE Ready states, but could also include the Error, Exception, or Finalized states.

**CAUTION:** When defining this algorithm, the user should exercise caution and determine if previous algorithms in the sequence within the state contain any form of transitioning logic that may inadvertently cause this algorithm to be bypassed.

---

## Defining VEE Options

# Exception Types

## Understanding Exception Types

Exception Types define the groupings of exceptions for an IMD based on their functional similarity. This provides a way to define VEE Exceptions in a distinct enough way to understand the root issue that was generated from the VEE Rule.

For a deeper functional understanding of VEE, refer to the [About VEE](#) section of the *Oracle Utilities Meter Solution Business User Guide*.

## Configuring Exception Types

This portal is used to display and maintain an Exception Type.

Refer to [Understanding Exception Types](#) for more information.

You can access the portal from **Admin > VEE > Exception Type > Search**.

The following zones may appear as part of the portal's **Main** tab page:

- **Exception Type List:** displays all of the Exception Types so you can choose the one you want to display in more detail
- **Exception Type:** shows the specific configuration for the selected Exception Type

There are two different options to use when creating an Exception Type:

Name	Details	Business Object
VEE Exception	This will create a "normal" VEE Exception that is attached to an IMD for tracking of conditions triggered in the VEE process.	D1-VEEException
VEE Exception - Monitor Service Point	In addition to tracking the failure in the VEE process, this VEE Exception generates a <a href="#">Service Issue Monitor</a> . This allows for cumulative tracking of VEE Exceptions that can be configured to result in a Service Investigative Order (field work) for the Service Point.	D2-VEEExceptionServiceMonitor

## Where Used

Follow this link to open the data dictionary where you can view the tables that reference [D1\\_EXCP\\_TYPE](#).

## VEE Groups

### Understanding VEE Groups

VEE groups are collections of VEE Rules that are applied to initial measurement data. During the VEE process, the system executes the VEE Rules defined in each VEE group. The rules within a VEE group are defined in a specific sequence, allowing control over the order in which the rules are executed.

VEE groups can be associated to a specific measuring component, or to a measuring component type (or both). VEE groups associated with a measuring component type are applied to all measuring components of that type, while those associated to a specific measuring component are applied only to that measuring component. VEE groups associated to a measuring component override those assigned to a measuring component type.

VEE groups can also be referenced by the [Execute VEE Group](#) VEE Rule.

For a deeper functional understanding of VEE, refer to the [About VEE](#) section of the *Oracle Utilities Meter Solution Business User Guide*.

## Configuring VEE Groups

This portal is used to display and maintain a VEE Group.

Refer to [Understanding VEE Groups](#) for more information.

You can access the portal from the **Admin > VEE > VEE Group > Search**. You are brought to a query portal with options for searching. Once your record has been selected you are brought to the maintenance portal to view and maintain the selected record.

The following zones may appear as part of the portal's **Main** tab page:

- **VEE Group**: Defines basic information about VEE group
- **VEE Rules List**: lists the VEE Rules belonging to the group
- **Referencing VEE Rules List**: lists the VEE Rules that reference the group
- **Referencing VEE Group Factors List**: lists the VEE group factors that reference the group
- **Referencing Measuring Component Type List**: lists the measuring component types that reference the group
- **Referencing Measuring Component List**: lists the measuring components that reference the group

### Where Used

Follow this link to open the data dictionary where you can view the tables that reference [DI\\_VEE\\_GRP](#).

## VEE Rules

### Understanding VEE Rules

VEE Rules are standard and custom Validation and Estimation rules that perform checking and/or manipulation of initial measurement data. VEE Rules are created for a specific VEE group. For example, if you were configuring two VEE groups and both included a specific VEE Rule, you would need to create two instances of the VEE Rule, one for each group.

The specific validation and estimation processing performed on initial measurement data is defined in individual VEE Rules, each performing a specific set of targeted logic. The base product contains many VEE Rules you can use in your implementation, but you can also create your own custom VEE Rules.

Some VEE Rules generate VEE Exceptions if the initial measurement data fails the conditions specified for the rule. Other rules override measurements, changing measurement values as dictated by the rule's parameters. Some rules can both create exceptions and override the measurement as part of a single process. By convention, VEE Rules change the Post-VEE quantities of initial measurement data, but VEE Rules can change anything on an initial measurement.

Every VEE Rule has an effective period. Rules will only be applied if the initial measurement's start date is within the rule's effective period. For example, an Interval Spike Check rule with a Start Date of 11/15/2010 will only be applied if the start date of the initial measurement is on or after 11/15/2010.

This allows you to update the specifics of a rule without removing the previous version of the rule. For example, you might change the tolerance of an Interval Spike Check rule from 1.2 to 1.5 as of a certain date. However, for initial measurement data for the period prior to the change, you would want to use the tolerance for the original version of the rule (1.2) instead of the new tolerance (1.5).



On almost every VEE Rule, the failure of the rule results in a VEE Exception and the [Exception Type](#) for the failure can be configured on the rule. These Exception Types can also be set to a specific Exception Severity:

- **Information:** Used to highlight minor issues, but not sufficient to cause the initial measurement data to be put into the exception state. Exceptions of this category can be used to report on the frequency of interesting, but not fatal issues
- **Issues:** Used to report a problem that will prevent the initial measurement data from being finalized. Multiple "issue exceptions" can be created during VEE processing. If at least one issue exists after all rules have been applied, the initial measurement data is transitioned to the exception state
- **Terminate:** Used to report a severe issue that will cause the VEE process to stop and the initial measurement data to be transitioned immediately to the exception state. Only one terminate exception can be issued (as the first one causes VEE processing to stop on an initial measurement data).

For a deeper functional understanding of VEE, refer to the [About VEE](#) section of the *Oracle Utilities Meter Solution Business User Guide*.

## Configuring VEE Rules

This portal is used to display and maintain a VEE Rule. Also, a list of the specific out-of-the-box rules is included below the instructions for using the portal.

Refer to [Understanding VEE Rules](#), [Understanding VEE Groups](#), and [Understanding Exception Types](#) for more information. For a deeper functional understanding of VEE, refer to the [About VEE](#) section of the *Oracle Utilities Meter Solution Business User Guide*.

You can access the portal from **Admin > VEE > VEE Rule > Search**. You are brought to a query portal with options for searching. Once your record has been selected you are brought to the maintenance portal to view and maintain the selected record.

The following zones may appear as part of the portal's **Main** tab page:

- **VEE Rule:** this zone displays all of the configuration items specific to this instance of a VEE Rule.
- **Eligibility Criteria List:** this zone displays any VEE Rule Eligibility Criteria that have been setup. These eligibility criteria determine conditionally whether the VEE Rule should be executed or not. Use the Add button to create a new eligibility criteria for the rule you're viewing.

## Where Used

Follow this link to open the data dictionary where you can view the tables that reference [D1\\_VEE\\_RULE](#).

## Validation VEE Rules

Below is a list of the validation rules provided as part of base product. For more information on how each rule executes and can be configured, follow the link provided on the rule.

VEE Rule Name	Applicable Data Type(s)	Purpose
<a href="#">Consecutive Interval Check</a>	Interval	This validation rule flags any combination of consecutive intervals within Initial Measurement Data based on the values of the data or the condition codes of the data.
<a href="#">Duplicate IMD Check</a>	Interval or Scalar	This rule allows for a duplicate IMD to be flagged.
<a href="#">Dynamic Comparison Validation</a>	Interval or Scalar	This powerful, flexible validation rule compares measurements to historical statistics for the related Service Point. The system will maintain statistics such as the

following: sum, min, max, average, median, zero value count, outage count, and standard deviation. Then you define formulas (no programming required) for the comparison of current measurements to these statistics.

Ensure IMD Exists for Sibling MCs	Interval or Scalar	This rule validates that an IMD exists for all of the other measuring components associated to the same Device Configuration as the current measuring component, for the same period of time.
Final Measurement Replacement	Interval or Scalar	This validation rule allows you to define a variety of configuration options to decide if new data should replace existing measurements. The options include value change thresholds, percentage change thresholds, as well as condition code ranking.
High/Low Check	Interval or Scalar	This validation rule compares the total consumption of the current IMD to historical values. The comparison is normalized based on average daily usage (ADU). If the current IMD is too high or too low compared to historical data then an exception is thrown.
Inactive Measurement Check	Interval or Scalar	This validation rule flags any Initial Measurement Data received on a device that is either disconnected, uninstalled, and/or not connected to a Usage Subscription.
Interval Size Validation	Interval	This rule validates that the interval size (in seconds) supplied with the Initial Measurement is equal to the interval size defined on measuring component's type.
Interval Spike Check	Interval	This rule checks for spikes within an IMD and generates an exception if one is found.
Multiplier Check	Interval or Scalar	This rule validates that the register multiplier supplied with the IMD is equal to the multiplier stored on the measuring component. If not, an exception is created using the register multiplier exception type and severity configured on the rule.
Negative Consumption Check	Interval or Scalar	This rule flags any IMD where the total consumption is negative.
Prolonged Estimation Check	Interval or Scalar	This validation rule creates an alert when a device has been estimated for an extended period of time.
Raise Missing Quantity Exception	Interval	This rule flags any missing interval data.
Sum Check	Interval or Scalar	This rule is used to compare the difference between interval data to scalar data for a period of time, or between a set of TOU scalar reads to a "Sum" scalar reading.
Unit of Measure Check	Interval or Scalar	This rule checks the unit of measure (UOM) passed in with the Initial Measurement against

the primary unit of measure configured on the measuring component's type.

<a href="#">Zero Consumption Check</a>	Interval or Scalar	This rule checks if the total consumption for the IMD is zero. There is also a check for whether an outage occurred during the same time as the zero consumption to provide ways to avoid exceptions in that case.
--	--------------------	--

## Estimation VEE Rules

Below is a list of the estimation rules provided as part of base product. For more information on how each rule executes and can be configured, follow the link provided on the rule.

VEE Rule Name	Applicable Data Type(s)	Purpose
<a href="#">Interval Adjustment From Scalar</a>	Interval	This rule performs adjustments to interval values based on the values from the associated scalar data on the same device.
<a href="#">Interval Averaging Estimation</a>	Interval	This rule finds historical interval data from the same measuring component based on a variety of configuration options to use for estimating any missing data within an IMD.
<a href="#">Interval Create Estimation IMD for Gap</a>	Interval	This estimation rule creates a new Estimation IMD to fill gaps between the interval data received from the Head End.  <b>Note:</b> <i>this estimation rule acts differently from the other rules as it creates a new IMD rather than filling in missing values in an estimation IMD created from periodic estimations.</i>
<a href="#">Interval Interpolation Estimation</a>	Interval	This rule attempts to interpolate gaps within an IMD using prior and subsequent intervals as starting points for linear interpolation.
<a href="#">Interval Profile Estimation</a>	Interval	This rule estimates any missing interval data for the IMD based on a referenced Profile Factor.
<a href="#">Interval Proxy Day Estimation</a>	Interval	This rule checks for days with similar temperature and uses the measurement data from those days as the basis of interval estimation for the in-flight initial measurement.
<a href="#">Scalar Calculation From Interval</a>	Scalar	This rule performs adjustments to scalar values based on the values from the associated interval data on the same device.
<a href="#">Scalar Estimation</a>	Scalar	This rule finds historical scalar data from the same measuring component based on a variety of configuration options to use for estimating any missing data within an IMD.
<a href="#">Scalar Profile Estimation</a>	Scalar	This rule estimates any missing scalar data for the IMD based on a referenced Profile Factor.

<a href="#">Scalar Proration</a>	Scalar	This rule prorates the value of a scalar reading that has two valid scalar readings on either side as boundaries. It will also take into account any related interval data within the same period to exclude from the calculation.
<a href="#">Subtractive Interval Adjustment Rule</a>	Subtractive Interval Adjustment Rule	This rule performs adjustments to qualifying interval consumption values for subtractive interval measuring components based on an adjustment target calculated using a start and stop reading for the period that encapsulates the intervals to adjust.

## Decision-Making VEE Rules

There are VEE Rules delivered as part of the base product that help with decision-making when executing VEE (listed below). For more information on how each rule executes and can be configured, follow the link provided on the rule.

VEE Rule Name	Purpose
<a href="#">Exception Handler</a>	This rule allows for termination of the VEE process based on a configurable set of exceptions being present for the IMD. This rule also allows a unique To Do Type to be generated based on a group of exceptions.
<a href="#">Execute VEE Group</a>	This rule performs a call to execute a separate VEE Group which includes execution of all VEE Rules within that group.
<a href="#">Successful Termination</a>	This rule allows VEE to be successfully terminated based on a list of exceptions.
<a href="#">VEE Group Matrix (Factor)</a>	This rule provides a way to choose different instances of a VEE Rule using a Factor. This factor leverages characteristics that are defined on Service Point, Device, or Measuring Component.

## Validation VEE Rules

### Consecutive Interval Check

#### Overview

This rule flags any combination of consecutive intervals within Initial Measurement Data based on the values of the data or the condition codes of the data. It can be used to find faulty meters that are reporting consecutive outage codes, zero measurements, or negative values. It can also be used by water utilities to identify leaks based on the interval never reaching zero.

#### NOTE:

Additional detail on the logic of this rule can be found in the Detailed Description of the [D2-CONSINTRV](#) Algorithm Type.

For help with the meaning of specific configuration fields, refer to the embedded help on the screen when adding or editing the rule.

## Business Object

D2-ConsecutiveIntervalCheck

## Example Scenarios

Below are some example scenarios that can be achieved based on configuration of this rule.

**Scenario 1:** Rule configured to fail for zero values

Parameter Name	Configuration Value
Check performed	Consecutive Measurement Values
Maximum consecutive hours	02:00:00
Look To Prior Measurements	No
Equation Type	Equal To
Value for Comparison	0
Bottom Range Condition	
Top Range Condition	

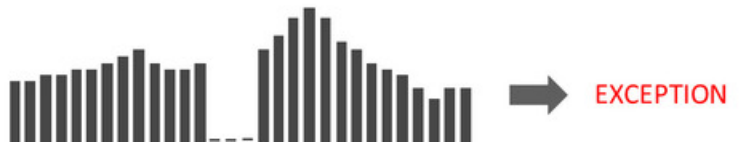
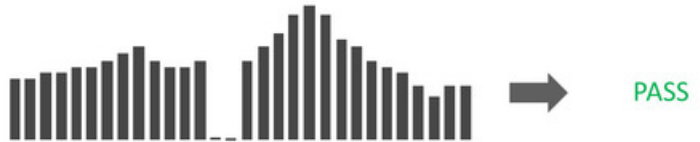
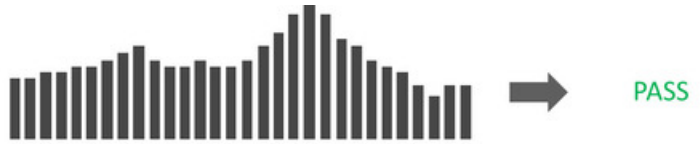

**Scenario 2:** Rule configured to fail for negative values

Parameter Name	Configuration Value
Check performed	Consecutive Measurement Values
Maximum consecutive hours	02:00:00
Look To Prior Measurements	No
Equation Type	Less Than
Value for Comparison	0
Bottom Range Condition	
Top Range Condition	

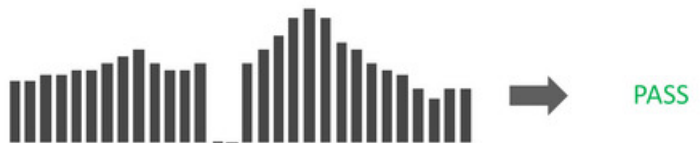
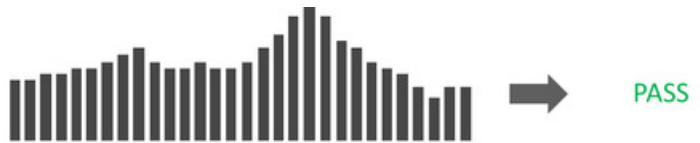

**Scenario 3:** Rule configured to fail for missing condition codes

Parameter Name	Configuration Value
Check performed	Consecutive Condition Values
Maximum consecutive hours	02:00:00
Look To Prior Measurements	No
Equation Type	
Value for Comparison	
Bottom Range Condition	Missing
Top Range Condition	Missing

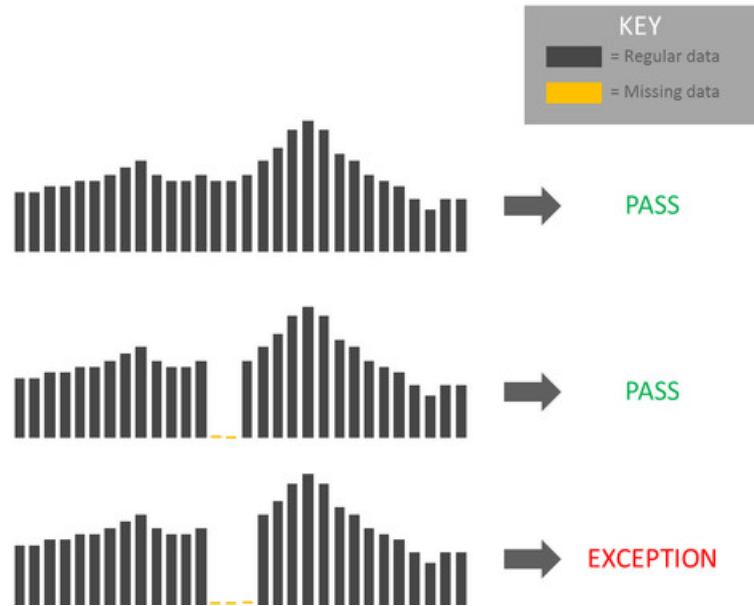

**Scenario 4:** Rule configured to fail for outage condition codes only if its zero

Parameter Name	Configuration Value
Check performed	Both
Maximum consecutive hours	02:00:00
Look To Prior Measurements	No
Equation Type	Equal To
Value for Comparison	0
Bottom Range Condition	Outage
Top Range Condition	Outage

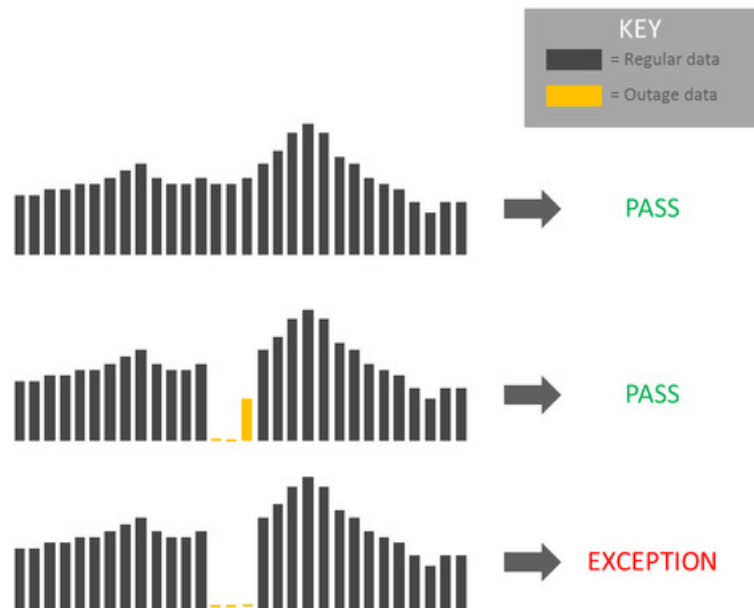

**Scenario 5:** Rule configured to fail if a long period of consecutive water values are greater than 0.1

Parameter Name	Configuration Value
Check performed	Consecutive Measurement Values
Maximum consecutive hours	20:00:00
Look To Prior Measurements When First Interval Matches Criteria	No
Equation Type	Greater Than
Value for Comparison	0.1
Bottom Range Condition	
Top Range Condition	

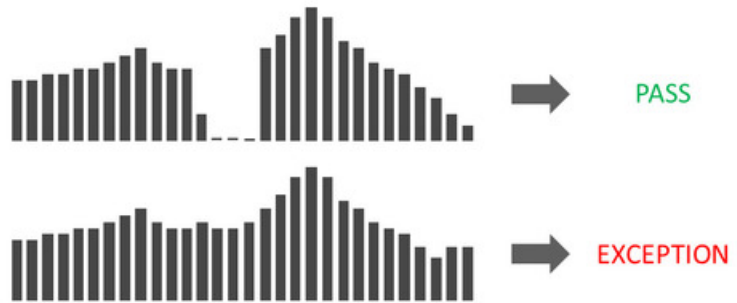

**Scenario 6:** Look back at prior measurements when the first interval matches criteria

Parameter Name	Configuration Value
Check performed	Consecutive Measurement Values
Maximum consecutive hours	02:00:00
Look To Prior Measurements	Yes
Equation Type	Equal To
Value for Comparison	0
Bottom Range Condition	
Top Range Condition	

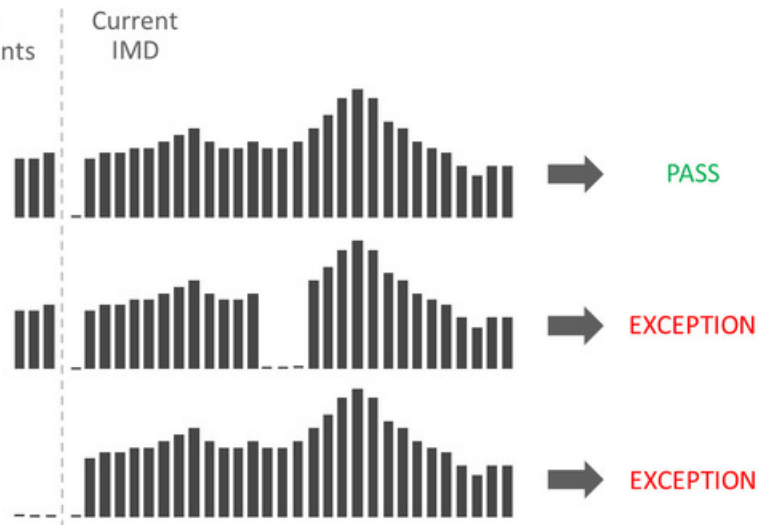

## Duplicate IMD Check

If the current Initial Measurement Data (IMD) being validated is determined to be a duplicate of an existing IMD for the same measuring component, this rule will produce a VEE exception of the type and severity configured on the VEE Rule. The algorithm logic looks for duplicate IMDs using the following criteria:

- associated to the same measuring component as the current IMD
- utilizes the same IMD business object as the current IMD (for example, Initial Load Scalar)
- references the same To Date/Time (ends on the same date) as the current IMD
- exists in a "Finalized" state
- the contents of pre-VEE are identical to the pre-VEE of the current IMD

If any IMDs are found that meet all of the above criteria, the current IMD is deemed to be a duplicate.

### NOTE:

Additional detail on the logic of this rule can be found in the Detailed Description of the [DI-DUPIMDCHK](#) Algorithm Type.

For help with the meaning of specific configuration fields, refer to the embedded help on the screen when adding or editing the rule.

## Business Object

D1-DuplicateIMDCheck

## Dynamic Comparison Validation

This validation rule compares measurements to historical statistics for the related Service Point. The system will maintain statistics such as the following: sum, min, max, average, median, zero value count, outage count, and standard deviation. Setting up these [Measuring Component Statistics](#) is a prerequisite to using the rule.

Users can define formulas (no programming required) for the comparison of current measurements to these statistics. This is powerful rule will allow utilities to look for unusual usage patterns. For example:

- Lowest/highest usage ever
- Current usage is more than three standard deviations from the mean
- Detect unexpected zero usage
- Detect negative usage while ruling out known cases
- Abnormal usage
- Voltage threshold monitoring
- 

---

### NOTE:

Additional detail on the logic of this rule can be found in the Detailed Description of the [D2-DYNCOMCHK](#) Algorithm Type.

For help with the meaning of specific configuration fields, refer to the embedded help on the screen when adding or editing the rule.

---

## Business Object

D2-DynCompValidation

## Example Scenarios

Below are some example scenarios that can be achieved based on configuration of this rule.

**Example 1:** Detect new "high water mark"



**Example 2:** High Usage



### Historical Statistics

Statistics MC Type: MC_STATS_LASTMONTH		
Average	15 min	1.630
Standard Deviation	15 min	0.519

Statistics MC Type: MC_STATS_LASTYEAR		
Average	15 min	1.893
Standard Deviation	15 min	0.851

### Dynamic Values

- |  |   |
|--|---|
| <b>Variable Name: IMD1</b><br><ul style="list-style-type: none"> <li>Source Type: IMD</li> <li>Set Function: Max</li> </ul>  | <b>Variable Name: CS3</b><br><ul style="list-style-type: none"> <li>Source Type: Channel Statistics</li> <li>MC Type: MC_STATS_LASTYEAR</li> <li>Value: Average</li> </ul>            |
| <b>Variable Name: CS1</b><br><ul style="list-style-type: none"> <li>Source Type: Channel Statistics</li> <li>MC Type: MC_STATS_LASTMONTH</li> <li>Value: Average</li> </ul>            | <b>Variable Name: CS4</b><br><ul style="list-style-type: none"> <li>Source Type: Channel Statistics</li> <li>MC Type: MC_STATS_LASTYEAR</li> <li>Value: Standard Deviation</li> </ul> |
| <b>Variable Name: CS2</b><br><ul style="list-style-type: none"> <li>Source Type: Channel Statistics</li> <li>MC Type: MC_STATS_LASTMONTH</li> <li>Value: Standard Deviation</li> </ul> |   |

### Equation

$$(IMD1 - CS1) / CS2 > 3$$

$$AND (IMD1 - CS3) / CS4 > 3$$

This equation checks that the standard score of the current max interval is within 3 standard deviations of historical data from last month and last year. If greater than 3 standard deviations, an exception is thrown.

### Example 3: Detect unexpected zero usage (method 1)

### Historical Statistics

Statistics MC Type: MC_STATS_LASTMONTH		
Total Count	15 min	2880
Zero Count	15 min	3

Statistics MC Type: MC_STATS_LASTYEAR		
Total Count	15 min	2880
Zero Count	15 min	0

### Dynamic Values

- |   |  |
|---|--|
| <b>Variable Name: IMD1</b><br><ul style="list-style-type: none"> <li>Source Type: IMD</li> <li>Calc Function: Sum</li> </ul>  | <b>Variable Name: CS_T2</b><br><ul style="list-style-type: none"> <li>Source Type: Channel Statistics</li> <li>MC Type: MC_STATS_LASTYEAR</li> <li>Value: Total Count</li> </ul> |
| <b>Variable Name: CS_T1</b><br><ul style="list-style-type: none"> <li>Source Type: Channel Statistics</li> <li>MC Type: MC_STATS_LASTMONTH</li> <li>Value: Total Count</li> </ul> | <b>Variable Name: CS_Z2</b><br><ul style="list-style-type: none"> <li>Source Type: Channel Statistics</li> <li>MC Type: MC_STATS_LASTYEAR</li> <li>Value: Zero Count</li> </ul>  |
| <b>Variable Name: CS_Z1</b><br><ul style="list-style-type: none"> <li>Source Type: Channel Statistics</li> <li>MC Type: MC_STATS_LASTMONTH</li> <li>Value: Zero Count</li> </ul>  |  |

### Equation

$$IMD1 = 0$$

$$AND CS_Z1 / CS_T1 < 0.01$$

$$AND CS_Z2 / CS_T2 < 0.01$$

This equation finds zero intervals in the current IMD that seem to not fit with historical trends for the customer based on prior counts of zero intervals.

### Example 4: Detect unexpected zero usage (method 2)

### Historical Statistics

Statistics MC Type: MC_STATS_LASTMONTH		
Min	15 min	0.43

Statistics MC Type: MC_STATS_LASTYEAR		
Min	15 min	0.52

### Dynamic Values

- |  |   |
|--|---|
| <b>Variable Name: IMD1</b><br><ul style="list-style-type: none"> <li>Source Type: IMD</li> <li>Calc Function: Min</li> </ul> | <b>Variable Name: CS1</b><br><ul style="list-style-type: none"> <li>Source Type: Channel Statistics</li> <li>MC Type: MC_STATS_LASTMONTH</li> <li>Value: Min</li> </ul> |
|  | <b>Variable Name: CS2</b><br><ul style="list-style-type: none"> <li>Source Type: Channel Statistics</li> <li>MC Type: MC_STATS_LASTYEAR</li> <li>Value: Min</li> </ul>  |

### Equation

$$IMD1 = 0$$

$$AND CS1 > 0$$

$$AND CS2 > 0$$

This equation finds zero intervals in the current IMD that seem to not fit because the minimum values for the meter historically have never reached zero during comparable periods.

### Example 5: Detect negative usage while ruling out known cases

### Historical Statistics

Statistics MC Type: MC_STATS_13MONTHS		
Negative Count	15 min	0

### Dynamic Values

- |  |
|--|
| <b>Variable Name: V1</b><br><ul style="list-style-type: none"> <li>Source Type: IMD</li> <li>Calc Function: Min</li> </ul>   |
| <b>Variable Name: V2</b><br><ul style="list-style-type: none"> <li>Source Type: Channel Statistics</li> <li>MC Type: MC_STATS_13MONTHS</li> <li>Value: Negative Count</li> </ul> |

### Equation

$$V1 < 0 AND V2 = 0$$

This equation detects negative usage on the current IMD while the prior 13 months shows no cases of negative usage.

### Example 6: Abnormal usage

### Historical Statistics

Statistics MC Type: MC\_STATS\_LASTMONTH

Average	15 min	1.630
Standard Deviation	15 min	0.519

Statistics MC Type: MC\_STATS\_LASTYEAR

Average	15 min	1.893
Standard Deviation	15 min	0.851

### Dynamic Values

- Variable Name: IMD\_STD
  - Source Type: IMD
  - Calc Function: Standard Deviation
- Variable Name: IMD\_AVG
  - Source Type: IMD
  - Calc Function: Average
- Variable Name: LM\_AVG
  - Source Type: Channel Statistics
  - MC Type: MC\_STATS\_LASTMONTH
  - Value: Average
- Variable Name: LM\_STD
  - Source Type: Channel Statistics
  - MC Type: MC\_STATS\_LASTMONTH
  - Value: Standard Deviation
- Variable Name: LY\_AVG
  - Source Type: Channel Statistics
  - MC Type: MC\_STATS\_LASTYEAR
  - Value: Average
- Variable Name: LY\_STD
  - Source Type: Channel Statistics
  - MC Type: MC\_STATS\_LASTYEAR
  - Value: Standard Deviation

### Equation

```
IMD_AVG <= 0
AND ABS(IMD_AVG - LM_AVG) < 0.5
AND ABS(IMD_AVG - LY_AVG) < 0.5
AND ABS(IMD_STD - LM_STD) > 1.5
AND ABS(IMD_STD - LY_STD) > 1.5
```

This equation determines that the average of the current IMD is close to the historical average but that the standard deviation is far off. This points to abnormal usage.

### Example 7: Voltage threshold monitoring

### Historical Statistics

None

### Dynamic Values

- Variable Name: VOLT\_MAX
  - Source Type: IMD
  - Calc Function: Max
- Variable Name: VOLT\_MIN
  - Source Type: IMD
  - Calc Function: Min

### Equation

```
VOLT_MIN < 117
OR
VOLT_MAX > 127
```

This equation determines if the voltage data in the current IMD has fallen below or exceeded the bounds that a utility needs to keep customer voltage within. This is usually set to values that catch incorrect voltage before the value drops below the regulatory requirement.

## Ensure IMD Exists for Sibling MCs

This rule validates that an IMD exist for all of the other measuring components associated to the same Device Configuration as the current measuring component, for the same period of time.

A check is also performed that all of the Initial Measurements have the same External Source ID (indicating that they all came from the same usage file).

#### NOTE:

Additional detail on the logic of this rule can be found in the Detailed Description of the [D2-ENSIMDMC](#) Algorithm Type.

For help with the meaning of specific configuration fields, refer to the embedded help on the screen when adding or editing the rule.

## Business Object

D2-EnsureIMDExistsForSibling

## Final Measurement Replacement

This validation rule allows you to define a variety of configuration options to decide if new scalar or interval data should replace existing measurements. The options include value change thresholds, percentage change thresholds, as well as condition code ranking. One common use for this rule is rejecting trivial measurement changes to prevent very small changes for a bill from being sent to a customer.

#### NOTE:

Additional detail on the logic of this rule can be found in the Detailed Description of the [D2-VLMSRCOND](#) Algorithm Type.

For help with the meaning of specific configuration fields, refer to the embedded help on the screen when adding or editing the rule.

## Business Object

D2-FinalMeasurementValidation

### Example Scenarios

Below are some example scenarios that can be achieved based on configuration of this rule.

#### Example 1: Replacement of measurements based solely on value difference

KEY	
<span style="display:inline-block; width:10px; height:10px; background-color:gray;"></span>	= Regular
<span style="display:inline-block; width:10px; height:10px; background-color:yellow;"></span>	= System Estimated
<span style="display:inline-block; width:10px; height:10px; background-color:red;"></span>	= No Read – System
<span style="display:inline-block; width:10px; height:10px; background-color:blue;"></span>	= No Read – Outage
<span style="display:inline-block; width:10px; height:10px; background-color:lightgreen;"></span>	= Super

Parameter Name	Configuration Value
Replacement Method	Reject Based on Configuration
Replacement Condition Value	No Read – System
Replace Manually Edited Data?	
Use Early and Late MC Type Settings?	
Replacement Evaluation Type	Compare Value Change
Value Change Tolerance	0.1
Percentage Change Tolerance	
Condition Code Prioritization by Groups	

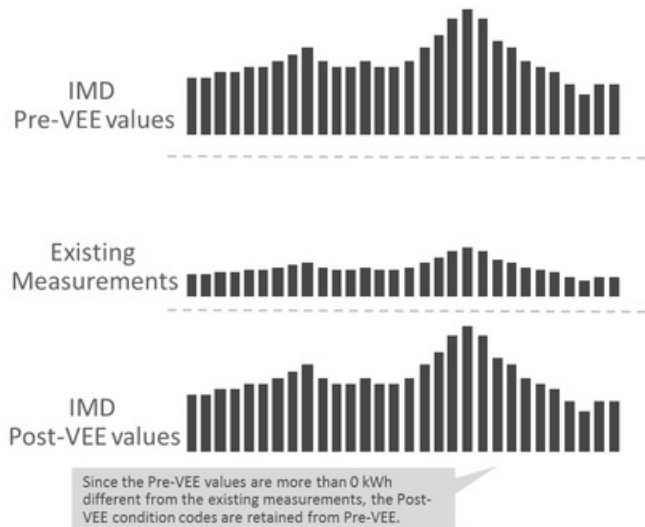

#### Example 2: Percentage change to replace measurement

KEY	
<span style="display:inline-block; width:10px; height:10px; background-color:gray;"></span>	= Regular
<span style="display:inline-block; width:10px; height:10px; background-color:yellow;"></span>	= System Estimated
<span style="display:inline-block; width:10px; height:10px; background-color:red;"></span>	= No Read – System
<span style="display:inline-block; width:10px; height:10px; background-color:blue;"></span>	= No Read – Outage
<span style="display:inline-block; width:10px; height:10px; background-color:lightgreen;"></span>	= Super

Parameter Name	Configuration Value
Replacement Method	Reject Based on Configuration
Replacement Condition Value	No Read – System
Replace Manually Edited Data?	
Use Early and Late MC Type Settings?	
Replacement Evaluation Type	Compare Percentage Change
Value Change Tolerance	
Percentage Change Tolerance	50
Condition Code Prioritization by Groups	

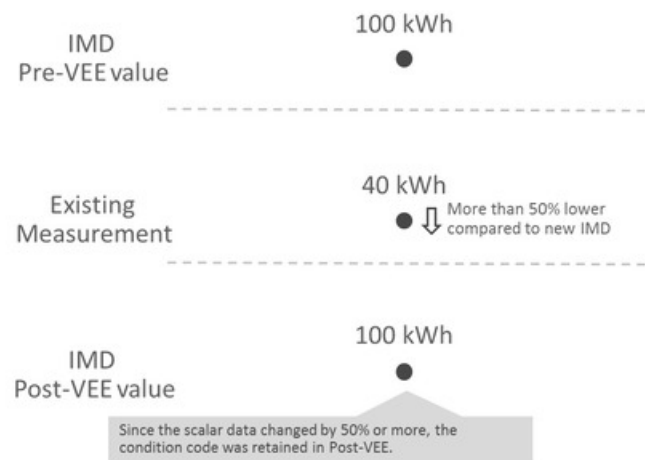

#### Example 3: Partial replacement of estimated data with regular data based on condition range prioritization

KEY	
■	= Regular
■	= System Estimated
■	= No Read – System
■	= No Read – Outage
■	= Super

Parameter Name	Configuration Value
Replacement Method	Reject Based on Configuration
Replacement Condition Value	No Read – System
Replace Manually Edited Data?	
Use Early and Late MC Type Settings?	
Replacement Evaluation Type	Compare Value Change
Value Change Tolerance	0.1
Percentage Change Tolerance	
Condition Code Prioritization by Groups	10: Super 20: Regular, No Read – Outage 30: System Estimate 40: No Read – System

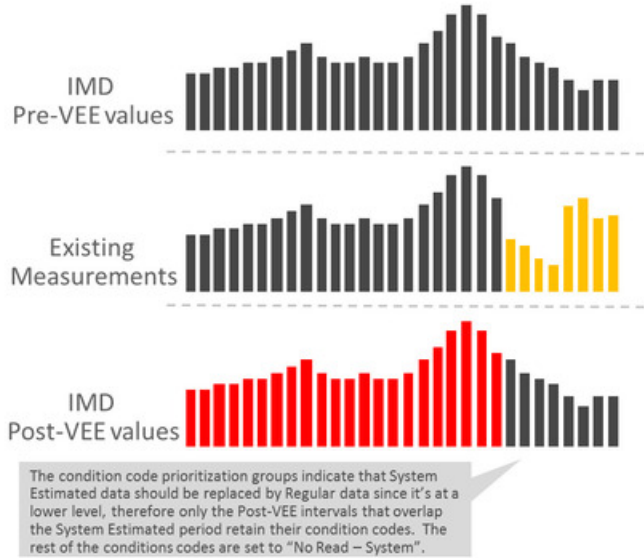

**Example 4:** Partial replacement of regular data with outage data based on condition range prioritization

KEY	
■	= Regular
■	= System Estimated
■	= No Read – System
■	= No Read – Outage
■	= Super

Parameter Name	Configuration Value
Replacement Method	Reject Based on Configuration
Replacement Condition Value	No Read – System
Replace Manually Edited Data?	
Use Early and Late MC Type Settings?	
Replacement Evaluation Type	Compare Value Change
Value Change Tolerance	0.1
Percentage Change Tolerance	
Condition Code Prioritization by Groups	10: Super 20: Regular, No Read – Outage 30: System Estimate 40: No Read – System

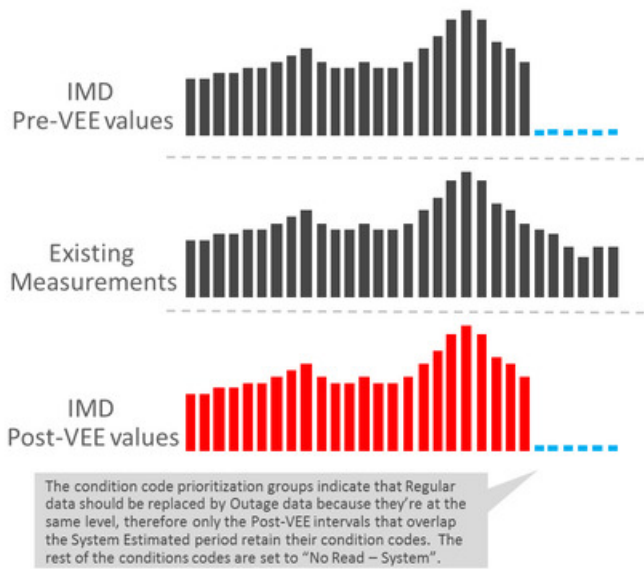

**Example 5:** Super not replaced by regular (retain a smoothed spike)

KEY	
■	= Regular
■	= System Estimated
■	= No Read – System
■	= No Read – Outage
■	= Super

Parameter Name	Configuration Value
Replacement Method	Reject Based on Configuration
Replacement Condition Value	No Read – System
Replace Manually Edited Data?	
Use Early and Late MC Type Settings?	
Replacement Evaluation Type	
Value Change Tolerance	
Percentage Change Tolerance	
Condition Code Prioritization by Groups	10: Super 20: Regular, No Read – Outage 30: System Estimate 40: No Read – System

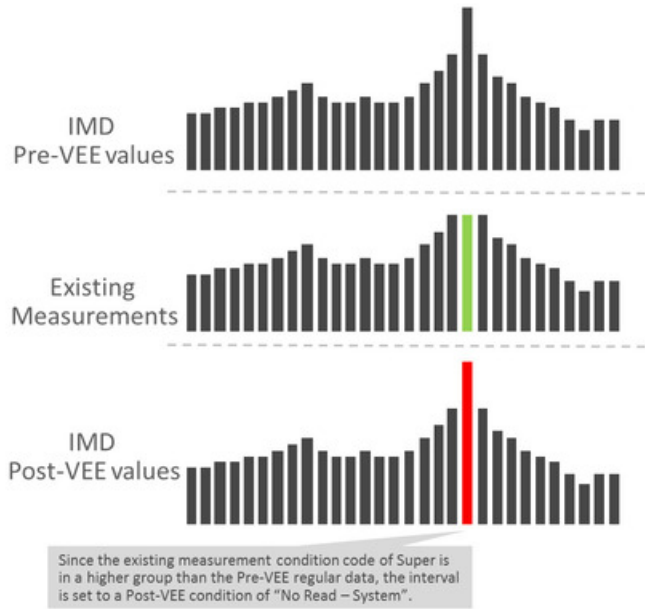

**Example 6:** Prevent replacement of manually edited data

KEY	
■	= Regular
■	= System Estimated
■	= No Read – System
■	= No Read – Outage
■	= Super
⚙	= User Edited data

Parameter Name	Configuration Value
Replacement Method	Reject Based on Configuration
Replacement Condition Value	No Read – System
Replace Manually Edited Data?	No
Use Early and Late MC Type Settings?	
Replacement Evaluation Type	
Value Change Tolerance	
Percentage Change Tolerance	
Condition Code Prioritization by Groups	

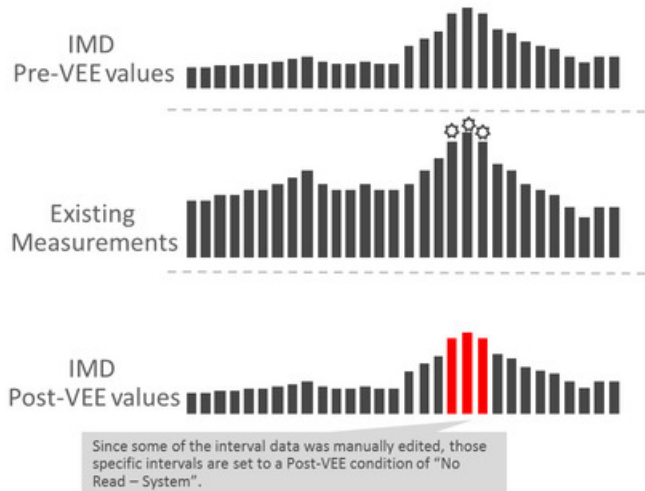

**Example 7:** Allow replacement of manually edited data if the condition group is lower than new data

KEY	
<span style="display:inline-block; width:10px; height:10px; background-color:black;"></span>	= Regular
<span style="display:inline-block; width:10px; height:10px; background-color:yellow;"></span>	= System Estimated
<span style="display:inline-block; width:10px; height:10px; background-color:red;"></span>	= No Read – System
<span style="display:inline-block; width:10px; height:10px; background-color:blue;"></span>	= No Read – Outage
<span style="display:inline-block; width:10px; height:10px; background-color:lightgreen;"></span>	= Super
<span style="display:inline-block; width:10px; height:10px; border:1px solid black; border-radius:50%;"></span>	= User Edited data

Parameter Name	Configuration Value
Replacement Method	Reject Based on Configuration
Replacement Condition Value	No Read – System
Replace Manually Edited Data?	No
Use Early and Late MC Type Settings?	
Replacement Evaluation Type	
Value Change Tolerance	
Percentage Change Tolerance	
Condition Code Prioritization by Groups	10: Super 20: Regular, No Read – Outage 30: System Estimate 40: No Read – System

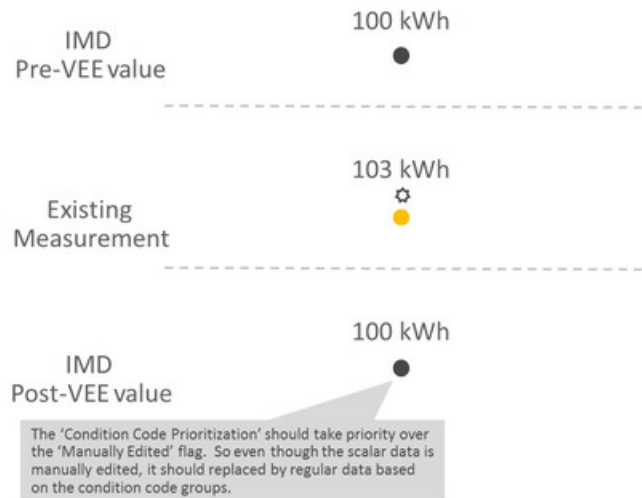

## High/Low Check

This validation rule compares the total consumption of the current IMD to historical values. The comparison is normalized based on average daily usage (ADU). If the current IMD is too high or too low compared to historical data then an exception is thrown.

Numerous configuration options are provided including:

- A Historical Pre-Window and Post-Window that determines the number of days to check before and after the period being examined.
- Percentages to control how much of the historical data can be user edited, estimated, or non-normal data.
- What type of historical data to look at first
- What to do when an outage has occurred

### NOTE:

Additional detail on the logic of this rule can be found in the Detailed Description of the [D2-HILO-CHK](#) Algorithm Type.

For help with the meaning of specific configuration fields, refer to the embedded help on the screen when adding or editing the rule.

## Business Object

D2-VEERuleHighLowCheck

## Inactive Measurement Check

This validation rule flags any Initial Measurement Data received on a device that is either disconnected, uninstalled, and/or not connected to a usage subscription.

- When the 'Check Measurements on Disconnected Device' flag is set to "Yes", the logic will compare the IMD measurements total to the threshold configured. If the total measurements are above the threshold, then logic compares



the IMD dates to two things: 1) On/Off Dates related to the Install Event and 2) the Installation and Removal Dates of the Install Event. If the On or Off falls within the dates for an interval IMD, then the logic will only sum intervals that fall during the disconnected periods.

- When the 'Check for Uninstalled Device' flag is set to "Yes", the logic will check for a valid Install Event based on the IMD dates.
- When the 'Check for Missing Usage Subscription' flag is set to "Yes", the logic will check for an active Usage Subscription based on the IMD dates.

**NOTE:**

Additional detail on the logic of this rule can be found in the Detailed Description of the [D2-INACTVCHK](#) Algorithm Type.

For help with the meaning of specific configuration fields, refer to the embedded help on the screen when adding or editing the rule.

**Business Object**

D2-InactiveMeasurementCheck

**Example Scenarios**

Below are some example scenarios that can be achieved based on configuration of this rule.

**Example 1:** Non-zero data during disconnected period

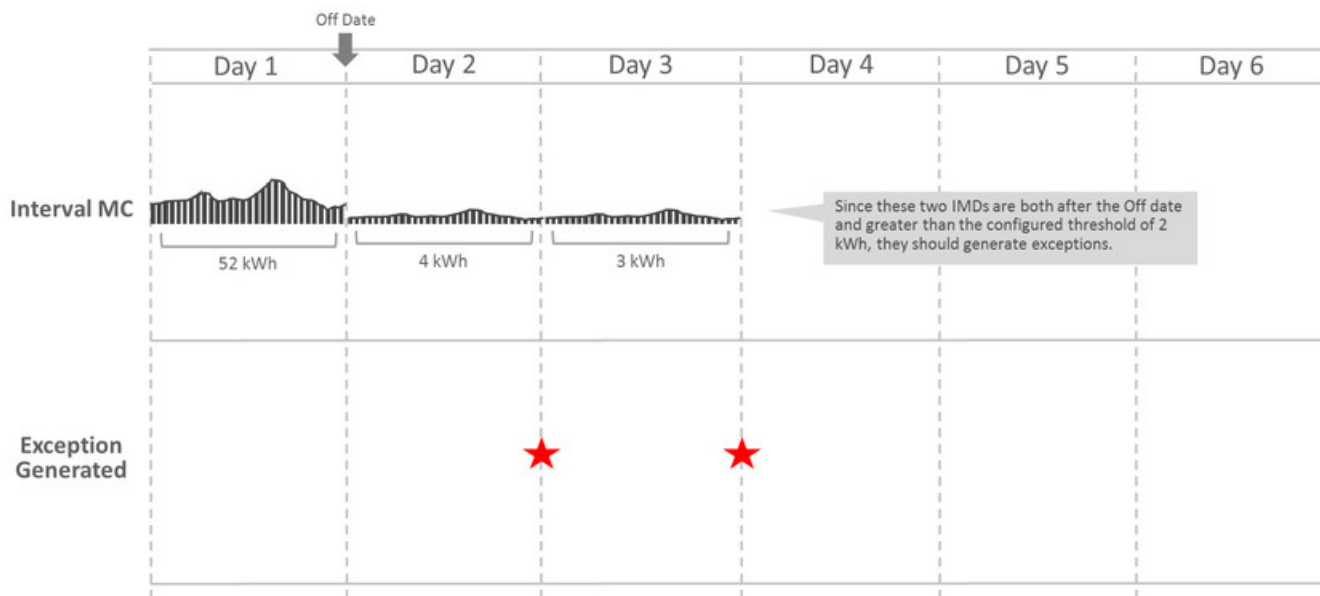

**Example 2:** Non-zero data after removal date with no new install

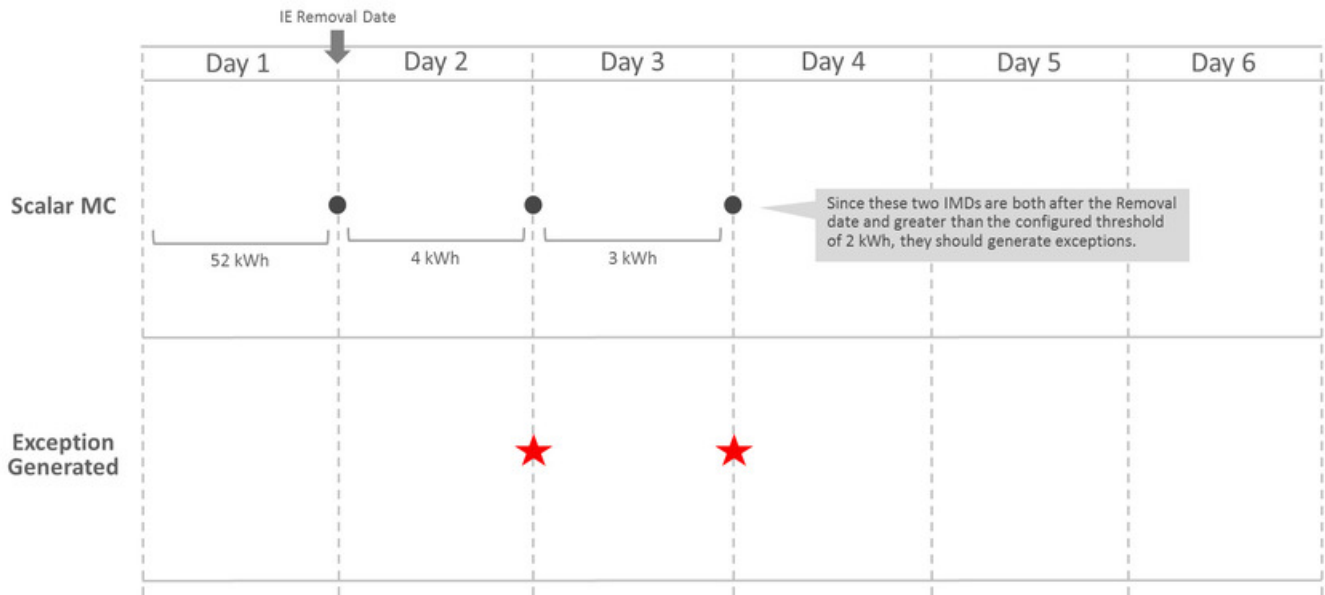

**Example 3:** Data received when device has no Install Event records

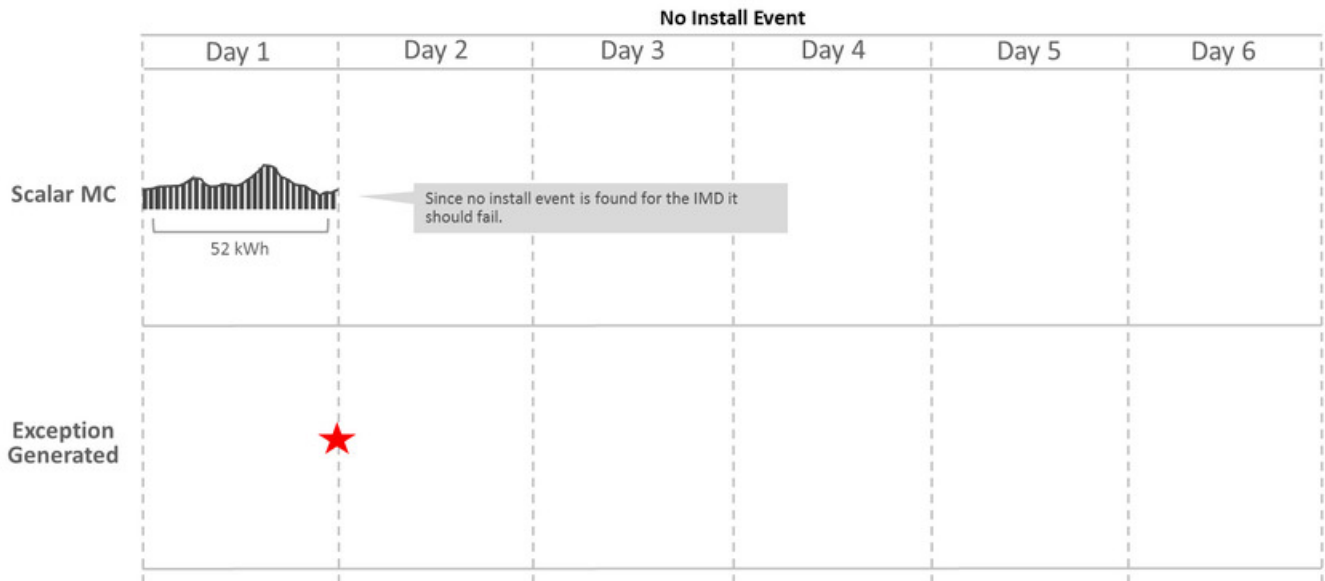

**Example 4:** Data received when not connected to a Usage Subscription record



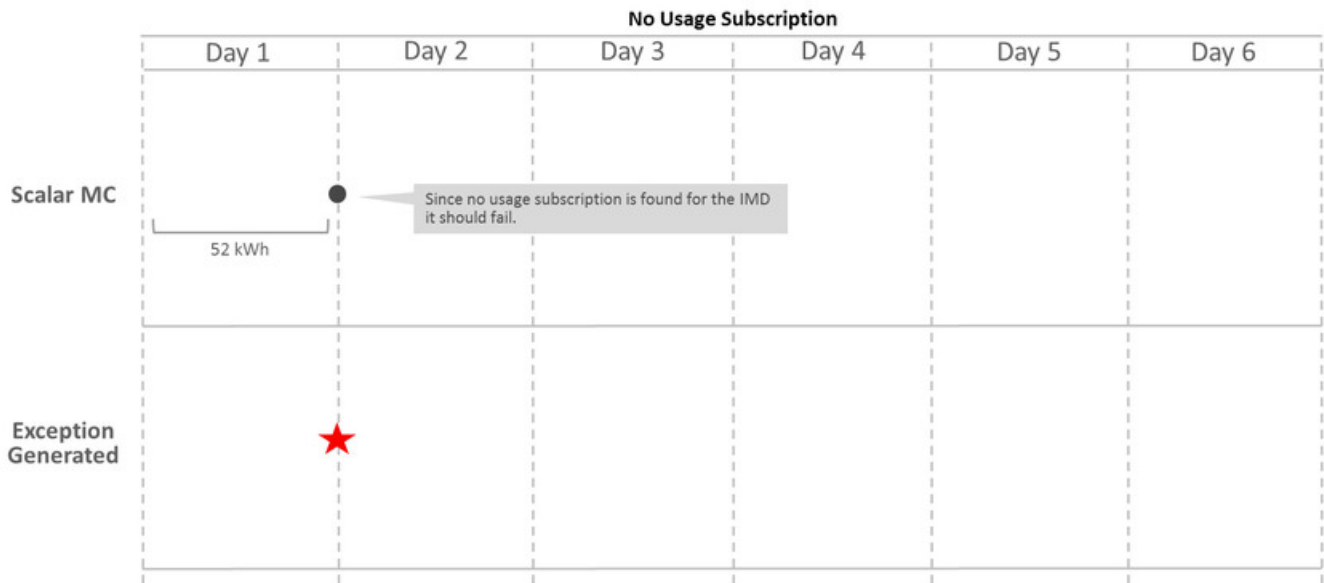

## Interval Size Validation

This rule validates that the interval size (in seconds) supplied with the Initial Measurement is equal to the interval size defined on measuring component's type.

**NOTE:**

Additional detail on the logic of this rule can be found in the Detailed Description of the [D2-INTSIZVAL](#) Algorithm Type.

For help with the meaning of specific configuration fields, refer to the embedded help on the screen when adding or editing the rule.

## Business Object

D2-IntervalSizeValidation

## Interval Spike Check

This rule looks for spikes by taking the highest interval and the third-highest interval, and determining the percent difference between the two. If the percent difference is larger than the tolerance configured on the rule, the algorithm logs an exception of the type and severity configured on the rule.

The rule can be executed in one of two modes (as configured on the rule):

- The spike check is performed for every 24-hour chunk of data in the initial measurement data set
- The spike check is performed for the entire initial measurement data set

**NOTE:**

Additional detail on the logic of this rule can be found in the Detailed Description of the [D2-INTSPKCHK](#) Algorithm Type.

For help with the meaning of specific configuration fields, refer to the embedded help on the screen when adding or editing the rule.

## Business Object

D2-IntervalSpikeCheck

## Multiplier Check

This rule validates that the register multiplier supplied with the Initial Measurement is equal to the multiplier stored on the measuring component.

---

### NOTE:

Additional detail on the logic of this rule can be found in the Detailed Description of the [D2-REGMULCHK](#) Algorithm Type.

For help with the meaning of specific configuration fields, refer to the embedded help on the screen when adding or editing the rule.

---

## Business Object

D2-RegisterMultiplierCheck

## Negative Consumption Check

This rule checks if the total consumption of the IMD is less than zero. If the rule encounters negative consumption, an exception will be logged only if the related Measuring Component Type is not configured to "allow negative consumption".

---

### NOTE:

Additional detail on the logic of this rule can be found in the Detailed Description of the [D2-NCON-CHK](#) Algorithm Type.

For help with the meaning of specific configuration fields, refer to the embedded help on the screen when adding or editing the rule.

---

## Business Object

D2-NegativeConsumptionCheck

## Prolonged Estimation Check

This validation rule can be used on either interval or scalar and will alert you when a device has been estimated for an extended period of time. The IMD must first fall within the condition code range configured on the rule for this to execute. Next the validation finds the 'Most Recent Non-Estimated Read Date Time' from the Measurement Component. If this date plus the 'Days of Estimation Allowable' from the VEE Rule is less than the IMD End Date then a Prolonged Estimation Exception is created.

---

### NOTE:

Additional detail on the logic of this rule can be found in the Detailed Description of the [D2-PROESTCHK](#) Algorithm Type.

For help with the meaning of specific configuration fields, refer to the embedded help on the screen when adding or editing the rule.

---

## Business Object

D2-ProlongedEstimationCheck

## Example Scenario

Below is an example scenario that can be achieved based on configuration of this rule.

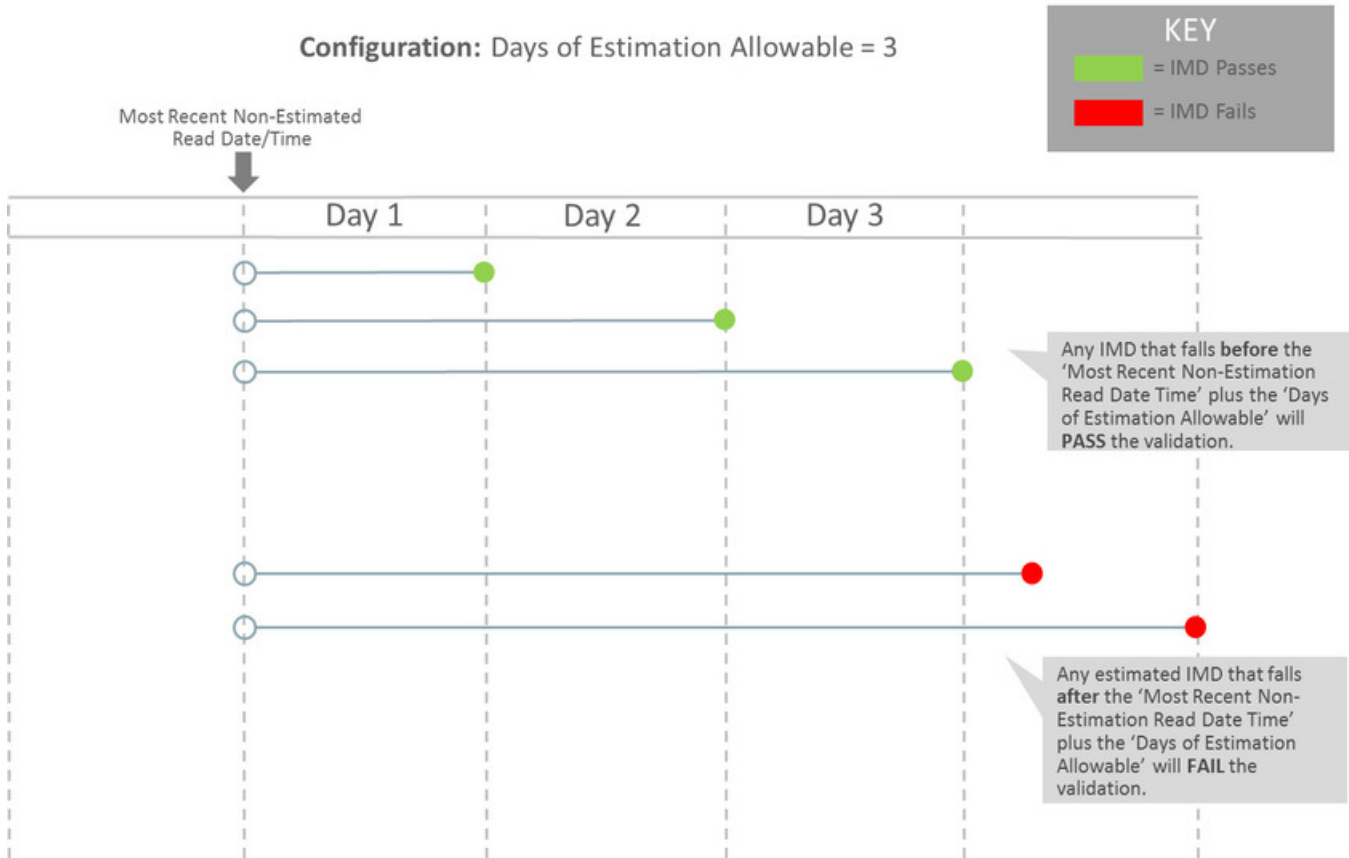

## Raise Missing Quantity Exception

This rule flags any missing interval data while providing a soft parameter on the algorithm to exclude a condition range if desired.

---

### NOTE:

Additional detail on the logic of this rule can be found in the Detailed Description of the [D2-RAIMISQTY](#) Algorithm Type.

For help with the meaning of specific configuration fields, refer to the embedded help on the screen when adding or editing the rule.

---

## Business Object

D2-RaiseMissingQuantityExcp

## Sum Check

This rule evaluates whether consumption for the current Initial Measurement Data is within a tolerance of the sum of the consumption during the same period for any measuring components related to the current one. If the values are not within the defined tolerance of each other, and exception is logged.

The rule can be used to evaluate consumption totals for an interval measuring component that has a related scalar measuring component with the same UOM to ensure that the total consumption of the interval measuring component is within a tolerance of that of the scalar value. It can also be used to evaluate consumption totals for scalar TOU meters that have a "check" register (for example, three registers that measure ON-PEAK, OFF-PEAK, and SHOULDER, with a fourth check register that measures the total consumption).

---

**NOTE:**

Additional detail on the logic of this rule can be found in the Detailed Description of the [D2-SUM-CHK](#) Algorithm Type.

For help with the meaning of specific configuration fields, refer to the embedded help on the screen when adding or editing the rule.

---

## **Business Object**

D2-SumCheck

## **Unit of Measure Check**

This rule checks the unit of measure (UOM) passed in with the Initial Measurement against the primary unit of measure configured on the measuring component's type.

---

**NOTE:**

Additional detail on the logic of this rule can be found in the Detailed Description of the [D2-UOMCHK](#) Algorithm Type.

For help with the meaning of specific configuration fields, refer to the embedded help on the screen when adding or editing the rule.

---

## **Business Object**

D2-UOMCheck

## **Zero Consumption Check**

This rule checks if the total consumption for the IMD is zero. There is also a check for whether an outage occurred during the same time as the zero consumption to provide ways to avoid To Dos by having a different exception type.

---

**NOTE:**

Additional detail on the logic of this rule can be found in the Detailed Description of the [D2-ZEROCNCHK](#) Algorithm Type.

For help with the meaning of specific configuration fields, refer to the embedded help on the screen when adding or editing the rule.

---

## **Business Object**

D2-ZeroConsumptionCheck

## **Estimation VEE Rules**

## Interval Adjustment From Scalar

This rule adjusts interval Initial Measurement Data based on scalar values using one of two options configured on the VEE Rule. Both options require that a scalar measuring component be related to the current interval measuring component using the Consumption Reference Measuring Component, and that one or more final measurements be present for the related measuring component between the start and end date/times of the current Initial Measurement Data set.

1. Adjust all intervals. In this case, the scalar consumption provides a value that is then used to proportionally adjust all of the intervals in the set. The formula used is  $(\text{Scalar Consumption} / \text{Total Initial Measurement Consumption}) * \text{Interval Amount}$ . If the total of all of the intervals had been equal to zero originally, the rule adjusts all of the intervals to the same value.
2. Adjust intervals based on condition. For this option, a range of conditions is configured on the VEE Rule, and the rule adjusts only those intervals with conditions that lie within the configured range. The adjustment is done by applying an adjustment factor to each of the intervals within range.

---

**NOTE:**

Additional detail on the logic of this rule can be found in the Detailed Description of the [D2-INTADJSCA](#) Algorithm Type.

For help with the meaning of specific configuration fields, refer to the embedded help on the screen when adding or editing the rule.

---

### Business Object

D2-IntervalAdjustmentFrmScalar

## Interval Averaging Estimation

The algorithm estimates when the current Measuring Component is eligible. Estimation is performed only if all these conditions are satisfied:

- The Measuring Component is interval.
- The Measuring Component is linked to a Service Point or the VEE Rule's Estimate If Not Attached to SP field is set to "Estimate".
- The Percentage of Missing Intervals is less than the VEE Rule's Maximum Percentage Missing Intervals Threshold.

The algorithm will compute the Total Accumulated Consumption and the Total Number of Intervals using a variety of methods including scanning holidays, similar days of the week, or neighboring days. Once a set of valid comparison days are found then these are used as the basis of creating estimated intervals for the current IMD.

---

**NOTE:**

Additional detail on the logic of this rule can be found in the Detailed Description of the [D2-INTAVGEST](#) Algorithm Type.

For help with the meaning of specific configuration fields, refer to the embedded help on the screen when adding or editing the rule.

---

### Business Object

D2-IntervalAveragingEstimation

## Interval Create Estimation IMD for Gap

This rule is very different from other VEE rules in that it does not examine the current initial measurement but rather looks to see if there are any missing measurements prior to the initial measurement being processed (i.e. a gap exists). If so and the scenario meets the configured options it will generate an estimation initial measurement to fill in that gap.

This rule is intended to provide more real-time filling of missing measurements as opposed to running periodic estimation. However, it is still expected that periodic estimation will be used in conjunction with this rule such that any gaps that are not filled in by this rule would eventually be filled in by periodic estimation.

This rule can be configured to perform minimal validation of that gap that is identified and defer to the estimation initial measurement to validate against other initial measurements and final measurements that may overlap the gap. Conversely, it can also be configured to validate the gap and exclude any periods where a final measurement or in progress initial measurement overlaps the gap's duration.

---

### NOTE:

This estimation rule acts differently from the other rules - it creates a new IMD rather than filling in missing values in an estimation IMD created from periodic estimations.

Additional detail on the logic of this rule can be found in the Detailed Description of the [D2-CREESTIMD](#) Algorithm Type.

For help with the meaning of specific configuration fields, refer to the embedded help on the screen when adding or editing the rule.

---

## Business Object

D2-CreateEstimationIMDRule

## Example Scenarios

The following are sample scenarios that can be achieved based on configuration of this rule.

**Example 1:** A 4-hour gap exists and the rule is configured to always fill gaps. Maximum hours are set to 4 and the gap fill is set to "always".

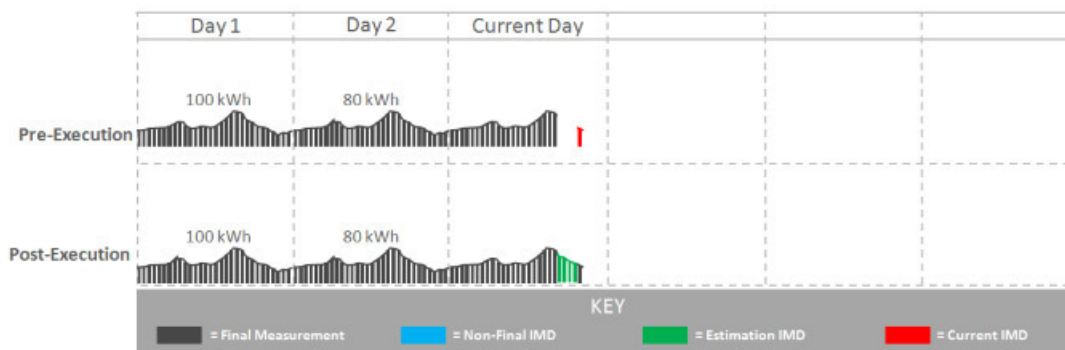

Since the maximum hours has not been exceeded and the rule is configured to always fill the gap, a 4-hour estimation IMD is created to fill the gap.

**Example 2:** A 4-hour gap exists and the rule is configured to always fill gaps. However, the maximum number of hours to fill is 3.

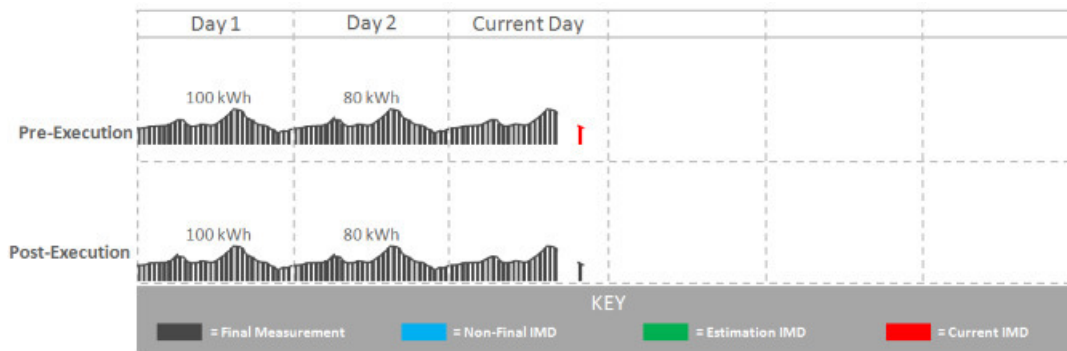

Since the gap is 4 hours long and the maximum hours to gap fill is 3 hours, no estimation has been created. An exception would be created if the rule were configured this way.

**Example 3:** A non-contiguous gap exists and the rule is configured to "Skip In-Progress IMDs and Final Measurements" with a maximum number of IMDs set to 2.

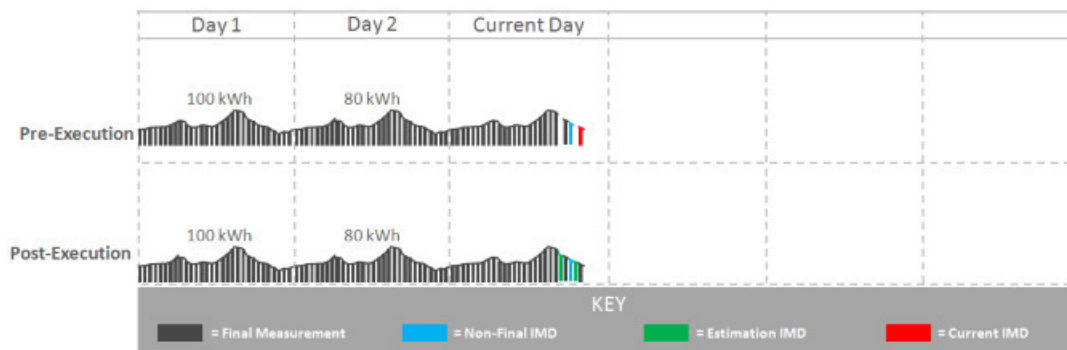

In this scenario:

- One interval in the 4-hour gap is covered by a final measurement.
- One interval in the 4-hour gap is covered by an in-progress IMD.
- Two estimation IMDs are generated one to fill each hour not covered by a final measurement or in-progress IMD.

## Interval Interpolation Estimation

This rule attempts to interpolate gaps in Initial Measurement Data sets using prior and subsequent intervals as starting points for linear interpolation. A configuration parameter determines the maximum number of consecutive intervals within a gap before that gap can no longer be interpolated.

If a given gap lies at the beginning or end of the Initial Measurement Data set, this algorithm seeks out final measurements immediately before or after the set in an attempt to find two reference measurement values for interpolation. In this situation, assuming that the condition of the measurement retrieved lies in NEITHER of the algorithm parameter ranges you have configured (the measurement is neither "missing" nor an "outage"), this measurement value is then used as the basis for interpolation.

In the event that the gap is the entire length of the Initial Measurement Data set (and the VEE Rule is configured such that this is not too large of a gap), the routine attempts to find final measurements as described above.

If a valid measurement can be found for only one side of a given gap, the interpolation logic assigns each interval in the gap the same value - the value of the measurement retrieved. This is referred to as applying a "flat load".

### NOTE:

Additional detail on the logic of this rule can be found in the Detailed Description of the [D2-INTINTEST](#) Algorithm Type.

For help with the meaning of specific configuration fields, refer to the embedded help on the screen when adding or editing the rule.

---

## Business Object

D2-IntervalInterpolationEst

## Interval Profile Estimation

This rule uses a profile measuring component's interval consumption as a source of values to assign to intervals in the current Initial Measurement Data set that are marked "missing" via the interval's condition. If the interval is marked with a condition indicating "outage", the algorithm skips it.

If a measurement is not available for the profile measuring component on the date/time, the interval is left unchanged.

---

### NOTE:

Additional detail on the logic of this rule can be found in the Detailed Description of the [D2-INTPROEST](#) Algorithm Type.

For help with the meaning of specific configuration fields, refer to the embedded help on the screen when adding or editing the rule.

---

## Business Object

D2-IntervalProfileEstimation

## Interval Proxy Day Estimation

This rule checks for days with similar temperature and uses the measurement data from those days as the basis of interval estimation for the in-flight initial measurement. [Measuring component comparison periods](#) are used as the main driver for determining similar temperature days.

---

### NOTE:

Additional detail on the logic of this rule can be found in the Detailed Description of the [D2-INTPROXY](#) Algorithm Type.

For help with the meaning of specific configuration fields, refer to the embedded help on the screen when adding or editing the rule.

---

## Business Object

D2-IntervalProxyDayEstimation

## Scalar Calculation From Interval

This rule calculates a single consumption amount for a scalar measuring component's Initial Measurement using the total consumption for the same date/time range for a related interval measuring component.

The scalar value replaces any existing value within the Initial Measurement (in the post-VEE list) and updates the condition to the value configured on the VEE Rule. This VEE Rule updates the condition to the value defined in "Condition Value for High Quality Condition" when the measurement condition value for all underlying interval data and the previous scalar measurement (when Evaluate Condition Of Previous Scalar Measurement is configured as "Yes") is greater than or equal to the "Minimum Condition Quality to Override" (If "Minimum Condition Quality to Override" is defined) otherwise it updates the measurement condition of the Initial Measurement Data to the condition defined in "IMD Created Condition Value".



---

**NOTE:**

Additional detail on the logic of this rule can be found in the Detailed Description of the [D2-SCACALINT](#) Algorithm Type.

For help with the meaning of specific configuration fields, refer to the embedded help on the screen when adding or editing the rule.

---

**Business Object**

D2-ScalarCalcFromInterval

**Scalar Estimation**

This rule uses historical data for the same measuring component to derive an estimated value for a scalar Initial Measurement. Depending upon a VEE Rule configuration parameter, the routine uses historical data from a month ago followed by a year ago, or vice-versa. If the data for the first historical period turns out to be usable, the second historical period will not be evaluated. Whether historical data qualifies for use in estimation is configured via the rule parameters in conjunction with the below algorithm parameters.

The rule rejects consumption from a historical period as unusable for estimation if too great a portion of the period is covered by final measurements that are not high-quality. The first pair of parameter values are used when evaluating the acceptable System-Estimated Percentage for historical periods as configured on the VEE Rule. Once an estimated value is calculated, the routine backs into a reading (which involves backing out multipliers and, if the measuring component is subtractive, adding the result to the prior reading).

An interim High/Low can also be configured on this rule.

---

**NOTE:**

Additional detail on the logic of this rule can be found in the Detailed Description of the [D2-SCALAREST](#) Algorithm Type.

For help with the meaning of specific configuration fields, refer to the embedded help on the screen when adding or editing the rule.

---

**Business Object**

D2-ScalarEstimation

**Scalar Profile Estimation**

This VEE rule arrives at a scalar estimate by looking at final measurements for a profile measuring component covering the same date range as the current Initial Measurement. The profile measuring component to be used as a source of measurement data is defined via a profile factor on the rule. This rule is meant primarily for a configuration in which the profile measuring components are interval, although the profile could be scalar as well.

If a measurement already exists in the current Initial Measurement with a condition that lies within the ranges specified in the pairs of algorithm parameters for "system estimate" and "regular", the routine does not attempt to estimate.

---

**NOTE:**

Additional detail on the logic of this rule can be found in the Detailed Description of the [D2-SCAPROEST](#) Algorithm Type.

For help with the meaning of specific configuration fields, refer to the embedded help on the screen when adding or editing the rule.

---

## Business Object

D2-ScalarProfileEstimation

## Scalar Proration

This rule prorates the value of a scalar reading that has two valid scalar readings on either side as boundaries.

If the scalar MC does have a related interval MC and 'Minimum Related Measurement Condition' is defined the algorithm will take into consideration any intervals during the proration period that meet a minimum condition quality defined by the 'Minimum Related Measurement Condition' when performing the proration. This is to keep the prorated scalar estimates in sync with any existing interval measurements. To do this the algorithm will augment the total duration and total quantity being prorated by the related interval MC's qualifying measurements. For example, take the following scenario:

- Scalar proration is executing for a scalar IMD for 01/01 12:00 AM - 01/02 12:00 AM (24 hours)
- The subsequent measurement is for 150 kWh and has a measurement date/time of 01/04 12:00 AM (72 hours)
- The related interval MC has measurements on 01/03 12:00 AM to 01/04 12:00 AM totally 100 kWh (24 hours)

Therefore the result of the calculation for the scalar IMD from 01/01 12:00 AM to 01/02 12:00 AM would be 25 kWh. Since the interval measurements covered 24 of the 72 total hours of the 150 kWh that would leave 50 kWh to be split among the remaining 48 hours. Which leaves 25 kWh for 01/01 12:00 AM to 01/02 12:00 AM and 25 kWh for 01/02 12:00 AM to 01/03 12:00 AM.

---

### NOTE:

Additional detail on the logic of this rule can be found in the Detailed Description of the [D2-SCLRPRORT](#) Algorithm Type.

For help with the meaning of specific configuration fields, refer to the embedded help on the screen when adding or editing the rule.

---

## Business Object

D2-ScalarProration

## Subtractive Interval Adjustment Rule

This rule adjusts qualifying consecutive intervals for a subtractive interval initial measurement (IMD) based on the known consumption between a set of actual readings. The readings can either be leveraged from other intervals within the IMD or from the final measurements when there are no suitable readings within the IMD. The adjustment is done by applying an adjustment factor to each of the qualifying intervals.

The rule supports adjusting multiple sets of qualifying consecutive intervals by calculating a consumption adjustment target and adjustment factor specific to each set of consecutive qualifying intervals.

Intervals are considered to be qualified for adjustment based on condition. A range of conditions is configured on the VEE Rule, and the rule adjusts only those intervals with conditions that lie within the configured range.

---

### NOTE:

Additional detail on the logic of this rule can be found in the Detailed Description of the [D2-SUBINADJV](#) Algorithm Type.

For help with the meaning of specific configuration fields, refer to the embedded help on the screen when adding or editing the rule.

---

## Business Object

D2-SubIntAdjustmentVEE

## Decision-Making VEE Rules

### Exception Handler

This rule allows you to terminate the VEE process based on a configurable set of exceptions being present for the IMD. This rule also allows a unique To Do Type to be generated based on a group of exceptions.

---

**NOTE:**

Additional detail on the logic of this rule can be found in the Detailed Description of the [D1-AVEER-EEH](#) Algorithm Type.

For help with the meaning of specific configuration fields, refer to the embedded help on the screen when adding or editing the rule.

---

## Business Object

D1-VEERuleExceptionHandler

### Execute VEE Group

Many implementations need to execute a group of validations for any data being received. For example, you might want to perform device identifier validations, multiplier checks, and UOM checks on all measuring components. One inefficient way to meet this requirement would be to repeat these three rules in multiple VEE groups. However, this solution becomes hard to maintain if changes to the rules are required (or if new "global rules" are introduced) as each group would have to be updated. Instead of this, you can use the "Execute VEE Group" rule to execute a referenced VEE Group. Using the example above, you could create a group called "Rules for All MCs" that contains a device identifier validations rule, a multiplier check rule, and a UOM check rule, and then reference the "Rules for All MCs" group in a Execute VEE Group rule.

---

**NOTE:**

Additional detail on the logic of this rule can be found in the Detailed Description of the [D1-AVEER-RFG](#) Algorithm Type.

For help with the meaning of specific configuration fields, refer to the embedded help on the screen when adding or editing the rule.

---

## Business Object

D1-VEERuleReferredVEEGroup

### Successful Termination

This rule allows VEE to be successfully terminated based on a list of exceptions.

---

**NOTE:**

Additional detail on the logic of this rule can be found in the Detailed Description of the [D1-AVEER-EST](#) Algorithm Type.

For help with the meaning of specific configuration fields, refer to the embedded help on the screen when adding or editing the rule.

---

## Business Object

D1-VEERuleSuccessTermination

## VEE Group Matrix (Factor)

Another situation likely to occur in many implementations is where specific rules may need to be applied to measurement data based on specific criteria, such as geography. For example, some geographic territories may have unique VEE Rules in addition to rules that are applied to all geographic territories. The "VEE Group Matrix (Factor)" rule allows for a Factor to determine which VEE Rule gets executed based on defined characteristics.

---

### NOTE:

Additional detail on the logic of this rule can be found in the Detailed Description of the [D1-AVEER-FCT](#) Algorithm Type.

For help with the meaning of specific configuration fields, refer to the embedded help on the screen when adding or editing the rule.

---

## Business Object

D1-VEERuleGroupFactor

## Prerequisite Setup

Since the prerequisite setup items for this rule are more involved, the following procedure describes these in detail:

1. Create the Characteristic Type and Values to be used by the factor that will be referenced by the rule.
2. Create the Characteristic Source Algorithm to be used by the factor that will be referenced by the rule.
3. Create the VEE Groups to be associated to the characteristic values.
4. Create the Factor that will be referenced by the rule.
5. Create the Factor Values for the factor, each referencing an effective-dated characteristic value/VEE group pairings.
6. Create the rule, referencing the factor

## Measuring Component Statistics

### Understanding Measuring Component Statistics

Oracle Utilities Meter Data Management provides a way to stage statistics for Measuring Components in order to speed up VEE processing. These statistics are primarily meant for use in conjunction with the [Dynamic Comparison Validation](#) VEE Rule, but could also be generated for other analytics or reporting.

Some of the potential benefits of using Measuring Component Statistics are:

- Reduce the data volume for VEE queries by up to 1000 times (this is most beneficial when replacing VEE Rules that query historical data such as High/Low)
- Offload heavier processing of historical data to "system downtimes" - potentially nights or weekends

Below is an overview example of how Measuring Component Statistics can be implemented along with the Dynamic Comparison Validation:

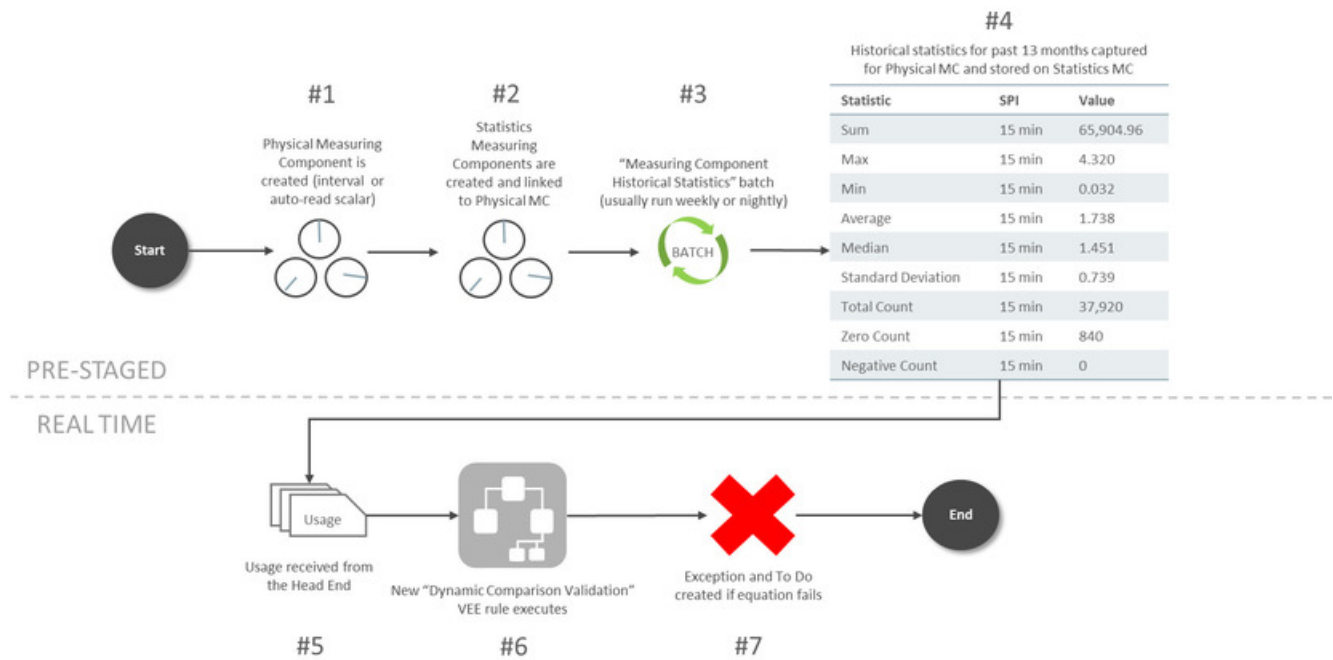

The steps for pre-staging Measuring Component Statistics are detailed below:

1. A Physical Measuring Component is created. The algorithm to trigger the creation of Statistics Measuring Components is only set on Interval or Auto-Read Scalar BOs as part of base product.
2. New Statistics Measuring Component are created and linked to the Physical Measuring Component.
3. The Measuring Component Historical Statistics Batch ([DI-MCHS](#)) is run based on the schedule you've defined. The suggestion is to run this either nightly or on the weekends during quieter times for overall system processing.
4. A measurement is created for the Statistics Measuring Component that holds historical statistics related to the Physical Meter for a specific period of time (in this example it's set for 13 months).

The steps for how VEE can take advantage of Measuring Component Statistics are detailed below:

1. IMDs are received from the Head End.
2. The [Dynamic Comparison Validation](#) VEE Rule is configured to execute for the meter. This validation uses the historical statistics from the Statistics Measuring Component in order to perform its validation logic.
3. An exception and potentially a To Do is generated based on the failure of the VEE rule.

## Storage Impact from Statistics

Much consideration was given to the storage implications when designing Measuring Component Statistics. Below is an outline of the storage impact to customers who choose to calculate and store Channel Statistics. An example impact to a utility with 1 million Physical Meters (each with 4 channels of information) is shown in the far right column:

Area	Additional Data in MDM	Example Impact
		(assuming utility has 1 million Physical Meters)
<b>Additional MCs</b>	1-3 extra MCs per Physical Meter	1 - 3 million extra MCs

<i>Assumption: Statistics are only configured on the primary billing channel MC Type for the majority of your Physical Meters.</i>	<i>Assumption: customers will only configure Statistics on their primary billing channel MC Type for the majority of their Physical Meters.</i>	<i>This increases the Measuring Component table by an extra 25% to 75% from its size without statistics.</i>
<b>Additional Measurements</b> <i>If 'Statistics Retention Mode' configured as "Only Retain Most Recent Record".</i>	1 extra Measurement per Physical Meter	1 - 3 million extra Measurements for the life of MDM  <i>This data is a minuscule fraction compared to the overall AMI data footprint.</i>
<b>Additional Measurements</b> <i>If 'Statistics Retention Mode' configured as "Retain Historical Records".</i>	1 extra Measurement per Physical Meter per week	1 - 3 million extra Measurements per week (52-156 million per year)  <i>This data is 0.2-0.5% of the size of the AMI data collected in that same week.</i>

## Configuring Measuring Component Statistics

### Measuring Component Types

In order to start generating Measuring Component Statistics, two different configurations must occur for [Measuring Component Types](#):

- New Measuring Component Types must be configured that leverage the **Channel Statistics Type** business object. These should be setup as the periods for which Measuring Component Statistics should be calculated. For example, if you would like to be able to reference both last month, last year, as well as the past 13 months as statistics periods, then 3 different Channel Statistics Types must be setup for this. These could be setup as follows:
  - "Last Month" Channel Statistics Type:
    - Period End Lag Days = 0
    - Period Start Lag Days = 30
  - "Same Month Last Year" Channel Statistics Type:
    - Period End Lag Days = 365
    - Period Start Lag Days = 395
  - "Prior 13 Months" Channel Statistics Type:
    - Period End Lag Days = 0
    - Period Start Lag Days = 395

**NOTE:** *it's recommended to set the Statistics Retention Mode to "Only Retain Most Recent Record" on the Channel Statistics Type to reduce the amount of data being stored in Oracle Utilities Meter Data Management.*

- For a Physical Measuring Component Type leveraging either "Interval Channel Type" or "Register - Auto-Read Type", the **Related Statistics Measuring Component Types** section must be filled in with the appropriate types that should be created for the Physical Measuring Component.

### VEE Rule

If you have a desire to leverage Measuring Component Statistics for VEE, the [Dynamic Comparison Validation](#) VEE Rule section should be referenced. A number of detailed examples of how to implement this rule are provided in this section as well.

### Related Batch Controls

There are a few batches directly involved with Measuring Component Statistics:

- **Measuring Component Historical Statistics (D1-MCHS)**: this batch monitors any active Statistics Measuring Components to execute the logic for calculating a new set of historical statistics.
- **Statistics Measuring Component Creation (D1-STMCC)**: this batch is used to create Statistics Measuring Components on any Physical Measuring Components that were created prior to configuring this module. This is especially useful for existing customers that want to implement Statistics Measuring Components for all of their devices.

---

**NOTE:** Refer to [Understanding Measuring Component Statistics](#) for more information.

---

## Defining Usage Options

This section describes concepts and common tasks related to usage administration.

## The Big Picture of Usage Requests

Oracle Utilities Meter Data Management is used by some organizations who use a meter data management (mdm) system to record meter reading information. Since meter reads are not available in Oracle Utilities Customer Care and Billing to calculate consumption during the billing process, usage (or bill determinants) must be requested by Oracle Utilities Customer Care and Billing from the mdm system, Oracle Utilities Meter Data Management.

The following sections describe how the base-package usage request process works.

## Requesting Bill Determinants

The term bill determinant request is another way to refer to a usage request. These usage requests are created during the batch billing process, and also when a user generates an online bill segment or performs cancel / rebill. The get consumption algorithm specified on the SA Type's Bill Segment Type is responsible for creating the usage request.

## Online Billing Usage Requests

- Usage requests created from an online billing request are not held in the initial state. These usage requests are transitioned through their lifecycle resulting in the request being sent to Oracle Utilities Meter Data Management (MDM) and, once a response is received, the bill segment is regenerated.
- The bill segment remains in the Freezable state until the user freezes the bill segment and completes the bill. If the freezable bill segment is regenerated, however, the system cancels the usage request and creates another usage request for the bill segment.
- In addition to the standard MDM usage request elements, the system captures the responsible user id.

## Usage Request Lifecycle

The usage request business object (BO) contains the rules that govern the processing of a usage request. The base product provides the BO C1-UsageRequest which serves as a parent BO and contains the following lifecycle:

- All usage requests are created in the initial Pending state. If the usage request was created from the batch billing process, the batch Usage Scheduled Monitor Process must be executed to transition the usage request.

- If there are pending sync requests for the usage request's service agreement, the usage request is held in the Awaiting Data Sync state until the sync is processed.
- Once all pending sync requests related to the usage request have been processed, the usage request transitions to the Send Request state. An enter algorithm on this transitory state is responsible for sending the usage request to Oracle Utilities Meter Data Management (MDM).
- The usage request sits in the Awaiting Bill Determinants state until a response is received from MDM, or a time out is encountered.
- When a response is received from MDM, the usage request is transitioned to either the Bill Determinants Received state, or the Error state. In the case of an error, the following occurs:
  - If the usage request was created from the batch billing process and the billing window is still open, a new usage request will be created the next time billing runs and the process is repeated. If however, the billing window is no longer open, a to do entry is created for manual follow up.
  - If the usage request was created from an online billing process, the user will be notified. The bill segment remains in the error state and the user can either delete the bill segment, or attempt to generate it again. If the bill segment is regenerated, a new usage request is created and the process is repeated.
  - The system transitions usage requests in the Bill Determinants Received state to the Bill Determinants Processed state. An enter algorithm on this final state is responsible for generating the bill segment. If the usage request was created from the batch billing process, the bill segment is frozen and the bill is completed. For online billing usage requests, the user is responsible for freezing the bill segment and completing the bill.

## Summary Billed Accounts and Usage Requests

A "summary" account refers to an account with service agreements that cover more than one premise. If these premises are linked to service points that span different measurement cycle routes scheduled for reading on different dates, there's no guarantee that all the account's SAs will be billed at the same time. This is because batch billing for manually read meters is based on the meter's scheduled reading date.

For example, assume a summary account has two SAs each linked to a different premise. One is on route X, scheduled for reading every first of the month and the other is on route Y, scheduled for reading every 20<sup>th</sup> of the month. Assume that the account's bill cycle is cycle X (which matches the schedule of premise/SP on route X). When billing runs on the first of the month, the service agreements tied to route Y won't have any reads. And because route Y is not scheduled for reading, the system will not estimate the consumption. Instead, it will skip billing the route Y SAs until the next month. This means some SAs are always one billing cycle behind.

## Requesting Bill Determinants for Summary Billed Accounts

Usage requests for summary billed accounts are handled as follows:

- On the first night of the billing window usage requests are created for each SA and sent to Oracle Utilities Meter Data Management (MDM). MDM then checks what the next schedule read date is for each service point.
- Assuming Oracle Utilities Meter Data Management owns meter read schedules; when batch billing executes Oracle Utilities Customer Care and Billing (CCB) cannot determine whether a summary account's service agreement should be included on the bill or not.
- If MDM determines that an SA/usage subscription should be skipped from billing, it notifies CCB by including a skip indicator and reason on the usage response, as well as the SA's next scheduled read date. This date is captured as a **MDM Next Scheduled Read Date** characteristic on the SA, and the usage request is cancelled. The system still attempts to complete the bill since this might be the last outstanding usage request for the bill
- When billing next runs, the base *Get bill segment consumption using a usage request* algorithm first checks if the SA should be skipped as follows (Note that this check is also performed in first billing run):



- Get the *MDM Next Scheduled Read Date* characteristic on the SA. If this date is after the bill segment end date, we'll skip the SA from billing

If your implementation would like to wait until the bill cycle window end date before attempting to complete summary account's bills, ensure that the *Complete Bill at End of Bill Cycle* pre-bill completion algorithm is defined on customer class. This is useful if scheduled reads are expected in the bill cycle window, but not necessarily on the window start date.

## Corrected Read Notifications

If a read that was used for bill determinant calculations is modified in the mdm system, notification is sent to Oracle Utilities Meter Data Management.. Resulting in the creation of an off cycle bill generator. The system uses the business object defined as the OCBG Corrected Read BO MO option on the Off Cycle Bill Generator maintenance object to create the OCBG.

What happens next depends on the lifecycle that your implementation has configured for the OCBG Corrected Read BO. Here are examples of what might occur:

- Create a To Do entry for manual follow up.
- Find any frozen bill segments that might be affected by the corrected read and perform cancel/rebill.

## Configuring The System For Usage Request Integration

Oracle Utilities Customer Care and Billing sends usage requests to Oracle Utilities Meter Data Management (MDM) in the form of an xml message. MDM sends responses back to Oracle Utilities Customer Care and Billing.

The following sections describe at a high level the data setup required to send usage requests to MDM.

## Start and End Times for Billing

As you know, there is logic in billing to determine the start date and end date for a bill segment. Refer to [Ways To Control The Start Date Of A Bill Segment](#) and [Ways To Control The End Date Of A Bill Segment](#) for more information. When billing for a customer with interval data, the system also needs to know the time.

The time used by billing, referred to as the cutoff time, is stored on the service agreement. There is also a control on the service agreement called Start Day Option that determines which day to use for the start time. Billing uses the billing date, the cutoff time, and the start day option to determine the correct interval data to process.

Oracle Utilities Customer Care and Billing lacks knowledge of the type of meter installed at a service point. Thus, both interval processing period as well as scalar processing information is captured on a usage request. Oracle Utilities Meter Data Management (MDM) then uses the appropriate period to calculate bill determinants based on the type of meter installed.

MDM returns the true usage period used to calculate bill determinants on the usage response. This usage period is captured on the bill segment.

## The Big Picture of Time of Use Mapping and Pricing

This section provides an overview of the concepts related to setting up your control tables to support time of use mapping and pricing with the rates.

---

**NOTE:** Time of use mapping is supported to enable low volume interval data manipulation (for example, for mapping electric vehicle charging events into time of use quantities). A meter data management application, such as Oracle

Utilities Meter Data Management, must be used to manipulate high volumes of interval data and calculating bill determinants for billing purposes.

## Mapping to Time of Use (TOU) Periods

Many customers choose not to price their interval data using interval prices. Customers may choose for their interval data to be mapped into time of use (TOU) periods. This option for interval data might be preferred because:

- Typically it involves fixed prices for the use periods
- It is more manageable than direct billing
- It is easier for a customer to forecast and budget

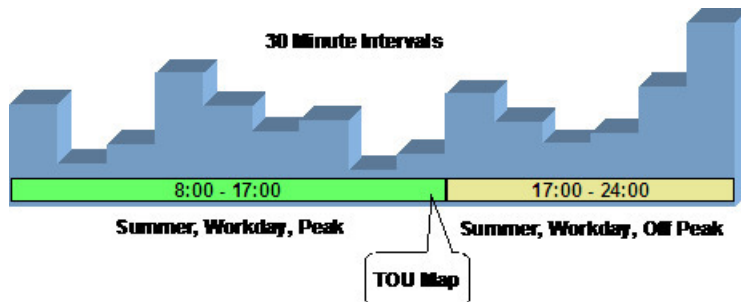

A TOU map's purpose is to define the TOU codes for a collection of time period definitions (i.e. given dates and times). The TOU Map has a TOU Map Type, which defines the interval size between TOU map data rows.

Time of use periods can (and often do) change during the year.

Map #123 (TOU Group 2)	
Effective 1 Jan 2000	
Interval Date/Time	
30/Apr/00 16:30	On Peak/Winter
30/Apr/00 16:45	On Peak/Winter
30/Apr/00 17:00	Off Peak/Winter
30/Apr/00 17:15	Off Peak/Winter
---	
01/May/00 7:45	Off Peak/Summer
02/May/00 8:00	On Peak/Summer
02/May/00 8:15	On Peak/Summer
---	

All the possible TOU codes for a given map are grouped together in a TOU group. Refer to [Grouping of TOU Codes for TOU Mapping](#) for more information.

## Grouping of TOU Codes for TOU Mapping

This section describes the relationship between TOU Codes and TOU Mapping.

## Overview of TOU Codes and TOU Mapping

A TOU map's purpose is to define the TOU codes for a collection of time period definitions (i.e. given dates and times).

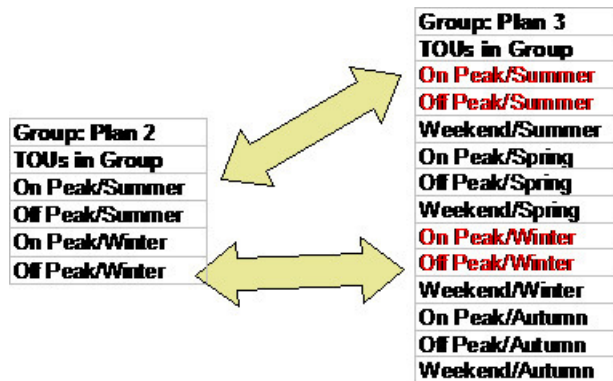
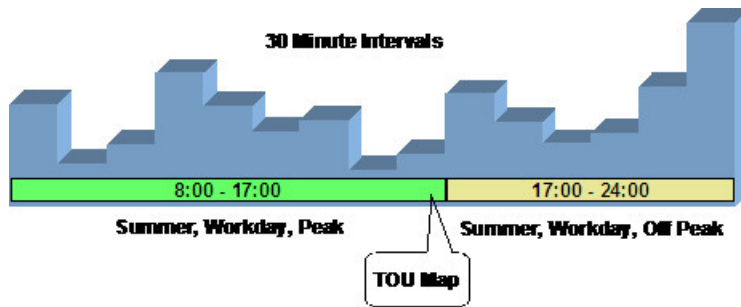

## TOU Sequence for TOU Mapping and Pricing

If desired, you may use sequence number to indicate the relative position or relative priority of each TOU code within a TOU group. This sequence number is not used by any system functionality, but is available for you to use in a plug-in algorithm.

## Time of Use (TOU) Mapping and Pricing

The following section describes the logic used by the system to map an interval data curve to TOU periods using a TOU map, and subsequently apply prices to these mapped quantities.

At some point during billing, the system will take an interval data curve and will map the interval values to TOU periods based on a TOU Map. The interval data curve is retrieved from either a specific usage request or from the new rate engine buffer populated prior to calling the rate engine.

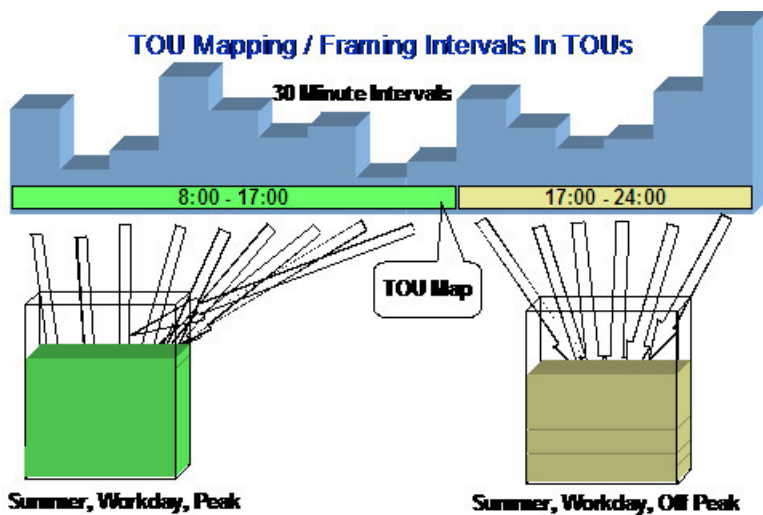

This type of data manipulation is typically handled using a calculation rule based on the 'math' calculation rule type.

Once the interval data curve values have been mapped to TOU periods, prices can be applied to the time of use period quantities using calculation rules based on the 'service quantity' calculation rule type.

## Calculation Rules for TOU Mapping & Pricing

Calculation Rules are used to perform time of use mapping and time of use pricing.

### Time of Use Mapping

Time of use mapping will be typically handled using a calculation rule based on the 'math' calculation rule type. Calculation rules of this type can perform many functions. Two examples include:

- Applying a TOU map to an interval data curve to produce service quantities that will be added to the bill segment's SQ collection.
- Applying a TOU map to a derived interval data curve. For example, after deriving the power factor curve, perform TOU mapping on the resultant curve.

For further details on the 'math' calculation rule type, refer to [Base Package Math Calculation Rule](#) for more information.

### Time of Use Pricing

Time of use pricing will be typically handled using calculation rules based on the 'service quantity' calculation rule type. Calculation rules of this type can perform many functions. For example:

- Add or update a service quantity in the bill segments SQ collection
- Create bill calculations lines that levy charges based on some type of consumption. For example, applying a price to a specific service quantity in the bill segment's SQ collection

For further details on the 'service quantity' calculation rule type, refer to [Base Package Service Quantity Calculation Rule](#) for further information.

---

**NOTE:** Calculation rules are implemented using algorithms that contain the logic to be performed. If your implementation requires a new type of calculation rule, you can configure a new calculation rule type and reference the appropriate algorithm on it.

---

## TOU Map Used For Mapping

An interval data curve is mapped into time-of-use periods using a TOU map. The TOU map used by the calculation rule for mapping interval data curve values to time of use periods is defined directly on the calculation rule.

### Attributes of TOU Maps

TOU map types define attributes shared by TOU maps of a given type. The essential attributes of any TOU Map Type are the interval sizes between TOU map data rows, associated TOU map template(s) to use, and whether the TOU data will follow any seasonal time shifting.

## Designing Your Time of Use (TOU) Mapping and Pricing Options

This section provides an overview for designing your control tables to support time of use (TOU) mapping and pricing with the new rating engine.

### Designing Your Time Of Use (TOU) Mapping and Pricing Calculation Rules

As you know from the rates chapter, the system can handle mapping of interval data curve values into different time of use periods and pricing these quantities using the 'math' and 'service quantity' calculation rule types respectively. Refer to [Base Package Calculation Rule Descriptions](#) for more information.

The following guidelines provides a high level outline on how you should go about designing a rate schedule that involves time of use mapping and pricing.

- Obtain copies of existing bills that use the rate in question. If the rate is new, then write up exactly how the information should appear on the customers' printed bills.
- Identify all the lines that represent charges for individual time of use periods.
- Determine how the quantities for the time of use periods are calculated. Which time of use map is used to define the time periods?
- In order to perform time of use mapping and pricing, calculation rules need to be designed
  - A calculation rule based on the 'math' calculation rule type may be used to map an interval data curve into time of use periods. This calculation rule must know the TOU map to apply to the interval data curve to map into the relevant time of use periods. The time of use period quantities are populated in the bill segments SQ collection.
  - Calculation rules based on the 'service quantity' calculation rule type may be used to apply prices to each mapped time of use period quantity. These calculation rules each require either a price or regular bill factor for pricing each time of use period quantity. The bill factor may contain the price directly, or may indicate that the price is customer specific and can be found as contract quantities for the service agreement.

Once you have your calculation rules designed, you will be able to design the other control tables needed to set up your time of use billing customer.

### Designing Your TOU Codes for TOU Mapping

The next most logical step in designing your time of use mapping controls is to define your time of use codes. To do this, look at the time of use periods to which your usage needs to be mapped. These values will likely correspond to the time of use quantities that your rate bills for. It should be noted that it's possible that will not bill for every time of use period.

## Designing Your TOU Groups for TOU Mapping

To further aid in designing time of use mapping, the TOU Group enables you to group together all the time of use codes that are available to be used in a single map. You must also decide if you want to use a sequence number to define the relative order of a TOU code within a TOU group.

When TOU data is created for a TOU map, only TOU periods defined on a specified TOU group can be specified.

## Designing Your TOU Map Types for TOU Mapping

Now that you have your TOU groups defined, you can begin defining TOU map types. Recall that the TOU map type defines the attributes that may be shared by TOU maps of the same type.

The essential attributes of any TOU Map Type are the interval sizes between TOU map data rows, associated TOU map template(s) to use, and whether the TOU data will follow any seasonal time shifting. Refer to [Designing Your Time Options](#) for more information.

### TOU Map Type Interval Size

The interval size of a TOU map must divide evenly into the interval size of the interval data curve that uses the map (because the system joins the date/time of the interval data curve values to the date/time of the TOU data). This means that it is possible to use a 15 minute TOU map with a 60 minute interval data curve. However, it is not OK to have a 60 minute TOU map used with a 15 minute interval data curve because the join will miss 3 out of 4 interval data curve values.

### TOU Map Type Override Template

While most TOU maps will use the TOU map template defined on the TOU map type, TOU maps also support override templates. Refer to [Designing Your TOU Map Templates](#) for TOU Mapping for more information.

- A TOU map's TOU map type defines the default TOU map template that's used to generate its TOU data.
- A TOU map's type defines the TOU map templates that can be referenced on individual TOU maps to override the default template.
- An individual TOU map can have override templates. If the TOU map doesn't have an override template, the default template defined on the TOU map type is used to generate the map's TOU data.

Refer to [Creating TOU Map Types](#) for further information.

## Designing Your TOU Map Templates for TOU Mapping

In order to help your users to create and maintain data for TOU maps, you may define TOU map templates, which can be used to generate data for a TOU map. The templates may be used to define standard data for a TOU map as well as data for special periods, such as holidays. TOU map types reference TOU map templates.

Every TOU map references a TOU map template that defines the rules for generating TOU data from that TOU map. Specifically, TOU map templates define:

- The TOU group (defines the valid TOU periods for the template) used for the TOU map
- The default TOU period used for periods not explicitly defined. (This means you don't have to specify dates and times for all periods. For example, if your default TOU period is "Off Peak" you only need to define dates and days and times for On Peak or other TOU periods.)
- The specific date ranges, days of the week, and time periods designated for each TOU period. The system periodically generates TOU map data for TOU maps by interpreting the rules defined in the template.

## Holidays

Many utilities categorize consumption on holidays differently than on the day of week on which the holiday falls. For example, holiday consumption might be categorized as Off-Peak regardless of the day it falls on. TOU map templates can define rules for different TOU periods for holidays by specifying the following:

- A Work Calendar that defines when holidays start and end
- Either:
  - A Holiday TOU period for consumption on holiday
  - A Holiday TOU Map Template that defines the TOU codes to use for different times in the year

## TOU Map Template Interval Size

TOU map templates can also specify an interval size. This value specifies the duration of the individual TOU map data records, and also controls the values allowed in the Start and End Times. For example, if a TOU map template sets the interval size at 15 minutes, Start and End times must be in units of the interval size (10:00, 10:15, 10:30, etc.).

A TOU map template can be used to generate TOU map data for TOU maps whose interval size is divisible by the template's interval size. For example, a 60 minute template can be used to generate TOU data for TOU maps with an interval size of 60 minutes, 15 minutes, 5 minutes, etc. This means separate map templates are not needed for every interval size.

Refer to [Creating TOU Map Templates](#) for further information.

## Setting Up Time of Use (TOU) Mapping and Pricing Control Tables

This section provides an overview of setting up your control tables to support time of use mapping and pricing with rates.

### Creating TOU Map Templates

TOU map templates may be used to define standard data for a TOU map as well as data for special periods, such as holidays. TOU map types reference TOU map templates and used for TOU map data generation.

**Prerequisites:** You must define TOU groups and work calendars before you can create TOU map templates. Refer to the Oracle Utilities Application Framework online help for more information about creating work calendars.

To maintain existing TOU map templates, select **Admin > Usage > TOU Map Template > Search** then use standard actions to edit, duplicate, or delete a TOU map template.

To define a new TOU map template, follow these steps:

1. Select **Admin > Consumption > TOU Map Template > Add**. If your system supports more than one TOU map template business object, you will be prompted to select a business object for this TOU map template.
2. Enter a name and a meaningful description for the TOU map template.
3. Select the TOU group to be used by the TOU map template.
4. Select the default TOU for the TOU map template (from the TOU Group). This is the TOU used when creating TOU map data for dates not accounted for in the TOU Schedules section.
5. Select the work calendar for the TOU map template. Work calendars define the days of the week on which work is performed, and specify holidays.
6. Select the holiday TOU for the TOU map template (from the TOU Group).
7. Select the TOU map template used for holidays (if applicable).

8. Specify the interval size for TOU map data created from the map template. Interval size is designated as hours:minutes:seconds (HH:MM:SS)
9. To specify TOU schedule's date ranges and which TOUs should be used for this TOU map template, click the + or - sign in the TOU Schedule Section and enter or select the following:
  - Start and End Dates for a specific date range
  - Start and End Days of the Week: To add or remove Start and End Days of the Week pairs, click the + or - sign and select the appropriate weekdays
  - Start and End Times: To add or remove Start and End Times within a Start and End Days of the Week pair, click the + or - sign and enter the appropriate times
  - TOU
10. Click **Save**.

Now you can use the TOU map template when creating TOU types.

## Creating TOU Map Types

An interval data curve is mapped into time-of-use periods using a TOU map. The TOU map used by the calculation rule for mapping interval data curve values to time of use periods is defined directly on the calculation rule. TOU map types define attributes shared by TOU maps of a given type.

**Prerequisites:** You must define TOU map templates and time zones before you can create TOU map types. Refer to the Oracle Utilities Application Framework online help for more information about creating time zones.

To maintain existing TOU map types, select **Admin > Consumption > TOU Map Type > Search** then use standard actions to edit, duplicate, or delete a TOU map type.

To define a new TOU map type, follow these steps:

1. Select **Admin > Consumption > TOU Map Type > Add**

---

**NOTE:** If your system supports more than one TOU map type business object, you will be prompted to elect a business object for this TOU map type.

---

2. Enter a name and a meaningful description for the TOU map type.
3. Select the business object to use when creating TOU maps of this type
4. Select the time zone for the TOU map type.
5. Specify the interval size for TOU map data created from the map type. Interval size is designated as hours:minutes:seconds (HH:MM:SS)
6. Select the default TOU map template for the TOU map type
7. To add or remove override TOU map templates for this TOU type, click the + or - sign in the Override TOU Map Templates section and select the TOU map template.
8. Click **Save**.

Now you can use the TOU map type when creating TOU maps.

## Usage Subscription Types



## Understanding Usage Subscription Types

Usage Subscription Types define a collection of properties defining a class of Usage Subscriptions. Usage Subscription types also control valid values for various attributes of Usage Subscriptions.

For a deeper functional understanding, refer to the [About Usage Subscriptions](#) or [About Usage Calculation](#) sections .

## Configuring Usage Subscription Types

This portal is used to display and maintain a Usage Subscription Type.

Refer to [Understanding Usage Subscription Types](#) for more information.

You can access the portal from the **Admin > Usage > Usage Subscription Type > Search**.

The following zones may appear as part of the portal's **Main** tab page:

- **Usage Subscription Type List:** displays all of the Usage Subscription Types so you can choose the one you want to display in more detail
- **Usage Subscription Type:** shows the specific configuration for the selected Usage Subscription Type

The Usage Subscription Type defines a number of lists for "valid" objects that can be used in conjunction with the overall usage calculation process:

- Valid Service Point Types
- Valid Usage Recipients
- Valid Usage Calculation Groups
- Valid Dynamic Option Types

### Where Used

Follow this link to open the data dictionary where you can view the tables that reference [DI\\_US\\_TYPE](#).

## Integrating Usage Transactions

### Requesting Usage Transactions from External Systems

When Oracle Utilities Meter Data Management is deployed with Oracle Utilities Customer Care and Billing, usage transactions can be created via a request from Oracle Utilities Customer Care and Billing.

To invoke a usage transaction request, Oracle Utilities Customer Care and Billing invokes a Usage Transaction Request Inbound service script which invokes the Usage Transaction Seeder (D2-UsgTranSeeder) business object. This business object does the following:

- Determines the usage subscription ID based on an external usage subscription ID
- Determines the appropriate usage transaction business object to create. This uses the "How To Create Usage Subscription Related Information" processing method defined for the "Usage Transaction Creation" processing role on the service provider that represents the external system.

For a deeper functional understanding of Usage Transactions, refer to the [About Usage Transactions](#) section.

## Processing and Sending Usage Transactions to External Systems

When Oracle Utilities Meter Data Management is deployed with Oracle Utilities Customer Care and Billing, usage transaction information, including bill determinants and other data can be sent to Oracle Utilities Customer Care and Billing.

Usage transactions are sent to subscribing systems when they enter the "Sent" state. The "Send Usage" (D2-SEND-USG) Enter algorithm on the Sent state of the base package usage transaction business object (D2-UsageTransaction) determines the method used to send the information, based on the Usage Recipient (service provider) defined on the usage transaction's Usage Subscription. Usage transactions can be sent to service providers via either online real-time processing or periodically via batch processing.

### Online Real-Time Processing

To set up the service provider to support online real-time notification of usage transactions, do the following:

- Create one or more Outbound Message Types that reference the outbound message business object to be used to send usage transaction information to the external system. The base package include the following business object for Usage Transaction Outbound Message (D2-UsageTranOutboundMesg).
- Define a Message Sender that will be used to send the message to the external system.
- Add the outbound message type to the service provider's External System and reference the Message sender created above.
- Add a processing method to the service provider as follows:
- **Processing Role:** Usage Transaction Notification - Online
- **Processing Method:** How To Send US Related Information
- **Status:** Active
- **Default Processing Method:**
- **Outbound Message Type:** the outbound message type created above
- **Override Processing Method:** outbound message types for specific usage subscription types if applicable

For a deeper understanding of integrating usage transactions with Oracle Utilities Customer Care and Billing, refer to the [Configuring the Bill Determinant Interface](#) in the Interface section.

### Batch Processing

If Oracle Utilities Meter Data Management is deployed with Oracle Utilities Customer Care and Billing that requests bill determinants, usage transaction processing should be coordinated with Oracle Utilities Customer Care and Billing's billing process.

Requests from Oracle Utilities Customer to Meter that have been indicated as "batch requests" accumulate in a "calculation deferred" state to be processed specially by the **Usage Transaction Calculate Defer Monitor** batch control (D2-UTCD).

To set up the service provider to support periodic batch processing of usage transactions, use a periodic monitor batch control. These batch programs should invoke the business objects that will contain the usage transaction information. The base package includes the following business object for this: Usage Transaction Outbound Message (D2-UsageTranOutboundMesg).

Next, setup the following configuration:

- Add a processing method to the service provider as follows:
- **Processing Role:** Usage Transaction Notification - Batch
- **Processing Method:** How To Send US Related Information

- **Status:** Active
- **Default Processing Method:**
- **Batch Control:** the batch control created above
- **Override Processing Method:** batch controls for specific usage subscription types if applicable

Errors encountered when processing Usage Transactions can be reprocessed with the following batches:

- Reprocessing usage transaction "seeders" in error ([D2-UTSED](#))
- Reprocessing usage transactions in error ([D2-UTID](#))

If unexpected errors occur that leave usage transactions in an unmonitored state, the **Usage Transaction Monitor** batch control ([D2-UT](#)), or one based on this batch control with parameter values tailored to any specific requirements, can be used to process those usage transactions.

For a deeper functional understanding of Usage Transactions, refer to the [About Usage Transactions](#) section.

## Generating Usage Transactions in Oracle Utilities Meter Data Management

There may be some cases where Usage Transactions should be generated in Oracle Utilities Meter Data Management rather than requested from an external system. Generation of these usage transactions are scheduled around the time when the meter installed on the service point is read.

Base product delivered a batch program that reads all pending measurement cycle schedule routes with selection date on or before the business date and creates as SP measurement cycle schedule route business object instance that stages the creation of these usage transactions.

For additional details refer to the batch control ([D1-CSPSR](#)) and business object ([D1-SPMrmtCycScheduleRoute](#)).

## Usage Transaction Exception Types

### Understanding Usage Transaction Exception Types

Usage Transaction Exception Types define the groupings of exceptions for a Usage Transaction based on their functional similarity. This provides a way to define Usage Transaction Exceptions in a distinct enough way to understand the root issue that was generated from the usage calculation rule.

For a deeper functional understanding of Usage Calculation, refer to the [About Usage Calculation](#) section.

### Configuring Usage Transaction Exception Types

This portal is used to display and maintain a Usage Transaction Exception Type.

Refer to [Understanding Usage Transaction Exception Types](#) for more information.

You can access the portal from the **Admin > Usage > Usage Transaction Exception Type > Search**.

The following zones may appear as part of the portal's **Main** tab page:

- **Usage Transaction Exception Type List:** displays all of the Usage Transaction Exception Types so you can choose the one you want to display in more detail
- **Usage Transaction Exception Type:** shows the specific configuration for the selected Usage Transaction Exception Type

## Where Used

Follow this link to open the data dictionary where you can view the tables that reference [DI\\_USAGE\\_EXCP\\_TYPE](#).

# Usage Calculation Groups

## Understanding Usage Calculation Groups

Usage calculation groups are collections of usage calculation rules that are used to either calculate bill determinants or validate bill determinants. During the usage transaction process, the system executes the usage calculation rules defined in the usage calculation group referenced on the usage subscription. The rules within a usage calculation group are defined in a specific sequence, allowing control over the order in which the rules are executed.

Usage calculation groups are associated with specific usage subscriptions and usage subscription types (or both). When assigned to usage subscriptions, usage calculation groups contain the usage calculation rules to be used to calculate usage / bill determinants. Usage calculation groups associated with usage subscription types are those groups considered valid for usage subscriptions of that type.

Usage calculation groups can also specify a list of device donfiguration types that are considered valid. Usage calculation groups should only be associated with usage subscriptions for service points related to device configurations of a valid device configuration type.

Usage calculation groups can also be referenced by the [Execute Usage Calculation Group](#) usage calculation rule.

For a deeper functional understanding of usage calculation, refer to the [About Usage Calculation](#) section.

## Configuring Usage Calculation Groups

This portal is used to display and maintain a usage calculation group.

Refer to [Understanding Usage Calculation Groups](#) for more information.

You can access the portal from **Admin > Usage > Usage Calculation Group > Search**. You are brought to a query portal with options for searching. Once your record has been selected you are brought to the maintenance portal to view and maintain the selected record.

The following zones may appear as part of the portal's **Main** tab page:

- **Usage Calculation Group:** Defines basic information about usage calculation group
- **Usage Calculation Rules List:** lists the usage calculation rules belonging to the group
- **Referencing Usage Calculation Rules List:** lists the usage calculation rules that reference the group
- **Referencing Usage Subscription Type List:** lists the usage subscription types that reference the group
- **Referencing Usage Subscriptions List:** lists the usage subscriptions that reference the group

## Where Used

Follow this link to open the data dictionary where you can view the tables that reference [DI\\_USG\\_GRP](#).

# Usage Calculation Rules

## Understanding Usage Calculation Rules

Usage calculation rules are standard and custom rules that perform calculations on measurement data to generate bill determinants and other values used by external systems, such as billing systems, customer information systems, etc. Usage calculation rules are created for a specific usage calculation group. For example, if you were configuring two usage calculation groups and both included a specific usage calculation rule, you would need to create two instances of the usage calculation rule, one for each group.

The base package includes rules that calculate common bill determinants including:

- Scalar reads
- Time-of-use consumption (by applying a time-of-use map to an interval channel)
- Interval curves (either real or derived)
- Virtually anything else that can be calculated from the information in the system

Several usage calculation rules provide a means for defining the manner in which service quantities are rounded during usage calculations. Service quantity rounding can be defined using the **SQ Rounding Details** which allow configuration of the method by which quantities are rounded (Up, Down, or Nearest) and the number of decimal positions retained after rounding.

On almost every usage calculation rule, the failure of the rule results in a usage transaction exception and the [Usage Transaction Exception Type](#) for the failure can be configured on the rule. These usage transaction exception types can also be set to a specific Exception Severity:

- **Information:** Used to highlight minor issues, but not sufficient to cause the usage transaction to be put into a failure state. Exceptions of this category can be used to report on the frequency of interesting, but not fatal issues
- **Issues:** Used to report a problem that will prevent the usage transaction from being sent. Multiple "issue exceptions" can be created during usage transaction processing. If at least one issue exists after all rules have been applied, the usage transaction is transitioned to a failure state requiring review and approval.
- **Terminate:** Used to report a severe issue that will cause the usage calculation process to stop and the usage transaction to be transitioned immediately to a failure state requiring review and approval. Only one terminate exception can be issued (as the first one causes calculation processing to stop on for a Usage Transaction). This should be used for cases where manual override / approval isn't accurate. For example, a "Curve Not Continuous" error that says the interval data doesn't cover the full usage period should always be set to Terminate as an Exception Severity.

For a deeper functional understanding of usage calculation, refer to the [About Usage Calculation](#) section.

## Configuring Usage Calculation Rules

This portal is used to display and maintain a usage calculation rule.

Refer to [Understanding Usage Calculation Rules](#), [Understanding Usage Calculation Groups](#), and [Understanding Usage Transaction Exception Types](#) for more information.

You can access the portal from **Admin > Usage > Usage Calculation Rule > Search**. You are brought to a query portal with options for searching. Once your record has been selected you are brought to the maintenance portal to view and maintain the selected record.

The following zones may appear as part of the portal's **Main** tab page:

- **Usage Calculation Rule:** Defines the usage calculation rule, including parameters used when executing the rule
- **Eligibility Criteria List:** Lists the eligibility criteria defined for the rule

## Where Used

Follow this link to open the data dictionary where you can view the tables that reference [DI\\_USG\\_RULE](#).

## Pre-Calculation Usage Calculation Rules

The following is a list of the pre-calculation usage calculation rules provided as part of base product. For more information on how each rule executes and can be configured, follow the link provided on the rule.

Usage Calculation Rule Name	Applicable Data Type(s)	Purpose
<a href="#">Alignment and Delay Usage Calculation Rule</a>	Interval or Scalar	This rule can be used to handle two main needs:  1) aligns all measuring components for a Usage Subscription to the same date (whether on the same device or separate devices)  2) delays the usage transaction until the end of the retry window based on the quality of available data and other configured parameters.
<a href="#">Check Existence of Installed Device</a>	Interval or Scalar	This rule checks for the existence of a device installed on the Usage Subscription's Service Point for the usage period. In the case of multi-items this rule also checks that they are effective for the usage period.

## Calculation Usage Calculation Rules

The following is a list of the calculation usage calculation rules provided as part of base product. For more information on how each rule executes and can be configured, follow the link provided on the rule.

Usage Calculation Rule Name	Applicable Data Type(s)	Purpose
<a href="#">Apply Math (Interval Data)</a>	Interval	This rule is used to perform calculations on interval data and stores the results in the usage transaction's service quantities. A variety of options are available on this rule that include defining the calculation type, variables to use, as well as the equation to use (math functions and expressions).  This rule provides aggregated usage for all selected interval measuring components (filter by TOU, SQI & UOM) associated to a usage subscription.  This rule can also multiply total usage by a factor using a custom formula.
<a href="#">Daily Scalar Usage Calculation Rule</a>	Scalar	This rule is used to calculate usage of daily scalar measuring components installed in the Service Points associated with a Usage Subscription for the specified usage period. It creates bill determinants by taking the

difference between the beginning and ending reading for the bill period.

This rule can also be used to provide register readings by measuring component.

For consumption values, only the beginning and ending readings are exported

This rule supports date breaks (the normal Get Scalar Data rule does not).

---

[Get Interval Data](#)

Interval

This rule is used to get interval quantities from interval measuring components installed in the Service Points linked to the Usage Subscription for the specified 'Interval' usage period.

This rule retrieves the interval data for measuring components associated to a usage subscription by TOU, SQI and UOM.

This rule converts the interval data to another interval length or unit of measure.

---

[Get Item Counts and Consumption](#)

Interval or Scalar

This rule finds item-based and multi-item-based Service Points linked to the Usage Subscription for the current usage transaction, summarizes the item counts by item type and Service Point, and calculates item-based consumption.

---

[Get Scalar Details](#)

Scalar

This rule is used to get usage from scalar measuring components installed in the Service Points linked to the Usage Subscription for the specified 'Scalar' usage period.

This rule creates bill determinants by summing all scalar readings for the bill period. This rule can also be used to provide register readings by measuring component. All readings are exported by this rule.

Note: This rule is used for traditional monthly read meters.

---

[Get Subtractive Interval Details](#)

Get Subtractive Interval Details

This rule is used to get interval quantities from subtractive interval measuring components installed on the service points linked to the usage subscription for the specified 'interval' usage period.

It also identifies the start and stop readings for each usage period using subtractive interval readings.

---

[Get TOU Mapped Usage](#)

Interval

This rule is used to get time of use quantities from interval measuring components for devices installed at the Service Points linked to the Usage Subscription for the specified 'Interval' usage period.

---

<a href="#">Interval Tier Calculation</a>	Interval	<p>This rule calculates the difference between a source and reference vector.</p> <p>This rule loops through each tier that is configured and calculates the imbalance amount associated to that tier level.</p> <p>This rule breaks down that difference into one to many positive or negative tiers, and create a service quantity for each tier calculated.</p>
<a href="#">Profile Accumulation</a>	Interval	<p>This rule is used to manipulate a customer's interval data by adding other vectors to it. Those other vectors are derived from a list of profile factors and corresponding characteristic values stored in a list on the usage transaction.</p>
<a href="#">Round and Adjust Usage</a>	Interval or Scalar	<p>This rule copies identified source and target Service Quantities and inserts these as Service Quantities that are rounded and adjusted.</p>
<a href="#">Vector and Service Quantity Math</a>	Interval	<p>This rule is designed to facilitate configuration of complex vector calculations. It is based on a series of underlying services with vectors configured as input to the calculations.</p> <p>Typical uses:</p> <p>Perform math using interval data, e.g., take the difference between two curves, find max values, find coincident peaks, multiply a curve by a value, apply TOU maps, etc.</p> <p>Define complex formulas using various interval curves, profile factor values or calculated service quantities (bill determinant values).</p> <p>Support math functions: sin, cos, square root, etc.</p> <p>Store derived curves in memory that can be used in subsequent calculations</p> <p>Please note, this rule is not as efficient as other rules.</p>

## Post-Calculation Usage Calculation Rules

Below is a list of the post-calculation usage calculation rules provided as part of base product. For more information on how each rule executes and can be configured, follow the link provided on the rule.

<b>Usage Calculation Rule Name</b>	<b>Applicable Data Type(s)</b>	<b>Purpose</b>
<a href="#">Usage High/Low Rule</a>	Interval or Scalar	<p>This rule compares the Service Quantities of the Usage Transaction to historical values. If the current value is too high or too low compared to historical data then an exception is thrown.</p>



<a href="#">Validate Against Tolerance</a>	Interval or Scalar	This rule is used to validate the calculated usage against a tolerance value. The tolerance value may either come from the specified value or tolerance factor defined in the usage calculation rule.
<a href="#">Business Flag Hold</a>	Interval or Scalar	This rule can stop a usage transaction from proceeding when there have been business flags for the applicable service points. The hold can either be indefinite or set to expire a configurable amount of time prior to the calculation window ending.

## Decision-Making Usage Calculation Rules

There are usage calculation rules delivered as part of the base product that help with decision-making when executing running the usage calculation process. For more information on how each rule executes and can be configured, follow the link provided on the rule.

Usage Calculation Rule Name	Purpose
<a href="#">Execute Usage Calculation Group</a>	This rule performs a call to execute a separate usage calculation group which includes execution of all usage calculation rules within that group.
<a href="#">Exception Handler</a>	This rule is used to terminate execution of the usage processor if exception count criteria specified in the rule is met.

## Advanced Aside: Using Factors For Variables

A situation common in some implementations involves converting one unit of measure (UOM) to another. However, the conversion factor used in conversions of this can differ based on many different types of criteria, such as the location of the service point or other characteristics. This sort of calculation can be implemented as a usage calculation rule that accumulates consumption for one UOM and converts the consumption to a different UOM by applying a factor to it.

Factors used for this purpose have a Factor Class of "Number," and use some unique rules:

- Number factors reference a characteristic type (with pre-defined values).
- Number factors reference an algorithm that retrieves or derives the value of the characteristic type at runtime.

Factor values for a Number factor are effective-dated pairings of a characteristic value and a corresponding value. Because these pairings are effective-dated, the value returned from the factor can change over time for each characteristic value. At run time, the rule retrieves / derives the characteristic value for the factor's characteristic type and then finds the value associated with the respective characteristic value. Factors can be related to any real or dynamic attribute, so rules of this type are very flexible. For example:

- **Real Attribute:** you could create a rule that retrieves a specific value based on the location of a service point.
- **Dynamic Attribute:** you could create a rule that retrieves a percentage value based on the amount the customer conserved as compared to the same period in the prior year, returning one value if the amount conserved is between 5% and 10%, another value if the amount conserved is between 10% and 20%, and yet a third value if the amount conserved is greater than 20%. The amount conserved is dynamically calculated at execution time and is compared to the characteristic values defined for the factor, and returns the appropriate value. In this example, if the amount conserved was anything less than 5%, no percentage value would be returned.

## Pre-Calculation Usage Calculation Rules

### Alignment and Delay Usage Calculation Rule

This rule attempts to delay usage calculation until high quality data for calculating bill determinants have become available. It is especially useful for usage subscriptions having multiple sources of usages such as multiple service points or multiple measuring components on the installed meter. The rule ensures that the usage calculated is based on a common date or alignment date, identified for these sources.

---

**NOTE:**

Additional detail on the logic of this rule can be found in the Detailed Description of the [D2-ALGNDELAY](#) Algorithm Type.

For help with the meaning of specific configuration fields, refer to the embedded help on the screen when adding or editing the rule.

---

### Business Object

D2-AlignmentandDelay

### Check Existence of Installed Device

This rule checks for the existence of a device installed on the Usage Subscription's Service Point for the usage period. In the case of multi-items this rule also checks that they are effective for the usage period.

---

**NOTE:**

Additional detail on the logic of this rule can be found in the Detailed Description of the [D2-CHKEXTDVC](#) Algorithm Type.

For help with the meaning of specific configuration fields, refer to the embedded help on the screen when adding or editing the rule.

---

### Business Object

D2-ChkExistenceofInstalledDvc

## Calculation Usage Calculation Rules

### Apply Math (Interval Data)

This rule is used to perform calculations on interval data and it stores the results in the usage transaction's service quantities. A variety of options are available on this rule that include defining the calculation type, variables to use, as well as the equation to use (math functions and expressions).

---

**NOTE:**

Additional detail on the logic of this rule can be found in the Detailed Description of the [D2-APPMATHIN](#) Algorithm Type.

For help with the meaning of specific configuration fields, refer to the embedded help on the screen when adding or editing the rule.

---

## Business Object

D2-ApplyMathInt

## Example Scenarios

Below are some example scenarios that can be achieved based on configuration of this rule.

### Scenario 1: Get the total KWH for the period

---

**Calculation Type** = Single Variable

**Variable Name** = V1, where the following is configured:

- Variable Type = Channel Accumulation
- UOM = KWH
- Set Function = Sum

---

### Scenario 2: Get the higher value between the total KWH or total KVARH

---

**Calculation Type** = Math Function

**Math Function** = Max

**Variable Name** = V1, where the following is configured:

- Variable Type = Channel Accumulation
- UOM = KWH
- Set Function = Sum

**Variable Name** = V2, where the following is configured:

- Variable Type = Channel Accumulation
- UOM = KVARH
- Set Function = Sum

---

### Scenario 3: Total KWH multiplied with a factor value

---

**Calculation Type** = Mathematical Expression

**Mathematical Expression** = V1 \* V2

**Variable Name** = V1, where the following is configured:

- Variable Type = Channel Accumulation
- UOM = KWH
- Set Function = Sum

**Variable Name** = V2, where the following is configured:

- Variable Type = Factor
  - Factor = factor code that holds the multiplier
- 

## Daily Scalar Usage Calculation Rule

This rule is used to calculate usage of daily scalar measuring components installed in the Service Points associated with a Usage Subscription for the specified 'Interval' usage period. Only automatically read scalar measuring components with value identifier that matches usage calculation rule's UOM/TOU/SQI will be processed.

If configuring this rule with interval and scalar usage calculation rules under a usage calculation group, it should be executed after interval usage calculation rule and before the scalar usage calculation rule.

This rule calculates usage based on the beginning and ending reading values -- ignoring intermediate readings. This rule will not estimate data based on the usage transaction estimate flag. Frequently read scalar devices must use periodic estimation processes.

---

**NOTE:**

Additional detail on the logic of this rule can be found in the Detailed Description of the [D2-GETFRESCR](#) Algorithm Type.

For help with the meaning of specific configuration fields, refer to the embedded help on the screen when adding or editing the rule.

---

## Business Object

D2-CalFrequentlyReadScalar

## Get Interval Data

This rule is used to get interval quantities from interval measuring components installed in the service points linked to the usage subscription for the specified 'Interval' usage period. Only measuring components that match the UOM/SQI defined in the usage calculation rule are processed. Measurements within the period are stored in the usage transaction's service quantities' interval data list. The SQ entry's quantity is calculated based on the **Calculate Function** defined in the usage calculation rule. This is done for every entry in the usage period list. Each service quantity recorded by this rule is linked to a service point and measuring component.

By supplying the Axis Conversion parameters on the usage calculation rule, this algorithm will convert the identified measuring component's consumption into the supplied UOM and interval size prior to storing the consumption into the service quantity's interval data list.

---

**NOTE:**

Additional detail on the logic of this rule can be found in the Detailed Description of the [D2-GETINTDAT](#) Algorithm Type.

For help with the meaning of specific configuration fields, refer to the embedded help on the screen when adding or editing the rule.

---

## Business Object

D2-GetIntervalData

## Get Item Counts and Consumption

This rule finds item-based and multi-item-based Service Points linked to the Usage Subscription for the current usage transaction, summarizes the item counts by item type and Service Point, and calculates item-based consumption. Once the item detail entries are created, the rule processes goes through them to create usage period SQs.

---

**NOTE:**

Additional detail on the logic of this rule can be found in the Detailed Description of the [D2-GETITEMCC](#) Algorithm Type.

For help with the meaning of specific configuration fields, refer to the embedded help on the screen when adding or editing the rule.

---

## Business Object

D2-GetItemCountsConsumption

## Get Scalar Details

This rule is used to get usage from scalar measuring components installed in the Service Points linked to the Usage Subscription for the specified 'Scalar' usage period. By default all scalar measuring components are processed but if specific UOMs/TOUs/SQIs are defined in the usage calculation rule then only applicable measuring components are processed. Measurements within the period are retrieved. The usage transaction request may indicate whether or not 'Estimate' measurements are allowed.

The measurement details are stored in the usage transaction's scalar details. The usage is also stored in the usage transaction's service quantities unless otherwise specified in the usage calculation rule (using Build Service Quantity indicator).

This rule can be configured to perform measurement quality assessment, which will result in the population of the measurement quality list with the quantities and corresponding conditions of those measurements (regular, estimated, etc.).

**Please note:** this rule should not be used with readings occurring daily or more frequently as it will retrieve all of the readings to store in the Usage Transaction. The [Daily Scalar usage calculation rule](#) may be a better option for this use case.

---

### NOTE:

Additional detail on the logic of this rule can be found in the Detailed Description of the [D2-GETSCALAR](#) Algorithm Type.

For help with the meaning of specific configuration fields, refer to the embedded help on the screen when adding or editing the rule.

---

## Business Object

D2-GetScalar

## Get Subtractive Interval Details

This rule is used to calculate the usage for a subtractive interval measuring components. This differs from the Get Interval Data usage calculation rule in that it also retrieves a start and stop reading for each usage period it calculates. The start and stop readings are then used to provide entries into the usage scalar details table which are then made available in the usage transaction sent to the billing system for bill presentment.

---

### NOTE:

Additional detail on the logic of this rule can be found in the Detailed Description of the [D2-SUBINTADJ](#) Algorithm Type.

For help with the meaning of specific configuration fields, refer to the embedded help on the screen when adding or editing the rule.

---

## Business Object

D2-GetSubtractiveInterval

## Get TOU Mapped Usage

This rule is used to get time of use quantities from interval measuring components for devices installed at the Service Points linked to the Usage Subscription for the specified 'Interval' usage period. Only measuring components that match the UOM/SQI defined in the usage calculation rule instance are processed.

Measurements within the period are mapped to time of use quantities based on the TOU map defined on the usage calculation rule. If dynamic options are specified in the referenced TOU map and if there are dynamic option events in

effect within the usage period then the TOU map associated with the dynamic option is used for the entire dynamic option event period. This calculation is performed for every usage period requested.

The calculated time of use quantities are stored in the usage transaction's service quantities per Service Point and measuring component.

---

**NOTE:**

Additional detail on the logic of this rule can be found in the Detailed Description of the [D2-GETTOUUSG](#) Algorithm Type.

For help with the meaning of specific configuration fields, refer to the embedded help on the screen when adding or editing the rule.

---

## Business Object

D2-GetTOUUsage

## Interval Tier Calculation

This rule calculates the difference between a source and reference vector. It then breaks that difference into one to many positive or negative tiers. For each tier calculated it will create a service quantity with the optional ability to create additional service quantities for the total of all positive tiers and the total of all negative tiers. This rule will loop through each tier that is configured and calculate the imbalance amount associated to that tier level.

---

**NOTE:**

Additional detail on the logic of this rule can be found in the Detailed Description of the [D2-GETINTIER](#) Algorithm Type.

For help with the meaning of specific configuration fields, refer to the embedded help on the screen when adding or editing the rule.

---

## Business Object

D2-IntervalTierCalculation

## Profile Accumulation

This rule is used to manipulate a customer's interval data by adding other vectors to it. Those other vectors are derived from a list of profile factors and corresponding characteristic values stored in a list on the usage transaction.

The typical application of this rule is for customer self-service rate compare, in which a self-service user has selected a set of usage adjustments to apply to his/her historical consumption to assess the effect on the amount consumed.

This rule algorithm retrieves the customer's usage (the source UOM) for the usage period using one of two options:

- A channel linked to a Usage Subscription
- A usage transaction service quantity

Then it takes each entry in the usage transaction's profile factor list, finds the profile measuring component for each, retrieves the measurement data for the profile, applies axis conversion to align it to the source UOM and target interval size, and adds it to the source vector. Each profile's data is added progressively to arrive at a final vector. The final vector may then be TOU-mapped, and the vector itself may be preserved or discarded.

---

**NOTE:**

Additional detail on the logic of this rule can be found in the Detailed Description of the [D2-DYNPRFLAC](#) Algorithm Type.

---

For help with the meaning of specific configuration fields, refer to the embedded help on the screen when adding or editing the rule.

---

## Business Object

D2-ProfileAccumulation

## Profile Service Quantity

This rule intervalizes scalar service quantity values based on a profile measuring component.

This rule first retrieves scalar service quantities, identified by the rule's UOM/TOU/SQI. If multiple service quantities exist for the service point they will be summarized at the service point level. In the case of a split or broken usage period for a service point, the usage period is merged and the quantities are summarized. Each service quantity is subject to intervalization. The profile measuring component is then derived using the profile factor supplied with either the usage subscription or service point as characteristic sources. If the profile is not available, an exception will be created using the exception details on the rule.

If a dynamic option type is provided, the events associated with it are retrieved for the usage transaction period. Any intervalized quantities that coincide with the dynamic option events start/end date time are then recorded in a new usage period service quantity of usage type "Correlated SQ".

If no dynamic option type provided, the intervalized quantities are recorded in a new usage period service quantity of usage type "Profile SQ".

---

### NOTE:

Additional detail on the logic of this rule can be found in the Detailed Description of the [D2-PRFSVCQTY](#) Algorithm Type.

For help with the meaning of specific configuration fields, refer to the embedded help on the screen when adding or editing the rule.

---

## Business Object

D2-ProfileServiceQuantity

## Round and Adjust Usage

This rule copies identified source and target Service Quantities and inserts these as period Service Quantities that are rounded and adjusted. This rule captures the source and target Service Quantity identifiers, rounding method, and Service Quantity bucket to hold the adjustment. The usage calculation rule also has an option to validate the difference between the source and target service quantities.

---

### NOTE:

Additional detail on the logic of this rule can be found in the Detailed Description of the [D2-RNDADJUSG](#) Algorithm Type.

For help with the meaning of specific configuration fields, refer to the embedded help on the screen when adding or editing the rule.

---

## Business Object

D2-RoundAndAdjustUsage

## Vector and Service Quantity Math

This rule is designed to facilitate configuration of complex vector and scalar quantity calculations. It is based on a series of underlying services, including Axis Conversion, Apply Formula (most importantly), and Apply TOU Map. It can be configured to accept as input up to five vectors - where a single vector can represent the combination of all measuring components with linkages to the Usage Subscription with the configured UOM/SQL. It can also accept a list of scalar variables that can be taken in as factor values, usage transaction service quantities, set functions on a vector, or numeric values.

Vectors can be combined using a simple formula expression, or using condition formula expressions. Both interval values and interval conditions can be referenced. The result is interval-by-interval processing of the vector formula. The resulting final vector can be stored, TOU mapped, and/or subjected to a final set function (such as sum or max).

This rule stores service quantities of type "other" - meaning that the service quantities created by this rule do not have linkages to a specific Service Point or measuring component, given the potentially diverse sources of the data taken as input by this rule that lead to the final quantity.

---

**NOTE:**

Additional detail on the logic of this rule can be found in the Detailed Description of the [D2-MATH](#) Algorithm Type.

For help with the meaning of specific configuration fields, refer to the embedded help on the screen when adding or editing the rule.

---

### Business Object

D2-Math

## Post-Calculation Usage Calculation Rules

### Usage High/Low Rule

This rule is used to validate the current usage against historical usage - previous year usage or previous usage. It ensures that any increase or decrease of the current usage relative to historical usage is within a tolerance.

---

**NOTE:**

Additional detail on the logic of this rule can be found in the Detailed Description of the [D2-USGHIGLOW](#) Algorithm Type.

For help with the meaning of specific configuration fields, refer to the embedded help on the screen when adding or editing the rule.

---

### Business Object

D2-UsageHighLowRule

### Validate Against Tolerance

This rule is used to validate the calculated usage against a tolerance value. The tolerance value may either come from the specified value or tolerance factor defined in the usage calculation rule.

---

**NOTE:**

Additional detail on the logic of this rule can be found in the Detailed Description of the [D2-VALUSGTOL](#) Algorithm Type.

---



For help with the meaning of specific configuration fields, refer to the embedded help on the screen when adding or editing the rule.

---

## Business Object

D2-ValAgainstTol

## Business Flag Hold

This rule can be used to place a hold on a usage transaction until the business flags related to the usage transactions service points can be investigated. The hold can be placed in one of two ways:

- **Calculation Window Based:** holds will remain until either a user manually bypasses the usage exception error or the current date is within a configurable tolerance of the calculation window end (aka the retry until date time).
- **Indefinite:** holds require a user to manually bypass the usage exception that is generated.

Defining which business flags should result in a usage transaction is a matter of identifying which business flag types, priorities, and confidences should be included.

---

### NOTE:

Additional detail on the logic of this rule can be found in the Detailed Description of the [D2-AUR-IBFH](#) algorithm type.

For help with the meaning of specific configuration fields, refer to the embedded help on the screen when adding or editing the rule.

---

## Business Object

D2-BusinessFlagHold

## Decision-Making Usage Calculation Rules

### Execute Usage Calculation Group

This rule performs a call to execute a separate usage calculation group which includes execution of all usage calculation rules within that group. It is especially useful in cases where repeating the same rule over and over would be hard to maintain.

For example, you may want to calculate a straightforward kWh sum for every usage calculation group. Creating a separate CALC\_KWH\_SUM usage calculation group for this one calculation allows you to isolate the configuration points. Then the CALC\_KWH\_SUM usage calculation group can be referenced in every other usage calculation group that needs this sort of service quantity.

---

### NOTE:

Additional detail on the logic of this rule can be found in the Detailed Description of the [D1-AUSGR-RFG](#) Algorithm Type.

For help with the meaning of specific configuration fields, refer to the embedded help on the screen when adding or editing the rule.

---

## Business Object

D1-UsageRuleReferredUsageGroup

## Exception Handler

This rule evaluates the exception list that was accumulated during the execution of the calculation rules against exception criteria configured on this rule. This used to terminate the execution of usage calculation group processor if there are far too many exceptions hit during the execution.

---

**NOTE:**

Additional detail on the logic of this rule can be found in the Detailed Description of the [D2-UREXPCHAN](#) Algorithm Type.

For help with the meaning of specific configuration fields, refer to the embedded help on the screen when adding or editing the rule.

---

## Business Object

D2-UsageRuleExceptionHandler

## Detailed Configuration Examples

### Demand Calculation Options Using Interval Data

There are a number of ways to calculate a demand value from interval data when retrieving bill determinants for CIS. A few examples of demand calculations are listed below:

**Scenario1: Use interval data for demand at a common block size:** the [Vector and Service Quantity Math](#) usage calculation rule can be used to calculate demand from the interval data. Below is one example of configuration to handle demand calculation based on 30 minute blocks:

Usage Calculation Rule field	Value	Notes
Vector 1 // Type	Physical Channels Links to Usage Subscription	
Vector 1 // Unit of Measure	Kilowatt-Hours	Use your own UOM here - this is just as example.
Vector 1 // Service Quantity Identifier	Consumed	Use your own SQI here - this is just as example.
Vector Processing // Common Interval Size	00:30:00	This configuration rolls up all channels (whether 5 minute, 15 minute, or 30 minute interval data) into a common interval size.
Vector Processing // Vector Formula Source	Simple Vector Formula	
Vector Processing // Simple Vector Formula	IV1*2	This is multiplying the common 30 minute interval size by 2 to achieve an hourly value.
Result // Unit of Measure	Kilowatts	Use your own UOM here - this is just as example.
Result // Service Quantity Identifier	Consumed	Use your own SQI here - this is just as example.
Result // Insert Primary SQ Entry	Yes	
Result // SQ Entry Quantity Source	Set Function Against Derived Vector	

Result // Set Function Against Derived Vector      Max

This function pulls the max value based on the configuration in the "Vector Processing" section.

**Scenario 2: Use interval data for demand by TOU period:** This example is very similar to the last and again leverages the [Vector and Service Quantity Math](#) usage calculation rule. However, instead of calculating a single demand value for the entire period it will calculate a demand value for each TOU period:

Usage Calculation Rule field	Value	Notes
Vector 1 // Type	Physical Channels Links to Usage Subscription	
Vector 1 // Unit of Measure	Kilowatt-Hours	Use your own UOM here - this is just as example.
Vector 1 // Service Quantity Identifier	Consumed	Use your own SQI here - this is just as example.
Vector Processing // Common Interval Size	00:30:00	This configuration rolls up all channels (whether 5 minute, 15 minute, or 30 minute interval data) into a common interval size.
Vector Processing // Vector Formula Source	Simple Vector Formula	
Vector Processing // Simple Vector Formula	IV1*2	This is multiplying the common 30 minute interval size by 2 to achieve an hourly value.
Result // Unit of Measure	Kilowatts	Use your own UOM here - this is just as example.
Result // Service Quantity Identifier	Consumed	Use your own SQI here - this is just as example.
Result // Insert Primary SQ Entry	No	
Result // Apply TOU Map To Derived Vector	Yes	
Result // TOU Map	(your TOU Map)	Select the TOU Map you'd like to apply.
Result // Time Of Use Calculate Function	Max	This function pulls the max value based on the configuration in the "Vector Processing" section and then buckets it based on the selected TOU Map.

## Usage Calculation Types

### Understanding Usage Calculation Types

Usage calculation types define calculations executed at a customer level where there may be more than one calculation per usage subscription. For example, a customer may have a usage subscription for producing billing determinants but there may be additional calculations that will be executed on a much less frequent basis (annually, quarterly, etc). Usage calculation types provide a way to leverage a single usage subscription to drive multiple different calculations.

Usage calculation types use the following parameters:

- **Request Type:** Used to drive the creation and processing of the usage transactions for all usage subscriptions that are valid for the usage calculation type.

---

**NOTE:** Request types for usage calculation types should be based on the Usage Calculation Request Type business object (D2–UsageCalculationReqType)

---

- **Service Point Quantity Creation:** Details of the quantities created by usage calculations of this type, including service point quantity type, and UOM, TOU, and SQL.
- **Applicable Usage Subscription Types:** A list of usage subscription types for which this usage calculation type is applicable. Each usage subscription type is defined by an effective date range, the usage transaction business object used for the usage calculation, the result UOM/TOU/SQL, and the usage calculation group used to perform the calculations.

## Configuring Usage Calculation Types

Refer to [Understanding Usage Calculation Types](#) for more information.

You can access the portal from **Admin > Usage > Usage Calculation Type**.

The following zones may appear as part of the portal's **Main** tab page:

- **Usage Calculation Type List:** This zone lists all usage calculation type records. Broadcast a record to display the details of the selected record.
- **Usage Calculation Type:** This zone displays details for the selected usage calculation type.

### Where Used

Follow this link to open the data dictionary where you can view the tables that reference [D1\\_USG\\_CAL\\_TYPE](#).

## Dynamic Option Types

### Understanding Dynamic Option Types

Dynamic options specify terms that override how usage is normally calculated, such as a critical peak period that affects the TOU mapping of interval consumption. Dynamic option types store information common to dynamic options of a specific type.

There are two classes of dynamic options:

- **Interval Set:** Used to represent dynamic option types that provide a set of intervals that will be included in a calculation.
- **Usage Event:** Used to represent dynamic option types that provide a specific period of time during which a dynamic option is applicable.

Interval Set dynamic option types also define key information about the interval data they represent, including:

- **Unit of Measure:** Identifies the quantity that Interval Set dynamic options and Interval Set dynamic option events based on this type are measuring.
- **Interval Size:** Defines the size of the intervals for Interval Set dynamic option events of this type, represented as hours:minutes:seconds (HH:MI:SS).

### Configuring Dynamic Option Types

This portal is used to display and maintain a Dynamic Option Type.

Refer to [Understanding Dynamic Option Types](#) for more information.

You can access the portal from **Admin > Usage > Dynamic Option Type**.

The following zones may appear as part of the portal's **Main** tab page:

- **Dynamic Option Type List:** displays all of the Dynamic Option Types so you can choose the one you want to display in more detail
- **Dynamic Option Type:** shows the specific configuration for the selected Dynamic Option Type

## Where Used

Follow this link to open the data dictionary where you can view the tables that reference [DI\\_DYN\\_OPT\\_TYPE](#).

# Bill Cycle

## Understanding Bill Cycles

Bill cycles identify when a customer is going to be billed and when bill determinants are going to be calculated.

---

**NOTE:** Meter Data Management bill cycles are created from Customer Care and Billing bill cycles via [Customer To Meter Master Data Synchronization](#).

---

## Configuring Bill Cycles

This portal is used to display and maintain a Bill Cycle.

Refer to [Understanding Bill Cycles](#) for more information.

You can access the portal from other objects such as Measurement Cycles.

The following zones may appear as part of the portal's **Main** tab page:

- **Bill Cycle List:** displays all of the Bill Cycles so you can choose the one you want to display in more detail.
- **Bill Cycle:** shows the specific configuration for the selected Bill Cycle.
- **Bill Cycle List:** lists the bill cycle schedules of the current bill cycle.

---

**NOTE:** Meter Data Management bill cycles are created from Customer Care and Billing bill cycles via [Customer To Meter Master Data Synchronization](#). Bill cycles should only be updated via the Customer Care and Billing Bill Cycle portal.

---

## Where Used

Follow this link to open the data dictionary where you can view the tables that reference [DI\\_BILL\\_CYC](#).

# Defining Time of Use Options

## Time of Use Groups

## Understanding Time of Use Groups

Time of Use (TOU) Groups are groups of TOUs that are associated to TOU templates that limit the TOUs available for use in a TOU schedule. These TOUs will be available as the default, holiday, and schedule TOUs within the template.

Each TOU in the group is given a priority. The priority is important in a few ways:

- The [TOU Overlay](#) 360 Degree zone uses these priorities to decide which TOUs will be rendered as a unique shade and which will fall into a category of "other" when the maximum number of distinct TOUs to graph has been reached.
- These priorities are available for use in customized logic.

## Configuring Time of Use Groups

This portal is used to display and maintain a TOU Group.

Refer to [Understanding Time of Use Groups](#) for more information.

You can access the portal from the **Admin > Usage > TOU Group > Search**.

The following zones may appear as part of the portal's **Main** tab page:

- **TOU Group List:** This zone lists all TOU Group records. Broadcast a record to display the details of the selected record.
- **TOU Group:** This zone provides information about the selected TOU Group.

## Where Used

Follow this link to open the data dictionary where you can view the tables that reference [DI\\_TOU\\_GRP](#).

## Time of Use Map Templates

### Understanding Time of Use Map Templates

Every TOU map references a TOU map template that defines the rules for generating TOU data from that TOU map. Specifically, TOU map templates define:

- The TOU group (defines the valid TOU periods for the template) used for the TOU map
- The default TOU period used for periods not explicitly defined. (This means you don't have to specify dates and times for all periods. For example, if your default TOU period is "Off Peak" you only need to define dates and days and times for On Peak or other TOU periods.)
- The specific date ranges, days of the week, and time periods designated for each TOU period.

The system periodically generates TOU map data for TOU maps by interpreting the rules defined template.

Attributes used to define TOU map templates include the following:

- **TOU Group:** the TOU group used by the map template Default TOU: the default TOU for the map template (from the TOU Group). This is the TOU used when creating TOU map data for dates not accounted for in the TOU Schedules section.
- **Work Calendar:** the work calendar used to identify holidays. On each holiday the Holiday TOU will be used. For additional information see [Defining Work Calendar](#) in the Oracle Utilities Application Framework *Administrative User Guide*.
- **Holiday TOU:** the TOU used for holidays (from the TOU Group)

- **Holiday Template:** the TOU map template used for holidays (if applicable)
- **Interval Size:** the size of the intervals for TOU map data created from the map template, represented as hours:minutes:seconds (HH:MI:SS).
- **TOU Schedules:** date ranges (including month, day, and time ranges) and which TOUs

Refer to [Understanding Referencing Master Data by Identifiers](#) for information on how admin configuration can reference a TOU map by a TOU template to ease migration of data between environments.

## TOU Map Template Interval Size

TOU map templates can also specify an interval size (in seconds-per-interval, or SPI). This value specifies the duration of the individual TOU map data records, and also controls the values allowed in the Start and End Times. For example, if a TOU map template sets the interval size at 15 minutes, Start and End times must be in units of the interval size (10:00, 10:15, 10:30, etc.).

A TOU map template can be used to generate TOU map data for TOU maps whose SPI is divisible by the template's SPI. For example, a 60 minute template can be used to generate TOU data for TOU maps with SPIs of 60 minutes, 15 minutes, 5 minutes, etc. This means separate map templates are not needed for every SPI.

## Holidays

Many utilities categorize consumption on holidays differently than on the day of week on which the holiday falls. For example, holiday consumption might be categorized as Off-Peak regardless of the day it falls on. TOU map templates can define rules for different TOU periods for holidays in two ways. Both options require that the template references a Work Calendar that identifies each of the holidays throughout the year. In addition they require either:

- A Holiday TOU that will be used for each holiday for the duration of that holiday (e.g. Off Peak)
- A Holiday TOU Map Template that defines the TOUs that should be used for holidays that fall during different seasons within the year (e.g. Off Peak Summer, Off Peak Winter)

## Important Time of Use Template System Events

The time of use template supports the following business object algorithm system events:

- **Derive TOU:** receives a date time and determines the TOU code for that date time based on the configuration of the time of use template schedule. See algorithm type Derive Time Of Use For Date Time ([D2-DERTOU-DT](#)) as an example.

## Configuring Time of Use Map Templates

This portal is used to display and maintain a TOU Map Templates.

Refer to [Understanding Time of Use Map Templates](#) for more information.

You can access the portal from the **Admin > Usage > TOU Map Template > Search**.

The following zones may appear as part of the portal's **Main** tab page:

- **TOU Map Template List:** This zone lists all TOU Map Template records. Broadcast a record to display the details of the selected record.
- **TOU Map Template:** This zone provides information about the selected TOU Map Template.

## Where Used

Follow this link to open the data dictionary where you can view the tables that reference [D1\\_TOU\\_MAP\\_TMPLT](#).

# Time of Use Map Types

## Understanding Time of Use Map Types

TOU Map Types define important properties of TOU maps of the type, including the interval size and the valid TOU map templates.

Attributes used to define TOU map types include the following:

- **Time Zone:** the time zone to be used when generating the TOU map data. Refer to [Multiple Time Zone Support](#) for more information about how time zones impact TOU map data in multiple time zone environments.
- **Interval Size:** the size of the intervals for TOU map data created from maps of this type, represented as hours:minutes:seconds (HH:MI:SS). The interval size cannot be larger than the interval size defined on the Default TOU Map Template or any of the Override TOU Map Templates.
- **Default TOU Map Template:** the default TOU map template used by maps of this type
- **Override TOU Map Templates:** one or more TOU map templates that can be used as an override on TOU maps of this type.

### TOU Map Type Interval Size

The SPI of a TOU map must divide evenly into the SPI of any measuring component that uses the map (because the system joins the date/time of the measurement to the date/time of the TOU data). This means that it is possible to use a 15 minute TOU map with a 60 minute measuring component. However, it is not OK to have a 60 minute TOU map used with a 15 minute measuring component because the join will miss 3 out of 4 measurements.

However, it is important to note that the TOU mapping process is at its most efficient when the measurement data that is being mapped is of the same interval size as the TOU schedule it is being mapped against. When there are differences in the interval size the process must first convert the measurement data into the appropriate interval size for the TOU Map prior to applying the TOU Map.

This means that for each TOU Map Template you should have sufficient TOU Map Types to cover the various interval sizes that will be supported by your measurement data. For example, if you have measuring components with interval sizes of 15 minutes, 30 minutes, and 60 minutes then for each TOU Map Template there should be TOU Map Types with interval sizes of 15 minutes, 30 minutes, and 60 minutes.

### Default and Override TOU Map Templates

While most TOU maps will use the TOU map template defined on the TOU map type, TOU maps also support a fallback/override pattern used in other areas of the system.

- A TOU map's TOU map type defines the default (or "fallback") TOU map template that's used to generate its TOU data.
- A TOU map's type defines the TOU map templates that can be referenced on individual TOU maps to override the "fallback" template.
- An individual TOU map can have an override template. If the TOU map doesn't have an override template, the fallback template defined on the TOU map type is used to generate the map's TOU data.

### Important Time of Use Map System Events

The TOU Map business object that is associated to a given TOU map type supports a special system event that is used in the generation of TOU map data:

- **Create TOU Map Data:** receives a date range and for that date range it will create the appropriate TOU map data for the TOU map. See algorithm type Create TOU Map Data ([D2-CRETMD-CT](#)) as an example.



## Configuring Time of Use Map Types

This portal is used to display and maintain a TOU Map Types.

Refer to [Understanding Time of Use Map Types](#) for more information.

You can access the portal from the **Admin > Usage > TOU Map Type > Search**.

The following zones may appear as part of the portal's **Main** tab page:

- **TOU Map Type List:** This zone lists all TOU Type records. Broadcast a record to display the details of the selected record.
- **TOU Map Type:** This zone provides information about the selected TOU Map Type.

### Where Used

Follow this link to open the data dictionary where you can view the tables that reference [DI\\_TOU\\_MAP\\_TYPE](#).

## Defining Premise and Service Point Options

A premise is where a customer consumes the services supplied by your company. Located at a premise are the various devices that consume energy and measure consumption. Before you can define premises and devices, you must set up the control tables defined in this section.

---

#### WARNING:

The topics in this section do not describe every table that must exist in order to set up premises and service points. Many premise and service point control tables are described in [Defining Device Options](#), and [Defining Service Order Options](#). The tables described in this section are those that must be set up regardless of the type of service.

---

## An Illustration Of A Premise

The following picture illustrates a premise with 2 service points, 2 meters, and 2 badged items:

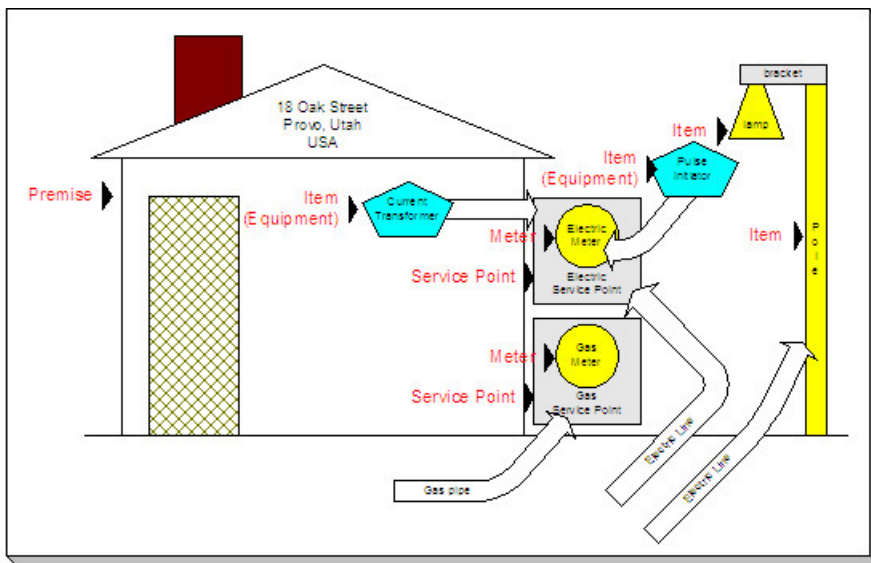

The following concepts are illustrated above:

**Premise** A premise describes a location at which your company supplies some type of service. In addition to the obvious address information, a premise also contains geographic coordinates, meter read instructions, and taxation jurisdiction information.

---

**FASTPATH:**

For more information about the control tables that must be set up before you can define a premise see [Setting Up Premise Options](#).

---

**Service Point** A service point (SP) is a geographic location at which service(s) are delivered to a premise. The SP record maintains information about the type of service, the measurement cycle (if the service is metered), the field office responsible for maintaining the service, the distribution company that supplies the service, etc.

There are three major categories of service points:

- Those where the rate of consumption and the total amount of consumption is measured (e.g., electricity, gas, water) by a meter. You can think of this type of service point as a "socket" into which a meter can be plugged. Over time, many meters may be plugged into the socket. We refer to these types of service points as metered.
- Those that hold badged items. A badged item is a physical device with a unique identity (e.g., a specific street light, a specific hydrant). You can think of this type of service point as a "socket" into which a badged item can be plugged. Over time, many items may be plugged into the socket. We refer to these types of service points as item-based.
- Those used to hold one or more non-badged items. For example, if your organization doesn't badge street lamps, you can use a single service point to hold an infinite number of lamps. We refer to these types of service points as non-badged.

---

**FASTPATH:**

Refer to [Service Points \(SPs\)](#) for more information about non-badged items.

---

An unlimited number of SPs may exist at a premise. However in reality, the number of SP's is related to the number of services supplied by your company. For example, an electric and gas company will typically have two SPs per premise.

---

**FASTPATH:**

For more information about the control tables that must be set up before you can define service points refer to [Setting Up Generic Service Point Options](#), [Defining Device Options](#).

---

Field activities may be dispatched to all types of service points.

**Meter** A meter is a physical device used to measure the amount of gas, water, or electricity used by a customer. While most meters measure consumption in a single unit of measure (e.g., gallons, cubic feet, kilowatt-hours), some electric meters are extremely sophisticated and measure several different factors. For example, some electric meters measure how much was used, when it was used, the efficiency of consumption, the maximum amount used, and a few other unusual things.

---

**FASTPATH:**

For more information about the control tables that must be set up before you can define a meter, refer to [Defining Device Options](#), and [Setting Up Consumption Estimation Parameters](#).

---

**Item** An item that is not consider to be "equipment" is a physical device that does NOT measure consumption, but impacts billing in some way (i.e., there are charges in your rates based on the number and type of items installed at a service point). Examples include street lights, light poles, and security cameras. Items are related to service points and a service point can have one or more items linked to it.

---

**FASTPATH:**

For more information about the control tables that must be set up before you can define an item, refer to [Configuring Device Types](#).

---

For more information about premises and service points, refer to [Understanding The "V"](#).

---

## Setting Up Premise Options

This section describes tables that must be set up before you can define premises.

### Defining Premise Types

Open **Admin > Geographic > Premise Type** to define the premise types used to categorize your premises.

#### Description of Page

Enter a unique **Premise Type** and a **Description** for every premise type.

**Allow CIS Division** controls whether premises of this type can use the CIS Division on the premise page. Valid values are Not Allowed, Optional, and Required.

If your implementation requires restricting data by CIS Division, it is recommended that Allow CIS Division be set to Required.

#### Where Used

Follow this link to open the data dictionary where you can view the tables that reference [CL\\_PREM\\_TYPE](#).

### Implementing Address Validation

In order to set up address validation, you must ensure that the following Option Types are defined with their corresponding values on the General System Configuration – Feature Configuration page:

Option Type	Description
Address Validation Script	Indicates the name of the BPA script to invoke when a user clicks on the validate address button. This option is required if the Allow Address Validation option is set to Y. The base product includes sample script C1-ValAddr that uses Oracle Spatial procedures and functions to geocode an address and return its matching quality code.
Allow Address Validation	Indicates whether an integration with address validation software is implemented. If set to Y, the system will render a validate button along with the address fields displayed throughout the application to trigger address validation. Valid values are 'Y' and 'N'. If set to Y, the Address Validation Script to invoke must be specified.

As described in the above table, the base product includes sample script C1-ValAddr uses Oracle Spatial procedures and functions to geocode an address and return a matching quality code. To use this script, ensure that the Oracle Spatial Geocoding (F1-ORAGEOCD) algorithm is plugged in on installation options for the geocoding service system event. A data source containing the geocoding data must also exist on the database.

If your implementation uses something other than Oracle Spatial for address validation, you'll need to create a new address validation BPA script to specify on the General System Configuration feature configuration. For additional information about creating this script, see the steps descriptions for the C1-ValAddr script in the application. The new script should contain the following move step to update the page:

- If the calling page is an old style page, the move from the BPA to the page can be achieved by specifying a move step from a source field to a User Interface Field.
- If the calling page is a display map, the move from the BPA to the page can be achieved by specifying a step to read the Business Object, modify the values as returned by the validation software, and then update the BO.

## Setting Up Generic Service Point Options

This section describes tables that must be set up before you can define service points.

### Setting Up Service Point Types

Every service point must reference a service point (SP) type. The SP type controls almost all aspects of the service point's behavior (e.g., the type of field activity that may be dispatched to it, the type of service agreement that may be linked to it, the type of device that may be installed at it).

The topics in this section describe the windows used to set up your SP types.

---

**WARNING:**

Setting up SP types requires careful analysis of your company's SA types, field activities, and its consumption estimation philosophy. Refer to [Designing SP Types](#) for more information about this design process.

---

### Setting Up Premise & Service Point Postal Defaults

You set up postal defaults if your company is able to default field values onto new premises and service points based on the premise's postal code. The topics in this section describe how to maintain postal defaults.

---

**FASTPATH:**

For more information about where these default values are used, refer to [Maintaining Premises](#) and [Maintaining Service Points](#).

---

### Postal Defaults - Main

To define premise postal defaults, open **Admin > Geographic > Postal Code Default > Add**.

**Description of Page**

Enter the **Country Code** and range of postal codes to which the default values apply using the **From Postal Code** and **To Postal Code**.

---

**NOTE:**

You may not have postal defaults whose from / to postal codes overlap.

---

Trend Area is not applicable for Customer to Meter.

Enter the **County** to be defaulted onto new premises located in this postal code range.

Enter the **City** to be defaulted onto new premises located in this postal code range.

Enter the **CIS Division** to be defaulted onto new premises located in this postal code range.

Enter the **State** to be defaulted onto new premises located in this postal code range.

Enter the **Time Zone** to be defaulted onto new premises located in this postal code range.

Use the **Characteristic Types and Values** collection to define the **Characteristic Types** and their respective **Characteristic Values** to be defaulted on premises located in this postal code range. In addition to providing interesting information, these characteristics may also determine the prices and tax rates on the bills generated for the services consumed at a premise.

---

**FASTPATH:**

For more information about characteristics, see [Setting Up Characteristic Types & Their Values](#) and [An Illustration Of A Bill Factor And Its Characteristics](#).

---

Use the **Geographic Types and Values** collection to define the **Geographic Types** and their respective **Values** to be defaulted on premises located in this postal code range. In addition to providing interesting information, these values may be used to sort field activities in geographic value order.

**Where Used**

This information is defaulted when a new Premise is added. Characteristics and geographic values are also defaulted when the postal code for a Premise is changed. Refer to [Maintaining Premises](#) for more information.

## Postal Defaults - Service Default

To define values to be defaulted for a service point located in a postal range, open **Admin > Geographic > Postal Code Default > Search** and navigate to the **Service Defaults** page.

---

**FASTPATH:**

For more information about where these default values are used, refer to [Maintaining Service Points](#).

---

**Description of Page**

Use the **Service Defaults** collection to define values to be defaulted on service points located in a given postal code range belonging to a given **Service Type** (note, a service point's Service Type comes from its SP Type).

**Stock Location** is not applicable for Customer to Meter.

- Use the **Characteristic Types and Values** collection to define the **Characteristic Types** and their respective **Characteristic Values** to be defaulted on new service points located in this postal code range. In addition to providing interesting information, these characteristics may also determine the prices and tax rates on the bills generated for the services consumed at a service point.
- Use the **Geographic Types and Values** collection to define the **Geographic Types** and their respective **Values** to be defaulted on new service points located in this postal code range. In addition to providing interesting information, these values may be used to sort field activities in geographic value order.

## Designing SP Types

Every service point must reference an SP type. When you set up an SP type, you define how the system manages many aspects of its service points' behavior.

---

**NOTE:**

**Perfect foresight.** In a perfect world, the other control tables would have been set up with perfect foresight of setting up your SP types. In reality, setting up your SP types may invalidate some of your earlier decisions. Don't feel bad if this happens, some amount of iteration is natural.

---

Designing your SP types is an iterative process. To minimize the number of iterations, we recommend using the steps outlined in this section to complete the following table. When the table is complete, you're ready to set up your SP types.

SP Type	Service Type
---------	--------------

## Service Segmentation

At a minimum, you will have one SP type for every different type of service that exists at your premises. If we assume that your organization sells gas, water, waste water and electricity services, you will need four SP types.

SP Type	Service Type
<b>GAS</b>	Gas service
<b>WATER</b>	Water service
<b>WASTE WATER</b>	Waste water service
<b>ELECTRIC</b>	Electric service

## Device Segmentation

For each service, determine if there exist meters, badged items, or non-badged items at the service points. For example, if we assume:

- Electric service has service points with meters, badged lamps, and parking lots.
- Gas and water services just use meters.
- Waste water service doesn't actually have a meter installed at it (it uses the water consumption measured by the water service point's meter)

Then your SP types will be:

SP Type	Service Type	SP Sub Type
<b>GAS - METERED</b>	Gas service	Meter
<b>WATER - METERED</b>	Water service	Meter
<b>WASTE WATER</b>	Waste water service	Unbadged
<b>ELECTRIC - METERED</b>	Electric service	Meter
<b>ELECTRIC - BADGED LAMP</b>	Electric service	Item
<b>ELECTRIC - PARKING LOT</b>	Electric service	Unbadged

## SA Type Segmentation

Every SP Type whose service points can be linked to a service agreement has one or more SA types. These define which type of service agreements can pay for the service point's service. If different service points have different valid SA types, you will need to split the SP types accordingly.

The SA Type segmentation of SP Types is the most complicated design decision you'll have to make. Unfortunately, the decision making process is subjective and iterative. The iterations are caused by the fact that the number of SA types is dependent on the number of SP types (and vice versa). We recommend the following to help work your way through this conundrum:

- Design your SA types using the information in [Defining Service Agreement Types](#).
- Return to your SP types and determine if, given the proposed SA types, you can define a list of valid SA types for each SP type. If you find the population of SA types (and their valid rates) could result in invalid rates paying for service at a service point, divide your SA types further.

## Defining Bill and Measurement Cycles

This chapter is dedicated to issues related to defining cycles, routes and schedules in the system.

### Defining Bill and Measurement Cycles

Every account references a bill cycle. An account's bill cycle controls when it is billed.

Every manually read metered service point references a measurement cycle. A service point's measurement cycle controls when a service point's meter is measured.

The design of your measurement and bill cycles is inextricably linked because you probably want to bill your customers shortly after their meter devices are measured.

In this section, we describe how to design and set up these cycles. In addition, we discuss how to set up bill period schedules. These are used to define the bill segment end date for special types of non-metered service agreements.

---

**NOTE:**

**Recommendation.** We recommend reviewing [Bill Frequency - Bill Cycle vs Bill Segment Duration](#) before setting up this information.

---

## The Big Picture of Bill Cycles, Measurement Cycles, and Bill Periods

The topics in this section provide background information about a variety of bill cycle, measurement cycle, and bill period issues.

### Designing Cycles for Metered Services

The topics in this section provide background information about a variety of measurement cycle issues.

### A Description of the Cyclical Meter Read Process

Manual meter readers using handheld devices record most meter reading measurements in the field. These meter reads are uploaded into the system for use by Oracle Utilities Meter Data Management.

A service point's installed meter device is measured due to the following data relationships:

- Every metered service point references a schedule route.

- A route references a measurement cycle.
- A measurement cycle has measurement cycle schedules that define when the service points in the cycle are measured.
- Every measurement cycle schedule contains two dates:
  - **Scheduled selection date.** This is the date Meter Data Management could use to select the service points in the cycle for download to your handheld software via custom algorithms to create handheld activities when pending measurement cycle schedules are proposed (refer to [Measurement Cycle and Bill Determinants](#) for more information).
  - **Expected work date.** This is the date the meter is expected to be read.

---

**NOTE:**

**Overriding a route within a specific schedule.** Rather than downloading all routes within a cycle, you can set up the system so that only specific routes are downloaded on any given date. This is a very powerful feature. You can use it, for example, to estimate specific cycles every other month or indicate the customer reads the meter every third month. Refer to [Designing Measurement Cycles, Routes, And Schedules](#) for more information.

---

- On the scheduled selection date, Meter Data Management could create a download file, via custom algorithms, containing information to be sent to your handheld software. This download file should contain information about every register or measuring component on every meter in the routes being downloaded.
- Your handheld software distributes this information to the handheld devices and then your meter readers do their job. When they finish, the resultant measurements are uploaded into the system for subsequent use by other processes such as usage transactions for billing.

---

**WARNING:**

It is very important to create a measurement cycle schedule for every expected read date regardless of whether the cycle's routes are downloaded. Why do you have to do this? Because Meter Data Management uses the expected work date on the measurement cycle to know when to look for a measurement during usage calculations. If it can't find a reading on or near this date, Oracle Utilities Meter Data Management may estimate consumption. Without a measurement cycle schedule, MDM wouldn't know when to look for readings. So, for example, if you estimate a given cycle's consumption EVERY OTHER MONTH, you must create a measurement cycle schedule for EVERY month. On each month's schedule, you must define if the routes should be downloaded.

---

---

**FASTPATH:**

For more information about the how to control when a cycle is read, refer to [Setting Up Measurement Cycle Schedules](#).

---

## Designing Measurement Cycles, Routes, And Schedules

The topics in this section provide information describing how to design your measurement cycles, routes, and schedules.

- [Designing Measurement Cycles For Meter Reading](#)
- [Designing Schedule Routes For Meter Reading](#)
- [Designing Metered Measurement Cycle Schedules](#)

### Designing Measurement Cycles for Meter Reading

The criterion that affects the number of measurement cycles has nothing to do with when meter readers physically read your meter devices. Rather, the frequency that you bill the meter's consumption (real or estimated) is what controls the number of measurement cycles.

So, for example, if you bill every month, but read every OTHER month, you'll have 20 measurement cycles - one for each bill day during the month. If you bill bimonthly, you'll have 40 measurement cycles. If you bill quarterly, you'll have 60 measurement cycles. Etc.



---

**NOTE:**

**Different billing frequencies are possible for different service points.** If you have different billing frequencies for your different types of metered service, you'll need a different set of cycles for each billing frequency. For example, if you bill water quarterly and electricity monthly, you'll have 20 bill cycles (one for each bill day during a month), but you'd need 60 quarterly measurement cycles for your water service points, and 20 monthly measurement cycles for your electric service points. This would result in a customer getting billed every month. However, four times a year, their bill would contain a charge for both electricity and water.

---

[Top of the Page](#)

### Designing Service Routes For Meter Reading

The following points describe the relationship between a meter read, a route and a measurement cycle:

- A measurement cycle contains one or more routes.
  - A route has one or more service points.
  - A service point holds an installed meter device.
  - And a device is what is measured.
  - Therefore, the number of devices a person can read in a day limits the number of service points in a route.
- 

**WARNING:**

If your company supplies electric service and uses MV90's, you will need to take advantage of "notional" routes. A "notional" route's service points are never actually read by a human. Rather, the service points' consumption is fed to the system by a sophisticated device (e.g., an MV90). These service points still need to be linked to a route because usage calculation is dependent on the route's cycle to determine the expected meter read date.

---

[Top of the Page](#)

### Designing Metered Measurement Cycle Schedules

The process of designing your measurement cycle schedules is either easy or complicated. It will be easy if all routes within a cycle are downloaded when the measurement cycle is scheduled for download. It will be complicated if you download a subset of routes within a cycle on any given download date. We'll provide a few examples to help explain why.

If you download all cycles in a route whenever the cycle is downloaded, your measurement cycle schedule will look as follows.

---

**NOTE:**

**Bill cycles.** We've included each measurement cycle's related bill cycle to help you understand when the measurement cycle's consumption will be billed. Bill cycles are discussed in [Bill Cycles](#).

---

Measurement Cycle	Download Date	Expected Work Date	Which Routes To Download	Bill Cycle	Bill Window	Estimation Date
1	28-May-99	31-May-99	All	1	31-May-99 to 2-Jun-99	2-Jun-99
2	31-May-99	1-Jun-99	All	2	1-Jun-99 to 3-Jun-99	3-Jun-99
3	1-Jun-99	2-Jun-99	All	3	2-Jun-99 to 4-Jun-99	4-Jun-99
4	2-Jun-99	3-Jun-99	All	4	3-Jun-99 to 7-Jun-99	7-Jun-99

---

Etc. to 20

Now let's complicate life. If we assume you physically read your routes every other month (but bill monthly using estimated consumption), then you'll need the following measurement cycle schedule.

Measurement Cycle	Download Date	Expected Work Date	Which Routes	Bill Cycle	Bill Window	Estimation Date
1	30-May-99	31-May-99	1, 2, 3 - Download  4, 5, 6 - Estimate	1	31-May-99 to 2-Jun-99	2-Jun-99
2	31-May-99	1-Jun-99	1, 2, 3 - Download  4, 5, 6 - Estimate	2	1-Jun-99 to 3- Jun-99	3-Jun-99
3	1-Jun-99	2-Jun-99	1, 2, 3 - Download  4, 5, 6 - Estimate	3	2-Jun-99 to 4- Jun-99	4-Jun-99
4	2-Jun-99	3-Jun-99	1, 2, 3 - Download  4, 5, 6 - Estimate	4	3-Jun-99 to 7- Jun-99	7-Jun-99
Etc. to 20						
1	29-Jun-99	30-Jun-99	1, 2, 3 - Estimate  4, 5, 6 - Download	1	30-Jun-99 to 2-Jul-99	2-July-99
2	30-Jun-99	1-July-99	1, 2, 3 - Estimate  4, 5, 6 - Download	2	1-July-99 to 3- Jul-99	3-July-99
3	1-July-99	2-July-99	1, 2, 3 - Estimate  4, 5, 6 - Download	3	2-July-99 to 4- July-99	4-July-99
4	2-July-99	3-July-99	1, 2, 3 - Estimate  4, 5, 6 - Download	4	3-July-99 to 7- July-99	7-July-99

Etc. to 20

Notice the following:

- You still have 20 measurement cycles even though you only read the meters every other month. Why? Because Oracle Utilities Meter Data Management uses the expected work date on the measurement cycle to know when to look for

a measurement. If it can't find a reading on this date, Meter Data Management estimates consumption. Without a measurement cycle schedule, Meter Data Management wouldn't know when to look for readings.

- Every other month you download half the routes in each cycle and estimate consumption for the other half.
- If you don't download all routes when a measurement cycle is scheduled, you have to indicate how to handle every route in the cycle.

The above design is infinitely flexible. You can use it to handle any number of requirements:

- Estimate consumption every seventh month.
- Bill every month, but only read once a quarter.
- Etc.

## Bill Cycles

The topics in this section provide background information about a variety of bill cycle features.

### The Cyclical Billing Process & Window Billing

The cyclical bill creation process creates most bills. This process works as follows:

- Every account references a bill cycle. The bill cycle's schedule controls WHEN the system attempts to create bills for the account.
- Every bill cycle has a bill cycle schedule that defines the dates when a cycle's accounts are to be billed. Rather than attempt to create bills on one evening, most bill cycles use a concept of "window billing" where the system attempts to produce bills for accounts over a few nights. The first night (i.e., the day the window opens) should be the earliest day on which meter reads for the account can enter the system. The last night (i.e., the day the window closes) should be the last possible day in which a meter read can enter the system. This concept of window billing allows you to start billing accounts on the earliest possible day and then bill the stragglers over successive evenings. This results in much better cash flow.
- When the bill cycle creation process runs, it looks for bill cycles with open bill windows. It then attempts to create bills for the accounts in each such cycle. If a bill is created, it will send it out that evening. If a bill cannot be created, the system will create a bill in the "error" state with a message that can be analyzed by your billing staff. The next day, your staff can either correct the problem or not. When the bill cycle creation process next runs, it deletes all "error" bills and attempts to recreate them. It continues this throughout the bill window. If bills are in error at the end of the window, they will remain in this state until a user fixes them. If the bills are still in error when the cycle's next window opens, a billing error will be generated.

The following diagram should help clarify the above.

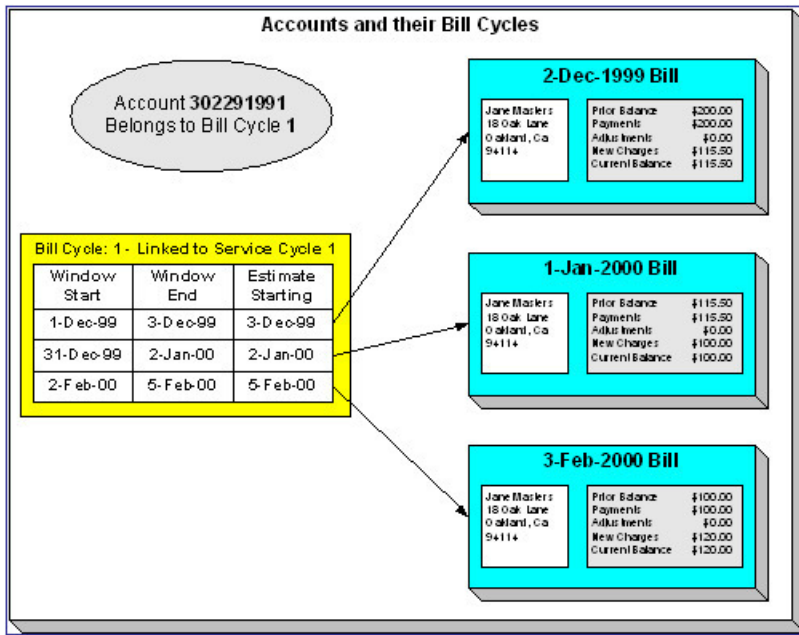

**FASTPATH:**

For more information about the how to control when bills are produced for a cycle, refer to [Bill Cycle - Bill Cycle Schedule](#).

## Designing Your Bill Cycle

The number of bill cycles is determined by the frequency that you bill your customers. So, for example, if you bill every month, you'll have 20 bill cycles - one for each bill day during the month. If you bill bimonthly, you'll have 40 bill cycles. If you bill quarterly, you'll have 60 bill cycles. Etc.

Keep in mind the following:

- You may need additional bill cycles if you allow customers to be billed off-cycle. For example, you could create a bill cycle called "Seniors" and link this to every senior citizen. You would set up this bill cycle's schedule to create bills shortly after social security checks are issued.
- You may need other bill cycles for customers with non-metered services (e.g., land leases, one time invoices).

**IMPORTANT:**

An account's bill cycle should attempt to create bill segments at least as often as the shortest service agreement duration. For example, if an account has both monthly and quarterly service agreements, the account should be placed on a monthly bill cycle. Refer to [Bill Frequency - Bill Cycle vs Bill Segment Duration](#) for more information.

## The Relationship Between Metered Measurement Cycles and Bill Cycles

As you can deduce, a service point's measurement cycle is related to an account's bill cycle.

The following table is an example of how you would set up the various dates on the various schedules that control meter reading and billing.

Measurement Cycle	Download Date	Expected Work Date	Bill Cycle	Bill Window	Estimation Date
1	28-May-99	31-May-99	1	31-May-99 to 2-Jun-99	2-Jun-99
2	31-May-99	1-Jun-99	2	1-Jun-99 to 3-Jun-99	3-Jun-99
3	1-Jun-99	2-Jun-99	3	2-Jun-99 to 4-Jun-99	4-Jun-99
4	2-Jun-99	3-Jun-99	4	3-Jun-99 to 7-Jun-99	7-Jun-99
Etc.					

Notice the following about this example:

- The bill cycle code is the same as the measurement cycle. This is not necessary, it's just good practice.
- The bill window starts on the first date on which a meter read could be uploaded.
- The bill window ends on the day after the last possible day a read could be uploaded for the bill cycle.
- Oracle Utilities Meter Data Management only estimates consumption on the last day of the bill window.

**FASTPATH:**

For more information about the bill cycle schedule, refer to [Setting Up Bill Cycles](#).

## How Does An Account Get Its Bill Cycle?

Most accounts are created behind-the-scenes when a user uses the "add account" option on [Person - Main Information](#). An account created like this doesn't have a bill cycle. Rather, it sits in limbo awaiting the activation of its first service agreement. When a service agreement is activated, the system populates the account's bill cycle using the following algorithm:

- If an account's bill cycle is protected, the activation of a service agreement will not affect an account's bill cycle. Refer to [Protecting An Account's Bill Cycle](#) for more information.
- If the service agreement being activated is for metered service, the account is given a bill cycle that will generate bills shortly after the service point is read. The route the system follows to get this bill cycle is a bit indirect:
  - A metered service agreement references one or more metered service points.
  - Every metered service point references a measurement cycle (the measurement cycle controls when the meter at the service point is read).
  - Every measurement cycle references a default bill cycle. It is this bill cycle that is populated on the account paying for service at the service point.
- If the service agreement being activated is for metered service and the associated service point is externally managed along with its measurement cycle and bill cycle, an external call is made to obtain the bill cycle from Meter Data Management. This bill cycle is assigned to the service agreement's account.
- If the service agreement being activated is not metered, the system cannot populate the account's bill cycle because there is no measurement cycle from which to default the bill cycle. This means the account's bill cycle will be blank until a user specifies a bill cycle for the account (using the Account page).

**NOTE:**

**A To Do entry highlights accounts without a bill cycle.** A To Do entry highlights those accounts that require a user to specify a bill cycle. This entry is generated for accounts without a bill cycle that have active service agreements.

---

When the last service agreement linked to an account is stopped, the account's bill cycle will be changed so that the account will be final billed when billing next executes. Refer to [What Happens At Finalization Time?](#) for more information.

When a service point's measurement cycle is updated, and the account's bill cycle is not protected, the system automatically updates the account's bill cycle to be in sync with the measurement cycle. Note that this will only take place if the Allow Bill Cycle Synchronization **Option Type** on the General System Options [Feature Configuration](#) is set to Y.

When an externally managed service point's measurement cycle is updated that results to a change in the bill cycle, a change notification is sent by Meter Data Management to trigger an corresponding update of the associated account's bill cycle in Customer Care and Billing. Note that this will only take place if the Allow Bill Cycle Synchronization **Option Type** on the General System Options [Feature Configuration](#) is set to Y.

## Protecting An Account's Bill Cycle

Over time, as a customer moves from premise to premise, their bill cycle is changed behind-the-scenes to be in sync with the latest service point's measurement cycle (as described in the previous section). If you do not want the system to change an account's bill cycle when a metered service agreement is activated, you need to turn on the account's **protect bill cycle** flag. You would do this if a customer liked to be billed at the start of the month regardless of when their device was read.

When the last service agreement for an account is stopped, the protect bill cycle flag is reset. This is to ensure that if the customer returns to start new service again, the bill cycle can be set based on [How Does An Account Get Its Bill Cycle](#).

## What Happens If An Account Has Service Agreements Spanning Metered Measurement Cycles?

A single account can have service agreements that are in several measurement cycles. The bill cycle on such an account will default based on the last activated metered service agreement.

It's important to be aware that an account will only have bills created when its bill cycle schedule so indicates. This means that the consumption for some service points could remain unbilled for a few weeks.

## Designing Bill Periods

Bill periods are used by non-metered service agreements whose bill end dates need to fall on strict dates. You need only set up this information if you have this type of service agreement.

---

### **FASTPATH:**

Refer to [Ways To Control The End Date Of A Bill Segment](#) for more information.

---

Every bill period has a calendar that defines when bill segments are created for service agreements that use the bill period. Examples of bill periods include:

- Quarterly Bill - Last Day Of Quarter
- Quarterly Future Bill - Last Day Of Quarter
- Monthly - 15th Day Of Month.
- Monthly Future Bill - Last Day Of Month.

The Quarterly Bill - Last Day Of Quarter bill period would have a schedule that looked as follows:

Earliest Date On Which To Create A Bill Segment	Bill End Date
1-Oct-1998	30-Sep-1998
1-Jan-1999	31-Dec-1998
1-Apr-1999	31-Mar-1999
1-Jul-1999	30-Jun-1999
...	

The Quarterly Future Bill - Last Day Of Quarter bill period would have a schedule that looked as follows:

Earliest Date On Which To Create A Bill Segment	Bill End Date
15-Dec-1998	31-Mar-1999
15-Mar-1999	30-Jun-1999
...	

The remainder of this section provides examples using the above calendars.

The following example assumes the following:

- The service agreement starts on 18-Dec-1998.
- The service agreement's SA type references the Quarterly Future Bill - Last Day Of Quarter bill period.

The following table shows when bill segments will be produced (assuming the account's bill cycle attempt to create segments as soon as possible) for several bill periods:

Earliest Date Segment Will Be Produced	Bill Period
18-Dec-1998	18-Dec-1998 thru 31-Mar-1999
15-Mar-1999	1-Apr-1999 thru 30-Jun-1999
...	

The following example assumes the following:

- The service agreement starts on 18-Dec-1998.
- The service agreement's SA type references the Quarterly Bill - Last Day Of Quarter bill period.

The following table shows when bill segments will be produced (assuming the account's bill cycle attempts to create segments as soon as possible) for several bill periods:

Earliest Date Segment Will Be Produced	Bill Period
1-Jan-1999	18-Dec-1998 thru 31-Dec-1998
1-Apr-1999	1-Jan-1999 thru 31-Mar-1999
...	

**FASTPATH:**

Refer to [Setting Up Bill Periods](#) for information about how to define this information.

## Setting Up Bill Cycles

An account references a bill cycle. The bill cycle defines when the account is billed and when the account's debt is checked to determine if it's overdue. To define a bill cycle and its bill cycle schedule, open **Admin > Billing > Bill Cycle > Add**.

### Description of Page

Enter a unique **Bill Cycle** and **Description** for every bill cycle.

If your implementation requires restricting bill cycles to accounts by CIS Division, specify a **CIS Division** on the bill cycle.

Use the **Bill Cycle Schedule** collection to define when bills are produced for the accounts in a given bill cycle. The following fields are required for each instance:

**Window Start Date** Specify the date on which the system should start trying to create bills for accounts in the cycle.

**Window End Date** Specify the last day on which the system will create bills for accounts in the cycle. This should be the last possible date on which a meter read could be loaded into Oracle Utilities Meter Data Management for the account.

**Accounting Date** Specify the financial date associated with the bills' financial transaction. The accounting date defines the financial period(s) to which the bills will be booked in your general ledger.

**Estimate Date** The date on which Oracle Utilities Meter Data Management may start estimating consumption if a real measurement cannot be found. When specified, this date is typically on or shortly before the window end date.

**Freeze and Complete** Turn on this switch if the system should freeze and complete any bill that is created without errors. If this switch is turned off, all bills created by the billing process will be left in the unfinished state. You would only turn this switch off if you want to verify an entire bill run prior to freezing it (e.g., if you are introducing a new version of a rate). If you turn this off, you will need to return to this page after verifying a bill run and turn it back on for the customers to receive bills. When the system next runs, it deletes all unfrozen bills and recreates them as per the instructions on the bill cycle schedule.

### Where Used

Follow this link to open the data dictionary where you can view the tables that reference [CI\\_BILL\\_CYC](#).

The batch bill creation process uses this schedule to define the bill cycles for which it should create bills.

---

#### NOTE:

**Don't forget.** After you set up the bill cycles that correspond with measurement cycles, go to [Setting Up Measurement Cycle Schedules](#) and update the measurement cycles accordingly.

---

## Setting Up Service Cycles And Measurement Cycle Schedules

Refer to [Measurement Cycles, Measurement Cycle and Bill Determinants](#), and [Setting Up Measurement Cycle Schedules](#) sections for more information

## Setting Up Measurement Cycle Schedules

---

#### FASTPATH:

Refer to [Designing Cycles for Metered Services](#) for more information about measurement cycle. Refer to [The Relationship Between Metered Service Cycles and Bill Cycles](#) for more information about how measurement cycles are linked to bill cycles.

---



## Description of Page

When you want to add a new measurement cycle schedule, you must specify the following information:

**Service Cycle** Enter the measurement cycle ID of the cycle whose routes will be downloaded.

**Scheduled Selection Date** Specify the date on which the system is meant to download information about the cycle's meters. This date should be a day or two before the scheduled work date.

Define the date the meters in the route are scheduled to be read using **Scheduled Work Date**. This date is extremely important as billing uses it when it looks for meter reads for service points in this cycle. If billing can't find a reading, consumption will be estimated as of this date (assuming the service agreement allows estimation).

Click **Pre-Generate Routes** if you need to finesse the cycle's routes on this Scheduled Selection Date (e.g., because some of the routes shouldn't be downloaded on a given date because the system is meant to estimate consumption). If you don't click this button, the system will create the routes on the scheduled selection date. It does this by creating a route extract for each downloadable route within the cycle (as defined by the route type). If you click this button, the system shows all routes within the cycle in the grid below. You must then define how the system is supposed to download each route on the scheduled selection date.

Click **Delete Routes** if you have pre-generated the routes and you want to remove them and allow the system to create the routes on the scheduled selection date.

Use the **Service Schedule Routes** to define how individual routes within the cycle should be handled during the download. The following fields are required for each schedule read date:

**Service Route** The unique ID of the service route. The route's route type is displayed adjacent.

**Schedule Type** This defines if and how the system is supposed to download the route's meter reads. Valid values are: Cust Read, Download, Estimate. Only those routes defined as Download will have meter reads downloaded. The other values are used to document why the route won't be downloaded.

**Schedule Status** This defines the download status of the route. Valid values are Pending and Complete. This value is only displayed for routes with a schedule type of Download.

### Where Used

This information is used by the meter read download process to determine which meter reads to download.

This information is used by the billing process to determine the date on which it expects to find a read. If it cannot find a read on or around this date, and it's OK to estimate consumption, consumption will be estimated as of the scheduled work date. The system uses the service agreement's rate schedule's frequency to determine the period of time around the scheduled work date in which it looks for a read. Refer to [Defining Frequency Codes](#) for more information.

## Setting Up Bill Periods

Some SA types reference a bill period. The bill period defines when the service agreement's bill segments are produced and the respective end date of each bill segment.

---

### FASTPATH:

Refer to [Designing Bill Periods](#) for more information.

---

To define a bill period and the bill period schedule, open **Admin > Billing > Bill Period > Add**.

### Description of Page

Enter a unique **Bill Period** and a **Description** for every bill period.

Use the **Bill Period Schedules** collection when the system should create bill segments for service agreements that use a given bill period. It also defines the end date of each respective bill segment. The following fields are required:

**Bill Date** Specify the earliest date on which the system is allowed to create a bill segment for service agreements using this bill period.

**Bill Seg End Date** Specify the end date of the bill segment. For future bills, this will be after the bill date. For retro bills, this will be before the bill date.

#### **Where Used**

Follow this link to open the data dictionary where you can view the tables that reference [CI\\_BILL\\_PERIOD](#).

This information is used by the bill segment creation process to determine the end date of service agreements that use a bill period.

## **Defining Statement Cycles**

If you have persons set up in the system to receive statements with financial information, you will need to assign them to a statement cycle and define a schedule for the statement cycle.

---

#### **FASTPATH:**

Refer to [The Big Picture of Complex Statements](#) for more information about statements.

---

## **The Big Picture Of Statement Cycles**

A statement cycle has a similar purpose to that of a bill cycle. It controls when statements will be produced.

### **The Cyclical Statement Process**

Persons who wish to receive statements will work with you to determine how often these statements should be produced. Some persons may want a monthly statement, some a quarterly and some annually. For each unique schedule that is designed for your various statement persons, you will set up a Statement Cycle and its schedule.

### **Designing Your Statement Cycles**

The number of statement cycles is determined by a combination of the frequency that you will send statements to the statement persons and how many statement cycles you wish to manage within the same frequency.

So, for example, for all the statement persons who wish to receive a monthly statement, will you create only one monthly Statement Cycle so that all monthly statements are produced the same day? Or will you have several monthly statement cycles scheduled throughout the month? The answer will depend on the volume of statements being produced and on how you want to manage the statement production.

### **Lifecycle of a Statement Cycle Schedule**

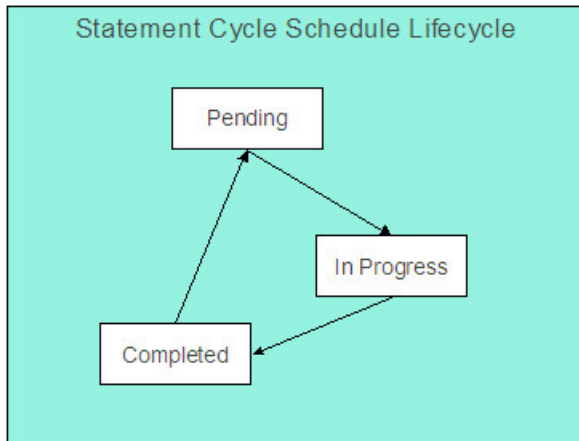

**Pending** The statement cycle schedule is added in this state. The Create Statements background process find records in this state to process on the appropriate date.

**FASTPATH:**

Refer to [Create Statements Background Process](#) for more information.

**In Progress** Records in this state are currently being processed by the Create Statements background process.

**Completed** Records in this state have already been processed by the Create Statements background process. If a problem occurs with the Create Statements background process and it needs to be rerun, simply change the status back to pending and rerun the process.

## Setting Up Statement Cycles

A Statement Construct references a statement cycle. The statement cycle defines when the statement person will receive statements with financial information related to the accounts and service agreements linked to the statement construct. To define a statement cycle and its statement cycle schedule, open **Admin > Billing > Statement Cycle > Add**.

### Description of Page

Enter a unique **Statement Cycle** and **Description** for every statement cycle.

Use the **Statement Cycle Schedule** collection to define when statements are produced for the persons with statement construct records in the given statement cycle. The following fields are required for each instance:

**Processing Date** Specify the date on which the system should create statements for persons with statement construct records in the cycle.

**Status** Indicates the status of the cycle schedule. Refer to [Lifecycle of a Statement Cycle Schedule](#) for more information.

### Where Used

Follow this link to open the data dictionary where you can view the tables that reference [CI\\_STM\\_CYC](#).

The batch statement creation process uses this schedule to determine which statement cycles for it should create statements for the statement construct records. Refer to [Create Statements Background Process](#) for more information.

## Defining Service Agreement Type (SA Types)

Every service agreement must reference a SA type. The SA type defines what you sell, how much you sell it for, to whom you sell it, how overdue debt is collected, and how sales will be booked in your general ledger.

**NOTE:**

**Perfect foresight.** In a perfect world, the other control tables would have been set up with perfect foresight of setting up your SA types. In reality, setting up your SA types may invalidate some of your earlier decisions. Don't feel bad if this happens, some amount of iteration is natural.

## Designing SA Types For Service Agreements With Service Points

Designing your SA types is an iterative process. To minimize some iterations, we recommend using the steps outlined in this section to complete the following table. When the table is complete, you're ready to set up your SA types.

Division/SA Type	Service Type
------------------	--------------

The topics in this section provide guidelines describing how to fill in this table for SA types associated with service agreements that charge for service point-oriented services.

### CIS Division Segmentation

A CIS division is typically associated with a jurisdiction. The definition of a jurisdiction is a geographic-oriented entity with unique business rules. For example, if you conduct business in California and Nevada, and each state has different collection rules, you will need a separate jurisdiction for each state. You must set up a CIS division for each jurisdiction in which you conduct business.

If we assume that you are located in a single jurisdiction - say California - we will need a single CIS division for all of our SA types.

CIS Division/SA Type
CA

### Service Segmentation

At a minimum, you will have one SA type for every different type of utility service offered by your organization. If we assume you sell electricity, gas, water, wastewater and cable; your SA Types will be as follows:

CIS Division/SA Type	Service Type
CA/G	Gas service
CA/W	Water service
CA/E	Electric service
CA/WW	Waste water service
CA/CABLE	Cable

## Receivable Segmentation

Many organizations segregate their receivable balances in the general ledger. For example, the receivable amount associated with gas and water service may be maintained in separate GL accounts.

If your organization does this, you will probably have at least one SA type for each such receivable account because each SA type references a distribution code that typically contains the receivable account.

- The word *probably* is underlined because this is a rule of thumb. There are situations where the number of receivable accounts isn't directly related to the number of SA types. This happens when an organization maintains very detailed receivable accounts in the general ledger and maintaining a one-to-one relationship between SA types and distribution codes would lead to a massive proliferation of SA types (and you don't want this!). If your organization maintains very detailed receivable accounts, please speak to your implementers, they should be able to introduce a small customization to generate the appropriate receivable account rather than extract it from the distribution code.
- The word *typically* is underlined because there are several SA types that don't book to a receivable account when bill segments are generated. For example, company usage and charitable contributions. Refer to [Company Usage Segmentation](#) and [Charitable Contribution Segmentation](#) for examples of SA types that don't book to receivable accounts.

We'll simplify our example and assume your organization has one receivable account for all types of utility service. Given this, we won't need additional SA types to support receivable segmentation:

CIS Division/ SA Type	Service Type	Distribution Code
CA/G	Gas service	A/R-UTIL
CA/W	Water service	A/R-UTIL
CA/E	Electric service	A/R-UTIL
CA/WW	Waste water service	A/R-UTIL
CA/CABLE	Cable service	A/R-UTIL

## Revenue Segmentation

Look at your rates and determine which rates can be used by each SA type. The following table shows the sample rates that can be used for each service:

CIS Division/ SA Type	Service Type	Distribution Code	Rates
CA/G	Gas service	A/R-UTIL	GALL-1
CA/W	Water service	A/R-UTIL	WALL-1
CA/E	Electric service	A/R-UTIL	ERES-1, ERES-2, ECOM-1, EIND-1, ELAMP-1
CA/WW	Waste water service	A/R-UTIL	WWALL-1
CA/CABLE	Cable service	A/R-UTIL	CABLE

Now, look at the rates' calculation rule GL Distribution window. You're looking for calculation rules whose GL distribution is affected by revenue class. If there are no revenue classes referenced on the calculation rules, this means that the revenue associated with the rate will be booked to a single GL account regardless of the type of customer. If you see revenue classes, this means that the revenue account associated with the calculation rule(s) differs depending on the SA type's revenue class. If revenue classes are used in the rates, you must create a different SA Type for every revenue class.

Let's assume the following:

- The gas rate (GALL-1) references the RESIDENTIAL, COMMERCIAL and INDUSTRIAL revenue classes in order to differentiate revenue based on the type of customer.
- None of the other rates differentiate revenue based on customer class.

Our SA types will now look as follows:

CIS Division/ SA Type	Service Type	Distribution Code	Revenue Class	Rates
<b>CA/G-RES</b>	Gas service	A/R-UTIL	R - residential	GALL-1
<b>CA/G-COM</b>	Gas service	A/R-UTIL	C - commercial	GALL-1
<b>CA/G-IND</b>	Gas service	A/R-UTIL	I - industrial	GALL-1
<b>CA/W</b>	Water service	A/R-UTIL	N/A	WALL-1
<b>CA/E</b>	Electric service	A/R-UTIL	N/A	ERES-1, ERES-2, ECOM-1, EIND-1, ELAMP-1
<b>CA/WW</b>	Waste water service	A/R-UTIL	N/A	WWALL-1
<b>CA/CABLE</b>	Cable service	A/R-UTIL	N/A	CABLE

Notice that we created new SA types for gas in order to specify the respective revenue class. We didn't do this for the other services because it isn't necessary. However, you should feel free to do this if it feels right or if you need it for reporting purposes. For example, if you want to report on all *residential* service agreements, but you differentiate only gas by residential versus commercial, you'll be in trouble.

## Rate Segmentation

Every SA Type whose service agreements have their charges calculated with a rate must have one or more rates linked to it. These define which rates can be linked to the SA type's service agreements. If different service agreements have different valid rate combinations, you will need to split the SA types accordingly.

For example, look at the electric rates. If we assume:

- the RES rates can only be used for residential customer,
- the IND rates can only be used for industrial customers,
- the COM rates can only be used for commercial customers,
- the LAMP rates can only be used for lamp customers

Then you might want to set up a new SA type to indicate such. The advantage of doing this is that you get more control over which rates can be used on a given SA type. The disadvantage is that you proliferate SA types. Unfortunately, it's really a question of taste.

CIS Division/ SA Type	Service Type	Distribution Code	Revenue Class	Rates
--------------------------	--------------	-------------------	---------------	-------

<b>CA/G-RES</b>	Gas service	A/R-UTIL	R - residential	GALL-1
<b>CA/G-COM</b>	Gas service	A/R-UTIL	C - commercial	GALL-1
<b>CA/G-IND</b>	Gas service	A/R-UTIL	I - industrial	GALL-1
<b>CA/W</b>	Water service	A/R-UTIL	N/A	WALL-1
<b>CA/E-RES</b>	Electric service	A/R-UTIL	N/A	ERES-1, ERES-2
<b>CA/E-COM</b>	Electric service	A/R-UTIL	N/A	ECOM-1
<b>CA/E-IND</b>	Electric service	A/R-UTIL	N/A	EIND-1
<b>CA/LAMP</b>	Electric service	A/R-UTIL	N/A	ELAMP-1
<b>CA/WW</b>	Waste water service	A/R-UTIL	N/A	WWALL-1
<b>CA/CABLE</b>	Cable service	A/R-UTIL	N/A	CABLE

**WARNING:**

Don't be too specific in your analysis in respect of rate segmentation because you could end up with a separate SA type for every rate (and you don't want this). We understand this is a very subjective warning, but we recommend that you start out with broad bands of rates that can be used on a SA type and narrow it down if you end up unhappy with the results. For example, you don't have to set up a separate SA type for low-income residential gas customers just because they have a special rate. Rather, you can leave your SA types as they are and treat low-income gas customers as a subset of your residential gas customers. **For more information**, refer to [Setting Up Start Options](#).

**NOTE:**

**Rate override.** If a service agreement of this type may be linked to a terms of service record, you must also consider whether or not the [rate schedule could be overridden](#) by a template SA linked to the terms of service record. Refer to [SA Type - Rate](#) for information about the possible values for this field.

## Service Point (SP) Type Segmentation

Every SA Type whose service agreements exist to bill for service point-oriented service has one or more SP types. These define which type of service points can be linked to the SA type's service agreements. If different service agreements have different valid SP types, you will need to split the SA types accordingly.

For each service point-oriented SA type, determine if there are any restrictions in respect of the types of service points that can use the SA type's rates. For example, if we assume that only commercial SP types can be used by commercial customers, industrial SP types by industrial customers, residential SP types by residential customers, your SA types will be:

CIS Division/ SA Type	Service Type	Distribution Code	Revenue Class	Rates	SP Type
<b>CA/G-RES</b>	Gas service	A/R-UTIL	R - residential	GALL-1	G-RES
<b>CA/G-COM</b>	Gas service	A/R-UTIL	C - commercial	GALL-1	G-COM
<b>CA/G-IND</b>	Gas service	A/R-UTIL	I - industrial	GALL-1	G-IND
<b>CA/W-RES</b>	Water service	A/R-UTIL	N/A	WALL-1	W-RES
<b>CA/W-COM</b>	Water service	A/R-UTIL	N/A	WALL-1	W-COM
<b>CA/W-IND</b>	Water service	A/R-UTIL	N/A	WALL-1	W-IND
<b>CA/E-RES</b>	Electric service	A/R-UTIL	N/A	ERES-1, ERES-2	E-RES

<b>CA/E-COM</b>	Electric service	A/R-UTIL	N/A	ECOM-1	E-COM
<b>CA/E-IND</b>	Electric service	A/R-UTIL	N/A	EIND-1	E-IND
<b>CA/WW-RES</b>	Wastewater service	A/R-UTIL	N/A	WWALL-1	W-RES, WW-RES
<b>CA/WW-COM</b>	Wastewater service	A/R-UTIL	N/A	WWALL-1	W-COM, WW-COM
<b>CA/WW-IND</b>	Wastewater service	A/R-UTIL	N/A	WWALL-1	W-IND, WW-IND
<b>CA/CABLE</b>	Cable service	A/R-UTIL	N/A	CABLE	CABLE

Notice the wastewater SA types reference both water and waste water service points. This is intentional as wastewater service uses the consumption from the water service to calculate some part of the wastewater charge.

## Company Usage Segmentation

Up to now, we've discussed SA types associated with service agreements linked to your customers. The system has also been designed to keep track of the expenses associated with your company's use of power. If you want the system to do this, you must create at least one SA type for each service consumed by your organization.

For example, if we assume your organization consumes electric, gas, and water service; your SA types will now be as follows:

CIS Division/ SA Type	Service Type	Distribution Code	Revenue Class	Rates	SP Type	Bill Seg Type
<b>CA/G-RES</b>	Gas service	A/R-UTIL	R - residential	GALL-1	G-RES	BD-RATED
<b>CA/G-COM</b>	Gas service	A/R-UTIL	C - commercial	GALL-1	G-COM	BD-RATED
<b>CA/G-IND</b>	Gas service	A/R-UTIL	I - industrial	GALL-1	G-IND	BD-RATED
<b>CA/W-RES</b>	Water service	A/R-UTIL	N/A	WALL-1	W-RES	BD-RATED
<b>CA/W-COM</b>	Water service	A/R-UTIL	N/A	WALL-1	W-COM	BD-RATED
<b>CA/W-IND</b>	Water service	A/R-UTIL	N/A	WALL-1	W-IND	BD-RATED
<b>CA/E-RES</b>	Electric service	A/R-UTIL	N/A	ERES-1, ERES-2	E-RES	BD-RATED
<b>CA/E-COM</b>	Electric service	A/R-UTIL	N/A	ECOM-1	E-COM	BD-RATED
<b>CA/E-IND</b>	Electric service	A/R-UTIL	N/A	EIND-1	E-IND	BD-RATED
<b>CA/WW-RES</b>	Wastewater service	A/R-UTIL	N/A	WWALL-1	W-RES, WW-RES	BD-RATED
<b>CA/WW-COM</b>	Wastewater service	A/R-UTIL	N/A	WWALL-1	W-COM, WW-COM	BD-RATED
<b>CA/WW-IND</b>	Wastewater service	A/R-UTIL	N/A	WWALL-1	W-IND, WW-IND	BD-RATED
<b>CA/CABLE</b>	Cable service	A/R-UTIL	N/A	CABLE	CABLE	BD-RATED
<b>CA/E-COY</b>	Electric service	EXP-COMP	N/A	E CO USE	E-CO USE	COMPUSAG
<b>CA/G-COY</b>	Gas service	EXP-COMP	N/A	G CO USE	G-CO USE	COMPUSAG
<b>CA/W-COY</b>	Water service	EXP-COMP	N/A	W CO USE	W-CO USE	COMPUSAG

Notice the three company usage SA types do not reference an A/R account as their distribution code. This is because when bill segments are created for these types of service agreements, the system must debit an expense account (or contra-revenue account) rather than a receivable account.



Also notice we introduced a new column - Bill Segment Type. Notice that the customer-oriented SA types use the BD-RATED bill segment type and the company usage SA types use the COMPUSAG bill segment type. Different bill segment types are necessary because company usage SA types use a different algorithm to calculate their bill segment's financial transaction algorithm because they don't affect either payoff or current balance.

**FASTPATH:**

For more information, refer to [Designing and Defining Bill Segment Types](#).

## Debt Class Segmentation

Every SA Type has a debt class. The debt class is used to categorize a service agreement's debt for the purpose of credit and collections (C&C) analysis. If a given SA Type has different categories of debt from C&C's perspective, you will have to split the SA Type.

**FASTPATH:**

For more information about debt class, refer to [Designing Your Collection Procedures](#).

If we assume that your residential services are regulated and your commercial and industrial services are deregulated, we won't have to introduce additional SA types.

CIS Division/ SA Type	Distribution Code	Revenue Class	Rates	SP Type	Bill Seg Type	Debt Class
<b>CA/G-RES</b>	A/R-UTIL	R - residential	GALL-1	G-RES	BD-RATED	REGU
<b>CA/G-COM</b>	A/R-UTIL	C - commercial	GALL-1	G-COM	BD-RATED	UNRE
<b>CA/G-IND</b>	A/R-UTIL	I - industrial	GALL-1	G-IND	BD-RATED	UNRE
<b>CA/W-RES</b>	A/R-UTIL	N/A	WALL-1	W-RES	BD-RATED	REGU
<b>CA/W-COM</b>	A/R-UTIL	N/A	WALL-1	W-COM	BD-RATED	UNRE
<b>CA/W-IND</b>	A/R-UTIL	N/A	WALL-1	W-IND	BD-RATED	UNRE
<b>CA/E-RES</b>	A/R-UTIL	N/A	ERES-1, ERES-2	E-RES	BD-RATED	REGU
<b>CA/E-COM</b>	A/R-UTIL	N/A	ECOM-1	E-COM	BD-RATED	UNRE
<b>CA/E-IND</b>	A/R-UTIL	N/A	EIND-1	E-IND	BD-RATED	UNRE
<b>CA/WW-RES</b>	A/R-UTIL	N/A	WWALL-1	W-RES, WW-RES	BD-RATED	REGU
<b>CA/WW-COM</b>	A/R-UTIL	N/A	WWALL-1	W-COM, WW-COM	BD-RATED	UNRE
<b>CA/WW-IND</b>	A/R-UTIL	N/A	WWALL-1	W-IND, WW-IND	BD-RATED	UNRE
<b>CA/CABLE</b>	A/R-UTIL	N/A	CABLE	CABLE	BD-RATED	UNRE
<b>CA/E-COY</b>	EXP-COMP	N/A	E CO USE	E-CO USE	COMPUSAG	No debt
<b>CA/G-COY</b>	EXP-COMP	N/A	G CO USE	G-CO USE	COMPUSAG	No debt
<b>CA/W-COY</b>	EXP-COMP	N/A	W CO USE	W-CO USE	COMPUSAG	No debt

Notice the three company usage SA types do not have a debt class. This is because their bill segment type's FT algorithm doesn't cause debt to be created and therefore there is no reason to have a debt class. However, you'll need to create a "dummy" debt class - call it N/A - for these SA types because every SA type must reference a debt class.

## Budget Billing Segmentation

Many utilities offer their customers levelized payment plans to smooth out the seasonal bill variations. We call this levelized amount the *budget amount*.

### FASTPATH:

Refer to [Budget Billing](#) for more information about budgets in general. Refer to [Billing - Current Balance versus Payoff Balance](#) for an example of budget billing accounting.

If we assume that you only allow budget billing on the electric and gas residential services, then you'll need to update your CA/G-RES and CA/E-RES SA types:

CIS Division/ SA Type	Dist Code	Rev Class	Rates	SP Type	Bill Seg Type	Debt Class	Recurring Charge Control Info
<b>CA/G-RES</b>	A/R-UTIL	R	GALL-1	G-RES	BD-RATED	REGU	Amount to bill is Not Allowed  Amount is Optional  Frequency is Monthly  Recurring Amount Label is Budget Amount:
<b>CA/G-COM</b>	A/R-UTIL	C	GALL-1	G-COM	BD-RATED	UNRE	
<b>CA/G-IND</b>	A/R-UTIL	I	GALL-1	G-IND	BD-RATED	UNRE	
<b>CA/W-RES</b>	A/R-UTIL	N/A	WALL-1	W-RES	BD-RATED	REGU	
<b>CA/W-COM</b>	A/R-UTIL	N/A	WALL-1	W-COM	BD-RATED	UNRE	
<b>CA/W-IND</b>	A/R-UTIL	N/A	WALL-1	W-IND	BD-RATED	UNRE	
<b>CA/E-RES</b>	A/R-UTIL	N/A	ERES-1, ERES-2	E-RES	BD-RATED	REGU	Amount to bill is Not Allowed  Amount is Optional  Frequency is Monthly  Recurring Amount Label is Budget Amount:
<b>CA/E-COM</b>	A/R-UTIL	N/A	ECOM-1	E-COM	BD-RATED	UNRE	
<b>CA/E-IND</b>	A/R-UTIL	N/A	EIND-1	E-IND	BD-RATED	UNRE	
<b>CA/WW-RES</b>	A/R-UTIL	N/A	WWALL-1	W-RES, WW- RES	BD-RATED	REGU	

CA/WW-COM	A/R-UTIL	N/A	WWALL-1	W-COM, WW-COM	BD-RATED	UNRE
CA/WW-IND	A/R-UTIL	N/A	WWALL-1	W-IND, WW-IND	BD-RATED	UNRE
CA/CABLE	A/R-UTIL	N/A	CABLE	CABLE	BD-RATED	UNRE
CA/E-COY	EXP-COMP	N/A	E CO USE	E-CO USE	COMPUSAG	No debt
CA/G-COY	EXP-COMP	N/A	G CO USE	G-CO USE	COMPUSAG	No debt
CA/W-COY	EXP-COMP	N/A	W CO USE	W-CO USE	COMPUSAG	No debt

Notice the following:

- We updated the two SA types to allow recurring charge information.
- The Recurring Charge Amount is Optional. Why? Because those customers who aren't on a budget plan won't have a recurring charge amount. Those customers on a budget will have a recurring charge amount.

**NOTE:**

**Turn on Eligible for Budget.** Besides indicating that these SA types use recurring charges, you also need to turn on the Eligible for Budget switch on the SA type to indicate that this type of SA participates in budget processing.

**Override Budget Eligibility.** You may plug in an override budget eligibility algorithm on an SA type that is configured to be Eligible for Budget if certain service agreements of this type are not eligible.

**FASTPATH:**

Refer to the Description of Page under [SA Type - Billing](#) for the definition of the recurring charge attributes.

## Designing SA Types For SAs Without Service Points

The topics in this section provide guidelines describing how to design the SA types associated with your service agreements that don't have service points.

## Overpayment Segmentation

When a customer pays more than they owe, you must decide what to do with the excess money. The following points describe two possibilities:

- You could create a new service agreement to hold the excess (let's call it an overpayment SA). The credit would be transferred from this service agreement to the billable service agreements when the next bill is completed. This means that all billable service agreements have the same opportunity to receive the overpayment when they are billed in the future.
- You could amalgamate the excess payment on one of the existing, billable service agreements. For example, if a customer has both electric and gas service, the excess funds could be kept on either the gas or the electric SA. This would result in the following:
  - The service agreements that do NOT receive the overpayment will have debt when they are next billed.
  - The service agreement that receives the overpayment could have its future debt offset by the overpayment (meaning that it could have a credit balance until the service agreement's future bill segments offset the overpayment amount).

- The above situation is not desirable unless the customer intentionally overpaid one service agreement. The first method (keeping the overpayment on a separate service agreement) obviates this potential problem. Obviously, if your organization sells a single service (and therefore your customers have a single service agreement) you would choose the second method.

You control which method is used by plugging in the appropriate Overpayment Distribution algorithm on each [Customer Class](#) (i.e., you can choose a different method for different customer classes). If you choose to hold overpayments on a separate SA, then you must set up an SA Type as described in the following table:

CIS Division/ SA Type	Service Type	Distrib. Code	Eligible for Billing	Debt Class	Pay Seg Type	Do Not Overpay	One-time
<b>CA/OVERPAY</b>	Other	A/P - OVER	Not billed	N/A	Normal	No	Yes

Notice the following about the new overpayment SA type:

- It has an interesting distribution code. This is because when a payment segment is created for this type of service agreements, the system must credit a liability (an overpayment is a liability).
- It's important to indicate that the overpayment SA is a one-time service agreement. Why? Because this means that the system will automatically close the SA when it's balance falls to zero (i.e., when all of the overpayment has been used to satisfy future bills).
- A bill segment type is not needed because the system never creates bill segments for such service agreements (they exist only to hold excess credits).
- You may also want to turn on the alert message
- You must plug-in a bill completion algorithm on this SA type. This bill completion algorithm will transfer the credit balance to the account's other service agreements when the bill is completed. Refer to [The Credit Transfer Algorithm](#) for more information about this algorithm.
- You must also reference this overpayment SA type as the parameter value on your overpayment algorithm (this algorithm is plugged in on the desired customer classes). Refer to [Overpayment Algorithm](#) for more information about this algorithm.

**NOTE:**

**If overpayment means charitable contribution.** Some organizations sponsor a program that works as follows - if a customer overpays a bill by a given amount (say \$5), this amount is assumed to be a charitable contribution. If you have this requirement, you will create another SA type to hold a customer's charitable contributions. This SA type will look similar to the one described below (see [Charitable Contribution Segmentation](#)) except it is not billable. The funds will be credited to this service agreement by creating a new overpayment algorithm that is similar to the base package [Overpayment Algorithm](#). This new algorithm will be very similar to the existing algorithm. The main difference will be that it will have to check if the overpayment amount is an exact value (say \$5). If so, it will create a payment segment for the charitable contribution SA type; otherwise it will create a payment segment for the overpayment SA.

## Write Off Segmentation

When you write off non-collectable debt, you transfer the receivable from a "normal" service agreement onto one or more write-off service agreements. When the debt is transferred to a write-off service agreement, the distribution code on the "normal" service agreement is credited (typically an A/R GL account), and the distribution code on the write-off service agreement is debited.

You will almost always need a write-off service agreement whose distribution code is the write-off expense. However, you probably don't book all of the write-off amount to a write-off expense account. Why? Because the debt that you're writing off typically contains both revenue and liabilities. At write-off time, you want to book the written off revenue to a write-off expense account and you want to reduce the liabilities (you don't owe the liability if you don't get paid). This means you'll

need another SA type for the liabilities. Refer to [The Ramifications of Write Offs in the General Ledger](#) for a complete explanation.

The following table contains the minimum number of SA Types that you'll need to hold your write-offs.

CIS Division/ SA Type	Service Type	Distrib. Code	Bill Seg Type	Debt Class	Pay Seg Type	Do Not Overpay
<b>CA/WO-STD</b>	Other	EXP-W/O	Not billed	WO	Normal	Yes
<b>CA/WO-LIA</b>	Other	LIA-General	Not billed	WO	Normal	Yes

Notice the following about the new write-off SA types:

- They have interesting distribution codes. This is because when debt is transferred to these types of service agreements, the system must debit either an expense account (i.e., write-off expense) or a liability account. It's important to note that in [The Ramifications of Write Offs in the General Ledger](#) we explain how this liability account may be overwritten with the liability account that was originally booked.
- Neither needs a bill segment type because the system never creates bill segments for such service agreements (they exist only to hold uncollectable debt)
- Even though the debt is not collectable, it still has a debt class. Why? Because the system shows a customer's debt on many inquiries by debt class and it's important to show write-off debt on these queries.
- The combination of Payment Segment Type and Do Not Overpay are important. Refer to [The Ramifications of Write Offs in the General Ledger](#) for a complete explanation.

**NOTE:**

The adjustment type used to set the offending service agreement's current balance equal to its payoff balance is defined on each write-offable SA type. The adjustment type used to transfer the delinquent debt to the write-off service agreement is defined on the write-off SA type.

**An Alternative.** If you have a limited number of liability accounts, you may decide to have a separate write-off service agreement for each liability account. Doing this would proliferate the number of service agreements created at write-off time. However, it would simplify the remittance of payment to the taxing authority if the reversed liability is ever paid.

## Connection Charge Segmentation

If you levy connection charges, you have two options:

- You can create a SA type that exists purely to handle connect charge debt. After doing this, you'd create a start option for this SA type that causes an adjustment to be levied as part of the start service process. This adjustment would contain your standard connection charge. This approach would be used by a utility that had multiple services (e.g., a combined electric, gas, water utility) that only levies a single connection charge regardless of the number of services started. If you use this approach, make sure to indicate the SA type is non billable.
- You can levy a start adjustment on one of your existing SA types (e.g., CA/E-RES). The easiest way to do this is with a start option. On the start option you'd indicate an adjustment to be levied as part of the start service process. This adjustment would contain your standard connection charge. This approach would be used by a utility that had a single service offering (e.g., an electric-only utility). Refer to [Setting Up Start Options](#) for more information.

In the table below, we show what would be necessary if you want to have a separate service agreement for the connection charge.

CIS Division/ SA Type	Service Type	Distrib. Code	Bill Seg Type	Debt Class
-----------------------	--------------	---------------	---------------	------------

Notice the following about the new connection charge SA type:

- It has a normal receivable distribution code.
- It doesn't need a bill segment type because the system never creates bill segments for such service agreements (its charged via an adjustment).
- The debt class is interesting - REGU (for regulated). We are intentionally linking the connection charge debt to the same debt class as the regulated debt from which it originates. This way, the C&C process will consider the connection charge debt the same as regulated debt and therefore perform the regulated collection (which results in the severance of all regulated service agreements).

## Charitable Contribution Segmentation

If your organization accepts charitable contributions made by your customers, you must create a SA type to hold these contributions.

CIS Division/ SA Type	Service Type	Distrib. Code	Debt Class	Bill Seg Type	Recurring Charge Control Info
CA/CHARITY	Other	A/P-CHAR	CHAR	RECUR	Amount to bill is Not Allowed  Amount is Required  Frequency is Monthly  Recurring Amount Label is Contrib. Amount

Notice the following about the new charitable contribution SA type:

- It has an interesting distribution code. This is because when a payment is distributed to these types of service agreements, the system must credit a payable account (i.e., charitable contribution payable) rather than a receivable account. Note well, we have assumed a receivable is not incurred when the bill segment for the charitable contribution is created.
- It uses an interesting bill segment type - RECUR. This bill segment type was set up to create recurring charges that don't automatically stop at some point in time.
- The debt class is interesting - CHAR (for charity). This is done so that past due charitable contribution debt is treated separately from other types of debt.
- The recurring charge control information is set up as defined.

### FASTPATH:

Refer to the Description of Page under [SA Type - Billing](#) for the definition of the recurring charge attributes. Refer to [Start Option Considerations For SA Types That Use Recurring Charges](#) for how you can use start options to automatically populate a service agreement's recurring charge fields with appropriate values when service is started.

### WARNING:

It's important that you assign the charitable contribution SA type with a payment segment type that only affect current balance (as opposed to affecting current AND payoff balance). This is because there is no receivable recognized when the contribution is billed and therefore there is no payoff balance to relieve when it's paid.

## Payment Arrangement Segmentation

If your organization allows customers to payoff outstanding debt using payment arrangements (e.g., current bill plus \$X), you will need a new SA type for every debt class that can have a payment arrangement. If we assume you can have payment arrangements for both regulated and unregulated debt, then you'll need at least two more SA types (you may have more SA types if you need to segregate the payment arrangement receivable amount by utility type (or some other type)).

CIS Division/ SA Type	Service Type	Distrib. Code	Debt Class	Bill Seg Type	Recurring Charge Control Info
<b>CA/PA-REGU</b>	Other	A/R-ARRG	REGU	RECUR-AS	Amount to bill is Not Allowed Amount is Required Frequency is Monthly Recurring Amount Label is Arrange Amount
<b>CA/PA-UNRE</b>	Other	A/R-ARRG	UNRE	RECUR-AS	Amount to bill is Not Allowed Amount is Required Frequency is Monthly Recurring Amount Label is Arrange Amount

Notice the following about the new payment arrangement SA types:

- They have an interesting distribution code. This is because when funds are transferred to these types of service agreements, the system must debit a receivable (i.e., payment arrangement receivable).
- They use an interesting bill segment type - RECUR-AS. This bill segment type was set up to create recurring charges that stop when the customer no longer has a payoff balance.
- Each new SA type references the debt class whose debt it will pay off. We are intentionally linking the payment arrangement debt to the same debt class as the regulated debt from which it originates. This way, the C&C process will consider the arrangement debt as the same as regulated debt and therefore perform the regulated collection (which results in the severance of all regulated service agreements).
- The recurring charge control information is set up as defined.

### FASTPATH:

Refer to the Description of Page under [SA Type - Billing](#) for the definition of the recurring charge attributes. Refer to [Start Option Considerations For SA Types That Use Recurring Charges](#) for how you can use Start Options to automatically populate a service agreement's recurring charge fields with appropriate values when service is started.

## Merchandise Segmentation - Installment Billing

If your organization allows customers to purchase merchandise using an installment plan, you must create a SA type for this.

**NOTE:**

**No installments.** If the customer must pay for the merchandise in one lump amount, you'd create an SA type similar to the [Connection Charge Segmentation](#) example.

CIS Division/ SA Type	Service Type	Distrib. Code	Debt Class	Bill Seg Type	Recurring Charge Control Info
CA/MERCH-I	Merch	A/R-MRCH	UNRE	RECUR-AS	Amount to bill is Not Allowed Amount is Required Frequency is Monthly Recurring Amount Label is Install Amount

Notice the following about the new merchandise SA type:

- It has a normal receivable distribution code.
- It uses an interesting bill segment type - RECUR-AS. This bill segment type was set up to create recurring charges that stop when the customer no longer has a payoff balance.
- The recurring charge control information is set up as defined.

**FASTPATH:**

Refer to the Description of Page under [SA Type - Billing](#) for the definition of the recurring charge attributes. Refer to [Start Option Considerations For SA Types That Use Recurring Charges](#) for how you can use start options to automatically populate a service agreement's recurring charge fields with appropriate values when service is started. Refer to [Start Option Considerations For SA Types That Use Initial Adjustments](#) for how you can use start options to automatically populate a service agreement's recurring charge fields with appropriate values when service is started.

## Deposit Segmentation - Installment Billing

If your organization allows customers to pay deposits using an installment plan, you must create an SA type for this.

**NOTE:**

**No installments.** If the customer must pay for the deposit in one lump amount, you'd create an SA type similar to the [Connection Charge Segmentation](#) example. Just make sure the adjustment that's levied to charge for the deposit amount doesn't affect payoff balance (when you bill a deposit, the customer doesn't really owe anything because it's not a true receivable from an accountant's perspective).



CIS Division/ SA Type	Service Type	Distrib. Code	Debt Class	Bill Seg Type	Recurring Charge Control Info
CA/DEP-I	Other	A/P-DEPO	DEP	RECURATB	Amount to bill is Required  Amount is Required  Frequency is Monthly  Recurring Amount Label is Install Amount

Notice the following about the new deposit SA type:

- It has an interesting distribution code. This is because when a payment is distributed to these types of service agreements, the system must credit a payable account (i.e., deposit payable) rather than a receivable account. Note well, we have assumed a receivable is not incurred when the bill segment for the deposit is created.
- It uses an interesting bill segment type - RECURATB. This bill segment type was set up to create recurring charges that stop when the system has billed the Total Amount to Bill.
- The debt class is interesting - DEP (for deposit). This is done so that past due deposit "debt" is treated separately from other types of debt.
- The recurring charge control information is set up as defined. Note well, the Amount to bill is Required.

**FASTPATH:**

Refer to the Description of Page under [SA Type - Billing](#) for the definition of the recurring charge attributes. Refer to [Start Option Considerations For SA Types That Use Recurring Charges](#) for how you can use start options to automatically populate a service agreement's recurring charge fields with appropriate values when service is started.

**NOTE:**

**Bill messages on receipt of deposit in full.** The base package includes a special FT Freeze algorithm that can be specified on deposit SA Types. It recognizes when a deposit has been paid in full, and creates a bill messages to inform the customer. Refer to algorithm DEP PIF MSG in [Algorithm Types](#) for more information.

## Billable Charge Segmentation

You create a billable charge whenever a customer should be charged for a service that occurs outside the normal course of business. For example, you would create a billable charge to charge a contractor for the repair of a ruptured gas line. You can also use billable charges to "pass through" other bill ready charges generated outside the system, by another application, or by a 3rd party supplier.

A billable charge must reference a service agreement. This service agreement behaves just like any other service agreement:

- **Bill segments are created for the service agreement.** Whenever billing is performed for an account with billable charge service agreements, the system creates a bill segment for each service agreement with unbilled charges. If multiple unbilled charges exist for a given service agreement, only one bill segment will be created and it will contain details about all of the billable charges.
- **Payments are distributed to the service agreement.** Payments made by an account are distributed to its billable charge service agreements just like any other service agreement.

- **Overdue debt is monitored.** The credit and collections process monitors billable charge service agreements for overdue debt and responds accordingly when overdue debt is detected.

Therefore, you must set up at least one SA type to hold your billable charge debt. You may have multiple charges based on billing frequencies, A/R booking, debt monitoring, etc. It's really up to you.

The easiest way to determine how many billable charge SA types you'll need is to define every conceivable billable charge (which you should have done when you designed your [billable charge templates](#)). Then ask yourself if they have the same billing and payment behavior, if so, you'll have one SA type. If not, you'll need one SA type for each combination.

We will assume your billable charges are all used to levy unusual one-off charges that can be collected in the same way, therefore we'll need one SA type.

CIS Division/ SA Type	Service Type	Distrib Code	Debt Class	Bill Seg Type	Billable Charge Templates	Rate
<b>CA/ONETIME</b>	Other	A/R-UTIL	UNRE	BILLCHRG	TREETRIM DAMAGE	None
<b>CA/PASSTHRU</b>	Electricity	A/R-OTHER	UNRE	BILLCHRG	None	None
<b>CA/ADDON</b>	Electricity	A/R-OTHER	EXTERNAL	BILLCHRG	None	TAXES

Notice the following about the new one time SA type:

- It has a normal receivable distribution code.
- Its debt class is unregulated.
- It uses an interesting bill segment type - BILLCHRG. This bill segment type was set up to create bill segments using billable charges.
- It references the valid billable charge templates that can be used on this SA type.

**NOTE:**

**One Time Charge.** The ONE TIME example shown above implies this SA type exists to hold one-time charges.

Because of this, you should turn on the One Time Charge switch on the SA type so that service agreement's of this type are automatically closed when final payment is received. You don't have to do this because a customer could have a single billable charge service agreement that is perpetually active for pass through charges (i.e., it doesn't have a stop date). If you do this, the system will create a bill segment for this service agreement whenever it finds an unbilled billable charge linked to the service agreement.

Notice the following about the pass through SA Type:

- It doesn't use the normal distribution code or debt class. This is done so that the debt and receivable can be tracked separately. If these charges were being pass through from another system, you might want to track these financial values separately.
- It still uses the normal bill segment type - BILLCHRG. From a billing perspective, there is no difference between this and the one time SA Type.
- Templates are not relevant - these charges are not created on-line using templates, but are loaded via the [Billable Charge Upload Staging](#).

Notice the following about the add on charges SA Type:

- This is an example of bill-ready charges (similar to pass through) to which the system adds on other charges, for example, taxes.
- It still uses the normal bill segment type - BILLCHRG. From a billing perspective, there is no difference between this and the one time SA Type.

- It also uses a Rate. In this case, the bill creation algorithm (specified on the bill segment type) will take any billable charge lines and attach them to a bill. In addition, these billable charges will include billable charge service quantities (SQs). These service quantities will also be swept onto the bill segment, and the Rate (TAXES in this example) will be applied. In order for taxes to be calculated, the billable charge SQs must include the total taxable amount - the system is not able to apply the rate on top of the other billable charges. But, it can apply the tax rate to the SQs that are supplied.
- You can also use this technique to bill other rate-ready service quantities, like kWh, CCF, *etc.* This is a way to process rate-ready data for which you have a contract, but you do not know the meter (and therefore, cannot collect real meter reads).
- If the rate has pre-processing calculation groups, these will be applied as well.

---

**FASTPATH:**

For more information about billable charge templates, refer to [Setting Up Billable Charge Templates](#).

---

## Over/Under Cash Drawer Segmentation

In order to balance a tender control that is out-of-balance, your organization must set up an account with a service agreement whose SA type references the over/under expense account. You will probably only have one service agreement that references this SA type, but you still must have it if you remit funds via a cash drawer.

---

**FASTPATH:**

For more information about over/under processing, refer to [How To Get An Unbalanced Tender Control In Balance \(Fixing Over/Under\)](#).

---

CIS Division/ SA Type	Service Type	Distrib. Code	Debt Class	Bill Seg Type
<b>CA/OVR UNDR</b>	Other	EXP-OV/UND	N/A	Not billed

Notice the following about the new SA type:

- It has an interesting distribution code. This is because when a payment segment is applied to this type of service agreement, the system must debit an expense account for under amounts (and credit it for over amounts).
- It doesn't need a bill segment type because the system never creates bill segments for such service agreements (it only has over/under payment segments linked to it).
- It uses the N/A debt class because the credit and collections process should never consider debt associated with service agreements of this type (because it's not really debt).

## Payment Upload Error Segmentation

If the payment upload process detects an invalid account on a payment upload record, it will create a payment for the suspense service agreement defined on the upload process' tender source (see [Setting Up Tender Sources](#)). You should create a special SA type for this service agreement.

---

**FASTPATH:**

For more information about the payment upload process, refer to [Phase 3 - Create Payment Events, Tenders, Payments, and Payment Segments](#).

---

CIS Division/ SA Type	Service Type	Distrib. Code	Debt Class	Bill Seg Type
<b>CA/SUSPENSE</b>	Other	EXP-MISC	N/A	Not billed

Notice the following about the new SA type:

- It has an interesting distribution code. This code should probably be a suspense account. All payment segments that are created for this service agreement will eventually be transferred to a "real" service agreement and therefore this GL account's balance should be zero when no payments are in suspense.
- It doesn't need a bill segment type because the system never creates bill segments for such service agreements (it only has invalid account payment segments linked to it).
- It uses the N/A debt class because the credit and collections process should never consider debt associated with service agreements of this type (because it's not really debt).

## CIAC Segmentation

If your company bills and refunds Contribution In Aid of Construction (CIAC) contracts, you must create one or more SA types. CIAC contracts are typically used to levy charges associated with line extensions. These types of service agreements are different from other service agreements because the initial amount charged is refunded to the original payee when new properties (or extensions) are added to the extension (or when the new properties are subsequently billed for service).

**NOTE:**

**Billable charges are used for the original CIAC service agreement.** CIAC SA types are always Billable Charge SA types because an operator must specify the exact amount to charge the contractor using a billable charge. Refer to [Billable Charge Segmentation](#) for more information.

The following points describe how CIAC processing is implemented in the system:

- When a new line extension is build, you will create a new service agreement that references your CIAC SA type. This service agreement should be linked to a service point associated with the extension. The easiest way to create this service agreement and link it to the service point is by using the Start Account transaction. It's important to remember to define your CIAC SA type as a valid SA type for the SP type used to represent the line extension.
- When a new premise / service point is built that "hangs" off the original extension, the new service point should be linked to the original service point. This can be done by referencing the original service point as the "parent" service point of the new service point using a [foreign key value characteristic](#).
- The system periodically monitors the original CIAC service agreement. The process that performs this monitoring is referenced on the original CIAC service agreement's SA type. The exact processing that takes place during this monitoring is up to your organization's specific business requirement. For example, if you refund 10% of every bill produced for the "downstream" service points to the original contractor, you would have logic in your CIAC monitoring process that looks for recent bill segments produced for the "downstream" service agreements and then creates an adjustment for the master service agreement.

**NOTE:**

**CIAC refunds are idiosyncratic.** Because CIAC refund processing is idiosyncratic, we do not supply any CIAC monitoring processes in the base package. This is because the likelihood that they could be used is extremely low because of your organization's unique requirements.

Therefore, if your organization performs CIAC processing, you should create a special SA type.

CIS Division/ SA Type	Service Type	Distrib. Code	Debt Class	CIAC Process	Bill Seg Type
<b>CA/CIAC</b>	Other	A/R - CIAC	UNRE	Refund based on percent of future bills	Billable Charge

## Loan Segmentation

If you loan money to customers that is recouped using an amortization schedule, you need to set up an SA type for the loan service agreement.

CIS Division/ SA Type	Service Type	Distrib. Code	Loan A/R Distrib. Code	Debt Class	Bill Seg Type
<b>CA/LOAN</b>	Other	A/R - LOAN	A/R - STLN	UNRE	LOAN

### FASTPATH:

Refer to [Setting Up The System To Enable Loans](#) for more information.

## Non-Billed Budget Segmentation

If you allow your customers to pay set amounts at specified intervals (e.g. every two weeks), you need to set up SA types for Non-Billed Budget service agreements. Non-billed budgets are typically used when your company bills on an infrequent basis and you want to provide your customers with a mechanism to make smaller payments more frequently. You may implement two types of Non-Billed Budgets monitored and unmonitored, each type requiring a different SA type. You may also implement different renewal options for Non-Billed Budgets.

CIS Division/ SA Type	Service Type	Distrib. Code	Non Billed Budget Monitoring	Debt Class	Renewal	Bill Seg Type
<b>CA/NBB-MON</b>	Other	A/P - OVPY	Monitored	NBB	Optional	Not billed
<b>CA/NBB-UNMON</b>	Other	A/P - OVPY	Unmonitored	N/A	Optional	Not billed

### FASTPATH:

For more information about monitored and unmonitored Non-Billed Budgets, refer to [Defining Non-Billed Budget Options](#).

## Designing SA Type For Other Segmentations

The earlier parts of this discussion described the most common factors that cause the creation of SA Types. However, many obscure factors could cause the introduction of more SA Types. In this section, we explain these more obscure factors.

### WARNING:

We strongly recommend not being too pedantic when considering the factors described in this section. If you can only think of a few strange situations that would necessitate a SA type, think carefully before you introduce it. It's better to be a little less than perfect than end up with large number of obscure SA types.

---

## Cash Distribution Segmentation

Every SA Type has a payment segment type. The payment segment type defines the cash account to which the SA type's payments should be booked. If different service agreements have different cash accounts, you will need to split the SA types accordingly.

## Adjustment Profile Segmentation

Every SA Type has one or more adjustment profiles. These profiles define the valid adjustment types that can be booked to the SA type's service agreements. If different service agreements within an SA type have different mixtures of valid adjustment types, you must split the SA types accordingly.

## Late Payment Charge Segmentation

An option exists on SA Type that causes the system to generate a late payment charge if payment is not received on time. If you don't levy late payment charges on all service agreements, you will need to determine when you do and design your SA types accordingly.

In addition, if you levy late payment charges, the percentage levied and the algorithm that defines the amount of the outstanding balance subject to the charge is defined on the SA type.

## Debt Classification Segmentation

Every SA Type has a debt class. The debt class is used to categorize a service agreement's debt for the purpose of credit and collections (C&C) analysis. If a given SA Type has different categories of debt from C&C's perspective, you must split the SA Type.

---

### **FASTPATH:**

For more information about debt class, refer to [Designing Your Collection Procedures](#).

---

### **NOTE:**

**Write Off Debt Class vs. Normal Debt Class.** An SA type references both write off debt class and normal debt class. An SA type's write-off debt class controls the write-off rules imposed on service agreements of a given type. An SA type's normal debt class controls the collection rules imposed on service agreements of a given type. Refer to [Different Collection Criteria For Different Customers And Different Debt](#) for more information about collection rules. Refer to [Different Write-Off Criteria For Different Customers And Different Debt](#) for more information about write-off rules.

---

## Allow Estimates Segmentation

Every SA Type has a switch that controls whether the system should have Oracle Utilities Meter Data Management estimate consumption if meter reads are missing at billing time. If a given SA Type has different situations when the system should and should not estimate, you will have to split the SA Type.

---

**NOTE:**

**Override.** You can override the value of the SA Type's estimation switch on an individual service agreement. This means that if only a few service agreements don't abide by the SA Type's estimation switch, you can change the switch value of these service agreements.

---

## Severance Criteria Segmentation

Every SA Type has severance criteria. The severance criteria define the severance process used to sever service if the customer doesn't pay. You can have multiple severance processes if different conditions warrant a different process. For example, you may have a different severance process if the customer has life support.

If you have a SA Type that requires different severance conditions other than those currently supported, you can make a programmatic change to introduce the additional conditions OR you can split the SA Type.

---

**FASTPATH:**

For more information about severance, refer to [Designing Your Severance Procedures](#).

---

## Deposit Class Segmentation

Every SA Type that exists to hold a cash deposit will reference a deposit class. The deposit class defines the business rules that control various functions including interest calculation and refund criteria. You will need multiple deposit SA Types if any of the deposit class' rules / conditions differ for different types of deposits. For example, if residential customers use a different recommended deposit algorithm as compared to commercial customers, you'd need one SA type for residential deposits and another for commercial deposits (where the residential deposit SA type will reference the residential deposit class and the commercial deposit SA type will reference the commercial deposit class).

You will need additional deposit SA types if your customers can have multiple deposits where each deposit is restricted to a specific type of debt. For example, if separate deposits are held for regulated and unregulated debt (and a customer could hold a combination of regulated and unregulated debt), you'd need one SA type for regulated deposits and another for unregulated deposits.

---

**FASTPATH:**

For more information about deposit class, refer to [Designing and Defining Deposit Classes](#).

---

## Sub SA Types

If you operate in a deregulated environment AND if you provide billing services for other service providers, you will need to create SA types to handle the billing of the service providers' charges.

---

**FASTPATH:**

Refer to [Designing Your SA Types And Start Options For Sub SAs](#) for more information.

---

## Financial Settlement SA Types

If you operate in a deregulated environment, you may have to create financial settlement service agreements for the service providers. As explained in [Service Providers Have Service Agreements Too, We Bill For Them and They Bill For Us](#) service providers require a service agreement to hold adjustments used to increase how much you owe the service provider (or how much they owe you).

---

**FASTPATH:**

Refer to [Designing SA Types For Service Provider Financial Settlements](#) for more information.

---

## Usage Request SA Types

Oracle Utilities Meter Data Management stores meter reading information and is responsible for calculating bill determinants during billing. The SA types for these customers will require special setup.

---

**FASTPATH:**

For more information about usage requests, refer to [The Big Picture Of Usage Requests](#).

---

## Initial Consumption Period Considerations

Bill segments produced for a service agreement have two time periods:

- The bill segment period. The bill segment period defines the entire period of time covered by a bill segment's charges.
- The consumption period. The consumption period defines the period of time used to calculate the number of days for daily charges.

The consumption period almost always starts one day after the bill segment period. The consumption period always ends on the bill segment's end date. For example, a bill segment period that spans 5-Jan-2002 through 6-Feb-2002 will almost always have a corresponding consumption period of 6-Jan-2002 through 6-Feb-2002. The reason that the start dates don't match is because a bill segment's start date equals the end date of the prior bill segment (i.e., the start date was already counted in the previous bill segment's consumption period and we don't want to count it twice).

The only time when the previous paragraph isn't true is the first bill segment that's produced for a new service agreement. This is because different utilities count the first day of a new service agreement differently than others. Because of this, a flag exists on SA Type called **Initial Start Date Option**. This flag controls whether the service agreement's start date is included in the consumption period in a service agreement's first bill segment.

The following table describes the ramifications of the options you can set for this flag.

Flag Value	Consumption Period Calculation	Use This Option When
Add 1 Day Always	The consumption period's start date is calculated by adding 1 day to the service agreement's start date. (The SA start date is never included in the consumption period for the first bill segment.)	You want the initial bill and all subsequent bills to have a consistently calculated consumption period (i.e., the consumption period for the first and all other bills is always one day less than the bill segment's period).
Add 1 Day for Back-to-back	A back-to-back occurs when any service point for this service agreement was previously linked to a different service agreement that	You want to flexibly handle consumption period calculation. If you start customers on the same date as the stop date of the



was stopped on the same date that the new service was started (i.e., there is no gap in the service).

If a back-to-back is detected, the consumption period start date is calculated by adding 1 day to the SA start date.

If no back-to-back is detected, the start date of the consumption period is the SA start date.

previous customer, billing does not include the SA start date in the consumption period. However, if you start a new customer one day (or more) after the stop date of the previous customer, billing includes the first day of the service agreement in the consumption period.

Include First Day	The start date of the consumption period is the service agreement start date. (The SA start date is always included in the consumption period.)	You want to always include the first day AND you will never encounter a back-to-back situation.
-------------------	---	---

The example below shows how the consumption period would be calculated with the various options for a customer who starts service on January 1.

	First Bill <b>Meter Read: Jan 31</b> <b>Bill Segment Period: Jan 1 to Jan 31</b>	Second Bill <b>Meter Read: Feb 28</b> <b>Bill Segment Period: Jan 31 to Feb 28</b>	Third Bill <b>Meter Read: Mar 31</b> <b>Bill Segment Period: Feb 28 to Mar 31</b>
Consumption period using Add 1 Day Always	Jan 2 to Jan 31 ( <b>30 days</b> )	Feb 1 to Feb 28 (28 days)	Mar 1 to March 31 (31 days)
Consumption period using Add 1 Day for Back-to-back when back-to-back is detected	Jan 2 to Jan 31 ( <b>30 days</b> )	Feb 1 to Feb 28 (28 days)	Mar 1 to March 31 (31 days)
Consumption period using Add 1 Day for Back-to-back when back-to-back is NOT detected	Jan 1 to Jan 31 ( <b>31 days</b> )	Feb 1 to Feb 28 (28 days)	Mar 1 to March 31 (31 days)
Consumption period using Include First Day	Jan 1 to Jan 31 ( <b>31 days</b> )	Feb 1 to Feb 28 (28 days)	Mar 1 to March 31 (31 days)

There may be SA types for which the value of this flag does not affect the consumption period calculation and still other SA types where this flag is never used. For example,

- For billable charge service agreements, the consumption period is equal to the start and end dates on the billable charge and therefore this flag is not applicable.
- A sub SA either inherits the consumption period from the master SA or it uses billable charges. As a result, billing does not use this flag.
- For some service agreements, the charges on the rate are not affected by the consumption period. For example, if you have a customer with a simple meter and a simple usage-based charge, billing calculates the amount of consumption between the start reading and end reading and applies the rate (i.e., the number of days in the consumption period doesn't impact the charges in some rates).
- Some service agreements are not billed, for example, [overpayment service agreements](#). For this type of service agreement and other types of service agreements that are not billed, this flag is not applicable. However, the system does not prevent a value from being entered in these cases to allow for an implementation process to use the flag if needed.

Setting this flag to an appropriate value is significant for certain types of service agreements.

- For services whose rate includes daily charges, the configuration of this flag may impact the first bill segment for the service agreement. For example, if the first bill period is October 1st through October 31st, do you consider consumption period to be 31 days or 30 days? How you want to bill the customer on the first bill determines how you set this flag.

- For service agreements that request usage (or bill determinants) based on interval data, the interval usage recordings typically begin on the first day of service. If you add 1 to the start date, you miss billing for intervals on the first day. In this case, you should set the value to Add 1 Day for Back-to-back.

## Processing Sequence Considerations

You may have customers with a complex collection of contracts such that the calculation for one bill segment relies on information calculated by another bill segment for the same account. For example, perhaps you need to process your bill segments as follows:

- Step 1: Calculate bill segments for all the account's "single site" service agreements (i.e., each service agreement related to a single premise)
- Step 2: Calculate the bill segment for additional charges for the "head office" service agreement where the charges are based on the aggregated consumption of all premises from all bill segments (calculated in the first step).

To create the "head office" bill segment for the account, you must control the order in which the system creates the bill segments for each service agreement.

The SA type allows you to indicate a billing processing sequence that controls the order in which the service agreements are processed. The processing sequence is optional and service agreements are processed in ascending order of their SA type's billing processing sequence. As a result, SA Types with a processing sequence of zero are processed first, then 1, then 2, etc.

---

### NOTE:

If you have sub SAs linked to a master SA, the billing processing sequence is used first to order the creation of bill segments for the master SAs. If you populate a processing sequence on an SA type for a sub SA, it is used to control the order in which the sub SAs for a given master SA are processed relative to each other. Refer to [Designing Your SA Types And Start Options For Sub SAs](#) for more information.

---

The billing processing sequence also controls the order of service agreements in the following other processes:

- Execution of pre bill completion algorithms. The system processes each service agreement in the billing processing sequence order. Within each service agreement, the pre bill completion algorithms on its [SA type](#) are processed in the order of the algorithm's sequence.
- Execution of bill completion algorithms. The system processes each service agreement in the billing processing sequence order. Within each service agreement, the completion algorithms on its [SA type](#) are processed in the order of the algorithm's sequence.

## Designing Prepayment Billing Options

This section provides guidelines describing how to design service agreements that handle smart meter prepaid billing.

When a customer is subject to prepayment, normal cycle-based billing is not used to calculate the bill segments for their service. Rather, a prepay billing (PPB) process creates bill segments frequently (for example, daily) and periodically requests funds to maintain an adequate payoff balance. Bills will only be used to periodically inform the customer of the various financial transactions that have occurred since the last bill was produced.

Implementing prepayment billing requires the configuration of the following objects:

- SA Type
- Adjustment Types
- Bill Segment Type
- Service Task Type

These configuration tasks are described below.

---

**NOTE:** For additional information, see the detailed descriptions in the application for the C1-PrepayBillerTaskType and C1-PrepayBillerTask business objects.

---

### SA Type for Prepay Billing

To configure a prepay billing SA Type, create a new SA type with the following attributes:

- Set the Special Role flag to **Bill Determinants Required**. The Prepay Option should be set to **Prepaid Smart Meter**.
- Specify the SA Creation system event with the algorithm CI\_CREATEPPB to create the service agreement's prepay biller.
- Specify the Payment Freeze system event with the algorithm STPZ-RMVC to set current amount to zero on a payment.
- If required, specify the Bill Completion system event with an algorithm of the type C1-CREPPBBM to add a bill message that informs an end customer of their prepaid charges for the period. You may need to create an algorithm of this type if it does not exist in your system.
- **Eligible for Budget** should be set to false.
- Reference a new **Prepay Bill Segment Type**, which is described below.

The following adjustment types must also be defined on the prepay SA type:

- **Adjustment Type (Xfer)** specifies the type of adjustment used to transfer funds from the delinquent service agreements to the prepaid service agreement
- **Adjustment Type (Current=0)** specifies the type of adjustment used to set the prepaid current balance to zero after debt has been transferred
- **NSF Adjustment Type** specifies the type of adjustment used to levy an NSF charge. The NSF Adjustment Type is described in greater detail below.

The new SA types must be added to the data value mapping between CCB and MDM. This is to enable the synchronization of SAs of this type to MDM. The new CCB SA types can be mapped to existing US types in MDM. For additional information about this configuration, please see the integration documentation.

### Adjustment Types for Prepay Billing

- **Funds Request Adjustment Type:** This adjustment type captures the type of adjustment used to request more prepaid funds. This adjustment type is specified on the prepaid biller task type. Specify the following algorithms on this adjustment type:
  - **Adj. Financial Algorithm** should reference the Adjustment FT creation algorithm ADJT-CA (Payoff=0/Current=Adj Amount (No GL)).
  - **Adjustment Freeze Algorithm** should reference an algorithm of the type C1-PPBADJFRZ (Set Prepaid Funds Request FT Details). You may need to create an algorithm of this type if it does not exist in your system.
- **NSF Adjustment Type:** For prepaid customers on autopay, when a user cancels an autopay tender the cancel reason must indicate that an NSF charge should be levied. The system invokes the NSF Charge algorithm specified on the tender's account's customer class which creates the NSF adjustment on the appropriate SA. The charge is levied using the NSF Adjustment Type specified on the SA's SA type. This adjustment type must reference the new adjustment freeze algorithm that will disable automatic payments on the PPB. This algorithm must be based on the algorithm type C1-DISPPBAP (Disable PPB's Automatic Payment). You may need to create an algorithm of this type if it does not exist in your system.

### Bill Segment Type Required for Prepay Billing

Configure a new bill segment type for prepaid service agreements. This bill segment type should have the following attributes:

- **Create Algorithm** should be set to C1-BSBS-UR to create bill segment using a usage request.

- **Financial Algorithm** should be set to a new algorithm with algorithm type C1-NEM-GL (Payoff Amt = Bill Amt / Current Amt = 0 (GL affected)). You may need to create an algorithm of this type if it does not exist in your system.
- **Get Consumption Algorithm** should be set to C1-BSGC-USG to get bill segment consumption using a usage request.

### Service Task Type for Prepay Billing

Configure a new service task type for prepay billing. This task type should reference the Prepay Biller (PPB) Task Type Business Object (C1-PrepayBillerTaskType). The task type must be specified on the new prepay billing SA creation algorithm. The task type captures the adjustment type used when an adjustment is created to request additional funds from the customer. Ensure that this adjustment type references the adjustment freeze algorithm (C1-PPBADJFRZ) that populates the financial transaction's arrears date.

## SA Types And The Financial Design

In this section, we provide an example of how our SA Types map to Bill Segment Types, Payment Segment Types, and Adjustment Profiles. This example is meant to help solidify the power of the financial model, it is not necessarily indicative of how your specific implementation will look.

### WARNING:

If you are not comfortable with the topics described in [Defining Financial Transaction Options](#), the following table will not make sense.

Division/SA Type	Distribution Code	Bill Segment Type	Payment Segment Type	Adjustment Profiles
CA/G-RES	A/R-UTIL	BD-RATED	NORMAL	BALXFER, MISCFEES, BUDGET
CA/G-COM	A/R-UTIL	BD-RATED	NORMAL	BALXFER, MISCFEES
CA/G-IND	A/R-UTIL	BD-RATED	NORMAL	BALXFER, MISCFEES
CA/W-RES	A/R-UTIL	BD-RATED	NORMAL	BALXFER, MISCFEES
CA/W-COM	A/R-UTIL	BD-RATED	NORMAL	BALXFER, MISCFEES
CA/W-IND	A/R-UTIL	BD-RATED	NORMAL	BALXFER, MISCFEES
CA/E-RES	A/R-UTIL	BD-RATED	NORMAL	BALXFER, MISCFEES, BUDGET
CA/E-COM	A/R-UTIL	BD-RATED	NORMAL	BALXFER, MISCFEES
CA/E-IND	A/R-UTIL	BD-RATED	NORMAL	BALXFER, MISCFEES
CA/WW-RES	A/R-UTIL	BD-RATED	NORMAL	BALXFER, MISCFEES
CA/WW-COM	A/R-UTIL	BD-RATED	NORMAL	BALXFER, MISCFEES
CA/WW-IND	A/R-UTIL	BD-RATED	NORMAL	BALXFER, MISCFEES
CA/CABLE	A/R-UTIL	BD-RATED	NORMAL	BALXFER, MISCFEES
CA/E-COY	E-COMP	COMPUSAG		
CA/G-COY	E-COMP	COMPUSAG		
CA/W-COY	E-COMP	COMPUSAG		
CA/VO-STD			NORMAL	BALXFER
CA/VO-LIA			NORMAL	BALXFER
CA/CONNECT			NORMAL	BALXFER, MISCFEES
CA/CHARITY	A/P-CHAR	RECUR	CHARITY	CHARITY

CA/PA-REGU	A/R-ARRG	RECUR-AS	NORMAL	BALXFER, MISCFEES, DPA
CA/PA-UNRE	A/R-ARRG	RECUR-AS	NORMAL	BALXFER, MISCFEES, DPA
CA/MERCH-I	A/R-MRCH	RECUR-AS	NORMAL	BALXFER, MISCFEES, MERCH
CA/DEP-I	A/P-DEPO	RECUR-AS	NORMAL	BALXFER, MISCFEES, DEPOSIT
CA/ONETIME	A/R-UTIL	BILLCHRG	NORMAL	BALXFER, MISCFEES
CA/OVR UNDR	EXP-OV/UND		NORMAL	
CA/OVERPAY	A/P-OVER		NORMAL	BALXFER
CA/SUSPENSE	A/R-SUSP		NORMAL	
CA/NBB	A/P-OVPY		NORMAL	BALXFER, MISCFEES, NBB

If you operate in a deregulated environment, you will also have additional SA types as described under [Designing Your SA Types And Start Options For Sub SAs](#) and [Designing SA Types For Service Provider Financial Settlements](#) you may have additional SA types.

## Setting Up SA Types

In the previous section, Designing SA Types, we presented a case study that illustrated a mythical organization's SA types. In this section, we explain how to use the windows on the SA Type window group to maintain your SA Types.

### SA Type - Main Information

Open **Admin > Customer > SA Type > Add** to define core information about your SA Types.

#### **WARNING:**

Every SA Type is owned by a CIS Division. This Division controls many values that can be referenced on the SA Type. If you don't understand Divisions and their place in the application, do NOT attempt to set up your SA Types. Rather, refer to [CIS Division Portal](#) before proceeding.

#### Description of Page

Enter a unique combination of **CIS Division** and **SA Type** for every service agreement type.

Enter a **Description** for the SA type.

**Service Type** defines the type of service associated with the SA type. If the SA type has rates, only rates belonging to this service type may be linked to the SA type.

Select the **Distribution Code** and **GL Division** that defines the receivable account for receivable-oriented service agreements. For non-receivable oriented service agreements, this distribution code is typically as follows:

- Charitable contributions. The distribution code is a charity payable account.
- Deposits. The distribution code is a deposit payable account.
- Non-Billed Budgets. The distribution code is an overpayment payable account.

- Company usage. The distribution code is a company usage expense account.
- Write off. The distribution code is a write-off expense account.
- Payment arrangements. The distribution code is a payment arrangement receivable account.

---

**FASTPATH:**

For more information about GL accounts, refer to [The Source Of GL Accounts On Financial Transactions](#).

---

Select the **Revenue Class** associated with the SA Type (and its service agreements). The revenue class may affect the revenue account(s) generated by the service agreement's rate.

---

**FASTPATH:**

Refer to [Designing Calculation Groups and Rules](#) for more information about revenue class.

---

Turn on **Start Options Required** if you want to force a customer service rep to choose a start option when they start service for this SA Type (on the Start Account window). If this switch is off and a rate is required for the SA Type, the system defaults the SA type's default rate on new service agreements. The default rate is defined on the SA Type - Rate page.

---

**FASTPATH:**

Refer to [Setting Up Start Options](#) for more information about the pros and cons of requiring start options.

---

Select the **Pay Segment Type** that defines how payment segments linked to service agreements of this type affect:

- The service agreement's payoff and current balances

---

**FASTPATH:**

For more information about payment segment types, refer to [Setting Up Payment Segment Types](#).

---

When a tender is canceled, a cancellation reason must be supplied. If the cancellation reason indicates a NSF (non sufficient funds) charge should be levied, the system invokes the Levy an NSF Charge algorithm specified on the tender's account's [customer class](#). Because adjustments must be linked to a service agreement, the algorithm must determine the appropriate service agreement to use to levy the adjustment based on business rules. The charge is levied using the **NSF Adjustment Type** of the appropriate service agreement's SA type.

---

**WARNING:**

You must specify adjustment type profiles on the SA type (on the Adjustment Type window) before adjustment types will appear in the above drop downs.

---

---

**FASTPATH:**

For more information about adjustment types, refer to [Setting Up Adjustment Types](#). For more information about cancellation reasons, refer to [Setting Up Payment Cancellation Reasons](#).

---

Select the **Payment Priority**. This field is available for use by the algorithms that distribute partial payments amongst an account's service agreements. Higher priority service agreements will have their debt relieved before lower priorities. Refer to [Distribution Based on Payment Priority](#) and [Delinquent Payment Distribution Algorithm](#) for information about payment distribution algorithms that use this field.

---

**NOTE:**

The values for this field are customizable using the Lookup table. This field name is PAY\_PRIORITY\_FLG.

---

---

**FASTPATH:**

---

For more information about distribution priority, refer to [Distributing A Payment Amongst An Account's Service Agreements](#).

---

Select the **Delinquent Payment Priority**. This field is available for use by the algorithms that distribute partial payments amongst an account's service agreements. Higher priority service agreements will have their debt relieved before lower priorities. Refer to [Delinquent Payment Distribution Algorithm](#) for information about a payment distribution algorithm that uses this field.

---

**NOTE:**

The values for this field are customizable using the Lookup table. This field name is DEL\_PRIORITY\_FLG.

---

Turn on **Do Not Overpay** if the system is not allowed to distribute an overpayment to this type of service agreement (i.e., the service agreement is not allowed to have a system-created credit balance). This field is available for use by algorithms that distribute overpayments. Refer to [Overpayments Held On Highest Priority Service Agreement](#) for information about an overpayment algorithm that uses this field.

Turn on **Late Payment Charge** if the system should generate a late payment charge for this type of service agreement if payment is not received on time. If this is turned on, you must define the **LPC Calc. Algorithm** used to calculate the late payment charge amount. Refer to [Defining Late Payment Charge Options](#) for more information about late payment charges. Examples of algorithm types used for calculating late payment charges are [BILPC-SPRC](#) and [BILPC-TOTAL](#).

Define the **Adjustment Type (Synch Curr)** that will be used to synchronize (make equal) the current amount with the payoff amount on a service agreement of this type. This type of processing happens as follows:

- Most [write-off](#) algorithms that perform financial efforts (e.g., writing off debt), will issue an adjustment of this type if the service agreement's current and payoff balances are not equal.
- If a user stops a customer on a [budget plan](#), the system issues adjustments of this type to synchronize the customer's current and payoff balances.
- If a user stops a service agreement covered by a [Non-Billed Budget](#), the system issues adjustments of this type to synchronize the customer's current and payoff balances.
- If a [cancellation of a bill segment](#) occurs after a customer has stopped participating in a budget plan, an adjustment of this type is issued to synchronize the imbalance created when the bill segment's financial transaction is canceled.

Turn on **CIAC SA Type** and specify an appropriate **CIAC Refund Process** if service agreements of this type are used to bill for Contribution In Aid of Construction (CIAC) charges. Refer to [CIAC Segmentation](#) for more information.

**Where Used**

Follow this link to open the data dictionary where you can view the tables that reference [CI\\_SA\\_TYPE](#).

## SA Type - Detail

Open **Admin > Customer > SA Type > Search** and navigate to the **Detail** page to define additional details about a given SA type.

**Description of Page**

Turn on **Display As Alert** if Control Central should display an alert if an account has a service agreement of this type that isn't Closed or Canceled. If this switch is on, also enter the **Alert Information** to appear on Control Central. We recommend only using this feature on unusual SA types (e.g., payment arrangements, write-offs) so that a CSR is not presented with an alert for every SA type.

If this SA Type is used for any of the **Special Roles**, defined in the dropdown, indicate which one. Valid values are: Billable Charge, Cash Deposit, Loan, Non-Billed Budget, Payment Arrangement, Write Off, Bill Determinants Required. This

information is used on windows with functionality that can only be used by service agreements used for specific roles. For example, the Billable Charge window group can only reference Billable Charge service agreements.

If Special Role is Cash Deposit, you must define the **Deposit Class** of the deposit. You should also define a **Deposit Class** on every SA type to which a given deposit can be distributed.

---

**FASTPATH:**

Refer to [What Do Deposit Classes Do?](#) for more information.

---

If the Special Role is Loan, you must also define the following fields:

- Use the **Interest Bill Factor** to define the bill factor code for the loan interest rate.
- Use **Override Interest Flag** to indicate whether the interest rate defined on the interest bill factor may be overridden at the SA level. If you select Allowed, the interest rate may be overridden by a contract value on a start option or the SA.
- Use the **Loan A/R Distribution Code** to define the distribution code to be used when posting the short-term receivable amount to the general ledger (the normal distribution code is used for the long-term receivable). If the normal distribution code is the same as the **Loan A/R Distribution Code**, the SA type does not differentiate between long- and short-term receivables. If the two distribution codes are different, the SA type differentiates between long- and short-term receivables.

---

**FASTPATH:**

Refer to [Defining Loan Options](#) for more information about **Interest Bill Factor**, **Override Interest Flag** and **Loan A/R Distribution Code**.

---

If the Special Role is Non-Billed Budget , you must also define the following:

- Use **Adjustment Type (Xfer)** to specify the type of adjustment used to the transfer accumulated credit from the Non-Billed Budget SA to the SAs covered by the Non-Billed Budget when the account is billed or the Non-Billed Budget SA is stopped.
- Use the **Non-Billed Budget Monitoring** to specify whether the Non-Billed Budget is monitored by the account debt monitor.

If the SA type is defined as Eligible for Non-billed Budget, you must also define the following:

- Use **Adjustment Type (Current=0)** to specify the type of adjustment used to set the service agreement's current balance to zero when a service agreement of this type is linked to an active, monitored Non-Billed Budget.

If the Special Role is Payment Arrangement, you must also define two adjustment types:

- Use **Adjustment Type (Xfer)** to specify the type of adjustment used to transfer funds from the delinquent service agreements to the payment arrangement service agreement.
- Use **Adjustment Type (Current=0)** to specify the type of adjustment used to set the payment arrangement's current balance to zero after funds have been transferred.

If the Special Role is Write Off, you must also define the following adjustment types:

- Use **Adjustment Type (Xfer)** to specify the type of adjustment used to transfer funds from the uncollectable service agreements to the write off service agreement.

If the Prepay Option is **Prepaid Smart Meter**, you must also define two adjustment types:

- Use **Adjustment Type (Xfer)** to specify the type of adjustment used to transfer funds from the delinquent service agreements to the prepaid service agreement.
- Use **Adjustment Type (Current=0)** to specify the type of adjustment used to set the prepaid current balance to zero after debt has been transferred.

---

**WARNING:**



You must specify adjustment type profiles on the SA type (on the Adjustment Type window) before adjustment types will appear in the above drop downs.

---

The **Stop Option Flag** can be used to automatically stop a service agreement when all other service agreements of an account are stopped. Valid values are: Automatically Stop SA. When all service point related service agreements of an account are stopped then all additional service agreements where the **Stop Option** is set to Automatically Stop SA will also be stopped. This is useful, for example, with charitable contribution service agreements. The charity service agreement should be stopped when all utility related services are stopped.

---

**FASTPATH:**

Refer to [The Lifecycle of a Service Agreement](#) for more information on the **Stop Option**.

---

Turn on **One Time Charge** if this SA type is used for one-time invoices. When a one-time invoice service agreement is created, the system sets the stop date of the SA to be equal to the start date.

Turn on **Sub SA** if this SA type is used to define the business rules for sub service agreements.

---

**FASTPATH:**

Refer to [Sub Service Agreements](#) for more information about sub service agreements.

---

**Renewal** of SAs of this type may be Optional, Not Allowed or Required depending on your business processes. If renewal is not allowed, the SA expires on the expiration date. Renewal treatment is an important consideration for SAs that require an expiration date, such as [non-billed budget SAs](#).

If renewal is required or optional, specify the **Days Before Expiration for Renewal**. Note that currently this is only used by Non-Billed Budgets to calculate the renewal date based on the expiration date.

If the Special Role is Non-billed Budget, **Non-Billed Budget Monitoring** must indicate whether the Non-Billed Budget is monitored by the account debt monitor.

---

**FASTPATH:**

Refer to [Credit and Collections and Non-Billed Budgets](#) for more information about monitoring Non-Billed Budgets.

---

## Where Used

The alert information is used by Control Central to alert a CSR when unusual service agreements exist for an account. Refer to [Control Central - Main](#) for more information.

Only SA types designated as being Billable Charge may have billable charges linked to them. Refer to [Maintaining Billable Charges](#) for more information.

Only SA types designated as being Cash Deposit are processed by the various deposit-related background processes (e.g., interest calculation, automatic refund, etc.). Refer to [The Big Picture Of Deposits](#) for more information.

Only SA types designated as Loan are used to define the loan terms for a loan SA. Refer to [Loans](#) for more information.

Only SA types designated as Non-billed Budget may be used to set up Non-Billed Budgets. Refer to [Non-Billed Budgets](#) for more information.

Only SA types designated as being Payment Arrangement may be used on the payment arrangement window group. Refer to [Setting Up Payment Arrangements](#) for more information.

Only SA types designated as being Write Off may be specified as the write off SA type on distribution codes. Refer to [Setting Up Distribution Codes](#) for more information.

Only service agreements whose SA type is designated as being Write Off appear on the Write Off SAs query. Refer to [Write Off - Write Off SAs](#) for more information.

---

## SA Type - Billing

Open **Admin > Customer > SA Type > Search** and navigate to the **Billing** page to define how the system manages bill segments for service agreements of a given SA type.

### Description of Page

Turn on **Eligible for Billing** if the system should create bill segments for service agreements of this type. This will typically be turned on for all service agreements except for those used to hold write-off amounts or to levy one-off adjustments.

Define the minimum number of days a bill segment (other than the final segment) must span using **Minimum Days for Billing**. This is useful to prevent initial bill segments that span only a few days.

---

#### FASTPATH:

For more information about minimum days, refer to [Preventing Short Bill Segments](#).

---

Select the **Bill Segment Type** that controls both how bill segments for this SA Type will be created and how the related financial transaction affects the general ledger and the customer's debt.

---

#### FASTPATH:

For more information about bill segment types, refer to [Setting Up Bill Segment Types](#).

---

Use **Default Description on Bill** to define the verbiage that should print on the customer's bill.

---

#### NOTE:

**Rates overwrite this description.** The Default Description on Bill is not applicable for service agreements whose charges are calculated using a rate. Why? Because the description that appears on the bill segment is defined on the rate schedule's rate version calculation group.

**Billable charges overwrite this description.** The Default Description on Bill is not applicable for service agreements whose charges are calculated using a billable charge. Why? Because the description that appears on the bill segment is defined on the billable charge.

---

Use the **Billing Processing Sequence** if you need to control the order in which service agreements linked to this SA type are processed by billing.

---

#### FASTPATH:

Refer to [Processing Sequence Considerations](#) for more information.

---

Use **Bill Print Priority** to define the order in which the SA type's bill segments should appear on bills (relative to the other SA types that appear on a bill).

---

#### NOTE:

The values for this field are customizable using the Lookup table. This field name is BILL\_PRT\_PRIO\_FLG.

---

Use **Max Bill Threshold** if you want the system to generate a bill error when a bill segment is produced in batch that exceeds a given value. These bill errors will appear on the standard billing queries and To Do lists. If, after reviewing the high value bill segment, an operator truly intends to send the bill out, they should regenerate the bill. Refer to [How To Correct A Bill Segment That's In Error](#) for more information.

---

#### WARNING:

The value entered in this field will DEFAULT onto service agreements of this type when they are first created. An operator may change the default value on a service agreement in case a specific customer has unusually high bills that continually error out. It's important to be aware that if you change the value of High Bill Amount on an SA type and there already exist service agreements of this type, the existing service agreements will contain the original value (the new value on the SA type will not be propagated on the existing service agreements).

---

Use **Graph Unit Of Measure** to define the unit of measure of the graphed consumption on the bill (if any).

Turn on **Allow Estimates** if the system should indicate to Oracle Utilities Meter Data Management whether to generate estimated consumption if meter reading(s) cannot be found at billing time. This value is defaulted onto service agreements and can be overridden on an individual service agreement.

Turn on **Characteristic Premise Required** if a characteristic premise must be linked to the service agreement when the service agreement is activated. The characteristic premise is used to define the taxing authorities associated with the service agreement's bill segments. It is also used to identify where the service agreement's service is located on various windows.

---

**FASTPATH:**

For more information about how characteristic premise is used, refer to [An Illustration Of A Bill Factor And Its Characteristics](#).

---

Use the **Initial Start Date Option** to control how billing should calculate the consumption period for the very first bill for service agreements of this type. This field is not applicable for sub SA types or SA types with a special role of Billable Charge. Valid values are Include First Day, Add 1 Day Always and Add 1 Day for Back-to-back. Refer to [Initial Consumption Period Considerations](#) for more information.

Non-metered service agreements may have the end date of their bill segments defined on a user-maintained bill period schedule. This option is used when bill segments must fall on strict calendar boundaries (e.g., quarterly bills that end on the last day of the quarter). If this SA type should be billed like this, select Use Bill Period in the **Use Calendar Billing** field. When this option is used, you must define the **Bill Period** whose schedule defines the bill segment end dates.

---

**FASTPATH:**

For more information about bill period schedules, refer to [Designing Bill Periods](#). For more information about other bill end date methods, refer to [Ways To Control The End Date Of A Bill Segment](#).

---

Instead of the Use Bill Period method, non-metered service agreements may have their bill segment end date based on the first day of service. For example, if service started on the 16th of some month, the ongoing bill segments will start on roughly the 16th of each month. This option is frequently used to bill for garbage or cable service. If this SA type should be billed like this, select Anniversary Future Billing or Anniversary Past Billing in the **Use Calendar Billing** field. When either option is used, you must define the **Anniversary Bill Frequency**. This frequency defines the amount of time between bill segments.

---

**FASTPATH:**

For more information about anniversary billing, refer to [Using The Anniversary Method](#). For more information about other bill end date methods, refer to [Ways To Control The End Date Of A Bill Segment](#).

---

**Total Bill Amount** indicates whether service agreements of this type can use the total amount to bill field on the service agreement page. Valid values are Not Allowed and Required. Only SA types used to bill for deposits or loans should have this field set to Required.

If Required is selected, you must enter the **Total Amount To Bill Label**. The **Total Amount To Bill Label** defines the label that prefixes the total bill amount on the service agreement page for service agreements of this SA type.

---

**FASTPATH:**

For more information about total amount to bill and deposit service agreements, refer to [Total Amount To Bill](#). For more information about total amount to bill and loan service agreements, refer to [Setting Up The System To Enable Loans](#).

---

**Recurring Charge** indicates whether service agreements of this type can use the recurring charge field on the service agreement window. Valid values are Not Allowed, Optional and Required. If either Optional or Required are used, you must enter:

- **Recurring Chg Amt Label.** This defines the label that prefixes the recurring charge amount on the service agreement window for service agreements of this SA type.
- **Recurring Charge Frequency.** This defines the following:
  - Specifies the frequency at which the Recurring Charge Amount specified on service agreements of the SA Type is to be billed.
  - Serves as the basis for proration of the Recurring Charge Amount.
  - Specifies the frequency at which service agreements of the SA Type without a rate and/or meters will be billed.

---

**FASTPATH:**

For more information about how to use the recurring charge information, refer to [Charitable Contribution Segmentation](#), [Merchandise Segmentation - Installment Billing](#), [Deposit Segmentation - Installment Billing](#), [Payment Arrangement Segmentation](#), [Budget Billing Segmentation](#), [The Terms Of A Loan Are Stored On A Service Agreement](#).

---

Turn on **Eligible for Budget** if service agreements of this type can participate in budget billing. If this switch is turned on, then you must define the **Adjustment Type (Synch Current)** that will be used to synchronize (make equal) the current amount with the payoff amount on a service agreement of this type when a budget is cancelled. (The Adjustment Type (Synch Current) field is on the main page.)

---

**FASTPATH:**

Refer to [Budget Billing](#) for more information about budgets in general. Refer to [Budget Billing Segmentation](#) and [Designing and Defining Budget Plans](#) for more information.

---

Set the **Eligible for Non-Billed Budget** flag to Eligible for Non-Billed Budget if you want SAs of this type to be eligible to be covered by a Non-Billed Budget. If this flag is set to Eligible for Non-Billed Budget, you must also define the **Adjustment Type (Current = 0)** field (on [SA Type - Detail](#)).

---

**FASTPATH:**

Refer to [Current Amount For SAs Covered By A Non-Billed Budget](#) and [SA Types for SAs Covered by Non-Billed Budgets](#) for more information.

---

## Require Total Amount Switch versus Bill Segment Algorithm

The following table shows valid combinations of the SA type's required total amount switch and the bill segment creation algorithm defined on the SA type's bill segment type. If N/A appears in a cell, the combination is not supported in the system. Otherwise, we list typical types of service agreements that will use a combination.

---

Bill Segment Create Algorithm	SA Type Require Total Amount Switch:	SA Type Require Total Amount Switch:
	Not allowed	Required
<a href="#">Apply Rate To Usage Request</a>	Metered services. Lamp services. Misc item services.	N/A

---

	Company usage. Misc recurring charges whose value is specified in a rate or is taxable.	
Recurring Charge With Auto Stop	Payment arrangements. Merchandise installment plans. Zero-interest loans.	N/A
Recurring Charge For Amount To Bill	N/A	Deposit installment plans.
Recurring Charge	Charitable contributions.	N/A
Billable Charge	One time invoices. Pass through charges	N/A
Loan	N/A	Loans.

## Allow Recurring Charge Switch versus Bill Segment Algorithm

The following table shows valid combinations of the SA type's allow recurring charge switch and the bill segment creation algorithm defined on the SA type's bill segment type. If N/A appears in a cell, the combination is not supported in the system. Otherwise, we list typical types of service agreements that will use a combination.

Bill Segment Create Algorithm	SA Type Recurring Charge Switch:	SA Type Recurring Charge Switch:	SA Type Recurring Charge Switch:
	Not allowed	Optional	Required
Apply Rate To Usage Request	Metered services - no budget Lamp services Misc item services. Company usage. Misc recurring charges whose value is specified in a rate or is taxable.	Metered services - budget optional	Metered services - budget required
Recurring Charge With Auto Stop	N/A	Payment arrangements. Merchandise installment plans. Zero-interest loans. SEE NOTE!	Payment arrangements. Merchandise installment plans. Zero-interest loans. SEE NOTE!
Recurring Charge For Amount To Bill	N/A	Deposit installment plans. SEE NOTE!	Deposit installment plans. SEE NOTE!
Recurring Charge	Charitable contributions	N/A	N/A
Billable Charge	One time invoices. Pass through charges	N/A	N/A
Loan	N/A	N/A	Loans.

**NOTE:**

Most recurring charge SA types require a recurring charge amount on their service agreements. However, the above matrix indicates you can have recurring charge SA types where this value is optional. Why? A special algorithm exists in billing that says if the recurring charge amount is 0 (zero) the system will bill the remaining payoff balance or total amount to bill. This algorithm exists so that you can easily bill the amount in one lump sum (i.e., don't bill it in installments).

---

### Where Used

The billing information is used when the system creates a bill segment for service agreements of this type.

## SA Type - Rate

Open **Admin > Customer > SA Type > Search** and navigate to the **Rate** page to define the rates that may be referenced on service agreements of a given type.

### Description of Page

Turn on **Rate Required** if the bill segment creation algorithm for the SA type expects a rate schedule to be referenced on service agreements of this type.

---

#### FASTPATH:

For more information, refer to [Rates](#).

---

When a rate changes within a bill segment's consumption period, the period is divided into separate usage periods – one for each active rate schedule during that period. The usage periods and their related consumption (or billable quantities) are then prepared for billing, and the rate schedule calculations are applied to their associated periods.

This feature is possible if the usage subscription type is configured with the base Dynamic Usage Group Determination algorithm, which determines the applicable usage group for each effective rate schedule. This algorithm requires that the CCB rate schedule has usage group extendable look-ups configured for the rate schedule and device configuration type combinations.

A typical use case is when there is a smart meter rollout in the middle of billing period and there are rate schedule changes that coincide with the meter exchange date. The usage group that is tied to the old meter will have rules that calculate scalar consumption, and the usage group that is tied to the new meter will have rules that calculate interval consumption. The end result is that the customer is billed with scalar consumption for the period where old meter was installed, and billed with interval consumption for the period where new meter is installed.

If the Contract Management module is not [turned off](#), which includes [umbrella agreement management](#), indicate the **Rate Source**. Check SA Only indicates that the rate schedule currently in effect for the service agreement should always be used. Check TOS First, then SA indicates that if the service agreement is linked to a terms of service record, the service agreement's rate could be [overridden by one linked to the terms of service](#) record.

The information in the **Rate Schedules** collection defines the rates that may be referenced on service agreements of this type. The following fields are required for each SA Type:

**Rate Schedule** Specify the rate schedule; its description is displayed adjacent.

**Use As Default** Turn on this switch for the rate to be defaulted on new service agreements.

## Rate Required versus Bill Segment Algorithm

The following table shows appropriate combinations of the SA type's rate required switch and the bill segment creation algorithm defined on the SA type's bill segment type. If N/A appears in a cell, the combination is not applicable. Otherwise,

we list typical types of service agreements that will use a combination. Be aware that no cross validation exists between the rate required switch and the bill segment creation algorithm when setting up the SA type.

Bill Segment Create Algorithm	SA Type Rate Required Switch:	SA Type Rate Required Switch:
	Not allowed	Rate required on SA
<a href="#">Apply Rate To Usage Request</a>	N/A	Metered services. Lamp services. Misc item services. Company usage.
<a href="#">Recurring Charge With Auto Stop</a>	Payment arrangements. Merchandise installment plans. Zero-interest loans.	N/A
<a href="#">Recurring Charge For Amount To Bill</a>	Deposit installment plans.	N/A
<a href="#">Recurring Charge</a>	Charitable contributions.	N/A
<a href="#">Billable Charge</a>	One time invoices.	Billable charges that require a rate to add-on extra charges (like taxes) or billable charges where the consumption is interfaced and the system is responsible for calculating the charges.
<a href="#">Loan</a>	Loans.	N/A

### Where Used

This information is used to default and validate the rate specified on a service agreement. Refer to [Service Agreement - Rate Info](#) for more information.

## SA Type - SP Type

Open **Admin > Customer > SA Type > Search** and navigate to the **SP Type** page to define the service point types that may be referenced on service agreements of a given type.

### Description of Page

Turn on **Service Points Required** if at least one service point should be linked to service agreements of this type in order to properly bill the service agreements.

The information in the **SP Types** collection defines the service point (SP) types that may be referenced on this SA type's service agreements. The following fields are required for each SA Type:

**SP Type** Specify the SP type; its description is displayed adjacent.

#### FASTPATH:

For more information about SP types, refer to [Designing SP Types](#).

### Where Used

This information is used to validate the types of service points linked to a service agreement. Refer to [Service Agreement - SA / SP](#) for more information.

## SA Type - Adjustment Profiles

Open **Admin > Customer > SA Type > Search** and navigate to the **Adj Profile** page to define the adjustment profiles that define adjustment types that may be referenced on service agreements of a given type.

### Description of Page

Define the **Adjustment Type Profiles** that, in turn, define adjustment types that may be referenced on service agreements of a given type.

---

**FASTPATH:**

For more information about adjustment type profiles, refer to [Setting Up Adjustment Type Profiles](#).

---

### Where Used

This information is used to validate the adjustments linked to the service agreement. Refer to [Adjustment - Main Information](#) for more information.

## SA Type - C&C

Open **Admin > Customer > SA Type > Search** and navigate to the **C&C** page to maintain attributes that affect how the system severs the service agreement when collection attempts fail.

---

**FASTPATH:**

Refer to [Designing Your Severance Procedures](#) for more information.

---

### Description of Page

Select the **Debt Class** associated with the SA Type. Any debt on a service agreement of this SA Type will be categorized under this debt class.

Select the **Write Off Debt ClassCode** associated with the SA Type. Any debt on a service agreement of this SA Type will be categorized under this debt class during write-off processing.

---

**NOTE:**

**Write Off Debt Class vs. Regular Debt Class.** It's important to be aware that a SA type references both a regular debt class and a write-off debt class. The regular debt class controls the collection criteria applied against an account's service agreements. The regular debt class is also used to segregate an account's outstanding balance on several queries in the system. The write-off debt class controls the write-off criteria applied against an account's stopped service agreements. The reason the system supports two different debt classes is because you may categorize your service agreements differently when you try to collect overdue debt versus when you write-off debt. Refer to [The Big Picture Of Write Off Processing](#) for more information.

---

The information in the **Severance Criteria** collection defines the SA Type's severance criteria. Severance criteria define the severance process to be executed for service agreements of a given SA type. The severance process may differ depending on some attribute of the customer or premise. For example, you may have a different severance process if the customer has life support equipment.

---

**FASTPATH:**



The following information is not intuitively obvious. Refer to [Designing Your Severance Procedures](#) for more information.

---

The following fields are required for each instance:

**Priority** The priority controls the order in which the system determines if the severance process should be applied (the first severance process whose algorithm applies is used). Higher priorities are checked before lower priorities.

**Severance Criteria Algorithm** Select the algorithm to be used to check if the severance process should be initiated for service agreements of this type. If a condition is met, a severance process is created using the associated severance process template.

If you haven't done so already, you must set up this algorithm in the system. To do this:

- Create a new algorithm (refer to [Setting Up Algorithms](#)).
- On this algorithm, reference an Algorithm Type that determines if the severance of a service agreement should be processed using the associated **Severance Process Template**. Click [here](#) to see the algorithm types available for this plug-in spot.

---

**IMPORTANT:**

You must have at least one entry in this collection otherwise the system will not start a severance process when a service agreement of this type needs to be stopped due to non payment. This entry should have the lowest priority code and should reference a **Severance Criteria Algorithm** that references the [SV CRIT DFLT](#) algorithm type.

---

**Severance Process Template** Specify the severance process template to use to sever the service agreement; its description is displayed adjacent.

**Where Used**

The debt class has multiple uses:

- The system summarizes an account's debt by debt class on [Account - Main Information](#) and [Account - Financial Balances](#).
- Debt class is one component that controls how the system analyzes an account's overdue debt (the others are the account's collection class and currency). Refer to [Different Collection Criteria For Different Customers And Different Debt](#) for more information.
- Write off debt class is one component that control how the system writes off an account's stopped service agreements. Refer to [Different Write-Off Criteria For Different Customers And Different Debt](#) for more information.

The severance criteria are used when a collection event is activated that indicates that service should be severed.

## SA Type - Billable Charge Template

Open **Admin > Customer > SA Type > Search** and navigate to the **BC Template** page to define the billable charge templates that can be used on service agreements of a given type.

---

**NOTE:**

**Only billable charges have billable charge templates.** Only service agreements that are defined as Billable Charges (in the Special Role on the Details window) may use the grid on this window.

---

**Description of Page**

The information in the **Billable Charge Template** collection defines the SA Type's permissible billable charge templates. A billable charge template contains the default bill lines, amounts and distribution codes used to levy a one-off charge. The following fields are required for each template:

**Billable Charge Template** Specify the billable charge template. Its description is displayed adjacent.

**Use As Default** Turn on this switch for the template to be defaulted on new billable charges linked to service agreements of this type (if any).

---

**FASTPATH:**

For more information about billable charge templates, refer to [Setting Up Billable Charge Templates](#).

---

### Where Used

This information is used to limit the billable charge templates that can be used for a given SA type.

## SA Type - Characteristics

To define characteristics common to all service agreements of a given type, open **Admin > Customer > SA Type > Search** and navigate to the **Characteristics** page.

### Description of Page

Use the characteristics collection to define a **Characteristic Type**, **Sequence**, and **Characteristic Value** common to all service agreements of this type.

---

**NOTE:**

You can only choose characteristic types defined as permissible on a SA Type record. Refer to [Setting Up Characteristic Types & Their Values](#) for more information.

---

## SA Type - Algorithms

Open **Admin > Customer > SA Type > Search** and navigate to the **Algorithm** page to define the algorithms that should be executed for service agreements of a given type.

### Description of Page

The grid contains **Algorithms** that control important functions in the system. You must define the following for each algorithm:

- Specify the **System Event** with which the algorithm is associated (descriptions of all possible events are provided below).
- Specify the **Sequence** and **Algorithm** for each system event. You can set the **Sequence** to 10 unless you have a **System Event** that has multiple **Algorithms**. In this case, you need to tell the system the **Sequence** in which they should execute.

---

**WARNING:**

These algorithms are typically significant processes. The absence of an algorithm may prevent the system from operating correctly.

---

The following table describes each **System Event** for which you can define algorithms.

System Event	Optional / Required	Description
Bill Completion	Optional	These algorithms are executed whenever a bill is completed for an account that contains a non-canceled service agreement of this type. The following situations necessitate the

definition of a completion algorithm on an SA type:

- As explained under [Technical Implementation of A/R Transfer](#) and [Technical Implementation of Routing Billable Charges To Service Providers](#), when a bill is completed, the system needs to set up the data necessary to interface any "master" SA's charges to the service provider and to transfer the receivable balance from the customer to the service provider. The system will only do this if you specify an appropriate algorithm on the master SA types.

- As explained under [Billing For SAs Covered By The Non-Billed Budget](#), when a bill is completed for accounts that have a Non-Billed Budget SA, the system needs to distribute the Non-Billed Budget's credit balance to the covered SAs. The system will only do this if you specify an appropriate algorithm on the NBB SA types.

- As explained under [Overpayment Segmentation](#), when a bill is completed, the system may apply an excess credit from a prior overpayment to an account's service agreements.

**Note.** Algorithms of this type are called for all non- Canceled service agreements, regardless of whether or not they are billed. If your algorithms should only be processed under certain conditions (for example, only process this algorithm for Active service agreements), then it is the responsibility of the algorithm to check the conditions before continuing.

Click [here](#) to see the algorithm types available for this system event.

---

Bill Eligibility	Optional	<p>These algorithms are executed during billing and allow logic to be introduced to check additional criteria to determine if an SA is eligible for billing.</p> <p>Click <a href="#">here</a> to see the algorithm types available for this system event. The algorithm type delivered with the system provides an example of how plug-ins of this type can be used</p>
Break NBB SA	Optional	<p>These algorithms are executed when a <a href="#">Non-Billed Budget</a> is manually stopped via the <a href="#">Non-Billed Budget maintenance page</a>.</p> <p>Click <a href="#">here</a> to see the algorithm types available for this system event.</p>

---

Note that the Payment Arrangement algorithm and the Break Pay Arrangement algorithm are mutually exclusive.

---

Break Pay Arrangement	Optional	<p>These algorithms are by executed by severance events when the event is created for payment arrangement SAs. This algorithm should be specified on SA types with a special role of Payment Arrangement to perform special actions that take place when a customer breaks a payment arrangement. Refer to <a href="#">Monitoring Payment Arrangements</a> for more information about breaking payment arrangements.</p> <p>Click <a href="#">here</a> to see the algorithm types available for this system event.</p>
Budget Eligibility	Optional	<p>These algorithms are executed when determining in a service agreement is eligible for budget. Algorithms of this type are only applicable on SA types that are marked as eligible for budget and may be used to override that setting and indicate that the service agreement is not eligible.</p> <p>For example, maybe service agreements in a certain rate are not eligible. Or perhaps service agreements with a given characteristic value are not eligible.</p> <p>Click <a href="#">here</a> to see the algorithm types available for this system event.</p>
Cut Process Rule	Optional	<p>These algorithms are executed to create a cut process for service agreements of this type. Refer to <a href="#">The Big Picture Of Cut Processes</a> for more information.</p> <p>Click <a href="#">here</a> to see the algorithm types available for this system event.</p>
FT Freeze	Optional	<p>These algorithms are executed whenever a financial transaction is frozen that is linked to a service agreement of this type. The following situations necessitate the definition of an FT freeze algorithm:</p> <ul style="list-style-type: none"><li>- As explained under <a href="#">Technical Implementation of Routing Consumption To Service Providers</a>, when a master SA's bill segment is frozen, the system must check if there are any service providers who need the bill segment's consumption. If so, it sets up the data necessary to interface the master SA's consumption (snapshot on the bill segment) to the service provider(s). The system will only do this if you specify an appropriate FT Freeze Algorithm on the master SA types.</li></ul>

---

- As explained under [Technical Implementation of Paying The Service Provider](#), when a financial transaction (FT) is frozen that is associated with a sub SA, the system must check if this FT should trigger the "payment" of a service provider. If so, it has to create an adjustment to increase how much we owe the service provider. The system will only do this if you specify an appropriate FT Freeze Algorithm on the sub SA types.

Click [here](#) to see the algorithm types available for this system event.

High Bill Amount	Optional	<p>This algorithm type checks for high bill amounts during batch billing. A bill threshold amount can be defined on a service agreement. By default the system compares this threshold amount to the bill segment amount during batch billing. If the bill segment amount exceeds the given threshold value, a bill error is generated. No proration takes place on the threshold amount if the bill segment's consumption period falls outside of the rate frequency's normal period.</p> <p>This algorithm may be used to override the default system behavior. It will prorate the SA's bill threshold amount before comparing it to the batch bill segment amount if the consumption period falls outside of the rate frequency's normal period.</p> <p>Click <a href="#">here</a> to see the algorithm types available for this system event.</p>
Landlord Reversion	Optional	<p>These algorithms are used to create, update or cancel a service agreement for a landlord when service is started, stopped or updated for a premise that references a <a href="#">landlord agreement</a>.</p> <p>Algorithms of this type are called:</p> <ul style="list-style-type: none"> <li>- When starting a new SA (start initiation)</li> <li>- When stopping an SA (stop initiation)</li> <li>- When canceling a pending start SA</li> <li>- When changing the stop / start dates of back-to-back service agreements</li> </ul> <p>Click <a href="#">here</a> to see the algorithm types available for this system event.</p>
Loan Interest Charge	Optional	<p>These algorithms are executed whenever the interest charge needs to be calculated for a loan, such as when the loan amortization schedule is created and when a bill segment is created for a loan SA. This algorithm should</p>

be specified on SA types with a special role of Loan. Refer to [Defining Loan Options](#) for more information.

Click [here](#) to see the algorithm types available for this system event.

---

Loan Periods and Amount	Optional	<p>These algorithms are executed whenever a user clicks the Calculate button on <b>Loan - Main</b> or on the Start SA Confirmation dialog for a loan SA. It calculates either the number of periodic payments or the payment amount (depending on whether the user specifies the number of payments or the payment amount as input). This algorithm should be specified on SA types with a special role of Loan. Refer to <a href="#">Defining Loan Options</a> for more information.</p> <p>Click <a href="#">here</a> to see the algorithm types available for this system event.</p>
Loan Schedule	Optional	<p>These algorithms are executed whenever the system needs to create a <b>loan amortization schedule</b> for a loan, such as when you renegotiate the terms of a loan on <b>Loan - Main</b>. This algorithm should be specified on SA types with a special role of Loan. Refer to <a href="#">Defining Loan Options</a> for more information.</p> <p>Click <a href="#">here</a> to see the algorithm types available for this system event.</p>
Override Proration Days	Optional	<p>This algorithm is invoked from rate application, right after base has determined if proration applies. It is used to override base days, normal days and "is within proration window" indicator, which were determined by base logic. Only one algorithm may be plugged-in to this system event. This is available only in the calculation rule based rating engine.</p> <p>Click <a href="#">here</a> to see the algorithm types available for this system event.</p>
Payment Arrangement	Optional	<p>These algorithms are by executed to handle the creation, breaking and canceling of payment arrangement SAs. This algorithm should be specified on SA types with a special role of Payment Arrangement to perform special actions that take place during the lifecycle of a payment arrangement. Refer to <a href="#">Monitoring Payment Arrangements</a> for more information about payment arrangements.</p> <p>Note that the Payment Arrangement algorithm and the Break Pay Arrangement algorithm are mutually exclusive.</p>
Payment Freeze	Optional	<p>These algorithms are executed whenever a payment is frozen. The following situations</p>

---

necessitate the definition of such an algorithm:

- For a loan SA, such an algorithm is required to create a frozen adjustment that transfers any credit balance resulting from an [overpayment](#) to the loan's principal balance. Refer to [Defining Loan Options](#) for more information.

Click [here](#) to see the algorithm types available for this system event.

---

Pre-Bill Completion	Optional	<p>These algorithms are executed immediately prior to bill completion when a bill contains a bill segment for a service agreement whose SA type has such an algorithm. The following situations necessitate the definition of such an algorithm:</p> <p>- If you want to delete a bill segment that's in error on the last night of a bill cycle when there are other bill segments that aren't in error, use such an algorithm.</p> <p>Click <a href="#">here</a> to see the algorithm types available for this system event.</p>
Process NBB Scheduled Payment	Optional	<p>These algorithms are executed by the NBB Scheduled Payment Processing background process whenever a scheduled payment is due. If the Non-Billed Budget SA is unmonitored, this algorithm is not called. This algorithm should be specified on Non-Billed Budget SA types to create the necessary adjustments for the Non-Billed Budget SA.</p> <p>Click <a href="#">here</a> to see the algorithm types available for this system event.</p>
Proposal SA Acceptance	Optional	<p>These algorithms are executed when a <a href="#">proposal service agreement</a> is accepted. Refer to <a href="#">Enabling The Creation Of A Real Service Agreement</a> for more information.</p> <p>Click <a href="#">here</a> to see the algorithm types available for this system event.</p>
Proposal SA Bill Segment Generation	Optional	<p>These algorithms are executed to generate simulated bills segments for a <a href="#">proposal service agreement</a>. Refer to <a href="#">Enabling The Generation Of Simulated Bill Segments</a> for more information.</p> <p>Click <a href="#">here</a> to see the algorithm types available for this system event.</p>
Proposal SA Creation	Optional	<p>These algorithms are executed when a <a href="#">proposal service agreement</a> is created. Refer to <a href="#">Enabling The Automatic Generation Of Billing Scenarios</a> for more information.</p>

---

SA Activation	Optional	<p>Click <a href="#">here</a> to see the algorithm types available for this system event.</p> <p>These algorithms are executed when a service agreement status changes from Pending Start to Active. It performs any additional activities that are necessary to activate an SA. The following situations necessitate the definition of such an algorithm:</p> <ul style="list-style-type: none"> <li>- If you want to create a customer contact to indicate that a non-billed budget has been activated, use such an algorithm.</li> </ul> <p>Click <a href="#">here</a> to see the algorithm types available for this system event.</p>
SA Cancel	Optional	<p>These algorithms are executed when a service agreement status changes to Canceled. It performs any additional activities that are necessary to cancel an SA.</p> <p>An example of when you may use this algorithm is that perhaps your business rules dictate that the creation of a payment arrangement should create a credit rating history transaction. When a payment arrangement SA is canceled, the credit rating should be updated with an end date.</p> <p>Click <a href="#">here</a> to see the algorithm types available for this system event.</p>
SA Creation	Optional	<p>These algorithms are executed when a service agreement is created. The following situations necessitate the definition of such an algorithm on an SA type:</p> <ul style="list-style-type: none"> <li>- If you want to create a To Do entry whenever a new service agreement of a given type is added, specify such an algorithm.</li> <li>- If you want to automatically activate SAs of a given type (instead of waiting for the background SA activation process to run), specify such an algorithm.</li> <li>- If you want to create a Workflow Process when a service agreement of a given type is added, specify such an algorithm.</li> </ul> <p>Click <a href="#">here</a> to see the algorithm types available for this system event.</p>
SA Information	Optional	<p>We use the term "SA information" to describe the basic information that appears throughout the system to describe a service agreement. The data that appears in "SA information" is constructed using this algorithm.</p> <p>Plug an algorithm into this spot to override the "SA information" algorithm on installation</p>



options or the system default "SA information" if no such algorithm is defined on installation options.

Click [here](#) to see the algorithm types available for this system event.

---

SA Renewal	Optional	These algorithms are executed by the Service Agreement Renewal background process whenever an SA is due for renewal or when the user clicks the <b>Renew</b> button (for <b>Non-Billed Budgets</b> ). It performs any activities that are necessary to renew an SA and returns the new renewal and expiration dates for the SA.
------------	----------	---

Click [here](#) to see the algorithm types available for this system event.

---

SA Stop	Optional	These algorithms are executed whenever a service agreement's status changes from pending stop to stopped. The following situations necessitate the definition of a SA stop algorithm:  - For <b>Non-Billed Budgets</b> to distribute any remaining credit balance from the Non-Billed Budget SA to the covered SAs, you must specify such an algorithm.  - For service credit memberships that have a <b>refundable membership fee</b> , an SA Stop algorithm attempts to refund the fee if this is the last SA linked to the membership that is being stopped.
---------	----------	---

Click [here](#) to see the algorithm types available for this system event.

---

SA Stop Initiation	Optional	These algorithms are executed whenever a service agreement's status becomes pending stop. The following situations necessitate the definition of a stop initiation algorithm on an SA type:  - As explained under <b>Finalizing Pending Stops</b> , service agreements are normally transitioned from pending stop to stopped by a background process (or manually). For <b>Non-Billed Budget SAs</b> to transition to stopped automatically (without waiting for the background process), you must specify such an algorithm.
--------------------	----------	--

**When does a SA become pending stop?**  
Service agreements typically become pending stop when a user initiates a request to stop service on **Start Stop - Main**. A **severance process** with an Expire SA **severance event** causes a service agreement to become pending stop (when the event is executed).

Additionally, the [Stop Expired Service Agreements](#) background process starts the process to initiate the stop of an SA when the expiration date is on or before the process date.

Click [here](#) to see the algorithm types available for this system event.

---

Start Stop Field Work

Optional

These algorithms are executed to create the field activities necessary to start and stop service. Refer to [Starting Service and Field Activities](#) and to [Stopping Service and Field Activities](#) for a description of when algorithms of this type are called. The following situations necessitate the definition of a start stop fieldwork creation algorithm:

- If a service agreement has field activities created to start and stop service at its service points, its SA type must have an appropriate start stop field work creation algorithm.

Click [here](#) to see the algorithm types available for this system event.

---

## SA Type - Billable Charge Overrides

The [BCU2 - Create Billable Charge](#) background process is responsible for creating billable charges for each billable charge upload staging record interfaced into the system. This process will override the values of the various switches referenced on a billable charge upload staging line if the respective service agreement's SA type has an override value for the billable charge upload staging line's billable charge line type.

---

### NOTE:

**This information is optional.** If you don't need to override the values of a [Billable Charge Line Type](#) you don't need to set up this information.

---

Open **Admin > Customer > SA Type > Search** and navigate to the **BC Upload Override** page to define override values for a given SA Type / Billable Charge Upload Staging Line Type.

### Description of Page

Use the **Billable Charge Overrides** collection to define values to be overridden on billable charge lines uploaded from an external system (refer to the description above for the details). The following switches may be overridden for a given **SA Type** and **Billable Charge Line Type**.

- Use the **Show on Bill** switch to define the value to be defaulted into the Show on Bill indicator on billable charge upload lines that reference this line type.
- Use the **Appear in Summary** switch to define the value to be defaulted into the App in Summary indicator on billable charge upload lines that reference this line type.
- Use **Memo Only, No GL** switch to define the value to be defaulted into the Memo Only, No GL indicator on billable charge upload lines that reference this line type.
- Use **Distribution Code** to define the value to be defaulted into the Distribution Code on billable charge upload lines that reference this line type.

## SA Type - Contract Option Type

Open **Admin > Customer > SA Type > Search** and navigate to the **Contract Option Type** page to define the contract option types, which are valid for service agreements of a given type.

---

**NOTE:**

**This tab may not appear.** This tab is suppressed if the interval billing Contract Options module is [turned off](#).

---

### Description of Page

If the SA Type's special role flag is set to Bill Determinants Required, you may define the **Contract Option Types** that are valid for contract options linked to a service agreement of this type.

### Where Used

This information is used to validate the contract options linked to the service agreement. Refer to [Service Agreement - Contract Options](#) for more information.

## SA Type - NBB Recommendation Rule

Open **Admin > Customer > SA Type > Search** and navigate to the **NBB Rec'n Rule** page to define the recommendation rules that are valid for Non-Billed Budget SAs of this type.

### Description of Page

If the SA Type's special role is Non-Billed Budget, you may define the **Recommendation Rules** that are valid on non-billed budget SAs of this type. Check the **Use As Default** box to indicate the default recommendation rule for service agreements of this type.

---

**FASTPATH:**

For more information about Non-Billed Budgets, refer to [Defining Non-Billed Budget Options](#).

---

### Where Used

The Non-Billed Budget recommendation rules are used to recommend the payment amount and payment schedule for Non-Billed Budget service agreements. Refer to [Maintaining Non-Billed Budgets](#) for more information.

## Setting Up Start Options

Start options save users time and prevent data entry errors because they default many values on a service agreement (e.g., the rate schedule, recurring charge amount, contract riders, contract terms, characteristics, terms and conditions, etc. can all be defaulted onto a service agreement from a start option).

A SA type may have zero or more start options.

- A SA type without start options is usually one that has a very limited number of options. For example, if a SA type has a single valid rate and no customer-specific contract values, you don't need to setup a start option (the SA's default rate can default based on the information defined when you setup the SA type).
- A SA type with multiple start options is one where many different permutations are possible. For example, a SA type that can have multiple rates and each rate can have multiple riders is a good candidate for start options (where each start option will default, for example, a specific rate and set of contract riders).

When the [Start/Stop](#) transaction is used to start service AND the service being started uses a SA type with start options, the user is asked to select one of the start options. The service agreement that's created is populated with fields from the start option.

When the [Order](#) transaction is used to start service, the user selects start options, but only indirectly. It works like this:

- A user selects a "package" of services to start service for a customer.
- A "package" contains one or more start options.
- When a user selects a package, the system creates a service agreement for each start option on the package (and defaults the information on each service agreement from the respective start option).

A start option's default values may change over time (i.e., the information on a start option is effective-dated). The start service logic uses the version of the start option that is effective on the day service starts.

Start options can cause a great deal of information to be populated on a service agreement. There are several ways to change this default information:

- A user may override this information using the [Service Agreement](#) transaction.
- If the service agreement is in the pending start state, you can use the [Start/Stop - Pending SAs](#) page to change the service agreement's SA type and/or start option.
- If the service agreement is in active or pending stop states, a button appears on [Service Agreement - Main](#) called **Apply New Start Option**. When pressed, the user is allowed to define a start option and the date its terms become effective on the service agreement. Refer to [Changing A Start Option](#) for the details of this functionality.

The topics in this section describe how to setup start options.

---

**NOTE:**

**The merge transaction can save setup time.** The [Start Options Merge](#) transaction can be used to construct a start option by copying pieces from other start options.

---

## Start Option Considerations - Rate-Oriented SA Types

To understand the following discussion, you should be familiar with the following concepts:

- SA types that use rates have one or more valid rate schedules. Only these rate schedules may be defined on service agreements of a given type.
- One of a SA type's rate schedules may be designated as the "default" rate. The system assigns the "default" rate to new service agreements when a CSR doesn't choose a start option.
- Start options may be used by customer service reps when a service is started for a customer. A start option causes the customer's new service agreement to be populated with a specific rate and contract terms (e.g., contract riders, contract values). The use of start options is not allowed if the service's SA type does not require a start option. The use of start options is required if the service's SA type requires a start option.

Whether or not a SA Type has start options is dependent on the following factors:

- If a SA Type has only one valid rate and the rate doesn't use customer-specific contract terms (e.g., contract riders, contract values), the SA Type does not need any start options. Why? Because the system default's the SA type's default rate on new service agreement when no start option is used at start time.
- If a SA Type has only one valid rate, but under unusual circumstances, it uses customer-specific contract terms, you'll want an option for every situation (both the standard one and the unusual ones).
- If a SA Type has a single rate with a variety of contract terms (which, by definition, are different for each customer), then you'd want a start option for each permissible combination of contract terms. You'd also want to turn on the SA type's Start Option Required switch to make your CSR's pick one of the start options when service is started (rather than let the system use the SA type's default rate).

- If a SA type has multiple valid rates and a variety of contract terms (a combination of the previous two points), you'd need a start option for each permissible combination. You'd also want to turn on the SA type's Start Option Required switch to make your CSR's pick one of the start options when service is started (rather than let the system use the SA type's default rate).

## Start Option Considerations - SA Types That Use Recurring Charges

To understand the following discussion, you should be familiar with the following concepts:

- Many SA types use the recurring charge algorithms to generate the bill segments. For example, if you let a customer pay for a \$900 heat pump in 3 installments of \$300, you'd have an SA type called CA/MERCH-I and indicate it uses the recurring charge algorithm.
- When a CSR creates an SA type that uses recurring charge algorithms, they can enter the recurring charge amounts on [Start/Stop Service - Start Confirmation](#) window OR they can specify a start option on this window and let the system populate the recurring charge amount. For example, if you let a customer pay for a \$900 heat pump in 3 installments of \$300, you can set up a start option called HP 3PAY with an installment amount of \$300.
- Depending on the type of service being started, you might also need to generate an adjustment when service is started in order to initialize the total debt. For example, when a customer buys a heat pump we'll need an adjustment issued to realize the entire \$900 of revenue.

The following table provides examples of recurring charge SA types with several typical start options:

CIS Division/ SA Type	Start Option	Adjustment Type	Install Amount	Comments
CA/CHARITY	DONATE \$5		5	This causes a charitable contribution to be created with an installment amount of \$5.
CA/CHARITY	DONATE \$10		10	This causes a charitable contribution to be created with an installment amount of \$10.
CA/PA-REGU	PAY \$10 PM		10	This causes a payment arrangement to be created with an installment amount of \$10.
CA/PA-REGU	PAY \$20 PM		20	This causes a payment arrangement to be created with an installment amount of \$20.
CA/PA-UNRE	PAY \$10 PM		10	This causes a payment arrangement to be created with an installment amount of \$10.
CA/PA-UNRE	PAY \$20 PM		20	This causes a payment arrangement to be created with an

				installment amount of \$20.
<b>CA/MERCH-I</b>	HP 3PAY	HEATPUMP	300	This causes a merchandise service agreement to be created with an installment amount of \$300. It also causes an adjustment to be issued to realize the \$900 of revenue.
<b>CA/MERCH-I</b>	BBQ 3PAY	BBQ	250	This causes a merchandise service agreement to be created with an installment amount of \$250. It also causes an adjustment to be issued to realize the \$750 of revenue.
<b>CA/DEP-I</b>	PAY \$40 PM		40	This causes a deposit service agreement to be created with an installment amount of \$40. The CSR would be required to define the total deposit amount to be billed over the life of the service agreement on the secondary SA window on the Start Account window.

## Start Option Considerations - Initial Adjustment SA Types

To understand the following discussion, you should be familiar with the following concepts:

- Some SA types depend on an adjustment to book their initial debt. For example, the CA/MERCH-I SA type requires an initial adjustment to book the payoff amount for the entire cost of the merchandise. Another example would be a loan service agreement (refer to [Booking The Principal Amount Using An Adjustment](#) for the details).
- When a CSR starts an SA type that requires an initial adjustment, they can create the adjustment immediately after starting service OR then can specify a start option when they start service and let the system generate the adjustment. You could let the system create the adjustment to book the \$900 associated with the heat pump as shown in the previous section.

The following table provides examples of SA types that use adjustments with several typical start options:

CIS Division/ SA Type	Start Option	Adjustment Type	Install Amount	Comments
<b>CA/MERCH-I</b>	HP 3PAY	HEATPUMP	300	This causes a merchandise service agreement to be created with an installment

				amount of \$300. It also causes an adjustment to be issued to realize the \$900 of revenue.
CA/MERCH-I	BBQ 3PAY	BBQ	250	This causes a merchandise service agreement to be created with an installment amount of \$250. It also causes an adjustment to be issued to realize the \$750 of revenue.
CA/CONNECT	CONNECT	CONNECT		This causes an adjustment to be issued to realize the connection charge.

## Start Option - Main

Open **Admin > Customer > SA Type Start Option > Add** to define a SA type's start options.

### Description of Page

Every start option is uniquely identified by the following fields:

**CIS Division & SA Type** Enter the Division and SA type to which the start option is linked.

**Start Option** Enter the unique identifier of the option. Pick something easy to recognize as this will be used by CSRs to pick an option when they start service.

**Effective Date** Enter the earliest effective date. It should be the same as the earliest effective date of the start option's rate (although it doesn't hurt for it to be earlier). The date defaults to the current date. (The status, below, should be Active.)

The remaining fields further describe a start option.

Enter a **Description** for the start option.

Indicate its **Status**. For new start options, the status should be Active. When it's no longer applicable, change it to Inactive.

Enter the primary **Rate Schedule** that should be defaulted onto service agreements created using this option. Refer to [Start Option Considerations For SA Types That Use Rates](#) for more information.

#### FASTPATH:

For more information about a service agreement's rates, refer to [Service Agreement - Rate Info](#).

Enter the **Adjustment Type** that should be generated, if any, when service is started using this option. Refer to [Start Option Considerations For SA Types That Use Initial Adjustments](#) for more information.

Enter the **Recurring Charge Amount** that should be defaulted onto service agreements created using this option. This field is only visible when the SA type allows recurring charges. In addition, the prompt for this field is defined on the SA type table on the billing window (e.g., it could appear as Payment Amount, Budget Amount, or Installment Amount). Refer to [Start Option Considerations For SA Types That Use Recurring Charges](#) for more information.

Enter the **Currency Code** in which monetary amounts are denominated.

#### NOTE:

The currency code defaults from the [installation record](#).

---

Enter the **Total Amount to Bill** that should be defaulted onto service agreements created using this option. This is useful to initiate either a loan or a deposit. The prompt for this field is defined on the SA type table on the billing window (e.g., it could be Deposit Amount or Loan Amount).

Use **Number of Periods** to default the number of payment periods of service agreements created using this option. This field is only allowed for SA types with special role of Loan. Refer to [The Terms Of A Loan Are Stored On A Service Agreement](#) for more information.

If your SA Type has a special role of Billing Determinants Required, you may enter the **Cutoff Time** and **Start Day Option** that should be defaulted onto service agreements that are created using this option. For start day option, you may choose **Current Day** or **Previous Day**.

If your SA Type has a special role of Billable Charge, then you can setup the start option to automatically create a billable charge when a service agreement is created using this start option. For example, you might have a start option that automatically creates a "one-time invoice" service agreement along with a "tree trimming" billable charge. To use this feature you should turn on the **Create Billable Charge** switch and specify the **Billable Charge Template** that will be used to create the billable charge. These fields are only allowed for SA types with special role of Billable Charge.

---

**FASTPATH:**

Refer to [Setting Up Billable Charge Templates](#) for more information about templates. Refer to [An Easier Way To Create One Time Charges](#) for an example of how you can setup a campaign with packages that use this type of start option.

---

**NOTE:**

The duplicate action in the page actions toolbar enables you to copy another start option. Refer to [Duplicate Button](#) in the system wide standards document for more information.

---

## Start Option - Rate Info

Open **Admin > Customer > SA Type Start Option > Search** and navigate to the **Rate Info** page to define the start option's default values for contract riders and contract values.

### Description of Page

The information in the **Contract Riders** collection defines the contract riders to be defaulted onto service agreements created using this start option. The following fields are required for each instance:

**Bill Factor** The bill factor defines the type of rider. You may only reference bill factors designated as being applicable for contract riders.

**Number of Days** The number of days the rider should be in effect. This value is used by the system to set the stop date on the service agreement's contract rider. If the rider has no expiration, set this field to 0. Default note: this field will be set to 0 if left blank.

---

**FASTPATH:**

For more information about a service agreement's contract riders, refer to [Service Agreement - Contract Riders](#).

---

The information in the **Contract Values** collection defines the contract values to be defaulted onto service agreements created using this start option. The following fields are required for each event:

**Bill Factor** The bill factor defines the type of value. You may only reference bill factors designated as allowing values in contract terms.

---



**Number of Days** The number of days the value should be in effect. This value is used by the system to set the stop date on the service agreement's contract value. If the value has no expiration, set this field to 0.

**Value** The amount of the contract value.

---

**FASTPATH:**

For more information about a service agreement's contract values, refer to [Service Agreement - Contract Values](#).

---

## Start Option - Characteristics & Qty

Open **Admin > Customer > SA Type Start Option > Search** and navigate to the **Characteristics & Qty** page to define the start option's default values for characteristics and contract quantities.

### Description of Page

The information in the **Characteristics** collection defines the characteristics to be defaulted onto service agreements created using this start option. The following fields are required for each instance:

**Characteristic Type** This defines the type of characteristic. Note: you may only define characteristics valid on service agreements.

**Characteristic Value** This defines the characteristic value that will be defaulted.

---

**FASTPATH:**

For more information about a service agreement's characteristics, refer to [Service Agreement - Characteristics](#).

---

The information in the **Contract Quantity** collection defines the contract quantities to be defaulted onto service agreements created using this start option. The following fields are required for each instance:

**Contract Quantity Type** This defines the type of contract quantity.

**Contract Quantity** The amount of the contract quantity.

---

**FASTPATH:**

For more information about a service agreement's contract quantities, refer to [Service Agreement - Contract Quantity](#).

---

## Start Option - Contract Option

---

**NOTE:**

**This tab may not appear.** This tab is suppressed if the interval billing Contract Options module is [turned off](#).

---

Open **Admin > Customer > SA Type Start Option > Search** and navigate to the **Contract Option** page to define the start option's contract option default values.

### Description of Page

The collection of contract option types will be used to link contract options to a service agreement that will be created with this start option. If the contract option to create for the service agreement will be SA Specific, simply indicate the **Contract Option Type**. This will cause a new contract option to be created with this contract option type and the new contract option will be linked to the new SA at start time. If the contract option to create for the service agreement will be Shared, indicate the contract option type and the **Contract Option ID**. This will cause the specified contract option to be linked to the new SA at start time.

## Start Option Merge

Use this page to modify an existing start option by copying information from other start options. This page may be used to copy records from the contract rider, contract value, contract quantity, characteristic, contract option and TOU contract value collections from one or more existing start options to another.

---

**NOTE:**

The target start option must exist prior to using this page. If you are creating a new start option, you must first go to the [Start Option](#) page to add the new start option and then navigate to the merge page to copy collection information.

---

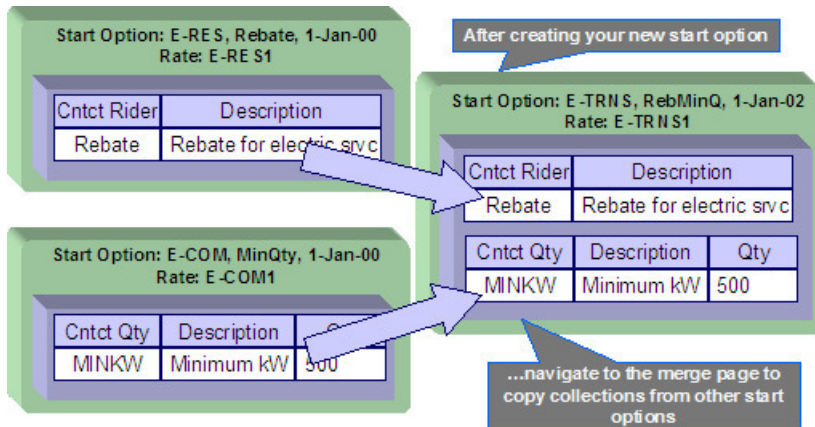

---

**NOTE:**

**Duplicate versus Merge.** The [Start Option](#) page has [Duplication](#) capability. You would duplicate a start option if you want to a) create a new start option AND b) populate it with all the information from an existing start option. You would use the start option merge page if you want to build a start option using pieces of one or more start options.

---

## Start Option Merge - Main

Open **Admin > Customer > SA Type Start Option Merge**.

### Description of Page

Select the **Original Start Option**, which is the target for merging the start option collection information.

Select the **Merge From Start Option**, which is your template start option to copy the collections from.

---

**NOTE:**

You may only copy information from one Merge From start option at a time. If you wish to copy information from more than one start option, select the first Merge From start option, copy the desired records, Save, then select the next Merge From start option.

---

The left portion of the page will display any existing records in the collections for the original start option. The right portion of the page will display the existing records in the collections for the Merge From start option.

You may use the **Copy All** button to copy all the records in all the collections from the Merge From start option to the Original start option. If you do not choose to copy all, you may copy records individually as described below.

The left portion of the **Contract Riders** collection initially displays existing contract riders linked to the original start option. In the **Merge Type**, you will see the word Original, for any of these records. The **Bill Factor** and **Number of Days** for each contract rider is displayed. In the right portion of the collection, the existing records in the merge from start option are displayed initially.

The left portion of the **Contract Values** collection initially displays existing contract values linked to the original start option. In the **Merge Type**, you will see the word Original, for any of these records. The **Bill Factor**, **Number of Days** and **Value** for each contract value is displayed. In the right portion of the collection, the existing records in the merge from start option are displayed initially.

The topics, which follow, describe how to perform common maintenance tasks:

## Removing A Row From A Grid

If you wish to remove a record linked to the Original start option, click the "-" button to the left of the record.

## Adding A New Row To A Start Option

You may move any of the records from the Merge From start option to the original start option by selecting the left arrow adjacent to the desired row. Once a record is moved it will disappear from the Merge From information and appear in the Original information with the word Merge in the Merge Type column.

## Removing An Uncommitted Row From A Start Option

If you have copied a row across by mistake, you may remove it by clicking on the right arrow adjacent to the appropriate record.

## Start Option Merge - Characteristics and Quantities

Open **Admin > Customer > SA Type Start Option Merge** and navigate to the **Characteristics and Quantities** page to copy rows in the characteristic and contract quantity collections.

### Description of Page

The left portion of the **Characteristics** collection initially displays existing characteristics linked to the original start option. In the **Merge Type**, you will see the word Original, for any of these records. The **Characteristic Type** and **Characteristic Value** for each characteristic are displayed. In the right portion of the collection, the existing records in the merge from start option are displayed initially.

The left portion of the **Contract Quantity** collection initially displays existing contract quantities linked to the original start option. In the **Merge Type**, you will see the word Original, for any of these records. The **Contract Quantity Type** and **Contract Quantity** for each contract quantity are displayed. In the right portion of the collection, the existing records in the merge from start option are displayed initially.

---

### FASTPATH:

Refer to [Start Option Merge - Main](#) for more information about how to perform common maintenance tasks for the grids displayed on this page.

---

## Start Option Merge - Contract Option

Open **Admin > Customer > SA Type Start Option Merge** and navigate to the **Contract Option** page to copy rows in the contract options collection.

---

**NOTE:**

**This tab may not appear.** This tab is suppressed if the interval billing Contract Options module is [turned off](#).

---

### Description of Page

The left portion of the **Contract Option** collection initially displays existing contract option information linked to the original start option. In the **Merge Type**, you will see the word Original, for any of these records. The **Contract Option Type**, **Contract Option ID** and **Description** of the contract option for each contract option row are displayed. In the right portion of the collection, the existing records in the merge from start option are displayed initially.

---

**FASTPATH:**

Refer to [Start Option Merge - Main](#) for more information about how to perform common maintenance tasks for the grids displayed on this page.

---

## Start Option Merge - Terms and Conditions

Open **Admin > Customer > SA Type Start Option Merge** and navigate to the **Terms and Conditions** page to copy terms and conditions (T&Cs).

### Description of Page

The left side of the **Terms and Conditions** grid initially displays the T&Cs linked to the original start option. On the right side, the T&Cs linked to the merge from start option are displayed initially.

---

**FASTPATH:**

Refer to [Start Option Merge - Main](#) for a description of how to perform common maintenance tasks for the grids displayed on this page.

---

## Defining SA Relationship Options

We use the term "SA Relationship" to describe functionality that supports the following situations:

- When companies other than your own provide a service to your customers AND you have some type of interaction with these companies. For example, in a deregulated market, customers deal with both distribution and energy supply companies. These companies typically exchange a great deal of information about their joint customers.
- When multiple rates are associated with a service (where each rate corresponds with a sub-category of service). For example, most water companies charge for both water and wastewater service using separate rates for each. While it is possible to set up water and wastewater as separate service agreements, the SA relationship functionality allows you to set up a single "master" service agreement (for the water service) and associate with it a "sub" service agreement (for the wastewater service).
- When a party representing a group of customers negotiates a contract that is applied over and above those of the individual service agreements. For example, the head office of a national chain may negotiate for additional discounts that should be calculated together or individually. The SA relationship functionality may be used to track the covered

service agreements and to calculate and transfer discounts to the head office's service agreement. Refer to the special discounts section.

---

**WARNING:**

Setting up the SA relationship control tables is as challenging as your organization's business rules. If you don't have requirements similar to those described above, you don't have to set up anything. If you have these types of requirements, your setup process will be taxing as you must design and set up control tables that manage the financial and consumption interactions that take place between you, your customers, and the various service providers.

---

The topics in this section describe tables that control your SA relationship functionality.

## The Big Picture of SA Relationships and Service Providers

You must set up service providers if companies other than your own provide a service to your customers AND you have some type of interaction with these companies. You will have one service provider for each such company. For example, if you are a distribution company in a deregulated market, you will have a service provider for each company that provides any of the following services:

- Energy (commonly referred to as Energy Supply Companies, Energy Service Providers, Retailers, and Suppliers)
- Meter service (commonly referred to as Meter Service Providers and Meter Agents)
- Meter reading (commonly referred to as Meter Data Management Agencies and Meter Reading Service Providers)
- Billing (commonly referred to as Billing Agents)

The topics in this section provide background information about service providers.

## Persons and Service Providers

A great deal of information about your service providers is defined using a person. For example, a service provider's name, address, phone numbers, electronic ID's, etc. are all defined on the person object.

In addition, every service provider must have a service provider object created for it. The service provider object contains information about a provider's relationships with the customer and your organization, for example:

- Do you calculate bills for the service provider? If so, do you have their rates or do they interface their charges to you? Refer to [Billing Relationships](#) for more information.
- Do you send the customers' consumption to the service provider? Do they send it to you? Refer to [Consumption Relationships](#) for more information.
- How are financial settlements between your organization and the service provider implemented (do you pay them when you get paid?, do you purchase the receivable for them?, etc.). Refer to [Service Providers Have Service Agreements Too](#) for more information.
- Etc.

---

**FASTPATH:**

Refer to [Designing Your SA Relationship Types and Service Providers](#) for more information.

---

**NOTE:**

In some situations, you will need to set up a service provider for your own company. Refer to [When Your Company Is A Service Provider](#) for the details.

## Service Providers Are Linked To Service Agreements

The following diagram illustrates a customer's bill for electric service in a deregulated market. Notice that there are separate sections for energy, distribution and meter service.

**NOTE:**

**Consolidated billing.** The following is an example of a bill that consolidates charges from many service providers. Rather than receive a consolidated bill, it is possible for the customer to receive 3 separate bills, one from each service provider (we refer to this as Dual billing).

Customer's Electric Bill	
Energy Supply - Cheap Power	\$12
Distribution - LG&E	\$9
Meter Service - MeterCo	\$2

If we were to look at this customer's service agreement in the distribution company's CIS system, we'd find a service agreement for distribution charges, and linked to it would be information about the meter service and energy service providers:

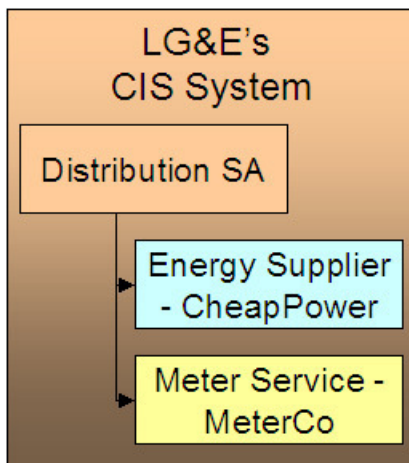

If we look at this customer's service agreement in the energy supply company's CIS system, we'd find a service agreement for energy charges, and linked to it would be information about the distribution and meter service providers:

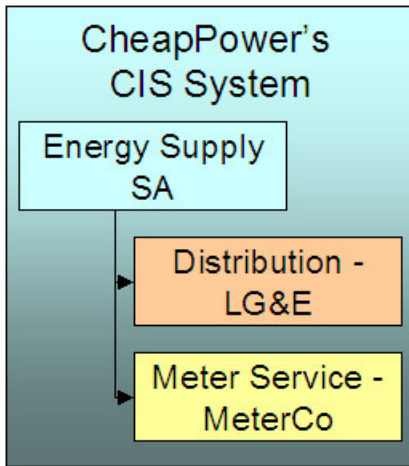

And finally, if we look at this customer's service agreement in the meter service company's CIS system, we'd find a service agreement for meter service charges, and linked to it would be information about the distribution and energy providers:

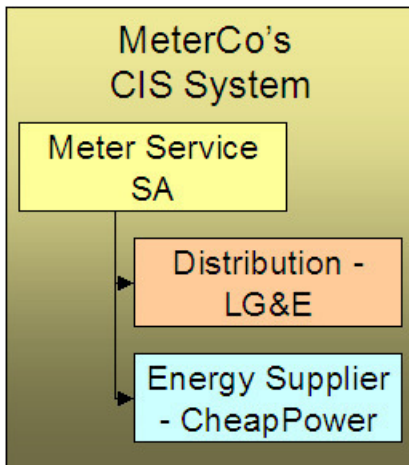

**NOTE:**

**Bottom line.** A customer's service providers keep track of the customer and each other in their respective CIS systems. A customer will have a service agreement (or the equivalent) in each service provider's CIS system. A customer's service agreement defines the service providers who supply each type of service.

**FASTPATH:**

Because information about customers and their services needs to be kept up-to-date in many different CIS systems, there is a need for automated communications between service providers. Refer to [Service Providers Have To Communicate About Customers](#) for more information.

## Service Providers May Change Over Time

A customer typically has a choice of service providers. Over time, their choice may change. The system keeps track of a customer's service providers throughout time so that it can accurately cancel / rebill historical bills. This means that the service provider relationship is *effective-dated*.

The following diagram illustrates how a distribution company's system keeps track of a customer's service providers (notice the customer changed energy suppliers):

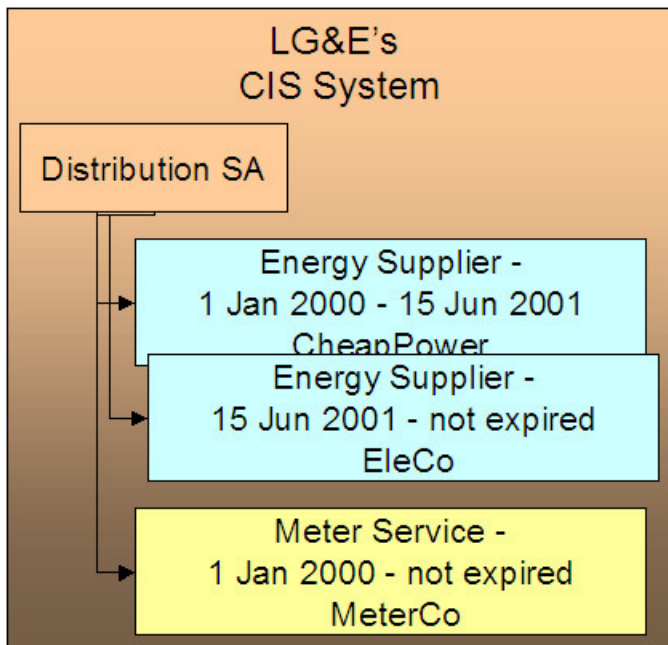

## How To Set Up SA Relationships On A Customer's Service Agreement

There are three ways to set up a customer's service providers:

- **Manually.** An operator can manually change a service agreement's SA relationships. The manual method is NOT recommended as changing service providers typically involves many events (e.g., you have to notify the current service provider that they will be dropped).
- **Use Default Service Providers.** The system will default a service provider on a required SA relationship when a service agreement is activated. Refer to [Defaulting Relationship Types And Defaulting Service Providers](#) for more information.

## When Your Company Is A Service Provider

Besides setting up service providers for other companies that provide services to your customer, you may have to set up a service provider for your own company. You have to do this when:

- **Your organization can supply one of the services.** Refer to the illustration in [Service Providers Are Linked To Service Agreements](#). If you are LG&E and you supply energy in addition to distribution, you would need to set up a service provider for your own organization. Why? Because whenever you have a subcategory of service (e.g., energy supply), you must indicate the service provider who provides this service; even when it's you.
- **You decide to break up a service into subcategories** (and have a separate service agreement for each category). For example, a water company may choose to break up service charges into water, wastewater and storm water (they may do this because there are different rates for each category of service). The following is an example of the segregated charges associated with this water company's service charges.



Customer's Water Bill	
Water Service - WaterCo	\$15
Wastewater - WaterCo	\$6
Storm Water - WaterCo	\$5

This water company system may benefit by creating a single service (for water) and indicating there are subcategories of service (for wastewater and storm water). Whenever you have a subcategory of service, you must indicate the service provider who provides this service. And, in this example, the water company would be the sole service provider for each subcategory of service.

Customer's Water Bill	
Water Service - WaterCo	\$15
Wastewater - WaterCo	\$6
Storm Water - WaterCo	\$5

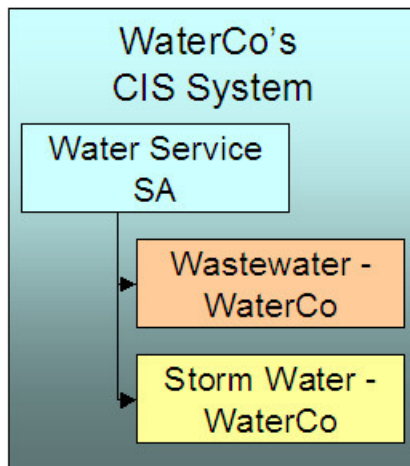

**NOTE:**

Refer to [We Bill For Them - Rate Ready Bill Segments Are Special](#) for restrictions in respect of using subcategories of service.

## Service Providers Have To Communicate About Customers

The providers of service typically have to communicate with each other in respect of the customer's service. The following diagram illustrates the major interfaces of information between your system and your service providers.

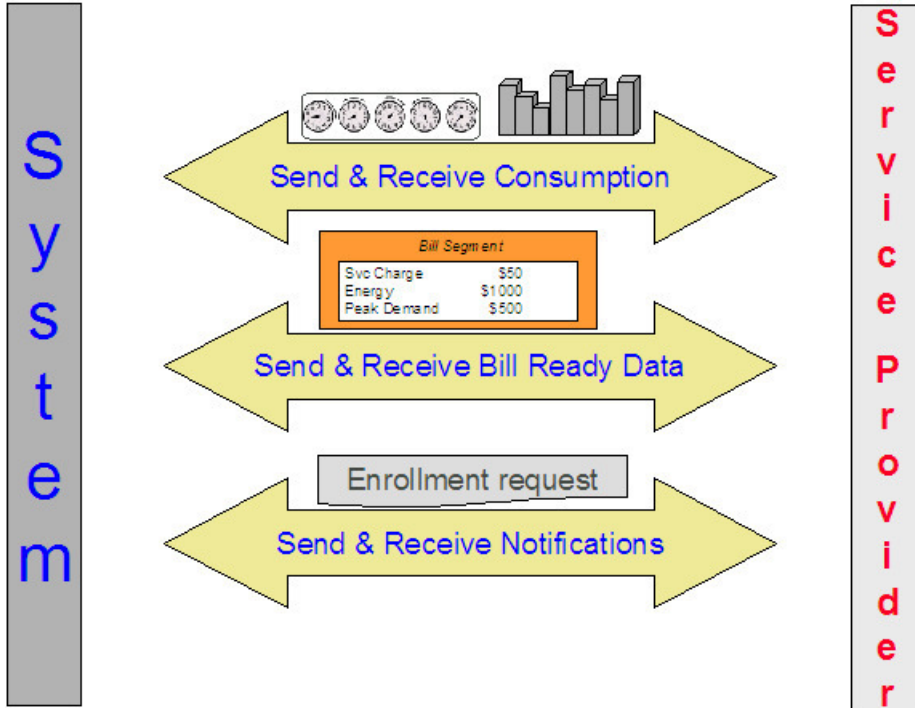

Depending on where your organization fits in the service provider hierarchy, you may:

- Bill for other service providers (or they may bill for you). Refer to [Billing Relationships](#) for more information about billing communications.
- Send the customer's consumption to service providers (or they may send it to you). Refer to [Consumption Relationships](#) for more information about consumption communications.
- Apprise service providers of the changes to the customers' service (or they may apprise you). Refer to [How Do You Communicate With Service Providers?](#) for more information about communications between service providers.

## Relationships Between Service Providers

Service providers may arrange contractual relationships with other service providers to provide additional services, e.g., an energy service provider may work with a specific meter data management agency to gather and report interval meter read data.

The system does nothing special to enforce or record these inter-relationships. Why? Because most service provider switches are received by notification records. Notification records indicate all the associated service providers. There is no need for the system to maintain the inter-service provider associations.

## A Service Agreement Can Have Many Types Of Relationships

As described in the previous sections, a given service can be subdivided into subcategories. Each type of service can have zero, one or more subcategories. We call each subcategory a **SA Relationship Type**. The topics in this section provide information about SA relationship types.

### An Example

We'll use the following example of a customer in a municipal utility's CIS system to explain SA Relationship types:

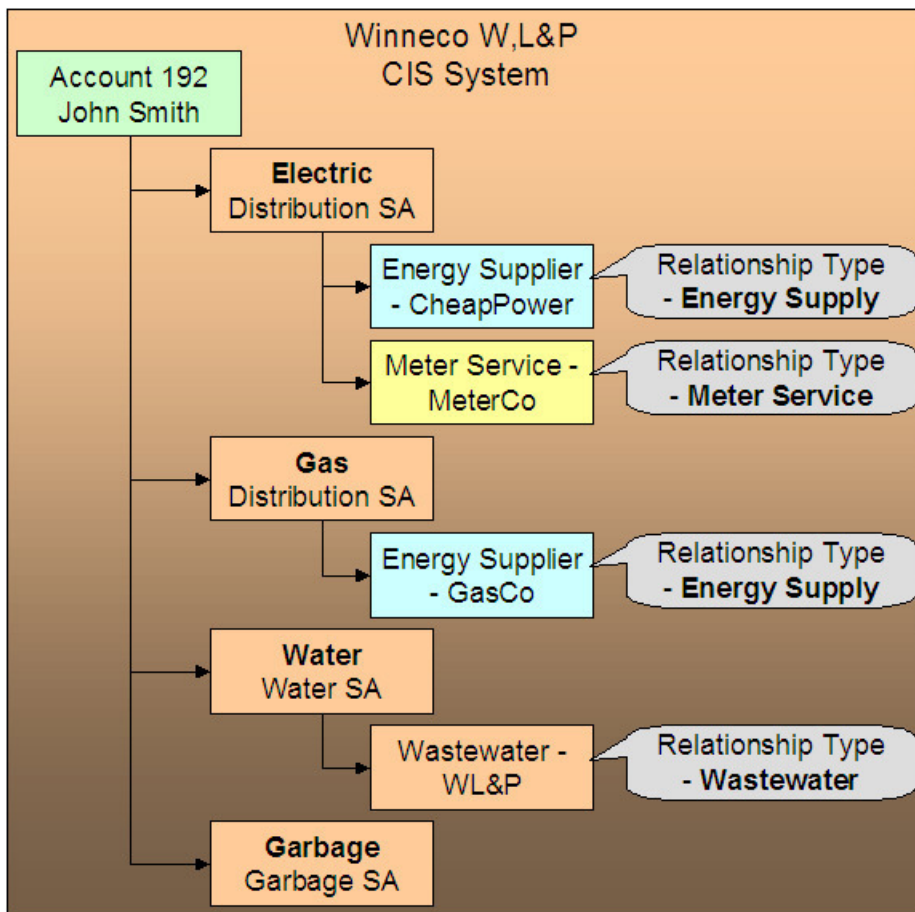

Note the following:

- Electric service has 2 SA relationship types: energy supply and meter service.
- Gas service has 1 SA relationship type: energy supply.
- Water service has 1 SA relationship type: waste water.
- Garbage service has no SA relationship types.

**NOTE:**

**Bottom line.** Service providers are related to the customer via "your" service agreement. Each service provider linked to a service agreement is defined in respect of a SA Relationship Type. This relationship is effective-dated because we care about how it changes over time.

**Your relationship type is implied.** The SA relationship type of "your" service agreement is implied, e.g., if you are a distribution company, "your" service agreement's implied SA relationship type is "distribution".

---

## Valid Relationship Types and Service Providers Are Defined On SA Types

You control which services have SA relationships (and which don't) when you set up your SA types. Each SA type can have zero, one or more SA relationship types. Each relationship type, in turn, can have one or more valid service providers.

---

**FASTPATH:**

Refer to [Setting Up SA Relationships For SA Types](#) for the page used to define the service providers and SA relationship types for each SA type.

---

## Defaulting Relationship Types And Defaulting Service Providers

Please be aware of the following:

- A SA relationship type for a given SA type can be marked as being **Required**.
- A service provider for a given SA relationship type / SA type can be marked as being the **Default**.

If, at activation time, the customer's master SA is missing a **Required** SA relationship that has a **Default** service provider, the activation process automatically creates the SA relationship type and links to it the **Default** service provider. If a master service agreement doesn't have all **Required** SA relationships, the service agreement cannot be activated. This is handy when your organization is the default service provider for a relationship type.

---

**FASTPATH:**

Refer to [Automatic Creation of Sub SAs](#) for information about how the system will automatically create sub service agreements for the defaulted SA relationship / service provider if your organization provides billing services for the service provider. Refer to [Setting Up SA Relationships For SA Types](#) for the page used to define the service providers and SA relationship types for each SA type.

---

## Required Relationship Types and Billing

When the system attempts to create a bill segment for a service agreement whose SA type has **Required** relationship types, it checks if all such relationships are defined for the service agreement. If not, a bill segment error will be generated.

The reason this restriction exists is to handle the situation when your required relationship types change over time. For example, assume on your first day of production you only need energy suppliers defined on electric service agreements. After several months, gas deregulates. When this happens, you will need to change your control tables to indicate that your gas SA types require an energy supplier. If you don't write a default program to update your existing gas service agreements, billing will complain.

## Relationship Types Do Not Impact Start/Stop

Customer service representatives (CSR's) are typically not involved with the customer's choice of service providers. Most organizations hear about a customer's service providers from the service providers or from a central body. This means that the start/stop dialog is not impacted by SA relationships. This also means that CSR's are not impacted by SA relationships

---

(unless something goes wrong). If something goes wrong, the CSR's may need to manually correct SA relationships. Refer to [How To Set Up Service Providers On A Customer's Service Agreement](#) for more information.

## Billing Relationships

When you set up a service provider, you must define your organization's billing relationship with the service provider. The following points provide examples of the billing relationships supported in the system,

- If you are an energy supply company, you may provide billing services for the distribution company. This means that your bill contains both your charges and the distribution company's charges. We refer to this as the **We Bill For Them** billing relationship.
- Alternatively, the distribution company may provide billing services for you. This means that the distribution company's bill contains your charges and their charges. We refer to this as the **They Bill For Us** billing relationship.
- Alternatively, you may both send bills to the customer. We refer to this as the **Dual Billing** relationship.
- Alternatively, if you subcategorize your services OR if your company provides one of the services that is provided by your service providers, then the system will create a separate bill segment for the subcategory of service. We refer to this as the **It's Us** billing relationship.

If you provide billing services for another service provider (i.e., you bill for them), there are two ways to determine the service provider's charges:

- You can load the service provider's rates in your system and calculate the charges for the service provider. We call this the **Rate Ready** calculation method.
- You can let the service provider calculate their own charges and interface them to you. We call this the **Bill Ready** calculation method.

If a service provider provides billing services for you (i.e., they bill for you):

- If the service provider has a suitable CIS system, they can load your rates in their system and calculate your charges for you. We call this the **Rate Ready** calculation method.
- You can calculate your charges and interface them to them. We call this the **Bill Ready** calculation method.

If you don't have a billing relationship with a service provider, you still need a service provider record to define such. Why? Because the system needs to know that it doesn't have to worry about a particular service provider in respect of billing. In addition, you may have other interactions with a service provider that have nothing to do with billing, e.g., you may send or receive consumption.

The topics in this section provide a wealth of information about the various billing relationships and the ramifications of each.

## Sub Service Agreements

If you provide billing services for another service provider OR if you subcategorize your own charges, there will be a separate service agreement (SA) linked to the customer's account that holds these unique charges. We refer to this new service agreement as a **Sub SA**. We use the term "sub" because this service agreement is subservient to the "master" service agreement. By subservient we mean:

- A sub SA's start and stop dates are the same as the master SA. This statement may seem odd, but it's true – all sub SAs linked to a master service agreement have the same start and stop dates as the master.
- A sub SA's status (i.e., *pending start*, *active*, *pending stop*, *stopped*, etc.) is controlled by its master service agreement. As a rule, the master SA transitions its status first and the sub SA(s) follow.

---

**NOTE:** There are situations where the master service agreement transitions its status and the sub service agreement(s) does not. One example of this is when both the master and sub SAs are closed and a payment cancellation occurs that only affects the master SA. In this scenario, the master SA becomes reactivated and the sub SA remains closed. Another example is when a straggling billable charge posts to a sub SA; the master SA is not affected.

---

- Refer to [The Rate Ready Calculation Method](#) for additional examples of subservience.
- 

**NOTE:**

You may find it helpful to keep in mind that sub SAs are only used for service providers with a billing relationship of It's Us and We Bill For Them. This is because these are the only relationships that have implicit billing responsibilities.

---

The topics in this section provide additional information about sub SAs.

## Only Some Service Providers Have Sub SAs

If you do not provide billing services for a service provider, there will be no sub SAs associated with the service provider's SA relationships. Let's use an example to make the point; assume:

- Service is divided into distribution, energy and meter service charges.
- You are the distribution company and you provide billing services for the energy supply company.
- The meter service company bills the customer independently.

In this situation, the customer will receive two bills: one from you (LG&E), the other from MeterCo. Notice that your bill (LG&E) contains your distribution charges AND CheapPower's energy charges:

Customer's Electric Bill from LG&E	
Energy Supply - Cheap Power	\$12
Distribution - LG&E	\$9

Customer's Electric Bill from Meter Co	
Meter Service - MeterCo	\$2

If we were to look at the customer information in the three service providers' respective CIS systems, we'd find the following service agreements and SA relationships for the customer:

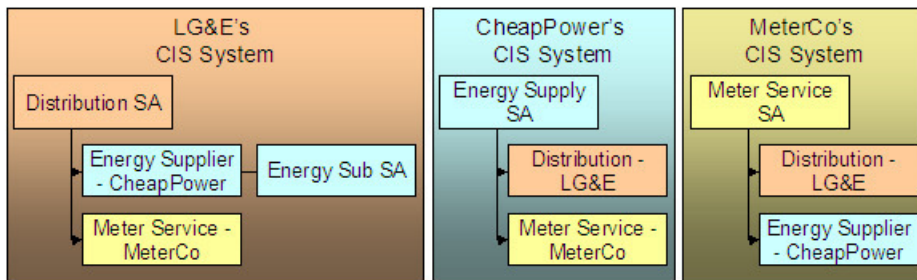

Notice the following:

- The customer has a service agreement in each supplier's CIS system.
- Because LG&E (the distribution company) bills for CheapPower, all customers who have their energy supplied by CheapPower will have a sub SA in LG&E's system. This sub SA maintains the charges (and receivable balance) associated with CheapPower's energy charges.
- Notice that neither CheapPower's nor MeterCo's CIS systems use sub SAs. This is because neither company bills for other service providers.

**NOTE:**

**Sub SAs are needed if you subcategorize your charges.** The above example shows sub SAs being used when a company provides billing service for another company. Sub SAs are also used when you subcategorize your charges - each sub SA contains the rate associated with each subcategory.

## Automatic Creation of Sub SAs

The system creates sub SAs for customers choosing service providers where the billing option is It's Us or We Bill For Them. The system creates sub SAs via the following mechanisms:

- The [analyze SA relationships](#) background process (ANLYZSAR) monitors newly activated SA relationships. If the respective service provider is It's Us or We Bill For Them, this process creates the sub SA(s) using the information defined on [SA Type SA Relationship Type - Sub SA Type](#).

**NOTE:**

The [analyze SA relationships](#) background process also activates and stops sub SAs. Refer to [Sub SA State Transition](#) for the details.

- A button exists on the [SA Relationships](#) page. This button, when pressed, creates sub SAs real-time. This button would only be used if the operator couldn't wait for the background process to run.

The SA type associated with the new sub SAs is defined when you set up each SA Type / SA Relationship Type. Refer to [Setting Up SA Relationships For SA Types](#) for more information.

If the SA type uses start options, the start option contains additional values (e.g., rates, contract riders) that are used to populate the newly created sub SAs. Note: start options are typically not used for We Bill For Them - Bill Ready service provider because we don't need to default rates, contract riders and/or contract values on billable charge sub SAs. Refer to [Setting Up SA Relationships For SA Types](#) for more information.

**NOTE:**

**Manually created sub SAs.** In very unusual situations, an operator may create a sub SA manually. An operator would do this using the [SA Relationship](#) transaction.



## Sub SA State Transition

Sub SAs follow normal SA state transition rules, but have a few additional rules about when the transitions can take place.

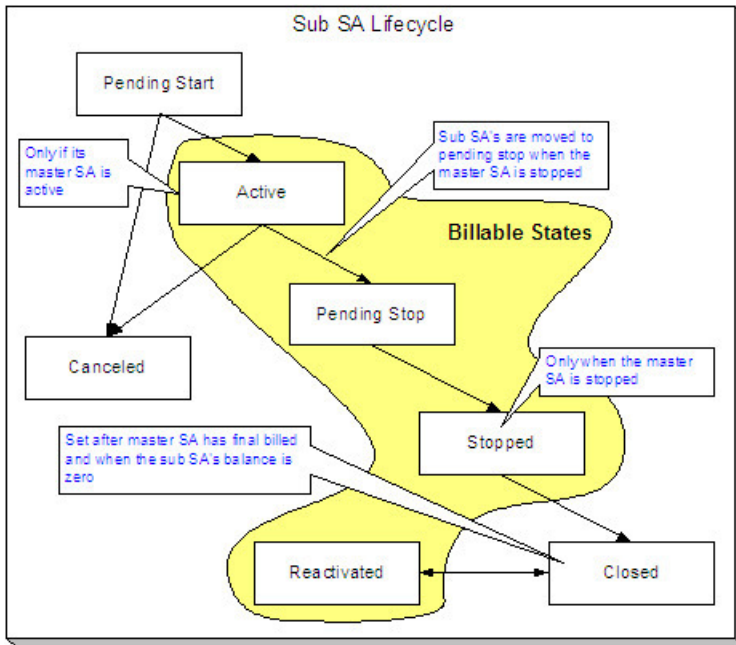

The following points highlight the additional state transition rules:

- A sub SA can only become Active if its master SA is Active. Most sub SAs are activated by the [analyze SA relationships](#) background process. However, a user can manually activate a sub SA using the activate button on the [SA maintenance](#) page.
- Sub SAs become Pending Stop when their master becomes Stopped. This typically occurs when the [SA activation background process](#) stops the master SA. However, this can happen real time if a user manually stops a master SA using the stop button on the [SA maintenance](#) page.
- A sub SA can only become Stopped if its master SA is Stopped. Most sub SAs are stopped by the [analyze SA relationships](#) background process. However, a user can manually activate a sub SA using the stop button on the [SA maintenance](#) page.
- A sub SA becomes Closed if its master has been final billed and it has a balance of zero. Most sub SAs are closed when their balance becomes zero after the master SA is final billed. However, a user can manually close a sub SA using the close button on the [SA maintenance](#) page. Note, if additional billable charges are interfaced after the master has been closed, the sub SA will be Reactivated.

## We Bill For Them

If you provide billing services for another service provider, then you have a We Bill For Them billing relationship with the service provider. The topics in this section provide information about this type of billing relationship.

## Sub SAs Are Used When We Bill For Them



As described under [Sub Service Agreements](#), sub SAs are used for We Bill For Them service providers. The sub SAs hold the service providers charges. It's important to note that the system allows more than one sub SA to be created for a given service provider.

## The Rate Ready Calculation Method

If you provide billing services for a service provider (i.e., the service provider has a billing relationship of We Bill For Them ), you can load the service provider's rates in your system and calculate the charges for the service provider. We call this the **Rate Ready** calculation method.

**NOTE:**

It's Us **can be Rate Ready**. The prior paragraph indicated that the Rate Ready billing option was used for We Bill For Them service providers. If you subcategorize your services and use rates to calculate each subcategory's charges, the service provider(s) set up for your own organization will also be subject to the Rate Ready rules described below.

If a customer uses a We Bill For Them - Rate Ready service provider, the system will create a separate bill segment for the service provider's charges. Keep in mind the following in respect of these types of bill segments:

- The consumption is copied from the "master" service agreement (note: we copy item details and read details after pre-processing calculation groups, if any exist, have been applied). This means that the bill period on the sub SA's bill segment is identical to that on the normal SA. This also means that if the "master" SA is in error, bill segments for the sub SA will not be created.
- The rate defined on the sub SA is applied against this consumption. All pre-processing calculation groups defined on the service provider's rate will be used to manipulate this consumption. If you have pre-processing calculation group on your master SA's rate to apply a line loss or convert a cubic foot to a therm, you don't have to have these pre-processing calculation group on the sub SA's rate (because we copy the consumption from the master to the sub after pre-processing calculation group, if any exist, have been applied).

The following illustration should help:

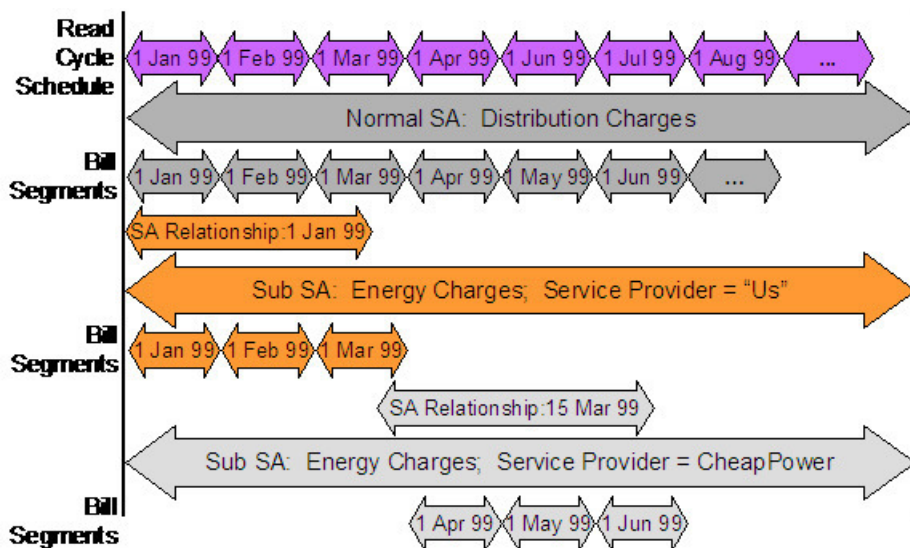

Be aware of the following:

- This example is from a distribution company's perspective.
- From 1 Jan 99 through 15 Mar 99, the distribution company distributes power AND supplies energy (i.e., the distribution company is the service provider of energy).

- On 15 Mar 99, CheapPower becomes the energy supplier. However, the next bill period ends on 30 Mar 99. This means that CheapPower will only start supplying energy on 1 Apr 99. See the following note for why the effective date of the supplier switch is not the true effective date from billing's perspective.

---

**NOTE:**

**Service Provider Changes Take Effect On The Next Bill.** If the service provider is changed within a customer's billing period, the system assumes that the service provider in effect at the START of the period is effective the entire billing period. This means that a change of service providers will only take effect on the bill whose start date follows the change date.

---

Please be aware of the following characteristics of Rate Ready bill segments:

- You cannot cancel a Rate Ready bill segment independently from the master bill segment. If you need to cancel / rebill the sub SA's bill segment, you must cancel / rebill the master SA's bill segment.
- You cannot delete a Rate Ready bill segment independently from the master bill segment. If you need to delete the sub SA's bill segment, you must delete the master SA's bill segment.
- Similarly, if you cancel / rebill the normal SA's bill segment, all Rate Ready bill segments will be cancelled / rebilled.

---

**NOTE:**

**Bottom line.** Creating, freezing, deleting, and canceling a "master" bill segment does the same with all Rate Ready bill segments. You cannot create, freeze, delete or cancel a Rate Ready bill segment independent of its master bill segment.

---

## The Bill Ready Calculation Method

If a customer uses a We Bill For Them - Bill Ready service provider, the service provider calculates their own charges and interfaces them to the system. We then present their charges on our bill; we don't actually calculate anything (sometimes this is referred to as "pass through" billing).

The sub SA linked to a We Bill For Them - Bill Ready must be a billable charge SA. Why? Because billable charge SAs exist to hold bill lines until such time as a bill is created for the customer's account. Refer to [Setting Up Billable Charge Templates](#) for more information.

Please be aware of the following characteristics of Bill Ready bill segments:

- Unlike Rate Ready bill segments, Bill Ready bill segments can span different time periods than the master SA. This is because you cannot predict when a service provider will interface their billable charges to you. In fact, a given bill could contain billable charges that span different periods and these charges could have been interfaced from historic and existing service providers.
- Unlike Rate Ready bill segments, Bill Ready bill segments can be created and deleted independently from the master bill segment.
- Unlike Rate Ready bill segments, Bill Ready bill segments can be cancelled independently from the master bill segment.

[Sending Consumption And Waiting For The Charges](#)

[Uploading Consumption \(Rather Than Uploading Calculated Charges\)](#)

[Calculating Taxes On Uploaded Charges](#)

### **Sending Consumption And Waiting For The Charges**

If your organization supports We Bill For Them - Bill Ready service providers AND you are the source of consumption used by these service provider to calculate their charges, you need to be aware of the following:

- We do NOT recommend sending raw meter reads to service providers. Rather, we recommend sending these service providers the same consumption that you use on your bill segments. Remember, the system maintains a snapshot of billed consumption on bill segments associated with service agreements that are linked to service points.
- But to implement our recommendation (of only interfacing billed consumption to service providers), we need to create a bill segment for the master SA and then wait until the service provider returns the billable charge before sending out the bill. The following points describe how this works:
  - Early in the bill cycle, the system creates a bill segment for the master SA (remember, the system maintains a snapshot of billed consumption on bill segments linked to service points). When the master bill segment is frozen, the system interfaces the snapshot consumption to all service providers associated with the master service agreement who need consumption (this is defined on the service provider). Refer to [We Can Send Billed Consumption To Any Service Provider](#) for more information about interfacing consumption to service providers.
  - The bill associated with the bill segment will not be completed. Why? Because the bill segments associated with the We Bill For Them - Bill Ready service providers will be in Error. This only happens if you use the [Billable Charge](#) bill segment creation algorithm (this algorithm is plugged in on the sub SA's SA type). On the algorithm, make sure to specify a value of Y for the parameter **Wait For The Last Day Of The Bill Cycle**. By doing this, a bill segment in the Error state will exist for the sub SA until the last night of the bill cycle's window.
  - On the last night of the bill cycle window, when the system attempts to create a bill segment for the billable charge SA associated with the We Bill For Them - Bill Ready, it will either find recently interfaced billable charges or it won't. If it finds unbilled, billable charges, a bill segment will be created for the sub SA and the billable charges will be swept onto it. If it doesn't find unbilled billable charges, the bill will be completed (i.e., sent out) without the service provider's charges.

---

**NOTE:**

**Bottom line.** If a customer's account uses We Bill For Them - Bill Ready service providers, the bill will not be completed (i.e., sent out) until the last night of the bill cycle (if you use the appropriate algorithm). Why? Because we wait until the last night of the bill cycle before trying to sweep on recently interfaced billable charges. If no billable charges have been interfaced from the service provider by the last night of the bill cycle, the bill will be sent out without the service provider's charges.

**Batch versus Online Bill Creation.** If you create a bill online, the system will NOT create an Error bill segment for the We Bill For Them - Bill Ready service provider. Why? Because if you want to create an online bill, either the service provider has interfaced their charges or they haven't. If they have, they should be swept on the bill (via the creation of a bill segment). If they haven't, it shouldn't prevent you from completing the bill.

---

[Top of the Page](#)

### **Uploading Consumption (Rather Than Uploading Calculated Charges)**

We understand this is confusing, but it is quite possible to set up the system so that the We Bill For Them - Bill Ready service provider passes in CONSUMPTION rather than the calculated bill lines. They would only do this if they are not able to calculate the charges in their system and have therefore provided you with their rates. To do this, you would set up everything as described above. In addition, when you upload the billable charges, you must specify the consumption to be rated in the billable charge's service quantity (SQ) collection.

[Top of the Page](#)

### **Calculating Taxes On Uploaded Charges**

It is possible to set up the system to calculate taxes for billable charges. You would do this if the service providers are passing through the charges and want you to calculate the taxes.

If you want taxes calculated on top of billable charges:

- Create a service quantity (SQ) on the billable charge that contains the total monetary amount that taxes will be calculated on. Note, you would not have to do this if you have a pre-processing calculation group in your rate that calculates the total monetary amount to which taxes should be applied.

- Specify a rate on the billable charge service agreement. This rate will contain calculation rules that calculate taxes. Note, the calculation rules will be simple SQ calculation rules that apply a percentage to the value of the SQ that represents the monetary amount on which taxes should be calculated.

When the system creates the bill segment for the billable charge, it will call the rate and the rate will calculate the taxes and add additional lines (actually, bill calculation headers) to the bill segment.

## Pay At Bill Time vs. Pay At Pay Time

If you provide billing services for another service provider (i.e., the service provider has a billing relationship of We Bill For Them ), you will owe them money because you will be receiving money from their customers for their service. You have two options in respect of when the system increases the amount you owe the service provider:

- You can tell the system to increase how much you owe the service provider when you freeze the customer's bill segment. Some people refer to this method as "purchasing the receivable from the service provider". We call this the **Pay At Bill Time** method.
- You can tell the system to increase how much you owe the service provider only when you are paid for by the customer. We call this the **Pay At Pay Time** method.

The method used for a service provider is defined on the service provider's record.

---

**FASTPATH:**

Refer to [When We Bill For Them, We Owe Them Money](#) for more information.

---

## Paying The Service Provider - Technical Implementation

---

**WARNING:**

This section describes, technically, how we increase the amount we owe a We Bill For Them service provider. If you aren't technically inclined, skip this section.

---

The following illustration shows the logical steps involved with increasing how much we owe a We Bill For Them service provider.

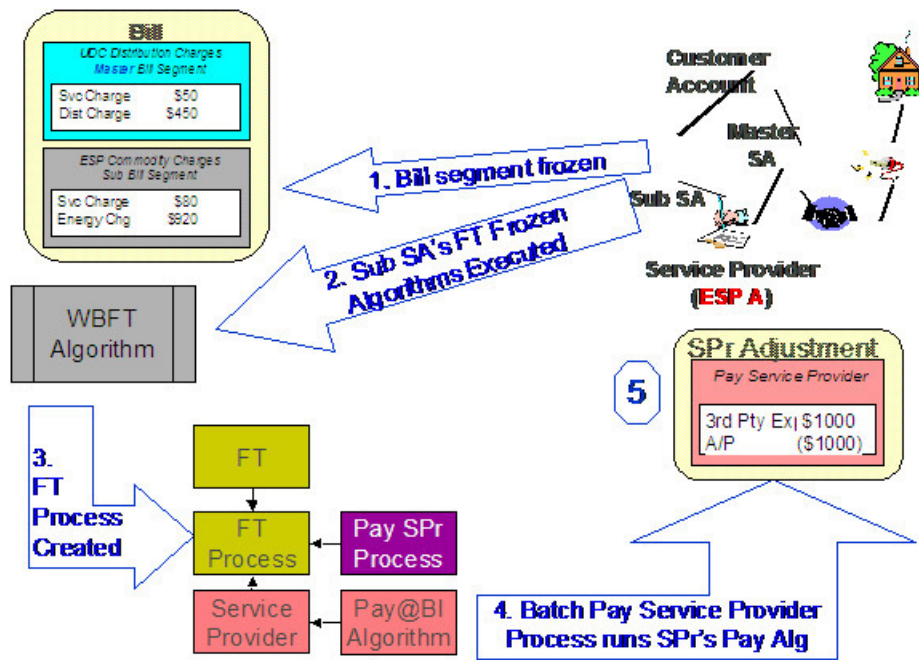

The following points explain the steps:

- When a financial transaction (FT) is frozen, the system executes the FT Freeze algorithms defined on the SA(s) SA type.
- If you've set up the system properly (i.e., you've put the appropriate FT Freeze algorithm on the sub SA's SA type), one of these algorithms will determine if there is a WBFT service provider associated with the sub SA. If so, it will insert a row on the FT Process table.
- Rows on the FT process table are used as "triggers" for batch processes. In this case, the batch process that is triggered is the one that looks at new FT's and determines if a related "payable" adjustment should be created for the We Bill For Them service provider. This batch process uses the service provider's Payment Relationship and Pay Service Provider algorithm to determine when and how to create these "payable" adjustments.

## Service Providers Have Service Agreements Too

Most service providers need service agreements as explained in the following topics.

### When We Bill For Them, We Owe Them Money

When you bill on behalf of a service provider (i.e., the service provider has a billing relationship of We Bill For Them ), you will eventually owe them money (because the customer pays you for the service provider's service). You have two options in respect of when the system increases the amount you owe the service provider:

- You can tell the system to increase how much you owe the service provider when you create the customer's bill. Some people refer to this method as "purchasing the receivable from the service provider".
- You can tell the system to increase how much you owe the service provider only when you are paid for by the customer.

The system keeps track of how much you owe a service provider on a service agreement linked to the service provider's account. The system creates adjustments against this service agreement to increase how much you owe them.

If you "purchase the receivable" (i.e., you owe them when you bill the customer), an adjustment is created when the customer is billed. If you owe them only when you are paid by the customer, an adjustment is created when the customer

pays. The following example illustrates an adjustment being created when the bill is frozen (illustrating the "purchase the receivable" scenario):

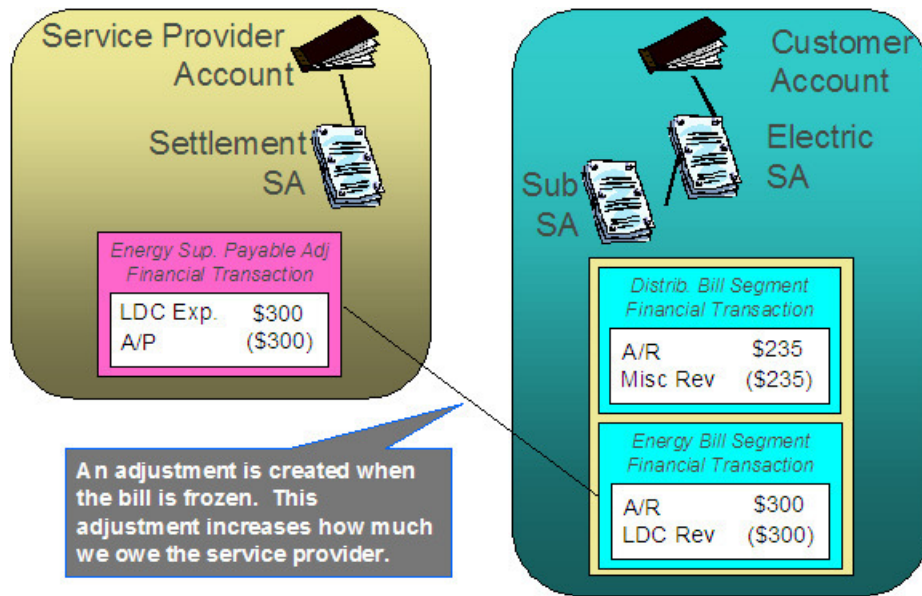

If you only pay the service provider when you are paid, the example would look as follows:

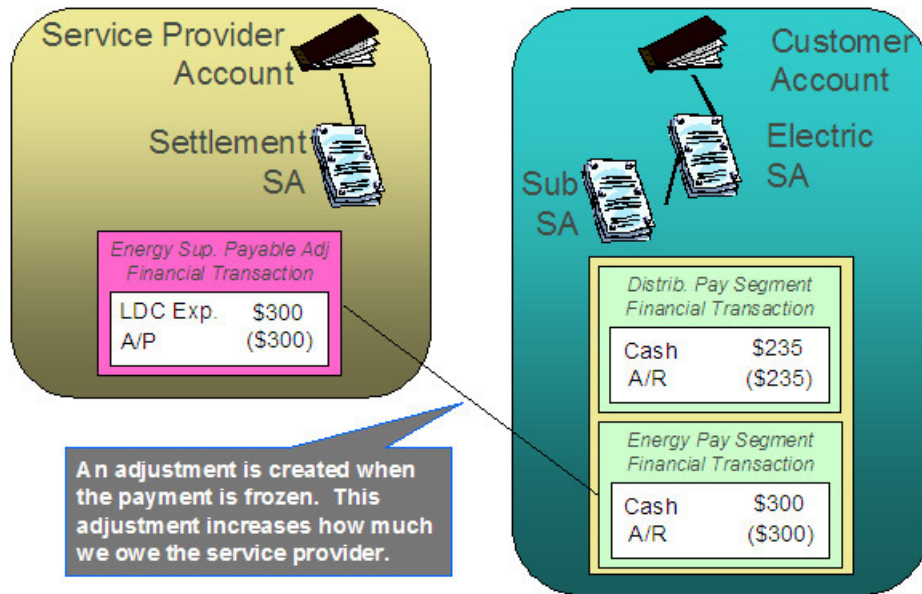

## Adjustments and We Bill For Them Service Providers

**FASTPATH:**

It's important that you are comfortable with the information described under [When We Bill For Them, We Owe Them Money](#) before reading this section.

Adjustments associated with We Bill For Them sub service agreements are tricky. The following points describe how the system "pays" the related service provider when adjustments are issued against the customer's sub service agreement:



- For Pay At Bill Time service providers, most adjustments are treated just like bill segments, i.e., when the adjustment's FT is frozen, a payable adjustment is created for the respective service provider. The reason "most" is underlined in the previous sentence is because A/P adjustments (i.e., adjustments used to interface check requests to your A/P system) are excluded. Why? Because A/P adjustments are used to refund overpayments to the customer. Overpayments are purely between the customer and your company (you never transferred the overpayment to the service provider because it's associated with a Pay At Bill Time service provider).
- For Pay At Pay Time service providers, A/P adjustments are treated just like payment segments, i.e., when the adjustment's FT is frozen, a payable adjustment is created for the respective service provider. All other types of adjustments are ignored. Why? Because A/P adjustments are used to refund overpayments to the customer. Think of it like this - when the customer originally overpaid, you transferred this overpayment to the Pay At Pay Time service provider; therefore, when you refund the overpayment, you get to take the money back from the service provider.

## When They Bill For Us, They Owe Us Money

When a service provider bills on behalf of your organization, they will eventually owe you money (because the customer pays them for your service).

The system keeps track of how much a service provider owes you on a service agreement linked to the service provider's account. The question is, How does the system determine how much you are owed when you don't produce a bill? Well, you do produce a bill, it just doesn't get sent to the customer. We understand this is a little confusing, but think about it like this:

- The service provider is presenting your charges on their bill.
- You still have to calculate how much the customer owes your organization otherwise you'll never know how much you are owed by the service provider.

As illustrated below, when a bill is completed, the system determines if there are bill segments and/or adjustments associated with service agreements with a service provider who "bills for us". If it finds these, it transfers the receivable from the customer's service agreement to the service provider's service agreement. If all financial transactions have been transferred to the service provider, no bill is produced for the customer.

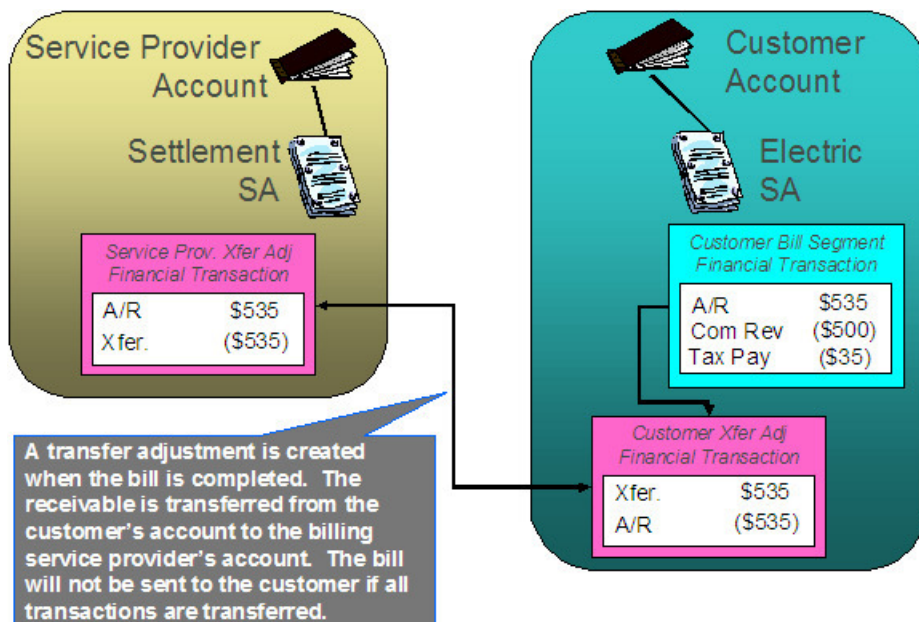

**NOTE:**

**Bottom line.** We always generate a bill for "us", even though we don't send it to the customer.

## They Bill For Us

If a service provider provides billing services for you, then you have a They Bill For Us billing relationship with the service provider. The topics in this section provide information about this type of billing relationship.

### The Customer Still Needs A Service Agreement

If a service provider bills for you, you still need a service agreement for the customer. Why? Because:

- As explained under [Service Providers Are Linked To Service Agreements](#), service providers are defined in respect of a customer's service agreement (therefore the customer must have a service agreement).
- As explained under [When They Bill For Us, They Owe Us Money](#), you still have to calculate bills for the customer.

---

**NOTE:**

**A customer's bill history still exists.** Be aware that even when a service provider bills for us, you will still be able to see the customer's billing history. It's just that the customer won't owe you anything because the receivable balance will be transferred to the service provider's account.

---

### They Bill For Us - Bill Ready

At bill completion time, the system determines if there are bill segments and/or adjustments associated with service agreements with a service provider who "bills for us". If it finds these,

- It transfers the receivable from the customer's service agreement to the service provider's service agreement. If all financial transactions have been transferred to the service provider, no bill is produced for the customer.
- Note that payments and A/P adjustments are not transferred. Why? Because payments and A/P adjustments are purely between the customer and your company.
- Each bill segment and adjustment is marked to be interfaced to the service provider (via a separate background process).

### They Bill For Us - Rate Ready

The They Bill For Us - Rate Ready option is not a recommended option. Why? Because you really have to compute how much the customer owes as explained above. If you go to the trouble of figuring out how much the customer owes, then it makes sense to interface this to the billing service provider.

The only difference between this option and They Bill For Us - Bill Ready is that the system will not interface the bill segments and adjustments to the billing service provider.

### A/R Transfer - Technical Implementation

---

**WARNING:**

This section describes, technically, how a customer's A/R balance is transferred to a They Bill For Us service provider. If you aren't technically inclined, skip this section.

---



The following illustration shows the logical steps involved with the transference of a customer's A/R balance to a They Bill For Us service provider.

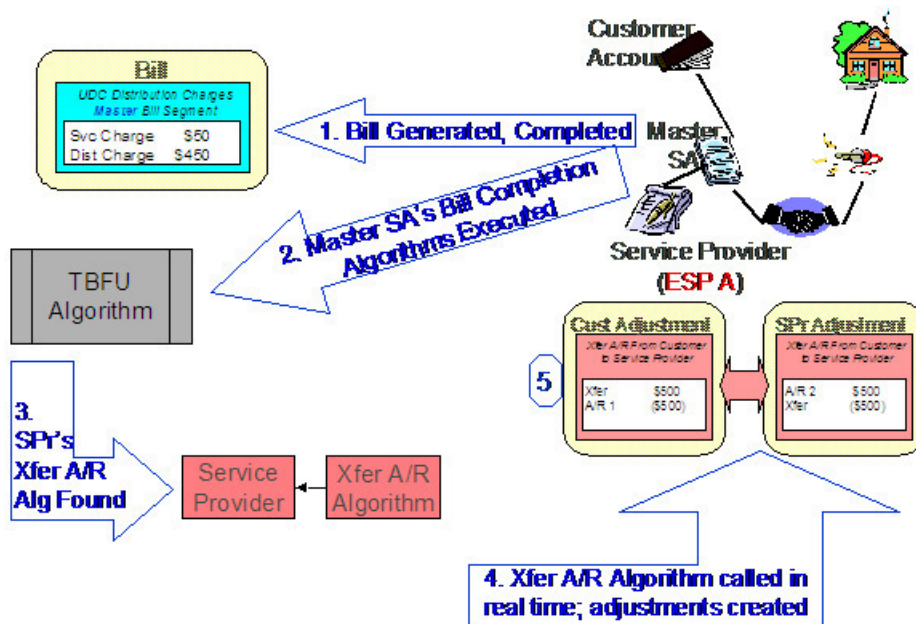

The following points explain the steps:

- When a bill is completed, the system executes the bill completion algorithms defined on the bill's master SA(s) SA types.
- If you've set up the system properly (i.e., you've put the appropriate Bill Completion algorithm on the master SA's SA type), one of these algorithms will determine if there is a They Bill For Us service provider associated with each master SA on the bill. If so, it will execute the Transfer A/R algorithm defined on the service provider's record. This algorithm causes a transfer adjustment to be created (transferring the financial transaction's affect on the customer's balance from the customer to the service provider).

**NOTE:**

If there are multiple master SAs on a bill, the financial details associated with each respective master SA could be transferred to different service providers (e.g., one service provider could receive the financial details for gas and another for electricity). Refer to [Different Service Providers Can Bill Different Services](#) for more information.

## Routing Billable Charges To Service Providers - Technical Implementation

**WARNING:**

This section describes, technically, how we send billable charges to service providers. If you aren't technically inclined, skip this section.

The following illustration shows the logical steps involved with sending billable charges to service providers.

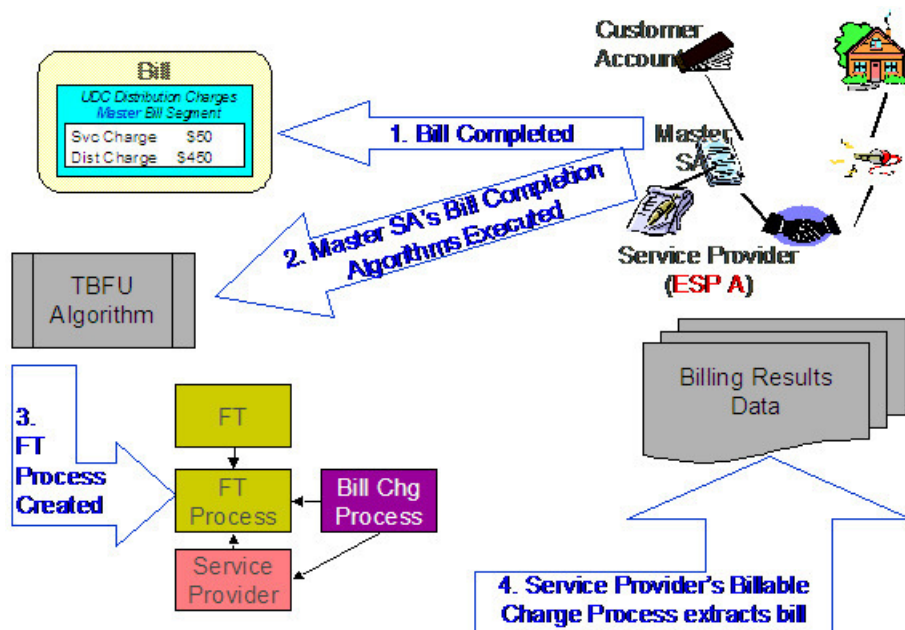

The following points explain the steps:

- When a bill is completed, the system executes the bill completion algorithms defined on the bill's master SA(s) SA types.
- If you've set up the system properly (i.e., you've put the appropriate Bill Completion algorithm on the master SA's SA type), one of these algorithms will determine if there is a They Bill For Us service provider associated with each master SA on the bill. If so, it will insert a row on the FT Process table.
- Rows on the FT process table are used as "triggers" for batch processes. In this case, the batch process that is triggered is the one that downloads billable charges to the service provider. The ID of the batch process that is referenced on the trigger comes from the Service Provider's Billable Charge Download Process.

**NOTE:**

If there are multiple master SAs on a bill, the financial details associated with each respective master SA could be routed to different service providers (e.g., one service provider could receive the financial details for gas and another for electricity). Refer to [Different Service Providers Can Bill Different Services](#) for more information.

## Bill Routings Are Changed

If all of an account's "master" SAs have a SA relationship with a service provider who bills for us (i.e., the service provider's billing relationship is They Bill For Us ), then we have nothing to send to the customer. The system still creates bill routings, but with a couple of differences:

- The Batch Process Id and Run Number are reset.
- The Customer's Name is prefixed with the text from a bill message code 6, 10103. This message code's text is \*\*\* Bill not sent.

This way, the operators can easily see that that the bill was not routed and why.

**FASTPATH:**

Refer to [Different Service Providers Can Bill Different Services](#) for information about how the various services under an account could be billed by different service providers.

## Combinations Of Service Provider Billing Methods

Consider the following situation:

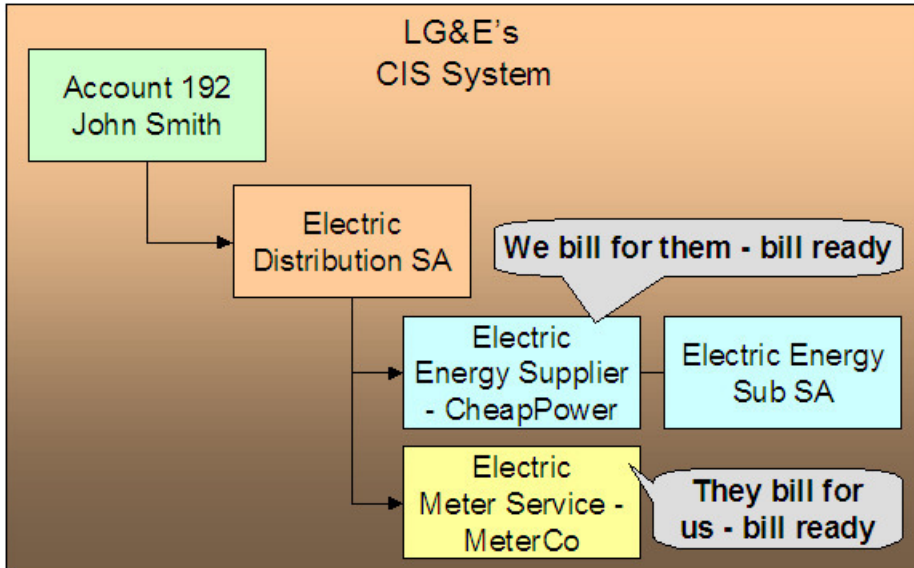

In the above example, we are billing for the energy service provider and the meter service provider is billing for us. This means that we will calculate the charges for ourselves, interface charges from CheapPower, and then interface our charges and CheapPower's charges to MeterCo. MeterCo will then produce a bill for the customer that contains our distribution charges, CheapPower's energy charges, and MeterCo's service charges. To help solidify this point, let's look at how this customer would look in MeterCo's CIS system.

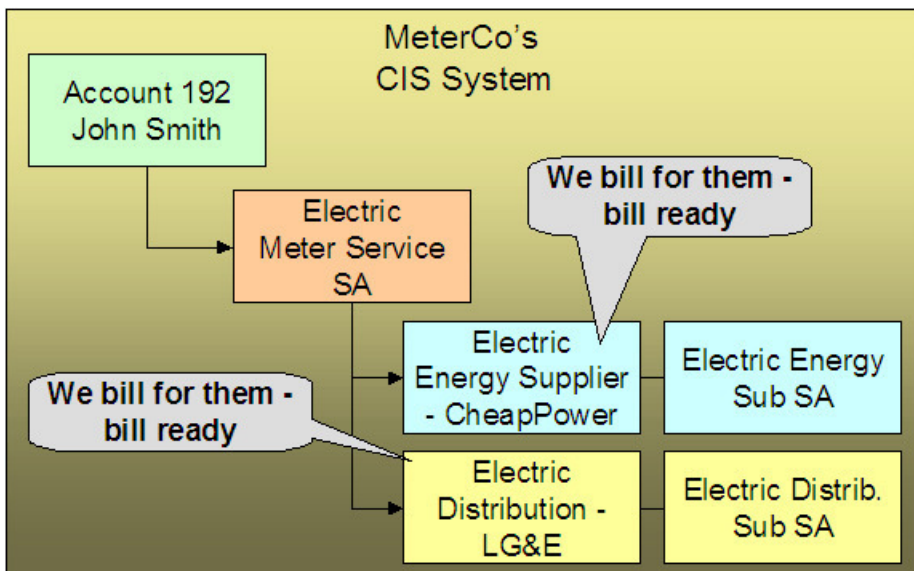

There are some restrictions in respect of permissible combinations of service providers that may supply service to a customer as described in the following points:

- If the system encounters a customer with a We Bill For Them (WBFT) - Bill Ready service provider and another service provider that is They Bill For Us (TBFU) - Rate Ready, a billing error will be produced. Why? Because TBFU - Rate Ready means they have everything they need to calculate our bills and therefore we do not interface bill lines to them.

If we don't interface our bill lines to them, then we can't interface the charges that were interfaced from the WBFT - Bill Ready service provider. You may wonder why we don't prohibit WBFT - Rate Ready and TBFU - Rate Ready, because it's conceivable for the TBFU service provider to have our rate and the WBFT service provider's rate.

- If the system encounters a WBFT - Pay At Pay Time service provider and another service provider that is TBFU, a billing error will be produced. Why? Because when the system detects a TBFU service provider, it transfers the receivable from the customer to the service provider (and therefore the customer's account will never be paid).

## Different Service Providers Can Bill Different Services

Be aware that the system determines billing relationships at the service agreement level, NOT at the account level. To make the point, check out the following customer in a distribution company's system:

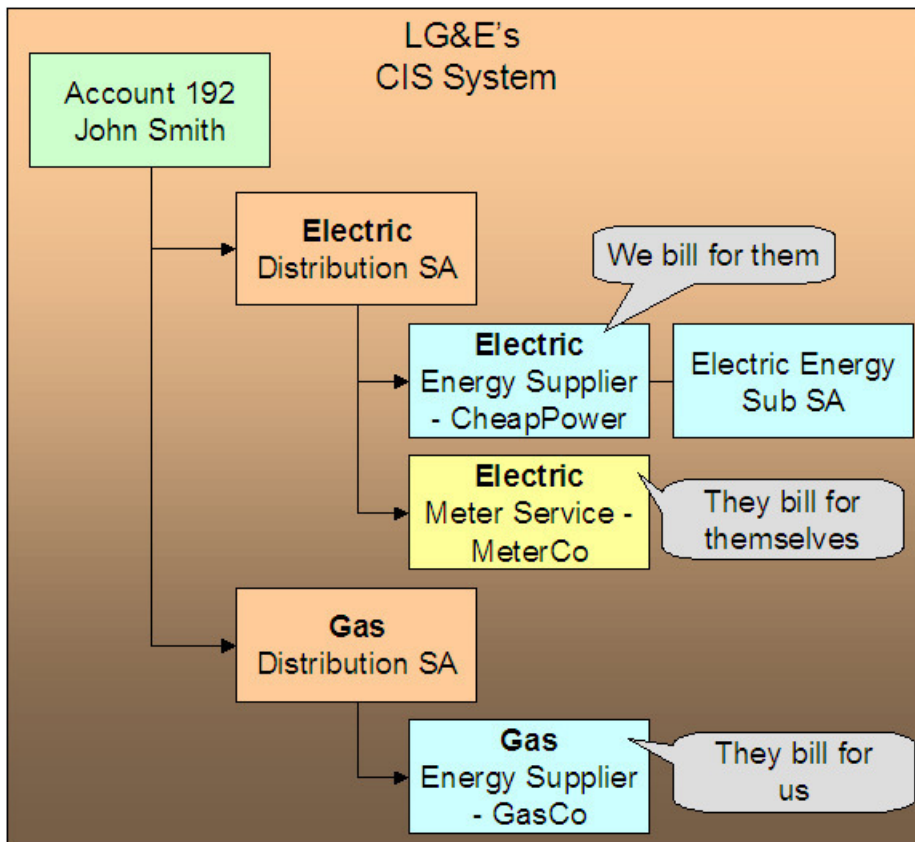

Be aware of the following in respect of the above illustration:

- The distribution company (LG&E) distributes both electricity and gas.
- The customer has a choice of energy service providers for both gas and electricity.
- This customer - John Smith - purchases his electricity from CheapPower and his gas from GasCo.
- LG&E provides billing services for CheapPower.
- GasCo provides billing service for LG&E.

In this situation, LG&E will send bills to the customer that contain both electric distribution and energy charges (but no gas distribution charges). GasCo will also send bills to the customer; these will contain both LG&E's gas distribution charges as well as their own energy charges.

## If You Deal With TBFU Service Providers, You Cannot Reopen Bills

---

### **FASTPATH:**

Refer to [Bill Lifecycle](#) for information about reopening previously completed bills.

---

If your organization deals with They Bill For Us (TBFU) service providers, a great deal happens when a bill is completed (e.g., the receivable is transferred from the customer to the service provider, we may mark the bill segments and adjustments for routing to the service provider, etc.). These things cannot be undone and therefore the system will not let you reopen bills when these things have occurred.

---

### **NOTE:**

**Technical rule.** The specific rule that prevents the reopening of bills is as follows: if a bill contains a service agreement whose SA type has one or more bill completion algorithms, the system will not allow the bill to be reopened. Refer to [SA Type - Algorithms](#) for more information about bill completion algorithms.

---

## Consumption Relationships

When you set up a service provider, you must define your organization's consumption relationship with the service provider - a service provider may send the customers' consumption to you, you may send consumption to them, or you may have no consumption relationship with a given service provider.

The topics in this section provide a wealth of information about the various consumption relationships and the ramifications of each.

## Only The Master SA Is Linked To Service Points

The following diagram makes the point that service points cannot be linked to sub SAs (i.e., service agreements that exist to hold charges associated with We Bill For Them service providers). This is because all service points associated with our "master" SA are implicitly linked to all sub SAs.

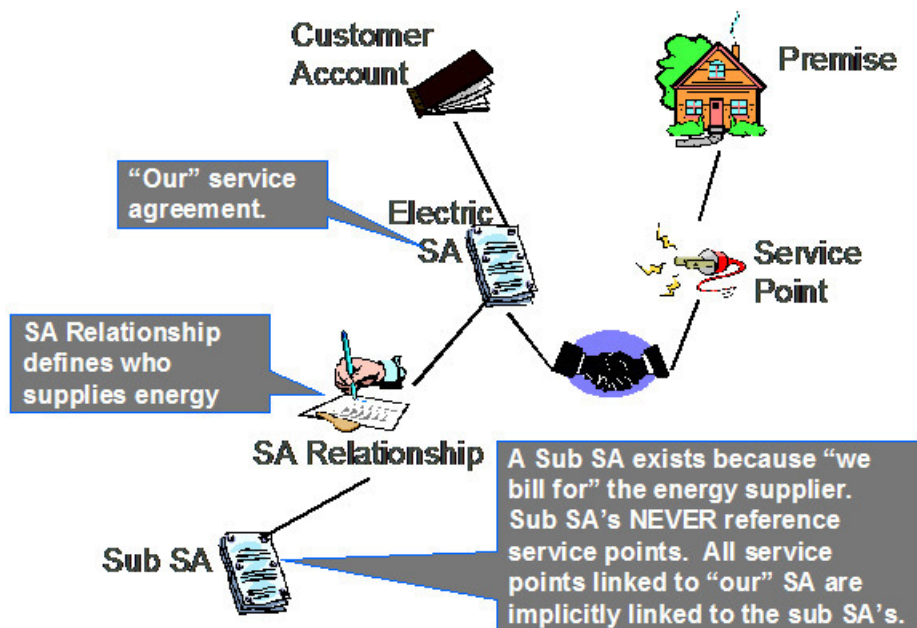

It's important to understand why the system does not allow sub SAs to reference service points:

- The consumption associated with all service providers should be the same, otherwise the customer will receive inconsistent bills from different service providers.
- The easiest way to ensure consumption is the same for all service providers is to make sure that they all have the same service points (which they must if sub SAs "inherit" their service points from their master).

## We Can Send Billed Consumption To Any Service Provider

You can send consumption to any service provider. It doesn't matter what their billing relationship is. Information on the service provider object tells the system if AND how to send consumption to a service provider.

Rather than send raw reads to service providers, we download consumption that has been calculated and snapshot onto the "master" bill segment. We send this billed consumption because:

- It is clean and validated
- Register indexes have been subtracted
- Multiple registers have been summed

---

### NOTE:

We only send consumption after a bill segment is Frozen. If your organization supports We Bill For Them - Bill Ready service providers AND you are the source of consumption used by these service providers to calculate their charges, please refer to [The Bill Ready Calculation Method](#) for an explanation of how the system waits a given amount of time for the recipient of the consumption to interface their charges back to the system before sending the bill to the customer. In other words, the bill sent to the customer should contain the bill segment that triggered the consumption download as well as bill segments containing uploaded billable charges.

---

## Routing Consumption To Service Providers - Technical Implementation

---

### WARNING:



This section describes, technically, how we send consumption to service providers. If you aren't technically inclined, skip this section.

The following illustration shows the logical steps involved with sending consumption to service providers.

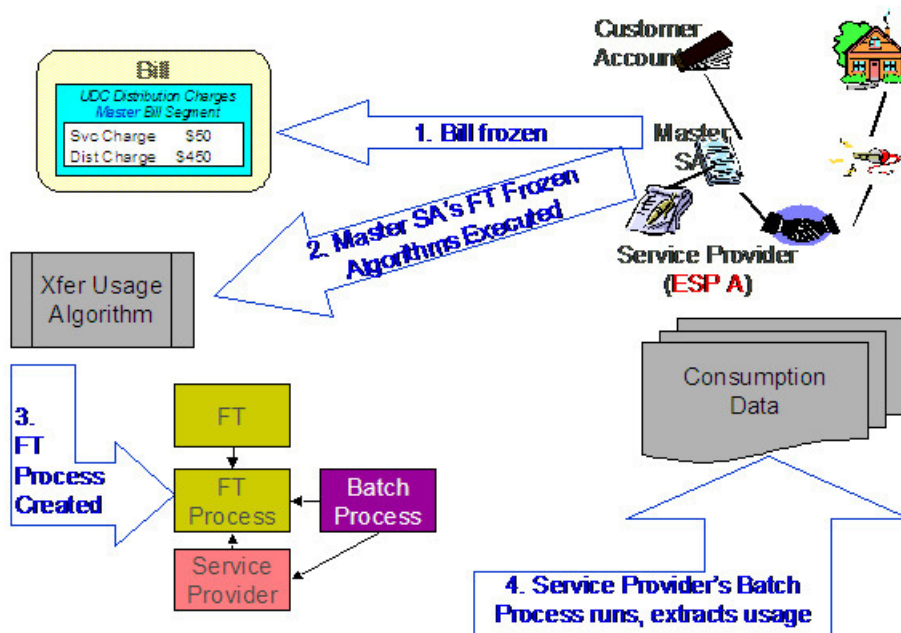

The following points explain the steps:

- When a financial transaction (FT) is frozen, the system executes the FT Freeze algorithms defined on the SA(s) SA type.
- If you've set up the system properly (i.e., you've put the appropriate FT Freeze algorithm on the master SA's SA type), one of these algorithms will determine if there are service providers associated with the master SA who need consumption. If so, it will insert a row on the FT Process table.
- Rows on the FT process table are used as "triggers" for batch processes. In this case, the batch process that is triggered is the one that downloads billable consumption to the service provider. If multiple service providers need consumption, multiple rows will be inserted. The ID of the batch process that is referenced on the trigger comes from the Service Provider's Consumption Download Process.

## We Can Receive Consumption From Service Providers

We can receive consumption from any source. The system can receive consumption from service providers. Each customer must have:

- A premise
- A service point
- A device with measuring components sufficient to hold the interfaced consumption

### NOTE:

**You don't have to perfectly model the service points and meters.** If you are not the distribution company, you may be worried about how to keep devices and service point information up-to-date. Be aware that you don't have to model the SPs and devices perfectly. Why? Because you just need to set up enough information so that consumption can be received accurately.

## MDMAs And Service Cycles

---

**WARNING:**

This section uses terminology and concepts described in [The Cyclical Meter Read Process](#).

---

A Meter Data Management Agency (MDMA) is a service provider who reads meters. In some locales, a meter can be read by a variety of MDMAs, in other locales there is no MDMA as the meter is read by the distribution company. If your organization has MDMAs, then you need to be aware of the following:

- MDMAs must be linked to service agreements as a service provider. Like all service providers, they can change over time.
- When an MDMA is reading a service agreement's meters, the MDMA may override the customer's service cycle (and schedule) with their own cycle. If they do this, the customer's service cycle in the MDMA's system is defined on the service agreement's SA relationship information for the MDMA. Note: whether or not a service provider can override a service cycle is controlled by a switch on the service provider's record. Refer to [Service Provider - Main](#) for more information.
- A service provider's service cycle schedules are maintained using the system's normal service cycle schedule. The ID of the service provider associated with each schedule is defined on the service cycle; in other words, if a service provider reads meters and they can override the customer's service cycle, the service provider's service cycles must be defined in the system. Refer to [Designing Service Cycles, Routes, And Schedules](#) for more information.
- At billing time, the system determines if a service agreement is covered by an MDMA. If so, it uses the service cycle defined on the service agreement's MDMA SA relationship record.
- If your organization ever reads the customers' meters, your regular read cycle should be maintained on your service points. You can think of the service cycle that is defined on a service agreement's MDMA SA relationship record as an override of your service points normal service cycle.
- If the meter read download process detects that a service point is linked to a service agreement with an active MDMA, it still creates a meter read download staging record; however, it marks it as Do Not Need To Read. This means that when a service point is no longer read by an MDMA, the meter read will be downloaded normally.
- Refer to [We Can Receive Consumption From Service Providers](#) for a description of how a service provider interfaces consumption into the system.

## Deposits Issues

---

**WARNING:**

This section uses terminology and concepts described in [The Big Picture Of Deposits](#).

---

Deposits should be held using normal deposit service agreements (SAs). You should NOT use the [Sub Service Agreements](#) (sub SA) functionality to hold or bill for deposits because deposit service agreements do not have the same state transition as do master SAs (e.g., you can activate or stop a deposit independent from its master).

However sub SAs can be covered by a deposit. If so, their SA type must reference a deposit class. To make the point, let's examine a few scenarios:

- Assume you have a sub SA for your own charges (this can happen when we use sub SAs to unbundle charges from the Master SA). In this case, it is likely that the sub SA and master SA will be in the same deposit class. This means that a single deposit SA would cover both the master and the sub SA.



- Assume They Bill For Us (Bill or Rate Ready). In this situation, we still have a master SA for our charges and we transfer the charges to the service provider who does the billing. In this case, it is likely that we would be holding the deposit for the service provider, not on the end-use customer. If we are in a situation where 1) we cannot hold a deposit against the service provider, and/or 2) we are not assured of the service provider paying us when the customer doesn't pay them, then we might want to put the master SA in a deposit class and hold a deposit against the customer's account using a normal deposit SA. We would not expect the service provider to bill the customer for the deposit, so we don't need a sub SA. We bill the customer directly for the deposit using our normal deposit SA.
- Assume We Bill For Them (Bill or Rate Ready). In this situation, we could hold a normal deposit SA for the customer's master SA. For sub SAs, we have two scenarios:
  - **We pay at billing time.** Since we purchase the receivable, we would want to increase our normal deposit to cover the Sub SA. To do this, the sub SA's SA type's deposit class should be the same as our master SA's deposit class.
  - **We pay at payment time.** It seems unlikely that we would want to hold a deposit on behalf of a service provider when we don't purchase the receivable. However, it is possible to do so by putting the sub SA into its own deposit class. If you did this, the system will require a separate deposit SA for the service provider's deposit. The system would calculate and refund such deposits using the algorithms defined on the new deposit SA's SA type's deposit class. It's important to be aware that the deposit is not held with respect to the specific service provider. Rather, it is just held in the system as separate deposit that could be used for any service agreement that belongs to its deposit class.

## Credit and Collection Issues

---

### **WARNING:**

This section uses terminology and concepts described in [The Big Picture Of Credit & Collections \(C&C\)](#).

---

C&C is only tricky if you deal with We Bill For Them service providers. We'll run through the service provider billing relationships to explain why:

- If we have a Dual relationship with a service provider, we don't have their debt, so we only have a responsibility to tell them when we cut a customer (via a Notification). We don't have to worry about collecting their debt.
- If we have a They Bill For Us relationship with a service provider, there is no debt on the customer's SA because it gets transferred to the service provider (and the service provider's SA will fall into arrears if they don't pay us).
- If we have a We Bill For Them or It's Us relationship with a service provider, the customer's debt associated with the service provider's service is maintained on a sub SA (i.e., it is segregated from our debt). This segregation of debt is both a powerful feature and a cause of administrative difficulties. The topics in this section provide more information about this issues.

## Debt Class Recommendations

A service agreement's debt class is an important element in determining how a customer's debt is collected. In general, we recommend the following:

- If the service provider has a billing relationship of It's Us, we recommend the sub SAs belong to the same debt class as the "master". Why? Because both SAs' overdue debt should probably be grouped together under a single collection process.
- If you buy the receivable from the service provider (i.e., the service provider has a payment relationship of Pay at Billing Time ), we recommend the sub SAs belong to the same debt class as the "master". Why? Because both SAs' overdue debt should probably be grouped together under a single collection process.

- If you don't buy the receivable from the service provider (i.e., the service provider has a payment relationship of Pay at Pay Time ), you may want to use a different debt class on the sub SA. Why? Because you may collect the service provider's debt differently.

**NOTE:**

**Bottom line.** If both the "master" and the sub SAs fall into arrears, you will have 1 or 2 collection processes, it all depends on the debt class assigned to each SA type.

**FASTPATH:**

Refer to [Automating Your C&C Activities](#) for information describing how debt class plays a part in this processing.

## Severing Service

Sub SAs and severance is tricky. Why?

- Because it's possible for the master SA to be in arrears when the sub SA isn't (for all the standard reasons - directed payments, cancel / rebills, etc.).
- Because it's possible for the sub SA to be on one collection process and the master to be on another (due to different debt classes or different time lines).

Both of these situations could result in severance starting for only one of the service agreements in the master / sub relationship. However, **YOU CAN'T CUT SERVICE FOR ONE WITHOUT CUTTING THE OTHER** because there is only one service point.

Before we describe how to deal with this conundrum, we'd like to remind you that the system starts a unique severance process for each SA (sub or normal) to be severed. It only creates a severance process for those service agreements linked to a collection process when the collection process' Start Severance event is activated. The type of severance process that is created is controlled by each service agreement's SA Type's severance criteria. Please keep in mind the following when designing these severance processes:

- **Only The "Master" Service Agreement Is Linked To Service Points.** This means only master SAs should have a "cut for non payment" severance event. Note: typically, such a severance process will expire the "master SA" several days after the cut event if funds are NOT received.
- As described under [Sub SA State Transition](#), a sub SA becomes Pending Stop (and eventually Stopped ) when its "master" is stopped. This means the sub SAs will be finalized when the master is finalized.
- If you start severance on a sub SA when the master isn't being severed, you have a problem because you can't cut the sub SA independent from the master SA.

We'll use an example to illustrate how you should design your severance processes to deal with the above challenge. Assume you have a master and a sub SA where both are being managed under the same collection process. Also assume that the Start Severance event kicks off on 18-Dec-1999. In this situation, we'd recommend the following severance processes to be kicked off.

Master SA Severance Process		
Trigger Dt.	Event Type	Status
18-Dec-99	Set door hanger	Pending
Pending	Cut for non pay	Pending
Pending	Expire SA	Pending

Sub SA Severance Process		
Trigger Dt.	Event Type	Status
3-Jan-00	Create To Do Entry	Pending

Notice that the sub SA's severance process contains a single event that generates a To Do Entry on a date in the future of the Expire SA event on the Master SA. This entry should be something like "sub being severed independent of its master". This event will only be triggered if the master SA is paid off and the sub SA isn't. Why? Because if the master SA's Expire SA event is executed, the Sub SA will be Stopped and stopping a SA cancels outstanding severance processes. If the sub gets paid, the system will cancel the sub's severance process.

Let's change the example and assume that the master starts severance and the sub doesn't. In this situation, the master SA will eventually hit the Expire SA event and the sub SA will also stop. There's no alternative.

And let's change the example again and assume the sub starts severance and the master doesn't. In this situation, the To Do Entry will only be created X days after the start of severance. If you can't stand this date being X days in the future of the creation of the severance process, create an "Severance Criteria Algorithm" that checks if the master is not being severed or collected and generates a different severance process (with a different start date). Refer to [Designing Your Severance Procedures](#) for more information about Severance Criteria Algorithms.

## An Object-Oriented Perspective Of Service Providers

**WARNING:**

Skip this section if you are not technically inclined.

The following object diagram illustrates in a concise format the various types of service providers and the plug in algorithms and processes available for each.

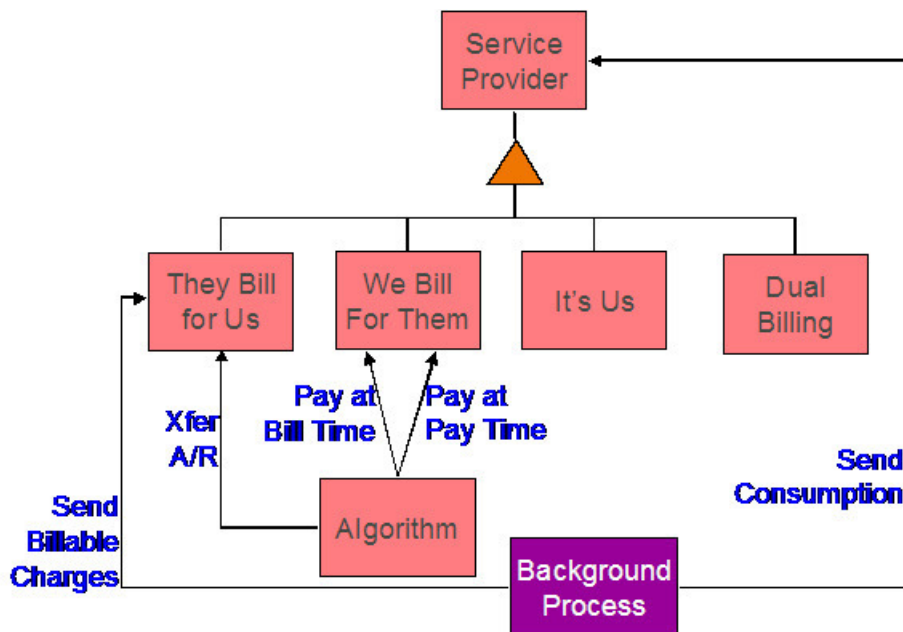

## How Do You Communicate With Service Providers?

You communicate with service providers (and they communicate with you) using the following mechanisms:

- You can use traditional interface techniques. For example, if you send consumption to service providers every month (so they can compute their charges), you could use the Consumption Download interface.

- You can use "notifications" to communicate with service providers. Notifications are electronic transactions that service providers exchange to communicate information about a customer. For example, you could use a notification to send a message to an energy supplier when a customer stops service. Note: the term "Direct Access Service Request" (DASR) is synonymous with Notification.

The difference between notifications and traditional interfaces is subtle. Think of notifications as a generic interface that can be used to communicate many different things (e.g., you can use notifications to advise stops, meter exchanges, supplier switches). Traditional interfaces communicate only one thing (and you need one traditional interface for each "thing"). For example, one interface is devoted to downloading consumption, another is responsible for uploading pass through charges, etc.

## Off Cycle Switch

If the customer care and billing application integrates with meter data management (mdm) system, it may be set up to generate sub-bill segments for each and every service provider having **We Bill for Them - Rate Ready** or **It's Us** billing relationship, that is effective in the billing period. This requires that the meter data management system can calculate the consumption for each effective SA relationship period.

If the switch is from or to a service provider having **They Bill for Us** billing relationship, separate bills have to be generated manually for each relationship effective in the billing period. This restriction is due to requirement for CCB application to generate a bill for a **They Bill for Us** relationship, so that the customer's charges are calculated and eventually transferred to the service provider. The generated bill for **They Bill for Us** billing relationship is not sent to the customer.

## Billing Master Configuration

To enable Off Cycle Switch, navigate to **Admin > General > Master Configuration** and add a new entry for Billing Master Configuration.

Specify the values for **Off Cycle Switch Option**, **Implementation Date** and **Off Cycle Switch Option for Old Bill**. Refer to the embedded help on billing master configuration portal for details.

## Rate Schedule

Rate schedules assigned to the sub-SA of service provider, having **We Bill for Them - Rate Ready** or **It's Us** billing relationship, must be configured with an SQ rule (for component-based engine) or a pre-processing calculation rule (for rule-based engine) that will obtain the sub-usage's consumption and load it into the bill segment SQ collection during rate application.

For more information, refer to the base package algorithm types provided for this purpose: [US](#) (component based engine) and [C1-ACRSUBUSG](#) (rule based engine).

## Sub-SA Type

When implementing this feature, sub-SA types of service provider having **We Bill for Them - Rate Ready** or **It's Us** billing relationship must be configured as non-bill determinant.

## Usage Request

Usage request is sent to the Oracle Utilities Meter Data Management (MDM) system, to obtain the calculated consumption for the billing period - this is used to calculate master bill segment's charges.

In addition, sub-usage request is sent to the mdm system, for each relationship that is effective during the billing period. Calculated consumption on these sub-usage requests is used to calculate sub-bill segment charges.

## Sending Consumption to Service Providers

Calculated consumption on these sub-usage requests also serves as the source for consumption download process if consumption is required to be sent to the service provider. A base package algorithm type - [C1-STGCNSMP](#), stages the download by creating an entry in the general process table, capturing the sub-usage id, batch control for consumption download and the batch number.

---

**NOTE:** It is implementation responsibility to build the consumption download batch process that will extract the consumption for sub-usage request as required.

---

## Designing Your SA Relationship Types and Service Providers

As explain in [A Service Agreement Can Have Many Types Of Relationships](#), SA relationship types and service providers are only required when you subcategorize your service agreements.

The topics in this section describe how to design your SA relationship types.

### Designing SA Relationship Types

The easiest way to design SA relationship types is to start with the matrix of SA types designed in [SA Types And The Financial Design](#). For each SA type in the matrix, determine if either of the following questions is true:

- Can companies other than your own provide some subcategory of the service (and do you have some type of interaction with these companies)? For example, this would be true if you are an energy supply company because a different company is responsible for distributing the power to the customer (and you probably exchange consumption and financial transactions with this company).
- Does your organization use different rates for subcategories of the service? For example, this would be true if you use separate rates for water and wastewater service (even though both are based on the customer's water consumption).

If either of the above is true, you will need a SA relationship type for each subcategory of service.

We'll use an example to help make the point. Using the SA types we designed earlier (see [SA Types And The Financial Design](#)), we'll assume the following:

- We are designing the system for an electric, gas, water, waste water, and cable utility.
- Residential electric customers have a choice of energy supplier.
- Commercial and industrial electric customers can choose an energy supplier and a meter service provider.
- Commercial and industrial gas customers have a choice of energy supplier.

---

**NOTE:**

We are not showing most of the SA types that we designed earlier because they do not have subcategories of service.

---

CIS BU/ SA Type	SA Relationship Type
G/COM	Energy supply
G/IND	Energy supply
E/RES	Energy supply

E/COM	Energy supply
	Meter service
E/IND	Energy supply
	Meter service

**NOTE:**

Notice that we did not design a SA relationship type for our own distribution service. This is because our relationship type is implied (e.g., if you are a distribution company, you do not have to set up a SA relationship type for distribution service because the customer's "master" service agreement is implicitly associated with distribution service).

## Designing Service Providers

After you design your SA relationship types, you need to list every potential service provider for each SA relationship type.

CIS BU/ SA Type	SA Relationship Type	Service Provider
G/COM	Energy supply	AmeriGas
		TransGas
		Green Power
G/IND	Energy supply	AmeriGas
		TransGas
		Green Power
E/RES	Energy supply	Green Power
		Cheap Power
		Us
E/COM	Energy supply	ElectriCorp
		Cheap Power
		TeniCorp
	Meter service	MeterCorp
		Us
E/IND	Energy supply	ElectriCorp
		Cheap Power
		TeniCorp
	Meter service	MeterCorp
		Us

Next, list each unique service provider identified above:

Service Provider
AmeriGas
TransGas

Green Power

---

Cheap Power

---

Us

---

ElectriCorp

---

TeniCorp

---

MeterCorp

---

---

You will have at least one service provider for each entry in the above list. However, you may have to set up more than one service provider in the system for a given company. The topics below explain how this happens.

## Billing Relationship Segmentation

As described under [Billing Relationships](#), a service provider may bill for you, you may bill for them, or you may each send a separate bill to the customer. In the table below, we have shown the assumed billing relationships for each service provider.

Service Provider	Billing Relationship
AmeriGas	We Bill For Them - Bill Ready
TransGas	We Bill For Them - Bill Ready
Green Power	We Bill For Them - Rate Ready
Cheap Power - Res	We Bill For Them - Rate Ready
Cheap Power - Com/Ind	Dual Billing
Us - Billable	It's Us
Us - Non billable	None
ElectriCorp	They Bill For Us - Bill Ready
TeniCorp	We Bill For Them - Bill Ready
MeterCorp	Dual Billing

Notice that we had to introduce additional service providers:

- Cheap Power has two service providers - one for residential customers, the other for commercial/industrial customers. This is necessary because we provide billing service for them for residential customers ( We Bill For Them - Rate Ready ), but for commercial and industrial customers they bill for themselves ( Dual Billing ).
- Our own service provider (the service provider known as "Us") has two service providers - one for energy supply because we bill for the energy we supply ( It's Us ), and another for meter service because we don't create bills for meter service ( None ).

## We Bill For Them - Payment Relationship Segmentation

As described under [Pay At Bill Time vs. Pay At Pay Time](#) when you provide billing service for a service provider you have to define if you pay the service provider when you bill the customer OR only later, when the customer pays you.

In the table below, we have shown the payment relationships for each service provider.

Service Provider	Billing Relationship	Payment Relationship
------------------	----------------------	----------------------

AmeriGas	We Bill For Them - Bill Ready	Pay At Billing Time
TransGas	We Bill For Them - Bill Ready	Pay At Billing Time
Green Power	We Bill For Them - Rate Ready	Pay At Billing Time
Cheap Power - Res	We Bill For Them - Rate Ready	Pay At Billing Time
Cheap Power - Com/Ind	Dual Billing	N/A
Us - Billable	It's Us	N/A
Us - Non billable	None	N/A
ElectriCorp	They Bill For Us - Bill Ready	N/A
TeniCorp - Com	We Bill For Them - Bill Ready	Pay At Billing Time
TeniCorp - Ind	We Bill For Them - Bill Ready	Pay At Pay Time
MeterCorp	Dual Billing	N/A

Notice that we had to introduce an additional service provider for TeniCorp because for commercial customer we purchase the receivable (Pay At Bill Time), but for industrial customers we only pay them when we're paid by the customer (Pay At Pay Time).

## Consumption Relationship Segmentation

As described under [Consumption Relationships](#) a service provider may send the customers' consumption to you, you may send consumption to them, or you may have no consumption relationship with a given service provider.

In the table below, we have shown the consumption relationships for each service provider.

Service Provider	Billing Relationship	Payment Relationship	Consumption Relationship
AmeriGas	We Bill For Them - Bill Ready	Pay At Billing Time	We Send Consumption
TransGas	We Bill For Them - Bill Ready	Pay At Billing Time	We Send Consumption
Green Power	We Bill For Them - Rate Ready	Pay At Billing Time	N/A
Cheap Power - Res	We Bill For Them - Rate Ready	Pay At Billing Time	N/A
Cheap Power - Com/Ind	Dual Billing	N/A	N/A
Us - Billable	It's Us	N/A	N/A
Us - Non billable	None	N/A	N/A
ElectriCorp	They Bill For Us - Bill Ready	N/A	N/A
TeniCorp - Com	We Bill For Them - Bill Ready	Pay At Billing Time	We Send Consumption
TeniCorp - Ind	We Bill For Them - Bill Ready	Pay At Pay Time	We Send Consumption
MeterCorp	Dual Billing	N/A	N/A

Notice that we didn't have to proliferate service providers due to consumption relationships.

## Other Segmentations

The earlier parts of this discussion described the most common factors that cause the creation of service providers. However, many obscure factors could cause the introduction of more service providers. In this section we explain these more obscure factors.



## Payment Method

As described under [Pay At Bill Time vs. Pay At Pay Time](#), when you provide billing service for a service provider you have to pay the service provider at some point in time. The algorithm that defines the amount to pay (and how the related adjustment is generated) is defined on the service provider record. If a service provider has different payment algorithms for different customer segments, you must split the service provider accordingly.

## Transfer Receivable Method

As described under [When They Bill For Us, They Owe Us Money](#), a service provider will owe you money if they provide billing service for you. The algorithm that defines how to transfer the customer's receivable to the service provider is defined on the service provider record. If a service provider has different transfer A/R algorithms for different customer segments, you must split the service provider accordingly.

## Billable Charge Download Process

As described under [They Bill For Us - Bill Ready](#), billable charges are interfaced to service providers who provide billing service for you. The background process that performs the interface of billable charges is defined on the service provider record. If a service provider has different billable charge interfaces for different customer segments, you must split the service provider accordingly.

## Consumption Download Process

As described under [We Can Send Billed Consumption To Any Service Provider](#), consumption can be sent to any service provider. The background process that performs the interface of consumption is defined on the service provider record. If a service provider has different consumption interfaces, you must split the service provider accordingly.

## Notification Upload Processing

A service provider can send you notifications. Whenever a notification is uploaded, the system creates a workflow process to process each such notification. The type of workflow process that's created is controlled by the service provider's workflow process profile. If a service provider requires a different workflow process for a given type of notification (for whatever reason), you must split the service provider accordingly.

## Notification Download Processing

The system will send notifications to service providers when something noteworthy happens and when information is needed from a service provider. The type of notification that is sent to a service provider and the background process that interfaces the notification to the service provider is defined on the service provider's notification download profile. If a service provider requires a different type of notification to be sent or they have different interface protocols for a given type of notification, you must split the service provider accordingly.

## Financial Settlement Service Agreement

As described under [Service Providers Have Service Agreements Too](#), service providers have service agreements. These service agreements contain how much you owe the service provider (if you bill for them) and how much they owe you (if they bill for you). If you want to have separate service agreements for financial settlements associated with distinct customer segments, you must split the service provider accordingly.

## Geographic Area Segmentation

The following table reflects the new service providers that were added since we started [Designing Service Providers](#).

CIS BU/ SA Type	SA Relationship Type	Service Provider
G/COM	Energy supply	AmeriGas
		TransGas
		Green Power
G/IND	Energy supply	AmeriGas
		TransGas
		Green Power
E/RES	Energy supply	Green Power
		Cheap Power - Res
		Us - Billable
E/COM	Energy supply	ElectriCorp
		Cheap Power - Com/Ind
		TeniCorp - Com
	Meter service	MeterCorp
	Us - Non billable	
E/IND	Energy supply	ElectriCorp
		Cheap Power - Com/Ind
	Meter service	MeterCorp
	Us - Non billable	

Next, determine the postal code ranges in which a service provider is allowed to provide service.

CIS BU/ SA Type	SA Relationship Type	Service Provider	Postal Range
G/COM	Energy supply	AmeriGas	94000 - 95999
		TransGas	94000 - 95999
		Green Power	94000 - 95999
G/IND	Energy supply	AmeriGas	94000 - 95999

		TransGas	94000 - 95999
		Green Power	94000 - 95999
E/RES	Energy supply	Green Power	94000 - 95999
			93000 - 93999
		Cheap Power - Res	94000 - 95999
		Us - Billable	94000 - 95999
E/COM	Energy supply	ElectriCorp	94000 - 95999
		Cheap Power - Com/Ind	94000 - 95999
		TeniCorp - Com	94000 - 95999
	Meter service	MeterCorp	94000 - 95999
		Us - Non billable	94000 - 95999
E/IND	Energy supply	ElectriCorp	94000 - 95999
		Cheap Power - Com/Ind	94000 - 95999
		TeniCorp - Ind	94000 - 95999
	Meter service	MeterCorp	94000 - 95999
		Us - Non billable	94000 - 95999

Next, we need to strip off the SA types because the postal ranges are defined for combinations of service provider and SA relationship type. Notice the problem - we have a service provider - Green Power has different postal ranges for the same SA relationship type. You have two ways to fix this problem, you can split your service provider (have one for the gas and another for the electric), or you can split the SA relationship type (have one for the gas and another for the electric). We've chosen the former in our example.

SA Relationship Type	Service Provider	Postal Range
Energy supply	AmeriGas	94000 - 95999
	TransGas	94000 - 95999
	Green Power - Gas	94000 - 95999
Energy supply	AmeriGas	94000 - 95999
	TransGas	94000 - 95999
	Green Power - Gas	94000 - 95999
Energy supply	Green Power - Electric	94000 - 95999
		93000 - 93999
	Cheap Power - Res	94000 - 95999
	Us - Billable	94000 - 95999
Energy supply	ElectriCorp	94000 - 95999
	Cheap Power - Com/Ind	94000 - 95999
	TeniCorp - Com	94000 - 95999
Meter service	MeterCorp	94000 - 95999
	Us - Non billable	94000 - 95999
Energy supply	ElectriCorp	94000 - 95999
	Cheap Power - Com/Ind	94000 - 95999

	TeniCorp - Ind	94000 - 95999
Meter service	MeterCorp	94000 - 95999
	Us - Non billable	94000 - 95999

In the table below, we have shown the final list of service providers.

Service Provider	Billing Relationship	Payment Relationship	Consumption Relationship
AmeriGas	We Bill For Them - Bill Ready	Pay At Billing Time	We Send Consumption
TransGas	We Bill For Them - Bill Ready	Pay At Billing Time	We Send Consumption
Green Power - Electric	We Bill For Them - Rate Ready	Pay At Billing Time	N/A
Green Power - Gas	We Bill For Them - Rate Ready	Pay At Billing Time	N/A
Cheap Power - Res	We Bill For Them - Rate Ready	Pay At Billing Time	N/A
Cheap Power - Com/Ind	Dual Billing	N/A	N/A
Us - Billable	It's Us	N/A	N/A
Us - Non billable	None	N/A	N/A
ElectriCorp	They Bill For Us - Bill Ready	N/A	N/A
TeniCorp - Com	We Bill For Them - Bill Ready	Pay At Billing Time	We Send Consumption
TeniCorp - Ind	We Bill For Them - Bill Ready	Pay At Pay Time	We Send Consumption
MeterCorp	Dual Billing	N/A	N/A

## Designing Your SA Types And Start Options For Sub SAs

When you were [Designing Service Providers](#), you defined the service providers that were valid for every combination of SA type and SA relationship type. If you provide billing services for another service provider or if you subcategorize your own services, you another task - you have to design the SA types for your sub SAs.

As described earlier, there will be a separate [Sub Service Agreement](#) for every SA relationship for which we calculate a bill segment. Every sub SA must reference an SA type. The following table shows sample SA types (notice that they are only used for We Bill For Them and It's Us service providers).

CIS BU/ SA Type	SA Relationship Type	Service Provider	SA Type(s) for Sub SAs
G/COM	Energy supply	AmeriGas	AG1
		TransGas	TG1
		Green Power - Gas	GP-GC1
G/IND	Energy supply	AmeriGas	AG1
		TransGas	TG1
		Green Power - Gas	GP-GI1
E/RES	Energy supply	Green Power - Electric	GP-ER1
		Cheap Power - Res	CP-ER1
		Us - Billable	US-ER1
E/COM	Energy supply	ElectriCorp	Not applicable - they bill for us

		Cheap Power - Com/Ind	Not applicable - dual billing
		TeniCorp - Com	TC1
	Meter service	MeterCorp	Not applicable - dual billing
		Us - Non billable	Not applicable - no billing
E/IND	Energy supply	ElectriCorp	Not applicable - they bill for us
		Cheap Power - Com/Ind	Not applicable - dual billing
		TeniCorp - Ind	TC1
	Meter service	MeterCorp	Not applicable - dual billing
		Us - Non billable	Not applicable - no billing

The design steps required to set up these SA types are similar to those described under [Designing SA Types For Service Agreements With Service Points](#). The following points provide a few suggestions that will help you design your SA types for sub SAs:

- The business unit should be the same as defined for the master service agreement.
- Service type should be set up as per [Service Segmentation](#).
- Distribution code should be set up as per [Receivable Segmentation](#).
- Obviously, the sub SA switch should be turned on.
- Start options:
  - If the SA type is used for a We Bill For Them - Rate Ready service provider or for yourself, the start options should be Required because rates, contract riders and/or contract values will be populated on the sub SA from a start option. Refer to [Automatic Creation of Sub SAs](#) for more information.
  - If the SA type is used for a We Bill For Them - Bill Ready service provider, the start options should be not allowed because we don't need to default rates, contract riders and/or contract values on billable charge sub SAs.
- The payment distribution and late payment information should be set up as for any SA type. Refer to [Cash Distribution Segmentation](#) and [Late Payment Charge Segmentation](#) for more information.
- If the SA type is used for We Bill For Them - Bill Ready service provider, the special role should be Billable Charge, otherwise it should not be used. Remember, you should not use sub SAs for Cash Deposits.
- Deposit class should be used if the sub SA is covered by a deposit. Refer to [Deposits Issues](#) for more information.
- The one time charge switch should be off.
- Bill segment type:
  - If the SA type is used for a We Bill For Them - Bill Ready service provider, the bill segment type should reference a bill segment creation algorithm that creates bill segments from billable charges (and generates bill segment errors until the last night of the bill cycle). Refer to [The Bill Ready Calculation Method](#) for more information.
  - If the SA type is used for a We Bill For Them - Rate Ready service provider, the bill segment type should reference a get consumption algorithm that gets consumption from the master SA, and a bill segment creation algorithm that applies a rate.
- Specify a characteristic premise is required if the sub SA is associated with premise-oriented service.
- The calendar billing options should not be used.
- The recurring charge information should not be used.
- Sub SAs used for We Bill For Them - Rate Ready service providers should NOT be eligible for budgets and therefore the eligible for budget switch should be off. This admonition is given because budget billing causes current amount due to be out-of-sync with payoff amount due and we don't want this to happen for sub SAs. Why? Because we use the bill segments associated with these sub SAs to determine how much we owe the service provider.

- If the SA type is used for a We Bill For Them - Rate Ready service provider or for your own company, rates need to be set up; otherwise they should not be used.
- Sub SAs never reference service points. Refer to [Only The "Master" Service Agreement Is Linked To Service Points](#) for more information.
- Adjustment types profiles should be set up accordingly.
- Refer to [Credit and Collection Issues](#) for recommendations in respect of the debt class, write off debt class, and severance criteria associated with these SA types.
- Billable charge templates should not be used.
- Completion algorithms cannot be used for sub SAs.
- If the SA type is used for a We Bill For Them service provider, you should link to the SA type the FT freeze algorithm that controls how we pay the service provider. Refer to [Pay At Bill Time vs. Pay At Pay Time](#) for how this algorithm is used.
- The creation of bill segments for the sub SAs occurs after the bill segment for the related master SA is created. If you populate a [billing processing sequence](#) on an SA type for a sub SA, it is used to control the order in which the sub SAs for a given master SA are processed relative to each other.

Refer to [Setting Up SA Types](#) for how to set up these new SA types in the system.

## Reference Send Consumption Algorithm On Master SA Types

As explained under [We Can Send Billed Consumption To Any Service Provider](#), when a master SA's bill segment is frozen, the system must check if there are any service providers who need the bill segment's consumption. If so, it sets up the data necessary to interface the master SA's consumption (snapshot on the bill segment) to the service provider(s). The system will only do this if you specify an appropriate FT Freeze Algorithm on the master SA types. Refer to [SA Type - Algorithm](#) (FT Freeze Algorithm) for more information.

## Reference TBFU Algorithm On Master SA Types

As explained under [They Bill For Us](#), when a bill is completed, the system needs to check if there are any service providers who bill for us associated with the bills "master" SAs. If so, it sets up the data necessary to interface the master SA's charges to the service provider and to transfer the receivable balance from the customer to the service provider. The system will only do this if you specify an appropriate FT Completion Algorithm on the master SA types. Refer to [SA Type - Algorithm](#) (Bill Completion Algorithm) for more information.

---

### NOTE:

If there are multiple master SAs on a bill, the financial transactions associated with each respective master SA could be routed to different service providers (e.g., one service provider could bill for gas and another could bill for electricity). Refer to [Different Service Providers Can Bill Different Services](#) for more information.

---

## Designing SA Types For Service Provider Financial Settlements

As explained in [Service Providers Have Service Agreements Too](#), We Bill For Them and They Bill For Us service providers require a service agreement. You must create SA types for these types of service agreements. The following points provide a few suggestions that will help you design these financial settlement SA types:

- Service type should probably be a non-service oriented service type.

- Distribution code for We Bill For Them settlement SAs should be a payable account (or treat it as a "contra" receivable. Refer to [Receivable Segmentation](#) for more information.
- The sub SA switch should be turned off.
- Start options are not allowed.
- The payment distribution and late payment information should be set up as for any SA type. Refer to [Cash Distribution Segmentation](#) and [Late Payment Charge Segmentation](#) for more information.
- Special role should not be used.
- Deposit class should be used if the settlement service agreement is covered by a deposit. This would probably only be used for They Bill For Us service providers (because they will owe us money).
- The one time charge switch should be off.
- These service agreements are not billable and therefore none of the billing information should be specified.
- The characteristic premise switch should be off.
- Rates should not be used.
- Service points should not be used.
- Adjustment types profiles should be set up accordingly.
- Debt class, write off debt class, and severance criteria should be set up accordingly.
- Billable charge templates should not be used.
- Completion algorithms should not be used.
- Freeze algorithms should not be used.

Refer to [Setting Up SA Types](#) for how to set up these new SA types in the system.

## Setting Up SA Relationship Information

In the previous section, *Designing Your SA Relationship Types and Service Providers*, we presented a case study that illustrated a mythical organization's SA relationship information. In this section we explain how to set up this information.

### Setting Up SA Relationship Types

Open **Admin** > **Open Market** > **SA Relationship Type** to define your SA relationship types. Refer to [Designing SA Relationship Types](#) for more information.

#### Description of Page

Enter an **SA Relationship Type** code and **Description** for every relationship type.

#### Where Used

Follow this link to open the data dictionary where you can view the tables that reference [CI\\_SA\\_REL\\_TYPE](#).

### Setting Up Service Providers

The topics in this section describe how to set up service providers.

## Service Provider - Main

Open **Admin** > **Open Market** > **Service Provider** > **Add** to define core information about a service provider.

### Description of Page

Enter a unique **Service Provider** code for the service provider.

End a brief **Description** of the service provider.

If you communicate with this service provider via notification messages or outbound messages, indicate the service provider's **External System**.

If you send notifications to this service provider, select a **Notification DL (download) Profile** that is used to define the configuration of the outgoing messages.

Select the **Person ID** that contains this service provider's phone numbers and demographic information.

If you bill for the service provider or if they bill for you, select the **Service Agreement** that holds how much you owe them or they owe you. Refer to [Service Providers Have Service Agreements Too](#) for more information.

### Where Used

Follow this link to open the data dictionary where you can view the tables that reference [CI\\_SPR](#).

## Service Provider - Detail

Open **Admin** > **Open Market** > **Service Provider** > **Search** and navigate to the **Detail** page to define additional information about your service providers.

### Description of Page

Define the **Billing Relationship** you have with the service provider. Refer to [Billing Relationships](#) for more information.

If you provide billing services for this service provider (i.e., the **Billing Relationship** is We Bill For Them ), define the **Payment Relationship**. Refer to [Pay At Bill Time vs. Pay At Pay Time](#) for more information. You may not be paying some service providers as such. Rather, the customer's receivables are simply transferred to the service provider, e.g., when you calculate discounts for special [negotiated terms](#). For these service providers, choose a payment relationship of Pay SP Not Applicable.

Define the **Consumption Relationship** you have with the service provider. Refer to [Consumption Relationships](#) for more information.

If a service provider reads meters and they can override the customer's service cycle, turn on **Overrides ServiceCycle**. Refer to [MDMAs And Service Cycles](#) for more information.

As described under [Pay At Bill Time vs. Pay At Pay Time](#), when you provide billing service for a service provider you have to pay the service provider at some point in time. The **Pay Service Provider Algorithm** defines the amount to pay and how the related adjustment is generated. Refer to [Paying The Service Provider - Technical Implementation](#) for more information about how this algorithm is used. If you haven't done so already, you must set up this algorithm in the system. To do this:

- Create a new algorithm (refer to [Setting Up Algorithms](#)).
- On this algorithm, reference an Algorithm Type that increases how much is owed the service provider. Click [here](#) to see the algorithm types available for this plug-in spot.

As described under [When They Bill For Us, They Owe Us Money](#), a service provider will owe you money if they provide billing service for you. The **Transfer A/R Algorithm** defines how to transfer the customer's receivable to the service provider. Refer to [A/R Transfer - Technical Implementation](#) for more information about how this algorithm is used. This



algorithm is also used to transfer receivables when you calculate discounts for special [negotiated terms](#). If you haven't done so already, you must set up this algorithm in the system. To do this:

- Create a new algorithm (refer to [Setting Up Algorithms](#)).
- On this algorithm, reference an Algorithm Type that transfers financial transactions from the customer to the service provider. Click [here](#) to see the algorithm types available for this system event.

As described under [They Bill For Us - Bill Ready](#), billable charges are interfaced to service providers who provide billing service for you. The **Billable Charge Download Process** performs the interface of billable charges to the service provider. Refer to [Routing Billable Charges To Service Providers - Technical Implementation](#) for more information about how this process is used.

As described under [We Can Send Billed Consumption To Any Service Provider](#), consumption can be sent to any service provider. The **Consumption Download Process** performs the interface of consumption to the service provider. Refer to [Routing Consumption To Service Providers - Technical Implementation](#) for more information about how this process is used.

## Service Provider - SA Relationship Type

Open **Admin > Open Market > Service Provider > Search** and navigate to the **SA Relationship Type** page to define the types of relationships (e.g., energy supplier, energy distributor, meter data management agency) associated with a service provider and the postal code ranges in which the service provider operates.

### Description of Page

Use the **SA Relationship Types** collection to define this service provider's **SA Relationship Types**. Use the collection that appears in the grid to define the **Postal Code** ranges in which this service provider is allowed to operate for each **SA Relationship Type**.

---

#### IMPORTANT:

After defining the SA relationship types that can be associated with a service provider, you must then define the SA types on which the service provider / SA relationship type combination can be used. This information is defined using [Setting Up SA Relationships For SA Types](#).

---

## Service Provider - Bill Messages

Open **Admin > Open Market > Service Provider > Search** and navigate to the **Bill Messages** page to define bill messages to appear on bills that contain charges associated with a service provider.

### Description of Page

Use the **Bill Messages** collection to define **Bill Message** codes that should appear on bills that contain charges associated with a given service provider. For each message, also specify the **Start Date** and **End Date** when such a message should appear on the bill (leave **End Date** blank if the message should appear indefinitely).

### Where Used

The system snaps bill messages on a bill during bill completion. Refer to [The Source Of Bill Messages](#) for more information.

## Setting Up SA Types and Start Options For Sub SAs

The SA types and start options described under [Designing Your SA Types And Start Options For Sub SAs](#) must be set up. Refer to [Setting Up SA Types](#) for how to do this.

## Setting Up SA Types For Financial Settlements

The SA types described under [Designing SA Types For Service Provider Financial Settlements](#) must be set up. Refer to [Setting Up SA Types](#) for how to do this.

## Update Master SA Types With FT Freeze and Bill Completion Algorithms

Refer to [SA Type - Algorithm](#) for more information.

## Setting Up SA Relationships For SA Types

### SA Type SA Relationship Type - Main

Open **Admin** > **Open Market** > **SA Type SA Rel. Type** > **Add** to define the types of SA relationships and service providers that can be associated with a SA type.

#### Description of Page

Define the **SA Relationship Type** that can be associated with service agreements of this **SA Type**.

---

**NOTE:**

You may only define SA Relationship Types for "master service agreements".

---

Turn on the **Required** switch if this **SA Relationship Type** must be defined for service agreements of this type. Refer to [Defaulting Relationship Types And Defaulting Service Providers](#) and [Required Relationship Types and Billing](#) for more information.

Indicate if **Gaps in SA Relationships** of this type that are associated with this service agreement type are Allowed or Not Allowed. You should only select Allowed if relationships of this type can be expired without a relationship with another service provider to replace it. Deregulated relationships typically should not have gaps in the relationship. For example, a relationship with an energy service provider should not expire unless a relationship with another energy service provider replaces it. Refer to [negotiated terms](#) for an example of SA relationship types that allow gaps in SA relationships.

Use the collection to define the **Service Providers** who can be associated with this **SA Relationship Type** on service agreements of this **SA Type**.

---

**NOTE:**

Only **Service Providers** previously defined as being valid for the **SA Relationship Type** can be specified (refer to [Service Provider - SA Relationship Type](#) for how to link a service provider to a SA relationship type).

---

Turn on **Default SPR** if the **Service Provider** should be defaulted on newly created SA relationships. Refer to [Defaulting Relationship Types And Defaulting Service Providers](#) for more information.

Use **Status** to control if the **Service Provider's** relationship to the SA Type / SA Relationship type is Active or Inactive. Only Active service providers can be linked to service agreements of this type. The system allows Inactive service providers

in order to support historical service providers who are no longer active and to allow you to set up new service providers in advance of their start date.

Use the drill down button adjacent to a service provider to view the valid Sub SA Types. Alternatively, navigate the Sub SA Type tab and scroll until you find the desired service provider.

### Where Used

When a new SA relationship is defined for a service agreement, the system uses this information to make sure the relationship is valid and that the associated service provider is valid.

## SA Type SA Relationship Type - Sub SA Type

Open **Admin > Customer > SA Type SA Rel Type > Search** and navigate to the **Sub SA Type** page to define valid sub SA types for service providers associated with a SA type.

If you provide billing services for the service provider (i.e., the service provider's billing relationship is We Bill For Them ) or if you subcategorize your own charges (i.e., the service provider is your organization and it has a billing relationship of It's Us ) a [Sub Service Agreement](#) will be created for the service provider.

### Description of Page

The information in the collection defines the valid **Sub CIS Division** and **Sub SA Types** of these sub service agreements. Those entries marked as **Create Initially** are used by the process that creates sub SAs for new SA relationships. This background process uses this information as follows:

- If the sub SA's SA type doesn't use Start Options (as defined on SA Type - Main), the background process simply creates a sub SA with the given SA type. Note: these types of sub SAs are typically used for service providers who send their charges to you (i.e., they have a billing relationship of We Bill For Them - Bill Ready ). This is because Billable Charge service agreements are used for these types of service agreements and billable charge service agreements contain very little information.
- If the sub SA's SA type uses Start Options (as defined on SA Type - Main), the **Start Option** defined in the collection is used to populate the sub SA with default values (e.g., rate, contract rider, etc.). Refer to [Setting Up Start Options](#) for more information.

### Where Used

The process that creates sub SAs for new SA relationships uses this information to determine the number and type of sub SAs to create for each SA relationship.

## Negotiated Terms

The topics in this section describe the use of SA relationship functionality for applying certain types of negotiated terms. It assumes that you are familiar with SA relationship functionality in general.

---

### NOTE:

**Negotiated terms are optional.** The functionality described in this section is only relevant if your organization offers this functionality.

**Umbrella agreements.** If the Contract Management module is not [turned off](#), you may also choose to use umbrella agreements to manage the functionality described here.

---

Imagine that the head office for a multi-site organization negotiates special terms that cover a number of its sites, each of whom have their own account and service agreement. The negotiated terms typically involve discounts. These discounts may be realized

- Under a single service agreement, separate and distinct from the service agreements that are covered, or
- Individually, for each covered service agreement. In this case, two sub-scenarios exist:
  - The discounts may be reflected on the bill segment of each service agreement, or
  - The discounts may be transferred to another service agreement (the group's service agreement). The discount does NOT appear on the individual bill segment for the service agreements that are covered by the negotiated terms.

SA relationships track and manage complex business relationships between a customer and a service provider. You can define the above relationships using service agreement relationship functionality. This is a special type of SA relationship in which the head office is the service provider.

## Examples Of Special Discounts

The following topics illustrate examples of how your organization may configure the system to handle this business functionality.

### Example Using Aggregated Consumption

A customer, Fresh Foods has 10 stores each with its own account and electric service agreement, i.e., each store is billed separately. Fresh Food's head office decides to negotiate a group discount that applies to one or more of the individual stores.

In the following diagram, one store's account is shown.

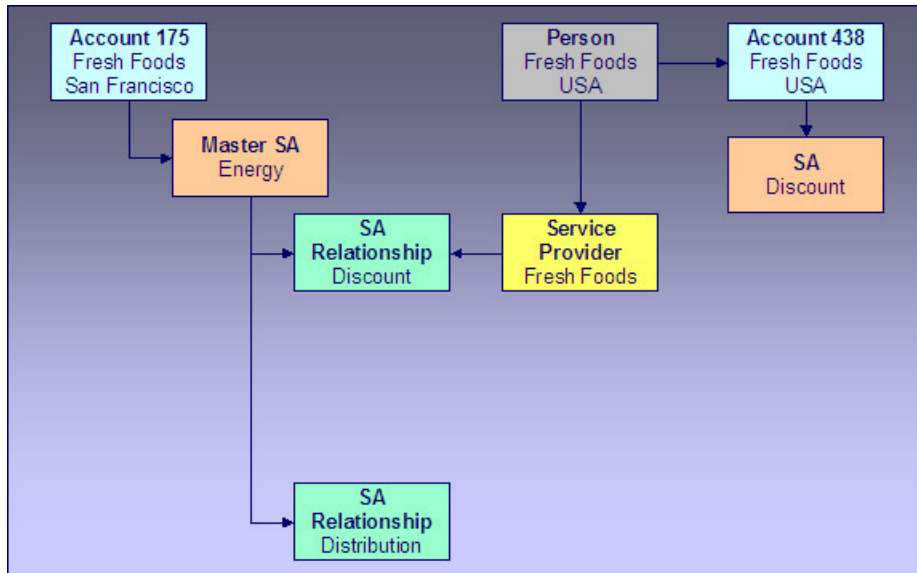

#### *Example Using Aggregated Consumption*

Note the following:

- An SA relationship is created for the energy SA covered by the negotiated terms.
- The service provider in the relationship is the head office.
- This relationship does not have a sub-SA because no additional billing services are provided for each individual covered service agreement.

- Discounts are calculated using the head office discount service agreement and affect only this service agreement and therefore only the head office's account.
- The master SA may have other deregulated relationships, such as the distribution relationship shown.

**NOTE:**

**Aggregated consumption algorithm.** In this scenario, the service provider's service agreement amalgamates the group's consumption and applies a rate to calculate the discount. This algorithm is not provided - you get to write this algorithm to meet your needs.

## Example Using Site-by-site Discount

In this scenario, the discount is calculated on a site-by-site basis.

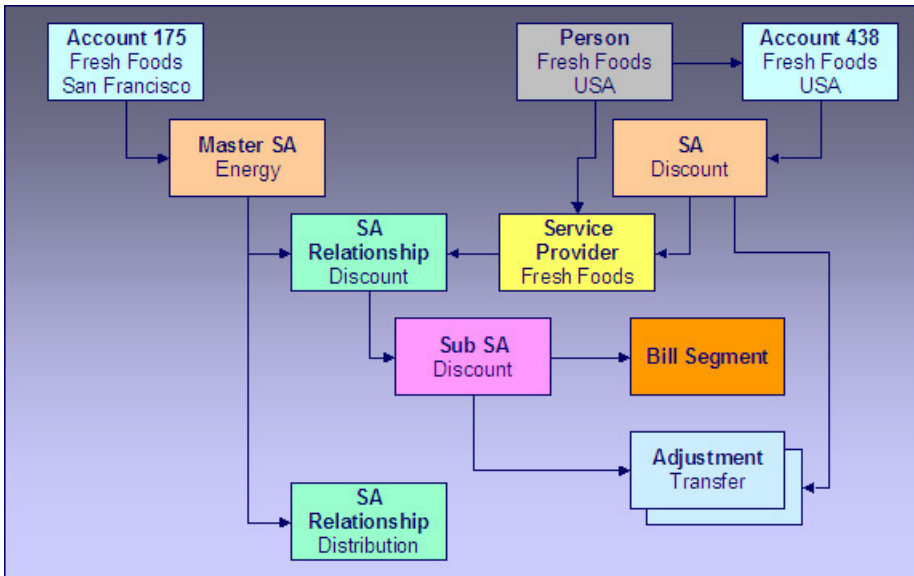

### *Example Using Site By Site Discount*

Note the following differences between this example and the one where consumption is aggregated:

- Each service agreement participating in the discount has an SA relationship with a sub SA.
- Discounts are calculated on a site-by-site basis by the sub SA for each service agreement covered by the discount agreement.
- The discounts may be transferred to the head office service agreement using transfer adjustments. In this case, you may choose to not show the discount on the individual site's bills.

## Setting Up The System To Enable Negotiated Terms

The above topics provided background information about how special negotiated terms could be supported in the system. The following discussion summarizes the various setup tasks alluded to above. These notes highlight the setup required in addition to that detailed in [Setting Up SA Relationships Information](#).

## Algorithm

If you use sub SAs to calculate charges / discounts for each covered service agreement individually and you want to transfer the charges / discounts to the service provider's service agreement at bill completion, you will need to set up a bill completion algorithm to do this.

Refer to the algorithm type [BCMP-TR](#) for more information.

## SA Relationship Type

You will need an SA relationship type that will be used for each type of negotiated term or discount.

## Service Provider

Set up a service provider using the principal party of the negotiated discount. For example, if a head office negotiates a special agreement for its sites, you should set up a new service provider representing the head office.

- **Billing Relationship** will depend on the type of negotiated terms you choose to set up. For terms where debits / credits are calculated for each covered service agreement individually, select We Bill For Them, Rate Ready. We are effectively billing on behalf of the principal party. For terms where the discount is calculated on an amalgamated SA there is no billing relationship because no additional billing services are provided for each covered service agreement.
- Select a **Payment Relationship** of Pay SPR Not Applicable if debits / credits to the sub-SA should not be transferred to the service provider. If you want to transfer charges at bill completion time using a bill completion algorithm, you should also select Pay SPR Not Applicable because you will not be creating adjustments to pay the principal party service at payment time or at billing time.
- Enter a **Transfer A/R Algorithm** to transfer the debit / credit from the sub-SA to the principal party's service agreement. If you do not want to transfer the debit / credit to the principal party's service agreement, you do not need to specify a transfer algorithm.

## SA Type SA Relationship Type

Associate the SA relationship type setup for negotiated terms with the SA type(s) of the service agreements that are covered by the terms. The following are suggested values for the SA type SA relationship type:

- **Required.** Relationships of this type should not be required for the SA type because the negotiated terms will only cover selected service agreements with that SA type.
- **Gaps in SA Relationship** are Allowed if service agreements of this type do not have to have an SA relationship of this type with a service provider throughout the effective period of the SA.
- Add the service provider set up above to the list of valid service providers for this SA type and SA relationship type combination.

## SA Type

Set up an SA type for the sub SAs that will be used to calculate discounts. This SA type should use the [BCMP-TR](#) bill completion algorithm if you want to transfer the discounts to the head office.

---

**NOTE:**

**TBFU Deregulated Relationship with WBFT Negotiated Terms Relationship.** If you have the unusual situation where a master service agreement has a relationship with a TBFU service provider as well as a negotiated term "relationship" with a WBFT service provider, and you transfer charges / discounts from the discount agreement sub SA to the WBFT service provider, you will not be able to use the algorithms provided to transfer receivables to the service providers. This is because bill completion algorithms associated with the SA type of a master service agreement are executed before any bill completion algorithms associated with the SA types of sub service agreements. Consequently the TBFU XFER algorithm associated with the master service agreement will transfer all receivables from related sub SAs to the TBFU service provider before the BCMP-TR algorithm can transfer the discount agreement receivables. You will need to modify the TBFU XFER bill completion algorithm that transfers receivables from the customer to the TBFU service provider to exclude the discount agreement receivables.

---

## Defining Service Credit Options

Some companies allow their customers to participate in a special rewards program. The term "service credits" is used to describe a program that rewards customers for their business. The topics in this section provide details to help you set up the control tables required to support any service credit program that your company supports.

---

**NOTE:**

**Penalty Points.** The service credits functionality is described in the documentation with the assumption that it is used for accumulating points to reward your customers. However, if your company has a business need to record penalty points for a customer, the service credits functionality may be used for that purpose as well.

---

## The Big Picture Of Service Credits

The topics in this section provide background information about service credit functionality.

### Service Credit Membership

Let's look at some examples of special programs that may use service credits functionality:

- Capital credits - When customers receive their utility service from a cooperative, they are considered "members" of the cooperative and may over time receive capital credit allocations from the cooperative based on their service history and the cooperative's profits allocated during that time period.
- Frequent flier miles - Perhaps your company has made an agreement with one or more airlines to allow customers to accumulate frequent flier miles for every x amount spent on service.
- Free pay-per-view movies - Maybe your cable service offers free pay-per-view movies under certain conditions. Using service credits, you can set up your system to accumulate the free pay-per-view movies and use the free movies to offset actual movies viewed by the customer.
- Any other type of loyalty program where the customer earns credits that may later be redeemed in some way.

To participate in a program such as those described above, the customer is linked to a service credit membership. The membership record provides the following functionality:

- It defines the accounts that are linked to the membership.

---

**FASTPATH:**

Refer to [Who are the Members?](#) for information about linking persons and accounts to a membership.

---

- It defines a [membership type](#), which controls certain behavior about the membership.
  - It may define an external ID if the membership is associated with an external program, such as a frequent flier mile program.
  - It may define a [service agreement](#) to use for miscellaneous financial transactions that may get created.
  - It may define characteristics used to capture miscellaneous information about the membership.
  - Over time, service credit events are created for a membership. The events indicate an amount that either adds or subtracts credit units (i.e., points, miles, movies, dollars, etc) for the membership.
- 

**FASTPATH:**

Refer to [The Big Picture of Service Credit Membership](#) for more information about functionality related to a membership.

---

## How Are Service Credits Earned?

Service credits may be monetary rewards for service or they may be non-monetary rewards such as free movies or frequent flier miles. In any case, how the membership earns the points or rewards depends on the business rules for the program you are offering.

A typical scenario is that the service credits are earned for a membership as a result of other services linked to the membership's accounts. For example:

- Perhaps free pay-per-view movies are earned when signing up for cable service. In this case, the pay-per-view movie membership is related to the membership account's cable service agreement. Refer to [Service Credits Earned When Starting Service](#) for more information.
- Perhaps one frequent flier mile is earned for every \$10 spent on electricity. In this case, the frequent flier membership is related to the membership account's electricity service agreements (for example, electricity distribution, electricity retail and lamp service). Refer to [service credits earned through billing](#) for more information.
- For a capital credits membership, capital credit allocations are calculated based on the amount spent by the customer for standard service, for example electricity and/or gas service. In this case, the capital credit membership is related to the membership account's electricity and/or gas service agreements. For capital credits, a background process is used to calculate the allocated amounts. Refer to [Allocating Capital Credit](#) for more information.

It is also possible to earn service credits irrespective of other service for the membership's accounts. (Again, it depends on the business rules for the program you are offering.) For example, perhaps you offer 500 frequent flier miles for signing up for service with your company, regardless of the type of service chosen. In addition, assume that no additional miles are earned for ongoing service. In this example, there is no need to link the membership to any service agreements.

---

**FASTPATH:**

Refer to [Service Agreements Contribute to a Membership](#) for more information.

---

Each earned service credit amount is linked to the membership via a [service credit event](#).

## How Are Service Credits Redeemed?



Once service credits have been earned for a membership, how may a customer redeem these credits? The method by which the credits are redeemed depends on the business rules for the program you are offering. Here are some examples of how a service credit may be redeemed:

- For free pay-per-view movies, perhaps your customer's monthly cable bill is credited for any pay-per-view movies until all free movies are used. Refer to [Service Credits Redeemed Through Billing](#) for more information.
- For frequent flier miles, the information about the earned miles is exported to the appropriate airline. The miles are actually redeemed by the customer through the airline, not through your company. Refer to [Interface Membership Information to a Third Party](#) for more information.
- For a capital credit membership, the company periodically (maybe once a year) decides if credits should be redeemed (referred to as "retired") and if so, how much. The company runs a background process to calculate the "retirement" amount. When an amount is retired, the membership balance is reduced by the retirement amount and the amount is transferred to service agreements related to the membership. Refer to [Capital Credit Retirement](#) for more information.

**NOTE:**

**Tracking Membership Balances.** If service credits are redeemed via the system, your membership should probably be configured to keep track of a balance. Refer to [Event Amounts May Contribute to a Balance](#) for more information.

Each service credit amount redeemed through the system is linked to the membership via a [service credit event](#).

## Service Agreements For a Membership

There are three types of service agreements that may be associated with a service credit membership. The following sections describe these types.

### SAs Contribute to the Membership

As described in [how are service credits earned](#), many memberships are related to specific service agreements for the membership's accounts. We refer to these service agreements as the SAs that contribute to the membership because often the service credit amounts earned for the membership are based on amounts spent by the customer for these services.

During the lifetime of a membership, service agreements that contribute to a membership may be stopped and other service agreements started. For example, perhaps you have a frequent flier membership that is related to electric service. Imagine that the customer starts out with a certain rate for electric service, but later decides to opt for a different type of rate that requires expiring the old service agreement and creating a new one. How does this affect your frequent flier mile calculation? It depends on how you design the [algorithm](#) that creates the frequent flier events. Essentially, the algorithm must cater for this situation. The following diagram illustrates the scenario.

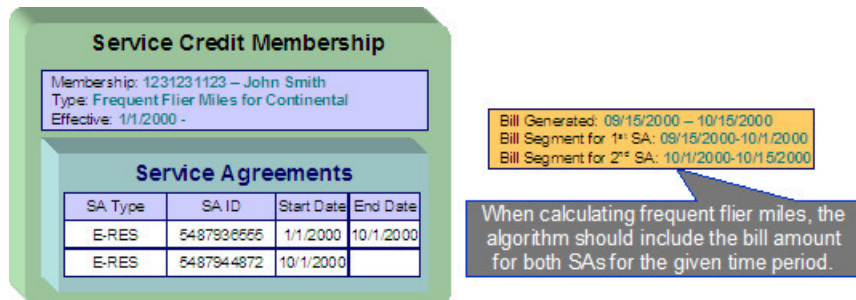

The service agreements that contribute to a membership are not linked directly to the membership record. This would cause a maintenance burden, requiring links to be updated when service is stopped or started for applicable service agreements.

Rather, this link is indirect. The list of service agreement types is defined for the membership type. The system can determine which service agreements are "linked" to the membership by looking at the SA types for the membership type.

---

**FASTPATH:**

Refer to [Determine The Types of Service Agreements That Contribute to the Membership](#) for more information on designing your membership type to include appropriate SA types.

---

## SA Used for Miscellaneous Transactions

For some memberships, you may need to define a special service agreement to use for miscellaneous transactions. For example:

If events created for a membership cause an adjustment to be created to affect the general ledger, rather than allowing the system to arbitrarily pick a service agreement to use for this adjustment, the SA to use should be indicated on the membership. Refer to [An Event May Cause Other Actions to Occur](#) for more information.

## Membership Fee SAs

For some memberships, a [membership fee](#) may be applicable. A special service agreement is used to hold the fee. This service agreement is not linked directly to the membership, but is simply a service agreement linked to one of the membership's accounts.

---

**NOTE:**

**Some fees may be refundable.** The refunding of a fee must be handled by an algorithm. Refer to [SAST-RF](#) for information about the algorithm type provided with the base product.

---

## Designing Your Service Credit Options

This section helps you to determine how to design your service credit membership types and service credit event types.

## Designing Your Membership Types

This section discusses the options to consider when designing your service credit membership types.

First consider the type of unit that your membership's service credit events represent.

- Is it related to a currency? If so, ensure that your currency is correctly defined on the [currency](#) page.
- Is it a non-currency unit, such as movies, points or miles? If so, you need to define the unit on the [credit unit](#) page.

Next, consider other behavior that your membership may exhibit.

- Should your membership [calculate an overall balance](#) ?
- Will miscellaneous financial transactions be created for you membership over its lifetime? If so you may need to link a [service agreement to your membership](#).
- Should events linked to your membership reference a [fiscal year](#) ?

The table below illustrates three types of memberships: one for capital credits, one for frequent flier miles and one for free pay-per-view movies.

Membership Type	Description	Unit Type / Currency or Credit Unit	Has Balance?	Require SA?	Fiscal Year?
STDCAPCR	Standard capital credit membership	Currency / \$	Yes	Yes	Yes
FFDELTA	Delta frequent flier miles	Credit Unit / Miles	No	No	No
FREEPPV	Free pay-per-view movies	Credit Unit / Movies	Yes	No	No

The following points explain the settings for each membership above:

- The capital credit membership uses a currency of US dollars for its units. Over time, capital credits are allocated and retired. The overall balance of the credits and debits should be calculated and displayed for information purposes. It is common for the allocation and retirement of capital credits to affect the GL, and as a result, a membership SA is required for posting these financial effects. Finally, in a capital credit situation, the allocation is typically related to a specific fiscal year. When calculating and displaying balances, the balance for each fiscal year must also be available. As a result, the fiscal year must be set to required.
- For the frequent flier membership type, a separate membership type must be created for each different airline. This is because a separate membership must exist for each separate airline in order to keep track of the accumulated miles correctly. The membership type does not have a balance because the accumulated miles are interfaced to the airline and the airline keeps track of the balance. In this example, no SA is required because an assumption is being made that the creation of frequent flier miles does not affect the GL. (Accumulating miles is no liability or expense for the company. The miles are simply accumulated on behalf of a third party.) Finally, the frequent flier miles do not need to indicate a fiscal year.
- For the free pay-per-view movies membership, we assume that the credits are redeemed from within the system. For example, perhaps a calculation rule calculation algorithm or pre-processing calculation rule redeems the free pay-per-view movies over time as customers are billed for the movies. As a result, the membership should have a balance. In this example, no SA is required because an assumption is being made that any affect on the GL is posted at the time the free movies are redeemed (i.e., when calculating a bill). (This is just an example. It's possible that you may want to post to the GL when free movies are accumulated to mark a payable for the company.) Finally, free pay-per-view movies do not need to indicate a fiscal year.

More options must be considered for each membership type.

## Consider Whether the Membership Should Indicate Subcategories

For some types of memberships, the amount of each service credit event is further grouped by a subcategory. Refer to [Events May Indicate a Subcategory](#) for more information.

Use subcategories if multiple subtypes of credits may be accumulated and redeemed and if balances need to be tracked for each subcategory.

For our sample membership types, only the capital credits type should indicate subcategories.

Membership Type	Description	Subcategories
STDCAPCR	Standard capital credit membership	Distribution Transportation
FFDELTA	Delta frequent flier miles	
FREEPPV	Free pay-per-view movies	

## Determine the Types of Service Agreements Linked to the Membership

Memberships typically exist to reward customers for participating in standard service with the company. Refer to [How Are Service Credits Earned?](#) for more information. If memberships of this type are related to standard service for your company, determine the SA types for these service agreements.

---

**NOTE:**

**Standard Service SA Types.** These service agreement types are probably different from the type of service agreement you may link as the membership SA. The membership SA is used for miscellaneous charges like general ledger posting. These SA types are related to electricity service, gas service, etc.

---

For our three examples, assume that the company provides electric service and cable. The capital credits are related only to electric service, frequent flier miles are accumulated for a combination of services, and free pay-per-view movies are related only to cable service.

Membership Type	Description	SA Types
STDCAPCR	Standard capital credit membership	E-RES (Electric Residential) AL-RES (Area Lighting)
FFDELTA	Delta frequent flier miles	E-RES (Electric Residential) AL-RES (Area Lighting) CABLE -RES (Cable Residential)
FREEPPV	Free pay-per-view movies	CABLE-RES (Cable Residential)

## Consider Special Functionality Needed When Adding, Activating or Inactivating a Membership

Should a letter or bill message be generated when a membership is created or activated? Should anything happen when a membership is inactivated? If so, you may need to define one or more algorithms to be plugged in on the membership type.

For our examples, let's say that a bill message is generated when a frequent flier or free pay-per-view membership is created. Let's say that a letter is generated when a capital credits membership is activated. We also assume that when a capital credits membership becomes inactive, any outstanding balance is redeemed. For the frequent flier miles and pay-per-view memberships, we assume nothing special occurs when the membership becomes inactive.

---

**FASTPATH:**

Refer to [Lifecycle of a Membership](#) for more information about the various status values for a membership.

---

Membership Type	Description	Algorithm System Event	Algorithm
STDCAPCR	Standard capital credit membership	Membership Activation	Send Letter
		Membership Inactivation	Redeem Balances
FFDELTA	Delta frequent flier miles	Membership Creation	Generate Bill Message
FREEPPV	Free pay-per-view movies	Membership Creation	Generate Bill Message

---

**NOTE:**

**Sample Algorithms.** The base package does not provide sample algorithms for all the above examples. Refer to [Service Credit Membership Type - Algorithm](#) for more information about the algorithms provided with the system.

---

## Determine Whether The Membership Requires Additional Information

Is there any information about your membership that you need to capture that is not already provided by the base system logic? If the answer is yes, you may need to define characteristics for your membership. Use the [characteristic collection](#) on the membership type to define the types of characteristics allowed for memberships of this type. You may also define default values for you membership's characteristics.

## Designing Your Service Credit Event Types

Now that you have designed your membership types, you need to design the types of service credit events that may be created for your membership.

In many cases, a credit event should cause additional functionality to occur. Algorithms are executed when an event is completed and when an event is canceled and are used to perform additional functionality. The following points illustrate possible algorithms that may be needed when a credit event is completed.

- Validate the event as compared to other events. For example, perhaps a new event should never cause the overall membership balance to fall below zero. You could use an algorithm on the service credit event type to check this condition.
- Create an adjustment that posts to the general ledger. Your credit event may not affect the customer's balance when created, but perhaps it should have an effect on the general ledger. For these types of credit events, you may need to create an adjustment to post to the GL.
- Create adjustments to affect the customer's balance. When "redeeming" a credit, you may need to transfer a monetary amount to one or more of the customer's service agreements.
- Create a bill message. Perhaps when a credit is accumulated, you want to inform the customer via a message on the bill indicating the credit amount. A temporary bill message is added to one of the membership's accounts.

---

### NOTE:

**One Account Message of the Same Message Type.** The temporary bill message collection on the account allows only one bill message of the same bill message type. If it's possible for multiple types of events to be generated for the same account, consider creating a different bill message type for each event type.

---

- Stamp a batch code and batch run number onto the event. This would be used when your event information needs to be interfaced to an external system.

The following points illustrate possible algorithms that may be needed when a credit event is canceled.

- Validate the event as compared to other events. For example, perhaps canceling an event should never cause the overall membership balance to fall below zero.
- Cancel adjustments that may have been created when the event was completed.

To illustrate examples of when to use some of the algorithms above, we'll design event types for the membership types designed above.

## Designing Capital Credit Event Types

The following event types illustrate typical events for a capital credits membership.

SC Event Type	Description	Membership Type	Algorithm System Event	Algorithm
ALLOCATECCR	Capital credit allocation	STDCAPCR	Event Creation	Create Simple Adjustment
			Event Creation	Generate Bill Message
			Event Cancellation	Validate Balance Not < Zero
			Event Cancellation	Cancel Related Adjustments
RETIRECCR	Retire capital credit (apply to customer's balance)	STDCAPCR	Event Creation	Validate Balance Not < Zero
			Event Creation	Create Adjustments to Affect Customer's Balance
			Event Cancellation	Cancel Related Adjustments
FORFEITCCR	Forfeit capital credit (retirement not applied to customer's balance)	STDCAPCR	Event Creation	Validate Balance Not < Zero
			Event Creation	Create Simple Adjustment (affect GL only)
			Event Cancellation	Validate Balance Not < Zero
			Event Cancellation	Cancel Related Adjustments

These event types assume the following:

- When credit events are allocated, the customer is notified via a bill message, the general ledger is affected so a simple GL only adjustment is created. If an event of this type is canceled, any adjustments that were created should be canceled. The event amount should always be positive, so checking that the membership balance does not fall below zero is only checked for event cancellation.
- When capital credits are retired, it's possible that the full membership balance is not applied to the customer's balance. For the portion of the retirement that does affect the customer's balance, you need an algorithm that applies the credits to the customer's service agreements via adjustments. Cancellation of this event should cause any related adjustments to be canceled. It's assumed that the amount of this event is a credit so checking that the membership balance does not fall below zero is only checked for event completion.
- For the portion of the retirement that is not applied to the customer's balance, the event amount should simply affect the GL so a GL only adjustment is created. Cancellation of this event should cause any related adjustments to be canceled. It's assumed that the amount of this event is a credit so checking that the membership balance does not fall below zero is only checked for event completion.

**NOTE:**

**Service credit event types are independent of subcategories.** A capital credits membership typically uses subcategories. When events are created for different subcategories, the same service credit event type may be used. As a result, all subcategories use the same event completion and event cancellation algorithms.

## Designing Frequent Flier Event Types

The following event types illustrate typical events for a frequent flier membership:

SC Event Type	Description	Membership Type	Algorithm System Event	Algorithm
ADDMILES	Add miles to the membership	FFDELTA	Event Creation	Generate Bill Message
			Event Creation	Populate Batch Information
			Event Cancellation	Event may not be canceled.

This event type assume the following:

- A new event should generate a bill message.
- Information about the event amount should be interfaced to an external system so batch information should be populated when the event is completed.
- Events of this type may not be canceled because the information is interfaced to an external system. Rather, to reverse an event, simply create a new event whose amount is a credit. This credit amount is also interfaced to an external system.

**NOTE:**

**Sample Algorithm.** The system does not provide a sample cancellation algorithm that prevents the event from being canceled.

- There is no validation to ensure that the balance does not fall below zero. Recall that this membership was defined as not requiring a balance.

Notice that only one type of event has been defined for this membership. That is because the credits for this membership are not redeemed via this system. Rather they are accumulated on behalf of an external system.

## Designing Pay-per-view Event Types

The following event types illustrate typical events for a free pay-per-view movies membership:

SC Event Type	Description	Membership Type	Algorithm System Event	Algorithm
ADDPV	Free pay-per-view movies	FREEPPV	Event Creation	Generate Bill Message
			Event Cancellation	Validate Balance Not < Zero
REDEEMPPV	Redeem pay-per-view movies	FREEPPV	Event Creation	Validate Balance Not < Zero
			Event Creation	Generate Bill Message

These event types assume the following:

- Any type of new event should generate a bill message.
- For adding free movies, it is assumed that the quantity is positive so when the event is cancelled, the algorithm verifies that the balance does not become negative.

- For redeeming free movies, it is assumed that the quantity is negative so when the event is completed, the algorithm verifies that the balance does not become negative.
- These events do not affect the general ledger and they do not directly affect the customer's balance so no adjustment algorithm is needed.

## How Are Service Credit Events Created?

Now that you have designed the behavior of your service credit events, an important issue is to determine how these events are created. Consider your business practice for each type of membership.

Let's use our sample memberships to work through different ways that you may create service credits.

### Service Credits for Capital Credit Memberships

For a capital credit membership, capital credit allocations are calculated once a year based on billing history and the cost of service. To accomplish this, a background process calculates the amount and creates the service credits. Refer to [allocating capital credits](#) for a sample process provided with the base package.

Credits are redeemed via the retirement process. The company determines when to retire capital credits based on analysis of their financial situation. This retirement process is also handled by a background process. Refer to [capital credit retirement](#) for a process provided with the base package.

For capital credits memberships, special functionality is required when a member dies. The capital credits are considered part of the person's estate and may need to be retired and applied to a beneficiary's account. This process depends on the company's business practice. However, typically, the membership status would change to inactive so that new capital credit allocations are not created for the membership. The system provides a sample inactivation algorithm called [SCMI-RB](#) that transfers part or all of the outstanding credit balance to the member's service agreements. From there, a user can cut a check to the beneficiary.

---

**NOTE:**

**Some Credits Are Never Retired.** For many cooperatives, some types of allocated credits are never retired. Refer to [Partial Retirement](#) for more information.

---

### Service Credits for Frequent Flier Memberships

In our example, frequent flier miles were related to both the electricity and phone service. Let's assume that frequent flier miles are accumulated every \$x spent on electricity and phone service. In this example, a bill completion algorithm creates service credits based on the bill segment amounts for these service agreements. Refer to [Service Credits Earned Through Billing](#) for more information.

As mentioned before, the frequent flier miles are not redeemed using this system, but are interfaced to a third party for redemption.

### Service Credits for Free Movies Memberships

---

**NOTE:**

**Sample Algorithms.** No base package algorithm types are provided to support the logic described in this example.

---



In this scenario, let's suppose that a customer receives three free pay-per-view movies when signing up for new service. To handle this, perhaps an SA creation algorithm creates the membership and the service credits when the service is started. Or perhaps you want to wait until the first bill is generated and a bill completion algorithm is used to generate the first credit. It depends on your business practice.

For redeeming the free pay-per-view movies, it is assumed that the movies are credited during billing after it is determined that the customer has been billed for a movie. The number of movies used for the membership is reduced until all the free movies are used.

---

**FASTPATH:**

Refer to [Service Credits Redeemed Through Billing](#) for more information.

---

## Setting Up Service Credit Options

### Setting Up Credit Units

Credit unit is used for service credit membership types whose [events](#) record non-monetary units. Open **Admin > Service Credit > Credit Unit** to set up credit units.

**Description of Page**

The following fields display for each credit unit:

**Credit Unit** The unique identifier of the credit unit.

**Description** The description of the unit. This also acts as a label for the unit when displaying information about a service credit event.

**Symbol / Label Position** Indicates whether or not the label for this credit unit appears as a Prefix or as a Suffix to the service credit event amount.

**Decimal Positions** Indicates the number of decimal positions used for this credit unit. This information should be used by any algorithm or background process that creates a service credit event to determine how to store the event amount. It is also use to correctly display the service credit amounts.

**Where Used**

Follow this link to open the data dictionary where you can view the tables that reference [CI\\_CR\\_UNIT](#).

### Setting Up SC Membership Inactive Reasons

The service credit membership inactive reason must be specified when the status of a service credit membership changes to inactive. Open **Admin > Service Credit > Service Credit Membership Inactive Reason** to set up service credit inactive reasons.

**Description of Page**

The following fields display for each inactive reason:

**Inactive Reason** The unique identifier of the service credit membership inactive reason.

**Description** The description of the inactive reason.

**Where Used**

Follow this link to open the data dictionary where you can view the tables that reference [CI\\_SCM\\_NCTV\\_RSN](#).

# Setting Up Service Credit Membership Types

## SC Membership Type - Main

Service credit memberships have a membership type. Open **Admin > Service Credit > Service Credit Membership Type > Add** to define the membership type.

### Description of Page

Enter a unique **Service Credit Membership Type** and **Description** for each membership type.

Use the **SA Requirement** flag to indicate whether a [miscellaneous SA](#) must be linked to memberships of this type. The possible values are SA Required and SA Not Allowed .

---

**NOTE:**

The value defaults to SA Required.

---

Use the **Fiscal Year Requirement** flag to indicate whether events linked to memberships of this type should indicate a [fiscal year](#). The possible values are Fiscal Year Required and Fiscal Year Not Allowed.

---

**NOTE:**

**Default Note.** The value defaults to Fiscal Year Not Allowed.

---

Use the **SCM Event Balance** flag to indicate whether or not a [balance of service credit events](#) linked to memberships of this type should be calculated and displayed. The possible values are Has a Balance and No Balance.

---

**NOTE:**

**Default Note.** The value defaults to Has a Balance.

---

Use the **SC Membership Type Unit** flag to indicate whether or not the unit for the event amounts for events linked to memberships of this type is Currency or Credit Unit. When the unit is currency, indicate the **Currency Code**. When the unit is credit unit, indicate the **Credit Unit**.

If events linked to memberships of this type must indicate a subcategory, enter a valid **Subcategory Name** and **Description** for each subcategory applicable to this membership.

---

**FASTPATH:**

Refer to [Events May Indicate a Subcategory](#) for more information.

---

Use the **SA Types** grid to indicate the types of [service agreements that contribute to memberships](#) of this type. Indicate the **CIS Division** and **SA Type** for each type of service agreement that is related to a membership of this type.

### Where Used

Follow this link to open the data dictionary where you can view the tables that reference [CI\\_SCM\\_TYPE](#).

## SC Membership Type - Algorithm

Open **Admin > Service Credit > Service Credit Membership Type > Search** and navigate to the **Algorithm** page to define any algorithms that are associated with a membership type.

### Description of Page

The grid contains **Algorithms** that control important functions in the system. You must define the following for each algorithm:

- Specify the **System Event** with which the algorithm is associated (descriptions of all possible events are provided below).
- Specify the **Sequence** and **Algorithm** for each system event. You can set the **Sequence** to 10 unless you have a **System Event** that has multiple **Algorithms**. In this case, you need to tell the system the **Sequence** in which they should execute.

The following table describes each **System Event** for which you can define algorithms.

System Event	Optional / Required	Description
Membership Creation	Optional	Use this system event for algorithms that are executed when a membership is created.  Click <a href="#">here</a> to see the algorithm types available for this system event.
Membership Activation	Optional	Use this system event for algorithms that are executed when a membership becomes active.  Click <a href="#">here</a> to see the algorithm types available for this system event.  <b>NOTE:</b> <b>Creating Memberships In Active Status.</b> A membership may be created in either pending status or in active status, based on your business practice. For memberships created in active status, the system executes the membership creation algorithms and the membership activation algorithms.
Membership Inactivation	Optional	Use a system event of Membership Inactivation for algorithms that are executed when a membership becomes inactive .  Click <a href="#">here</a> to see the algorithm types available for this system event.

## SC Membership Type - Characteristics

To define characteristics that can be defined for service credit memberships of a given type, open **Admin > Service Credit > Service Credit Membership Type > Search** and navigate to the **Characteristics** page.

### Description of Page

Use the characteristics collection to define characteristics that can be defined for service credit memberships of a given type. Use **Sequence** to control the order in which characteristics are defaulted. Turn on the **Required** switch if the **Characteristic Type** must be defined on service credit memberships of a given type. Turn on the **Default** switch to default

the **Characteristic Type** when service credit memberships of the given type are created. Enter a **Characteristic Value** to use as the default for a given **Characteristic Type** when the **Default** switch is turned on.

## Setting Up Service Credit Event Types

Service credit events created for a service credit membership have an event type. Open **Admin > Service Credit Event Type > Add** to set up service credit event types.

### Description of Page

Enter a unique **Service Credit Event Type** and **Description** for each event type.

Indicate the **Service Credit Membership Type** to which this event type belongs.

The grid contains **Algorithms** that control important functions in the system. You must define the following for each algorithm:

- Specify the **System Event** with which the algorithm is associated (descriptions of all possible events are provided below).
- Specify the **Sequence** and **Algorithm** for each system event. You can set the **Sequence** to 10 unless you have a **System Event** that has multiple **Algorithms**. In this case, you need to tell the system the **Sequence** in which they should execute.

The following table describes each **System Event** for which you can define algorithms.

System Event	Optional / Required	Description
Event Completion	Optional	Use a system event of Event Completion for algorithms that are executed when an event is completed. Refer to <a href="#">An Event May Cause Other Actions to Occur</a> for more information.  Click <a href="#">here</a> to see the algorithm types available for this system event.
Event Cancellation	Optional	Use this system event for algorithms that are executed when an event is canceled.  Click <a href="#">here</a> to see the algorithm types available for this system event.

### Where Used

Follow this link to open the data dictionary where you can view the tables that reference [CI\\_SC\\_EVT\\_TYPE](#).

## Service Credit Examples

In this section, we provide examples of how to define your control tables to support functionality related to different types of service credit memberships. While your company may not define your environment exactly the same way, this section should help solidify your understanding of how to set up your company's service credit options.

## Defining Control Tables for a Refundable Fee

If your membership requires payment of a [fee](#) that is refundable, you must define an SA type to use for the refundable fee.

## Adjustment Type for Refundable Fee

This example assumes that the fee is set up similarly to a deposit. The adjustment used to charge the fee would affect the current balance, but not the payoff balance or the general ledger because the fee is not considered a "receivable", rather it is an amount collected and held for the customer.

Create an [adjustment type](#) for levying the fee. Indicate the fee amount and indicate the adjustment FT creation algorithm [ADJT-CA](#), which affects the current balance, but not the payoff balance or the general ledger.

---

**NOTE:**

**Adjustment Type Profiles.** Be sure to add this adjustment type to an appropriate [adjustment type profile](#) and ensure this profile is linked to your SA type.

---

## SA Type for Refundable Fee

Create an SA type to use for the fee. This SA type should be marked as not billable.

Indicate the appropriate adjustment type profile that includes the adjustment type to levy the fee.

Indicate an appropriate payment segment type that references the [PSEG-NM](#) payment segment FT algorithm. This algorithm affects the payoff amount and current amount by the payment amount, which should cause the current amount to become zero and the payoff amount to become a credit for the fee amount when the fee is paid.

## Start Option for Refundable Fee

For this SA type, define a start option that causes an adjustment to be levied as part of the start service process.

---

**FASTPATH:**

Refer to [Including The Membership Fee](#) on campaigns and packages for more information about levying the fee via the order transaction.

---

## Algorithm for Refunding the Fee

The base product provides an algorithm type [SAST-RF](#) that refunds a fee when [service agreements that contribute to the membership](#) are stopped. You must create an algorithm for this algorithm type and enter the SA type created above as an input parameter.

This SA stop algorithm must be plugged in on all SA types that you defined for the [membership type](#).

## Defining Control Tables for a Nonrefundable Fee

If your membership requires payment of a [fee](#) that is not refundable, you can set this up in two ways:

- You can create a special SA type to handle charging the fee. For this SA type, define a start option that causes an adjustment to be levied as part of the start service process. This adjustment contains your fee. You may use this option if the membership is related to multiple types of services and not all services need to be present in order to create the membership.

- You can levy an adjustment on one of the other service agreements that is being started. To do this, you would use a start option to define an adjustment to be levied as part of the start service process. You may use this option if the membership is related to a single service (for example, free pay-per-view movies).

For our example, we will set up the SA for the nonrefundable fee with a separate 'fee' SA type.

## Adjustment Type for Nonrefundable Fee

Create an [adjustment type](#) for levying the fee. Indicate the fee amount and indicate the adjustment FT creation algorithm [ADJT-NM](#), which affects the current balance and payoff balance by the adjustment amount, and affects the general ledger.

---

**NOTE:**

**Adjustment Type Profiles.** Be sure to add this adjustment type to an appropriate [adjustment type profile](#) and ensure this profile is linked to your SA type.

---

## SA Type for Nonrefundable Fee

Create an SA type to use for the fee. This SA type should be marked as not billable.

Indicate the appropriate adjustment type profile that includes the adjustment type to levy the fee.

Indicate an appropriate payment segment type that references the [PSEG-NM](#) payment segment FT algorithm. This algorithm affects the payoff amount and current amount by the payment amount, which causes the current amount to become zero and the payoff amount to become a credit for the fee amount when the fee is paid.

## Start Option for Nonrefundable Fee

For this SA type, define a start option that causes an adjustment to be levied as part of the start service process.

---

**FASTPATH:**

Refer to [Including The Membership Fee](#) on campaigns and packages for more information about levying the fee via the order transaction.

---

## Defining an SA Type for Miscellaneous Transactions

Does your membership require a [service agreement](#) to support miscellaneous transactions? If so, you need to consider the SA type to use for this service agreement. This SA type should be marked as not billable.

If you choose to use the order transaction to set up the membership, this SA type must be defined on the [algorithm that creates the membership](#).

It is possible that you may require a start option for this SA type, for example if you want to define a characteristic for service agreements of this type.

## Using Campaigns/Packages to Set Up Membership

If enrollment in a membership is a common occurrence for your customers when starting service, you should consider using the [order](#) page to start service for the customer and to create the membership as well.

---

**NOTE:**

This section only makes sense if you are familiar with the [Sales and Marketing](#) chapter.

---

The recommendation is to use a question/miscellaneous field to ask the customer service representative to indicate the appropriate membership type. Algorithms validate this membership type and use it to create a membership of that type.

This section walks you through how to set up the campaign / package required to support this.

## Column Reference for Membership Type

In order to ask the customer service representative to define an appropriate service credit membership type, you must define a column reference for the membership type.

Add a new column reference with the following information:

- Column Reference: SCM-TYPE
- Description: SC Membership Type
- FK Reference: SCM TYPE
- Long Description: Service Credit membership type to use when creating a service credit membership at start time.

---

**NOTE:**

**Column Reference Algorithms.** This column reference indicates a validation algorithm and a posting algorithm. However, we have not defined them yet so for now simply save this information.

---

## Algorithms to Create Membership via Order

The base product provides two algorithm types to support the creation of a membership record via the order page: a validation algorithm type and a posting algorithm type.

### Validate Membership Information

This algorithm is a column reference validation algorithm that checks that an input membership type is valid. Refer to [CRVL-ME](#) for more information. You must define an appropriate algorithm for this algorithm type, and on that algorithm you must define the column reference used to identify the membership type. For example:

- Algorithm: VAL MEM TYPE
- Description: Validate SC Membership Type
- Algorithm Type: CRVL-ME
- Parameter1: (Column Reference for Membership Type): SCM-TYPE

### Post Membership Information

This algorithm is a column reference posting algorithm that creates a membership using the membership type indicated by the user. Refer to [CRPS-ME](#) for more information. You must define an appropriate algorithm for this algorithm type, and on that algorithm you must define the column reference used to identify the membership type. For example:

- Algorithm: CREATE MEMBRSH
- Description: Validate SC Membership Type
- Algorithm Type: CRPS-ME
- Parameter1: (Column Reference for Membership Type): SCM-TYPE

- Parameter2: (Service Credit Membership Status): 10 -Pending or 20 -Active. Refer to [Lifecycle of a Membership](#) for more information.
- Parameters3-5: (Division, SA Type, Start Option): Indicate the information needed to create an SA for miscellaneous transactions.

---

**NOTE:**

This algorithm first looks for an existing service agreement of this division / SA type linked to the membership's accounts. If one exists, it uses that SA to link to the membership. If an SA does not exist, it creates one with the input division, SA and (optional) start option.

**Update the Column Reference.** Now that you have defined the validation and posting algorithms, return to your [column reference for membership type](#) and define the algorithms there.

---

Although your company may support multiple types of memberships, this column reference and its algorithms have been designed such that only one column reference for membership type would be needed to set up any type of membership. Although the posting algorithm for the membership type column reference indicates an SA type to use for miscellaneous transactions, a service agreement is only created and linked if your membership type indicates that an SA is required. As a result, you may use the same column reference for both memberships that require an SA and those that don't require an SA. However, if you have different membership types that require an SA and each uses a different SA type or a different start option for the membership SA, you need to define more than one posting algorithm and, as a result, more than one column reference.

## Define a Campaign for Creating a Membership When Starting Service

Many factors must be considered when [designing your campaigns and packages](#). The possible creation of a membership when using the order page is simply another factor to consider.

If you plan to define a question/miscellaneous field to capture a service credit membership type, the available packages linked to the campaign should be ones that are related to memberships. For example, if your membership is related to electric service, it doesn't make sense to create a membership for a campaign designed to generate a one-time charge.

When defining a question/miscellaneous field, you must indicate its applicability. Consider whether a membership type is required, optional or only applicable for certain packages. This helps ensure that your users capture this information when appropriate.

## Including the Membership Fee

You must determine the best way to setup your campaign/package to handle the levying of your membership fee, if applicable. Consider some of the following questions.

- If the membership has a fee, is it a refundable fee or a non-refundable fee?
- Is the fee always applicable for the membership? Or is it waived under certain conditions? For example, maybe the fee is applicable if a customer signs up for a single service, but the fee is waived if the customer signs up for two or more services.

The SCM type column reference and question/miscellaneous field are set up to ask the user what type of membership to create. Because the applicability of the fee may differ for each membership type, you should carefully consider the campaign / package setup to levy the fee correctly.

- If a fee is always applicable for a membership, you may consider creating a membership creation algorithm that creates a fee SA with a start option to levy the fee when the membership is created.

---

**NOTE:**



**Sample Algorithm.** The base product does not provide a membership creation algorithm to do this.

---

- If the fee is not always applicable for a membership, you must determine when the fee is applicable. The recommendation is to include the fee SA type in the SAs-to-create collection for the appropriate package. For example,
  - If the fee is applicable when the customer signs up for a single service, you should define a package for each single service that includes one SA to create for the single service and the fee SA as another SA to create.
  - If the fee is waived when the customer signs up for two or more services, you should define a package for each combination of the multiple services. These packages do not include the fee SA in the SAs to create.
- If the customer signing up for service is a former customer who has returned, perhaps the fee was paid earlier when the customer originally had service. In this case, maybe your business practice is to waive the fee at this time. To do this, you should set up a question/miscellaneous field for the user to mark that this is a returning customer. Based on the answer to this question, perhaps only packages that do not levy any fee are eligible for selection.

## Defining Another Person for Your Account

It is common for a capital credit membership to define more than one person for the account being turned on and linked to a membership. A typical example is a married couple. Both spouses are indicated on the account and financially responsible persons and as a result, both are considered [members](#).

Column reference algorithms have been provided by the base product to enable linking a second person to your account via the [order](#) page.

This section walks you through how to set up the column reference and campaign to support this.

---

**NOTE:**

**Linking A Second Person to the Account.** This logic is not restricted to service credit functionality. Any campaign may be designed to include the ability to link a second person to the account being started.

---

## Column References for Additional Person

In order to ask the customer service representative to link an additional person for the account, you must define several column references to use as questions/miscellaneous fields.

- We should assume that the person may already exist in the database. As a result, a question to record the person ID is needed.
- If the person does not already exist, the user should capture the person's name, an ID type and an ID number. Questions for these three fields are needed. The system uses this information to create a new person.
- Whether we are using an existing person or creating a new one, the person's link to the account must include an account relationship type. A question to record the account relationship type is needed.

Add a new column reference for person ID:

- Column Reference: PERSON-ID
- Description: Person ID
- FK Reference: PER
- Long Description: Person ID of the additional person to link to the order's account.

Add a new column reference for person name:

- Column Reference: PERSON-NAME

- Description: Person Name
- FK Reference: not applicable
- Long Description: Name of a new person to create.

Add a new column reference for identifier type:

- Column Reference: PER-ID-TYPE
- Description: Identifier Type
- FK Reference: ID TYPE
- Long Description: Identifier type for the primary ID of the additional person to link to the order's account.

Add a new column reference for identifier number:

- Column Reference: PER-ID-NUM
- Description: Person ID Number
- FK Reference: not applicable
- Long Description: Identifier number for the primary ID of the additional person to link to the order's account.

Add a new column reference for account relationship type:

- Column Reference: ACCT-REL-TYPE
- Description: Account Relationship Type
- FK Reference: ACCT REL
- Long Description: Relationship type to use for the link between the additional person and the order's account.

---

**NOTE:**

**Column Reference Algorithms.** One of the column references above must indicate a validation algorithm and a posting algorithm. However, we have not defined them yet so for now simply save this information. We recommend using the account relationship type record because that is used for all additional persons.

---

## Algorithms to Link Additional Person via Order

The base product has provided two algorithm types to support the linking of an additional person to the account via the order page: a validation algorithm type and a posting algorithm type.

### Validate Addition Person Information

This algorithm is a column reference validation algorithm which checks that either a person id or person name, a valid ID type and ID number are provided and that a valid account relationship type is provided. Refer to [CRVL-PE](#) for more information. You must define an appropriate algorithm for this algorithm type and on that algorithm you must define the column reference used for the five fields required for this validation. For example:

- Algorithm: VAL ADD PER
- Description: Validate Additional Person Info
- Algorithm Type: CRVL-PE
- Parameter1: (Column Reference for Person ID): PERSON-ID
- Parameter2: (Column Reference for Person Name): PERSON-NAME
- Parameter3: (Column Reference for Person ID Type): PER-ID-TYPE
- Parameter4: (Column Reference for Person ID Number): PER-ID-NUM

- Parameter5: (Column Reference for Account Relationship Type): ACCT-REL-TYPE

### Post Addition Person

This algorithm is a column reference posting algorithm that may link an existing person to the order's account or create a new person and link that person to the order's account. Refer to [CRPS-PE](#) for more information. You must define an appropriate algorithm for this algorithm type, and on that algorithm you must define the column reference used for the five fields required for this logic. For example:

- Algorithm: LINK ADDNTL PER
- Description: Link additional person to order's account
- Algorithm Type: CRPS-PE
- Parameter1: (Column Reference for Person ID): PERSON-ID
- Parameter2: (Column Reference for Person Name): PERSON-NAME
- Parameter3: (Column Reference for Person ID Type): PER-ID-TYPE
- Parameter4: (Column Reference for Person ID Number): PER-ID-NUM
- Parameter5: (Column Reference for Account Relationship Type): ACCT-REL-TYPE

---

**NOTE:**

**Update the Column Reference.** Now that you have defined the validation and posting algorithms, return to your [column reference for account relationship type](#) and define the algorithms there.

---

## Design a Campaign to Include Linking an Additional Person

Any campaign related to a specific account may include the questions and miscellaneous fields defined here to create/link an additional person to the account.

Simply create entries in the questions and miscellaneous fields collection to prompt the user to ask for the required information. A question should exist for each column reference created above. The following table illustrates a possible setup.

Seq	Description	Prompt on Order	Column Reference	Dependency
10	Account relationship type for additional person.	If you would like to link another person to this account, please enter an account relationship type.	ACCT-REL-TYPE	Must have account
20	Person ID for additional person	If the additional person already exists in the database, enter the person id.	PERSON-ID	Must have account
30	Person name for additional person	If you would like to create a new person, please enter the person name.	PERSON-NAME	Must have account
40	ID type for additional person	Please enter the ID type of the new person.	PER-ID-TYPE	Must have account
50	ID Number for additional person	Please enter the ID number of the additional person.	PER-ID-NUM	Must have account

---

## Service Credits Earned When Starting Service

For some memberships, you may want to add service credits when starting the program. For example, the customer gets three free pay-per-view movies when signing on for cable service. Or a customer receives 500 frequent flier miles for signing up for a combination of gas and electric service.

There are various ways that you can accomplish this. You should work with your implementers to consider the various options to determine the method that best suits your business practice.

- You could use an SA activation algorithm to create a membership and an event for the initial points. Use this method if the points are related to a single type of service agreement and the points are earned automatically when starting service (i.e., without any human decision to be made).
- You could use a membership creation or membership activation algorithm to generate a service credit event automatically. This method assumes that the decision to create the membership has been made and that the free initial points are always earned for this type of membership (i.e., regardless of the type of service created).
- You could use questions and miscellaneous fields for a campaign/package to determine a customer's eligibility for participation in the membership and for the initial free points. A column reference posting algorithm could create the membership and/or the service credit event for the free points based on the answers to the questions.
- Perhaps the initial free points are only earned after the first bill is generated. Use a bill completion algorithm to generate the initial points.

You may think of other plug-in spots that could be used to generate free initial points based on your business needs.

## Service Credits Earned Through Billing

For some memberships, you may accumulate points as a result of billed amounts for other services. For example, perhaps your customers earn one frequent flier mile for every \$10 spent on the combined electricity, gas and water bills each month.

To accomplish this, you must design an algorithm to be executed at billing time. There are various plug-in spots executed at billing time that you may use, but the recommended plug-in is a post completion algorithm on the customer class. This plug-in is executed after all bill segments are frozen and most of the completion logic has occurred.

Your algorithm should determine the [service agreements that contribute to the membership](#) and calculate the service credit amount for those service agreements bill segments.

This algorithm should also consider what to do when bill segments that contributed to the event are canceled. The algorithm provide with the base product [CBCM-SC](#) checks to see if any canceled bill segments are referenced on any previous events. If so, it includes the canceled amount on the new event. This may cause the new event to be a negative amount. The assumption is that over time, earned credits will compensate for the negative event amount. For a membership that [interfaces information to a third party](#), it is assumed that the negative event amount is also interfaced.

## Service Credits Redeemed Through Billing

For some memberships, your customer may redeem their earned points by receiving a discount on their bill. For example, if your cable customer has earned one free pay-per-view movie, you can give them a credit the next time they get billed for a pay-per-view movie.

The base product has not provided any algorithms to credit a bill based on earned service credits. This section will identify considerations your implementers should follow when designing algorithms to redeem service credits through billing.

The recommendation is to credit the customer's bill by generating an adjustment using a pre-bill completion algorithm. This algorithm's responsibilities are as follows:

- Determine if the appropriate bill segment(s) contain the charges that need to be credited. For example, if the service credit is for a free pay-per-view movie, determine if the customer has been billed for a pay-per-view movie.
- Determine if the customer's current service credit balance for this program. For example, how many free pay-per-view movie credits are left?
- Create an adjustment to credit the appropriate service agreement by the eligible credit amount.
- Update the service credit membership balance by creating a new SC event with a credit for the number of points redeemed. Link the adjustment to the event as a contributed to FT.
- Consider cancel/rebill situations. If a cancel/rebill has occurred, determine if there is a change to the redeemed credits. For example, if the original bill had one pay-per-view movie that was credited and the new bill also has one pay-per-view movie, no change is needed to the service credit balance. If the original bill had more pay-per-view movies than the new bill, perhaps one or more redeemed service credit points should be reinstated. If the original bill had fewer pay-per-view movies than the new bill, perhaps more points should be redeemed.

You may wonder why we don't recommend crediting the customer's bill while generating the bill segment. For example, use pre-processing calculation rule to determine if any points should be redeemed and use a calculation rule to generate a bill calculation line with the credit amount.

The reason for this is that cancel/rebill logic is not straightforward. Algorithms executed during rate application should NOT perform any updates, such as updating the service credit membership balance. The balance should be updated using a bill segment freeze algorithm or a bill completion algorithm.

When a cancellation occurs, the service credit balance should be updated to reinstate the redeemed points. Again, this should occur when the cancellation is frozen or at bill completion time. If you perform a cancel/rebill, the calculation of the rebill segment does not have the up-to-date information about the service credit balance because the reinstatement of the points by the canceled segment has not occurred yet.

## Designing Your Rate Options for Capital Credits

The capital credit allocation background process relies on certain data configuration in order to function correctly. This section identifies the required data setup.

---

**FASTPATH:**

Refer to [Allocating Capital Credits](#) for more information.

---

## Identifying SQ and Sales Information for Historical Bill Segments

To allocate capital credits, the background process retrieves billing history for each SA that contributes to the membership for the given fiscal year. The process needs to calculate the service quantity (SQ) amount billed and the sales amount billed for the SA in that year.

---

**NOTE:**

**Sales Amount.** The sales amount refers to the monetary amount billed. For a capital credit allocation, this amount would generally exclude taxes and may exclude other line item amounts from the bill.

---

In order to calculate the amounts correctly, the background process must determine which bill calculation lines for each bill segment contain the SQ and/or sales information. Characteristics on the bill calculation lines identify which bill lines should be used.

The rest of this section uses examples to illustrate how you may configure your rate options to support this.

## Define Characteristics for SQ and Sales

Char Type for identifying bill lines that hold **SQ information**

- Char Type: CCA-SQ
- Description: Capital credit allocation usage
- Type of Char: Pre-defined
- Values: Y
- Char Entities: Calculation Rule, Bill Calculation Line

Char Type for identifying bill lines that hold **sales information**

- Char Type: CCA-SALES
- Description: Capital credit allocation sales
- Type of Char: Pre-defined
- Values: Y
- Char Entities: Calculation Rule, Bill Calculation Line

## Define Calculation Rules

Identify each rate schedule that may be linked to a service agreement that contributes to a capital credit membership.

For each of these rate schedules, identify the calculation rules whose resulting bill calculation line will contain a billable service quantity that should be included in the SQ calculation for allocating capital credits. For each calculation rule that qualifies, define the CCA-SQ char type (defined above) and a char value of Y.

For each rate schedule, identify the calculation rules whose resulting bill calculation line amount should be included in the sales calculation for allocating capital credits. For each calculation rule that qualifies, define the CCA-SALES char type (defined above) and a char value of Y.

---

### NOTE:

**Characteristic Information.** The system automatically copies characteristic info from a calculation rule to its resulting bill calculation line if the char type entities include both calculation rule and bill calc line.

---

## Define Batch Control Parameters

The background process to allocate capital credits **CPCRALOC** receives the char type and char value to identify the bill calculation lines that contain the SQ and sales amounts. Once you have your characteristics defined, update your batch control to include these values as default parameter values.

## Designing Bill Factors for Credit Allocation

The **capital credit allocation** process uses an allocation factor in its calculation. A typical capital credit membership may define multiple subcategories, meaning that allocation amounts are calculated each year for the multiple subcategories. The calculation is the same for each subcategory, but the allocation factor differs.

The process has been designed to calculate the allocation for a single subcategory. If your organization requires allocations calculated for multiple subcategories, the process must be run for each subcategory. The allocation process receives a bill factor as an input parameter. As a result, a different bill factor should be set up to define the allocation factor for each subcategory.

For each subcategory, the allocation factor may differ further for the type of customer. For example, the allocation for a commercial customer may differ from the allocation factor for a residential customer. The allocation background process expects the bill factor for each subcategory to define a characteristic type of revenue class. The process determines each service agreement's revenue class by looking at the value defined on its SA type.

Following is an example of bill factors set up for a capital credit membership with two subcategories: transportation and generation.

## Characteristic Type for Allocation Bill Factor

Char Type: REV-CLASS

Description: Revenue Class

Type of Char: Pre-defined

Values: (define all the valid revenue class values)

Char Entity: Bill Factor

## Bill Factor for Transportation

Bill Factor Id: CCAF-TRANS

Description: Transportation Allocation Factor

Char Type: REV-CLASS

Char Source: Characteristic Collection

Char Values: (for each year, the new transportation allocation factor for each revenue class must be defined)

## Bill Factor for Generation

Bill Factor Id: CCAF-GEN

Description: Generation Allocation Factor

Char Type: REV-CLASS

Char Source: Characteristic Collection

Char Values: (for each year, the new generation allocation factor for each revenue class must be defined)

---

### NOTE:

**The characteristic source is characteristic collection.** It is the responsibility of the background process to determine the SA's revenue class and to pass this value into the bill factor routines to retrieve the correct bill factor value.

**Estimating Allocation Factors.** Often the company needs to estimate the allocation factors for the new fiscal year and may adjust the values several times until the calculated allocation amounts are satisfactory. Refer to [Allocating Capital Credit](#) for more information.

---

## Partial Retirement

In the cooperative business, it is common to never retire certain capital credit allocation amounts. The amounts that do not retire should be assigned their own subcategory.

When executing the retirement background process, the subcategory to retire may be input to the process. If you have certain subcategories that you do not retire, you would simply run the background process for the subcategories that do retire.

Cooperatives typically retire amounts and transfer the amounts to a beneficiary when a member dies. This is known as "estate retirement". Refer to [Service Credits for Capital Credit Memberships](#) for more information. If your business practice designates that certain subcategories of allocated amounts do not get retired, this probably holds true for estate retirement as well. If that is the case, your membership inactivation algorithm should be designed to only retire the appropriate amounts by subcategory.

## Interface Membership Information to a Third Party

For some memberships, you may accumulate points for a third party, for example accumulating frequent flier miles for an airline. For these types of memberships, you must interface the event information to the third party.

To interface information to a third party, you may choose one of the following options:

- Design an extract program to interface the information
- Use workflow and notification to interface the information via the XAI tool

## Interface Via an Extract Program

The service credit event may indicate a batch code and batch run number. Design a program to extract event information to a third party. This extract program would select service credit events marked with its batch code and the current run number.

Your service credit event must define a completion algorithm that stamps the appropriate batch code and run number. The base product provides an algorithm type to perform this logic. Refer to [SCEC-BT](#) for more information.

## Other Considerations For Interfacing Info to a Third Party

Because event information is extracted to a third party, you must consider how to handle adjustments to the event amount. For example, if your event is generated based on the creation of a bill segment, what should happen if that bill segment is cancelled?

You may want to prevent these types of events from getting canceled. Validation like this may be added via a user exit or using an event cancellation algorithm.

---

**NOTE:**

**Sample Algorithms.** The product does not provide any base algorithms to prevent an event from being canceled.

---

You should allow negative event amounts to be created so that this information may also be sent to the third party's system.



# Defining Loan Options

The topics in this section describe how to set up the system to enable loan functionality.

---

**NOTE:**

**Loans are optional.** The system configuration requirements described in this section are only relevant if your organization loans money to customers.

---

## The Terms Of A Loan Are Stored On A Service Agreement

Loans are initiated by creating a loan service agreement for a customer. The loan service agreement (and its SA Type) contains the loan's terms:

- The **loan amount** is held in the service agreement's Total Amount to Bill.
- The **customer's periodic payment amount** is held in the service agreement's Recurring Charge Amount.
- The **number of amortization periods** (e.g., 36 months, 240 months, etc.) is held in the service agreement's Number of Payment Periods.
- If the **interest rate** is the same for all customers with this type of loan service agreement, the interest rate is defined on the service agreement's SA type (using a bill factor). A specific interest rate can be defaulted from a start option contract value. If a specific interest rate applies to the customer, the SA type's interest rate can be overridden by specifying a bill factor value on the customer's service agreement (where the bill factor value contains the specific interest rate for the customer).
- The SA type controls the **periodicity of the bills** (e.g., monthly or bi-weekly).

Because a loan is defined using a service agreement, the typical functionality that is controlled by the service agreement's SA type is supported, including:

- How and when it is billed.
- How payments are booked in the GL (and the payment priority relative to other service agreements).
- How its debt is monitored by credit and collections.
- How late payment charges are calculated.

Loan service agreements are created using [Start/Stop](#) just like all other service agreements. The start/stop transaction has special loan functionality that allows an operator to specify the service agreement-specific loan terms described above. A start option can be specified to override the SA type's interest bill factor.

---

**NOTE:**

**Automatic calculation of periodic payment amount / number of periods.** The system calculates a loan's periodic payment amount or number of payments (whichever is left blank). You can have the system do this on [Start/Stop Maintenance](#) (using the **Calculate** button that appears on the [start service confirmation window](#) ), and on [Loan - Main](#) (by clicking the **Calculate** button). Regardless of where you do this, the calculation is performed by an algorithm on the loan's SA type. Refer to the [LPDA-SI](#) algorithm type for more information about the base package algorithm.

---

## Payoff Balance and Current Balance for Loans

As described under [Current Amount versus Payoff Amount](#), a loan service agreement's current balance and payoff balance differ during the lifetime of the loan. Current balance contains how much the customer owes to remain current (typically their periodic payment amount), and payoff balance contains the amount the customer would have to pay to payoff the loan (typically the principal balance plus any accrued interest charges).

Unlike other SAs, loans have two accounts receivable distribution codes: long term and short term. These two codes allow the general ledger to differentiate between unbilled loan receivables (long term) and billed loan receivables (short term). The current balance for a loan is always the amount of the short-term receivables. The payoff balance for a loan is always the net of the short-term receivables and the long-term receivables.

If the SA has a [special role](#) of Loan, the financial transaction algorithms supplied with the base package transfer the current amount between the long-term receivables and the short-term receivables in the GL. For example, when a bill segment is generated for the loan SA, the amount of the periodic payment is transferred from the long-term receivables to the short-term receivables. Don't worry, the examples in the following sections show exactly what these transactions look like.

An operator can see the how the bills, payments and adjustments have affected the GL, current balance and payoff balance using [SA Financial History](#).

The following sections provide examples of how adjustments, bills and payments are recorded in the GL and the subsequent effect on the current and payoff balances. When reading the examples, remember that the payoff balance is always the net of the short-term receivable and the long-term receivable balances.

## Booking The Principal Amount Using An Adjustment

When a loan service agreement is activated (i.e., when its status changes from pending start to active ), an adjustment is created to book the principal amount. If the customer takes out a loan of 10,000, the adjustment's financial transaction looks as follows:

Event	GL Accounting	Effect On Current Balance	Effect On Payoff Balance	Current Balance	Payoff Balance
Loan service agreement is activated (and an adjustment is created to book the principal)	Long Term Loan Receivable 10,000 Cash <10,000>	0	10,000	0	10,000

This adjustment is issued if:

- The service agreement's SA type indicates a [special role](#) of Loan.
- The loan service agreement's Total Amount to Bill contains an amount (i.e., the loan amount).
- The loan service agreement was created using a [start option](#) on [Start/Stop Maintenance](#) AND the start option references an [adjustment type](#) and this adjustment type has been set up as follows:
  - The adjustment type's distribution code should reference the GL account to credit (e.g., Cash).
  - The adjustment type's FT algorithm reference  $\text{Payoff Amt} = \text{Adj Amt} / \text{Current Amt} = 0$  (booking principal only impacts a customer's payoff balance).

Note that because this financial transaction doesn't have a current amount (the customer doesn't actually owe a current amount yet), there is no need to book anything to the short-term receivables distribution code.

## Loan Amortization Schedule Calculation

The amortization schedule is a projection of the amount of principal and interest in each payment over the life of the loan. The amortization schedule may change, for example if the interest rate changes or the customer makes an overpayment (reducing the principal balance).

A loan's amortization schedule is calculated when an operator clicks the **Calculate** button on [Loan - Main](#). Please be aware that when this button is clicked, an algorithm plugged in on the loan [SA type](#) actually calculates the amortization schedule (refer to the algorithm type [LSCH-SI](#) for more information).

## Billing For Loans And Interest Calculation

A bill segment is produced for a loan when its service agreement's account is next billed.

Factors on a loan's SA type controls when a bill segment is produced for a loan. Typically SA types for loan service agreements are set up to use anniversary [calendar billing](#). For this configuration:

- You must indicate the type of anniversary billing in the calendar billing option. Currently, we only support the Anniversary Future Billing (meaning that loans are billed in advance just like a classic home loan is). Refer to [Using The Anniversary Method](#) for more information about how this billing method controls the end date of the loan bill segment.
- You must reference an [anniversary billing frequency](#) consistent with the [recurring charge frequency](#) (e.g., monthly, quarterly, etc.).

To set up for a loan that is billed on a monthly basis, you would define the following fields in SA Type - Billing:

- **Use Calendar Billing:** Anniversary Future Billing
- **Anniversary Bill Frequency:** Monthly
- **Total Bill Amount:** Required
- **Recurring Charge:** Required
- **Recurring Charge Frequency:** Monthly
- **Total Amount To Bill Label:** Loan Amount
- **Recurring Chg Amt Label:** Payment Amount

If your type of loan must be billed on an exact date (for example, always on the 15th of the month) or with an exact number of days between each bill (for example, every 14 days), then your loan should be set up to use the calendar billing option of Use Bill Period. In order for your loan bills to be created on specific dates, the system makes the following assumptions:

- Your [bill cycle schedule](#) for the loan's account is defined with the dates that you want the loan to bill and is defined with the window start date equal to the window end date.
- You define a [bill period](#) schedule corresponding to your bill cycle schedule. Each bill period schedule's bill date should match your bill cycle window start date and each bill period schedule's bill segment end date should be set to the loan period end date.
- Considerations for the first bill. If the loan SA Type's Initial Start Date Option indicates that the first day of the service agreement should be billed, then the loan SA's start date should match the window start date of the next bill cycle schedule for the account. If the loan SA Type's Initial Start Date Option indicates that first day of the service agreement should not be included, then the loan SA's start date should be one day prior to the window start date of the next bill cycle schedule for the account.
- Define your [recurring charge frequency](#) to match the frequency of your bill periods.

How the bill segment affects the customer's balance, and how it affects the general ledger are controlled by several algorithms defined on the loan service agreement's [SA type](#) and [bill segment type](#):

- The SA type's loan schedule algorithm controls how the [loan amortization schedule](#) is calculated.
- The SA type's loan interest charge algorithm controls how interest is calculated.
- The bill segment type's create algorithm controls how the bill lines are constructed.
- The bill segment type's financial algorithm controls how the general ledger is affected by the bill.

The second entry in the following table contains an example of the financial transaction produced by the base package algorithms (note, the first financial transaction in the table was described under [Booking The Principal Amount Using An Adjustment](#) ).

Event	GL Accounting	Effect On Current Balance	Effect On Payoff Balance	Current Balance	Payoff Balance
Loan service agreement is activated	Long Term Loan Receivable 10000 Cash <10000>	0	10,000	0	10,000 long-term: 10,000
First bill segment is produced	Interest: Long Term Loan Receivable 41.66 Interest Revenue <41.66> Transfer Long Term To Short Term: Short Term Loan Receivable 438.71 Long Term Loan Receivable <438.71>	438.71	41.66	438.71	10,041.66 short-term: 438.71 long-term: 9,602.95

Several important points are illustrated above:

- When a bill segment is produced for a loan service agreement, the following takes place (if you use a bill segment creation algorithm of Create Bill Segment for Loans ):
  - The loan SA type's bill segment creation algorithm calls the SA type's loan interest charge algorithm.
  - The base package loan interest charge algorithm calculates simple interest based on: 1) unbilled principal (i.e., the service agreement's payoff balance minus the current balance), 2) the number of billing periods covered by the bill, and 3) the [interest rate](#). Refer to the algorithm type [LINT-SI](#) for more information about the base package interest calculation algorithm.

**NOTE:**

**No interest on interest and no interest on past due amounts.** Just like a classic home loan, the base package algorithms do not calculate interest on interest, nor do they calculate interest on past due amounts. If you want to levy a late payment charge, use the SA type's late payment processing. If your organization calculates interest differently, you must develop your own algorithm(s).

- The SA type's bill segment creation algorithm uses the calculated interest to format the bill segment's bill lines. It creates one bill line to show the amount of interest in the payment, and another bill line to show the amount of principal. The principal amount is equal to the service agreement's periodic payment amount minus the amount of calculated interest.
- The financial transaction illustrated above is created if you use a bill segment financial algorithm of Payoff Amt = Interest / Current Amt = Bill Amount on the loan's bill segment type. The following explains how this algorithm works:

- The SA's current balance increases by the amount of the loan's periodic payment amount (i.e., its recurring charge amount). In other words, the amount the customer thinks they owe increases by 438.71.
- The SA's payoff balance increases by the amount of interest. In other words, if the customer wanted to payoff the loan, they'd owe 10,041.66.
- The *Interest* portion of the GL accounting is straightforward (if you're an accountant). It simply takes the amount of interest and debits it to the SA type's receivable distribution code (long-term receivables) and credits it to the distribution code defined on the interest rate's bill factor (typically interest revenue).
- The *Transfer* portion of the GL accounting transfers moneys from long-term receivables (i.e., the unbilled principal) to short term receivables (the billed portion of the debt). The amount transferred is equal to the FT's effect on the service agreement's current balance, allowing the general ledger to differentiate between unbilled loan receivables (long term) and billed loan receivables (short term). Remember that the payoff balance is the net of the short-term and long-term receivables.

## Paying What Is Owed

When a payment is made for a loan:

- The service agreement's payoff amount is reduced by the payment amount.
- The service agreement's current amount is reduced by the payment amount.

The events that happen when a customer makes a payment against a loan is controlled by the FT algorithm plugged in on the loan service agreement's payment segment type. We'll use an example to help explain how this algorithm works. The 3<sup>rd</sup> entry in the following table illustrates the financial transaction produced when a payment is made (note, the first two financial transactions were described above).

Event	GL Accounting	Effect On Current Balance	Effect On Payoff Balance	Current Balance	Payoff Balance
Loan service agreement is activated	Long Term Loan Receivable 10000	0	10,000	0	10,000
	Cash <10000>				long-term: 10,000
First bill segment is produced	Interest:	438.71	41.66	438.71	10,041.66
	Long Term Loan Receivable 41.66				short-term: 438.71
	Interest Revenue <41.66>				long-term: 9,602.95
	Transfer Long Term To Short Term:				
	Short Term Loan Receivable 438.71				
	Long Term Loan Receivable <438.71>				
Payment is made	Affect Cash	-438.71	-438.71	0	9,602.95
	Cash 438.71				short-term: 0
	Long Term Loan Receivable <438.71>				long-term: 9,602.95
	Transfer Long Term To Short Term:				

Long Term Loan  
 Receivable 438.71  
 Short Term Loan  
 Receivable <438.71>

The financial transaction illustrated above is created if you use a payment segment FT creation algorithm of Payoff Amt = Current Amt = Pay Amt on the loan's payment segment type. The following explains how this algorithm works:

- The SA's current balance decreases by the amount of the payment amount. In other words, the customer thinks they owe 0 after the payment. Note refer to [Overpayments](#) for information about how an overpayment affects the SA's balances and the general ledger.
- The SA's payoff balance decreases by the amount of the payment. In other words, if the customer wanted to payoff their loan, they'd owe 9,602.95.
- The *Cash* portion of the GL accounting is straightforward (if you're an accountant). It simply takes the amount of the payment and debits it to the payment segment type's distribution code (typically cash) and credits it to the SA type's receivable distribution code (long-term receivable).
- The *Transfer* portion of the GL accounting effectively reduces short-term receivables by the FT's effect on the customer's current balance. This reduction is handled by an offsetting increase to long-term receivables (to make up for reduction made when the cash was applied). Again, this differentiation between short-term and long-term receivables allows the general ledger to differentiate between unbilled loan receivables (long term) and billed loan receivables (short term).

## Overpayments On Loans

You can determine whether you want to accept loan overpayments. Overpayments reduce the principal amount (the amount owed on the loan), which follows the philosophy adopted by a typical home loan.

When the payment is made, any overpayments are distributed according to the overpayment distribution algorithm defined for the customer class. Any customer classes for which you want to allow loan overpayments should use an overpayment distribution algorithm that keeps the overpayment on the loan SA.

When the payment transaction is frozen, the system checks to see if there is a credit amount on the loan SA's current balance. If a credit exists, the customer has made an overpayment and an adjustment is created to zero out the current balance and transfer the amount of the credit from the SA's short-term receivable to long-term receivable. The adjustment may appear on the customer's next bill to show the additional amount paid against the principal.

The algorithm that controls this adjustment to remove the credit on current balance is plugged in on the loan service agreement's SA type and is applied on the SA Type - Payment Freeze system event.

The third and fourth entries in the following table illustrate an overpayment (note, the first two financial transactions were described above).

Event	GL Accounting	Effect On Current Balance	Effect On Payoff Balance	Current Balance	Payoff Balance
Loan service agreement is activated	Long Term Loan	0	10,000	0	10,000
	Receivable 10000				
	Cash <10000>				
First bill segment is produced	Interest:	438.71	41.66	438.71	10,041.66
	Long Term Loan				short-term: 438.71
	Receivable 41.66				long-term: 9,602.95
	Interest Revenue <41.66>				

	Transfer Long Term To Short Term: Short Term Loan Receivable 438.71 Long Term Loan Receivable <438.71>				
Payment is made (with an overpayment of 200.00)	Affect Cash Cash 638.71 Long Term Loan Receivable <638.71> Transfer Long Term To Short Term: Long Term Loan Receivable 638.71 Short Term Loan Receivable <638.71>	-638.71	-638.71	-200.00	9,402.95 short-term: <200.00> long-term: 9,602.95
Create adjustment to remove SA's credit.	Transfer Short Term Credit to Long Term: Short Term Loan Receivable 200.00 Long Term Loan Receivable <200.00>	200.00	0	0	9,402.95 short-term: 0 long-term: 9,402.95

In the third financial transaction illustrated above, the billed amount of the payment works essentially the same as that illustrated under [Paying What Is Owed](#). If the Keep Overpayment on Loan SA algorithm is plugged in on the overpayment distribution event on the customer class, the overpayment amount is applied to the loan SA, creating a credit on the SA's current balance. The following explains how this algorithm works:

- If the account has an loan SA and there is an excess credit, the credit is applied to the loan SA (as long as this does not cause the loan SA to have a credit payoff balance).
- If there is not a loan SA to which the credit can be applied, the algorithm checks to see if there is an open excess credit SA for the account.
  - If so, the excess credit amount is applied to the excess credit SA.
  - If not, the algorithm creates an excess credit SA and applies the amount to this SA.

The fourth financial transaction illustrated above is created if the Create Adjustment to Remove SA's Credit algorithm is plugged in on the loan's SA type's payment freeze event. The following explains how this algorithm works:

- If the SA's current balance is less than zero, the algorithm creates a frozen adjustment that removes the credit by transferring the credit from the short-term receivable to the long-term receivable. This adjustment ID is captured on the pay segment so the adjustment can be canceled if the payment is later canceled. Note that the adjustment cancel reason used by the system in this case is specified on the Financial Transaction Options [Feature Configuration](#) using the Adjustment Cancel Reason For Payment Linked To Adjustment option type.
- The SA's current balance increases by the amount of the credit transfer. In other words, the customer thinks they owe 0 after the transfer.
- The SA's payoff balance doesn't change because the payoff balance is always the net of the short-term and long-term receivables. In other words, if the customer wanted to payoff their loan, they'd still owe 9,402.95.

---

**NOTE:**

**Overpayments and interest.** The base package interest calculation algorithm (plugged in on the loan's SA type) does not take into consideration the exact date that the overpayment is made when calculating the interest for the period. It only takes into consideration the outstanding principal amount (payoff balance - current balance) at the time of the interest calculation.

---

## Adjusting Loan Amounts

You would issue ad hoc adjustments if you need to change a loan's payoff and/or current balance outside of the normal billing / payment functions.

An adjustment can:

- Reduce a loan's payoff balance.
- Reduce a loan's current balance (i.e., how much the customer thinks they currently owe).
- Reduce both the loan's payoff and current balance.

For adjustments that affect payoff amount only:

- These adjustments are used to change the principal owed, e.g., if an additional amount is loaned.
- The adjustment's adjustment type should reference the Payoff Amt = Adj / Current Amt = 0 FT algorithm.
- GL lines will be generated to reflect the change to principal.

For adjustments that reduce current amount only:

- These adjustments can be used to change the amount that the customer must pay as part of the next bill.
- The adjustment's adjustment type should reference the Payoff Amt = 0 / Current Amt = Adj Amount (no GL) FT algorithm.
- Typically, GL lines are not generated for FTs that only affect the customer's current balance. However, moneys must be transferred from long to short in the amount of the adjustment (as described above under [Payoff Balance and Current Balance for Loans](#)).

For adjustments that reduce both payoff and current amount:

- These adjustment types can be used to levy additional charges, such as late fees, or to correct interest calculations.
- The adjustment's adjustment type should reference the Payoff Amt = Adj / Current Amt = Adj FT algorithm.
- GL lines are generated to reflect the change to principal. In addition, GL lines must be generated to transfer money from long to short in the amount of the adjustment (as described above under [Payoff Balance and Current Balance for Loans](#)).

---

**NOTE:**

Adjustments that affect the principal balance (payoff balance - current balance) affect the term of the loan because interest is based on the principal balance.

**Adjustments can cause credit balances to exist.** If you credit the loan SA, it is possible for the current balance to become negative. You may need to create additional adjustments that affect the current amount, depending on whether the customer needs to pay this amount as part of the next payment.

---

## Writing Off Loans

Loans are written off using the standard write-off processing.

---

**FASTPATH:**



Refer to [The Big Picture Of Write Off Processing](#) for background information.

We illustrate the classic financial transactions that transpire to financially write-off a loan to help illustrate important points (these are the fourth and fifth entries in the following table):

Event	GL Accounting	Effect On Current Balance	Effect On Payoff Balance	Current Balance	Payoff Balance
Loan service agreement is activated	Long Term Loan	0	10,000	0	10,000
	Receivable 1000				long-term: 10,000
	Cash <1000>				
First bill segment is produced	Interest:	438.71	41.66	438.71	10,041.66
	Long Term Loan				short-term: 438.71
	Receivable 41.66				long-term: 9,602.95
	Interest Revenue <41.66>				
	Transfer Long Term To Short Term:				
	Short Term Loan Receivable 438.71				
Payment is made (with an overpayment of 200.00)	Long Term Loan Receivable <438.71>				
	Affect Cash	-638.71	-638.71	-200.00	9,402.95
	Cash 638.71				short-term: <200.00>
	Long Term Loan Receivable <638.71>				long-term: 9,602.95
	Transfer Long Term To Short Term:				
	Long Term Loan Receivable 638.71				
Create adjustment to remove SA's credit.	Short Term Loan Receivable <638.71>				
	Transfer Short Term Credit to Long Term:	200.00	0	0	9,402.95
	Short Term Loan Receivable 200.00				short-term: 0
	Long Term Loan Receivable <200.00>				long-term: 9,402.95
Sync up current with payoff balance	Transfer Long Term To Short Term:	9,402.95	0	9,402.95	9,402.95
	Short Term Loan Receivable 9,402.95				short-term: 9,402.95
	Long Term Loan Receivable <9,402.95>				long-term: 0
Transfer balance to a write-off SA	Transfer From Loan SA:	-9,402.95	-9,402.95	0	0

Write Off Xfer  
Clearing 9,402.95

Long Term Loan  
Receivable  
<9,402.95>

Long Term Loan  
Receivable 9,402.95

Short Term  
Loan Receivable  
<9,402.95>

Transfer To Write Off  
SA:

Bad Loans Expense  
9,402.95

Write Off Xfer  
Clearing <9,402.95>

Note, these will  
cause a balance of  
9,402.55 to exist on  
the write-off service  
agreement.

---

The only unusual portion of the last two financial transactions is the impact on short and long term receivables. Please see the examples above under [Billing For Loans And Interest Calculation](#) and [Paying What Is Owed](#) to understand how any impact to a loan's current balance causes this type of financial transfer to occur.

## Distribution Codes for Loans

As explained above under [Payoff Balance and Current Balance for Loans](#), loans have two accounts receivable distribution codes: long term and short term. These two codes allow the general ledger to differentiate between unbilled loan receivables (long term) and billed loan receivables (short term). Both receivables distribution codes are defined on the loan SA type.

In addition, loans have a distribution code used to book interest revenue. The interest revenue distribution code is defined on the loan's bill factor value for a revenue class (defined on the loan's SA type). For example, on the bill factor you can use one distribution code to book interest revenue from the residential revenue class and another distribution code to book interest revenue from the commercial revenue class. In this example, you create two loan SA types, one for residential revenue and the other for commercial revenue.

Loans may also have a bad loan debt (expense) distribution code that is used when writing off a loan. The bad loan debt distribution code is defined on the loan's write-off service agreement type. Refer to [Defining Credit & Collections Options](#) for more information.

## Setting Up The System To Enable Loans

The above topics provided background information about how loans are supported in the system. The following discussion summarizes the various setup tasks alluded to above.

## Distribution Code

You must set up the following [distribution codes](#):

- Long term receivables
- Short term receivables
- Interest revenue
- Bad loan debt

## Adjustment Types

The following adjustment types are needed:

- Activate a loan. This should reference a distribution code associated with cash or the cash equivalent and an FT algorithm of  $\text{Payoff Amt} = \text{Adj} / \text{Current Amt} = 0$ .

---

**NOTE:**

**Creating Checks for Loan Amounts.** If you want the system to initiate a check to the customer for the loan amount, the loan activation adjustment type should indicate an **A/P Request Type Code**. Refer to [Controls The Interface To A/P & 1099 Reporting](#) for more information.

---

- Remove Credit (Overpayment). This adjustment should reference an FT algorithm of  $\text{Payoff Amt} = 0 / \text{Current Amt} = \text{Adj Amount}$  (no GL). Even though this algorithm indicates that there is no effect on the GL, there is a special exception built in for loan SAs. The special exception creates GL details to transfer the current balance (short-term receivable) to the long-term receivable. Refer to [Overpayments](#) for more information.

---

**NOTE:**

**Printing Overpayments on Bills.** If you want the overpayment adjustment to appear on customers' bills, turn on **Print by Default** and enter a **Description on Bill** (e.g. "Additional Principal"). For more information, refer to [Controls Information Printed On The Bill](#).

---

- Adjustment types to perform any of the adjustments described under [Adjusting Loan Amounts](#).

## Adjustment Type Profile

Create an adjustment type profile that references the adjustment types used on a loan. Besides the above adjustment types, it should also reference adjustment types to levy late payment charges (if applicable), levy non-sufficient funds charges (if applicable), refund overpayments (if applicable), sync current balance with payoff balance at write-off time, transfer balances to a write-off service agreement, and write-down small balances.

## Algorithms

Add the following [algorithms](#):

- Overpayment Distribution. This algorithm is later plugged in on the customer class for the Overpayment Distribution system event. Refer to the algorithm type [OVPI-LO-CSA](#) for more information about the base package algorithm.

- Bill Segment Creation for Loans. This algorithm is later plugged in on the loan's bill segment type. Refer to the algorithm type [BSBS-LO](#) for more information about the base package algorithm.
- Bill Segment Financial Transaction Creation for Loans. This algorithm is later plugged in on the loan's bill segment type. Refer to the algorithm type [BSBF-LO](#) for more information about the base package algorithm.
- Amortization Schedule. This algorithm is later plugged in on the SA type for the Loan Schedule system event. Refer to the algorithm type [LSCH-SI](#) for more information about the base package algorithm.
- Interest Calculation. This algorithm is later plugged in on the SA type for the Loan Interest Charge system event. Refer to the [LINT-SI](#) algorithm type for more information about the base package algorithm.
- Payment Periods/Payment Amount Calculation. This algorithm is later plugged in on the SA type for the Loan Periods and Amount system event. Refer to the algorithm type [LPDA-SI](#) for more information about the base package algorithm.
- Loan SA Payment Freeze. This algorithm has a parameter that must reference the Remove Credit adjustment type defined above. This algorithm is later plugged in on the SA type for the Payment Freeze system event. Refer to the algorithm type [STPZ-RMVCR](#) for more information about the base package algorithm.

## Bill Factor

You must set up a [bill factor](#) that defines the interest rate. If you have different interest rates for different types of loans, you can create a separate bill factor for each or you can use start options to override the interest rate.

On the bill factor's [bill factor value](#), make sure to reference the GL distribution code used to book interest revenue for the revenue class specified on the loan's SA type.

## Customer Class

Any [customer class](#) on which you want to allow overpayments for a loan must use the overpayment distribution algorithm defined above. The overpayment distribution algorithm keeps the overpayment on the loan SA rather than transferring it to an excess credit SA, allowing a subsequent adjustment to apply the overpayment to the principal balance.

## Bill Segment Type

Create a bill segment type that references the bill segment creation algorithm defined above and the FT creation algorithm defined above.

## Frequency

Create [frequency](#) codes to correspond to the frequency of your loans. When setting up your SA types, you must indicate a recurring charge frequency and, if you use the Anniversary Billing Option, you must indicate an anniversary frequency.

## Bill Period

If you use the Use Bill Period option, set up a bill period with an appropriate schedule of dates for billing your loan.

## Bill Cycle Schedule

If you use the Use Bill Period option, the bill cycle schedule for these types of loans should be defined with an appropriate schedule of dates for billing your loan.

## Collection, Severance and Write Off Processes

You should set up the appropriate credit and collections information. Refer to [Defining Credit & Collections Options](#) for more information.

## SA Type

You must set up a [SA type](#) for your loan service agreements (you may need multiple SA types if you have different business rules for different types of loans). The following points describe the minimal requirements for a loan SA type.

### SA Type - Main

Define the following options:

- **Distribution Code** should be a long-term receivable code.
- **Service Type** should reference something like "Miscellaneous Service".
- Specify the **Revenue Class** that, together with the interest bill factor, determines the distribution code used to book the loan interest revenue.
- **Start Option** should be turned on.
- The Payment Segment Type should reference the Normal Payment. The base package payment segment financial algorithm (  $\text{Payoff Amt} = \text{Current Amt} = \text{Pay Amt}$ ) used for Normal Payment pay segment types creates the additional GL details to transfer the credit from long-term receivables to short-term receivables if the SA's special role is Loan.
- Turn on **Late Payment Charge** if applicable.
- Define an appropriate **Adjustment Type (Synch Current)** that will cause current balance to be synchronized with payoff balance (if the loan is [written off](#)).

### SA Type - Detail

Define the following options:

- **Special Role** is Loan.
- Specify the **Interest Bill Factor** set up above. You can use start options to override.
- Use **Override Interest Flag** to indicate whether the interest rate defined on the interest bill factor may be overridden at the SA level. If you select Allowed, the interest rate may be overridden by a contract value on a start option or the SA.
- Use the short-term receivable account defined above as the **Loan A/R Distribution Code**. If you do not want the system to differentiate between short-term receivables and long-term receivables, make the loan A/R distribution code the same as the distribution code (above).

## SA Type - Billing

---

### FASTPATH:

For an overview of some of these options, be sure to refer to [Billing For Loans And Interest Calculation](#) for more information.

---

Define the following options:

- The **Bill Segment Type** should reference the value created above.
- **Characteristic Premise Required** should not be checked. (A loan SA is not a premise-based service. SA types that have this box checked are filtered out of the SA type search when the start method is Start a SA, so users will never be able to start a loan SA that requires a characteristic premise.)
- **Use Calendar Billing** must equal Anniversary Future Billing or Use Bill Period.
- **Bill Period** is required for the Use Bill Period option.
- **Anniversary Billing Frequency** is required for the Anniversary Future Billing option and must equal the periodicity of the bills (monthly, weekly, etc.).
- **Total Bill Amount** is required (it holds the principal).
- **Total Amount To Bill Label** should reference something like "Loan Amount".
- **Recurring Charge** is required (it holds the periodic payment amount).
- **Recurring Chg Amt Label** should reference something like "Payment Amount".
- **Recurring Charge Frequency** is required (it defines the periodicity associated with the recurring charge amount) and must be the same as the bill period frequency or the anniversary billing frequency (based on your **Use Calendar Billing** option).

## SA Type - Rate

Turn off the **Rate Required** switch as loans do not use rates.

## SA Type - SP Type

Turn off the **Service Points Required** switch as loans do not have service points.

## SA Type - Adjustment Profile

**Adjustment Type Profile** should reference the profile set up above.

## SA Type - Credit and Collections

The credit and collections information should reference a **Severance Process Template** that simply expires the loan. The **Debt Class** and **Write Off Debt Class** should reference an appropriate value consistent with your credit and collections rules. Refer to [Defining Credit & Collections Options](#) for more information.

## SA Type - Algorithms

The Loan Schedule, Loan Interest Charge, Loan Periods, and Amounts and Payment Freeze [algorithms](#) defined above must be set up.

## Start Options

Loans require a start option to define the adjustment type that is used to create the adjustment to book the initial principal amount when the loan is activated. Loan start options can also specify default values for loan amount, payment amount, and number of periods.

Create at least one start option for each loan SA type. The following information should be defined:

- **Adjustment Type** should reference the adjustment type defined above to book principal.
- **Recurring Charge Amount** (Payment Amount) should only be defined if you have standard loan payments.
- **Total Amount To Bill** (Loan Amount) should only be defined if you have standard loan amounts.
- **Number of Payment Periods** should be the number of payment periods in the loan (if you have a standard loan period).
- If you want to define a set of standard APRs for a loan SA Type, set up a **Contract Value** on the Rate Info page. The **Bill Factor** should match the interest bill factor specified on the [SA Type](#).

## Defining Non-Billed Budget Options

A Non-Billed Budget (NBB) is a payment plan that allows your customers to pay set amounts at specified intervals (e.g. every two weeks). Non-Billed Budgets are typically used when your company bills on an infrequent basis and you want to provide your customers with a mechanism to make smaller payments more frequently. As the name suggests, bills are not created for the Non-Billed Budget's scheduled payments; customers must remember to make their payments at the scheduled intervals. The topics in this section describe how to design and set up non-billed budgets.

---

**NOTE:**

**Non-Billed Budgets are optional.** The system configuration requirements described in this section are only relevant if your organization offers Non-Billed Budgets.

---

## What Is A Non-Billed Budget?

A Non-Billed Budget is a special type of budget or payment plan that encompasses three major elements:

- A set of scheduled payments
- The business rules used to recommend and potentially renew the payment schedule
- The business rules that govern the financial impact on the current and payoff balances of the SAs covered by the payment schedule

Non-Billed Budgets are managed via a service agreement whose SA type has a special role of Non-Billed Budget. If an SA type has a special role of Non-Billed Budget it must have one or more recommendation rules, and SAs of that type are allowed to have payment schedules.

# The Financial Impact Of Non-Billed Budgets

When you set up the Non-Billed Budget SA type, you can indicate whether the Non-Billed Budget is monitored by the [account debt monitor](#) process. The following sections contain examples of financial transactions for Non-Billed Budgets that are monitored by the account debt monitor.

**NOTE:**

**Unmonitored Non-Billed Budgets.** SAs that are covered by unmonitored Non-Billed Budgets are subject to different financial treatment than those that are monitored. The [financial transactions relevant for unmonitored Non-Billed Budgets](#) are discussed later.

## Current Amount For SAs Covered By A Non-Billed Budget

As described under [Current Amount versus Payoff Amount](#), the values of the current balance and payoff balance are the same for most financial transactions. One exception is for SAs that are covered by a Non-Billed Budget in which case the current balance is always zero and the payoff balance is always the amount the customer really owes.

When a Non-Billed Budget is activated or an SA is added to a Non-Billed Budget, the system creates adjustments for all affected SAs to set the current amount equal to zero. The adjustment type that references the Payoff Amt = 0 / Current Amt = Adj Amount (no GL) algorithm is taken from the SA's SA type.

**NOTE:**

**Non-Billed Budgets and Open Item Accounts.** If the Non-Billed Budget is for an open item account, no match event is created for the financial transaction that reduces the current amount to zero. This FT must be manually matched if required.

The following example shows the effect of activating a Non-Billed Budget that covers an electric SA with a current balance of 25. The transactions for the electric SA are illustrated on the right and the transactions for the non-billed budget SA are illustrated on the left.

Event	Effect On	Effect On	Current	Payoff	Effect On	Effect On	Current	Payoff
	Current	Payoff			Current	Payoff		
	Balance	Balance			Balance	Balance		
	Electric SA				Non-Billed Budget SA			
Starting balance	0	0	25	25				
Non-Billed Budget is activated	-25	0	0	25				

By setting the current balance for the covered SAs to zero, the SAs are insulated from the regular debt monitoring process. Depending on the Non-Billed Budget [recommendation algorithm](#), the payoff balance can be ignored, divided evenly between the scheduled payments or added to the first scheduled payment.

Activating a Non-Billed Budget has no affect on its own current or payoff balances.



## Scheduled And Actual Payments On The Non-Billed Budget

When a scheduled payment is due, an adjustment is created to increase the Non-Billed Budget's current balance by the expected amount. The current balance on the SA can be monitored to ensure that payments are being made on time.

When the payment is made, the Non-Billed Budget's current balance is reduced to zero and the Non-Billed Budget's payoff balance reflects the accumulated credit from the payment. This accumulated credit is transferred to the covered SAs when the next bill for the account is completed.

The following example illustrates scheduled and actual payments for the Non-Billed Budget in the previous example. The amount of the scheduled Non-Billed Budget payments is 10. Note that the first two transactions were described above.

Event	Effect On	Effect On	Current	Payoff	Effect On	Effect On	Current	Payoff
	Current	Payoff			Current	Payoff		
	Balance	Balance	Balance	Balance	Balance	Balance	Balance	Balance
	Electric SA				Non-Billed Budget SA			
Starting balance	0	0	25	25				
Non-Billed Budget is activated	-25	0	0	25				
First scheduled payment is due					10	0	10	0
Payment					-10	-10	0	-10

An algorithm ( Process NBB Scheduled Payment ) plugged in on the Non-Billed Budget SA type creates the appropriate financial transactions when the scheduled payment is due. The algorithm is called by the Non-Billed Budget Scheduled Payment Processing ( [NBBPS](#) ) background process.

The normal payment processing handles the adjustments created when the payment is made.

**NOTE:**

**Non-Billed Budget Payment Cancellation.** If a payment is canceled, the financial transaction is reversed.

**Automatic Payments And Non-Billed Budgets.** Users may set up a Non-Billed Budget to use [automatic payments](#) by setting up the account's auto pay options. Users may also exclude the Non-Billed Budget from automatic payment if the account is set up for automatic payment. The [NBB Scheduled Payment Automatic Payment Create](#) background process calls the [Auto Pay Creation](#) algorithm to create the auto payment for a Non-Billed Budget.

## Overpayments for Non-Billed Budgets

Typically, payments in excess of the Non-Billed Budget's current balance are credited to an overpayment (excess credit) SA. When the next adjustment is created for a scheduled payment, the credit on the overpayment SA is used to relieve the non-billed budget current balance.

**NOTE:**

**Overpayment Distribution Algorithm.** The overpayment distribution is a function of the overpayment distribution algorithm plugged in on the account's customer class. We strongly recommend that the Non-Billed Budget SA type be

set up so that overpayment is not allowed. Any excess payments should go to an overpayment SA. For more information about overpayment distribution, refer to [Overpayment Segmentation](#).

In the example below, the customer pays 20 for a scheduled payment instead of 10. The non-billed budget SA is illustrated on the right and the overpayment SA is illustrated on the left. The electric SA is not illustrated in the example below because scheduled payments, payments and overpayments have no effect on covered SAs. The first four transactions were illustrated above.

Event	Effect On	Effect On	Current	Payoff	Effect On	Effect On	Current	Payoff
	Current Balance	Payoff Balance	Balance	Balance	Current Balance	Payoff Balance	Balance	Balance
	Non-Billed Budget SA				Overpayment SA			
Starting balance								
Non-Billed Budget is activated								
First scheduled payment is due	10	0	10	0				
Payment	-10	-10	0	-10				
Second scheduled payment is due	10	0	10	-10				
Over-payment	-10	-10	0	-20	-10	-10	-10	-10
Third scheduled payment is due	10	0	10	-20				
Transfer Adjustment	-10	-10	0	-30	10	10	0	0

After the Process NBB Scheduled Payment algorithm creates the next scheduled payment, it looks for a credit amount on the overpayment SA and creates an adjustment to transfer the credit balance (or the amount of the payment if the credit is more than the scheduled payment amount) from the overpayment SA to the non-billed budget SA. The overpayment transfer adjustment type and the overpayment SA type are specified as parameters to the algorithm.

## Underpayments For Non-Billed Budgets

An insufficient payment or a canceled payment leaves a current balance on the Non-Billed Budget SA.

In the example below, the customer makes a payment of 7 for the fourth scheduled payment. The example below does not show the overpayment SA (illustrated above). The first eight transactions are discussed above.

Event	Effect On Current Balance	Effect On Payoff Balance	Current Balance	Payoff Balance	Effect On Current Balance	Effect On Payoff Balance	Current Balance	Payoff Balance
	Electric SA				Non-Billed Budget SA			
Starting balance	0	0	25	25				
Non-Billed Budget is activated	-25	0	0	25				
First scheduled payment is due					10	0	10	0
Payment					-10	-10	0	-10
Second scheduled payment is due					10	0	10	-10
Over- payment					-10	-10	0	-20
Third scheduled payment is due					10	0	10	-20
Transfer Adjustment					-10	-10	0	-30
Fourth scheduled payment					10	0	10	-30
Underpayment					-7	-7	3	-37

The Process NBB Scheduled Payment algorithm creates a trigger to ensure that the current balance is monitored by the account debt monitor. Refer to [Credit And Collections And Non-Billed Budgets](#) for more information.

## Billing For SAs Covered By The Non-Billed Budget

When the next bill for the account is completed, the credit on the Non-Billed Budget is transferred to the covered SAs. The credit is prorated over the covered SAs according to the relative payoff balances on each SA.

In the example below, the electric SA's bill is 33. The first ten transactions are discussed above.

Event	Effect On Current Balance	Effect On Payoff Balance	Current Balance	Payoff Balance	Effect On Current Balance	Effect On Payoff Balance	Current Balance	Payoff Balance
	Electric SA				Non-Billed Budget SA			
Starting balance	0	0	25	25				

Non-Billed Budget is activated	-25	0	0	25				
First scheduled payment is due					10	0	10	0
Payment					-10	-10	0	-10
Second scheduled payment is due					10	0	10	-10
Over-payment					-10	-10	0	-20
Third scheduled payment is due					10	0	10	-20
Transfer Adjustment					-10	-10	0	-30
Fourth scheduled payment					10	0	10	-30
Underpayment					-7	-7	3	-37
Bill	0	33	0	58				
Bill completion (transfer adjustment)	0	-37	0	21	0	37	3	0

When a bill segment financial transaction is created, the current amount is set to zero for SAs that are covered by the Non-Billed Budget (if you use a bill segment FT algorithm of  $\text{Payoff Amt} = \text{Bill Amt} / \text{Current Amt} = \text{Amt Due}$  ). Though not evident by the name, the  $\text{Payoff Amt} = \text{Bill Amt} / \text{Current Amt} = \text{Amt Due}$  algorithm does set the current amount to zero for monitored Non-Billed Budgets. (For SAs with other roles, the current amount is equal to the amount due or the recurring charge.)

A bill completion algorithm transfers money from the Non-Billed Budget to the covered SAs (if you plug in the NBB Credit Transfer bill completion algorithm on the Non-Billed Budget SA type). The algorithm type supplied with the base package distributes the credit using the method described in [Distributing Non-Billed Budget Credit](#).

**NOTE:**

**Canceled Bill Segments.** No new processing occurs when a bill segment is canceled; any credit balance remains on the covered SA.

## Distributing Non-Billed Budget Credit

Both the NBB Credit Transfer bill completion algorithm type and the Non-Billed Budget SA stop algorithm type supplied with the base package use the same method of distributing a credit from a Non-Billed Budget SA to the covered SAs. The following points describe how the credit is distributed:

- Covered SAs that are already in credit (due to some other circumstance, such as a cancellation and rebill) are excluded from the distribution.
- The distribution to each covered SA will not exceed its total payoff to ensure that none of the covered SAs have a credit balance.
- The credit is prorated over the covered SAs according to the relative payoff balances on each SA.
- The calculation of the payoff balance is adjusted to exclude the current balance to ensure that the credit is prorated over the debt covered by the budget, not any ad-hoc debt for the SA.

**NOTE:**

The current balance on covered SAs should always be zero. The only exception occurs if an adjustment has been added that directly affected the SA balance. In this case, the distribution assumes that the balance is outside the non-billed budget and needs to be paid separately.

- Any excess credit remains on the Non-Billed Budget SA until the next distribution takes place or until the [Non-Billed Budget SA is stopped](#).
- The type of adjustments created is determined by the **Adjustment Type (Xfer)** specified on the Non-Billed Budget SA type.

The examples in the table below illustrate the points above.

NBB SA Credit	SA 1 Payoff	SA 1 Current	SA 2 Payoff	SA 2 Current	SA 1 Credit Xfer	SA 2 Credit Xfer
-100.00	-100.00	0.00	-200.00	0.00	0.00	0.00
-100.00	150.00	0.00	-50.00	0.00	-100.00	0.00
-300.00	150.00	0.00	50.00	0.00	-150.00	-50.00
-100.00	150.00	0.00	250.00	0.00	-37.50	-62.50
-100.00	150.00	0.00	250.00	50.00	-42.86	-57.14

The first example above shows that covered SAs with a credit balance are excluded from the distribution. Any excess credit remains on the Non-Billed Budget.

The second example shows that one covered SA has a credit balance, so the entire credit is distributed to the remaining SA.

The third example shows the amount distributed to a covered SA does not exceed its payoff balance. Again, any excess credit remains on the Non-Billed Budget SA.

The fourth example illustrates how the credit is prorated based on the payoff balance. The fifth example illustrates the same prorating but with a current balance on one of the SAs (SA 2). (Remember that the prorating excludes any current balance.)

The prorated amount is calculated by subtracting the current balance from the payoff balance then multiplying the result by the distribution amount and dividing by the total payoff owing of all covered SAs.

## Stopping an SA Covered By a Non-Billed Budget

If a service agreement covered by a Non-Billed Budget is stopped, the system must bring the current balance and payoff balance of the covered SA back in synch. The system creates an adjustment using the Synch Current adjustment type from the SA's SA type.

In the example below, the electric SA's payoff balance is 21. The first twelve transactions are discussed above.

Event	Effect On Current Balance	Effect On Payoff Balance	Current Balance	Payoff Balance	Effect On Current Balance	Effect On Payoff Balance	Current Balance	Payoff Balance
	Electric SA				Non-Billed Budget SA			
Starting balance	0	0	25	25				
Non-Billed Budget is activated	-25	0	0	25				
First scheduled payment is due					10	0	10	0
Payment					-10	-10	0	-10
Second scheduled payment is due					10	0	10	-10
Over- payment					-10	-10	0	-20
Third scheduled payment is due					10	0	10	-20
Transfer Adjustment					-10	-10	0	-30
Fourth scheduled payment					10	0	10	-30
Underpayment					-7	-7	3	-37
Bill	0	33	0	58				
Bill completion (transfer adjustment)	0	-37	0	21	0	37	3	0
SA is stopped	21	0	21	21				

**NOTE:**

In addition to syncing the current and payoff balance, the SA being stopped is removed from the covered SAs collection. When the last covered SA is removed from the collection, the Non-Billed Budget is also [stopped](#).

## Financial Transactions For Unmonitored Non-Billed Budgets

Some companies have the concept of non-billed budgets where the payments made by the customer are optional. This functionality is implemented as an unmonitored Non-Billed Budget. Unmonitored Non-Billed Budgets allow a customer to make optional prepayments towards a bill.

As explained previously, unmonitored Non-Billed Budgets receive different financial treatment than monitored Non-Billed Budgets. The financial transaction algorithms use the **Non-Billed Budget Monitor** flag on the Non-Billed Budget's SA type to create the appropriate financial transactions. The following table describes the differences in the financial treatment of monitored and unmonitored Non-Billed Budgets.

System Event	Monitored Non-Billed Budgets	Unmonitored Non-Billed Budgets
When a Non-Billed Budget is activated or an SA is added to a Non-Billed Budget...	The system creates adjustments for all affected SAs to set the current balance equal to zero.	The current balances for covered SAs are not zeroed. The activate SA and Non-Billed Budget maintenance processing do not create any adjustments if the Non-Billed Budget is unmonitored.
When a scheduled payment is due...	An adjustment is created to increase the Non-Billed Budget's current balance by the expected amount.	There is no change to the Non-Billed Budget's current balance; it is always zero. The scheduled payment processing background process does not execute the <a href="#">NBB process scheduled payment algorithm</a> .
When the payment is made...	The Non-Billed Budget's current balance is reduced to zero and the Non-Billed Budget's payoff balance reflects the accumulated credit from the payment.	Typically the payments are distributed to an excess credit (overpayment) SA. Refer to <a href="#">Distributing Payments for Unmonitored Non-Billed Budgets</a> for more information.
When a bill segment financial transaction is created...	The current amount is set to zero for SAs that are covered by the Non-Billed Budget.	The covered SAs' current amounts are equal to their payoff amounts.
At bill completion...	Money from the Non-Billed Budget is transferred to the covered SAs. Customers may receive a bill for information purposes, but they are not required to pay it.	Money from the overpayment SA is transferred to the account's SAs. The customer is still liable to pay the outstanding balance.
When the Non-Billed Budget is stopped or an SA is removed from a Non-Billed Budget...	The system creates adjustments for all affected SAs to synchronize their current balances with their payoff balances, thus removing the zero current balance and replacing it with the actual current balance.	There is no change to the current balances for covered SAs as the balances already reflect the actual current balance.

Unmonitored Non-Billed Budgets also receive different credit and collections treatment. Refer to [Credit and Collections and Unmonitored Non-billed Budgets](#) for more information.

## Distributing Payments for Unmonitored Non-Billed Budgets

For Non-Billed Budgets, payments are distributed according to the payment and overpayment algorithms on the customer class. The base package payment distribution algorithm applies a payment first towards any SAs that have overdue or current balances (refer to [Distributing A Payment](#) for more information). Since the unmonitored Non-Billed Budget SA doesn't have a current balance, it is not considered by the payment distribution algorithm. If there aren't any SAs with a current balance, the overpayment distribution algorithm handles the remaining credit. You can elect to:

- Apply the overpayment to an excess credit SA. This is the method that we strongly recommend because all financial transactions are then a function of the normal payment, overpayment and billing processes.

- Apply the overpayment to the highest priority SA that is eligible for overpayment (as specified on the SA type). You can use this method to apply the overpayment to the unmonitored Non-Billed Budget SA. If you use this method, you must also set up the system to [transfer the credit from the unmonitored Non-Billed Budget](#).

---

**NOTE:**

**Use An Excess Credit SA.** We strongly recommend that payments for unmonitored Non-Billed Budgets are distributed to an excess credit SA. In this case, the Non-Billed Budget is just a shell to hold the covered SAs and recommend a payment schedule; all financial transactions are a function of the normal payment, overpayment and billing processes.

---

**FASTPATH:**

Refer to [Overpayment Segmentation](#) for a detailed discussion of overpayment distribution options.

---

## Transferring Credit from Unmonitored Non-Billed Budgets

If you distribute an overpayment to an unmonitored Non-Billed Budget SA (i.e. the unmonitored non-billed budget maintains a credit balance instead of an overpayment SA), you must plug-in a bill completion algorithm on the SA type to transfer the credit balance to the covered SAs at bill completion time. The bill completion algorithm type ([BCMP-NB](#)) supplied with the base package transfers the credit balance to the covered service agreements when the bill is completed. Additionally, the **Adjustment Type (Xfer)** on unmonitored Non-Billed Budget SA types should reference a FT algorithm of  $\text{Payoff Amt} = \text{Adj} / \text{Current Amt} = \text{Adj}$  to ensure that the credit is removed from both the current and payoff balances.

---

**WARNING:**

You must create your own SA stop algorithm type for correctly stopping an unmonitored non-billed budget that maintains a credit balance. The SA stop algorithm that is supplied with the base package does NOT transfer remaining credit from the unmonitored Non-Billed Budget SA. (The base package SA stop algorithm transfers the remaining credit using the overpayment distribution algorithm on the customer type, which you have set up to transfer to back to the unmonitored non-billed budget.)

---

## Designing Non-Billed Budgets

The topics in this section describe functionality that you must consider when designing non-billed budgets.

### Making SAs Eligible For Non-Billed Budgets

A billable SA may be covered by a Non-Billed Budget when its SA type is flagged as Eligible for Non-Billed Budget.

All SAs that are eligible for non-billed budgets should reference a bill segment type that uses the  $\text{Payoff Amt} = \text{Bill Amt} / \text{Current Amt} = \text{Amt Due}$  bill segment FT algorithm. This algorithm sets the SA's current amount to zero if it is covered by a monitored Non-Billed Budget.

A list of the SAs covered by a Non-Billed Budget is maintained with the non-billed budget SA. This list is used at bill completion to determine the financial transactions that should occur.

## Designing Recommendation Rules



Users (and the renewal process) ask the system to recommend the scheduled payments for a Non-Billed Budget. In general, this recommendation process must establish:

- The amount to be paid
- The dates on which the payments are due

We envision many different types of recommendation rules. For example:

- Recommend 26 scheduled payments to be made on a fortnightly basis that are due on Tuesdays.
- Recommend monthly payments that are due on the nearest workday after the 10th of the month.
- Recommend scheduled payments where the customer pays their annual charges in 10 out of 12 months where the payments are not due in November and December.
- Recommend bi-monthly payments where the payments are due on the first workday following the 5th and 20th of the month.

Additionally, the recommendation rules must determine how to handle any outstanding payoff balances for covered SAs. The true-up rule provided with the base package [payment schedule algorithm type](#) can ignore the payoff balance, divide the payoff balance evenly between the scheduled payments, or add the payoff balance to the first scheduled payment.

A recommendation rule comprises three elements:

- An algorithm to calculate an average daily amount (the [NBDA-DA](#) algorithm type provided with the base package uses premise billing history)

**NOTE:**

**Calculating an Amount for Non-utility SAs.** The algorithm type supplied with the base package only handles service-point oriented SAs. For example, the average daily amount algorithm calculates an average daily amount. For non-utility SAs, you must develop the appropriate algorithm types.

- Two algorithm types are provided with the base package to calculate a schedule of payments. [NBPS-MON](#) calculates a monthly schedule and [NBPS-PS](#) calculates a scheduled based on a specified number of days.
- A collection of default parameter values for the payment schedule algorithm type

A recommendation rule (based on the algorithm types provided with the base package) is illustrated below.

Rule: <b>Weekly</b>		
Avg Daily Amt Alg: <b>Use premise history</b>		
Pay Schedule Alg Type: <b>Number of days</b>		
Parameter	Value	Override
Number of days in period	7	Y
Number of payments	52	N
True-up rule	Spread	N

***Weekly Payments Recommendation Rule***

**NOTE:**

**Additional Parameters.** Not all of the parameters associated with the weekly payment schedule algorithm type are illustrated. Refer to the [NBPS-PS](#) algorithm type for a detail description of the parameters.

The default parameter values for the payment schedule algorithm type may change over time, so the collection contains an effective date. If default values are changed, these changes do not affect Non-Billed Budgets already in effect. Existing Non-Billed Budgets keep the parameter values that were used when the Non-Billed Budget was started.

A user may override the default parameter values for the payment schedule algorithm type to customize the schedule if an override is allowed for a parameter. Additionally, a user may edit the payment schedule details at any time (provided the payment has not yet been processed).

The parameter values used for the recommendation rule are kept with the Non-Billed Budget SA, so that any customized parameter changes can be re-applied to a renewed Non-Billed Budget. For example, the parameter that determines the payment due day may default to the first of the month. To customize the schedule, this value may be changed to the fifth of the month. This amended value is kept with the Non-Billed Budget SA to ensure that the renewed budget follows the same monthly schedule.

**NOTE:**

Normally parameter values for an algorithm type are kept with the algorithm. Because the parameters may vary for each Non-Billed Budget, the parameter values are kept with the SA in the case of Non-Billed Budgets.

Refer to [Non-billed Budgets Recommendation Rule - Main](#) for information on creating recommendation rules.

## Example Recommendation Rules

The following examples may be helpful in designing and implementing your recommendation rules.

**NOTE:**

**Developing Your Own Payment Schedule Algorithms.** The base package comes supplied with a [monthly payment schedule algorithm type](#). You can use this algorithm as an example when creating payment schedule algorithm types for your implementation.

## Fortnightly Payments Recommendation Rule Example

The following diagram illustrates a recommendation rule where the customers pay every two weeks. The current balance for any covered SAs is added to the first payment.

Rule: <b>Fortnightly</b>		
Avg Daily Amt Alg: <b>Use premise history</b>		
Pay Schedule Alg Type: <b>Number of days</b>		
Parameter	Value	Override
Number of days in period	14	Y
Number of payments	26	N
True-up rule	Spread	N

*Fortnightly Payments Recommendation Rule*

## Monthly Payments Recommendation Rule Example

The following diagram illustrates a recommendation rule where the customers pay twice monthly on the first of the month. The current balance for any covered SAs is spread out over the scheduled payments.

Rule: <b>Monthly</b>		
Avg Daily Amt Alg: <b>Use premise history</b>		
Pay Schedule Alg Type: <b>Monthly</b>		
Parameter	Value	Override
Day of month	1	Y
Number of payments	12	N
True-up rule	Spread	N

*Monthly Payments Recommendation Rule*

## Ten Out of Twelve Months Recommendation Rule Example

The following diagram illustrates a recommendation rule where the customers pay one a month except for months during a holiday season (November and December). The current balance for any covered SAs is added to the first payment.

Rule: <b>10 of 12</b>		
Avg Daily Amt Alg: <b>Use premise history</b>		
Pay Schedule Alg Type: <b>X out of Y months</b>		
Parameter	Value	Override
Total number of months	12	N
Months with no payment	11,12	Y
True-up rule	1 <sup>st</sup> pay	N

*Ten Out of Twelve Months Recommendation Rule*

## Activating Non-Billed Budgets

You can plug in an algorithm (of type [SACR-AT](#)) on the SA Creation system event on the Non-Billed Budget SA type to automatically activate the Non-Billed Budget (i.e. transition it from pending start to active status). If you don't use a SA Creation algorithm to activate the Non-Billed Budget, it is activated the next time the [SA activation background process](#) runs.

When a Non-Billed Budget is activated, you can perform special processing using an algorithm plugged in on the SA Activation system event on the Non-Billed Budget SA type. The special processing can be developed to do anything that you would like, for example you could:

- Create a customer contact that with an appropriate letter template can generate a letter to inform the customer of their payment amount and payment schedule.
- Initiate the creation of a payment coupon book for a customer.

The system comes supplied with a sample algorithm type (called [SAAT-CC](#)) that simply creates a customer contact to indicate that the Non-Billed Budget is activated.

## Renewing Non-Billed Budgets

A Non-Billed Budget can be renewed either manually or via a background process. When the Non-Billed Budget SA is created, the expiration date, renewal date and the recommendation rule used to create the initial budget are kept with the SA. A renewal flag on the Non-Billed Budget SA type controls if a renewal is required, optional or not allowed. If renewal is required, a user must specify a renewal date when creating the service agreement. The renewal date is defaulted on to an SA based on the value of the **Days Before Expiration for Renewal** field on the SA type.

An algorithm on the SA type can customize the processing required to renew an SA.

The [SA renewal background process](#):

- Executes the SA renewal algorithm (specified on the SA type) when the renewal date is reached (i.e., it is on or before the process date). The base package comes with an algorithm type ( [SARN-NB](#)) that determines the current recommendation rule for a non-billed budget and executes the associated payment schedule algorithm using the Non-Billed Budget SA-specific parameter values to generate a new schedule. It returns new expiration and renewal dates.
- If the renewal algorithm is successful, the renewal and expiration date fields on the SA are updated with the new values.
- If the renewal process is not successful, a To Do list entry (of type [TD-SARN](#)) is created for the account and SA.

The new payment schedule that is returned from the renewal process for a Non-Billed Budget is appended to the current schedule.

A user can manually launch the renewal process for a Non-Billed Budget SA by clicking the **Renew NBB** button on the [Non-Billed Budget maintenance page](#).

## Expiring Non-Billed Budgets

Non-Billed Budget service agreements may specify an expiration date. The [SA expiration background process](#) initiates the stop process for all pending start or active SAs where the expiration date is reached (before or on the process date).

## Stopping Non-Billed Budgets

When a Non-Billed Budget stop is initiated, either on request or because it has expired and is not being renewed, the Non-Billed Budget is transitioned to pending stop status. You can plug in an algorithm (of type [SAIS-ST](#)) on the SA Stop Initiation system event on the Non-Billed Budget SA type to automatically finalize and stop the SA (i.e. transition it to stopped status). If you don't use a SA Stop Initiation algorithm, the Non-Billed Budget is stopped the next time the [SA activation background process](#) runs.

To finalize a pending stop SA, the system first calls the stop SA algorithm plugged-in on the SA Stop system event on the SA type. The stop SA algorithm type ( [SAST-NB](#)) supplied with the base package:

- Distributes any credit on the Non-Billed Budget to the covered SAs (using the method described in [Distributing Non-Billed Budget Credit](#))
- Distributes any excess credit remaining on the non-billed budget using the [overpayment distribution](#) algorithm for the account's customer class and the overpayment transfer adjustment type (specified as a parameter to the algorithm)

- Creates a trigger to cause the account to be reviewed by the account debt monitor
- Creates a customer contact (if the customer contact class and customer contact type parameters are populated)

---

**WARNING:**

If you do not plug in an SA stop algorithm that transfers the credit balance from the non-billed budget to its covered SAs (or an excess credit SA), the stopped Non-Billed Budget may have a credit balance. You must then manually distribute this credit.

---

After the SA stop algorithm is finished, the SA stop processing performs the following steps if the SA type has a special role of Non-Billed Budget:

- If the Non-Billed Budget is monitored, create adjustments to synchronize the current and payoff balance of covered SAs using the **Adj. Type (Synch Current)** adjustment type from the covered SAs' SA types
  - Remove the covered SAs from the Non-Billed Budget
  - Remove all the scheduled payments from the non-billed budget
  - Create an adjustment to synchronize current and payoff on the Non-Billed Budget SA using the **Adj. Type (Synch Current)** adjustment type from the Non-Billed Budget's SA type
- 

**NOTE:**

Synchronizing current and payoff effectively sets the current amount to zero on the Non-Billed Budget SA, as the payoff amount should have been reduced to zero by the distribution and overpayment processing in the algorithm for SA Stop.

---

**FASTPATH:**

Refer to [The Lifecycle Of A Service Agreement](#) for more information about how a pending stop SA is stopped and closed.

---

## Automatic Payment and Non-Billed Budgets

If a customer wants to pay their non-billed budget scheduled payments automatically, the account must be set up for automatic payment. In addition, the Non-Billed Budget must indicate that automatic payment is being used.

---

**FASTPATH:**

Refer to [How To Set Up Automatic Payment For A Non-Billed Budget](#) for more information.

---

When this is done, a background process referred to as NBBAPAY creates automatic payments on the scheduled payment date by calling the automatic payment creation algorithm plugged in on the installation record.

---

**NOTE:**

You must ensure that your auto pay creation algorithm supports Non-Billed Budget scheduled payments. The [APAY-CREATE](#) algorithm type supplied with the base package supports non-billed budget scheduled payments.

---

## Credit and Collections and Non-Billed Budgets

Unless the Non-Billed Budget is **unmonitored**, the [account debt monitor](#) (ADM) monitors a Non-Billed Budget SA's current amount just as it does for any other SA. The [scheduled payment algorithm](#) creates a trigger to ensure that the account debt monitor reviews the account the next time it runs. The review date on the trigger record is set to the process business date.

---

A separate [debt class](#) is needed for Non-Billed Budget SA types, thus allowing you to define collection class controls, debt criteria and collection process templates specifically for Non-Billed Budgets. The debt criteria should be set up to trigger a collection process when the arrears amount exceeds \$0.01 for more than n payment periods plus the number of grace days that you want to allow.

The collection process template can perform any of the events in standard collection processes, such as sending letters to customers and creating severance processes. At a minimum, the collection process template should be set up to start a severance process for all service agreements in the debt class. (Since the debt class is specifically for Non-Billed Budgets, the Non-Billed Budget is the only SA that will be subject to a severance process.)

The Non-Billed Budget severance process template should include the following event types:

- Populate a characteristic on the SA to indicate that the SA is broken. The base package comes supplied with a severance event algorithm type ( [SVEV-NB](#)) that sets an SA characteristic to indicate that it was "severed".
- [Expire Severance Agreement](#) to move the SA to the pending stop state.

When the system subsequently stops the Non-Billed Budget, the system removes the covered SAs from the Non-Billed Budget and synchronizes their current balances with their payoff balances. Since the SAs have current balances again, they are subject to the account debt monitor, which can start subsequent collection processes for any of the SAs that meet the debt criteria for their debt class.

---

**FASTPATH:**

Refer to [Stopping Non-billed Budgets](#) for a complete description of the events that occur when a Non-Billed Budget is stopped.

---

Customers can catch up on their payments and avoid having their Non-Billed Budget broken as long as their current balance doesn't violate the debt criteria for the Non-Billed Budget's collection process.

## Credit and Collections and Unmonitored Non-Billed Budgets

If the **Non-Billed Budget Monitor** flag on the Non-Billed Budget's SA type is set to Unmonitored, the [NBB Scheduled Payment Processing](#) background process does not create a trigger for the account debt monitor. Additionally, the Non-Billed Budget's current amount is always equal to zero, so it never violates any debt collection criteria. We recommend using a debt class that has the **Eligible for Collection** flag turned off, such as the N/A debt class.

For unmonitored Non-Billed Budgets, the current balance is kept on the covered SAs so they are subject to the account debt monitor and any debt criteria for their SA types' debt classes. For more information, refer to [Financial Transactions for Unmonitored Non-Billed Budgets](#).

## Non-Billed Budget Status

A Non-Billed Budget SA's status is just like any other SA's status. In addition, you can use a characteristic to keep an explicit status relevant to the Non-Billed Budget:

- A base package severance event algorithm type ( [SVEV-NB](#)) creates a characteristic value to indicate if a Non-Billed Budget is "broken" (i.e. stopped as a result of a severance process).
- A base package break Non-Billed Budget algorithm type ( [NBBR-BRK](#)) creates a characteristic value to indicate if a Non-Billed Budget is "canceled" (i.e. manually stopped by a user).

An active Non-Billed Budget implicitly has a "kept" status (i.e. all scheduled payments have been made).

## Alerts For Non-Billed Budgets

The system provides [alerts](#) to highlight the existence of Non-Billed Budgets. These alerts are important to assist the customer service representatives:

- An alert is displayed if the account has a Non-Billed Budget that is not stopped (e.g., pending start, active or pending stop).
- When a user denies a Non-Billed Budget (for whatever reason), the user should create a [customer contact](#) with a given [customer contact type](#). This type of alert prevents the customer from shopping around. An existing alert algorithm type ([CC BY TYPCL](#)) can highlight these customer contacts.
- For customers who are permanently forbidden from having a Non-Billed Budget, the user should put a permanent [alert on the account](#).
- Use an algorithm to highlight cancelled or severed non-billed budgets with an entry in the alert zone. The algorithm type to do this is not provided. Use [PP BY STATUS](#) and [CCAL-WF](#) as examples of how to create this type of algorithm.

---

### FASTPATH:

For more information about introducing alert conditions on Control Central, refer to [Installation Options - Algorithms](#).

---

## Non-Billed Budget Recommendation Rule

Recommendation rules are used to recommend scheduled payments for Non-Billed Budgets. For information about designing recommendation rules, refer to [Designing Recommendation Rules](#).

To define recommendation rules, navigate to **Admin > Financial > NBB Recommendation Rule > Add**.

### Description of Page

Enter an easily recognizable **Recommendation Rule** code and **Description** for each recommendation rule.

Specify the **Average Daily Amount Algorithm** used to calculate the average daily amount for this recommendation rule.

Specify the **Payment Schedule Algorithm Type** used to create the recommended payment scheduled for Non-Billed Budgets that use this recommendation rule. The Payment Schedule Algorithm Type cannot be modified if a Non-Billed Budget SA that is not stopped or cancelled is using this recommendation rule.

**Payment Schedule Parameters** enables you to define collections of default parameter values for the payment schedule algorithm type that are effective dated. For each collection:

- **Effective Date** defines the date on which the collection of parameter values becomes effective.
- **NBB Rule Parameter Value** specifies the default value of each parameter supplied to the algorithm. Note that the [payment schedule algorithm type](#) controls the number and type of parameters.
- **Override Flag** indicates whether the user can override the default value for the parameter.

### Where Used

Follow this link to open the data dictionary where you can view the tables that reference [CI\\_NB\\_RULE](#).

## Setting Up The System To Enable Non-Billed Budgets

The above topics provided background information about how Non-Billed Budgets are supported in the system. The topics in this section describe how to set up the system to enable Non-Billed Budget functionality.



---

**NOTE:**

**Example Setup.** This section describes typical non-billed budget configurations. Your set up and configuration may differ depending on your business needs. This section is provided for guidance only. Read the descriptions of Non-Billed Budget functionality above to understand the implications of the described setup.

---

## NBB Distribution Codes

You must set up a Non-Billed Budget Clearance [distribution code](#) that is used on the Non-Billed Budget SA type to credit non-billed payments.

## NBB Adjustment Types

---

**NOTE:**

**Non-Billed Budget Financial Transaction Algorithms.** The Non-Billed Budget adjustment types use the standard FT algorithm types that are provided with the base package. If you have not yet defined algorithms for these types in your system, do so before creating the Non-Billed Budget adjustment types.

---

The following adjustment types are needed:

- **Add SA To Non-Billed Budget.** This adjustment type should reference an FT algorithm of  $\text{Payoff Amt} = 0 / \text{Current Amt} = \text{Adj Amount (no GL)}$ . Because the adjustment affects the current balance only, there is no entry in the GL. This adjustment type is referenced on **Adjustment Type (Current=0)** on SA types that are eligible for Non-Billed Budgets. Note that this adjustment type is never used if the SA is added to an unmonitored Non-Billed Budget.
- **Bill Complete for Monitored Non-Billed Budget.** This adjustment type should reference a distribution code used for balance transfer clearing. It should reference a FT algorithm of  $\text{Payoff Amt} = \text{Adj} / \text{Current Amt} = 0$ . This adjustment type is referenced on **Adjustment Type (Xfer)** on SA types that are monitored Non-Billed Budgets.
- **Synch Balance for Non-Billed Budget.** This adjustment type should be set up for **Sync. Current Amount** and should reference a FT algorithm of  $\text{Payoff Amt} = 0 / \text{Current Amt} = \text{Adj Amount (no GL)}$ . This adjustment type is referenced on the **Adj. Type (Synch Current)** on Non-Billed Budget SA types. It is used when a Non-Billed Budget SA is stopped to synch the current balance with the payoff balance.
- **Scheduled Payment.** This adjustment type should reference an FT algorithm of  $\text{Payoff Amt} = 0 / \text{Current Amt} = \text{Adj Amount (no GL)}$ . Because the adjustment affects the current balance only, there is no entry in the GL. This adjustment type is referenced on the Non-Billed Budget process scheduled payment algorithm.
- **Overpayment Transfer.** This adjustment type should reference a transfer distribution code and a FT algorithm of  $\text{Payoff Amt} = \text{Adj} / \text{Current Amt} = \text{Adj}$ . This adjustment is referenced on the non-billed budget process scheduled payment algorithm and the stop non-billed budget algorithm. Note that if there is already a transfer adjustment type created in your system, you do not need to create a new one.

If you are setting up an unmonitored Non-Billed Budget that maintains a credit balance (as opposed to maintaining the credit balance on an overpayment SA), you need to create an adjustment type for Bill Complete for Unmonitored Non-Billed Budget. (Refer to [Transferring Credit from Unmonitored Non-billed Budgets](#) for more information.) The adjustment type should reference a transfer distribution code and a FT algorithm of  $\text{Payoff Amt} = \text{Adj} / \text{Current Amt} = \text{Adj}$ . This adjustment type is referenced on **Adjustment Type (Xfer)** on SA types that are unmonitored Non-Billed Budgets.

## NBB Adjustment Type Profiles



Create an adjustment type profile for Non-Billed Budgets that references the following adjustment types:

- Bill complete for monitored Non-Billed Budget
- Bill complete for unmonitored Non-Billed Budget (if used)
- Synch balance for Non-Billed Budget
- Scheduled payment
- Overpayment transfer

Create an adjustment type profile for eligible SAs that references the following adjustment types:

- Add SAs to monitored Non-Billed Budgets
- Bill complete for monitored Non-Billed Budget
- Bill complete for unmonitored Non-Billed Budget (if used)

---

**NOTE:**

**Bill Complete Adjustment Types.** Because the bill complete adjustment types transfer amounts between two SAs, they must be in profiles for both Non-Billed Budget and eligible SA types.

**Overpayment Transfer Adjustment Type.** The overpayment transfer adjustment type created above is used to transfer funds from an excess credit SA to a Non-Billed Budget when the scheduled payment is processed. It is also used to transfer excess funds from a Non-Billed Budget that is being closed to an excess credit SA. The transfer adjustment should therefore be added to an adjustment type profile that is referenced on the excess credit SA type.

---

## NBB Characteristic Types

Create a Non-Billed Budget status characteristic type that specifies Service Agreement as its characteristic entity. The characteristic type should include the following predefined values:

- Non-Billed Budget Canceled
- Non-Billed Budget Severed

## NBB Customer Contact Class And Types

Create a Non-Billed Budget customer contact class. The contact class may include the following customer contact types:

- Non-Billed Budget Activate
- Non-Billed Budget Renewal
- Non-Billed Budget Stop

---

**NOTE:**

**Customer Contact Letters.** If you want to send letters to your customers when a contact of any of these types is created, you must create an appropriate [letter template](#) and attach it to the contact type.

---

## NBB Algorithms

You must define the following [algorithms](#):

- On [NBB recommendation rule](#), the Non-Billed Budget Daily Amount Calculation. Refer to the [NBDA-DA](#) algorithm type for more information about the base package algorithm.
- On [SA type](#):
  - Non-Billed Budget Process Scheduled Payment. This algorithm has parameters that must reference the Scheduled Payment and Overpayment Transfer adjustment types defined above. Another parameter references an overpayment SA type (that you may need to create if there is not already one in your system). Refer to the [NBPA-PS](#) algorithm type for more information about the base package algorithm.
  - Non-Billed Budget SA Renewal. Refer to the [SARN-NB](#) algorithm type for more information about the base package algorithm.
  - Break Non-Billed Budget SA. Refer to the [NBBR-BRK](#) algorithm type for more information about the base package algorithm.
  - SA Activation - automatically activate SA (if you want to automatically activated Non-Billed Budgets when they are created). Refer to the [SACR-AT](#) algorithm type for more information about the base package algorithm. Note that this same algorithm may be used on many SA types.
  - SA Activation - create customer contact (if you want the system to create a customer contact when NBB SAs are activated). Refer to the [SAAT-CC](#) algorithm type for more information about the base package algorithm.
  - SA Stop - automatically stop SA (if you want to automatically transition Non-Billed Budgets from pending stop to stop when their stop is initiated). Refer to the [SAIS-ST](#) algorithm type for more information about the base package algorithm. Note that this same algorithm may be used on many SA types.
  - SA Stop - Stop Non-Billed Budget. Refer to the [SAST-NB](#) algorithm type for more information about the base package algorithm.
  - Bill Completion - Non-Billed Budget Credit Transfer. Refer to the [BCMP-NB](#) algorithm type for more information about the base package algorithm.
- On [bill segment type](#), the Bill FT Algorithm (for all SAs that are eligible for NBB). Refer to the [BSBF-BA](#) algorithm type for more information about the base package algorithm. Note this is the standard bill FT algorithm type used for common bill transactions. It supports bill FT for non-billed budgets and other SA types. You only need to create it if it doesn't already exist in your system.
- On [severance event type](#), an algorithm for Non-billed Budget Severance. Refer to the [SVEV-NB](#) algorithm type for more information about the base package algorithm.

---

**NOTE:**

**Payment Schedule Algorithm Types.** For Non-Billed Budget payment schedule algorithm types, you need to define the algorithm types (if you add your own algorithm types). You do not need to define algorithms because the parameter values for the algorithm are defaulted on the recommendation rule and stored with the Non-Billed Budget SA. (Normally the algorithm holds the parameter values.) Refer to the [NBPS-MON](#) algorithm type for more information about the base package payment schedule algorithm.

---

## NBB Debt Class And Collection Process

Set up a separate debt class, collection class control, collection process template and severance process template for Non-Billed Budgets according to the information in [Credit and Collections and Non-Billed Budgets](#).

## SA Types for SAs Covered by NBBs

You must modify the SA type for any SAs that you want to allow to be covered by a Non-Billed Budget.

- Verify that the specified **Bill Segment Type** (on the Billing page) references a financial transaction algorithm to set the current amount to zero for monitored Non-Billed Budgets. The FT creation algorithm type **BBSF-BA** (i.e.,  $\text{Payoff Amt} = \text{Bill Amt} / \text{Current Amt} = \text{Amt Due}$ ) supplied with the base package sets the current amount to zero for SAs that are covered by monitored non-billed budgets, though this is not evident by the name. (For SAs that are not covered by a Non-Billed Budget, the current amount is equal to the amount due or the recurring charge.) Refer to [Billing For SAs Covered By The Non-Billed Budget](#) for more information.
- Set the **Eligible for Non Billed Budget** flag (on the Billing page) to Eligible for Non-Billed Budget .
- Populate the **Adjustment Type (Current = 0)** (on the Detail page) to indicate the adjustment to be used to zero out the current amount on the covered SAs when the Non-Billed Budget SA is activated. Use the Add SA To Non-Billed Budget [adjustment](#) created above. This adjustment type is only called for SAs that are covered by a monitored Non-Billed Budget.
- Reference an **Adjustment Type Profile** (on the Adjustment Profile page) that includes the Add SA To Non-Billed Budget adjustment type referenced in the **Adjustment Type (Current = 0)** field above.
- If not already specified (for write off), an **Adj. Type (Synch Current)** (on the Main page) is also required. It is used to synchronize (make equal) the current amount with the payoff amount when the SA is removed from (i.e. no longer covered by) a Non-Billed Budget.

## NBB Recommendation Rules

Set up any [NBB Recommendation Rules](#) that you want to be available for your Non-Billed Budget SAs. Use any Non-Billed Budget Daily Amount Calculation algorithms defined above. Also use the Non-billed Budget Monthly Payment Schedule ( [NBPS-MON](#) ) algorithm types and specify the default parameters.

## Non-Billed Budget SA Types

You must set up a [SA types](#) for your Non-Billed Budget service agreements. You may need multiple Non-Billed Budget SA types if you have different business rules for different types of Non-Billed Budgets, for example, if you have both monitored and unmonitored Non-Billed Budgets or if you support Non-Billed Budgets with different renewal requirements. The following points provide guidelines for creating a non-billed budget SA type.

### SA Type - Main (NBB)

**Service Type** should reference something like "Miscellaneous Service".

**Distribution Code** should be the one you set up to book credits for Non-Billed Budgets.

**Revenue Class** should be set to N/A. (Revenue classes are not applicable because Non-Billed Budgets do not apply a rate and revenue classes are only relevant for SA types that use a rate.)

The **Payment Segment Type** should reference the Normal Payment.

**Do Not Overpay** should be on. Any excess payments should go to the overpayment SA, not the Non-Billed Budget SA.

**Late Payment Charge** is not applicable and should not be turned on because Non-Billed Budgets are not billed.

**Adj. Type (Synch Current)** should reference the Synch Balance for Non-Billed Budget adjustment type created above.

### SA Type - Detail (NBB)

- **Special Role** is Non-Billed Budget.
- **Adjustment Type (Xfer)** must be populated to indicate the adjustment to be used for transferring accumulated credit from the Non-Billed Budget SA to the covered SAs. This field is not used for unmonitored Non-Billed Budgets.
- **Renewal** may be optional, not allowed, or required depending on your business processes.
- If Renewal is required, specify the **Days Before Expiration for Renewal**.
- **Non-Billed Budget Monitoring** must indicate whether the Non-Billed Budget is monitored by the account debt monitor.

## SA Type - Billing (NBB)

Non-Billed Budget SAs do not get billed, so the **Eligible for Billing** flag should be off.

Additionally, the **Characteristic Premise Required** should not be checked for Non-Billed Budgets.

## SA Type - Rate (NBB)

Non-Billed Budget SAs do not use rates, so the **Rate Required** flag should be off.

## SA Type - SP Type (NBB)

Non-Billed Budget SAs do not have service points, so the **Service Points Required** flag should be off.

## SA Type - Adjustment Profile (NBB)

**Adjustment Type Profile** should reference the [adjustment type profile](#) for Non-Billed Budgets (set up above).

## SA Type - Credit and Collections (NBB)

The credit and collections information should reference a **Severance Process Template** that calls the Non-Billed Budget Severance algorithm created above and expires the Non-Billed Budget SA. The **Debt Class** should reference an appropriate value consistent with your credit and collections rules. Typically, monitored Non-Billed Budgets should be in their own debt class. Unmonitored Non-Billed Budgets should have a **Debt Class** that is not Eligible for Collection.

The **Write Off Debt Class** is not applicable because the Non-Billed Budget contains no debt to be written off. Reference a debt class such as N/A. Refer to [Defining Credit & Collections Options](#) for more information.

## SA Type - Algorithms (NBB)

The SA type [algorithms](#) defined above must be set up:

- The Non-Billed Budget Credit Transfer algorithm created above should be specified for the Bill Completion system event (not used on unmonitored Non-Billed Budgets).
- The Break Non-Billed Budget SA algorithm created above should be specified for the Break NBB SA system event.
- The Non-Billed Budget Process Scheduled Payment algorithm created above should be specified for the Process NBB Scheduled Payment system event (not used on unmonitored non-billed budgets).

- The Non-Billed Budget SA Renewal algorithm created above should be specified for the SA Renewal system event.
- If you created the Automatic SA Activation algorithm above, it should be specified for the SA Creation system event.
- The Non-Billed Budget SA Activation algorithm created above should be specified for the SA Activation system event.
- If you created the Automatic SA Stop algorithm above, it should be specified for the SA Stop Initiation system event.
- The Stop Non-Billed Budget algorithm created above should be specified for the SA Stop system event.

## SA Type - NBB Recommendation Rule (NBB)

Add the recommendation rules defined above that are valid for SAs of this type. Also, indicate which recommendation rule should be used as the default.

## NBB Background Processes

Ensure that the following background processes are scheduled:

- Non-Billed Budget Scheduled Payment Processing ( [NBBPS](#))
- Non-Billed Budget Scheduled Payment Automatic Payment Create ( [NBBAPAY](#))
- Service Agreement Renewal ( [SARENEW](#))
- Stop Expired Service Agreements ( [SAEXPIRE](#))

## Defining Quotation Options

This section describes tables that must be set up before quotations can be created.

---

**FASTPATH:**

For more information, refer to [The Big Picture of Quotations](#).

---

## Setting Up SA Types For Quotes

The topics in this section describe additional setup responsibilities required on SA types that can have proposal service agreements.

---

**NOTE:**

**Assumption.** We have assumed that you've already designed your SA types for the services that you sell. If you haven't done this, refer to [Defining Service Agreement Types](#).

---

## Enabling The Automatic Generation Of Billing Scenarios

As described under [Proposal SAs Contain Billing Scenarios And Template Consumption](#), a proposal SA requires billing scenarios before a quote detail can be generated. The system can automatically create billing scenarios when a proposal SA is created. If this is required for your implementation, create a Proposal SA Creation algorithm type, and plug in the

appropriate algorithm on each applicable Proposal SA type. Refer to [PSAC-CBS](#) for an example algorithm (*note, this algorithm is not applicable for C2M but may be used as a reference only*).

## Enabling The Generation Of Simulated Bill Segments

As described under [Creating Quotes And Quote Details](#), in order for the system to generate simulated bill segments for a proposal SA, you must plug-in a Proposal SA Bill Segment Generation algorithm on the proposal SA's [SA type](#). Refer to [CBSP-AR](#) for an example algorithm that creates a simulated bill segments for each billing scenario linked to the proposal SA by calling rate application.

## Enabling The Creation Of A Real SA When A Quote Detail Is Accepted

As described under [Accepting / Declining Quote Details](#), in order for the system to create a real SA when a proposal SA is accepted, you must plug-in a Proposal SA Acceptance algorithm on the proposal SA's [SA type](#). Refer to [PSAA-PS](#) for an example algorithm that creates a real SA by copying the proposal SA.

---

**NOTE:**

**Interval pricing service agreements.** are not supported. PSAA-PS has a parameter for creating interval profiles, time-of-use maps and contract options when the real SA is created. This specific parameter/option is not applicable for C2M.

---

## Setting Up Quote Route Types

Quote route types control how quotes are [routed](#) to customers and prospects. To define a quote route type, open **Admin > Sales & Marketing > Quote Route Type**.

---

**FASTPATH:**

Refer to [Printing Quotes](#) for more information about how quotes are routed to customers and prospects.

---

### Description of Page

Enter a unique **Quote Route Type** and **Description** for every quote route type.

**Quote Routing Method** controls the type of information that may be defined when the respective **Quote Route Type** is selected on [Account - Person Information](#). The following options are available:

- Postal: Use this method if the routing is via the postal service.
- Fax: Use this method if the routing is via fax.
- Email: Use this method if the routing is via email.

---

**NOTE:**

The values for **Quote Routing Method** are customizable using the [Lookup](#) table. This field name is QTE\_RTG\_METH\_FLG .

---

- The next two fields control how quotes that are routed using this method are [printed](#) (both in batch and online).
- Use **Batch Control** to define the process that creates the flat file that is passed to your quote printing software. Refer to [Technical Implementation of Printing Quotes In Batch](#) for more information about these processes.

- Use **Extract Algorithm** to define the plug-in that constructs the "flat file records" that contain the information merged onto quotes routed using this method. Refer to [Printing Quotes](#) for more information.

#### Where Used

Follow this link to open the data dictionary where you can view the tables that reference [CI\\_QTE\\_RTE\\_TYPE](#).

## Setting Up Terms and Conditions

As described under [Legal Terms and Conditions May Be Specified On SAs](#), your **SA type start options** can reference terms and conditions (T&C's) that should be defaulted onto new service agreements (both real and proposal). Each T&C is identified with a terms and condition code. To define a terms and conditions code, open **Admin > Sales & Marketing > Terms and Conditions > Add**.

---

#### NOTE:

**T&C print order.** The value of the T&C code controls the order in which the T&C appears on the printed quote. This means you should assign these codes in some type of structured format (e.g., 01...) if you would like them to appear in a certain order.

---

#### Description of Page

Enter a unique **Terms and Condition** code and **Description**. Use **Text** to describe the exact terms.

#### Where Used

Follow this link to open the data dictionary where you can view the tables that reference [CI\\_TC](#).

## Setting Up Decline Reasons

A proposal SA decline reason must be supplied when a proposal SA is declined. Open **Admin > Sales & Marketing > Proposal SA Decline Reason** to define your reason codes.

#### Description of Page

Enter an easily recognizable **Decline Reason** and **Description** for each proposal SA decline reason.

#### Where Used

Decline reasons are used when a [quote detail is declined](#).

## Setting Up Customer Classes For Quotes

An optional plug-in spot exists on [customer class](#) where you can introduce additional logic to be executed when a quote is completed for an account that belongs to this customer class. The base package comes supplied with a sample algorithm that creates a workflow process when a quote is completed (refer to the algorithm [QTEC-WP](#) for more information).

## Defining Case Management Options

Case management functionality is a highly configurable tool your organization can use to manage many situations, including (but certainly not limited to) the following:

- a high-bill complaint,
- a bankruptcy,
- an inspection of a premise,
- a customer's request for literature,
- an application for new service,
- a contractor's request to extend a line,
- a customer's rejection of a quote,
- a customer's request to change service providers on a future date,
- the processing of a market message in a deregulated environment,
- ... (the list is only limited by your time and imagination)

Obviously the steps involved in the resolution of the above cases are very different. The topics in this section describe how to configure the system to manage your cases as per your organization's desires.

---

**NOTE:**

**Separate module.** The Case Management functionality is associated with a separate module. If the Case Management module is not applicable to your business you may turn it off. Refer to [Turn Off A Function Module](#) for more information.

---

**FASTPATH:**

Refer to [Case Management](#) for a description of how end-users use cases.

---

## The Big Picture Of Cases

The topics in this section provide background information about how to configure the system to support your case management requirements.

### Case Type Controls Everything

Whenever a user creates a case, they must specify the type of case (e.g., high-bill complaint, literature request, etc.). The case type controls how the case is handled.

Case types hold the business rules that control cases. Since these business rules can sometimes be quite complicated, setting up case types requires planning and foresight. The topics in this section describe the type of business rules that can be configured on your case types.

### Person / Account / Premise Applicability

Some types of cases may be person-oriented, others may be premise-oriented, and still others may be account-oriented. For example:

- Cases used to keep track of a literature request would reference the person who requested the literature.
- Cases used to keep track of the inspection of a property would reference the premise being inspected.
- Cases used to keep track of a high-bill complaint would reference the account associated with this bill(s) being disputed.



When you set up a case type, you define if its cases must reference a person, account, and/or premise. Note, any combination of these objects is permitted on a case.

## Contact Information Applicability

When a case is created, you may want to keep track of how to contact its originator. For example, you may want to record the originator's email address or phone number. When you set up a case type, you define if contact information is required, optional or not allowed on its cases.

## Business Object Association

A case type may reference a Business Object, which serves as a link between cases of that type and the options that are associated with the business object.

## Additional Information

Some of your cases may require additional information (in the form of [characteristics](#)). For example, a high-bill complaint may require at least one bill. When you set up a case type, you can define the additional fields that are required. In addition, you can define default values for these fields.

The case functionality also allows you to require characteristics when a case enters a given state. Refer to [Required Fields Before A Case Enters A State](#) for the details.

---

**NOTE:**

**Requiring supporting documents.** Because any [type of characteristic](#) can be referenced on a case, you can require references to supporting documents by requiring a file location characteristic.

---

## Access Rights

You can take advantage of the system's [security](#) to restrict cases of a given type to certain users. For example, you can restrict high-bill complaints to specific user groups.

The following points describe how to implement this type of security:

- Create an [application service](#) for each type of case you need to secure
- Define the access modes Add, Inquire and Change for each application service
- Define the applicable application service on each case type
- Link the appropriate [user groups](#) to each application service
  - For user groups that are allowed to add cases of a given type, define Add as a valid access mode.
  - For user groups that are allowed to view cases of a given type, define Inquire as a valid access mode
  - For user groups that are allowed to change cases of a given type, define Change as a valid access mode

If you restrict access to a case type's cases, you can further restrict which users can work on cases given the status of the case. Refer to [Which Users Can Transition A Case](#) for more information.

---

**NOTE:**

**Restricting access to cases is optional.** If you don't specify an application service on a case type, all users (who have access to the case transaction) may access its cases.

---

## Lifecycle

Many objects in the system have predefined lifecycles whose rules are governed by the base-package and cannot be changed. For example, a service agreement starts out in the Pending Start state and eventually becomes Closed when it's been final billed (and paid). You can't change the system to allow a service agreement to start its life in the Closed state.

The lifecycle of cases is not governed by the base package. Rather, you define the lifecycle of your cases when you set up their case types. Examine the following diagrams; the one on the left shows the potential lifecycle of a case that manages a high-bill complaint, the one on the right shows the potential lifecycle of a case that manages a customer's literature request.

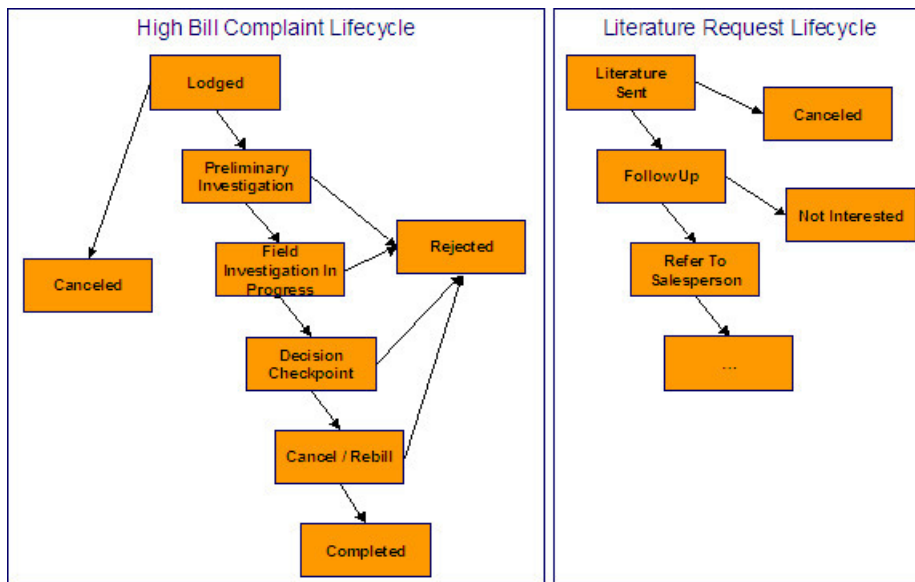

*Potential Lifecycles Of Two Types Of Cases*

---

**NOTE:**

**Just examples.** The above lifecycles are just examples. When you set up your case types, you must define the valid states for your case type.

---

The topics that follow describe important concepts that are illustrated in the above diagrams.

## Valid States versus State Transition Rules

The orange boxes in the above diagram show the potential valid states a given case can have. The lines between the boxes indicate the state transition rules. These rules govern the states a case can move to while it's in a given state. For example, the above diagram indicates a high bill complaint that's in the Lodged state can be either Canceled or moved into the Preliminary Investigation state.

When you set up a case type, you define both its valid states and the state transition rules.

## Transitory States

You can define a state in a case type as **Transitory** if you do not wish the case to exist in a particular state. For example, let's assume that an algorithm is associated with the Decision Checkpoint state (Enter Processing) that would automatically determine the next state for the case (i.e. Cancel/Rebill or Reject ) and also contains logic to transition the case accordingly. In this scenario, you may not ever want the case to exist in the Decision Checkpoint state, so that a user won't ever see a high bill complaint in that state. If the other states were marked as non-transitory, and an error were to occur during the transition from Decision Checkpoint to Cancel/Rebill, the case would roll back any changes to data made in the Cancel/Rebill (Enter Processing) state along with the changes made in the Decision Checkpoint state, and would end up in the Field Investigation In Progress state - the last non-transitory state prior to Decision Checkpoint.

## One Initial State and Multiple Final States

When you set up a case type's states, you must pick one as the initial state. The initial state is the state assigned to new cases of a given type. For example, high-bill complaint cases have an initial state of Lodged, whereas literature request cases have an initial state of Literature Sent.

You must also define which statuses are considered to be "final". When a case enters a "final" state, it is complete and no further action is necessary. You might want to think of the "final" states as the potential outcomes of a case. For example, a high-bill complaint has potential outcomes of Completed, Rejected, and Canceled.

The "final" states are used by the system to differentiate between open and closed cases. For example, an alert highlights when the person / account / premise in context has open cases (this alert only exists if you've plugged-in the appropriate installation [alert](#)).

## Allowing A Case To Be Reopened

You can set up your state transition rules to allow a case to be reopened (i.e., to be moved from a final state to a non-final state). Neither of the above examples allows this, but it is possible if you configure a case type accordingly.

## Make Sure To Have A Canceled State

The system does not allow you to delete a case. Therefore, if you want to support logical deletion, you should have a status of Canceled early in a case type's lifecycle. Doing this allows a user to cancel (i.e., logically delete) a case.

---

**NOTE:**

**Cancel reason.** You might want to consider setting up your case types to require a cancel reason (in the form of a [predefined value characteristic](#)) when a user cancels a case. Refer to [Required Fields Before A Case Enters A State](#) for more information.

---

## Buttons Are Used To Transition A Case From Status To Status

When a case is displayed on [Case - Main](#), a separate button is shown for each state into which the case can be transitioned. For example, a high-bill complaint case that is in the Lodged state would show two buttons: **Start Investigation** and **Cancel**. If the user presses the **Start Investigation** button, the case is transitioned to the Preliminary Investigation state. If the user presses the **Cancel** button, the case is moved to the Canceled state.

You may define the text displayed on the button differently for each state transition. This allows the action description to be varied according to the previous status. For example, the button to transition from New to Active may be labeled **Activate**, but the button to change from Closed to Active may be labeled **Reactivate**.

Refer to [Which Users Can Transition A Case](#) for instructions describing how to restrict users to specific actions.

## State Transitions Are Audited

The system maintains an audit trail whenever a case transitions from one state to another. This audit is shown in the case's [log](#).

## Reports and Analytics Highlight Productivity

When you set up a case type's lifecycle, keep in mind that several reports and analytics highlight how long it took cases to transition into a state. For example, you can use a report to see how long it took high-bill complaints to be completed (or initially actioned or ...). Refer to the [Reports](#) chapter for the details of case reports.

## Status-Specific Business Rules

As described in [Lifecycle](#), when you set up a case type, you define the possible states its cases can pass through. The following topics describe business rules that can be configured for each state.

## A Script That Helps A User Work Through A Case

You can define a [Business Process Assistant script](#) that helps a user work a case while it's in a given state. For example, when you set up the Preliminary Investigation state for the high-bill complaint case type, you can define a script. A user can then easily launch this script to help them work through a case in this state.

Please keep the following in mind when you're designing how to integrate BPA scripts with your cases:

- You can have a different script for each state. For example, you could develop a script to help a user work on a case while it's in the Preliminary Investigation state and a different script to help them work in a case while it's in the Decision Checkpoint state.
- Rather than make a user launch a script by pressing a hyperlink on the [case page](#), you can have the system automatically launch the script while the case is in a given state. Refer to [Script Launching Option](#) for more information.
- You can also have the system automatically launch a script when a user selects a To Do entry. Refer to [Launching Scripts When To Do Entries Are Selected](#) for more information.

---

### **FASTPATH:**

Refer to [Scripts and Cases](#) for more information about how to streamline your case processing with scripts.

---

## Required Fields Before A Case Enters A State

You can define additional fields (i.e., characteristics) that are required before a case can enter a given state. For example,

- You can indicate a high-bill complaint must reference at least one bill before it enters the Preliminary Investigation state.
- You can indicate a case must reference a cancel reason before it enters the Canceled state.

You do this by indicating that [characteristics](#) (that were optional when the case was added) are required when a case enters a given state.

## Validation Before A Case Enters A State

You can define validation that executes before a case can enter a given state. For example, you can indicate the case must have been assigned a responsible user before it can enter the Preliminary Investigation state. This validation logic is held in algorithms that are plugged in on the case type and therefore you can define any type of validation.

## Additional Processing When Entering A State

You can define additional processing that should happen when a case enters a given state. For example, you can have a [letter](#) created when a high-bill complaint case is Rejected. Similarly, you can have a [To Do entry](#) created when a high bill complaint enters the Preliminary Investigation state. This additional processing is held in algorithms that are plugged in on the case type and therefore you can define any type of additional processing.

You can also incorporate state transitioning logic within routines that are executed when a case enters a state, so that you do not need to rely upon CASETRAN to transition your cases. For example, when the state entry routines of the Preliminary Investigation status for a high-bill complaint are executed, they may be designed to transition the case into either the Rejected or Field Investigation In Progress state without waiting. Note that your Exit Validation and Exit Processing logic, if configured for the case state, will still be executed as part of the state transition. Auto-Transition logic for this state will be ignored during this transition.

## Validation Before A Case Exits A State

You can define validation that executes before a case can exit a given state. For example, you might want to check the account's balance is less than a given value before a case can exit a given state. This validation logic is held in algorithms that are plugged in on the case type and therefore you can define any type of validation.

## Additional Processing When Exiting A State

You can define additional processing that should happen when a case exits a given state. For example, you can have a [To Do entry](#) automatically completed when a high bill complaint leaves the Decision Checkpoint state. This additional processing is held in algorithms that are plugged in on the case type and therefore you can define any type of additional processing.

## Automatic Transition Rules

You can define rules that automatically transition a case into a different state. For example, you can indicate a literature request should be transitioned to the Follow Up state 1 week after the literature is sent. Similarly, you can indicate a high-bill complaint should transition to the Decision Checkpoint state after the fieldwork is complete. These rules are held in algorithms that are plugged in on the case type and therefore you can define any type of automatic transition rules.

Cases in a state with automatic transition rules are monitored by the [CASETRAN](#) background process. Each time this program runs, the respective automatic transition plug-in is called for each such case and it transitions the case if the condition applies.

---

**NOTE:**

**When to execute CASETRAN.** Because your automatic transition rules will be dependent on your business requirements, you need to think carefully about when you run the **CASETRAN** background process. For example, if you have automatic transition rules that transition a case to a new state when a related field activity is completed, you would want to schedule this job to run after field activities are uploaded. If you have rules to transition a case after a customer pays a deposit, you'd want to schedule this job to run after payments are uploaded. Bottom line - your business rules will dictate the frequency of execution.

---

When the user adds a new case or changes the state of a case manually the system attempts to auto-transition the case to subsequent statuses as necessary. If auto-transition rules apply to the new state (and to subsequent ones) they would be executed right away. In other words, you don't need to wait for the auto-transition background process to be executed. An indication that the case was auto-transitioned online is displayed right below the action buttons section.

---

**NOTE:**

**Auto-Transition Errors.** Online auto-transition is performed recursively committing each successful state transition to the database. It is performed up to 100 times or until an error is encountered during the process. If this happens, auto-transition stops at the last **non-transitory** state into which a successful transition had occurred. Two case log entries will be generated automatically - one containing the message that a transition error has occurred, and a second containing the actual error message. A To Do entry will also be generated automatically upon rollback. The type of this To Do entry will be taken from 1) the Case Transition Exception To Do Type **option** for the **Business Object** associated with the case type, and if this is not populated, 2) the Exception To Do Type indicated on the Case Options Feature Configuration. All of the above error handling is true for both batch and online processing of cases.

---

**NOTE:**

**Triggering Auto-Transition.** If you have a customized process that affects the state of a case and you want the case to be auto-transitioned right away, i.e. not wait for the next scheduled **CASETRAN** background process to execute, you can customize that process to trigger auto-transition for the specific case, or you can put the state transition logic into the routines that execute at state entry time.

---

## Script Launching Option

You can define whether the script associated with a given state is to be automatically launched while the case is in that state. The system supports the following options:

- Launch the script only if no script is currently active.
  - Always launch the script unless this specific script is currently active.
- 

**WARNING:**

With this option, if a script is currently open in the page's BPA script area then it will be automatically closed and the case script will open.

---

- Do not automatically launch the script.

You do this by plugging-in a Script Launching algorithm for the given state. If no such plug-in is provided the script is not automatically launched.

## Which Users Can Transition A Case Into A State

If you have [restricted access](#) to a case type, you can further restrict which user groups are allowed to transition a case into specific states. For example, you can control which user group can transition a high bill complaint into the Preliminary Investigation state. The following points describe how this is done:

- Define actions on the [application service](#) defined on the case type. You must define an action for each status that you need to secure.
- Define each status's corresponding action. Note, you only need to link a status to an action if it's secured. Any user with [access](#) to the case type can perform statuses that aren't linked to actions.
- Define the transition role for each status's valid next status. You can assign valid next statuses to be reachable via system (only), or system and user.
- Define which [user groups](#) have access to the actions (i.e., statuses). In addition, these user groups should have access to the Change action.

## Responsible User Applicability

Some of your cases may require a "responsible user". This is the user who has overall responsibility for the case. When you set up a case type, you define if a responsible user is required, optional or not allowed on its cases.

The following points describe how to set up the system if a responsible user is not required when a case is first created, but is later in its lifecycle:

- Indicate that a responsible user is optional on the case type
- Plug-in either an [exit validation](#) or [entry validation](#) algorithm on one of the case type's states to require a responsible user at some point in a case's lifecycle

---

### NOTE:

**Address To Do entries to the responsible user.** If you use the [base-package algorithm](#) to create a To Do entry when a case enters a given state, you can indicate that the To Do entry should be addressed to the responsible user on the case.

---

## Scripts and Cases

There are three ways [Business Process Assistant scripts](#) can be used to manage cases:

- You can create a BPA script to help users create a case. For example, a script can help a user create a new high-bill complaint.
- Using a script to create a case can save a user a lot of time (and training efforts). This is because the script can automatically populate many fields on the case based on answers to questions.

Refer to [Initiating Scripts](#) for a description of how end-users initiate scripts.

- You can create a script to help users work on a case when it's in a given state. Refer to [A Script That Helps A User Work A Case](#) for more information.
- You can [set up your case types to create To Do entries](#) to notify users when cases exist that require their attention. Users can complete many of these ToDo entries without assistance. However, you can set up the system to automatically launch a script when a user selects a ToDo entry. For example, consider a ToDo entry that highlights a high-bill complaint that requires investigation. You can set up the system to execute a specific script when a user selects this ToDo entry. This script might guide the user through the investigation process (and help them update the case). Refer to [Executing A Script When A To Do Entry Is Selected](#) for more information.

## To Do's and Cases

The topics in this section provide background information about how to facilitate case management with [To Do entries](#).

### Creating and Completing To Do Entries

You can configure your case types to create and complete [To Do entries](#) when a case enters or exits a state. Let's use the following [lifecycle diagram](#) to illustrate a potential use of To Do's:

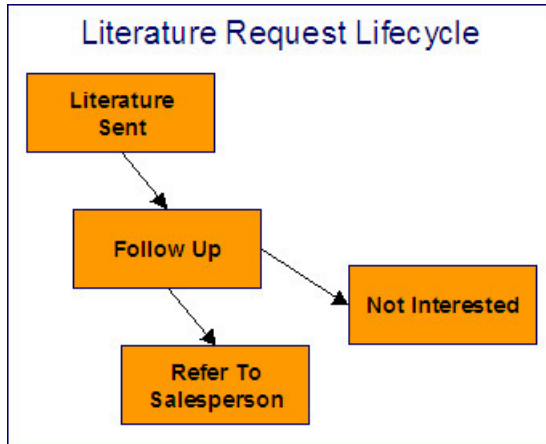

Let's assume the following:

- You want a To Do entry created when a literature request case enters the Follow Up state. You want this To Do automatically completed when the case enters either the Refer To Salesperson or Not Interested states. Note, we refer to this as the "first" To Do entry below.
- You want a different To Do entry created when a case enters the Refer To Salesperson state. You do not want the system to automatically complete this entry (the sales person must manually do this). Note, we refer to this as the "second" To Do entry below.

To implement the above, you would set up a case type as follows:

- Plug-in an [entry processing](#) algorithm on the Follow Up status to create the first To Do entry.
- Plug-in an [exit processing](#) algorithm on the Follow Up status to complete the first To Do entry.
- Plug-in an [entry processing](#) algorithm on the Refer To Salesperson status to create the second To Do entry.

While the case type illustrated above had a single To Do entry "active" at any point in time, you can easily configure a case type to have multiple To Do entries active at any point in time. Let's use the following lifecycle diagram to illustrate this point:



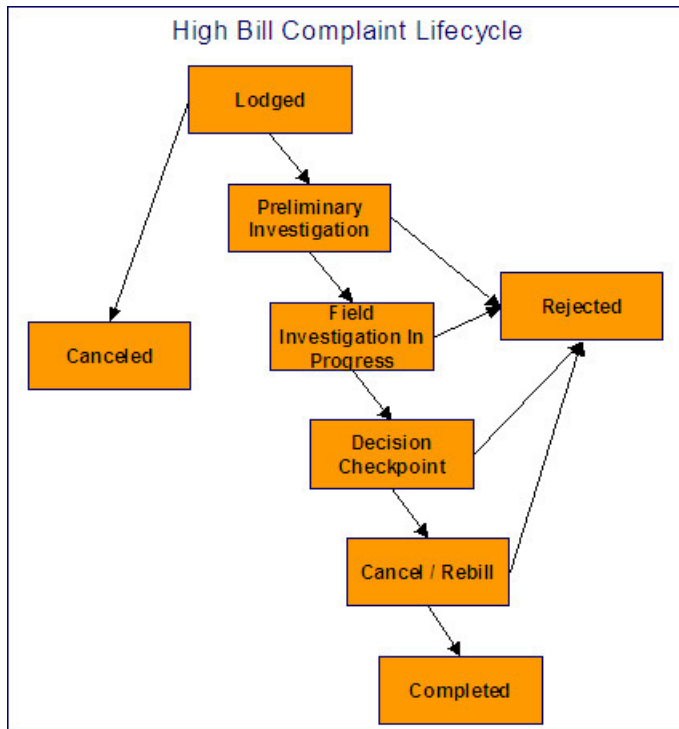

Let's assume the following:

- You want a To Do entry created when a high bill complaint is created and you want it completed when the case reaches the Canceled, Rejected or Approved states. This To Do entry could be used by a supervisor to monitor the number of high-bill complaints being worked. Note, we refer to this as the "first" To Do entry below.
- You want a different To Do entry created when the case enters the Preliminary Investigation state and you want this entry automatically completed when the case leaves this state. Note, we refer to this as the "second" To Do entry below.
- You want a different To Do entry created when the case enters the Decision Checkpoint state and you want this entry automatically completed when the case leaves this state. Note, we refer to this as the "third" To Do entry below.

To implement the above, you would set up the case type as follows:

- Plug-in an [entry processing](#) algorithm on the Lodged status to create the first To Do entry. Plug-in an [entry processing](#) algorithm on the Canceled, Rejected and Completed statuses to complete this entry.
- Plug-in an [entry processing](#) algorithm on the Preliminary Investigation status to create the second To Do entry. Plug-in an [exit processing](#) algorithm on the Preliminary Investigation status to complete this entry. We elected to use an exit processing algorithm because we only have to plug it in on one status. If we'd used an entry processing algorithm, we would need to plug it in on the 2 statuses into which a Preliminary Investigation status can transition.
- Plug-in an [entry processing](#) algorithm on the Decision Checkpoint status to create the third To Do entry. Plug-in an [exit processing](#) algorithm on the Decision Checkpoint status to complete this entry.

## Launching Scripts When To Do Entries Are Selected

You can set up your case types to create To Do entries to notify users when cases exist that require their attention. Users can complete many of these To Do entries without assistance. However, you can set up the system to automatically launch a script when a user selects a To Do entry. For example, consider a To Do entry that highlights a high-bill complaint that requires investigation. You can set up the system to execute a specific script when a user selects this type of To Do entry. This script might guide the user through the investigation process. Refer to [Executing A Script When A To Do Entry Is Selected](#) for more information.

## All To Do Entries Are Visible

When a case is displayed on [Case Maintenance](#), the system summarizes the number of To Do entries associated with the case (if you've [set up your To Do types](#) appropriately).

## Examples of Case Types

The topics that follow provide examples of case types related to several business processes. Use the information in this section to form an intuitive understanding of case types. After attaining this understanding, you'll be ready to design your own case types.

### High Bill Complaint

Some organizations will set up a case to manage a high-bill complaint. The following diagram illustrates how such a case type might look:

**Case Type – High Bill Complaint**

Person / Account / Premise Applicability	
Field	Applicability
Person	Required
Account	Required
Premise	Optional

**Secured**

Yes, all actions

Fields To Be Captured		
Field	Required / Optional	Default Value
Bill ID	Optional	..
Cancel reason	Optional	..
Reject reason	Optional	..

Applicability Rules	
Field	Applicability
Responsible User	Optional
Contact Information	Optional

Note the following about the High Bill Complaint case type:

- Notice that we set up the case type to require a person and an account, but premise is optional. This is because a bill can span multiple premises and knowing the premise isn't so important on cases of this type.
- We need to restrict high-bill complaints to specific user groups. This means we need to [set up a specific application service](#) for this case type (that has a separate "action" for each status).
- Cases of this type have 3 additional fields over their lifetime. Notice the following:

- The **Bill ID** characteristic is set up to be optional. This is because we've assumed that sometimes a high-bill complaint case can be lodged when you can't find the bill in question and you still want to log the case.
- Later in this section, you'll see that we've configured the Preliminary Investigation status to require a **Bill ID** before a case can enter this state.
- Both the **High Bill Complaint Cancel Reason** and **Reject Reason** are optional. Later in this section, you'll see that we've configured the Canceled and Rejected statuses to require these fields, respectively.
- Cases of this type do not need a **Responsible User** when first created. Later in this section, you'll see how we've configured the Preliminary Investigation status to require a **Responsible User** before a case can enter this state.
- Cases of this type do not need **Contact Information**. This was a subjective decision and depends on your organization's philosophy.

The topics that follow describe each of the statuses in a high-bill complaint's [lifecycle](#). We have assumed the following state transition rules:

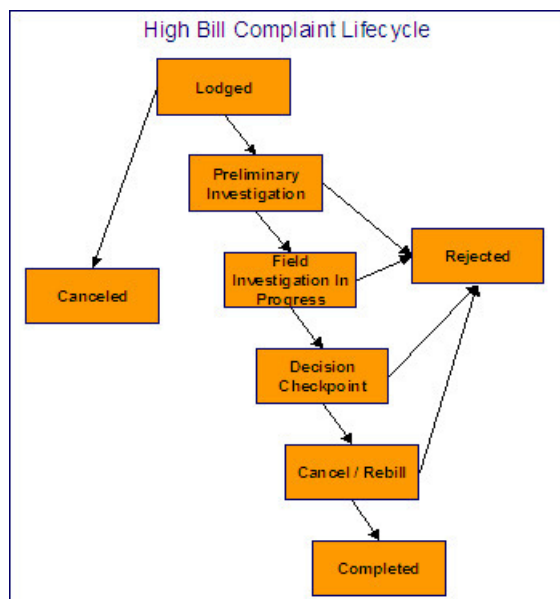

## Lodged High Bill Complaint

The following is an example of the configuration of the Lodged status for high bill complaint cases.

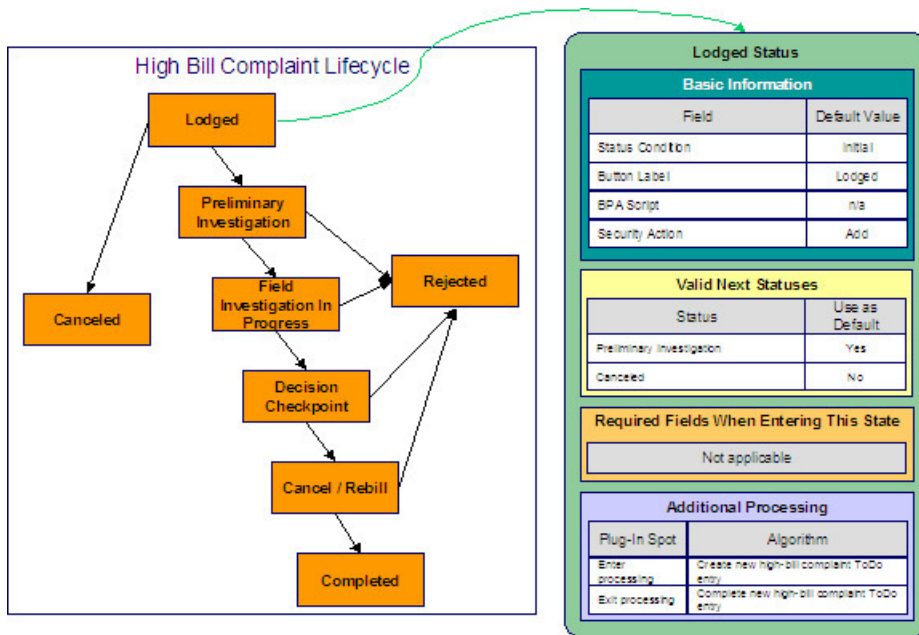

Note the following about this status:

- Lodged is the initial state. The initial state is the state populated on new cases of a given type. Remember that only one status can be defined as the initial state.
- It has a button label even though it's the initial state. The above diagram doesn't allow a user to ever transition a case into this state and therefore there will never be a button with such a label. However, it's a required field just in case you change your business rules.
- We have decided not to use a BPA script to help a user work on a high-bill complaint when it's in this state (this is probably not the best decision as BPA scripts can be quite useful).
- We have associated the Add action with this status. This means that only users with rights to the add action for the application service defined on the case type can add cases of this type.
- Notice that Valid Next Statuses are what restricts a case in this state to be transitioned to the Canceled and Preliminary Investigation states.
- Notice that the Additional Processing plug-ins create and complete a To Do entry when a case enters and exits this state, respectively.

## Preliminary Investigation High Bill Complaint

The following is an example of the configuration of the Preliminary Investigation status for high bill complaint cases.

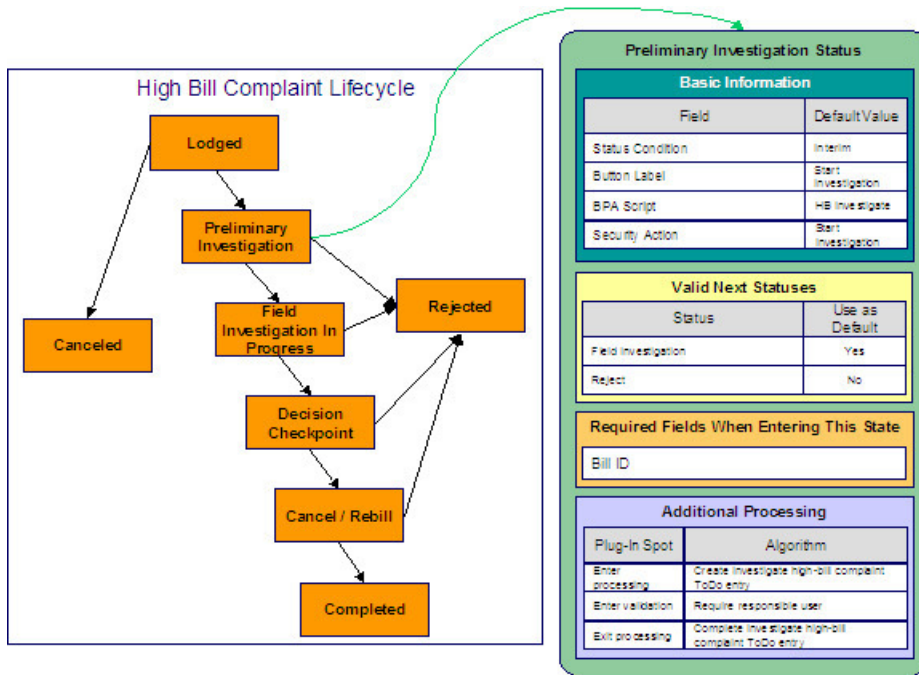

Note the following about this status:

- Preliminary Investigation is an interim state (meaning that it's not an initial or final state).
- It has a button label of **Start Investigation**. This is the label on the button that a user presses to move a case into this state. This button will only appear on cases that are in the Lodged state as this is the only state that can transition into the Preliminary Investigation state.
- We have decided not to specify a BPA script on this status. Rather, we're going to set up the To Do type used to highlight cases in this state to automatically launch an appropriate BPA script when a user selects the To Do entry.
- We have associated the Start Investigation action with this status. This means that only users with rights to this action for the application service defined on the case type can move a case into this state.
- Notice that Valid Next Statuses are what restricts a case in this state to be transitioned to the Field Investigation and Rejected states.
- Notice that a **Bill ID** must be specified on the case before it can be moved into this state.
- Notice that the Additional Processing plug-ins do the following:
  - Create and complete a To Do entry when a case enters and exits this state, respectively
  - Require a responsible user before a case can enter this state

## Field Investigation High Bill Complaint

The following is an example of the configuration of the Field Investigation In Progress status for high bill complaint cases.

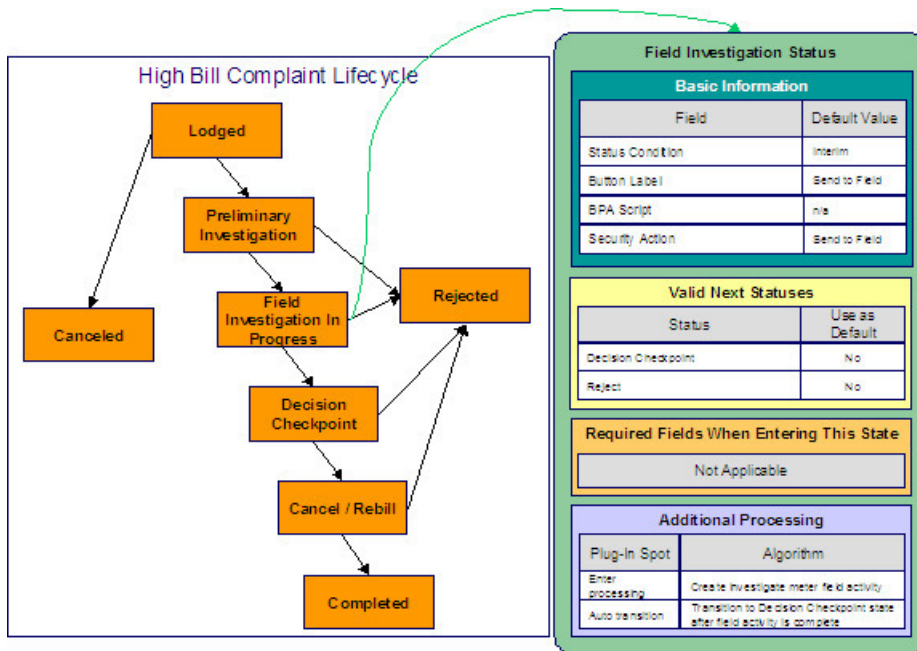

Note the following about this status:

- Field Investigation In Progress is an interim state (meaning that it's not an initial or final state).
- It has a button label of **Send to Field**. This is the label on the button that a user presses to move a case into this state. This button will only appear on cases that are in the Preliminary Investigation state as this is the only state that can transition into the Field Investigation in Progress state.
- We have decided not to specify a BPA script on this status because users don't work cases in this state (see the Additional Processing notes below for why this is the case).
- We have associated the Send to Field action with this status. This means that only users with rights to this action for the application service defined on the case type can move a case into this state.
- Notice that Valid Next Statuses are what restricts a case in this state to be transitioned to the Decision Checkpoint and Rejected states.
- Notice that the Additional Processing plug-ins do the following:
  - Create a field activity when a case enters this state
  - Cause the case to automatically transition to the Decision Checkpoint state when the field activity is completed

## Decision Checkpoint High Bill Complaint

The following is an example of the configuration of the Decision Checkpoint status for high bill complaint cases.

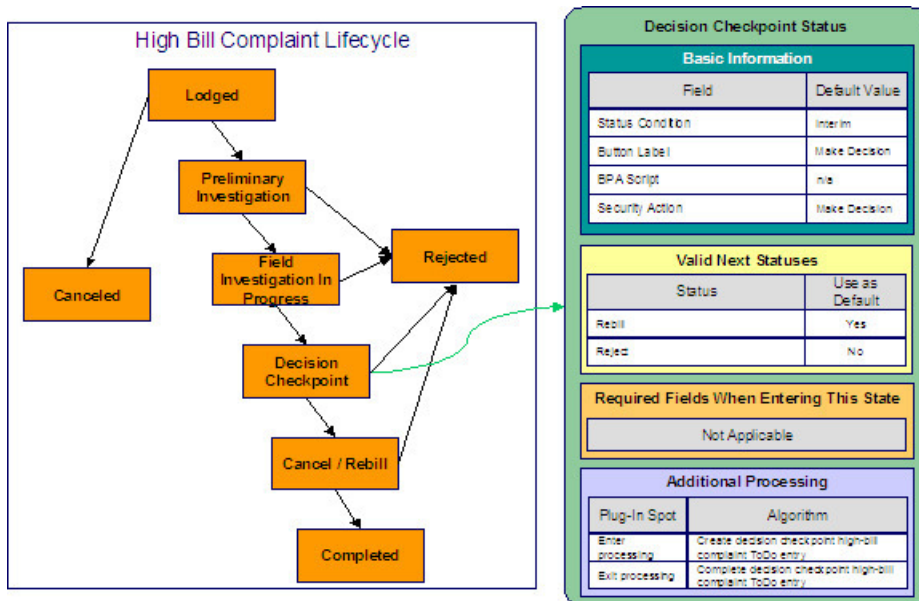

Note the following about this status:

- Decision Checkpoint is an interim state (meaning that it's not an initial or final state).
- It has a button label of **Make Decision**. This is the label on the button that a user presses to move a case into this state. This button will only appear on cases that are in the Field Investigation in Progress state as this is the only state that can transition into the Decision Checkpoint state.
- We have decided not to specify a BPA script on this status. Rather, we're going to set up the To Do type used to highlight cases in this state to automatically launch an appropriate BPA script when a user selects the To Do entry.
- We have associated the Make Decision action with this status. This means that only users with rights to this action for the application service defined on the case type can move a case into this state. Because the system will automatically transition cases into this state when the related field activity is complete, users will probably never press this button (and you may wish to prevent users from pressing this button by restricting security rights to the related action).
- Notice that Valid Next Statuses are what restricts a case in this state to be transitioned to the Cancel / Rebill and Rejected states.
- Notice that the Additional Processing plug-ins create and complete a To Do entry when a case enters and exits this state, respectively.

## Cancel Rebill High Bill Complaint

The following is an example of the configuration of the Cancel / Rebill status for high bill complaint cases.

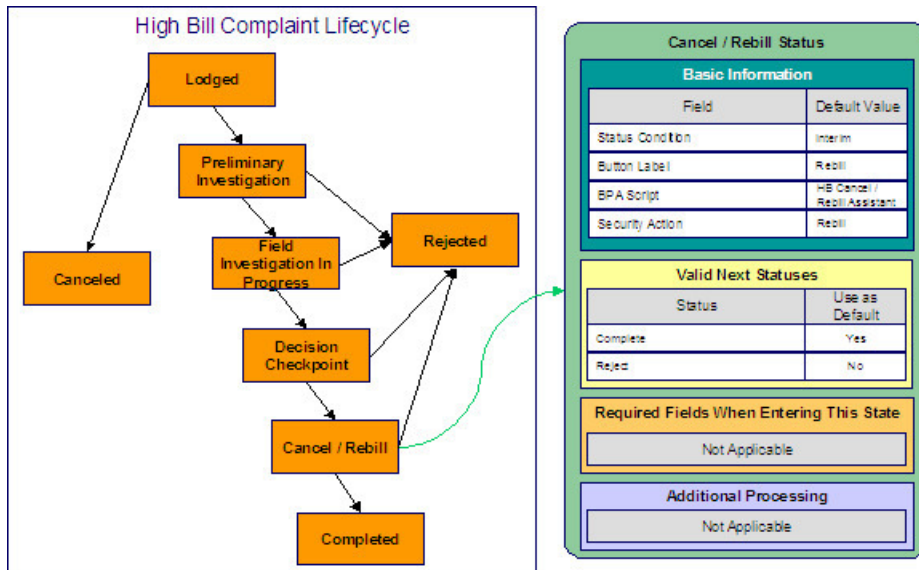

Note the following about this status:

- Cancel / Rebill is an interim state (meaning that it's not an initial or final state).
- It has a button label of **Cancel / Rebill**. This is the label on the button that a user presses to move a case into this state. This button will only appear on cases that are in the Decision Checkpoint state as this is the only state that can transition into the Cancel / Rebill state.
- We have referenced a BPA script that can assist a user in the cancel / rebill efforts.
- We have associated the Rebill action with this status. This means that only users with rights to this action for the application service defined on the case type can move a case into this state.
- Notice that Valid Next Statuses are what restricts a case in this state to be transitioned to the Completed and Rejected states.

## Completed High Bill Complaint

The following is an example of the configuration of the Completed status for high bill complaint cases.



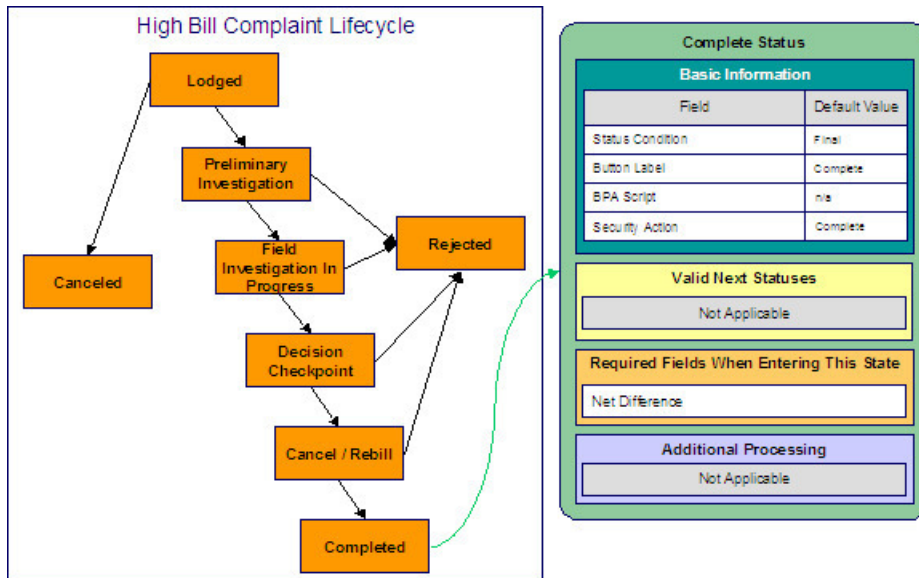

Note the following about this status:

- Completed is a final state (meaning that no further action is necessary).
- It has a button label of **Complete**. This is the label on the button that a user presses to move a case into this state. This button will only appear on cases that are in the Cancel / Rebill state as this is the only state that can transition into the Completed state.
- We have not referenced a BPA script because this is a final state (and no additional user action is necessary).
- We have associated the Complete action with this status. This means that only users with rights to this action for the application service defined on the case type can move a case into this state.
- Notice that there are no Valid Next Statuses (because this is a final state). If you wanted to allow a Completed case to be reopened, you would need to define the state into which a Completed case could be transitioned.
- Notice that the **Net Difference** must be specified on the case before it can be moved into this state. This would be the difference to the customer's balance after the cancel/rebill took place.

## Rejected High Bill Complaint

The following is an example of the configuration of the Rejected status for high bill complaint cases.

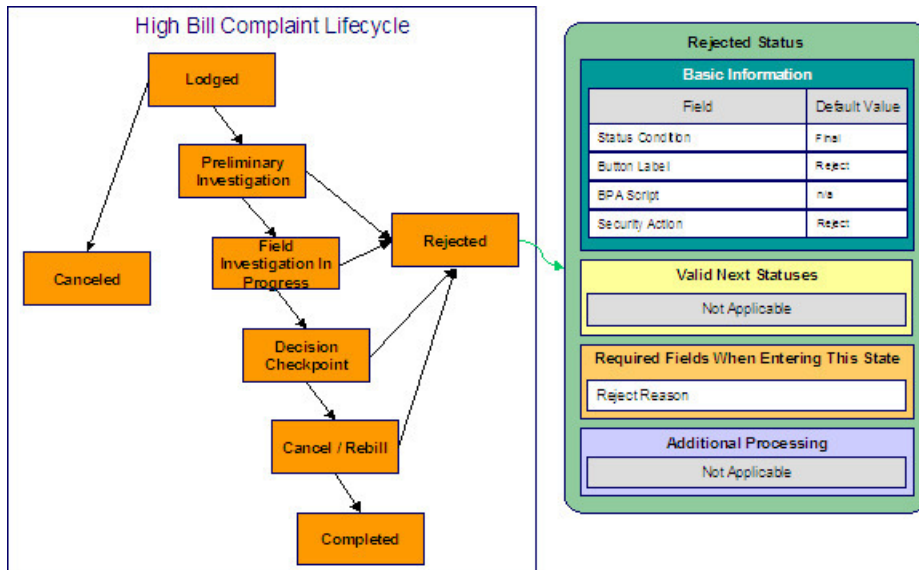

Note the following about this status:

- Rejected is a final state (meaning that no further action is necessary).
- It has a button label of **Reject**. This is the label on the button that a user presses to move a case into this state. This button will appear on cases that are in the Preliminary Investigation, Field Investigation in Progress , Decision Checkpoint and Cancel / Rebill states.
- We have not referenced a BPA script because this is a final state (and no additional user action is necessary).
- We have associated the Reject action with this status. This means that only users with rights to this action for the application service defined on the case type can move a case into this state.
- Notice that there are no Valid Next Statuses (because this is a final state). If you wanted to allow a Rejected case to be reopened, you would need to define the state into which a Rejected case could be transitioned.
- Notice that a **Reject Reason** must be specified on the case before it can be moved into this state.

## Canceled High Bill Complaint

The following is an example of the configuration of the Canceled status for high bill complaint cases.

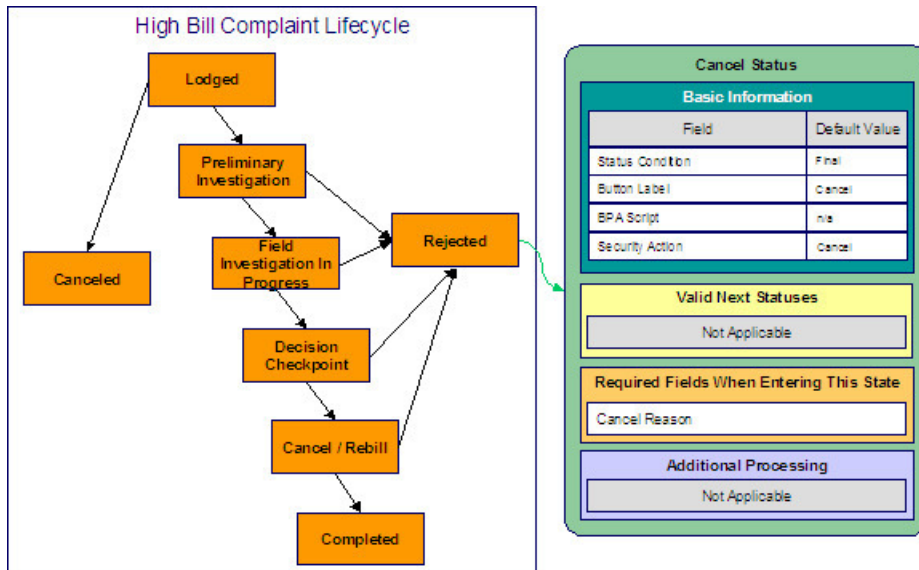

Note the following about this status:

- Canceled is a final state (meaning that no further action is necessary).
- It has a button label of **Cancel**. This is the label on the button that a user presses to move a case into this state. This button will only appear on cases that are in the Lodged state as this is the only state that can transition into the Completed state.
- We have not referenced a BPA script because this is a final state (and no additional user action is necessary).
- We have associated the Cancel action with this status. This means that only users with rights to this action for the application service defined on the case type can move a case into this state.
- Notice that there are no Valid Next Statuses (because this is a final state). If you wanted to allow a Canceled case to be reopened, you would need to define the state into which a Canceled case could be transitioned.
- Notice that a **Cancel Reason** must be specified on the case before it can be moved into this state.

## Setting Up Case Management Options

The topics in this section describe how to set up the system to enable case management.

### **WARNING:**

The following topics assume you thoroughly understand the concepts described under [The Big Picture Of Cases](#).

## Installation Options

### Case Info May Be Formatted By An Algorithm

An algorithm may be plugged in on the [installation record](#) to format the standard case information that appears throughout the system. Refer to [CSIN-DFLT](#) for an example of this algorithm.

This algorithm may be further overridden by a "Case information" plug-in on the [Case Type](#). Refer to [C1-CT-INFO](#) for an example of this algorithm.

## Alert Info Is Controlled By An Installation Algorithm

An algorithm that is plugged in on the [installation record](#) is responsible for formatting the alerts that highlight if the person / account / premise in context has open cases. Refer to [CCAL-CASE](#) for an example of this algorithm.

## Setting Up Application Services

As described under [Access Rights](#), you can prevent unauthorized users from accessing cases. The following points describe how to implement this type of security:

- Create an [application service](#) for each case type that needs to be secured
- Create an action on the application service for each status you need to secure
- Link the valid [user groups](#) to the application service and define which actions they can perform
- Define the application service on the [case type](#)
- Define the related action for each status on the [case type / status](#)

## Setting Up Scripts

As described under [Scripts and Cases](#), BPA scripts can facilitate the creation and working of cases. Refer to the [Defining Script Options](#) for instructions describing how to set up scripts.

## Setting Up To Do Types

As described under [To Do's and Cases](#), To Do entries can be used to highlight cases that require user attention.

The following points provide a high-level description of how to create (and complete) To Do entries for a case type:

- Create a To Do type for each different type of To Do entry used during a case's lifecycle
  - On the To Do type, think carefully about the roles whose users can work on the entries
  - Also consider if you would like a BPA script launched when a user selects the entry
- Specify the To Do type on the appropriate [entry processing](#) or [exit processing](#) algorithm
- If you want the system to automatically complete To Do entries, specify the To Do type on the appropriate [entry processing](#) or [exit processing](#) algorithm

Please be aware that the case maintenance transaction highlights the number of open and being worked To Do entries linked to the case being displayed on the page. However, the system can only do this if the To Do entries reference a [foreign-key characteristic](#) whose foreign key references the case table. If you use the [CSEN-TD](#) algorithm to create To Do entries when a case enters a given state, this algorithm will do this for you if:

- You have set up a [foreign-key characteristic type](#) whose [foreign key](#) references the case table
- In addition, the characteristic type must reference a characteristic entity of To Do Entry

## Setting Up Characteristic Types

As described under [Additional Information](#), some of your cases may require additional information (in the form of [characteristics](#)). If this is true, you must set up the characteristic types before setting up the case types.

Refer to [Setting Up To Do Types](#) for instructions regarding a characteristic type that must be set up in order for the system to know the To Do entries that are associated with a case.

If you use the [CSEN-CC](#) algorithm to create customer contacts when a case enters a given state, you should set up a [foreign-key characteristic type](#) as follows:

- Its [foreign key](#) must reference the case table
- In addition, the characteristic type must reference a characteristic entity of Customer Contact

## Setting Up Case Types

The case type maintenance transaction is used to maintain your case types. The topics in this section describe how to use this transaction.

---

### FASTPATH:

Refer to [The Big Picture Of Cases](#) for more information about how a case type encapsulates the business rules that govern a case.

---

## Case Type - Main

Use this page to define basic information about a case type.

Open the case type page by selecting **Admin > Customer > Case Type > Case Type > Add**.

---

### NOTE:

**Recommendation.** Before using this transaction, we strongly recommend that you review the [Examples of Case Types](#).

---

### Main Information

Enter a unique **Case Type** code and **Description** for the case type.

Use **Long Description** to provide a more detailed explanation of the purpose of the case type.

If your implementation requires restricting case types by CIS Division, specify a **CIS Division** on the case type.

**Person Usage** controls the applicability of a person on cases of this type. Select Required if a person must be defined on this type of case. Select Optional if a person can optionally be defined on this type of case. Select Not Allowed if a person is not allowed on this type of case.

**Account Usage** controls the applicability of an account on cases of this type. Select Required if an account must be defined on this type of case. Select Optional if an account can optionally be defined on this type of case. Select Not Allowed if an account is not allowed on this type of case.

**Premise Usage** controls the applicability of a premise on cases of this type. Select Required if a premise must be defined on this type of case. Select Optional if a premise can optionally be defined on this type of case. Select Not Allowed if a premise is not allowed on this type of case.

**Entity Relationship** controls the validation of relationships on cases of this type. *All* ensures that the account belongs to the person and that the account and premise are related. *Person and Account Only* disables the account and premise validation. *Premise and Account Only* disables the person and account validation. *None* disables all validation and allows any values. This setting only impacts the validation of values entered and works in conjunction with the three usage fields described above.

If you need to restrict access to cases of this type to specific user groups, reference the appropriate **Application Service**. Refer to [Setting Up Application Services](#) for the details of how to secure access to your cases.

If you are configuring a case type to handle the processing of data defined via a **Business Object**, associating the case type with a business object serves to link the properties of the business object (e.g. BO options) with cases of that type. Refer to [Business Objects](#) for further information. In addition, refer to [Automatic Transition Rules](#) for information on the role of BO options in case auto-transition errors.

**Responsible User Usage** controls the applicability of a responsible user on cases of this type. Select Required if a responsible user must be defined on this type of case. Select Optional if a responsible user can optionally be defined on this type of case. Select Not Allowed if a responsible user is not allowed on this type of case. Refer to [Responsible User Applicability](#) for more information.

### Contact Information Fields

There are three contact information fields: **Contact Person & Method Usage**, **Contact Instructions Usage**, and **Case Phone Usage**. These fields are used to determine whether or not each type of contact information must be entered on case records with this case type. Select Required if the contact information must be entered, select Optional if the user can choose whether or not to include the contact information on this type of case, or select Not Allowed if the contact information cannot be entered on this type of case.

### Algorithms

The **Algorithms** grid contains algorithms that control functions for cases of this type. You must define the following for each algorithm:

- Specify the **System Event** with which the algorithm is associated (see the table that follows for a description of all possible events).
- Specify the **Sequence Number** and **Algorithm** for each system event. You can set the **Sequence Number** to 10 unless you have a **System Event** that has multiple **Algorithms**. In this case, you need to tell the system the **Sequence** in which they should execute.

The following table describes each **System Event**.

System Event	Optional / Required	Description
Case Information	Optional	<p>We use the term "Case information" to describe the basic information that appears throughout the system to describe a case. The data that appears in "case information" is constructed using this algorithm.</p> <p>Plug an algorithm into this spot to override the "Case information" algorithm on installation options or the system default "Case information" if no such algorithm is defined on installation options.</p> <p>Click <a href="#">here</a> to see the algorithm types available for this system event.</p>

### Case Type Tree

The tree summarizes the case type's lifecycle. You can use the hyperlinks to transfer you to the **Lifecycle** tab with the corresponding status displayed.

## Case Type - Case Characteristics

To define characteristics that can be defined for cases of this type, open **Admin > Customer > Case Type > Search** and navigate to the **Case Characteristics** page.

### Description of Page

Use **Sequence** to control the order in which characteristics are defaulted. Turn on the **Required** switch if the **Characteristic Type** must be defined on cases of this type. Turn on the **Default** switch to default the **Characteristic Type** when cases of this type are created. Enter a **Characteristic Value** to use as the default for a given **Characteristic Type** when the **Default** box is checked. Refer to [Required Fields Before A Case Enters A State](#) for a description of how you can make option characteristics required at later stages in a case's lifecycle.

## Case Type - Lifecycle

Case types that involve multiple users and multiple potential outcomes have complex lifecycles. Before you can design a case type's lifecycle, it's important that you thoroughly understand the concepts described under [Lifecycle](#) and [Status-Specific Business Rules](#). After thoroughly understanding these concepts, we recommend you perform the following design steps:

- Draw a "state transition diagram" as illustrated above under [Lifecycle](#). Keep in mind that if your state transition diagram is complex, your cases will be complex. While some cases warrant complexity, you should always ask yourself if there aren't better ways to achieve the desired results if your first effort results in complexity.
- Determine which characteristics (if any) are required during each stage of a case's lifecycle
- Determine when To Do entries (if any) should be created (and completed) during a case's lifecycle
- Determine additional validation (if any) that should be executed before a case enters and exits each state
- Determine additional processing (if any) that should transpire when a case enters or exits each state
- Determine if scripts are warranted to help users work the cases and, if so, design the scripts for each applicable state

When the above tasks are complete, you will be ready to set up a case type's lifecycle.

Open the Lifecycle page by selecting **Admin > Case Type > Case Type > Search** and navigate to the **Lifecycle** page.

---

### NOTE:

You can navigate to a status by clicking on the respective node in the tree on the Main tab. You can also use the hyperlinks in the Next Statuses grid to display a specific status in the accordion.

---

### Main Information

The **Status** accordion contains an entry for every status in the case type's [lifecycle](#).

Use **Status** to define the unique identifier of the status. This is NOT the status's description, it is simply the unique identifier used by the system.

Use **Description** to define the label that appears on the lifecycle accordion as well as the status displayed on the case.

Use **Script** to reference a BPA script that can assist a user work on a case while it's in this status. Refer to [A Script That Helps A User Work Through A Case](#) for the details.

Use **Access Mode** to define the action associated with this status. This field is disabled if an application service is not specified on the Main page. Refer to [Access Rights](#) for the details of how to use this field to restrict which users can transition a case into this state.

Use **Batch** to specify a batch control that will auto-transition the case. Any case in a status configured with a batch control will be transitioned when the batch job runs (rather than when **CASETRAN** is executed). For this purpose, batch process **C1-CSTRS** ( **Case Scheduled Transition**) is supplied with base package, which will execute all Exit Status logic for the current status, and Enter Status logic for the destination status. You may choose to create a batch process with your own transition logic.

**NOTE:**

If you wish to defer transitioning a case in a particular status until the batch process on your case type status is executed, you should not populate an Auto-Transition algorithm on that status. Otherwise, CASETRAN will transition the case according to your Auto-Transition logic.

Use **Comment** to describe the status. This is for your internal documentation requirements.

Use **Sequence** to define the relative order of this status in the tree on the Main page.

Use **Status Condition** to define if this status is an Initial, Interim or Final state. Refer to [One Initial State and Multiple Final States](#) for more information about how this field is used.

Use **Transitory State** to indicate whether a case should ever exist in this state. Only Initial or Interim states can have a transitory state value of No.

The **Alert Flag** is used to indicate whether or not an alert should be displayed for customers with cases in the state. (The alert is shown via the base package Installation - Alert algorithm.)

### Algorithms

The **Algorithms** grid contains algorithms that control important functions for cases of this type. You must define the following for each algorithm:

- Specify the **System Event** with which the algorithm is associated (see the table that follows for a description of all possible events).
- Specify the **Sequence Number** and **Algorithm** for each system event. You can set the **Sequence Number** to 10 unless you have a **System Event** that has multiple **Algorithms**. In this case, you need to tell the system the **Sequence** in which they should execute.

The following table describes each **System Event** (note, all system event's are optional and you can define an unlimited number of algorithms for each event).

System Event	Description
Auto Transition	This algorithm is executed to determine if a case that's in this state should be transitioned into another state. Refer to <a href="#">Automatic Transition Rules</a> for the details.  Click <a href="#">here</a> to see the algorithm types available for this system event.
Enter Processing	This algorithm holds additional processing that is executed when a case is transitioned into this state. You can also specify state transition logic within Enter Processing routines. Refer to <a href="#">Additional Processing When Entering A State</a> for the details.  Click <a href="#">here</a> to see the algorithm types available for this system event.
Enter Validation	This algorithm holds validation logic that executes before a case can enter a given state. Refer to <a href="#">Validation Before A Case Enters A State</a> for the details.  Click <a href="#">here</a> to see the algorithm types available for this system event.
Exit Processing	This algorithm holds additional processing that is executed when a case is transitioned out of this state. Refer to <a href="#">Additional Processing When Exiting A State</a> for the details.



Exit Validation	<p>Click <a href="#">here</a> to see the algorithm types available for this system event.</p> <p>This algorithm holds validation logic that executes before a case can be transitioned out of a given state. Refer to <a href="#">Validation Before A Case Exits A State</a> for the details.</p>
Script Launching	<p>Click <a href="#">here</a> to see the algorithm types available for this system event.</p> <p>This algorithm sets the script launching option for the script associated with a given state, if any. Refer to <a href="#">Script Launching Option</a> for the details.</p>
	<p>Click <a href="#">here</a> to see the algorithm types available for this system event.</p>

## Next Statuses

Use the **Next Statuses** grid to define the statuses a user can transition a case into while it's in this state. Refer to [Valid States versus State Transition Rules](#) for more information. Please note the following about this grid:

- Use **Action Label** to indicate the verbiage to display on the action button used to transition to this status.
- **Sequence** controls the order of the buttons that appear on [Case - Main](#). Refer to [Buttons Are Used To Transition A Case Into A State](#) for more information.
- **Use as Default** controls which button (if any) is the default button.
- **Transition Condition** may be configured to identify a common transition path for cases of this type in the current state. This transition condition may then be referenced across multiple case types. You'll need to add values to Look Up table field **TR\_COND\_FLG** that fit the typical transitions for your case types (e.g. Ok, Error, etc.).

By assigning the transition condition value to a given "next status", you can design your Enter State transition or Auto-Transition logic to utilize those flag values *without specifying a status particular to a given case type*. Thus, similar logic may be used across a range of case types to transition a case into, for example, the next Ok state for the case's current status.

- **Transition Role** controls whether only the System or both System and User have the ability to transition a case into a given "next status".
- You can use the status description hyperlink to open the Status accordion to the respective status.
- When you initially set up a case type, none of the statuses will reside on the database and therefore you can't use the search to define a "next status". We recommend working as follows to facilitate the definition of this information:
  - Leave the Next Statuses grid blank when you initially define a case type's statuses
  - After all statuses have been saved on the database, update each status to define its Next Statuses (this way, you can use the search to select the status).

## Required Characteristics

Use the **Required Characteristics** grid to define characteristics that are required when a case enters this state. Only Optional characteristics defined on the main page appear in this grid. Refer to [Required Fields Before A Case Enters A State](#) for more information.

## Defining Umbrella Agreement Options

Your organization may use umbrella agreement functionality to manage many situations, including (but not limited to) the following:

- Creating a "negotiated contract" with a large customer with many sites.
- Creating a "negotiated contract" with all customers in a common geographic area, for example a specific city or an apartment complex

- Grouping and managing the proposal service agreements created during the quoting process
- Managing the renewal process for special contracts
- Applying override rate terms to one or more service agreements for a given effective period
- more...

---

**NOTE:**

**Separately module.** The umbrella agreement functionality is part of the Contract Management module. If this module is not applicable to your business you may turn it off. Refer to [Turn Off A Function Module](#) for more information.

---

## The Big Picture Of Umbrella Agreements

The topics in this section provide background information about how to configure the system to support your umbrella agreement requirements.

### Renewable Umbrella Agreements

When defining your umbrella agreement types, you must determine if umbrella agreements of this type are renewable. If so, you must set the renewal flag on the UA type to Renewable and determine the number of days prior to the end date of the umbrella agreement that the renewal process should start.

In addition, you must decide on your renewal procedure and design an appropriate renewal [algorithm](#). You may use one of the sample renewal algorithms provided by the system.

- The sample algorithm [URNW-TD](#) creates a To Do entry. Using this algorithm you can direct the To Do entry to an appropriate role to determine if the umbrella agreement should be renewed. If the umbrella agreement is associated with an account management group, the To Do entry could be assigned to a role defined for that AMG.
- The sample algorithm [URNW-CA](#) creates a [case](#). Using this algorithm you can create an appropriate case to help track the steps required for renewing an umbrella agreement.

If the base algorithms do not provide the logic your organization needs, you may create a new algorithm.

---

**NOTE:**

It is the responsibility of the renewal algorithm to change the renewal date as per the business requirements. If renewal requires manual review, the algorithm should reset the date to blank. If the algorithm can determine a new renewal date, the date should be changed to the appropriate value.

---

### Terms Of Service Covered Entities

For each terms of service type you design, consider whether or not a TOS created for this type should reference one or more entities in the system that are "covered" by the terms of service. Following are some examples of covered entities:

- A special contract is created for all the McDonalds franchises in your service area. When creating the terms of service record for the umbrella agreement used for this contract, you want the user to link the person record representing the McDonalds corporate entity as a covered entity for the TOS.
- An umbrella agreement is created for a large customer with several types of services. Perhaps you want to group the services in the contract based on type of service. The service type may be set up as a covered entity.

The covered entities could also be used to denote eligibility. Refer to [Linking To A UA For A Group Of Premises](#) for an example of using the covered entity collection for eligibility.

The covered entities are actually characteristics. You must define the desired characteristic types if they do not already exist. In this case, they would be foreign key characteristic types. The characteristic types that you want to use must reference a characteristic entity of TOS covered entity.

A terms of service record may only reference covered entity types that you designate on the Terms of Service type record. When designing the covered entities that are allowed for TOS records of a given type, you may also configure the Terms of Service type to indicate that one or more covered entity types are required.

Refer to [Terms Of Service Type - Main](#) for more information.

## Overriding Rate Terms

If your organization has business rules that require a service agreement's rate terms to be overridden, you can accomplish this using umbrella agreements and terms of service records. There are two levels of overriding that are possible:

- Override rate schedule
- Override other terms on the rate, including contract riders, contract terms and tax exemptions

To override any rate terms, the service agreement must be linked to a terms of service record that references a template service agreement. In addition, you must configure settings in the system to indicate whether or not overriding of terms is allowed.

- The [SA type](#) for the customer's service agreement indicates whether or not the rate schedule may be overridden using the rate source flag.
  - If the rate source value is Check TOS First, then SA, when applying the rate, the system determines if the SA is linked to a TOS effective at the time of the bill with a template SA. If so, the rate schedule on the template SA is used.
  - If the rate source value is Check SA Only, when applying the rate, the always uses the rate schedule on the customer's SA (regardless of whether or not the SA is linked to a TOS effective at the time of the bill with a template SA).
- If any bill factor on one of calculation rule indicates that it is eligible for tax exemptions, contract terms or contract riders, the terms of service usage flag on the bill factor indicates where the system should look for the appropriate value. The flag tells the system to find applicable information either on the TOS's template SA only, on the customer's SA only or it should first check the TOS, then check the customer's SA.

The following table illustrates the different scenarios possible when configuring your bill factors and the resulting behavior. The term "standard behavior" in the tables below indicate that the standard behavior as described in [Defining Bill Factors](#) is followed.

	TOS Usage	Template SA	Customer SA	BF Char Source
Contract Rider Applicability is checked	Check TOS First, then SA	Found	Not checked	If source = SA, the template SA's characteristic collection is checked. If source <> SA, the standard behavior is followed.
		Not Found	Found	If source = SA, the customer SA's characteristic collection is checked. If source <> SA, the standard behavior is followed
		Not Found	Not Found	N/A

Check TOS Only	Found	Not checked	If source = SA, the template SA's characteristic collection is checked. If source <> SA, the standard behavior is followed
	Not Found	Not checked	N/A
Check SA Only	Not checked	Standard behavior	

TOS Usage	Template SA	Customer SA	BF Value Source	BF Char Source	
Value in Contract Term is checked	Check TOS First, then SA	Found	Not checked	Template SA	N/A
		Not Found	Found	Customer SA	N/A
		Not Found	Not Found	Bill Factor Value (based on Char Source)	If source = SA, the template SA's characteristic collection is checked. If source <> SA, the standard behavior is followed
Check TOS Only	Found	Not checked	Template SA	N/A	
	Not Found	Not checked	Bill Factor Value (based on Char Source)	If source = SA, the template SA's characteristic collection is checked. If source <> SA, the standard behavior is followed	
Check SA Only	Not checked	Standard behavior			

TOS Usage	Template SA	Customer SA	BF Value Source	
Tax Exemption is checked	Check TOS First, then SA	Found	Not checked	Template SA
		Not Found	Found	Customer SA
		Not Found	Not Found	No value
Check TOS Only	Found	Not checked	Template SA	
	Not Found	Not checked	No value	
Check SA Only	Not checked	Standard behavior		

Note that [proration](#) logic is followed for the above functionality as expected. For example, imagine that a bill factor with Value in Contract Terms is proratable and the TOS usage value is Check TOS First, then SA. If the template SA has a contract value that is only in effect for the first 10 days of a bill, that value is used for the first 10 days and the remaining days in the bill take the value from the SA (if applicable) or the bill factor value as per the table rules above.

**NOTE:**

When designing your terms of service type, you must indicate whether a template service agreement is optional, required or not allowed. When the template SA is required, the user setting up the TOS record for this TOS type must

link the correct service agreement as the template SA. If a new template service agreement is required, the new SA must be created first.

---

## Setting Up Umbrella Agreement Options

The topics in this section describe how to set up umbrella agreement options.

### Configure SA Types for Umbrella Agreements

For each type of service agreement that may be linked to a terms of service record, you must configure the Rate Source for the [SA type](#) to indicate if the rate should always be taken from the service agreement ( [Check SA Only](#) ) or if the rate should be taken from the terms of service record for the service agreement, if any ( [Check TOS First, then SA](#) ).

---

**FASTPATH:**

Refer to [Overriding Rate Terms](#) for more information.

---

**NOTE:**

The rate source is only visible on SA type if the Contract Management module is not [turned off](#).

---

### Configure Bill Factors for Umbrella Agreements

For each bill factor that has a value in contract term, contract rider applicability or tax exemption applicability, you must indicate where the system should look for a value when a service agreement is linked to a terms of service with a template SA and where this bill factor is referenced by the rate being applied. Using the terms of service usage flag, tell the system to [Check TOS Only](#), [Check SA Only](#) or [Check TOS First, then SA](#).

---

**FASTPATH:**

Refer to [Overriding Rate Terms](#) for more information.

---

**NOTE:**

The terms of service usage flag is only visible on bill factor if the Contract Management module is not [turned off](#).

---

### Configure A Campaign To Link An SA To A Terms Of Service

The system provides a pair of column reference algorithm types that support linking a new service agreement to an existing terms of service record via an [order](#). The pair includes a validation algorithm type [CRVL-SATOS](#) and a posting algorithm type [CRPS-SATOS](#).

In order to take advantage of this functionality, you must:

- Create an algorithm for each of the above algorithm types. Only one algorithm is needed for each algorithm type because there are no parameters for either one.
- Setup a unique [column reference](#) for the terms of service ID column reference code and plug in the new validation and posting algorithms on the record.

- For campaigns whose orders link a new service agreement to an existing umbrella agreement, make sure to define a [miscellaneous field](#) for the terms of service ID. Note, the miscellaneous field must reference the column reference that you setup above.

Based on your business practice, you may want to further configure your campaign / package for linking a service agreement to an existing terms of service. Refer to [Linking A Service Agreement To A TOS Through Orders](#) for more information.

## Setting Up Umbrella Agreement Types

The umbrella agreement type transaction is used to maintain your UA types. The topics in this section describe how to use this transaction.

### Umbrella Agreement Type - Main

Open **Admin > Umbrella Agreement > Umbrella Agreement Type > Add** to define basic information about an umbrella agreement type.

#### Description of Page

Enter a unique **Umbrella Agreement Type** code and **Description** for the UA type.

Use **Renewal** to indicate whether an umbrella agreement of this type is Renewable or Not Renewable. For renewable UA types, indicate the **Renewal Days Before Expiration**. The renewal date for umbrella agreements of this type are calculated based on this number of days before the end date.

Use the characteristics collection to define characteristics that can be defined for umbrella agreements of a given type. Use **Sequence** to control the order in which characteristics are defaulted. Turn on the **Required** switch if the **Characteristic Type** must be defined on umbrella agreements of a given type. Turn on the **Default** switch to default the **Characteristic Type** when umbrella agreements of the given type are created. Enter a **Characteristic Value** to use as the default for a given **Characteristic Type** when the **Default** switch is turned on.

---

#### NOTE:

**Characteristic Types.** You can only choose characteristic types defined as permissible on an umbrella agreement record. Refer to [Setting Up Characteristic Types & Their Values](#) for more information.

---

Enter the valid **Terms of Service Types** that may be referenced for umbrella agreements of this type.

#### Where Used

Follow this link to open the data dictionary where you can view the tables that reference [CI\\_UA\\_TYPE](#).

### Umbrella Agreement Type - Algorithms

Open **Admin > Umbrella Agreement > Umbrella Agreement Type > Search** and navigate to the **Algorithms** page.

#### Description of Page

The grid contains **Algorithms** that control important functions in the system. You must define the following for each algorithm:

- Specify the **System Event** with which the algorithm is associated (descriptions of all possible events are provided below).

- Specify the **Sequence** and **Algorithm** for each system event. You can set the **Sequence** to 10 unless you have a **System Event** that has multiple **Algorithms**. In this case, you need to tell the system the **Sequence** in which they should execute.

The following table describes each **System Event** for which you can define algorithms.

System Event	Description
UA Renewal	<p>Algorithms of this type are executed by the UARENEW background process when an umbrella agreement has reached its renewal date.</p> <p>Only one renewal algorithm is allowed for a given UA type.</p> <p>Click <a href="#">here</a> to see the algorithm types available for this system event.</p>

## Setting Up Terms Of Service Types

The terms of service type transaction is used to maintain your Terms of Service types. The topics in this section describe how to use this transaction.

### Terms Of Service Type - Main

Open **Admin > Umbrella Agreement > Terms of Service Type > Add** to define basic information about terms of service types.

#### Description of Page

Enter a unique **Terms of Service Type** code and **Description** for the TOS type.

Use **Template SA Usage** to indicate whether a template SA is Optional, Required or Not Allowed. Refer to [Overriding Rate Terms](#) for more information about using template SAs.

Use the characteristics collection to define characteristics that can be defined for terms of service records of a given type. Use **Sequence** to control the order in which characteristics are defaulted. Turn on the **Required** switch if the **Characteristic Type** must be defined on terms of service records of a given type. Turn on the **Default** switch to default the **Characteristic Type** when terms of service records of the given type are created. Enter a **Characteristic Value** to use as the default for a given **Characteristic Type** when the **Default** switch is turned on.

#### NOTE:

**Characteristic Types.** You can only choose characteristic types defined as permissible on a terms of service record. Refer to [Setting Up Characteristic Types & Their Values](#) for more information.

Use the **Covered Entities** collection to define the types of entities that are "covered" by terms of service records of this type. Refer to [Terms Of Service Covered Entities](#) for more information

#### NOTE:

**Characteristic Types.** You can only choose characteristic types defined as permissible for TOS covered entity. Refer to [Setting Up Characteristic Types & Their Values](#) for more information.

#### Where Used

Follow this link to open the data dictionary where you can view the tables that reference [CI\\_TOS\\_TYPE](#).

## Terms Of Service Type - UA Types

Open **Admin** > **Umbrella Agreement** > **Terms of Service Type** > **Add** and navigate to the **UA Types** page.

### Description of Page

Enter the valid **Umbrella Agreement Types** that may reference this terms of service type.

## Setting Up Terms of Service Cancel Reasons

Whenever a terms of service record is canceled, a cancel reason must be specified. Open **Admin** > **Terms of Service Cancel Reason** to specify such cancellation reasons.

### Description of Page

Enter an easily recognizable **Terms of Service Cancel Reason** and **Description** for the terms of service cancellation reason.

## Umbrella Agreements Configuration Examples

This section provides examples of how you would configure the system to support various business scenarios.

### Linking A Service Agreement To A TOS Through Orders

As described in [Configure A Campaign To Link An SA To A Terms Of Service](#), the system has provided a pair of column reference algorithms to enable your users to link a new service agreement to an existing terms of service record (and its umbrella agreement) when starting service via the order transaction.

When designing your campaign and packages to use this option, consider the scenarios where you may use this to determine whether or not you require additional configuration. The following topics describe some possible scenarios.

#### Linking To A UA For A Given Account

Imagine that you would use this logic when an important customer is starting additional service and has an existing umbrella agreement for other services that the new service should be added to. The user creating the order is probably the account manager for that account and would know the correct terms of service record to link the new service to.

For this scenario, you do not need to provide any "help" to the user to indicate that linking to a TOS is an option or to help select the correct TOS. You simply need to ensure that the campaign that would be used by this account manager to start service for the important customer simply includes a question / miscellaneous field to [link the SA to the terms of service](#).

#### Linking To A UA For A Group Of Premises

Imagine you have created an umbrella agreement for a group of premises that are not actively managed by a specific user. For example, perhaps there are several apartment complexes that have negotiated a special rate with your company. When new customers sign up for service at a premise that belongs to one of these apartments, the user should be informed that



there is a special contract for this premise. The user may also need help selecting the correct terms of service record. To accomplish this logic, you must define additional algorithms to help your users.

For example, perhaps your standard campaign for residential electric customers includes a package to be used by premises linked to one of these apartment buildings and should only be eligible to one of those premises. You must create an eligibility algorithm for this package. Its logic could be designed based on the following assumptions:

- The qualifying premises are linked to a parent premise
- The parent premise is linked to the appropriate terms of service record in its covered entity collection

The eligibility algorithm checks to see if the order's premise is linked to a parent premise that is referenced on a terms of service record for an umbrella agreement that is currently in effect. It could also be restricted to search for a specific umbrella agreement type or terms of service type if appropriate.

---

**NOTE:**

The campaign for this scenario must include a question / miscellaneous field to [link the SA to the terms of service](#). It should be configured with an applicability of only applicable on package. The package that is used to include the SA into the terms of service for the apartment complex would include this question / miscellaneous field.

---

Once the user chooses this package, user is prompted to provide the correct terms of service record via the question / miscellaneous field. To help the user, you should create a column reference retrieval algorithm to default the correct terms of service record for this premise. It would use the same logic as the eligibility algorithm described above. In other words, it would find the parent premise for this premise and then find the terms of service record covered entity collection includes this parent premise and whose umbrella agreement is currently in effect.

## Reports Addendum

This chapter is an addendum to the general [Defining and Designing Reports](#) chapter.

## Configuring the System to Invoke Oracle BI Publisher Enterprise Real-Time

In order to invoke Oracle BI Publisher Enterprise from within the system, it must be configured. This topic describes the steps at a high level that are required to configure your system to enable BI Publisher..

### Specify Reporting Tool Options

The following information should be defined on Reporting Tool Options table:

- **Reporting Server** is the web server URL where the reporting tool is installed.
- **Reporting Folder** defines the name of the directory on the Oracle BI Publisher server where reports are located. The system's reporting tool algorithm constructs the URL to open Oracle BI Publisher Enterprise based on the information provided on Reporting Options. The same folder name should be used as a report folder in Oracle BI Publisher Enterprise where reports are published.

## Reporting Tool Algorithm

The base product provides an installation algorithm plug-in spot called Reporting Tool. This plug-in spot should contain an algorithm that invokes the reporting tool real-time. The corresponding algorithm type, called algorithm reference: [F1-BIPR-INV](#), invokes Oracle BI Publisher Enterprise.

This algorithm relies on information defined in the Reporting Options table: the reporting server and folder names for accessing the reporting tool. The algorithm constructs several strings, for example, the URL of the BI Publisher, information about the report being requested and user info in the format expected by Oracle BI Publisher Enterprise. The Java program returns the correct URL to the browser. The browser then opens a BI Publisher Enterprise window with the appropriate URL.

To use the algorithm reference: [F1-BIPR-INV](#) algorithm type to invoke Oracle BI Publisher Enterprise, perform the following steps:

1. Create an algorithm for this algorithm type.
2. In the installation options, add an entry to the algorithm collection with an algorithm entity of Reporting Tool and indicate the algorithm created in the previous step.

## Interface with Oracle BI Publisher Enterprise Batch Scheduler

Presently the base product does not provide support for batch jobs with Oracle BI Publisher. Please use Oracle BI Publisher directly in order to schedule reports to run in batch.

## Configuring the System for Batch Bill Print

This section describes the steps for configuring the applications to print bills in batch.

### Configure Oracle BI Publisher for Batch Bill Print

1. Configure the Oracle BI Publisher Scheduler to allow report job submission.

---

**NOTE:**

Refer to the Oracle Fusion Middleware Administrator's Guide for Oracle Business Intelligence Publisher for more information.

---

2. Ensure that the CI\_BILLPR report artifacts (CI\_BILLPR.rtf, CI\_BILLPR.xdo, CI\_BILLPR.xdm) are deployed to corresponding BI Publisher catalog folder:

### Configure Oracle Utilities Customer Care and Billing for Batch Bill Print

1. Go to **Admin > Reporting > Reporting Options** and configure the following values:

- **Reporting Server from Browser** should point to the correct BI Publisher Server URL; for example, `http://<hostname>:port`
  - **Reporting Folder** is the name as the Catalog Folder in BI Publisher where **CI\_BILLPR** is located; for example, CCB
  - **Reporting Engine User ID** is the BI Publisher User ID.
  - **Reporting Engine Password** is the BI Publisher Password.
2. Create a custom Bill Route Type Extract Algorithm using the **CI-BLEX-BIP** Algorithm Type. Ensure that the following algorithm soft parameters are set:
    - **Output Directory** is the directory in BI Publisher server where the generated output files will be placed, for example, `/tmp/`
    - **Report Absolute Path** is the path where `CI_BILLPR.xdo` is located in the BI Publisher Catalog, for example, `/CCB/CI_BILLPR/CI_BILLPR.xdo`
    - **Report Format** is the format of the generated output files; for example, `pdf`
    - **Report Code** is the **CI\_BILLPR** report code; for example, `CI_BILLPR`
  3. Go to **Admin Menu, B, Bill Route Type** and configure the corresponding Bill Route Type (such as, **POSTAL**) to use the **RTTYPOST** Batch Control and the custom Bill Route Type Extract Algorithm.

## Description of Sample Reports

This section provides an overview of each sample report supplied with Oracle Utilities Customer Care and Billing that may be found in the demonstration database. They may be used by your organization as they are or as a starting point for creating a [new report](#).

---

### NOTE:

**Account Security.** The sample reports provided with the product do NOT incorporate account security. If a user has been given security to view the report, then all the data in the report is available for viewing.

---

## Active Severance Processes - CI\_ACSVPR

### Parameters

Parameter	Parameter Code	Description
Start Date	P_FROM_DT	Start date to use for reporting severance processes. If not defined, start date is set to 1900-01-01.
End Date	P_TO_DT	End date to use for reporting active severance processes. If not defined to date is set to the current date.

---

### Report Description

This report is used to aid in the monitoring of active severance processes. The report details are used to review how the company is doing as far as the collection of outstanding debt, as well as to monitor the progress of currently active severance processes.

The report selects active severance processes whose creation date is between the input start and end dates.

## Bill Print in BI Publisher - CI\_BILLPR

### Parameters

Parameter	Parameter Code	Description
CC&B user	P_USER_ID	No default value. Required. Returns an error message if user ID is null, empty or does not exist in database.
Batch Switch	P_BATCH_SW	For a single bill print, Batch Switch is 'No' and for multiple bill print, Batch Switch is 'Yes'.
First Bill	P_FROM_BILL_ID	First Bill Id to print for the Bill Range.
Last Bill	P_TO_BILL_ID	Last Bill Id to print for the Bill Range.
Batch Code	P_BATCH_CD	Passed in by the system the report is submitted in batch. Only bills with a Bill Routing that references this batch code are selected.
Batch Number	P_BATCH_NBR	Passed in by the system the report is submitted in batch. Only bills with a Bill Routing that references this batch number are selected.
Extract Algorithm	P_EXTRACT_ALG	Passed in by the system the report is submitted in batch. Only bills with a Bill Routing whose bill route type references this extract algorithm are selected.

### Report Description

This report is used with BI Publisher to display all the information that appears on the customer's printed bill for the bill ID entered in the input parameters. Refer to the description of the parameters above. The bill is only displayed if the bill is complete.

See below for details of the information extracted for the report. In addition, the sample report layout provided for the base product includes:

- Payment coupon.
- Form for change of address.
- A graph of consumption for current charges.

The following sections highlight the data that is extracted for this report.

### Bill Information

Field Name	Format	Source/Value/Description
SORT_KEY	A12	Primary sort for the report - currently sorted by Bill Id
BILL_ID	A12	CI_BILL

SEQNO	N5	CI_BILL_ROUTING
PER_ID	A10	CI_BILL_ROUTING
NBR_BILL_COPIES	N1	CI_BILL_ROUTING
ENTITY_NAME1	A64	CI_BILL_ROUTING. Mailing Entity Name 1.
ENTITY_NAME2	A64	CI_BILL_ROUTING. Mailing Entity Name 2.
ENTITY_NAME3	A64	CI_BILL_ROUTING. Mailing Entity Name 3.
COUNTRY	A3	CI_BILL_ROUTING
ADDRESS1	A254	CI_BILL_ROUTING
ADDRESS2	A254	CI_BILL_ROUTING
ADDRESS3	A254	CI_BILL_ROUTING
ADDRESS4	A254	CI_BILL_ROUTING
CITY	A30	CI_BILL_ROUTING
COUNTY	A30	CI_BILL_ROUTING
STATE	A6	CI_BILL_ROUTING
POSTAL	A12	CI_BILL_ROUTING
IN_CITY_LIMIT	A1	CI_BILL_ROUTING
BATCH_CD	A8	CI_BILL_ROUTING
BATCH_NBR	N10	CI_BILL_ROUTING
NO_BATCH_PRT_SW	A1	CI_BILL_ROUTING
ACCT_ID	A10	CI_BILL
BILL_STAT_FLG	A2	CI_BILL
BILL_DT	Date	CI_BILL
DUE_DT	Date	CI_BILL
ACCT_ENTITY_NAME	A64	Get Main Person from CI_PER_NAME. Account Entity Name
LANGUAGE_CD	A3	Person's Language from CI_PER
CURRENCY_CD	A3	CI_ACCT
CUR_SYMBOL	A4	CI_CURRENCY_CD
DECIMAL_POSITIONS	N1	CI_CURRENCY_CD
CUR_POS_FLG	A2	CI_CURRENCY_CD
OPEN_ITEM_SW	A1	CI_CUST_CL
BILL_COPY	A1	Bill copy number

## Bill Segment Information

Field Name	Format	Source/Value/Description
BSEG_ID	A12	CI_BSEG
SA_ID	A10	CI_BSEG

START_DT	Date	CI_BSEG
END_DT	Date	CI_BSEG
BILL_CYC_CD	A4	CI_BSEG
WIN_START_DT	Date	CI_BSEG
EST_SW	A1	CI_BSEG
CLOSING_BSEG_SW	A1	CI_BSEG
PREM_ID	A10	CI_BSEG
CIS_DIVISION	A5	CI_SA
SA_TYPE_CD	A8	CI_SA
SAT_DESCR	A60	CI_SA_TYPE_L
BILL_PRT_PRIO_FLG	A2	CI_SA_TYPE
GRAPH_UOM_CD	A4	CI_SA_TYPE
HEADER_SEQ	N3	CI_BSEG_CALC
BCALC_START_DT	Date	CI_BSEG_CALC
BCALC_END_DT	Date	CI_BSEG_CALC
RS_CD	A8	CI_BSEG_CALC
EFFDT	Date	CI_BSEG_CALC
BILLABLE_CHG_ID	A12	CI_BSEG_CALC
CALC_AMT	N15.2	CI_BSEG_CALC
BCALC_DESC_BILL	A80	CI_BSEG_CALC
SEQNO	N5	CI_BSEG_CALC_LN
PRT_SW	A1	CI_BSEG_CALC_LN
APP_IN_SUMM_SW	A1	CI_BSEG_CALC_LN
CALC_LN_AMT	N15.2	CI_BSEG_CALC_LN
DST_ID	A10	CI_BSEG_CALC_LN
MSR_PEAK_QTY_SW	A1	CI_BSEG_CALC_LN
DESCR_LN	A80	CI_BSEG_CALC_LN
STATE	A6	CI_PREM
CITY	A30	CI_PREM
POSTAL	A12	CI_PREM
SIBLING_ID	A12	CI_FT

## Account Summary Information

Field Name	Format	Source/Value/Description
CURRENCY_CD	A3	Derived from CI_BILL_SA or CI_FT.
SUM_CUR_AMT	S15.2	Get Bill's Current Balance from CI_BILL_SA Bill's Current Charge from CI_FT

		Bill's Current Correction Charge from CI_FT
		Bill's Current Adjustment from CI_FT
		Bill's Current Payment from CI_FT
SUM_TOT_AMT	S15.2	Get Bill's Total Balance from CI_BILL_SA Bill's Total Charge from CI_FT Bill's Total Correction Charge from CI_FT Bill's Total Adjustment from CI_FT Bill's Total Payment from CI_FT
BILL_PRT_FLG	A4	Set as follows: ASBL - Indicator for Bill's Balance from CI_BILL_SA ASBS - Indicator for Bill's Current Charge from CI_FT ASBC - Indicator for Bill's Correction from CI_FT ASAD - Indicator for Bill's Adjustment from CI_FT ASPS - Indicator for Bill's Payment from CI_FT

## Current Charge Information

Field Name	Format	Source/Value/Description
SUM_CUR_AMT	S15.2	Derived from CI_FT (Only the current charge bill segments.)
SUM_TOT_AMT	S15.2	Derived from CI_FT (Only the current charge bill segments.)
CURRENCY_CD	A3	CI_BILL_SA or CI_FT
DEBT_CL_CD	A4	Debt Class of SA Type
DESCR	A60	Debt Class Description

## Premise Information

One record for every premise linked to the bill.

Field Name	Format	Source/Value/Description
PREM_ID	A10	Premise Id obtained from Bill Segment
PREM_TYPE_CD	A8	CI_PREM
LL_ID	A10	CI_PREM
MAIL_ADDR_SW	A1	CI_PREM

TREND_AREA_CD,	A8	CI_PREM
COUNTRY	A3	CI_PREM
ADDRESS1	A254	CI_PREM
ADDRESS2	A254	CI_PREM
ADDRESS3	A254	CI_PREM
ADDRESS4	A254	CI_PREM
CITY	A30	CI_PREM
NUM1	A6	CI_PREM
NUM2	A4	CI_PREM
HOUSE_TYPE	A2	CI_PREM
COUNTY	A30	CI_PREM
STATE	A6	CI_PREM
POSTAL	A12	CI_PREM
GEO_CODE	A11	CI_PREM
IN_CITY_LIMIT	A1	CI_PREM

## Auto Pay Information

Field Name	Format	Source/Value/Description
BILL_ID	A12	CI_APAY_CLR_STG
APAY_SRC_CD	A12	CI_APAY_CLR_STG
EXT_ACCT_ID	A50	CI_APAY_CLR_STG
SCHED_EXTRACT_DT	Date	CI_APAY_CLR_STG. The date that the automatic payment will be downloaded.
APAY_SRC_NAME	A30	CI_APAY_SRC_L
APAY_SRC_DESCR	A60	CI_APAY_SRC_L
TNDR_TYPE_DESCR	A60	CI_TENDER_TYPE_L
TENDER_TYPE_CD	A4	CI_TENDER_TYPE

## Bill Segment Readings

Field Name	Format	Source/Value/Description
BSEG_ID	A12	CI_BSEG_READ
SP_ID	A10	CI_BSEG_READ
SEQNO	N5	CI_BSEG_READ
REG_CONST	S12.6	CI_BSEG_READ
USAGE_FLG	A2	CI_BSEG_READ



USE_PCT	S3	CI_BSEG_READ
HOW_TO_USE_FLG	A2	CI_BSEG_READ
MSR_PEAK_QTY_SW	A1	CI_BSEG_READ
UOM_CD	A30	CI_BSEG_READ
TOU_CD	A30	CI_BSEG_READ
SQI_CD	A30	CI_BSEG_READ
START_REG_READ_ID	A12	CI_BSEG_READ
START_READ_DTTM	DTTM	CI_BSEG_READ
START_REG_READING	S15.6	CI_BSEG_READ
END_REG_READ_ID	A12	CI_BSEG_READ
END_READ_DTTM	DTTM	CI_BSEG_READ
END_REG_READING	S15.6	CI_BSEG_READ
MSR_QTY	S18.6	CI_BSEG_READ
FINAL_UOM_CD	A4	CI_BSEG_READ
FINAL_TOU_CD	A8	CI_BSEG_READ
FINAL_SQI_CD	A30	CI_BSEG_READ
FINAL_REG_QTY	S18.6	CI_BSEG_READ
BADGE_NBR	A30	CI_MTR
NBR_OF_DGTS_RGT	S2	CI_REG

## Bill Segment Consumption History

Field Name	Format	Source/Value/Description
SA_ID	A10	CI_BSEG
START_DT	Date	CI_BSEG
BSEG_ID	A12	CI_BSEG
END_DT	Date	CI_BSEG
UOM_CD	A30	CI_BSEG_SQ
TOU_CD	A30	CI_BSEG_SQ
SQI_CD	A30	CI_BSEG_SQ
QTY	S18.6	Service Quantity from CI_BSEG_SQ

## Payment Information

One record for every payment linked to the bill.

Field Name	Format	Source/Value/Description
PAY_DT	Date	CI_PAY_EVENT

FT_TYPE_FLG	A2	Pay or Pay Cancel ('PS' or 'PX')
CAN_RSN_CD	A4	CI_PAY
CURRENCY_CD	A3	CI_FT.
CUR_AMT	S15.2	Derived from CI_FT. Sum of CUR_AMT for the bill with FT Type Flag = (PS or PX) and Show on Bill Switch = 'Yes'
TOT_AMT	S15.2	Derived from CI_FT. Sum of CUR_AMT for the bill with FT Type Flag = (PS or PX) and Show on Bill Switch = 'Yes'
TOT_PREV_BAL	S15.2	Calculated as Previous Balance = Ending Balance - (current charges + payments + adjustments + corrections)
PAY_CAN_RSN_DESCR	A60	Description of cancel reason code. (Note, that this is retrieved in a special stored procedure that retrieves all the cancel reason codes and descriptions.)

## Adjustment Information

One record for every adjustment linked to the bill.

Field Name	Format	Source/Value/Description
BILL_ID	A12	CI_FT
ACCOUNTING_DT	Date	CI_FT
ARS_DT	Date	CI_FT
PARENT_ID	A12	CI_FT
SIBLING_ID	A12	CI_FT
FT_ID	A12	CI_FT
CUR_AMT	S15.2	CI_FT
TOT_AMT	S15.2	CI_FT
FT_TYPE_FLG	A2	Adjustment or Adjustment Cancel ('AD' or 'AX')
SHOW_ON_BILL_SW	A1	CI_FT
CURRENCY_CD	A3	CI_FT
XFERRED_OUT_SW	A1	CI_FT
ADJ_TYPE_CD	A8	CI_ADJ
CAN_RSN_CD	A4	CI_ADJ
SA_ID	A10	CI_ADJ
CHAR_PREM_ID	A10	CI_SA
DESCR_ON_BILL	A254	CI_ADJ_TYPE_L
ADJ_CAN_RSN_DESCR	A60	Description of cancel reason code. (Note that this is retrieved in a special stored procedure

that retrieves all the cancel reason codes and descriptions.)

---

---

## Bill Message Information

One record for every bill message linked to the bill.

Field Name	Format	Source/Value/Description
MSG_PRIORITY_FLG	A12	CI_BILL_SA or CI_FT
INSERT_CD	S15.2	CI_BILL_SA or CI_FT
MSG_ON_BILL	S15.2	CI_BILL_SA or CI_FT

## Billed Revenues by Rate - CI\_BILREV

### Parameters

Parameter	Parameter Code	Description
Accounting Period	P_ACCT_PERIOD	Defines the accounting period used for the report. A valid fiscal year and accounting period for a valid accounting calendar must be provided.
Account Type Characteristic	P_CHAR_TYPE	Defines a Characteristic Type for a characteristic linked to the Distribution Code to define an Account Type.
Account Type	P_REV_ACCTY_CHAR	Account Type Char Value for Revenue related GL Accounts. The char type defined for this parameter should match the Char Type code defined as parameter #2. The parameter value indicated for this parameter should be one that represents revenue accounts.

### Report Description

This is an analysis report for the billed revenues for an accounting period according to the various rates, which were in effect in the system. The information in this report helps to adjust rates in order to achieve better financial results and comply with regulations and market trends.

This report selects all records in the financial transaction GL collection that satisfy the following criteria:

- The financial transaction is frozen.
- The Accounting Date on the financial transaction within input accounting period (parameter 1)
- The distribution code associated with the GL entry has a characteristic type and value that matches the input Account Type Characteristic and Account Type (parameters 2 & 3)

#### NOTE:

**Performance Consideration.** If your implementation chooses to use this report, you may consider adding an index to the CI\_FT table on ACCOUNTING\_DT to aid in performance. When making this decision, carefully weigh the

benefit of improving report performance against the possible degradation to the performance of day-to-day processing as a result of defining a new index. In addition, many companies opt to create a reporting database that is a shadow of production to ensure that indexes defined to benefit reports may be created without any affect on the production environment.

---

## Case Statistics By Case Type - CI\_CSESTS

### Parameters

Parameter	Parameter Code	Description
Start Date	P_FROM_DT	See the report's description for how this field is used.  If start date is not specified, it is defaulted to 7 days prior to the end date.
End Date	P_TO_DT	See the report's description for how this field is used.  If end date is not specified, it is defaulted to the current processing date.
Case Condition (Open, Closed)	P_COND_FLG	If specified, only cases in this condition are included in the report. If left blank, the reports produces statistics for both open and closed cases.

### Report Description

This report provides two types of statistics:

1. Open cases whose creation date falls between the input Start Date and End Date (inclusive)
2. Closed cases whose closing date falls between the input Start Date and End Date (inclusive)

The third parameter is only used if you want to restrict the statistics to only open or closed cases. If you leave this parameter blank, both open and closed statistics will be produced.

The following information is provided in graphical format:

- Number of cases by case type
- Percentage of cases by case type

## Case Statistics for a Given Status - CI\_CSESGS

### Parameters

Parameter	Parameter Code	Description
Start Date	P_FROM_DT	See the report's description for how this field is used.  If start date is not specified, it is defaulted to 7 days prior to the end date.
End Date	P_TO_DT	See the report's description for how this field is used.

If end date is not specified, it is defaulted to the current processing date.

Case Type/Status	P_CASE_STATUS_CD	This is the desired Case Type and Status that will be reported on.
Responsible User	P_CASE_OWNER	If specified, only cases with this responsible user are included in the report.
First Bucket High Limit	P_B1_LIMIT	Cases that took <= this number of days to reach the given status will be grouped together for statistical reporting.
Second Bucket High Limit	P_B2_LIMIT	Cases that took <= this number of days but more than the first bucket high limit to reach the given status will be grouped together for statistics reporting.
Third Bucket High Limit	P_B3_LIMIT	Cases that took <= this number of days but more than the second bucket high limit to reach the given status will be grouped together for statistics reporting. Cases that took more than this number of days are included in another group.

### Report Description

This report shows cases of a given case type that transitioned to a given status during a given date range.

Graphs are printed to show the number and percentage of cases grouped by the time it took to reach the status. These statistics are grouped into age buckets whose size is controlled by the last 3 parameters.

Summary statistics are also printed showing the minimum, maximum, average and median times for these cases.

## Collection Summary - CI\_CLLSUM

### Parameters

Parameter	Parameter Code	Description
Start Date	P_FROM_DT	If from date is not set, the default is one month prior to the current date.
End Date	P_TO_DT	End date of the date range. If not defined by user, it is set to one month after the current date

### Report Description

This report provides detailed monthly summary information of all collection activities. The report is typically used by a collection department for resource planning and performance review purposes.

This report selects pending and completed collection events whose event trigger date falls between the input start and end dates.

## Customer Contacts by Type - CI\_CUSTCN

### Parameters

Parameter	Parameter Code	Description
Start Date	P_FROM_DT	Start date to use for reporting customer contacts. If not defined, the start date is set to the current date minus 7 days.
End Date	P_TO_DT	End date to use for reporting customer contacts. If not defined, End Date is set to the current date.
Customer Contact Class / Type	P_CC_TYPE_CD	Specify a Customer Contact Class / Type to restrict the report output to a specific class / type.

### Report Description

This report lists all customer contacts in the system created within the input date range. You may optionally restrict the report to customer contacts for a given Customer Contact Class / Type (parameter 3).

**NOTE:**

**Graphs.** The information on this report is shown in both textual and graphical formats.

**Performance Consideration.** If your implementation chooses to use this report, you may consider adding an index to the CI\_CC table on CC\_DTTM to aid in performance. When making this decision, carefully weigh the benefit of improving report performance against the possible degradation to the performance of day-to-day processing as a result of defining a new index. In addition, many companies opt to create a reporting database that is a shadow of production to ensure that indexes defined to benefit reports may be created without any affect on the production environment.

## Customers with Life-Support / Sensitive-Load - CI\_PMLSSL

### Parameters

Parameter	Parameter Code	Description
Service Type	P_SERVICE_TYPE	Service type used to restrict the report to premises with services of this type.

### Report Description

This reports displays a detailed list of premises that are coded with Life-Support (LS) or Sensitive-Load (SL) information. It may optionally restrict the output to premises with service points for input service type.

This information is used by a company to make sure that customers at these premises are dealt with appropriately in the case of an outage (planned and unplanned) or service cut due to non-payment.

The report provides detailed information about the premise and the related facility elements providing service to that premise (e.g. substation, feeder and node for electric service).

**NOTE:**

If ANY person connected to an account has an LS/SL indication in the Person record, then all the premises connected to this account will be treated as LS/SL. This means, for example, that a premise connected to an account that has a 3rd party guarantor with LS/SL is treated as a premise with LS/SL.

## GL Accounting Summary - CI\_GLACSM

### Parameters

Parameter	Parameter Code	Description
Accounting Period	P_ACCT_PERIOD	Defines the accounting period used for the report. A valid fiscal year and accounting period for a valid accounting calendar must be provided.
Account Type Characteristic	P_CHAR_TYPE	Defines a Characteristic Type for a characteristic linked to the Distribution Code to define an Account Type. The account types for the GL accounts are used for grouping the output to the report.

### Report Description

This is a financial audit report used to check the financial details in Oracle Utilities Customer Care and Billing for an accounting period against the GL system. The report summarizes all financial transaction (FT) information for a given accounting period according to the different operating and GL divisions and according to various levels of the account GL information.

#### NOTE:

**Performance Consideration.** If your implementation chooses to use this report, you may consider adding an index to the CI\_FT table on ACCOUNTING\_DT to aid in performance. When making this decision, carefully weigh the benefit of improving report performance against the possible degradation to the performance of day-to-day processing as a result of defining a new index. In addition, many companies opt to create a reporting database that is a shadow of production to ensure that indexes defined to benefit reports may be created without any affect on the production environment.

## Letter Print - BI Publisher Sample Welcome Letters - CI\_LTRGN\_ENG REPORT

#### NOTE:

Generating letters in batch is not supported yet.

### Parameters

Parameter	Parameter Code	Description
Batch Switch	P_BATCH_SW	For reports accessed online, set the switch to 'No'. Otherwise, it should be set to 'Yes'.
Customer Contact	P_CC_ID	References the customer contact associated with the main customer linked to the account.

### Report Description

This sample report template for BI Publisher produces letters that are not associated with any other object (i.e., the template does not have to extract information from another object to merge into a letter). You can use this template as a welcome letter for a new customer.

By default, the English versions of the report templates are provided with the base product. If multilingual report templates are required, your implementation should provide reports for each language. When a letter is generated, the system uses the report template based on the customer's language.

The address and name for the company are extracted from the [installation options](#). The text for the letter is defined in the report layout and not provided by Oracle Utilities Customer Care and Billing. Reports are printed according to the customer's language definition and not based on the user's language definition.

This sample report uses the following text:

Welcome to %1. You have been filed with ID Number %2.

We hope to provide you with our best possible service. If you experience any problems or have any questions, please contact one of our customer service representatives at (800)1234567.

%1 is the company name stored as a message on the [installation options](#).

%2 is Person Id stored on the Customer Contact.

## Open Cases By Type - CI\_CSEOPN

### Parameters

Parameter	Parameter Code	Description
Start Date	P_FROM_DT	See the report's description for how this field is used.  If start date is not specified, it is defaulted to 7 days prior to the end date.
End Date	P_TO_DT	See the report's description for how this field is used.  If end date is not specified, it is defaulted to the current processing date.
Case Type	P_CASE_TYPE_CD	If specified, only cases of this type are included in the report.
Responsible User	P_CASE_OWNER	If specified, only cases with this responsible user are included in the report.
First Bucket High Limit	P_B1_LIMIT	Cases that are open for less than or equal to this number of days will be grouped together for statistical reporting.
Second Bucket High Limit	P_B2_LIMIT	Cases that are open less than or equal to this number of days but more than the first bucket high limit will be grouped together for statistics reporting.
Third Bucket High Limit	P_B3_LIMIT	Cases that are open less than or equal to this number of days but more than the second bucket high limit will be grouped together for statistics reporting. Cases that took more than



this number of days are included in another group.

---

---

### Report Description

This is a report on open cases that were created between a given date range.

The report can be limited to a specific type and/or responsible user.

For each case type, the report shows the following:

- Number of open cases by age bucket (the last 3 parameters control the size (in days) of each bucket)
- Percentage of open cases by age bucket
- Details of the open cases

## Payments Balance - CI\_PMTBAL

### Parameters

---

Parameter	Parameter Code	Description
Start Date	P_FROM_DT	Report gets all the payments that have been received during a given date range (from and to date parameters).  If start date is not defined by the user, it is set to 7 days prior to the current date.
End Date	P_TO_DT	End date of the date range. If not defined by user it is set to the current date

---

---

### Report Description

This report provides an overall view of all payments created within the input date range. It is typically used for financial control and audit purposes. The report provides summary information about valid payments received and about canceled payment. Data is summarized by the tender source and the type of payment.

## Receivables Aging - CI\_RCVAGA

### Parameters

---

Parameter	Parameter Code	Description
Cutoff Date	P_CUTOFF_DATE	The date from which the arrears buckets are calculated. If no value is entered, the default is the current date minus 7 days.
First Bucket High Limit	P_B1_LIMIT	High limit of first bucket.
Second Bucket High Limit	P_B2_LIMIT	High limit of second bucket.
Third Bucket High Limit	P_B3_LIMIT	High limit of third bucket.

---

---

### Report Description

This report lists all accounts and their arrears information as of the input cutoff date using a balance forward accounting method.

Outstanding debt is placed into the buckets provided as input using the age of the debt as of the cutoff date. Credits are applied to the oldest debt first. For each account a separate bucket is used to display new charges. In addition, the total accounts receivable balance is displayed for each account.

**NOTE:**

**Performance Consideration.** If your implementation chooses to use this report, you may consider adding an index to the CI\_FT table on ARS\_DT to aid in performance. When making this decision, carefully weigh the benefit of improving report performance against the possible degradation to the performance of day-to-day processing as a result of defining a new index. In addition, many companies opt to create a reporting database that is a shadow of production to ensure that indexes defined to benefit reports may be created without any affect on the production environment.

## Tax Payables Analysis - CI\_TXPYBL

### Parameters

Parameter	Parameter Code	Description
Start Date	P_FROM_DT	Show summary of the tax amounts starting from this date. If not specified, the system will default this value to the current date minus 7 days.
End Date	P_TO_DT	Show summary of the tax amounts up to this date.  If not specified, the system will default this value to the current date.
Account Type Characteristic	P_CHAR_TYPE	Defines a Characteristic Type for a characteristic linked to the Distribution Code to define an Account Type.
Account Type	P_TAX_ACCTY_CHAR	Account Type Char Value for tax related GL Accounts. The char type defined for this parameter should match the Char Type code defined as parameter #3. The parameter value indicated for this parameter should be one that represents tax liability accounts.

### Report Description

This report displays a summary of the tax amounts that were levied by the company to customers within the input date range. It also includes the tax exemption information for that period.

This report select all records in the financial transaction GL collection that satisfy the following criteria:

- The financial transaction is frozen.
- The Accounting Date on the financial transaction within the input date range
- The distribution code associated with the GL entry has a characteristic type and value that matches the input Account Type Characteristic and Account Type (parameters 3 & 4)

The report also provides tax exemption information for bill segments whose financial transactions satisfy the above criteria. The tax exemption information is retrieved by looking at the bill calculation lines associated with the FT's bill segment.

**NOTE:**

**Performance Consideration.** If your implementation chooses to use this report, you may consider adding an index to the CI\_FT table on ACCOUNTING\_DT to aid in performance. When making this decision, carefully weigh the benefit of improving report performance against the possible degradation to the performance of day-to-day processing as a result of defining a new index. In addition, many companies opt to create a reporting database that is a shadow of production to ensure that indexes defined to benefit reports may be created without any affect on the production environment.

---

## To Do Entries - CI\_TDENTR

### Parameters

Parameter	Parameter Code	Description
ToDo Entry Status	P_ENTRY_STATUS_FLG	Defines if the To Do entries on the report should be limited to those with a given status value. If this parameter is left blank, the report will show all open and being worked To Do entries.
ToDo Type	P_TD_TYPE_CD	Defines if the To Do entries on the report should be limited to those of a given ToDo type. If this parameter is left blank, the report will show all To Do type that have at least one open or being worked entry.

### Report Description

The report shows open and being worked To Do entries.

You can limit the report to entries in a given status by specifying the desired **To Do Status** (open or being worked). If you don't specify a status, all open and being worked To Do entries will appear on this report.

You can also limit the report to entries of a given To Do Type by specifying the desired To Do Type. If you don't specify a To Do Type, all To Do Types with at least one entry in the open / being worked state will appear on this report.

#### NOTE:

**Graphs.** The information on this report is shown in both textual and graphical formats.

---

## Umbrella Agreement Summary - CI\_UASUMM

### Parameters

At least one parameter is required. If the umbrella agreement is entered, no other parameter value is allowed. The report definition uses the validation algorithm [RPTV-UASUMM](#) to check these conditions.

Parameter	Parameter Code	Description
Umbrella Agreement	P_UA_ID	Specify the Umbrella Agreement to restrict the report to this umbrella agreement (regardless of its status).  When this parameter is specified, all other parameters are not allowed.

Account Management Group	P_AMG	Specify a value for this parameter to restrict the report to umbrella agreements related to this Account Management Group.
Umbrella Agreement Characteristic Type	P_CHAR_TYPE	Specify a value for this parameter to restrict the report to completed umbrella agreements related to this Characteristic type and value (parameter 4).
Umbrella Agreement Characteristic Value	P_CHAR_VALUE	Specify a value for this parameter to restrict the report to completed umbrella agreements related to this Characteristic type (parameter 3) and value.
Number of Days Before Expiration	P_EXPIRE_IN_X_DAYS	Specify a value for this parameter to restrict the report to completed umbrella agreements whose End Date is on or before the current date less the Number of Days before Expiration.

## Report Description

This report provides summary information about one or more [umbrella agreements](#).

If the user does not supply an umbrella agreement ID, but enters one or more of the other parameters, the report only selects umbrella agreements that match the input criteria AND the match the following criteria:

- The status of the umbrella agreement is complete
- The start and end dates of the umbrella agreement include the current date

The report does not include canceled terms of service records or canceled service agreements linked to the above umbrella agreements.

For each umbrella agreement that is included in the report, the output includes information about the umbrella agreement, its collection of terms of service records and for each TOS record, its collection of service agreements.

In addition, the report includes the following graphs:

- Umbrella agreement summary graph showing billing history by accounting period for the effective dates of the umbrella agreement for all service agreements linked to the umbrella agreement's terms of service records.
- Terms of service summary graph showing billing history by accounting period for the effective dates of the umbrella agreement for all its service agreements

## Unbilled Revenues - CI\_UBLREV

### Parameters

Parameter	Parameter Code	Description
Accounting Period	P_ACCT_PERIOD	Defines the accounting period used for the report. A valid fiscal year and accounting period for a valid accounting calendar must be provided.
Account Type Characteristic	P_CHAR_TYPE	Defines a Characteristic Type for a characteristic linked to the Distribution Code to define an Account Type.

Account Type

P\_REV\_ACCTY\_CHAR

Account Type Char Value for Revenue related GL Accounts. The char type defined for this parameter should match the Char Type code defined as parameter #2. The parameter value indicated for this parameter should be one that represents revenue accounts.

---

## Report Description

This report provides a simplified calculation of estimated unbilled revenue for a given month.

It processes frozen financial transactions associated with bill segments and canceled bill segments whose bill segment end date is within the **Accounting Period** (parameter 1). It determines the billed revenue for the FT and then uses this information to calculate the unbilled revenue.

To determine "revenue", the report summarizes amounts posted to any distribution code with a characteristic entry that matches the input **Account Type Characteristic** type and **Account Type** characteristic value (parameters 2 and 3).

The estimate for the unbilled portion is calculated as (Bill Amount / Number of Days in the Bill Period) \* Number of Unbilled Days for the Accounting Period.

For example, consider a bill segment on a monthly-billed cycle for the period of 3/10/03 - 4/9/03, and for \$150 (revenue part of the bill). Assume we are in the April/03 accounting period, which covers 4/1/03 through 4/30/03. This means 21 days are unbilled for April. The unbilled revenue is calculated as  $150/31 * 21 = \$101.61$ .

The following are some points to note about this report.

- If the report runs for an historical date, it still estimates the unbilled revenue portion based on the above formula even if actual data exists. In other words, it will not try to find actual bills for subsequent months. As a result, this report always shows what would have been the estimated unbilled revenue for a particular month if that month is the most recent one.
- Services can be billed monthly bi-monthly, quarterly or in any desired frequency. This report only performs the revenue recognition estimation using actual bills that were created in the report's accounting period. As a result, it does not estimate unbilled revenue for accounts that were not billed in any portion of the input accounting period.
- Revenue recognition practices are unique and may vary from customer to customer. In a given month we can produce current bills (e.g. for electric service) or future bills (e.g. cable services). In addition in some cases we can have bills that started before the accounting period and ending after it (for example in a cancel-rebill situation). This report will only estimate unbilled revenues for bills with the accounting period equals to the report's accounting period.

---

### NOTE:

**Performance Consideration.** If your implementation chooses to use this report, you may consider adding an index to the CI\_BSEG table on START\_DT, END\_DT to aid in performance. When making this decision, carefully weigh the benefit of improving report performance against the possible degradation to the performance of day-to-day processing as a result of defining a new index. In addition, many companies opt to create a reporting database that is a shadow of production to ensure that indexes defined to benefit reports may be created without any affect on the production environment.

---

## Defining Overdue Processing Options

The system periodically monitors how much your customers owe to ensure they haven't violated your collection rules. When a violation is detected, the system initiates the appropriate activities (e.g., letters, disconnect notices, collection agency referrals, and eventually write off). The topics in this section describe how to configure the system to manage your overdue processing requirements.

---

### NOTE:

The overdue processing module has been designed to collect on virtually anything from an unpaid bill to an unmatched financial transaction. You tell the system what you collect on by configuring the various overdue processing control tables. In this release, the base-package is delivered with algorithms that support collecting on overdue bills. If your organization practices balance-forward accounting (i.e., collection is based on overdue service agreement balances), you will not use this functionality. Rather, you will use the functionality described under [Defining Credit and Collections Options](#).

**WARNING:**

Setting up this module is as challenging as your organization's collection rules. If you have simple rules, the set up process will be straightforward. If your rules are complicated (e.g., they differ based on the type of customer, the age of debt, the type of service, etc.), your setup process will be more challenging.

## Case Study - Collecting On Overdue Bills

The following topics introduce a case study that describes how overdue processing can be used to collect on overdue bills. This is just an example as virtually every aspect of overdue processing is configurable. Use this case study to familiarize yourself with the overdue processing core concepts.

### Monitoring Overdue Bills

The following diagram illustrates the objects and processes involved with collecting overdue bills.

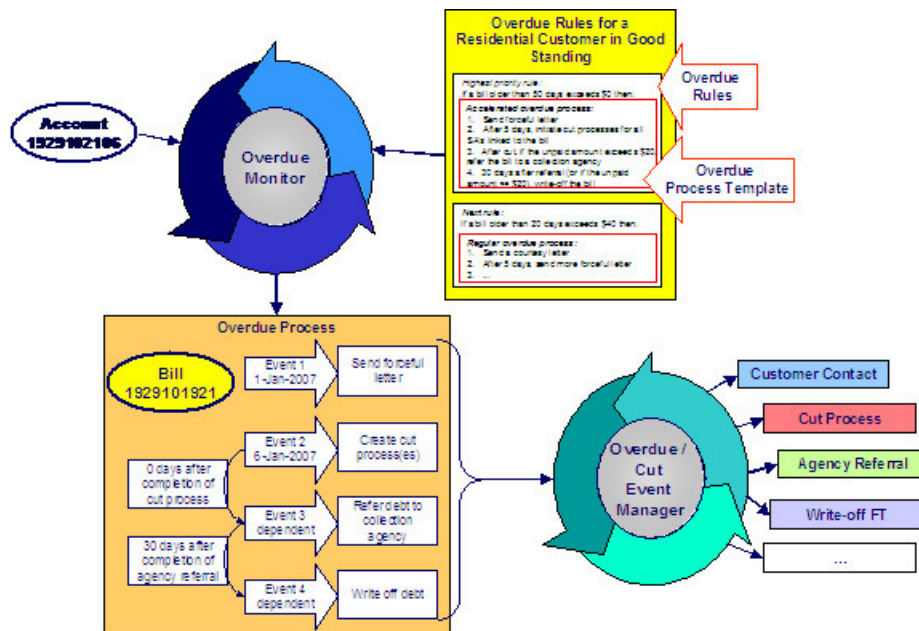

There are many important concepts illustrated above:

The **Overdue Monitor** checks if your accounts have bills that violate your overdue rules

The **Overdue Monitor** is a background process that periodically reviews your account's financial obligations.

Note well: every account belongs to a collection class. There are two types of collection classes: those whose accounts are monitored by the

[Account Debt Monitor](#), and those that are monitored by the Overdue Monitor. This chapter describes the Overdue Monitor.

---

Overdue rules define when and how unpaid bills are collected

An account's [collection class overdue rules](#) have algorithms that monitor an account's financial obligations. These algorithms are invoked by the Overdue Monitor when it's [time to review](#) an account's obligations.

These algorithms can contain any type of criteria. However, most are defined using a combination of a threshold age and monetary amount. For example, a classic algorithm would check if a bill has unpaid financial transactions more than 20 days old that exceed \$50.

In the case of bill-oriented collection, the monitoring algorithms look at each of the account's bills to determine if they are paid. Note, a bill is considered paid if its financial transactions (FTs) are linked to a balanced match event. If a monitoring algorithm finds an unpaid bill, it can check if it old enough (and large enough) to be considered a violation.

When you set up a monitoring algorithm, you define the type of overdue process that should be created when an overdue bill is detected. You do this by defining the appropriate "overdue process template".

---

An overdue process template defines how to handle an overdue bill

An [overdue process template](#) contains one or more [overdue event types](#). These define the number and type of events that are created to prod the customer to pay. For example, you might set up an overdue process template with event types to send a series of letters followed up by a call.

The overdue process template has contains the rules defining [when events are activated](#).

The specific action that's performed by an overdue event is controlled by the Activation algorithm defined on its event type. Refer to [Overdue Event Type - Main](#) for a list of the various Activation algorithms delivered with the base package.

---

Multiple objects can be associated with a single process

The above diagram shows a single bill linked to an overdue process. It should be noted that an overdue process is capable of referencing multiple bills (or other objects).

Note well: while a single overdue process can reference many overdue objects, all such objects must be of the same type. For example, you cannot commingle bills and service agreements under a single overdue process. The type of object managed by an overdue process is defined on its [overdue process template](#).

---

If a customer pays the bill, the overdue process is cancelled

If an overdue bill is paid, the [overdue process is canceled](#) real-time. You control if and how an overdue process is cancelled by setting up the appropriate rules on the [overdue process template](#).

---

The Overdue / Cut Event Manager activates and triggers overdue events

The [Overdue / Cut Event Manager](#) is a background process that activates overdue events on the appropriate date. On this date, the event's Activation algorithm(s) are called.

This Overdue / Cut Event Manager also has the responsibility of recursively activating later events that are dependent on the completion of earlier events.

---

Events can be activated real-time

[Overdue Process - Main](#) has a button that allows users to activate (and recursively trigger) overdue events online / real-time. This means you don't have to wait for a batch job to activate events.

Overdue events can wait for related activities to complete

As described above, an overdue event's Activation algorithm can create virtually any object. What wasn't explained is that the event can be set up to [wait](#) for the ancillary object to finish before it completes. For example, an event can create a To Do entry and wait for it to complete before the next event is triggered. You can introduce plug-ins to create and wait on virtually any object.

While an overdue event is in the Wait state, the Overdue / Cut Event Manager monitors the state of the related object(s). When the related object completes, the event is transitioned to the Complete state (thus triggering dependent overdue events). Please see [Some Events Wait For Something Before Completing](#) for more information.

## Cutting Service Agreements

An overdue process may contain an overdue event that creates a cut process(es). A cut process is used to cut (i.e., stop) a service agreement. The following diagram illustrates the objects and processes involved with cutting a service agreement.

**NOTE:**

**Cut processes aren't required.** It's quite conceivable to design an overdue process that doesn't cut service. For example, the overdue process may just contain an event that creates a case and the case manages the collection activities.

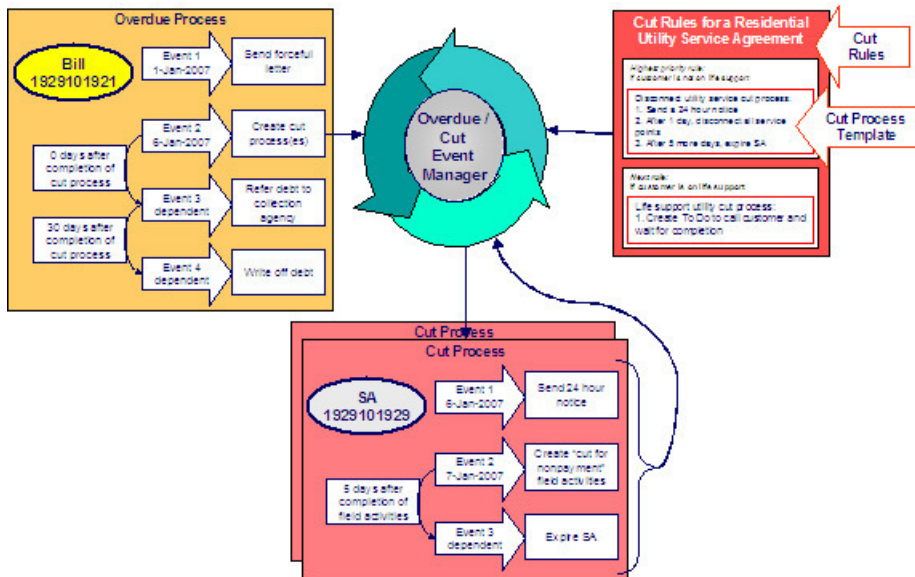

An overdue process may contain an overdue event that cuts (i.e., stops) service

If an overdue process's bill remains unpaid, one of the latter overdue events typically creates one or more [cut processes](#). A cut process contains the activities to stop a service agreement (in the hopes that lack of service will inspire the customer to pay). It should be noted that a separate cut process is created for each service agreement.



Cut rules define how to sever service agreements

The system allows you to define rules to control the type of cut process created. For example, you may have a different cut process if the customer has life support equipment, or if it's winter, or ...

The cut rules are defined on the service agreement's [SA type](#). This allows different rules for different types of service agreements.

---

Overdue events can "wait" for related activities to complete

When an overdue event creates cut process(es), it typically enters the Wait state. It enters this state as it is waiting for the cut process(es) to complete before it can itself complete. While in the Wait state, the Overdue / Cut Event Manager monitors the state of the related cut process(es). When the cut process(es) complete, the system transitions the originating overdue event to the Complete state (thus triggering dependent events).

---

A cut process template defines how to cut a service agreement

Cut processes and events are created using a [cut process template](#). A cut process template defines the actions involved in cutting a given type of service agreement. A cut process template usually contains several cut events. These events are a series of letters and / or disconnection field activities that eventually result in the expiration of a service agreement if payment is not received.

An Activation algorithm controls the specific action associated with a cut event and therefore an event can do practically anything. Refer to [Cut Event Type - Main](#) for a list of the various Activation algorithms delivered with the base package.

---

Cut events are also managed by the Overdue / Cut Event Manager

The same [background process](#) that manages the activation of overdue events manages cut events. This means you only have to submit one batch job to activate and trigger both overdue and cut events.

---

Events can be activated real-time

[Cut Process - Main](#) has a button that allows users to activate (and recursively trigger) cut events online / real-time. This means you don't have to wait for a batch job to activate events.

---

Cut events can "wait" just like overdue events

Cut events support the ability to wait for something to complete just like overdue events. For example, if a cut event creates a field activity, it enters the Wait state. While in the Wait state, the Overdue / Cut Event Manager monitors the state of the related field activities. When the field activities complete, the system transitions the originating cut event to the Complete state.

And, just like for overdue events, the notion of a cut event creating something and then waiting for it to complete is not limited to field activities. For example, you could have a cut event create a To Do entry and wait for it to complete before the next event is triggered.

Please see [Some Events Wait For Something Before Completing](#) for more information.

---

After a service agreement is stopped, it will be final billed

Many cut processes are configured so their last cut event [expires the service agreement](#). What happens at expiration depends on the type of service agreement. However, eventually the service agreement is transitioned into the Stopped state.

When the last active service agreement linked to an account is stopped, the system changes the account's bill cycle to bill that evening. If only one of many SAs is stopped, the SA will only be final billed as per the account's original bill cycle schedule.

---

If a customer doesn't pay their final bill, the final bill will be processed using a different type of overdue process

Final bills only differ from ongoing bills in that the service agreements associated with the bill's FTs are not active. This means that there is

nothing to cut. This means that the type of overdue process used to handle a "final" bill should differ from that used to handle "ongoing" bills.

As described above, overdue rules define how unpaid bills are handled (both ongoing and final). We recommend configuring your overdue rules to use different overdue process templates for final versus ongoing bills.

---

The last overdue event typically causes the debt to be written off

Ultimately, if the overdue and cut events fail to inspire payment, the debt will be written off. The method used to write-off a bill is controlled by an overdue event Activation algorithm.

---

## How Does The Overdue Monitor Work?

This section describes how the Overdue Monitor background process (C1-ADMOV) uses your overdue rules to collect overdue debt.

This process has an optional input parameter for CIS Division. It can be used if your implementation requires processing of data by CIS Division. You will need to create a copy of this process's batch control for each CIS Division.

---

### NOTE:

**Recommendation.** We recommend that you familiarize yourself with the concepts described in the [case studies](#) before reading this section.

**Collecting overdue bills.** The examples in the following section frequently refer to how the Overdue Monitor is configured for an organization that collects on unpaid bills. It should be noted that these are just examples as the Overdue Monitor can be used to collect on virtually anything (if you create the appropriate plug-in algorithms).

---

## Different Overdue Rules For Different Customers

The Overdue Monitor uses rules to control how it monitors an account's debt. The system allows you to define different rules for different combinations of collection class, division and currency code. For example,

- You probably have different collection rules for different jurisdictions (i.e., CIS Divisions). For example, if you have customers in different states / provinces, you may have different rules applied to each jurisdiction's debt. The **CIS division on each customer's account** defines the jurisdictional rules applied to the account's debt.
- You probably have different collection rules for different customer segments. For example, bills for large customers might be overdue if they are more than 10 days late, whereas small customers might have 24 days. You differentiate your customers in respect of the overdue via the **collection class on the customers' accounts**. An account's initial collection class is defaulted from its customer class. You may override an account's collection class at will.
- You will have different criteria for every currency in which you work because the monitoring process always compares a customer's debt against some value and this value must be denominated in the customer's currency. A customer's currency is defined using a **currency code on the account**.

The above means that every combination of CIS division, collection class, and currency code can have different rules. The following matrix is used to illustrate a sample organization's rules (note, we assume a single currency and therefore avoid the third dimension):

---

Account's Division	Account's Collection Class:	Account's Collection Class:
	Commercial Customer	Residential Customer

---

North	<p>Highest Priority: If a bill exists with unpaid FT's &gt; \$0 that is older than 45 days, create the commercial 45 days late overdue process.</p> <p>Next Priority: If a bill exists with unpaid FT's &gt; \$100 that is older than 30 days, create the commercial 30 days late overdue process.</p>	<p>Highest Priority: If a bill exists with unpaid FT's &gt; \$0 that is older than 50 days, create the accelerated overdue process for residential customers.</p> <p>Lower Priority: If a bill exists with unpaid FT's &gt; \$25 that is older than 25 days, create the courtesy reminder overdue process for residential customers.</p>
South	...	...

Notice that there can be multiple criteria for each cell in the matrix. What differentiates one criteria from another is its priority. The higher priority criteria will be compared first. If the debt violates the criteria, the overdue process is initiated and no further comparisons are performed.

## Overdue Rules Are Embodied In Algorithms

Your organization's overdue rules are defined in algorithms plugged in on [Collection Class Overdue Rules](#) (in the Overdue Monitor Rule system event). When the Overdue Monitor analyzes an account, it uses the rules associated with the account's collection class, CIS division and currency code. To analyze an account, it simply invokes these algorithms in sequence order, i.e., the lower the sequence, the higher its priority.

An Overdue Monitor Rule algorithm has two responsibilities:

- it determines if an account violates its overdue rules,
- if so, it creates one or more overdue processes using an [overdue process template](#)

## When Is An Account Monitored?

The Overdue Monitor determines if an account violates your overdue rules at least every X days, where X is defined on the [Customer Class - Controls](#) associated with the account's customer class and division (in the field Min Credit Review Freq (Days)).

In addition, the Overdue Monitor examines an account's debt as follows:

- X days after an account's bill due date (X is defined in the field Credit Review Grace Days on [customer class control](#)).
- If a payment is canceled with a cancellation reason that indicates non-sufficient funds.
- If a payment arrangement is broken (assuming you use the base package's break payment arrangement plug-in). Refer to [Breaking A Bill Oriented Payment Arrangement](#) for more information.
- If a pay plan is broken. Refer to [The Pay Plan Monitor](#) for more information.
- If a [match event](#) is added, changed or deleted.
- When a written off bill is [reversed](#).

### NOTE:

**Additional events.** Your implementation can have other events trigger the analysis of an account by the Overdue Monitor. To do this, add logic to insert a row on the CI\_ADM\_RVW\_SCH table when the event occurs. This row simply references the account ID to be reviewed and the desired review date.

## Collection Class Defines If And How Accounts Are Monitored

As described above, every account references a collection class. The collection class defines if and how its accounts are monitored. There are three options:

- The accounts are monitored by the [Account Debt Monitor](#)
- The accounts are monitored by the Overdue Monitor (this is described in this chapter).
- The accounts are not monitored for overdue debt.

---

### NOTE:

**Migration.** If you plan to migrate from the Account Debt Monitor (ADM) method of collection to the Overdue Monitor method, a special Overdue Monitor algorithm ( [CI-ACT-CSW](#) ) has been supplied that will skip accounts that are eligible for review by the Overdue Monitor if they have an active collection, severance or write-off process. This algorithm should be plugged in the applicable Collection Class Overdue Rules so that it will be invoked first. This allows accounts with active ADM-oriented collection activities to work themselves through the system. When an account no longer has any active ADM-oriented activities, monitoring responsibilities will be assumed by the Overdue Monitor.

---

## The Big Picture Of Overdue Processes

As described above, the Overdue Monitor subjects your accounts to overdue rules. If a rule is violated, an overdue process is created. The topics in this section provide background information about overdue processes.

### How Are Overdue Processes Created?

As described [above](#), the system creates an overdue process when an account violates your overdue rules. In addition, a user can manually create an overdue process at their discretion.

## The Components Of An Overdue Process

The following topics describe the major components of an overdue process.

### Overdue Objects

When an overdue process is created, the system links the overdue object(s) to the process. For example, if an overdue bill is detected, the bill is linked to the overdue process.

When you set up an [overdue process template](#), you define the type of object it collects on by defining the [foreign key characteristic type](#) used to reference the object. For example, when you set up an overdue process template to collect on bills, you define a foreign key characteristic type that references the bill object.

## Overdue Events

An overdue process has one or more overdue events. These events are the actions designed to encourage the customer to pay. For example, you might set up overdue events that:

- Send letters (via the creation of a customer contact)
- Create To Do entries
- Impact the account's credit rating
- Create a case (e.g., to seize the customer's assets)
- ... (the list is only limited by your imagination as algorithms are used to perform the event's actions)

You define the number and type of events by configuring [overdue process templates](#). When the system creates an overdue process, it copies the events defined on the specified template.

It's important to note that all overdue events are created when the overdue process is created. A separate background process, the [Overdue / Cut Event Manager](#), is responsible for activating, monitoring, and triggering overdue events. Activation of an event causes the system to do whatever the event indicates (e.g., send a letter, send a To Do entry to a user, start a cut process, refer debt to a collection agency, write-off debt, etc.).

## Overdue Log

Every overdue process has a log holding its history. Entries are added to the log when meaningful events occur, for example:

- When the process is created, a log entry is created to describe why the process was started.
- When an overdue event is activated, a log entry is created. These entries frequently contain a foreign key to the object that the event created so that users can easily drill down to the object from the log. For example, if an event creates a To Do entry, the To Do entry's foreign key is placed on the log and this allows a user to drill down on the log entry to see the To Do entry.
- When a process is canceled, a log entry is created to describe the circumstances of the cancellation (e.g., manual versus automated).
- Users can manually add log entries (you might want to think of these as "diary" entries) as desired.
- ...

Many of the base-package algorithms involved in overdue processing insert log entries so that a thorough audit trail is maintained. These algorithms have been designed to allow you to control the verbiage in each log entry by defining the desired message number using an algorithm parameter.

The log is viewable on the [Overdue Process - Log](#) page.

---

### NOTE:

**More than just an audit trail.** The log entries are more than just an audit trail. The system makes use of the log entries to know what it did. For example, when an overdue event needs to monitor the state of the To Do entries that it created, it uses the log to determine the identity of these To Do entries.

---

## Experimenting With Alternative Overdue Process Templates

The system allows you to determine the efficacy of proposed overdue process templates using a small subset of customers before implementing the templates on the entire customer base. We use the term "champion / challenger" to reference this functionality.

We'll use an example to explain. Let's assume your prevailing overdue process template for residential customers starts with a "gentle reminder" letter followed 10 days later by a letter threatening collection agency referral if payment is not received. You may want to experiment with the impact of a change to this template. For example, you may want to change the "gentle reminder" to something more assertive and follow this up 5 days later with an even sterner warning. You can use the "champion / challenger" functionality to perform this experiment.

The following points describe how to implement "champion / challenger" functionality:

- Set up a "challenger" overdue process template for each template that you want to experiment with.
- Insert a new **Champion/Challenger** option on the Overdue Processing [Feature Configuration](#) for every champion template. Each option's value defines:
  - the "champion" overdue process template code
  - the "challenger" overdue process template code
  - the percentage of the time the system should use the "challenger" template
- Keep in mind that you can only experiment with one challenger template per champion template. For example, let's assume you have two prevailing overdue process templates - one for residential customers and another for commercial customers. You can experiment with different challenger templates for the residential and commercial templates. However, you cannot experiment with two different challenger templates for the residential champion template (i.e., a champion template can have 0 or 1 challenger template).

After setting up the above, your implementation's [Overdue Rule Plug-In](#) may include logic to use the challenger template X % of the time rather than the champion template. The sample plug-in provided in the base product, called [C1-CB-CR-RAT](#), includes this logic.

If you are using the Oracle Utilities Analytics product, you can configure analytic zones in innumerable ways to compare the efficacy of the champion versus the challenger. For example,

- You can set up a graph to show the average duration of each type of process.
- You can set up a graph to show the average dollars that were successfully collected.
- You can set up a dimensional scorecard to show how each template performed in different regions (or customer classes or ...).
- Etc (the list is limited by your imagination)

## Overdue Process Information Is Overridable

"Overdue process info" is the concatenated string of information that summarizes an overdue process throughout the user interface. The base-package logic constructs this string by concatenating the following information:

- The description of its overdue process template
- Its status
- For active processes, the number of days since it was created. For inactive processes, the number of days since it was inactivated.
- For active processes, the unpaid amount of the objects being collected

If you'd prefer a different info string, you can develop a new algorithm and plug-it in on your [overdue process templates](#). This design allows some / all overdue process templates to have an override info string.

## Original and Unpaid Amounts

There are two amounts associated with each overdue object linked to an overdue process: its Original Amount and its Unpaid Amount. These amounts are used throughout overdue processing.

You control how these amounts are calculated by defining the appropriate algorithm on your [overdue process templates](#). For example, you can plug in a base-package algorithm ( [C1-CUAOA](#) ) if you collect on overdue bills and the original amount is the amount of financial transactions linked to the bill, and the unpaid amount is the sum of financial transactions that are not linked to balanced match events.

## Overdue Processes Are Highlighted Elsewhere

The topics in this section describe how other parts of the system highlight the existence of overdue and cut processes.

### Alert Zone

If you plug-in the appropriate alert algorithm ( [C1-OD-PROC](#) ) on the Installation record, alert(s) will be shown for active overdue processes in the Alert Zone that appears in the Dashboard and on Control Central - Account Information.

### Credit and Collections Zone

The Credit and Collections zone on [Control Central - Account Information](#) shows active overdue and cut processes.

### Account Activity History Zone

The Account Activity History Zone on [Control Central - Account Information](#) shows pending and waiting events and inactive processes.

## How Are Overdue Processes Cancelled?

A user may cancel an overdue process at their discretion, online / real-time using [Overdue Process - Main](#).

The system will automatically cancel an overdue process when the object(s) associated with the overdue process are sufficiently paid. Exactly when the system checks if an overdue process should be cancelled is dependent on your organization's billing and accounting rules. For example, if you practice [open-item accounting](#), you'd want to analyze an account's active overdue processes whenever a match event is added, changed or deleted (as match events are the only objects that impact if debt is considered paid in an open-item world). The base-package supports this specific example. If you need additional events to check if an overdue process should be canceled (e.g., the creation of a pay plan), a base-package change **MAY** be necessary. Please check with customer support if you have questions.

Two algorithms plugged-in on the [overdue process template](#) handle the cancellation:

- The Cancel Criteria algorithm is responsible for determining if an overdue process should be canceled. Algorithms of this type analyze the outstanding debt on the objects linked to the overdue process and indicate whether a process can be cancelled.

- The Cancel Logic algorithm is responsible for actually canceling the process. The logic involved in cancellation can be quite sophisticated as canceling an overdue process can result in the cancellation of its pending events and cut processes.

---

**NOTE:**

**Why two algorithms?** The reason two algorithms are involved in cancellation is because we want the cancellation logic to be encapsulated in one place so it can be called during both manual and automated cancellation.

**Different logic for different templates.** Because both the Cancel Criteria and Cancel Logic algorithms are plugged-in on the overdue process's template, you can have different cancellation criteria and logic for different templates.

---

## Overdue Processes Are Created From Templates

As described above, you set up [overdue process templates](#) to define the types of events and when they are executed. When an overdue process is created, its events are created by copying the event types from an overdue process template. The remaining topics in this section provide background information to assist you in setting up your templates.

## The Big Picture Of Overdue Events

This section describes the various types of overdue events and their lifecycle.

## How Are Overdue Events Created?

Overdue events are created as follows:

- The [Overdue Monitor](#) invokes Overdue Monitor Rules to periodically check your accounts (refer to [Overdue Rules Are Embodied In Algorithms](#) for how this works). An Overdue Monitor Rule creates an overdue process when an account violates your overdue rules. The overdue process has one or more overdue event(s). The number and type of events is controlled by the overdue process template specified on the Overdue Monitor Rule.
- Users can create an overdue process manually on [Overdue Process - Main](#). To do this, they specify an overdue process template. The number and type of overdue events is defaulted from the template.
- An overdue event may be manually added to an existing overdue process by a user on [Overdue Process - Events](#).

---

**NOTE:**

**Bottom line.** Most overdue events are created by the system when it creates an overdue process for delinquent obligations. If you need to create an ad hoc overdue event, you can either create an overdue process whose template contains the desired event OR link the desired event to an existing process.

---

## Overdue Events Can Do Many Things

An overdue event can perform a wide number of activities as the logic is embodied in an algorithm. The following points describe how this works:

- Every overdue event references an [overdue event type](#).
- The overdue event type, in turn, references an Event Activation algorithm.
- The Event Activation algorithm is invoked when the event is [triggered](#).



## Overdue Event Information Is Overridable

"Overdue event info" is the concatenated string of information that summarizes an overdue event throughout the system. The base-package logic constructs this string by concatenating the following information:

- The event type's description
- The event's status
- If it's pending:
  - If the event has a trigger date, the number of days until it's triggered plus the verbiage day(s) from today
  - Otherwise, the verbiage dependent on other events
- If it's waiting, the number of days, hours and minutes that it's been waiting
- If it's canceled, the cancel reason code's description
- If it's complete, the number of days, hours and minutes that it's been complete

If you'd prefer a different info string, you can develop a new algorithm and plug-it in on your event types. This design allows some / all event types to have an override info string.

## Overdue Event Lifecycle

The following diagram shows the possible lifecycle of an overdue event:

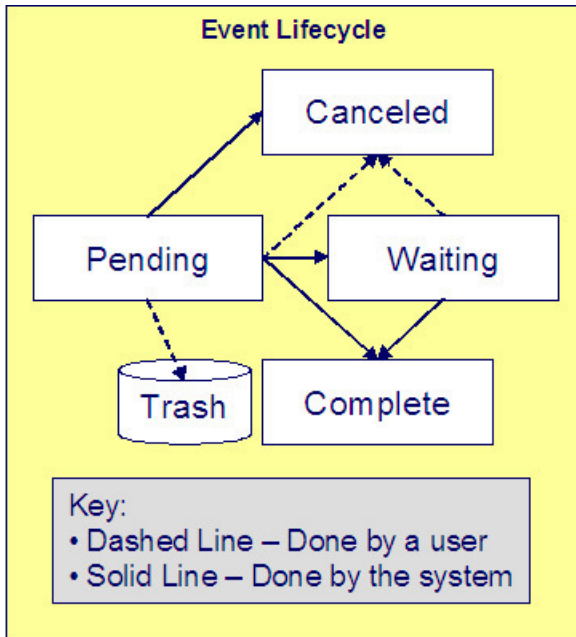

Overdue events are initially created in the Pending state. An event can take myriad paths after it's created; it all depends on how you've configured the system. The following topics describe an event's lifecycle:

## How and When Events Are Activated

An overdue event contains the date it should be activated; this is referred to as its trigger date. On this date, the Overdue / Cut Event Manager (a background process ( C1-ODET )) invokes the Event Activation algorithm plugged-in on the event's event type. The Event Activation algorithm, in turn, will decide on the state in which to leave the overdue event (e.g., it may transition it to the Complete state or the Waiting state).

If a user can't wait for the Overdue / Cut Event Manager real-time, they can click a button on [Overdue Process - Main](#) to activate (and recursively trigger) events online / real-time.

You control how an event's trigger date is populated by configuring the [overdue process template](#). You are given two choices when you link an event type to an overdue process template:

- You can indicate the event should be assigned a trigger date when it is first created. You'd use this approach on the first event and events with no dependencies on earlier events. The following points describe how to configure the overdue process template to do this:
  - Indicate the event type is NOT dependent on other events, and
  - Define the number of days after the process's creation to use when calculating the trigger date.
- You can indicate the event should be assigned a trigger date only after earlier events are Complete. This technique should be used whenever you have an event that is only executed after other events are Complete. The following points describe how to configure the overdue process template to do this:
  - Indicate the event is dependent on other events, and
  - Define the number of days after the completion / cancellation of all dependent event(s) that the trigger date should be set to. The Overdue / Cut Event Manager sets the trigger date on such an event when it detects that all of its dependent events are complete / canceled.

---

**NOTE:**

**Calendar vs Workdays.** When an overdue event is created by the system, its trigger date is set in accordance with your date arithmetic preferences. Refer to [Calendar vs. Work Days](#) for more information.

---

## Activating Events Should Add a Log Entry

As described [above](#), an overdue process has a log holding a history of meaningful events in the process's life. Most Event Activation algorithms will add an entry to the process's log.

These log entries are more than just an audit trail as they also reference the objects that are created during activation. For example, if an activation algorithm creates a customer contact, the ID of the customer contact will be referenced on the log (and end-users will be able to drill down on the log entry to see the customer contact).

## Holding Events

You can prevent a pending event with a trigger date on / before the current date from activating by plugging-in a Hold Event Activation plug-in on the overdue process template. This might prove useful, for example, if you want to suspend an overdue process while a [case](#) used to investigate the assertion of a customer is outstanding. Then, when the case closes, the overdue process can start up where it left off.

This technique would prove useful, for example, if your users can grant ad hoc suspend periods (e.g., if a customer wants a few extra days to pay before a cutoff). To do this, create a case type that has two states: Open and Close. Make sure to set up the Open state to have an automatic transition algorithm to close the case after X days. Then, all a user has to do is create a case of this type when they want to provide a suspend period. When the suspend period is over and payment isn't received, the case will close and the overdue process will start up where it left off.

## Some Events Wait For Something Before They Activate

Consider this scenario - you want an overdue event to create a To Do entry so a user can authorize the next phase of an overdue process. When this event activates, the event's activation algorithm will create a To Do entry, but it will NOT transition the event to complete. Rather, the overdue event will exist in the waiting state. While in the waiting state, the Overdue / Cut Event Manager will monitor the state of the To Do entry. When the To Do entry completes, the original overdue event can transition to the complete state and then latter dependent events can be triggered. The following points describe how to configure the system to support this type of event:

- The event type's Event Activation algorithm should behave as follows:
  - It creates the object on which the overdue event waits.
  - It must link this object to the overdue process by creating a log entry where the prime-key of the related object is referenced (in a foreign-key characteristic). This log entry should also reference the event.
  - It should leave the overdue event in the waiting state.
- The event type must have a Monitor Waiting Event algorithm. This algorithm is invoked each time the [Overdue / Cut Event Manager](#) executes. If the related object has transitioned to a "final" state, the originating overdue event is transitioned to the complete state (and then latter dependent events are triggered).

---

### NOTE:

**Bottom line.** Two algorithms must be set up on an overdue event type to implement waiting functionality: an Event Activation algorithm that creates the monitored object and a Monitor Waiting Event algorithm to check on the state of the monitored object. The Overdue / Cut Event Manager has the dual responsibility of activating the event and monitoring its related object for completion (and then triggering the dependent events when it completes).

---

While the above example illustrated how an overdue event could create and then monitor a To Do entry, you can use this functionality to create and monitor any object that has an initial and final state. If the base package does not contain the algorithms you need, simply develop new ones using the base-package algorithms as examples.

## How Are Events Canceled

A pending event will be cancelled automatically by the system when the overdue process is canceled. Refer to [How Are Overdue Processes Cancelled](#) for more information.

A user may cancel a pending or waiting event at their discretion.

Regardless of what triggers the cancellation, the Cancel Logic algorithm plugged in on the overdue event type handles the cancellation. This allows you to introduce additional cancellation logic should the need arise. Please note that the base package cancel algorithms insert a [log entry](#) when a user manually cancels an event.

## The Big Picture Of Cut Processes

While not required, many overdue processes will contain one or more events that will cut (i.e., stop) service. When such an event activates, it creates a "cut process". A cut process is very similar to an overdue process; the major difference is that a cut process is linked to a specific service agreement (the one being cut), whereas an overdue process is linked to the object(s) in arrears.

The topics in this section provide background information about cut processes.

## How Are Cut Processes Created?

The activation of an overdue event can create one or more cut processes.

In addition, a user can manually create a cut process at their discretion using [Cut Process - Main](#).

## Overdue Events Wait For The Cut Process To Conclude

Overdue events that create cut processes are perfect examples of events that [wait](#) for the object they create to complete before they, in turn, complete. After the cut process concludes, the originating overdue event will complete thus triggering its dependent events.

## Cut Processes Exist Under An Overdue Process

It's important to note that a cut process exists in respect of an overdue process. In other words, you can't create a cut process without referencing a parent overdue process. There are two reasons why:

- A cut process's overdue process defines the objects in arrears. It is these objects that are monitored to determine if the cut process (and overdue process) can be cancelled.
- The [log](#) associated with a cut process's overdue process contains the history of the cut process(es) and their events; there is no log specific to a cut process.

## The Components Of A Cut Process

Cut processes are simpler than overdue processes as they simply contain one or more "cut events". These events are the service agreement-specific actions designed to encourage the customer to pay. For example, you might set up cut events that:

- Create [field activities to cut service](#)
- Send letters (via the creation of a customer contact)
- Create To Do entries
- Impact the account's credit rating
- Create a case (e.g., to manage a customer with life support issues)
- ... (the list is only limited by your imagination as algorithms are used to perform the event's actions)

You define the number and type of events by configuring [cut process templates](#). When the system creates a cut process, it copies the events defined on the related template.

It's important to note that all cut events are created when the cut process is created. The Overdue / Cut Event Manager is responsible for activating the cut events at the appropriate time. Activation of an event causes the system to do whatever the event indicates (e.g., send a letter, send a To Do entry to a user, create a field activity, etc.)

Cut processes do not have their own log as their history is maintained on the parent overdue process's [log](#).

## Cut Process Information Is Overridable

"Cut process info" is the concatenated string of information that summarizes a cut process throughout the system. The base-package logic constructs this string by concatenating the following information:

- Its cut process template's description
- Its status
- For active processes, the number of days since it was created. For inactive processes, the number of days since it was inactivated.
- For active processes, the unpaid amount of the objects being collected on the cut process's overdue process

If you'd prefer a different info string, you can develop a new algorithm and plug-it in on your cut process templates. This design allows some / all cut process templates to have an override info string.

## How Are Cut Processes Cancelled?

A user may cancel a cut process at their discretion, online / real-time using [Cut Process - Main](#).

The system will automatically cancel a cut process when the overdue process is cancelled.

Regardless of what triggers the cancellation, the Cancel Cut Process algorithm plugged in on the cut process's [template](#) handles the cancellation.

If a cut process is canceled and the cut process's events created field activities, the cancel logic embodied in the algorithm can be quite sophisticated. Refer to [Field Activities To Cut And Reconnect Service](#) for an example.

## Cut Processes and Events Are Created From Templates

When a cut process is created, its cut events are created by copying a cut process template's event types. Cut events follow the same lifecycle and possess the same behavior as [overdue events](#).

## Cut Events Are Like Overdue Events

Cut events almost identical to [overdue events](#). The major difference is that cut events exists under a cut process and therefore are oriented towards the cut process's service agreement. The following topics describe other differences between cut events and overdue events.

## Field Activities To Cut and Reconnect Service

A cut process that's created for a service agreement whose service can be severed will typically contain a cut event that creates field activity(s) to cut service. The base-package cut event activation algorithm will create field activities for the service points linked to the service agreement being cut. The type of activity is defined on the [field activity type profile](#) defined on each service point's SP type. Please see [C1-CE-CR-FA](#) for the exact details of the base-package algorithm.

If the cut process is canceled after field activity(s) are created and before the cut process completes, different activities can transpire. The specifics of what happens are controlled by a Cancel Logic algorithm plugged in on the [cut process template](#). The following points summarize how a base-package algorithm ( [C1-CP-DWFA](#) ) works:

- It assembles all Pending, Held and Complete cut for nonpayment field activities (FA) created by the cut process (these are defined in the overdue process's [log](#)).
- Each FA is processed as follows:

- If the FA is Pending or Held and it is not linked to a field order (i.e., it hasn't been dispatched):
  - The FA is cancelled
  - An entry is added to the overdue process log to indicate the cancellation
- If the FA is Pending or Held and it is linked to a field order (i.e., it has been dispatched):
  - A To Do entry is created (the To Do Type is defined on the algorithm)
- If the FA is Complete and the Cut Process's SA is pending start or active (i.e., it hasn't been expired yet):
  - Reconnect field activity(s) are created for every service point that had a cut for non-payment field activity. The type of activity is defined on the [field activity type profile](#) defined on each service point's SP type.

## A Cut Event Expires Service Agreements (and May Trigger Final Billing)

The last cut event is typically set up with an activation algorithm that expires the cut process's service agreement. If earlier cut events created "cut for non-payment" field activities, these field activities will be used as the basis for stopping service. Refer to [Finalizing Pending Stops](#) for how the system use the meter reads on these field activities as the "stop reads" on the service agreement. Note, you can see the field activities that are used to "cut" and "stop" service by viewing the Field Activities grid on [Service Agreement - Service Point](#).

---

### NOTE:

**Final billing.** When the last service agreement linked to an account is expired, the system will schedule the account for billing (outside of its normal bill cycle schedule).

---

## Write Offs Are Implemented Using Overdue Events

The system has been designed to allow overdue events on the original overdue process to write-off the objects being collected. Refer to [Writing Off Bills](#) for a case-study explaining how to do this.

## Calendar vs. Work Days

When you set up your overdue and cut process templates, you supply information that controls how each event's trigger date is calculated. You have two options:

- You can say that an event's trigger date can only be populated after earlier, dependent events are complete. For example, the 2<sup>nd</sup> event (cut service) is triggered 2 days after the 1<sup>st</sup> event is complete (48 hour warning letter).
- You can say that an event's trigger date is populated when the process is first created. You simply define the number of days after the start of the process when each such event should be triggered. For example, the 2<sup>nd</sup> event (send cutoff warning) can be triggered 7 days after the start of the process.

In addition to the above, an option defined on the [Feature Configuration for Overdue Processing](#) plays a part in the calculation of an event's trigger date:

- If you set the option to use calendar days, the trigger date of events will be set to the first workday on / after the calculated date. For example, if you indicate that the 2<sup>nd</sup> event is triggered 7 days after the 1<sup>st</sup> event, the system will add 7 days to the 1<sup>st</sup> event's completion date. It then checks if this is a workday (and not a holiday); if so, this is the trigger date of the event; if not, it assigns the trigger date to the next workday.

- If you set the option to use workdays, the trigger date will be calculated by counting workdays. For example, if you indicate that the 2<sup>nd</sup> event is triggered 7 days after the 1<sup>st</sup> event, the system will count 7 workdays and set the trigger date accordingly.

---

**NOTE:**

**Account's division controls the work calendar.** The system uses the above information in conjunction with the [work calendar](#) associated with the account's division to determine workdays.

---

## Bill-Oriented Collection - Advanced Topics

The topics in this section provide information on features designed to facilitate the collection of overdue bills.

## Miscellaneous Bill-Oriented Collection Topics

The topics in this section provide background information about a variety of bill-oriented collection topics.

## Highlights Of The Sample Overdue Monitor Rule Algorithm

A base-package Overdue Monitor Rule algorithm exists to support many different types of overdue rules (see [C1-CB-CR-RAT](#)). Keep in mind that multiple such algorithms can be plugged in on [Collection Class Overdue Rules](#). When the [Overdue Monitor](#) analyzes an account, it calls these algorithms until there are no more to invoke (or until an algorithm tells it that there is nothing more to check). The following points describe its various options:

- **Different rules based on credit ratings.** You can set up algorithms to only be applied to accounts with a credit rating  $\leq$  a given value. We anticipate such algorithms will be used in conjunction with other such algorithms to apply different rules based on the customer's credit rating.
- **Different rules based on an account or service agreement characteristic.** You can set up algorithms to only be applied if an account or one of its service agreements has a given characteristic type and value effective within the last X days. For example, you could set up an algorithm that would process an account if it had a broken payment arrangement service agreement within the last 365 days (broken payment arrangement service agreements are marked with a given char type and value). You could set up a different algorithm that treated strategic customers more leniently (given that the definition of "strategic" could be held in an account or service agreement characteristic).
- **Skipping a bill if it has a future postpone date.** You can set up algorithms to ignore an unpaid bill if it has a "postpone date" that's in the future. This date would be defined on the bill using an ad hoc characteristic. The characteristic type is defined as a parameter on the algorithm.
- **Special process for bills with disputed debt.** You can set up an algorithm to create a given type of overdue process if the bill has disputed debt. By "disputed debt", we mean a bill with a financial transaction that's linked to an unbalanced match event that's marked as Disputed.
- **Special process for bills with credit balances.** You can set up an algorithm to create a special overdue process if the bill's total charges are negative (i.e., a credit bill). Such bills should be very unusual as we strongly recommend that credit bills should have their credit balance applied to an overpayment service agreement during bill completion.
- **Different rules when all service agreements are inactive.** You can set up an algorithm that should only be applied if all service agreements are inactive. We anticipate this can be used to differ the type of overdue process as if an account does not have active service agreements; there is nothing to stop to encourage them to pay.
- **Different rules based on age and amount of a bill.** You can set up an algorithm to create different types of overdue processes based on the age and amount of the bills.

---

**NOTE:**

**You are not limited by the base-package's rules.** If your implementation requires options that are not supported by the base-package algorithm, simply develop your own.

---

## Holding A Process's Events

Refer to [Holding Events](#) for a description of how to prevent the activation of an overdue / cut processes events while a given condition is true. The condition is defined in an algorithm so you can set up the system to prevent event activation for practically any condition. For example, you might want to hold event activation while the bill's account has an active case (e.g., a user might set up a case to conduct an ad hoc investigation of billing discrepancies). When the case closes, you'd want the process to start up where it left off.

## Bill Info Shows Unpaid and Write-off Amounts

The base-package Bill Information algorithm (plugged in on the [Installation](#) record) is responsible for constructing a bill's summary information that appears throughout the system. This algorithm can be configured to show the unpaid and write-off amounts of each bill.

## Writing Off Bills

The topics in this section provide background information on how to write off bills.

## After Service Is Cut, Write-Off Oriented Events Can Commence

After the last service agreement has been stopped, overdue events to manage the write-off of the overdue process's bill(s) should be triggered. Please note that a separate overdue process is NOT created to manage write-offs. Rather, events associated with the original overdue process will handle the write-off activities.

## Collection Agency Referrals

Before debt is written off, many implementations refer the unpaid bills to a collection agency. The following points describe how to implement this.

- Set up an overdue event type with an activation algorithm that refers an overdue process's bill(s) to a collection agency.
- When such an event is activated, the system creates a [Collection Referral](#) record for a collection agency. The specific agency to which the debt is referred is controlled by the event type's activation algorithm. The sample algorithm simply refers debt to the collection agency with the least amount of referred debt. If you prefer different logic, you must develop your own algorithm.
- A collection agency referral history record is linked to an account. It contains the amount of debt referred to the collection agency. It is the creation of this record that triggers the interface of information to the collection agency. The method used to interface the information to the agency is defined on the collection agency's record. Refer to [Setting Up Collection Agencies](#) for more information.
- If the collection agency is successful in obtaining the funds, a payment will be added. If the payment satisfies the cancel criteria defined on the overdue process template's cancellation plug-in, the overdue process will cancel. When an



overdue process is cancelled, the cancel criteria on the overdue process's template are executed. We strongly recommend plugging in an algorithm that will cancel collection agency referrals when an overdue process is cancelled.

- If the collection agency is not successful in obtaining your funds after a given amount of time, you probably want to cancel the referral and write-off the debt. The cancellation of the referral will happen automatically if you set up your overdue process template to have an event that creates a collection agency cancellation X days after the referral. You can cancel a referral manually by simply creating a new collection agency referral history record (with a type of cancel ).
- Collection agencies are notified of the cancellation of a referral by the creation of a new collection agency referral history record (with a type of cancel). This record will be interfaced to the agency in the same manner used to interface a new referral (see above).

---

**NOTE:**

**Log entry.** The base-package overdue event activation algorithms that make and cancel collection agency referrals insert rows in the overdue process's [log](#) to audit these events.

---

## Writing Off Bills Will Create Write-Off Adjustments And Possibly A Match Event

Most overdue process templates will be configured to contain an event that writes-off the unpaid balance of bills.

---

**NOTE:**

**Processing is redirected to another algorithm.** The base-package overdue event activation algorithm that writes off bills simply redirects the call to the Write-Off Bill algorithm plugged in on the account's [Collection Class Overdue Rules](#). The reason for this redirection is because users can manually write-off a bill (using [Bill - Main](#)) and when they do this, we want to invoke the same logic as when an overdue process writes-off a bill.

---

The base-package Collection Class Overdue Rules - Write-Off Bill algorithm determines the amount that should be written off for each distribution code on each unpaid financial transaction. It then creates a separate adjustment for each service agreement where the lines on the adjustment contain the amount to be written off for each distribution code. If the unpaid financial transactions are not linked to a match event, the write-off adjustments plus the unpaid financial transactions will be linked to a new match event. If the unpaid financial transactions were linked to an unbalanced match event, the write-off adjustments will be added to the existing match event (thus making it balanced).

If partial payments were made against a bill, the amount written off will be prorated in light of the partial payments. For example, if 20% of a bill had been paid, 80% of each distribution code will be written off.

For example, assume the original bill's FT looked as follows (note, if the bill has multiple service agreements this will need to be done for each SA's FT's):

- Debit A/R \$110.00
- Credit Flat Charge Revenue (\$50)
- Credit Usage Revenue (\$50)
- Credit City Tax Payable (\$5)
- Credit State Tax Payable (\$5)

Assume the customer had made a partial payment of \$11 and it was matched to this FT. At write-off time, the system will create an adjustment whose adjustment lines will cause each distribution code to be written off by 90% (100% - \$11 / \$110). For example:

- Debit Flat Charge Revenue (or some W/O Expense) \$45
- Debit Usage Revenue \$45
- Debit City Tax Payable \$4.50
- Debit State Tax Payable \$4.50

- Credit A/R \$99

This adjustment will then be linked to the original match event on which the payment was linked (thus making it Balanced ).

---

**NOTE:**

**Log entry.** The base-package overdue event activation algorithm that writes off bills inserts a row into the overdue process's [log](#) for each bill written off.

---

## Small Amount Write-Downs

Many organizations will write-down a bill whose value is small early in an overdue process. The base-package overdue event activation algorithm has parameters to support this requirement (this algorithm allows you to write-off an overdue process's bill(s) if their value is less than a threshold amount).

If your organization writes-down small amounts differently than large amount, simply set up an overdue event type to reference such an activation algorithm and position it in the appropriate place in the overdue process template.

## Bill Info Shows Written Off Amounts

The base-package Bill Information algorithm (plugged in on the [Installation](#) record) is responsible for constructing a bill's summary information that appears throughout the system. This algorithm can be configured to show the amount written-off for each bill.

## Online Write Off Of Bills Is Performed On Bill-Main

If a bill's account is associated with a [Collection Class Overdue Rule](#) that has a Write Off Bill algorithm, a button appears on [Bill - Main](#) if the bill hasn't been written off. When clicked, the Write Off Bill algorithm is invoked to write-off the bill.

## Online Reversal Of Written Off Bills Is Performed On Bill-Main

If a bill's account is associated with a [Collection Class Overdue Rule](#) that has a Write Off Bill algorithm, a button appears on [Bill - Main](#) if the bill has been written off. When clicked, the Write Off Bill algorithm is invoked (in reversal mode). The algorithm cancels the write-off adjustments (thus making the bill payable again). It also schedules the account for review by the [Overdue Monitor](#) the next time it runs.

## Write Offs And Overdue Process Cancellation

It should be stressed that writing-off a bill may cause an overdue process to be canceled because the bill's FT will be linked to a balanced match event (note, the specific [cancel criteria](#) are in a plug-in so this is not a hard rule).

The following points highlight interesting aspects of bill write-off and overdue process cancellation:

- If a user writes off a bill [real time](#) and the bill has an Active overdue process, the process's cancel criteria will be invoked. This typically results in the cancellation of the overdue process.
- If an overdue event writes off a bill, the state of the process depends on your cancel criteria and where the overdue event is positioned in the overdue process. For example,

- Imagine an overdue process that has an overdue event that writes off small amounts of debt early in the process. If such a process is applied against bill with a small amount of debt, the process will be canceled (when the event activates).
- Contrast this to an overdue process where the last event writes off the bill. Because there are no other events to activate, the process will complete (i.e., it will not be canceled).

## An Alert Can Show Written Off Bills

A base-package Control Central Alert algorithm ( [C1-WO-BILL](#)) can be set up to highlight if the account in context has written off bills. This algorithm is plugged in on the [Installation](#) record.

## Bill-Oriented Payment Arrangements

A payment arrangement is an agreement with a customer to payoff severely overdue debt in **billed** installments. Bills sent to customers with payment arrangements contain charges for both their current services and their payment arrangement installment amount.

---

### NOTE:

**Nomenclature.** Some organizations refer to payment arrangements as "current bill plus" agreements because the customer's bills contain charges for both their current debt plus their installment amount. After the customer has paid off their overdue debt, the payment arrangement closes and the customer's bills only contain charges for their current debt.

---

The topics in this section describe how to set up a payment arrangement and how the system monitors the ongoing arrangements.

## Creating Payment Arrangements

When you create a payment arrangement, you are actually creating a service agreement. This service agreement is just like other service agreements in that:

- It holds debt.
- It is periodically billed (thus creating unmatched bill segment financial transactions).
- When a payment is received, the payment segment financial transactions are matched to the bill segment financial transactions.

Debt is transferred to a payment arrangement service agreement (PA SA) from the customer's delinquent bills at the inception of the payment arrangement.

When you transfer debt from the overdue bills to a PA SA, transfer adjustments are created to transfer debt from the delinquent SAs to the PA SA. Match events are created to link the "transfer from" adjustments to the original unpaid financial transactions (FT). When all FT's on a bill are linked to balanced match events, the bill is no longer considered overdue and any active overdue process (and its related cut processes) will be cancelled. Refer to [How Are Overdue Processes Canceled](#) for more information.

---

### NOTE:

**Use the Payment Arrangement Transaction.** Use the [Payment Arrangement - Bill Oriented](#) to set up bill-oriented payment arrangements. This transaction creates a PA SA, transfers overdue bills to it, and sets up the installment amount. This transaction is also used if you need to break or cancel the payment arrangement.

## Installment, Payoff and Current Amounts

**WARNING:**

If you do not understand the difference between payoff balance and current balance, refer to [Current Amount versus Payoff Amount](#).

When you set up a payment arrangement service agreement (PA SA), you transfer delinquent debt to the PA SA using transfer adjustments. After moneys are transferred, the system sets the PA SA's current balance to zero. At this point, there will be no overdue bills. If the customer neglects to pay bills containing charges associated with the payment arrangement, an overdue process will ensue.

PA SAs start their life with a non-zero payoff balance (i.e., they have debt when first started). This debt is transferred from the bills whose outstanding debt necessitated the creation of the PA SA.

The installment amount that the customer is billed is determined by the number of installments used to payoff the debt. For example, if the customer owes \$500 and they want to pay this off in 10 installments, you'd set up the installment amount to be \$50. The installment amount is saved on the PA SA's recurring charge amount. If the customer again falls into arrears on their bills, you can transfer additional bills to the PA SA. You can also change the installment amount as needed.

A PA SA's payoff balance typically differs from its current balance. The payoff balance is the amount of debt remaining to be paid off under the terms of the payment arrangement. The current balance is the installment amount that has been billed but not paid. For example, a customer who is paying off \$500 with 10 installments of \$50 would have an initial payoff balance of \$500 and a current balance of \$0. After the first bill, the PA SA would still have a payoff balance of \$500, but its current balance would be \$50. When the customer pays, the PA SA's payoff balance would fall to \$450 and its current balance would return to \$0.

The following table contains a financial example of a customer who sets up a payment arrangement to payoff \$1,000 of debt in \$10 installments.

Event	Normal SA's GL Accounting	PA SA's GL Accounting	Normal SA's Current Balance	Normal SA's Payoff Balance	PA SA's Current Balance	PA SA's Payoff Balance
Prior to creation of payment arrangement	N/A	N/A	1000	1000	N/A	N/A
Transfer debt from normal SA(s) to PA SA	Xfer 1000 A/R <1000>	PA A/R 1000 Xfer <1000>	0	0	1000	1000
Set current balance to zero on PA SA	N/A	N/A	0	0	0	1000
Customer is billed (\$50 for new debt and \$10 of payment arrangement debt)	A/R 50 Revenue <50>	N/A	50	50	10	1000

Customer pays \$60	Cash 50 A/R <50>	Cash 10 PA A/R <10>	0	0	0	990
-----------------------	---------------------	------------------------	---	---	---	-----

When the customer pays off the payment arrangement debt, the system automatically closes the PA SA after it final bills (assuming the PA SA's SA type references a bill segment type that has a bill segment creation algorithm of Recurring Charge With Auto Stop ).

## Breaking A Bill-Oriented Payment Arrangement

If a customer neglects to pay a bill, an overdue process is created. If the bill contains charges from a payment arrangement, you'll want to "break" the payment arrangement. By "break", we mean cancel the arrangement and reinstate the debt under the originating bills. To do this, you must configure the [cut process template](#) used to cut the PA SA to contain a cut event that breaks the payment arrangement.

### NOTE:

**Processing is redirected to another algorithm.** The base-package cut event activation algorithm that breaks a payment arrangement simply redirects the call to the Bill-Based Payment Arrangement algorithm plugged in on the account's [Collection Class Overdue Rules](#). The reason for this redirection is that users can manually break a payment arrangement (using [Payment Arrangement - Bill Oriented](#)). When they do this, we want to invoke the same logic as when a cut event activation algorithm breaks a payment arrangement.

The base-package Collection Class Overdue Rule - Bill-Based Payment Arrangement algorithm does the following:

- Creates "cancel adjustments" for all unpaid financial transactions associated with the payment arrangement (e.g., billed, but not paid installments).
- Cancels ALL adjustments that were used to transfer the debt to the payment arrangement. When these are cancelled, the original bills will become unpaid (and the debt will be rather old by this point).
- Syncs up current balance with payoff balance on the PA SA.
- Makes the PA SA pending stop and expires it (SA activation will stop the SA when it next runs).
- If there is a credit left on the PA SA (because payments were made against the arrangement), the credit will be distributed amongst the bills that contributed debt to it (the oldest bills are paid off first). This relief will occur via transfer adjustments from the PA SA to the original SAs.
- Note, if there is a debit left (e.g., because LPC were issued or some other type of adjustment was created by an operator), an error is issued as we don't handle new debit on a payment arrangement.
- Inserts a characteristic on the PA SA to indicate that it has been broken (you might want to use this to cause more strict overdue rules to be applied to accounts with broken payment arrangements).
- Marks the account so it will be reviewed by the [Overdue Monitor](#) the next time it runs.

### NOTE:

**The PA SA must final bill before it closes.** It's important to note that the PA SA will only close after the PA SA is final billed. This is OK as it won't have any money left on it.

When the Overdue Monitor next runs, it will analyze the account's reinstated bills. We recommend setting up a Collection Class Overdue Rule - Overdue Monitor Rule algorithm that has more stringent rules if the account has a broken payment arrangement within the last X days. The base-package algorithm ( [CI-CB-CR-RAT](#) ) supports this type of processing.

### NOTE:

**Log entry.** The base-package overdue event activation algorithm that breaks a payment arrangement SA inserts a row into the overdue process's [log](#).

---

## Online Breaking

A user can click a button on the [Payment Arrangement - Bill Oriented](#) page to break a payment arrangement real time. When clicked, the Collection Class Overdue Rule - Bill-Based Payment Arrangement algorithm is called to break the payment arrangement. This is the same algorithm called when a cut event break a payment arrangement.

## Online Canceling

A user can click a button on the [Payment Arrangement - Bill Oriented](#) page to cancel a payment arrangement real time. Cancellation should be used when you want to "logically delete" a PA SA because it shouldn't have been created.

The logic described above for breaking a payment arrangement is executed when a user cancels a payment arrangement; the only difference is that the PA SA is marked with a different characteristic type / value than when it is broken. The "broken" characteristic type / value can be used to apply stricter rules to the account when it's next reviewed by the [Overdue Monitor](#).

## Creating Overdue and Cut Procedures

Your overdue procedures define how your organization collects overdue debt. Your cut procedures define how your organization cuts (i.e., stops) service agreements when collection attempts fail. In this section, we describe how to set up the data that controls these procedures.

---

**WARNING:**

There are numerous ways to design your overdue and cut procedures. Some designs will result in easy long-term maintenance; others will result in maintenance headaches. In this section, we provide information to help you understand the ramifications of the various options. Before you set up your overdue and cut procedures, we encourage you to gain an intuitive understanding of these options by using the system to prototype the alternatives.

---

## Designing Your Overdue Procedures

The design of your overdue procedures is an iterative process. Over time, you will develop skills that will allow you to skip some steps. However, when you're starting out, we recommend you use the following matrix as your guide. When the matrix is complete, you're ready to set up the overdue processing control tables.

---

Account's Division	Account's Collection Class:	Account's Collection Class:

---

The topics discussed below will gradually complete this matrix using a simple case study.

---

**FASTPATH:**

For more information about how the information in this matrix is used to monitor your customers' debt, refer to [How Does The Overdue Monitor Work](#).

---

## Your Divisions Are Frequently Preordained

An account's division defines the jurisdiction whose rules govern the account. For example, an account's division controls how its payments are distributed, if / how late payment charges are levied, etc. Divisions have typically been designed in advance of designing your overdue rules.

In our example, we assume you have two divisions: North and South.

Account's Division	Account's Collection Class:	Account's Collection Class:
North		
South		

## Designing Your Collection Classes

Multiple collection classes are needed when your organization has different overdue rules and / or procedures based on the type of customer. If all customers are treated the same way, you'll have a single collection class (call it Generic ). However, if you're like many organizations, you will have multiple collection classes.

For example, for commercial/industrial customers, you probably don't worry until they owe you more than, say, \$100 after 20 days. For residential customers, you probably don't worry until they owe you more than, say, \$5 after 20 days. In this situation, you will have at least two collection classes: one for commercial/industrial customers, the other for residential customers.

In our example, we assume you have two collection classes: Residential and Commercial/Industrial.

Account's Division	Account's Collection Class:	Account's Collection Class:
	Residential	Commercial/Industrial
North		
South		

### NOTE:

There are two very different ways to monitor your accounts for overdue debt. This chapter describes the method referred to as Overdue Processing. Refer to [Collection / Severance / Write Off](#) for a description of the other method. We anticipate that most organizations will only use a single method. If your organization opts to use both methods, you will need to set up the corresponding collection classes.

## Designing Overdue Monitoring Rules

At this point, we have the rows and columns defined in our matrix. Now it's time to work on the individual cells.

### NOTE:

**Single currency.** We've assumed that your implementation works in a single currency. If this is not true, you will need to add a 3rd dimension that will have a value for each currency code.

Each cell will contain the rules that the [Overdue Monitor](#) uses to determine if an account has overdue debt. These rules will eventually be configured using one or more algorithms on [Collection Class Overdue Rules](#).

Account's Division	Account's Collection Class:	Account's Collection Class:
	Residential	Commercial/Industrial
North		
South		

**NOTE:**

If the Overdue Monitor encounters an account whose collection class and division does not have overdue rules set up, it will issue an error.

Determining the rules in each cell can be straightforward or complicated; it depends on how your organization works. Our case study assumes the following:

- For residential debt (regardless of division) we have the following rules:
  - Highest priority. If a bill exists with unpaid FT's > \$0 that is older than 50 days, create the "accelerated overdue process" for residential customers. We'll talk more about this process later.
  - Medium priority. If the account's has a broken payment arrangement within the last 60 days with an unpaid bill > \$0 that is older than 20 days, create the "broken payment arrangement overdue process".
  - Lower priority. If a bill exists with unpaid FT's > \$25 that is older than 25 days, create the "courtesy reminder overdue process" for residential customers. We'll talk more about this overdue process later.
- For commercial-industrial debt (regardless of division) we have the following rules:
  - Highest priority. If a bill exists with unpaid FT's > \$0 that is older than 45 days, create the "commercial 45 days late overdue process". We'll talk more about this process later.
  - Medium priority. If the account's credit rating is < 550 and has an unpaid bill > \$0 that is older than 20 days, create the "risky commercial customer overdue process".
  - Lower priority. If a bill exists with unpaid FT's > \$100 that is older than 30 days, create the "commercial 30 days late overdue process". We'll talk more about this overdue process later.

Given the above, our matrix will look as follows:

Account's Division	Account's Collection Class:	Account's Collection Class:
	Residential	Commercial/Industrial
North	<p>Highest Priority: If a bill exists with unpaid FT's &gt; \$0 that is older than 50 days, create the accelerated overdue process for residential customers.</p> <p>Medium Priority: If the account has a broken payment arrangement within the last 60 days with an unpaid bill &gt; \$0 that is older than 20 days, create the broken payment arrangement overdue process.</p> <p>Lowest Priority: If a bill exists with unpaid FT's &gt; \$25 that is older than 25 days, create the courtesy reminder overdue process for residential customers.</p>	<p>Highest Priority: If a bill exists with unpaid FT's &gt; \$0 that is older than 45 days, create the commercial 45 days late overdue process.</p> <p>Medium priority. If the account's credit rating is &lt; 550 and has an unpaid bill &gt; \$0 that is older than 20 days, create the risky commercial customer overdue process.</p> <p>Lowest Priority: If a bill exists with unpaid FT's &gt; \$100 that is older than 30 days, create the commercial 30 days late overdue process.</p>



**NOTE:**

**The rules are limited by your imagination (and business requirements).** While the base-package Overdue Monitor Rule algorithm ( [C1-CB-CR-RAT](#) ) supports the above scenarios, we'd like to stress these are just examples. Your implementation can operate using very different rules by either configuring the base-package algorithm (it has many parameters that you can use to tailor your rules) OR by introducing a new algorithm. Refer to [Highlights Of The Sample Overdue Monitor Rule Algorithm](#) for the options delivered with the base-package.

## Designing Overdue Process Templates and Event Types

The following table shows a sample overdue process template for one of the rules in the Residential / North cell in the previous section's matrix.

Overdue Process Template	Overdue Event Type	When Triggered
Accelerated overdue process for residential customers	Old debt letter	At inception of process
	Cut active service agreements	10 days after inception
	Reduce customer's credit rating	10 days after inception (i.e., at the same time the cut process is created)
	Write down small debt	0 days after completion of the cut process(es)
	Refer debt to collection agent	0 days after attempting the small write down (this means that either the small write-down or the agency referral will take place as if the write-down is successful, the bill's FTs will be matched to balanced match events and the overdue process will stop)
	Cancel collection agent referral	45 days after referral
	Write-off debt	0 days after collection agent cancellation

You should create a similar table for each of the distinct overdue process templates in your matrix.

At this point, you've designed the distinct overdue process templates. Next, you'll need to design the algorithms that control their overdue processes:

- A template's Calculate Unpaid and Original Amount algorithm calculates the original and unpaid amounts of the objects being collected by a process. These values are used throughout the overdue processing module.
- A template's Cancel Criteria algorithm is executed to determine if a process should be cancelled. Refer to [How Are Overdue Processes Cancelled](#) for the details.
- A template's Cancel Logic algorithm is executed to cancel a process. Refer to [How Are Overdue Processes Cancelled](#) for the details. Please note that the logic embodied in this type of algorithm can be sophisticated because it is responsible for stopping an ongoing process's activities (e.g., this could involve cancelling field activities or cases). Cancellation algorithms are also responsible for inserting [log](#) entry(s).
- A template's Hold Event Activation algorithm is invoked to determine if the [Overdue / Cut Event Manager](#) should [suspend the activation](#) of the process's events.
- A template's Information algorithm is invoked to construct the [override "info string"](#).

Next, extract each unique event type from the above table:

Overdue Event Type	Action
Old debt letter	Create a customer contact
Cut active service agreement(s)	Start a cut process for every active SA with an unpaid FT on the bill
Reduce customer's credit rating	Insert an account credit rating history record
Write down small debt	Create write-down adjustments if unpaid debt is less than \$x
Refer debt to collection agent	Create a collection agency referral
Cancel collection agent referral	Cancel the collection agency referral
Write off unpaid debt	Create adjustments to write-off unpaid debt

At this point, you know the distinct event types. Next, you'll need to design the algorithms that control the lifecycle of each event type:

- The event type's Event Activation algorithm(s) are executed by the [Overdue / Cut Event Manager](#) on its trigger date. The following points describe the logic embodied in such an algorithm:
  - The activity that happens on the trigger date (e.g., creation of a customer contact, To Do, etc.). Refer to [Overdue Events Can Do Many Things](#) for the details.
  - Whether the event is transitioned into the Waiting or Complete state when it's triggered. Refer to [Some Events Can Wait](#) for the details.
  - How the log entry(s) associated with event activation will be constructed. The base-package algorithms allow you to control the verbiage in the log entry by defining the desired message number on the algorithm. This means that you may have to set up new messages. Refer to [Activating Events Should Add A Log Entry](#) for the details.
- The event type's Cancel Logic algorithm(s) are invoked when [an event is cancelled](#). The following points describe the logic embodied in such an algorithm:
  - If the event is allowed to be canceled. This logic may be necessary if some conditions prevent events of this type from canceling. For example, you may want to prevent an event from canceling when there are later dependent events that aren't canceled.
  - Any ancillary actions that take place during cancellation.
  - How the [log entry\(s\)](#) associated with event cancellation will be constructed.
- The event type's Monitor Waiting Event algorithm(s) are invoked to [monitor a waiting event](#). These algorithms are responsible for transitioning a Waiting event to Complete if the object on which it's waiting is complete.
- The event type's Event Information algorithm is invoked to construct the [override "info string"](#).

Once you've designed each event type's algorithms, you're ready to design your cut processes.

## Designing Cut Process Templates and Event Types

While not required, many overdue processes will contain an overdue event that cuts (i.e., stops) service (in the hopes that stopping service will inspire the customer to pay). When such an event activates, it creates one or more cut process(es).

The system allows you to control if and how service is cut by setting up Cut Process Rule algorithms on your SA types. This allows different rules for different types of service agreements. In addition, because these rules are embodied in algorithms, a given SA type can have conditional logic that controls the type of cut process created. For example, you may have a different cut process if the customer has life support equipment, or if it's winter, or ...

---

### NOTE:

**If a service agreements of a given type should never be cut.** If you have certain SA types that should never be cut, do NOT define an algorithm in the SA type's Cut Process Rule .

Determining your Cut Process Rules can be straightforward or complicated; it depends on how your organization works. Our case study assumes the following:

- For service agreements associated with metered service, we have the following rules:
  - Highest priority. If the customer has life support requirements, create "cut process in light of life support" process.
  - Lowest priority. Otherwise, create a "metered service" cut process.
- For service agreements associated with charitable contributions, create an "expiration only" cut process.

Once you've determined if / how each SA type is cut, you need to design your cut process templates (you'll need one for each unique method of cutting a service agreement). The following table shows the cut process templates referenced above. Adjacent to each process are its events and an indication of when they are triggered.

Cut Process Template	Event Number	Cut Event Type	Dependent On Event(s)	Trigger Date Set To X Days After Completion Of Dependent Events
Metered service	10	Letter - 48 hour disconnect for non-payment warning	N/A - first event	0
	20	Field activity - disconnect for non-payment	10	2
	30	'Service has been disconnected' letter	20	0
	40	Expire service agreement	20	10
Cut process in light of life support	10	Generate delinquent life support customer To Do entry (seeking approval for the cut)	N/A - first event	0
	20	Letter - 72 hour disconnect for non-payment warning	10	0
	30	Generate impending life support cutoff To Do entry to C&C rep	20	3
	40	Field activity - cut for non-payment	30	0
	50	Service has been disconnected letter	40	0
	60	Expire service agreement	40	10
Expiration only	10	Expire service agreement	N/A - first event	

At this point, you've designed the distinct cut process templates. Next, you'll need to design the algorithms that control the lifecycle of their cut processes:

- A template's Cancel Logic algorithm is executed to cancel a process. In addition to cancelling the event, these algorithms are also responsible for inserting **log** entry(s).
- A template's Information algorithm is invoked to construct the **override "info string"**.

Next, extract each unique event type from the above table:

Cut Event Type	Action
48-hour warning letter	Create a customer contact - 48-hour warning letter (letters are created via customer contacts)
72-hour warning letter	Create a customer contact - 72-hour warning letter
Disconnect for non payment	Create a cut for non-payment field activity
Permission to start a cut process for a life support customer	Create To Do seeking permission to send 72 hour letter
Permission to create a cut field activity for a life support cutoff	Create To Do seeking permission to issue a cut field activity
Service has been disconnected letter	Create a customer contact - service cut letter
Expire service agreement	Expire service agreement

At this point, you know the distinct event types. Next, you'll need to design the algorithms that control the lifecycle of their events:

- The event type's Event Activation algorithm(s) are executed by the [Overdue / Cut Event Manager](#) on its trigger date. The following points describe the logic embodied in such an algorithm:
  - The activity that happens on the trigger date (e.g., creation of a customer contact, To Do, etc.). Refer to [Cut Events Can Do Many Things](#) for the details.
  - Whether the event is transitioned into the Waiting or Complete state when it's triggered. Refer to [Some Events Can Wait](#) for the details.
  - How the log entry(s) associated with event activation will be constructed. The base-package algorithms allow you to control the verbiage in the log entry by defining the desired message number on the algorithm. This means that you may have to set up new messages. Refer to [Activating Events Should Add A Log Entry](#) for the details.
- The event type's Cancel Logic algorithm(s) are invoked when [an event is cancelled](#). The following points describe the logic embodied in such an algorithm:
  - If the event is allowed to be canceled. This logic may be necessary if some conditions prevent events of this type from canceling. For example, you may want to prevent an event from canceling when there are later dependent events that aren't canceled.
  - Any ancillary actions that take place during cancellation.
  - How the [log entry\(s\)](#) associated with event cancellation will be constructed.
- The event type's Monitor Waiting Event algorithm(s) are invoked to [monitor a waiting event](#). These algorithms are responsible for transitioning a Waiting event to Complete if the object on which it's waiting is complete.
- The event type's Event Information algorithm is invoked to construct the [override "info string"](#).

## Set Up Tasks

The above topics provided background information about how overdue processing works. The following discussion summarizes the various set up tasks.

## Cut Event Types

You will find that most of the time spent setting up your cut event types is spent setting up the objects that are referenced on the cut event type algorithms. For example, if you use the base-package algorithms, you may need to set up the following:

- The various "types" for the objects created by the plug-ins. For example, if a cut event type creates a To Do entry, you must supply the desired To Do type.
- [Foreign key characteristic types](#) that are used to reference the ancillary objects in the [log entries](#) (e.g., if an event creates a customer contact, the log references this customer contact using a FK characteristic type). Note, many of these will exist in the base-package.
- [Messages](#) that are used to define the verbiage in the [log entries](#). For example, if you use the base-package algorithm that creates a customer contact, you must supply the desired message category and number that contains the verbiage that appears in the log when customer contacts are created. Note, messages have been set up for all base-package algorithms (this means you should not have to set up new messages).
- Etc.

The only way to compile the complete list is to design the parameters for each cut event type algorithm. Refer to [Cut Event Type - Main](#) for the supported plug-in spots.

After you've set up the objects referenced on the algorithms, you can then set up the algorithms. Only then can you set up the cut event types.

## Cut Process Templates

After your cut event types exist, you can set up your cut process templates. You will find that most of the time spent setting up your cut process templates is spent setting up the objects that are referenced on the cut process template algorithms. Refer to [Cut Process Template - Main](#) for the supported system events.

## SA Type - Cut Process Rules

After you've created your cut process templates, you can set up the algorithms that hold your [cut process rules](#). These are plugged-in on [SA Type - Algorithm](#) in the Cut Process Rule system event.

## Overdue Event Types

You will find that most of the time spent setting up your overdue event types is spent setting up the objects that are referenced on the overdue event type algorithms. For example, if you use the base-package algorithms, you will set up the following:

- The various "types" for the objects created by the plug-ins. For example,
  - If an overdue event type creates a To Do entry, you must set up the To Do type.
  - If an overdue event type creates a customer contact, you must set up the customer contact type.
  - If an overdue event type writes off debt, you must set up the adjustment types.
  - Etc.
- [Foreign key characteristic types](#) that are used to reference the ancillary objects in the [log entries](#) (e.g., if an event creates a customer contact, the log references this customer contact using a FK characteristic type). Note, many of these will exist in the base-package.
- [Messages](#) that are used to define the verbiage in the [log entries](#). For example, if you use the base-package algorithm that creates a customer contact, you must supply the desired message category and number that contains the verbiage that

appears in the log when customer contacts are created. Note, messages have been set up for all base-package algorithms (this means you should not have to set up new messages).

- Etc.

The only way to compile the complete list is to design the parameters for each overdue event type algorithm. Refer to [Overdue Event Type - Main](#) for the supported plug-in spots.

After you've set up the objects referenced on the algorithms, you can then set up the algorithms. Only then can you set up the overdue event types.

## Overdue Process Templates

After your overdue event types exist, you can set up your overdue process templates. You will find that most of the time spent setting up your overdue process templates is spent setting up the objects that are referenced on the overdue process template algorithms. Refer to [Overdue Process Template - Main](#) for the supported system events.

## Collection Classes

Set up [collection classes](#) as per your [overdue procedures](#). Make sure to indicate that these collection classes use the Overdue collection method (only accounts linked to collection classes designated as using the Overdue collection method or processed by the Overdue Monitor).

## Collection Class Overdue Monitor Rules

After your overdue process templates exist, you can set up your Overdue Monitor Rules. These rules are algorithms plugged in on [Collection Class Overdue Rules](#). You will find most of the time spent setting up these algorithms is spent setting up the objects referenced on the base-package algorithm.

## Feature Configuration

You must set up a [Feature Configuration](#) to define parameters that control various overdue processing options.

The following points describe the various **Option Types** that must be defined:

- Trigger Date: Y-Workdays, N-Calendar Days. This option controls how the system computes the trigger dates on overdue and cut events. Enter Y if the system should use workdays. Enter N if the system should use calendar days. Refer to [Calendar vs Work Days](#) for the details.
- Payment Arrangement Type (B/S/A). This option indicates whether your implementation uses the [Balance-Oriented Payment Arrangements](#) (value **S**), [Bill-oriented Payment Arrangements](#) (value **B**) or both (value **A**). The value governs the navigation path for the payment arrangement lines in the [Account History](#) and [Credit & Collection](#) zones.
- Champion Template\$Challenger Template\$Percentage(1-100). You need only set up options of this type if your implementation implements [Champion / Challenger](#) functionality. Options of this type are entered in the format A \$B\$nnn where A is the overdue process template of the champion template, B is the overdue process template of the challenger template, and C is the percent of the time that the system should create the challenger template. The overdue monitor uses this option to override the champion overdue process template X% of the time with the challenger template. You may enter any number of these options (but only one per Champion Template).

## Overdue and Cut Event Cancellation Reasons

Overdue events can be cancelled automatically and manually (at the discretion of a user). Regardless of the method of cancellation, a cancellation reason must be supplied. You set up your overdue event cancellation reasons using [Overdue Event Cancellation Reason - Main](#) and [Cut Event Cancellation Reason - Main](#).

## Collection Agencies

If you refer debt to collection agents, you must set up your [collection agencies](#).

## Alert To Highlight Active Overdue Processes

If you want an alert to appear if the account has active overdue processes, you must configure an appropriate Control Central Alert algorithm ( [C1-OD-PROC](#)). This algorithm is plugged in on the [Installation](#) record.

## Bill-Oriented Collection - Additional Set Up

The topics in this section provide information on additional set up requirements if you collect on unpaid bills.

## One Bill Per Match Event

As mentioned earlier, a bill is considered paid if its financial transactions (FTs) are linked to a balanced match event. To determine a bill's outstanding amount, FTs from different bills cannot be commingled on the same match event (but it's OK for a bill's FTs to be on multiple match events). If you stick by the rule of "just one bill per match event" you will then be able to determine the outstanding balance of a partially paid bill. However, if you mix more than one bill under a match event, a particular bill's balance may become indeterminate.

The following Open-Item algorithm types have been provided by the base package to help enforce this rule:

- The Distribute by Bill Due Date Payment Distribution algorithm ( [C1-PYDS-BDU](#)).
- The match by Bill ID Payment Distribution Override algorithm ( [C1-PDOV-PYBL](#)).
- The FT cancellation FT Freeze algorithm ( [C1-CFTZ-COFT](#)).

If any of your customized plug-ins and processes create match events, it is important that these too enforce this rule. You may want to refer to the base package algorithms as an example of how to do this.

## Bill-Based Payment Arrangements

If you set up [payment arrangements for unpaid bills](#), you must configure the Bill-Based Payment Arrangement algorithm and plug it in on your [Collection Class Overdue Rules](#).

It's important to set up the adjustment types used during payment arrangement creation to NOT print on bills. This is because the base-package algorithm will match the adjustments used to transfer debt to the payment arrangement with the adjustment used to reduce the payment arrangement's current amount by the amount of the transfer if all adjustment types are set up to not print.

## Bill-Based Write-off

If you [write-off unpaid bills](#), you must set up the following:

- Set up the adjustment type that will be used to write-off an unpaid financial transaction. This adjustment type must be configured as follows:
  - **Adjustment Amount Type** must be Calculated Amount
  - Its distribution code is irrelevant as a separate calculation line will be created for each distribution code on the FT's that is written off and these lines will reference the appropriate distribution code.
  - It must reference an adjustment type char type / value that identifies it as one used to write-off a bill's FTs
  - The following algorithms must be defined on the adjustment type:
- The Generate Adjustment system event must reference an algorithm that has the responsibility of determining how to write-off a FT. This algorithm should be determining the FT's GL details and creating a separate adjustment calculation line for each GL detail. The base package is supplied with a sample algorithm that does this ( [C1-ADJG-WO](#)).
- The Adjustment Financial Transaction system event should reference an algorithm that impacts current, payoff and the GL by the amount being written off.
  - The distribution codes referenced on the financial transactions must be set up with a characteristic that holds the distribution code used to write-off the original amounts. For example,
    - Distribution codes used to record tax liabilities will typically reference the same distribution code for write-off (most organizations reverse tax liabilities at write-off time)
    - Distribution codes used to record revenue will typically reference a write-off distribution code used to record a write-off expense.
    - Distribution codes used to record receivables will typically not reference a write-off distribution code because receivables are implicitly written off when revenue and tax liabilities are written off.
  - Set up an adjustment cancellation code used when a users reverses a written-off bill (reversal involves canceling the write off adjustments).
  - Set up a Write Off Bill algorithm and plug it in on your [Collection Class Overdue Rules](#). This algorithm will reference the adjustment type described in the previous point.

## Alert To Highlight Written Off Bills

If you want an alert to appear if the account has bills with written-off debt, you must configure an appropriate Control Central Alert algorithm ( [C1-WO-BILL](#)). This algorithm is plugged in on the [Installation](#) record.

## Open-Item Bill Amount Plug-In

You must set up the algorithm that computes the original, unpaid, and write-off amounts of your open-item bills. This algorithm is called by other algorithms when these amounts are needed. This algorithm is plugged-in on [Installation](#) in the Determine Open Item Bill Amounts spot.

## Setting Up Overdue Processing



The topics in this section describe how to set up the control tables to implement your overdue processing.

## Setting Up Overdue Event Types

An overdue event type encapsulates the business rules that govern a given type of overdue event. Open **Admin > Credit & Collection > Overdue Event Type > Add** to set up overdue event types.

---

**NOTE:**

**Recommendation.** Before using this transaction, we strongly recommend that you review [The Big Picture Of Overdue Events](#).

---

### Description of Page

Enter a unique **Overdue Event Type** code and **Description** for the overdue event type.

Use **Long Description** to provide a more detailed explanation of the purpose of the overdue event type.

The **Algorithms** grid contains algorithms that control important functions. You must define the following for each algorithm:

- Specify the algorithm's **System Event** (see the following table for a description of all possible events).
- Specify the **Algorithm** to be executed when the System Event executes. Set the **Sequence** to 10 unless you have a **System Event** that has multiple **Algorithms**. In this case, you need to tell the system the **Sequence** in which they should execute.

The following table describes each **System Event** (note, all system event's are optional and you can define an unlimited number of algorithms for each event).

System Event	Optional / Required	Description
Cancel Logic	Required	This algorithm is executed to cancel an overdue event. Refer to <a href="#">How Are Events Canceled</a> for the details.  Click <a href="#">here</a> to see the algorithm types available for this system event.
Event Activation	Required	This algorithm is executed to activate an overdue event on its trigger date. Refer to <a href="#">Overdue Events Can Do Many Things</a> and <a href="#">How and When Events Are Activated</a> for the details.  Click <a href="#">here</a> to see the algorithm types available for this system event.
Event Information	Optional - only used if you want to override an overdue event's info string	This algorithm is executed to construct an overdue event's override info string. Refer to <a href="#">Overdue Event Information Is Overridable</a> for the details.  Click <a href="#">here</a> to see the algorithm types available for this system event.
Monitor Waiting Events	Optional - only used if events of this type can enter the Waiting state	This algorithm is invoked by the Overdue / Cut Event Manager for events in the Waiting state. Refer to <a href="#">Some Events Wait For Something Before Completing</a> for the details.

---

## Where Used

Follow this link to open the data dictionary where you can view the tables that reference [CI\\_OD\\_EVT\\_TYPE](#).

## Setting Up Overdue Process Templates

An overdue process template encapsulates the business rules that govern a given type of overdue process. Open **Admin > Credit & Collection > Overdue Process Template > Add** to set up overdue process templates.

---

### NOTE:

**Recommendation.** Before using this transaction, we strongly recommend that you review [The Big Picture Of Overdue Processes](#).

---

### Description of Page

Enter a unique **Overdue Process Template** and **Description** for the overdue process template.

**Collecting On Object** defines the type of object managed by this overdue process. This field actually references a [foreign key characteristic type](#) that references the managed object. For example, if this overdue process template manages overdue bills, you'd reference a foreign key characteristic that references the bill object.

The **Algorithms** grid contains algorithms that control important functions. You must define the following for each algorithm:

- Specify the algorithm's **System Event** (see the following table for a description of all possible events).
- Specify the **Algorithm** to be executed when the System Event executes. Set the **Sequence** to 10 unless you have a **System Event** that has multiple **Algorithms**. In this case, you need to tell the system the **Sequence** in which they should execute.

The following table describes each **System Event** (note, all system event's are optional and you can define an unlimited number of algorithms for each event).

System Event	Optional / Required	Description
Calculate Unpaid & Original Amount	Required	This algorithm is executed to calculate the unpaid and original amounts of the objects associated with the overdue process. These amounts are shown on the overdue process page and in the base-package <a href="#">overdue info string</a> .  Click <a href="#">here</a> to see the algorithm types available for this system event.
Cancel Criteria	Required	This algorithm is executed to determine if an overdue process can be cancelled. Refer to <a href="#">How Are Overdue Processes Cancelled</a> for the details.  Click <a href="#">here</a> to see the algorithm types available for this system event.
Cancel Logic	Required	This algorithm is executed to cancel an overdue process. Refer to <a href="#">How Are Overdue Processes Cancelled</a> for the details.

		Click <a href="#">here</a> to see the algorithm types available for this system event.
Hold Event Activation Criteria	Optional - only used if overdue processes of this type can be suspended while some condition is true	This algorithm is executed to determine if the activation of overdue and cut events should be suspended. Refer to <a href="#">Holding Events</a> for the details.  Click <a href="#">here</a> to see the algorithm types available for this system event.
Overdue Process Information	Optional - only used if you want to override an overdue process's info string	This algorithm is executed to construct an overdue process's override info string. Refer to <a href="#">Overdue Process Information Is Overridable</a> for the details.  Click <a href="#">here</a> to see the algorithm types available for this system event.

The **Event Types** control the number and type of overdue events linked to an overdue process when it is first created. The information in the scroll defines these events and the date on which they will be triggered. The following fields are required for each event type:

- **Event Sequence.** Sequence controls the order in which the overdue event types appear in the scroll.
- **Overdue Event Type.** Specify the type of overdue event to be created.
- **Days After.** If **Dependent on Other Events** is on, events will be triggered this many days after the completion of the dependent events (specified in the grid). Set this value to 0 (zero) if you want the event triggered immediately after the completion of the dependent events. If **Dependent on Other Events** is off, events will be triggered this many days after the creation of the overdue process. Refer to [How and When Events Are Activated](#) for the details.
- If **Dependent on Other Events** is on, define the events that must be completed or cancelled before the event will be triggered.
  - **Sequence** is system-assigned and cannot be specified or changed.
  - **Dependent on Sequence** is the sequence of the dependent event.

#### Where Used

Follow this link to open the data dictionary where you can view the tables that reference [CI\\_OD\\_PROC\\_TMP](#).

## Setting Up Cut Event Types

A cut event type encapsulates the business rules that govern a given type of cut event. Open **Admin > Credit & Collection > Cut Event Type > Add** to set up cut event types.

#### NOTE:

**Recommendation.** Before using this transaction, we strongly recommend that you review [Cut Events Are Like Overdue Events](#).

#### Description of Page

Enter a unique **Cut Event Type** code and **Description** for the cut event type.

Use **Long Description** to provide a more detailed explanation of the purpose of the cut event type.

The **Algorithms** grid contains algorithms that control important functions. You must define the following for each algorithm:

- Specify the algorithm's **System Event** (see the following table for a description of all possible events).
- Specify the **Algorithm** to be executed when the System Event executes. Set the **Sequence** to 10 unless you have a **System Event** that has multiple **Algorithms**. In this case, you need to tell the system the **Sequence** in which they should execute.

The following table describes each **System Event**.

System Event	Optional / Required	Description
Cancel Logic	Required	This algorithm is executed to cancel a cut event. Refer to <a href="#">How Are Events Canceled</a> for the details.  Click <a href="#">here</a> to see the algorithm types available for this system event.
Event Activation	Required	This algorithm is executed to activate a cut event on its trigger date. <a href="#">How and When Events Are Activated</a> for the details.  Click <a href="#">here</a> to see the algorithm types available for this system event.
Event Information	Optional - only used if you want to override a cut event's info string	This algorithm is executed to construct a cut event's override info string. Refer to <a href="#">Cut Event Information Is Overridable</a> for the details.  Click <a href="#">here</a> to see the algorithm types available for this system event.
Monitor Waiting Events	Optional - only used if events of this type can enter the Waiting state	This algorithm is invoked by the Cut / Cut Event Manager for events in the Waiting state. Refer to <a href="#">Some Events Wait For Something Before Completing</a> for the details.  Click <a href="#">here</a> to see the algorithm types available for this system event.

### Where Used

Follow this link to open the data dictionary where you can view the tables that reference [CI\\_CUT\\_EVT\\_TYPE](#).

## Setting Up Cut Process Templates

A cut process template encapsulates the business rules that govern a given type of cut process. Open **Admin > Credit & Collection > Cut Process Template > Add** to set up cut process templates.

### NOTE:

**Recommendation.** Before using this transaction, we strongly recommend that you review [The Big Picture Of Cut Processes](#).

### Description of Page

Enter a unique **Cut Process Template** and **Description** for the cut process template.

The **Algorithms** grid contains algorithms that control important functions. You must define the following for each algorithm:

- Specify the algorithm's **System Event** (see the following table for a description of all possible events).

- Specify the **Algorithm** to be executed when the System Event executes. Set the **Sequence** to 10 unless you have a **System Event** that has multiple **Algorithms**. In this case, you need to tell the system the **Sequence** in which they should execute.

The following table describes each **System Event**.

System Event	Optional / Required	Description
Cancel Logic	Required	This algorithm is executed to cancel a cut process. Refer to <a href="#">How Are Cut Processes Cancelled</a> for the details.  Click <a href="#">here</a> to see the algorithm types available for this system event.
Cut Process Information	Optional - only used if you want to override a cut process's info string	This algorithm is executed to construct a cut process's override info string. Refer to <a href="#">Cut Process Information Is Overridable</a> for the details.  Click <a href="#">here</a> to see the algorithm types available for this system event.

The **Event Types** control the number and type of events linked to a cut process when it is first created. The information in the scroll defines these events and the date on which they will be triggered. The following fields are required for each event type:

- Event Sequence.** Sequence controls the order in which the cut event types appear in the scroll.
- Cut Event Type.** Specify the type of cut event to be created.
- Days After.** If **Dependent on Other Events** is on, events will be triggered this many days after the completion of the dependent events (specified in the grid). Set this value to 0 (zero) if you want the event triggered immediately after the completion of the dependent events. If **Dependent on Other Events** is off, events will be triggered this many days after the creation of the cut process. Refer to [How and When Events Are Activated](#) for the details.
- If **Dependent on Other Events** is on, define the events that must be completed or cancelled before the event will be triggered.
  - Sequence** is system-assigned and cannot be specified or changed.
  - Dependent on Sequence** is the sequence of the dependent event.

#### Where Used

Follow this link to open the data dictionary where you can view the tables that reference [CL\\_CUT\\_PROC\\_TMP](#).

## Setting Up Collection Class Overdue Rules

Collection class overdue rules contain algorithms that impact accounts associated with a given collection class, division and currency code are managed. Open **Admin > Credit & Collection > Collection Class Overdue Rules > Add** to set up collection class overdue rules.

#### NOTE:

**Recommendation.** Before using this transaction, we strongly recommend that you review [Different Overdue Rules For Different Customers](#).

#### Description of Page

Enter the **Collection Class**, **CIS Division** and **Currency Code** to which the rules apply.

The **Algorithms** grid contains algorithms that control important functions. You must define the following for each algorithm:

- Specify the algorithm's **System Event** (see the following table for a description of all possible events).
- Specify the **Algorithm** to be executed when the System Event executes. Set the **Sequence** to 10 unless you have a **System Event** that has multiple **Algorithms**. In this case, you need to tell the system the **Sequence** in which they should execute.

The following table describes each **System Event**.

System Event	Optional / Required	Description
Bill-Based Payment Arrangement	Optional - only specified if your implementation uses bill-oriented payment arrangements	This algorithm is executed to handle the creation, breaking and canceling of a <a href="#">Bill-Oriented Payment Arrangements</a> .  Click <a href="#">here</a> to see the algorithm types available for this system event.
Overdue Monitor Rule	Required	This algorithm is invoked by the Overdue Monitor to analyze an account's debt. Refer to <a href="#">How Does The Overdue Monitor Work</a> for the details.  If you have multiple rules (and therefore multiple algorithms), please take care when assigning the sequence number, as the Overdue Monitor will invoke these rules in sequence order.  Click <a href="#">here</a> to see the algorithm types available for this system event.
Write Off Bill	Option - only specified if your implementation writes-off bills	This algorithm is executed to handle the write-off and write-off reversal of a bill. Refer to <a href="#">Writing Off Bills</a> .  Click <a href="#">here</a> to see the algorithm types available for this system event.

### Where Used

Follow this link to open the data dictionary where you can view the tables that reference [CI\\_OD\\_RULE\\_ALG](#).

## Setting Up Overdue Event Cancellation Reasons

An overdue event cancel reason must be supplied before an overdue event can be canceled. Open **Admin > Credit & Collection > Overdue Event Cancel Reason** to define overdue event cancellation reasons.

### Description of Page

Enter an easily recognizable **Overdue Event Cancel Reason** and **Description** for each cancellation reason.

### Where Used

Follow this link to open the data dictionary where you can view the tables that reference [CI\\_OEVT\\_CAN\\_RSN](#).

## Setting Up Cut Event Cancellation Reasons

A cut event cancel reason must be supplied before a cut event can be canceled. Open **Admin > Credit & Collection > Cut Event Cancel Reason** to define cut event cancellation reasons.

### Description of Page

Enter an easily recognizable **Cut Event Cancel Reason** and **Description** for each cancellation reason.

### Where Used

Follow this link to open the data dictionary where you can view the tables that reference [CI\\_CEVT\\_CAN\\_RSN](#).

## Defining Prepaid Metering Options

The topics in this section describe how to set up the system to enable prepaid metering functionality.

---

### NOTE:

**Prepaid metering is optional.** The system configuration requirements described in this section are only relevant if your organization offers prepaid metering service.

---

## The Big Picture of Prepaid Metering

Prepaid metering allows customers to pay for energy before it is actually used.

### How Does Prepaid Metering Work?

A traditional electronic prepaid metering system typically operates at three levels:

- Meters that are installed at the customer's home. These meters dispense energy up to the amount that the customer prepaid.
- Vending stations located at the utility's offices or designated payment agencies. These stations/agencies sell prepaid credits to customers.
- Master stations that group vending stations together for administration, reporting and control purposes. Master stations communicate information - e.g. customer information, tariff changes, etc - to the vending stations. The vending stations, in turn, report detailed customer sales and other transaction information to the master station.

A prepaid customer goes to a vendor and purchases credits for his/her meter to dispense energy. The vendor has knowledge of the customer and the rate that the customer is paying. The vendor issues the credits in any of the following forms: a prepaid card, a token (to be inserted into the meter) or a series of numbers (to be keyed into the meter).

### Debit Meter vs. Credit Meter

Prepaid meters are commonly referred to as debit meters. Billed meter types are also called credit meters. A meter's state of being 'credit' or 'debit' translates to a specific meter configuration. Having this property set at the meter configuration level enables meters to be switched between 'credit' and 'debit' if needed.

Prepaid credits may be purchased for either new premises or existing premises. In the latter case, the existing premise could initially have a typical 'credit' meter. In this case, fieldwork may be involved in getting the meter switched from 'credit' to 'debit' (prepaid).

## Prepaid Metering Transactions Result in Adjustments

There could be numerous types of prepaid transactions. But the most common types are prepaid sales and cancellations.

A sale or cancellation transaction includes a total amount that usually includes tax. In order to post to the general ledger, the prepaid transaction must result in a financial transaction. Moreover, separate GL entries must be created for the breakdown of revenue and tax. In some cases, it may also be necessary to calculate the usage from the revenue amount.

[Calculated Adjustments](#) are used to book revenue from these types of transactions. A base Generate Adjustment algorithm is available to let rate application generate the appropriate GL calculation lines and calculate the corresponding usage, if needed.

Prepaid adjustments do not affect a customer's balance.

## Interfacing Prepaid Transactions

An adjustment upload batch process exists for uploading prepaid transactions that result in adjustments. Refer to [Interfacing Adjustments From External Sources](#) for more information.

Prepaid metering options need only be set up if your organization offers prepaid metering service to your customers. Refer to [Defining Prepaid Metering Options](#) for more information.

## Prepaid Transactions Can Go Into Suspense

A prepaid transaction goes into suspense if a prepaid SA could not be determined for any of the following reasons:

- The badge number on the transaction is not a valid meter in the system
- The badge number on the transaction is a valid meter in the system, but is:
  - Not linked to a prepaid meter configuration type
  - Not linked to a non-closed, non-canceled prepaid SA

This can be a common occurrence because of the likelihood that transactions get uploaded prior to meter installation/exchange or service agreement information being updated in the system.

When this situation happens, you probably still want to recognize the revenue by posting an adjustment to a suspense SA that you designate. Refer to the base sample Get Prepaid SA Using Badge Number (C1-SABYBADGE) algorithm for an example of how the suspense SA is specified.

A batch process exists for automatically resolving suspense adjustments. Refer to [How Are Suspense Adjustments Resolved](#) for more information.

## Setting Up The System To Enable Prepaid Metering

The following sections describe the steps in setting up control information for prepaid metering.

### Meter Types



Prepaid meters are set up just like any other meter - i.e. the meter must reference a meter type and the meter's configuration must reference a meter configuration type.

To set up prepaid meter types you must do the following:

- Define the meter configuration types that will be used for recording prepaid usage. Mark each of these configuration types as Prepaid . Define one register with the appropriate UOM (e.g. kWh ).
- Define the meter types that will be used for prepaid metering. For each meter type, associate one of the Prepaid meter configuration types that you defined. You can also mark each meter type as Prepaid Capable.

---

**NOTE:**

Base logic does not require the meter type to be marked as Prepaid Capable. The Prepaid indicator on the meter configuration type is used to identify prepaid meters.

---

## Characteristic Types

The following characteristic types are needed if you are going to upload prepaid transactions as adjustments and need the system to determine the prepaid SA given a prepaid meter's badge number.

Refer to [Setting Up Characteristic Types](#) for more information.

### Prepaid Entity Characteristic Type

Create a characteristic type that identifies whether an SA Type is used for prepaid metering. For example:

- Characteristic Type = `<code>`
- Description = Prepaid Entity
- Char Entities = SA Type
- Subclass = predefined list
- Values = Y, N

### Badge Number Characteristic Type

Create a characteristic type for specifying a badge number. For example:

- `<code>`
- Description = Badge Number
- Char Entities = Adjustment, Adjustment Type
- Subclass = Adhoc

## Algorithms

The following algorithms need to be set up in order to store prepaid transactions in the system.

Refer to [Setting Up Algorithms](#) for more information.

---

**NOTE:**

The following sections describe basic set up needed for uploading 'sale' and 'cancellation' types of prepaid transactions. Your implementation team may have to define additional specific algorithms types for any other prepaid transaction type that you need to upload into or store in the system.

---

## Calculation Rule - Calculation Algorithm

Create an algorithm of type Determine Percent Given Total (C1-PCTGVNTOT) specifying your parameter values for UOM / TOU / SQI.

Create an algorithm of type Back Into Revenue (C1-BACKINREV) specifying your parameter values for UOM / TOU / SQI.

## Adjustment Type - Generate Adjustment

Create an algorithm of type Adjustment Generation - Apply Rate (ADJG-RT), specifying your [prepaid rate](#) and parameter values for UOM / TOU / SQI.

## Adjustment Type - Determine SA

Create an algorithm of type Get Prepaid SA Using Badge Number (C1-SABYBADGE), specifying your badge number characteristic type, prepaid characteristic type and suspense SA ID (i.e. SA to which the adjustment needs to post when a valid prepaid SA is not found).

## Adjustment Type - Resolve Suspense

Create an algorithm of type Cancel Suspense Adjustment (C1-CANSUSADJ) specifying the following:

- [Badge number characteristic type](#)
- [Prepaid entity characteristic type](#)
- [Prepaid adjustment type](#)
- Adjustment cancel reason

If you want this algorithm to create to do entries for adjustments that have been in suspense for too long, specify additional parameter values for number of days and to do type and to do role (optional).

## Adjustment Type - Adjustment Information

Specify the SUSPENSE\_DESCR parameter on your adjustment information algorithm if you want the information to include an indication of suspense.

## Installation - Adjustment Information

Specify the SUSPENSE\_DESCR parameter on your adjustment information algorithm if you want the information to include an indication of suspense.

## Rate

In order to generate separate calculation lines for the revenue and tax breakdown of the prepaid amount, you need to set up a prepaid rate with components that calculate revenue amount and tax amount given just a total amount.

Create a rate schedule with the following components:

- Tax Calculation Rule
  - Calculation Rule Type = Calculation Algorithm
  - Value Type = Percentage
  - Value Source = Bill Factor
  - Bill Factor = your tax bill factor
  - Calculation Algorithm = the one created for algorithm type C1-PCTGVNTOT. Refer to [Calculation Rule - Calculation Algorithm](#) for information.
  - Distribution Code = *your distribution code for tax liability*
- Revenue Calculation Rule
  - Calculation Rule Type = Calculation Algorithm
  - Derive SQ = checked
  - Value Type = Unit Charge
  - Value Source = Bill Factor
  - Bill Factor = your rate/kWh bill factor
  - UOM/TOD/SQI to use for the resulting calculated usage, for example kWh
  - RC Cross Reference = indicate the sequence for the tax calculation rule (above)
  - Calculation Algorithm = the one created for algorithm type C1-BACKINREV. Refer to [Calculation Rule - Calculation Algorithm](#) for information.
  - Distribution Code = your distribution code for revenue

## Adjustment Types

You must define an adjustment type for each type of transaction that you want to store in the system. Refer to [Setting Up Adjustment Types](#) for more information.

For prepaid sales and cancellation transactions, you need to define [calculated adjustment types](#). In addition, plug-in the following algorithms:

- Adjustment FT Creation - GL Only algorithm - so that transaction amounts do not affect the customer's balance. Specify calc lines as the source for adjustment distribution codes.
- [Generate Adjustment](#)
- [Determine SA](#)
- [Resolve Suspense](#), if applicable.
- [Adjustment Information](#), if applicable

## Adjustment Type Profiles

Create appropriate [adjustment type profiles](#) for your prepaid service agreements.

## Service Agreement Types

You must create a prepaid [SA Type](#) for each unique CIS Division. Each SA Type must be set up as non-billable and requiring a characteristic premise. The SA Types must also indicate that they are used for prepaid by specifying a [prepaid entity characteristic](#) value.

## Bill Cycle

Create at least one bill cycle that will be used for prepaid accounts. This bill cycle should not have a schedule defined.

## Vendor Information

A vendor could be a vending station, payment agency or master station.

You must create a [person](#) for each of your vendors. Information about the vendor may include names, an address, phone numbers, etc.

Any other miscellaneous information about the vendor can be stored as characteristics on the person.

Hierarchical relationships between vendors can be established through characteristics. For instance, a vending station's person record may contain a foreign key characteristic that points to the master station that the vending station reports to.

## Defining Conservation Program Options

Oracle Utilities Customer Care and Billing allows you to define conservation (or energy efficiency) programs and provide rebates to customers.

## The Big Picture of Conservation Programs

The purpose of using conservation programs is to provide rebates to customers based on eligibility and verification of newly purchased appliances and hardware that are rated to conserve the demand for energy. To redeem their rebates, customers have to submit a rebate application to the utility with receipts, and the utility has to administer and report on the programs.

Admin and transaction objects are provided in the product to support the definition of conservation programs (admin data) and the subsequent rebate claims (transaction data). Portals and BPA scripts are used to maintain the conservation programs and rebate claims. Adjustments are used to recognize the expense and to process refunds.

The following sections discuss the maintenance objects that support this functionality.

## Conservation Program Maintenance Object

A conservation program is an admin maintenance object (MO) used to support the definition of a conservation program. It holds rules that control how the claims for a conservation program are managed. If your organization wishes to use this MO, you can either use the business object (BO) supplied in the base product or configure your own BO.

This MO provides the following functionality:

- A business object option Display Statistics Service Script is provided for business objects of this type. The script plugged into this option retrieves information displayed on the **Conservation Program Statistics Zone**.
- A business object option Display Statistics UI Map is provided for business objects of this type. This is the map used on the **Conservation Program Statistics Zone** to display statistics.
- A separate maintenance object is provided to capture rebate definitions for a conservation program
- Logs are not provided.
- The standard characteristics collection is provided.

### Where Used

Follow this link to open the data dictionary where you can view the tables that reference [CI\\_CONSV\\_PROG](#).

---

#### FASTPATH:

For more information, about this MO and to review the business objects defined for this MO, navigate to **Admin > Database > Maintenance Object > Search** and view the MO C1-CPROG.

---

## Conservation Program Rebate Definition Maintenance Object

A conservation program has rebate definitions that define the rebate amounts and energy savings for different types of products. The superset of such lines is the "rebate matrix". Each row in the matrix defines the rebate and presumed energy savings for a product purchased by the consumer. If your organization wishes to use this maintenance object (MO), you can either use the business object (BO) supplied in the base product or configure your own BO.

This MO provides the following functionality:

- The Rebate Definition table can be used to capture information for rebate claim lines such as, appliance type, refund amount, energy savings, and applicable manufacturers and models.
- Logs are not provided for the Rebate Definition.
- A characteristics collection is not provided.

### Where Used

Follow this link to open the data dictionary where you can view the tables that reference [CI\\_REBATE\\_DEFN](#).

---

#### FASTPATH:

For more information, about this MO and to review the business objects defined for this MO, navigate to **Admin > Database > Maintenance Object > Search** and view the MO C1-RDEF.

---

## Rebate Claim Maintenance Object

When a customer files a claim for a rebate, a rebate claim will be created. The rebate claim maintenance object (MO) is used to support the definition of a claim. If your organization wishes to use this MO, you can either use the business object (BO) supplied in the base product or configure your own BO.

This MO provides the following functionality:

- Depending on the utility's requirements, you can specify single or multiple items on the Rebate Claim. A separate maintenance object is provided to capture rebate claim lines for a rebate claim.
- The standard characteristics collection is provided.
- A log is provided. This can be used to track approval information for the claim, to capture adjustments created as the claim is processed, etc.

#### Where Used

Follow this link to open the data dictionary where you can view the tables that reference [CI\\_REBATE\\_CLAIM](#).

---

**FASTPATH:**

For more information, about this MO and to review the business objects defined for this MO, navigate to **Admin > Database > Maintenance Object > Search** and view the MO C1-RCLAIM.

---

## Rebate Claim Line Maintenance Object

A rebate claim has a rebate claim line for each product eligible for a refund. You use the rebate claim line maintenance object (MO) to create a rebate line. If your organization wishes to use this MO, you can either use the business object (BO) supplied in the base product or configure your own BO.

This MO provides the following functionality:

- SA (service): The SA table is the real service SA. There is a separate SA under which the rebate adjustments are stored.
- Logs are not provided for Rebate Claim Line
- The standard characteristics collection is provided.

#### Where Used

Follow this link to open the data dictionary where you can view the tables that reference [CI\\_REBATE\\_LINE](#).

---

**FASTPATH:**

For more information, about this MO and to review the business objects defined for this MO, navigate to **Admin > Database > Maintenance Object > Search** and view the MO C1-REBLN.

---

## GL Accounting Example

The following table shows the financial transactions that are issued when processing energy conservation rebates. This example shows the financial transactions when a customer files a claim for a dishwasher and insulation.

Notice how the expense adjustments are atomized:

- Separate adjustments are created to expense each item individually.
- A single adjustment is created for the A/P check request.

---

Event	GL Accounting
Rebate adjustment is created - dishwasher	Rebate Expense 35

---

	A/P <35>
Rebate adjustment is created - insulation	Rebate Expense 45.45
	A/P <45.45>
A/P check request issued	A/P 80.45
	Cash <80.45>

## Setting Up Conservation Programs

Conservation Programs allow administrators to create and maintain conservation programs for which customer can submit rebate claims. To set up a conservation program, open **Admin > Customer > Conservation Program > Add**.

### FASTPATH:

For additional information on working with rebate claims, see [Rebate Claims](#).

The topics in this section describe the base-package zones that appear on the Conservation Program portal.

## Conservation Program List Zone

The Conservation Program [List zone](#) lists every conservation program. The following functions are available:

- Click a [broadcast](#) button to open other zones that contain more information about the adjacent conservation program.
- Click the Add link in the zone's title bar to add a new conservation program.

This zone displays the following for each conservation program defined in the system:

- Conservation Program Information (Description, Status, Start Date, End Date)
- The number of Complete Claims
- The total Complete Claims Amount
- The number of Incomplete Claims
- The Statistics Date/Time is the date that the statistics were last calculated

Use the following procedure to create a new conservation program:

- Select **Admin > Customer > Conservation Program > Add** or click **Add** on the title bar of the Conservation Program [List zone](#).
- Enter basic information about the conservation program in the **Main** section, including:
  - Conservation Program code
  - Description
  - Start Date/End Date
  - Statistic Update Frequency (in hours)
- Enter **Financial Information** about the conservation program, including:
  - CIS Division
  - SA Type
  - A/P Adjustment Type

- A/P Taxable Adjustment Type
- Enter **Approval Information** about the conservation program, including:
  - Approval To Do Type
  - Duplicate Claim To Do Role
  - Approval Levels and Threshold Amounts
- Click **Save**. To return to the Conservation Program portal without saving the new program, click **Cancel**.

To view a specific conservation program, click the broadcast icon for the conservation program you wish to view. The remaining zones in the Conservation Program portal open displaying details about the selected conservation program.

## Conservation Program Zone

You use the Conservation Program zone to view and maintain individual conservation program. The Conservation Program zone displays the following information about the selected conservation program:

- Basic information about the conservation program, including
  - Conservation Program
  - Description
  - Start Date/End Date
  - Statistic Update Frequency (in hours)
  - Status
- Financial Information about the conservation program, including
  - CIS Division
  - SA Type
  - A/P Adjustment Type
  - A/P Taxable Adjustment Type
- Approval Information about the conservation program, including
  - Approval To Do Type
  - Duplicate Claim To Do Role
  - Approval Levels and Threshold Amounts

Please see the zone's help text for information about this zone's fields.

## Conservation Program Status

The Status of a conservation program indicates the current state of the program within the system. Valid statuses include:

- **Pending** indicates the program is pending. This is the initial state of a conservation program when first created.
- **Active** indicates the conservation program is currently active.
- **Inactive** indicates the conservation program is currently inactive.



## Conservation Program Actions

You can perform a number of actions on a conservation program, including:

- **Edit:** Used to edit a conservation program
- **Delete:** Used to delete a conservation program
- **Activate:** Used to activate a pending or inactive conservation program
- **Refresh Statistics:** Used to refresh the statistics of an active conservation program
- **Deactivate:** Used to deactivate a pending or active conservation program
- **Pend:** Used to change the status of an active or inactive conservation program to Pending

The actions available are based on the current status of the conservation program. The table below summarizes the actions available at each status.

Status	Valid Action
Pending	Edit, Delete, Activate, Deactivate
Active	Edit, Refresh Statistics, Deactivate, Pend
Inactive	Activate, Pend

## Editing Conservation Programs

Use the following procedure to edit an active or pending conservation program:

- Click **Edit**.
- Edit the details of the conservation program as needed.
- Click **Save**.

## Deleting Conservation Programs

Use the following procedure to delete a conservation program:

- Click **Pend** to change the status of the conservation program to Pending (if needed).
- Click **Delete**.
- Click **OK** on the Confirm Delete dialog. To close the dialog without deleting the conservation program, click **Cancel**.

## Activating Conservation Programs

To activate an inactive or pending conservation program, click **Activate**.

## Deactivating Conservation Programs

To deactivate an active or pending conservation program, click **Deactivate**.

## Setting the Status of Conservation Programs to Pending

To set the status of an active or inactive conservation program to Pending, click **Pend**.

## Rebate Definition Zone

You use the Rebate Definition zone to add, view, and edit rebate definitions associated with a conservation program. A rebate definition defines the types of rebates allowed for a specific conservation program. The Rebate Definition zone displays the following details for each claim line:

- Rebate Definition
- Status (Active or Inactive)
- Rebate Amount per Unit
- Icons to Edit, Delete, and Activate/Deactivate rebate definitions

## Adding Rebate Definitions

Use the following procedure to add a rebate definition:

- Click **Add** in the title bar of the Rebate Definition zone.
- Enter a Description of the rebate definition.
- Select the **Product** for the rebate definition from the dropdown list.
- Select the **Service Type** for the rebate definition from the dropdown list.
- Enter the **Rebate Per Unit Amount** for the rebate definition.
- Enter the **Rebate Unit of Measure** for the rebate definition.
- Select the **Expense Adjustment Type** for the rebate definition from the dropdown list.
- Enter the **Presumed Energy Savings** for the rebate definition.
- Select the **Presumed Energy Savings Unit of Measure** for the rebate definition from the dropdown list.
- Enter the **Manufacturer** and **Model** for each item eligible to be submitted as a rebate claim line.
- To upload manufacturer/model information from a comma-separated-values file, click **CSV File to Upload**.
  - Click **Browse** on the File Upload dialog, and browse to the file to be uploaded.
  - Click **Upload**.
- Click **Save**. To return to the Rebate Definition zone without adding the rebate definition, click **Cancel**.

## Editing Rebate Definitions

Use the following procedure to edit a rebate definition:

- Click the edit icon for the rebate definition you wish to delete.
- Edit the details of the claim line as appropriate.

- Click **Save**. To return to the Rebate Definition zone without changing the rebate definition, click **Cancel**.
- 

**NOTE:**

You can edit a rebate definition only when it is Active.

---

## Deleting Rebate Definitions

Use the following procedure to delete a rebate definition:

- Click the delete icon for the rebate definition you wish to delete.
- Click **OK** on the Confirm Delete dialog. To close the dialog without deleting the rebate definition, click **Cancel**.

## Activating Rebate Definitions

To activate an inactive rebate definition, click the **Activate** button for the rebate definition you wish to activate.

---

**NOTE:**

You can only activate rebate definition that is currently Inactive.

---

## Deactivating Rebate Definitions

To deactivate an active rebate definition, click the **Deactivate** button for the rebate definition you wish to deactivate.

---

**NOTE:**

You can only deactivate rebate definition that is currently Active.

---

## Rebate Claim Statistics Zone

You use the Rebate Claim Statistic zone to view statistics for submitted rebate claims based on the current conservation program. This zone displays the following:

- Conservation Program
- Statistics Date/Time
- Statistics Charts

## Statistics Graphs

This zone displays statistics for submitted rebate claims using the following charts:

- **Statistics by Status:** A pie chart that displays the number and percentage of claims for each status.
- **Statistics by Month:** A line chart that displays the number of claims completed each month.
- **Statistics by Product:** A pie chart that displays the total value, percentage, and number of claim lines completed for each product.

- **Statistics by Claim Age:** A line and bar chart that displays the number of new claims per month (line graph) and the number of claims per age grouping (bar graph).

To refresh statistics, click **Refresh Statistics** on the title bar of the Rebate Claim Statistics zone.

## Defining Market Options

### Markets

#### Understanding Markets

Markets define the jurisdictions or regulatory environments in which a service point participates.

Markets also define market relationships for valid service providers and their roles within a market (distributor, etc.).

While each service point specifies only one market, a utility may serve more than one market, and different service points throughout the utility's service territory can be linked to different markets.

For each service provider defined for a market, you can also specify a fallback service provider.

#### Service Providers in Deregulated Markets

Some utilities operate in deregulated markets. In implementations in deregulated markets, the system can send information to and receive information from a variety of market entities. These entities are defined as service providers.

For example, a service point's distribution company and/or energy supply company may subscribe to its consumption, or a service point's meter service provider may send requests to ping the meter that's installed at the service point to verify connectivity between the meter and its head-end system.

##### *Different Relationship Types in Different Markets*

Each market can define different relationship types between its service providers. A single instance of Oracle Utilities Meter Data Management or Oracle Utilities Smart Grid Gateway may have service points in different markets where each market has different relationship types and service providers. For example:

- In a regulated market the distribution company is the de facto energy supplier and meter service provider.
- Another market might have two relationship types and a single service provider for each relationship:
  1. There is a single energy supply company for the entire market
  2. There is a single meter service provider for the entire market

Yet a another market might have two relationship types (energy supply and meter service). In this market, there might be multiple service providers for each relationship type. Each service point can choose any of the relationship type's service providers. If a service point does not declare a specific service provider for a given relationship type, the relationship type's "fallback" service provider is assumed.

### Configuring Markets

This portal is used to display and maintain a Market.

Refer to [Understanding Markets](#) for more information.

You can access the portal from the **Admin > Open Market > Market > Search**.

The following zones may appear as part of the portal's **Main** tab page:

- **Market List:** This zone lists all Market records. Broadcast a record to display the details of the selected record.
- **Market:** This zone provides information about the selected Market.

## Where Used

Follow this link to open the data dictionary where you can view the tables that reference [D1\\_MKT](#).

# Market Participants

## Understanding Market Participants

Market Participants are participants in a deregulated environment. Relationships between market participants are defined in a particular market record. Refer to [Understanding Markets](#) for more information.

Each market participant can be associated to an [external system](#) which is used to define the messages that can be sent to that market participant and how each message is sent.

## Configuring Market Participants

This portal is used to display and maintain market participants.

Refer to [Understanding Market Participants](#) for more information.

You can access the portal from the **Admin > Open Market > Market Participant > Search**.

The following zones may appear as part of the portal's **Main** tab page:

- **Market Participants List:** This zone lists all market participant records. Broadcast a record to display the details of the selected record.
- **Market Participant:** This zone provides information about the selected market participant.
- **Market Participant Characteristics:** This zone lists characteristics defined for the market participant.
- **Market Contracts:** This zone lists market contracts where the market participant is either the Buyer or Seller.
- **Processing Method List:** This zone provides the list of processing methods defined for the market participant.
- **Translation Method List:** This zone provides the list of translation methods defined for the market participant.
- **Inbound BOs Send By Service Provider:** This zone lists inbound business objects that are sent by this market participant. The identification is driven by the business object having a Business Object Option of type "Sent By Service Provider" that references the current market participant.

## Where Used

Follow this link to open the data dictionary where you can view the tables that reference [D1\\_SPR](#).

# Configuration

This section contains additional configuration topics for Customer to Meter .

## Configuring Zones

Many zones in Oracle Utilities Customer Care and Billing do not require configuration by your implementation team. For example, the base package is shipped with the Account Financial History zone that appears on the Control Central - Account Information portal. This zone does not require configuration because its zone type has no configurable options (i.e., its behavior is static).

Other zones require configuration before they can be used because their behavior is dynamic. The topics in this section provide tips and techniques on how to configure zones in Oracle Utilities Customer Care and Billing.

---

**FASTPATH:**

Refer to [The Big Picture of Portals and Zones](#) in the *Oracle Utilities Application Framework Administration Guide* for a description of portal and zone functionality.

---

## Configuring Timeline Zones

A timeline zone is a zone that may be configured on the account or customer information tabs of Control Central. This type of zone contains one or more "lines" where each line shows when significant events have occurred. For example, you can set up a timeline zone that has two lines: one that shows when payments have been received from a customer, and another that shows when bills have been sent to the customer.

---

**FASTPATH:** For a complete description of the numerous features available on a timeline zone, refer to [Timeline Zone](#).

Configuration is required to enable a timeline zone. A timeline zone is made up of one or more algorithms where each algorithm returns "events" for a certain type of record (payment or bill for example). The product delivers several algorithm types for the timeline zone to include "events" for many different transactions in the product. Each algorithm type uses the Account or Person in context to retrieve the related information.

- Refer to [Configuring Timeline Zones](#) in the framework portion of the administration guide for information about the type of detail each event may return. The base provided algorithm types include many parameters to allow the implementation to configure much of this information as desired.
- Click [here](#) to see the algorithm types available for this plug-in spot.

Many of the algorithms support supplying a [BPA script](#) to launch when a user clicks on an event on a timeline. Be sure to review each algorithm type to see what types of events support a BPA script. For each event, determine if your business practice warrants the development of a BPA script.

After configuring the algorithms per your business needs, the following additional steps are needed:

- Set up a [zone](#) that references these algorithms. The zone will reference the **F1-TIMELINE** zone type.
- Link the zone to the appropriate portal(s) (e.g., [Control Central - Account Information](#) or [Control Central - Customer Information](#)).
- Update your users' [portal preferences](#) and [security rights](#) so they can see the zone in the desired location on the portal(s).

You can set up many timeline zones. For example,

- You might want different zones to appear on a portal depending on the type of user. For example, you might want one timeline for billing clerks, and a different one for customer service representatives.
- For aesthetic reasons, you might want multiple simple timeline zones to appear on a given portal rather than one complex timeline zone.
- You might want to set up context specific timeline zones. For example, you might want to have one timeline zone that is premise-oriented and another that is person-oriented.

## Configuration Migration Assistant (CMA) Addendum

This section is an addendum to the general [Configuration Migration Assistant](#) section in the *Oracle Utilities Application Framework Administration Guide*. This section assumes that you are familiar with the concepts of Configuration Migration Assistant (CMA).

---

**NOTE:** CMA is designed to migrate configuration data only. Since base product data should be updated only through product patching mechanisms, CMA cannot currently be used to migrate master/transactional data that contains system-generated primary keys, such as customer account or billing information.

---

This addendum describes Configuration Migration Assistant (CMA) functionality that is specific to Oracle Utilities Customer Care and Billing.

The following sections provide information about what is provided in the C1-owned base package:

### Base Package Migration Plans

The C1-owned base package provides a large number of migration plans to support migrating configuration and/or administration data from one environment to another.

Use the following procedure to access the base package migration plans:

1. Navigate to **Admin > Implementation Tools > Migration Plan > Search**.
2. Enter "C1" in the **Migration Plan** field.
3. **Click Refresh**.
4. Select a migration plan in the search results list. The details of the selected migration plan are displayed in the Migration Plan portal.

---

**NOTE:** The C1-owned base package plans can also be used as a basis for custom migration plans. To create a custom migration plan, select a plan to base the custom migration plan on, click the Duplicate button, and define the custom plan to meet the implementation's requirements as described in [Defining a Migration Plan](#) in the *Oracle Utilities Application Framework Administration Guide*.

---

### Base Package Migration Request

The C1-owned base package provides two migration request to support migrating configuration and/or administration data from one environment to another.

Use the following procedure to access the base package migration requests:

1. Navigate to **Admin > Implementation Tools > Migration Request > Search**
2. Enter "C1" in the **Migration Request** field.
3. **Click Refresh**.
4. **Click the Copy and Sync Control Data** link in the search results list.

The details of the migration requests are outlined below. Please use the Migration Request portal to view additional details about this migration request.

#### Base Admin Data Migration Request

- **Migration Request:** C1-AdminBasic

- **Description:** Base Admin Data
- **Detailed Description:** Base Admin Data.
- **Migration Plans:** This migration request includes base package migration plans used by Oracle Utilities Customer Care and Billing.

#### Copy and Sync Control Data Migration Request

- **Migration Request:** C1-CopyControlTables
- **Description:** Copy and Sync Control Data
- **Detailed Description:** Copy and Sync Control Data.
- **Migration Plans:** This migration request includes base package migration plans used by Oracle Utilities Customer Care and Billing.

For additional information about these migration plans, see [Base Package Migration Plans](#).

---

**NOTE:** The C1-owned base package request can also be used as a basis for custom migration requests. To create a custom migration request, select the base package request, click the Duplicate button, and define the request as to meet the implementation's requirements as described in [Defining a Migration Request](#) in the *Oracle Utilities Application Framework Administration Guide*.

---

## Wholesale and Piecemeal Migrations

There are two general types of migrations used with the Configuration Migration Assistant: wholesale migrations and piecemeal migrations.

### Wholesale Migrations

Wholesale migrations are used when migrating all the configuration and/or administration data from one environment to another. For example, a wholesale migration might be used when migrating admin data from a development or test environment to a production environment. For more on this type of migration, see [Wholesale Migrations](#) in the *Oracle Utilities Application Framework Administration Guide*.

The following is a high-level overview of the steps involved when executing a wholesale migration.

1. Process the "F1-SchemaAdmin" (FW Foundation) migration request (This request contains migration plans for Field, Lookup, Char Type, Currency Code and FK Ref).
2. Process the "C1-AdminBasic" migration request. This includes copies of framework migration plans (including plans for Business Objects, Algorithms, and Feature Configurations) from the "F1-FrameworkAdmin" migration request, as well as independent base package C1-owned wholesale migration plans which can be run first.
3. Process any of the other delivered framework-based (F1-owned) migration requests as needed (except for the "F1-FrameworkAdmin" migration request which is already incorporated in #2)
4. Process the "C1-CopyControlTables" migration request. This includes base package C1-owned wholesale migration plans with dependency on "C1-AdminBasic" migration request.

### Piecemeal Migrations

Piecemeal (or "non-wholesale") migrations are used when migrating a small portion (or piece) of configuration and/or administration data from one environment to another. For example, a piecemeal migration might be used when migrating groups and rules from a development or test environment to a production environment. For more on this type of migration, see [Piecemeal Migrations](#) in the *Oracle Utilities Application Framework Administration Guide*.

The C1-owned base package does not contain piecemeal migration plans for Oracle Utilities Customer Care and Billing.



## Processing Notes for Specific Objects

The following limitations apply to certain Oracle Utilities Customer Care and Billing objects when using Configuration Migration Assistant:

- An Issuing Center object references a User. If this user does not exist in the target system, Configuration Migration Assistant cannot apply the requested changes.
- A Case Type object references an Application Service. If this service does not exist in the target system, Configuration Migration Assistant cannot apply the requested changes.
- Collection Agency and Service Provider objects reference a Person. If this person does not exist in the target system, Configuration Migration Assistant cannot apply the requested changes.
- Service Provider and Tender Source objects reference a Service Agreement. If this service agreement does not exist in the target system, Configuration Migration Assistant cannot apply the requested changes.
- If your migrateable object includes log tables, you may add your log entity to the characteristic type F1-MGO. You should also mark the log table as a “Non-Migrateable Table” in the Maintenance Object options.
- Transactions are applied in an unspecified order (and probably in order numerically by a randomly generated ID value). CMA only looks at "hard" constraints when determining what to put into the same transaction. Any "soft" constraints such as characteristics and algorithm parameters that might have FK references to other objects are not processed by CMA. Unless the migration plan ensures that related items go into the same transaction, they will end up in different ones, and must need to apply again and again until eventually all gets applied.

## To Do Lists Addendum

This section is an addendum to the general [To Do Lists](#) chapter. This addendum describes the To Do functionality that is specific to Oracle Utilities Customer Care and Billing.

### Assigning A To Do Role

As described in [To Do Entries Reference A Role](#), each To Do entry requires a role. To Do entries created in Oracle Utilities Customer Care and Billing may attempt to assign a role based on an account management group or division if it is applicable to the type of data related to the To Do entry.

As described in [The Big Picture of To Do Lists](#), users are informed that something requires their attention by entries that appear in a To Do List. For example, consider what happens when billing can't find a reading (and it's not allowed to estimate):

- The billing process creates a bill segment that is in error (meter read cannot be found).
- This bill segment that's in error, in turn, triggers the creation of a To Do entry.
- The To Do entry is assigned a role. A role is one or more users who can look at / work on the entry.
- When users view a To Do List, they only see entries addressed to roles to which they belong.

You can optionally use account management groups (AMG) to define the respective role to be assigned to To Do entries that are associated with an account and To Do type. For example, you can create an AMG called Credit Risks and assign this to accounts with suspect credit. Then, whenever an account-oriented To Do entry is created for such an account, it will be assigned a role based on the Credit Risks AMG. Refer to [Setting Up Account Management Groups](#) for more information.

By assigning an AMG to an account, you are telling the system to address this account's To Do list entries to the roles defined on the AMG (note, each To Do type can have a different role defined for it on an AMG).

You can optionally use division to define the respective role to be assigned to To Do entries that are associated with an account and To Do type. For example, you may have a division called California Operations and assign this to accounts located in California. Then, whenever an account-oriented To Do entry is created for such an account, it will be assigned a role based on the California Operations division. Refer to [CIS Division Portal](#) for more information.

A To Do Pre-Creation installation options plug-in is provided to determine the appropriate To Do Role for an account based on AMG and division setup. If plugged in, the logic to determine To Do role for an account is performed whenever a To Do entry is created. Refer to [C1-TDCR-DFRL](#) for further details on how this plug-in works.

---

**FASTPATH:**

Refer to [To Do Entries Reference A Role](#) for the details of how an initial role is assigned to To Do entries.

---

## System To Do Types

---

**NOTE:**

**List of available To Do types.** The To Do types available with the product may be viewed in the [application viewer](#)'s [To Do type](#) viewer. In addition if your implementation adds To Do types, you may [regenerate](#) the application viewer to see your additions reflected there.

---

## Background Processes Addendum

This chapter is an addendum to the general [Defining Background Processes](#) chapter. This addendum describes the background processes that are provided with Oracle Utilities Customer to Meter.

---

**NOTE: List of system background processes.** The list of background processes provided in the base product may be viewed in the [application viewer](#)'s [batch control](#) viewer. In addition if your implementation adds batch control records, you may [regenerate](#) the application viewer to see your additions reflected there.

---

## How To Set Up A New Extract Processes

Several background processes delivered with the system are used to interface information out of the system. The topics in this section describe when and how to introduce an additional extract process.

### Setting Up Meter Read Extracts

You will need a meter read extract for every mechanism your company uses to route meter read requests to the software that handles your meter reading requests. For example:

- You will need a meter read extract to interface records to your handheld device software. The MDL process delivered with the system is intended to be used to handle this function. This process will have to be populated to format the output records in keeping with the needs of your meter reading software.
- If you interface some meter read requests to automatic meter reading software, you will need a new meter read extract process.

If you need additional meter read extract processes, set up the following information:

- Add a new [batch control](#) record. Populate the fields as follows:

- **ID.** Assign an easily recognizable unique ID for the meter read extract process.
- **Description.** Enter a description of the meter read extract process.
- **Accumulate All Instances.** Turn this switch on.
- Use [Route Type](#) to define the meter read extract process to be used for each route type.
- It may be necessary to register the process with your scheduler software.

## Setting Up Automatic Payment Extracts

You will need an automatic payment extract for every mechanism your company uses to route automatic payment requests to a financial institution / clearing house. For example:

- You will need an automatic payment extract to interface records to the Automated Clearing House (ACH) if you allow customer to pay via credit card or direct debit from a checking account. The **APAYACH** and C1-APACH processes delivered with the system are intended to be used to handle this function.

If you need additional automatic payment extract processes, set up the following information:

- Add a new [batch control](#) record. Populate the fields as follows:
- **Batch Process.** Assign an easily recognizable unique ID for the automatic payment extract process.
- **Description.** Enter a description of the automatic payment extract process.
- **Accumulate All Instances.** Turn this switch on.
- Use [Auto Pay Route Type](#) to define the auto pay extract process to be used for each route type.

## Choosing Which Records Are Selected

The system is delivered with some background processes that utilize the **Select Records** plug-in spot to select the records to be processed. It is important to note that these background processes do not utilize the Process Records plug-in spot. This logic is hardcoded as these background processes are some of the core system functions such as billing and collections. This functionality provides flexibility in choosing which records are processed, but not how they are processed.

The background processes delivered with the system optionally selects records based on CIS Division. One example is the batch control (**BILLING**) and algorithm (**C1-BILL-SR**). The background process and select records algorithm work as a pair. The batch control defines the parameter to be used by the select records algorithm. The algorithm defines the thread strategy, key fields, and makes the batch control parameter available to be used in the SQL algorithm parameter. Click [here](#) to see the algorithm types available for the Select Records system event.

## Customizing Which Records Are Selected

There are two ways to customize what is provided with the system.

If your organization processes records using the same criteria as the samples delivered in the system, in this case CIS Division, simply create a custom batch control for each CIS Division and specify the corresponding parameter value.

If your organization processes records using different criteria, the following points summarize the steps needed to implement a new background process using plug-ins for the specific functionality:

- Duplicate an existing batch control
- Remove the batch parameter not relevant to your organization and replace with the relevant batch parameter. Note: only the batch parameters associated with selecting records should be removed or updated. Parameters used to process records must remain.
- Duplicate the plug-in script associated with the select records algorithm type. Modify the script to pass the new batch parameter(s) to bind variables and remove those that are no longer batch parameters.

- Duplicate the select records algorithm type and associate with the new script.
- Create an algorithm for the new algorithm type. The SQL parameter value should be copied from the original algorithm type's algorithm parameter value and modified to make use of the newly added bind variables. (**Note:** Do not change the fields selected or their order.)
- Update the batch control to use the new select records algorithm.

## The Big Picture of Sample & Submit

Sample and Submit refers to the ability to create Activity Requests. This is functionality that enables an implementer to design an ad-hoc batch process using the configuration tools.

Some examples of such processes are:

- Send a letter to customers that use credit cards for auto pay and the credit card expiration date is within 30 days of the current date.
- Stop auto pay for customers that use credit cards as the form of payment if the credit card has already expired. Notify the customer that their auto pay agreement has been terminated and that they need to call to reinstate.
- Select auto pay accounts that have more than X non-sufficient fund penalties, stop the auto pay agreement and notify the customer.

---

**NOTE:**

The terms *activity request* and *sample & submit request* may be used interchangeably.

---

## Activity Request Type Defines Parameters

For each type of process that your implementation wants to implement, you must configure an activity request type to capture the appropriate parameters needed by the activity request.

## Preview A Sample Prior To Submitting

To submit a new activity request, a user must select the appropriate activity request type and enter the desired parameter values, as applicable.

After entering the parameters, the following actions are possible

- Click **Preview** to see a sample of records that satisfy the selection criteria for this request. This information is displayed in a separate map. In addition, the map displays the total number of records that will be processed when the request is submitted. From this map you can **Save** to submit the request, go **Back** to adjust the parameters or **Cancel** the request.
- Click **Cancel** to cancel the request.
- Click **Save** to skip the preview step and submit the request.

When an activity request is saved, the job is not immediately submitted for real time processing. The record is save in the status Pending and a monitor process for this record's business object is responsible to transition the record to Complete.

As long as the record is still Pending, it may be edited to adjust the parameters. The preview logic described above may be repeated when editing a record.

The actual work of the activity request, such as generating customer contact records to send letters to a set of customers, is performed when transitioning to Complete (using an enter processing algorithm for the business object).

## Credit Card Expiration Notice

The base product supplies a sample process to find customers that use credit cards for auto pay and their credit card expiration date is within *X* days of the current date.

To this functionality the following configuration tasks are needed:

- Define an appropriate [customer contact class](#) and [type](#) to use.
- Define appropriate activity request Cancellation Reasons. Cancellation reasons are defined using a customizable [lookup](#). The lookup field name is C1\_AM\_CANCEL\_RSN\_FLG.
- Define an activity request type for the business object C1-NotifyExpiringCreditCardTyp . You may define default parameter values for the number of days for expiration and customer contact class and type.

## Exploring Activity Request Data Relationships

Use the following links to open the application viewer where you can explore the physical tables and data relationships behind the activity request functionality:

- Click [C1-ACM-ACTTY](#) to view the activity request type maintenance object's tables.
- Click [C1-ACM-ACTRQ](#) to view the activity request maintenance object's tables.

## Defining a New Activity Request

To design a new ad-hoc batch job that users can submit via Sample and Submit, first create a new Activity Request Type business object. The base product BO for the activity type C1-NotifyExpiringCreditCardTyp may be used as a sample.

The business object for the activity request includes the functionality for selecting the records to process, displaying a preview map for the user to review and to perform the actual processing. The base product BO for the activity request C1-NotifyExpiringCreditCardReq may be used as a sample. The following points highlight the important configuration for this business object:

- Special BO options are available for the activity request BOs to support the [Preview Sample](#) functionality.
  - Activity Request Preview Service Script. This script is responsible for retrieving the information displayed when a user asks for a preview of a sample of records.
  - Activity Request Preview Map. This is the map that is invoked to display the preview sample results.
- The enter algorithm plugged into the Complete state is responsible for selecting all the records that satisfy the criteria and processing the records accordingly.

## Setting Up Activity Request Types

Activity Request Types define the parameters to capture when submitting an activity request through Sample and Submit. To set up an activity request type, open **Admin > Customer > Activity Request Type > Add**.

The topics in this section describe the base-package zones that appear on the Activity Request Type portal.

## Activity Request Type List

The Activity Request Type [List zone](#) lists every activity type. The following functions are available:

- Click a [broadcast](#) button to open other zones that contain more information about the adjacent activity type.
- Click the Add link in the zone's title bar to add a new activity type.

## Activity Request Type

The Activity Request Type zone contains display-only information about an activity request type. This zone appears when an activity request type has been broadcast from the Activity Request Type List zone or if this portal is opened via a drill down from another page. The following functions are available:

- Click the **Edit** button to start a business process that updates the activity request type.
- Click the **Delete** button to start a business process that deletes the activity request type.
- Click the **Duplicate** button to start a business process that duplicates the activity request type.
- State transition buttons are available to transition the activity request type to an appropriate next state.

Please see the zone's help text for information about this zone's fields.

## Maintaining Sample & Submit Requests

Use the Sample and Submit transaction to view and maintain pending or historic activity requests. Navigate using **Menu > Tools > Sample & Submit Request > Search**.

## Sample & Submit Request Query

Use the [query portal](#) to search for an existing sample & submit request. Once a request is selected, you are brought to the maintenance portal to view and maintain the selected record.

## Sample & Submit Request Portal

This portal appears when a sample & submit request has been selected from the Sample & Submit Request Query portal. The topics in this section describe the base-package zones that appear on this portal.

## Sample & Submit

The Sample & Submit zone contains display-only information about an activity (sample & submit) request. The following functions are available:

- Click the **Edit** button to modify the parameters. Refer to [Preview A Sample Prior to Submitting](#) for more information.
- If the activity request is in a state that has valid next states, buttons to transition to each appropriate next state are displayed.

Please see the zone's help text for information about this zone's fields.

## Sample & Submit Log

This is a standard [log zone](#).

## Security Addendum

This chapter is an addendum to the general [Defining Security and User Options](#) chapter. This addendum describes security functionality that is specific to Oracle Utilities Customer Care and Billing.

## Implementing Account Security

---

**CAUTION:**

This section assumes you understand [The Big Picture of Row Security](#).

---

When you create an account, you must define which users can access the account's information. For example,

- If you have customers in two geographic territories, you may need to restrict access to accounts based on the office that manages each territory. For example, only users in the northern office may manage accounts in the northern territory.
- If you have industrial and residential customers, you may need to restrict access to these different customer segments based on the skill set of the users. For example, some users are skilled in dealing with industrial customers, while others are skilled in dealing with residential customers.

By granting a user access rights to an account, you are actually granting the user access rights to the account's bills, payment, adjustments, orders, etc.

---

**FASTPATH:**

Refer to [If You Do Not Practice Account Security](#) for setup instructions if your organization doesn't practice account security.

---

---

**NOTE:**

**Account security may also affect persons and premises.** Refer to [Persons Can Also Be Secured](#) for how access to person information is also restricted by account security. Refer to [Premises Can Also Be Secured](#) for how access to premise information is also restricted by account security.

---

The topics in this section describe how to implement account security.

## Persons Can Also Be Secured

It's important to be aware that persons can also be secured as a result of "account security". It works like this:

- If a person is linked to at least one account, users will not be allowed access to the person (or the person's related information) unless they have access to at least one of the person's accounts.
- If a person is not linked to any accounts (a rare situation), any user may access the person.

---

**NOTE:**

**How are persons linked to accounts?** A person is linked to an account when an account is created using the methods described under [How To Add A New Customer From Control Central](#) and [Order User Interface Flow](#). In addition, you may manually link and unlink persons from account using the [Account - Person](#) page.

---

## Premises Can Also Be Secured

It's important to be aware that premises can also be secured as a result of "account security". It works like this:

- If a premise is linked to at least one account, users will not be allowed access to the premise (or the premise's related information) unless they have access to at least one of the premise's accounts.
  - If a premise is not linked to an account (a rare situation), then all users may access the premise.
- 

**NOTE:**

**How are premises linked to accounts?** A premise is indirectly linked to an account. For the purpose of access restriction, we deem a premise as being linked to an account if at least one of its service points is linked to at least one of the account's service agreements.

---

## Data Becomes Invisible When Access Is Restricted

The following summarizes the impact of a user not having access to an account:

- [Account Security and Control Central](#)
- [Account Security and Searches \(and Maintenance Pages\)](#)
- [Account Security and To Do Lists](#)

## Account Security and Control Central

This section summarizes the impact of account security on [Control Central](#):

- Searches are affected as follows:
- An account will only be visible if a user has access to the account's access group.
- Persons that are not linked to accounts will be visible to all users.
- If a person is linked to an account, the person will only be visible if the user has access to at least one of the person's accounts.
- Premises that are not linked to accounts will be visible to all users.
- If a premise is linked to an account, the premise will only be visible if the user has access to at least one of the premise's accounts.
- The alerts that highlight the existence of "multiple relationships" are not impacted by account security. Specifically:
- The alert Person has multiple accounts will appear if the selected person is linked to multiple accounts, even if the user doesn't have access to every account. Note well, the person couldn't have been selected if the user didn't have access rights to at least one account.
- The alert Premise has multiple accounts will appear if the selected premise is linked to multiple account, even if the user doesn't have access to every account. Note well, the premise couldn't have been selected if the user didn't have access rights to at least one account.



- Only accounts to which the user has access will be displayed in the person tree.
- Only accounts to which the user has access will be displayed in the account tree.
- All other pages contain information related to Control Central's current account context. The current account context can never reference an inaccessible account and therefore these pages are not impacted by account security.

---

**NOTE:** If your implementation wishes to allow users to search for all accounts through Control Central without validating the user's access rights, this can be configured by setting up the **Search All Account** option type on the Customer Information Options [Feature Configuration](#) . If the user tries to select an account without having the required access, they will not be able to navigate to the Account Information tab on Control Central for the selected account.

---

## Account Security and Searches (and Maintenance Pages)

Searches are the gateway to the information that appears on maintenance pages. In general, account-related information is suppressed when a user doesn't have access rights to the account. This suppression is true for rows that directly reference an account AND for rows that indirectly reference an account. For example:

- A user can only see bills associated with accounts to which they have access rights.
- A user can only see financial transactions associated with service agreements that are, in turn, associated with accounts to which they have access rights.

---

**NOTE:**

**Person and premise searches are also impacted.** Keep in mind that information will be suppressed from both person and premise-oriented searches if the person / premise is related to accounts. Refer to [Persons Can Also Be Secured](#) for how access to person information is also restricted by account security. Refer to [Premises Can Also Be Secured](#) for how access to premise information is also restricted by account security.

---

## Account Security and To Do Lists

Account security does NOT impact the information that appears in a user's To Do list. Rather, we have assumed that your To Do roles (and the users assigned to these roles) are consistent with your account security requirements. This can result in anomalies. For example, it's possible for a supervisor to assign a bill segment error to a user who doesn't have access to the bill segment's account. This user will then see the related To Do entry in their Bill Segments In Error To Do list. However, when they drill down on the entry, account security will manifest itself (i.e., the user won't be able to display the bill segment that's in error). This happens because the drill down causes the bill segment search logic to execute. This logic inhibits the selection of bill segments if the user can't access the related account.

To minimize these anomalies, we recommend the following:

- Setup [To Do Roles](#) consistent with your Data Access Roles.
- Setup [Account Management Groups](#) that are consistent with your Access Groups.
- Setup default To Do Roles on your Account Management Groups for each [To Do type](#).

## Restricted Transactions

The following table lists all transactions that have some type of account security. The following notation is used to describe the type of account security:

- **Account-oriented.** This notation is used if the respective transaction uses basic account security (i.e., the user must belong to at least one data access role that has access to the account's access group in order to see the information).

- **Person-oriented.** This notation is used if the respective transaction uses person-oriented account security. Refer to [Persons Can Also Be Secured](#) for more information.
- **Premise-oriented.** This notation is used if the respective transaction uses premise-oriented account security. Refer to [Premises Can Also Be Secured](#) for more information.
- None of the above. Some unusual transactions have unusual implementations of account security. These are described below.

Transaction	Type of Account Security
Account	Account-oriented
Account Bill / Payment History	Account-oriented
Account Financial History	Account-oriented
Account Interval Info	Account-oriented
Account Payment History	Account-oriented
Account Person Replicator	Account-oriented
Account SAs for Debt Class	Account-oriented
Adjustment	Account-oriented
Adjustment Calculation Line Characteristics	Account-oriented
Appointment	Premise-oriented
Bill	Account-oriented
Bill Print Group	Person-oriented
Bill Segment	Account-oriented
Billable Charge	Account-oriented
Budget Review	Account-oriented
Case	Account-oriented, Person-oriented and Premise-oriented
Collection Agency Referral	Account-oriented
Collection Process	Account-oriented
Contract Option	Account-oriented
Control Central	Account-oriented, Person-oriented and Premise-oriented
Customer Contact	Person-oriented
Cut Process	Account-oriented
Declaration	Account-oriented
Deposit Review	Account-oriented
Field Activity	Premise-oriented
Field Order	Premise-oriented
Financial Transaction	Account-oriented
Financial Transaction on a Bill	Account-oriented
Financial Transaction on a Payment	Account-oriented
Interval Profile	Account-oriented (for SA-specific profiles)
Landlord Agreement	Account-oriented
Loan	Account-oriented
Match Event	Account-oriented

Multi-Cancel/Rebill	Account-oriented
Non-Billed Budget	Account-oriented
Order	Account-oriented, Person-oriented and Premise-oriented
Overdue Process	Account-oriented
Pay Plan	Account-oriented
Payment	Account-oriented
Payment Arrangement	Account-oriented
Payment Arrangement for Bills	Account-oriented
Payment Event	The user must have access to ALL accounts linked to the payment event.
Payment Event Quick Add	The user must have access to ALL accounts linked to the payment event(s).
Payment Quick Add	Account-oriented
Payment / Tender Search	Account-oriented
Person	Person-oriented
Premise	Premise-oriented
Premise Management	Premise-oriented
Quote	Account-oriented
SA Billing History	Account-oriented
SA Cash Accounting Balance	Account-oriented
SA Financial History	Account-oriented
SA Relationship	Account-oriented
Service Agreement	Account-oriented
Service Credit Event	The user must have access to ALL accounts linked to the service credit membership that has the service credit event.
Service Credit Membership	The user must have access to ALL accounts linked to the service credit membership.
Service Provider SA Relationship	Account-oriented
Severance Process	Account-oriented
Start/Stop	Account-oriented
Statement	The user can see the statement if they have access to at least one account on the statement's statement construct.
Statement Construct	The user can see the statement if they have access to at least one account on the statement construct.
Terms of Service	Account-oriented (User must have access to at least one account linked to the SA collection in the TOS.)
TOU Map	Account-oriented (for SA-specific TOU maps)
Umbrella Agreement	Account-oriented (User must have access to at least one account linked to the SA collection in the UA's TOS.)
Write Off	Account-oriented
Write Off Process	Account-oriented

## Account Security Case Studies

The topics in this section contain examples of how to implement account security. Use these examples to form an intuitive understanding of these objects. Once this intuition is obtained, you'll be ready to design the account security objects for your own company.

### Securing Accounts Based On Customer Class

Assume the following security requirement exists:

- You have two broad groups of accounts:
  - Residential accounts.
  - Commercial / Industrial accounts.
- Users can be classified as have one of the following access rights:
  - May access all accounts.
  - May only access residential accounts.
  - May only access commercial / industrial accounts.

The following diagram illustrates the access groups and data access roles required to implement these requirements:

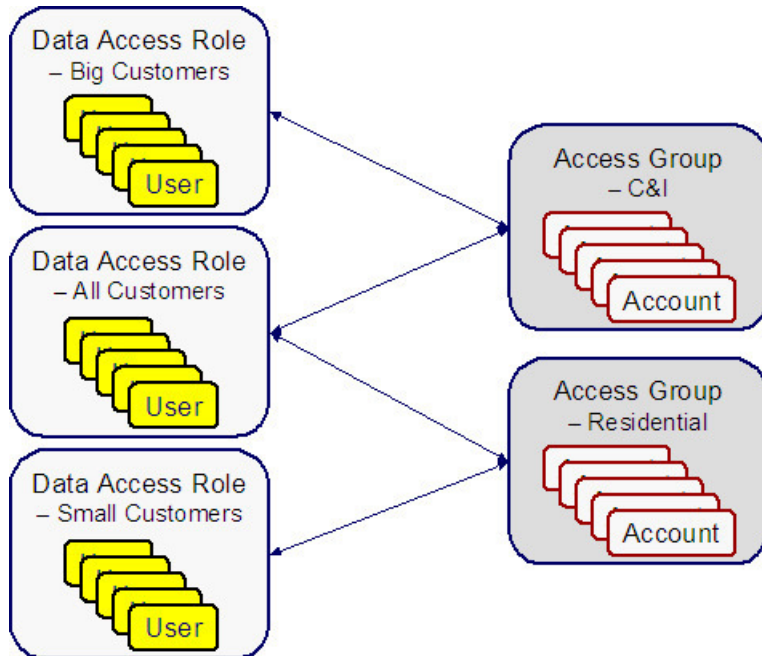

Notice the following about the above:

- There are 2 access groups because access to accounts is based on whether the account is considered to be residential or commercial/industrial.
- The Big Customers data access role is only linked to the C&I access group.
- The Small Customers data access role is only linked to the Residential access group.

- The All Customers access role is linked to both the C&I and Residential access groups. Users with this role can therefore access all accounts.

## Securing Accounts Based On Region

Assume that accounts are classified as belonging to one of the following regions:

- Northwestern
- Northeastern
- Southwestern
- Southeastern

Assume the following company hierarchy exists:

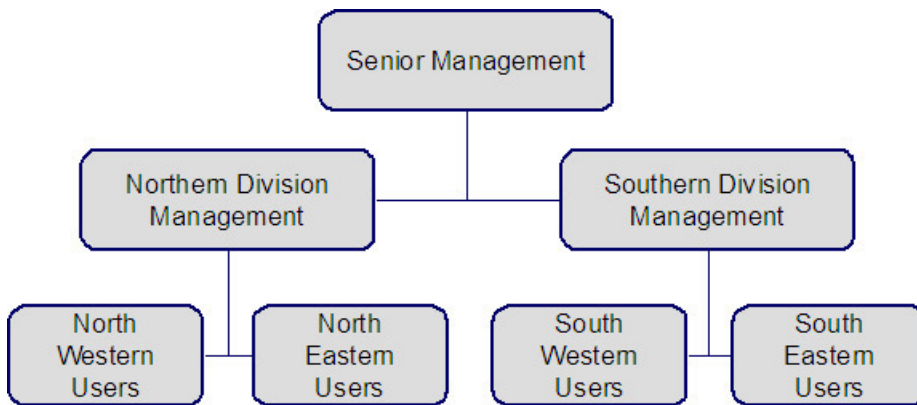

- Senior Management has access to all customers
- Northern Division Management has access to all customers in the Northwestern and Northeastern divisions.
- Southern Division Management has access to all customers in the Southwestern and Southeastern divisions.
- Northwestern Users have access to all customers in the Northwestern division.
- Northeastern Users have access to all customers in the Northeastern division.
- Southwestern Users have access to all customers in the Southwestern division.
- Southeastern Users have access to all customers in the Southeastern division.

The following diagram illustrates the access groups and data access roles required to implement these requirements:

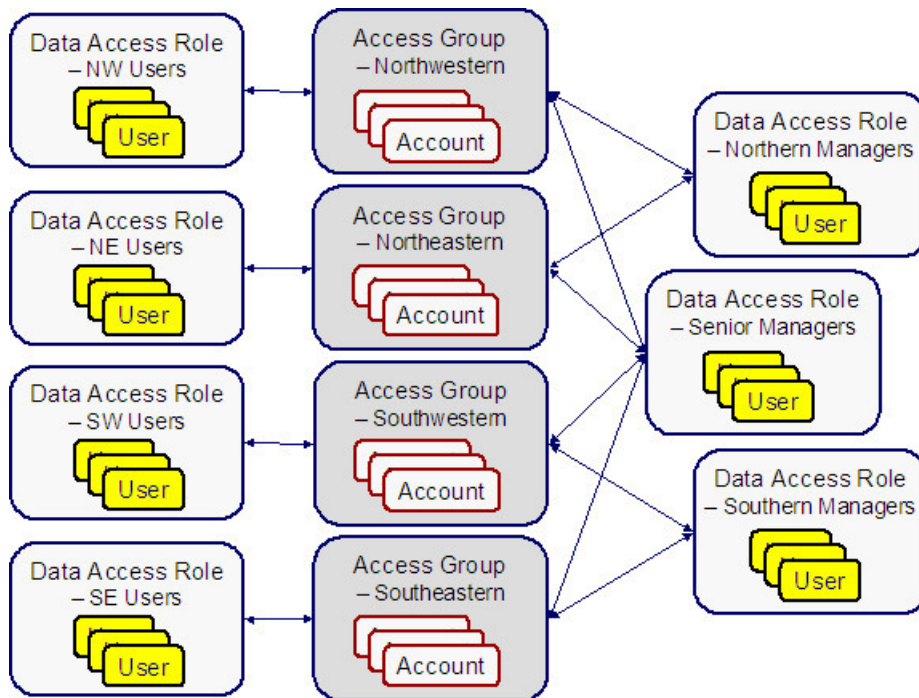

Notice the following about the above:

- There are 4 access groups because access to accounts is based on the region in which they are located (and there are 4 regions).
- There are 7 data access roles because each component of every layer of the access hierarchy requires a separate data access role.

## The Default Access Group

There are two ways an access group can be assigned to an account:

- The base package will default an account's access group based on the user who adds the account. It uses the user's [default access group](#) to do this.
- If you can conceive of a rule to assign an appropriate access group to a newly added account, you can have your programming staff introduce a user exit to the account row program to implement this rule. For example, a user exit could be developed that assigns an access group to an account based on its customer class. The name of the user-exit is AFTER-MOVE-CORR-ADD and the name of the account row program is CIPCACCR.

---

### WARNING:

Regardless of the method used to assign an account's access group, please be aware that the user who adds an account must have access to this access group.

---

### NOTE:

**Subsequent changes to an account's access group.** A user may change an account's access group to any access group to which they have access.

---

## If You Do Not Practice Account Security

If you do not restrict access to accounts (i.e., all users can access all accounts), you must set up one access group and one data access role and then indicate all users are part of this role. You should also define the access group as the default access group on all of your users (so that new accounts are all labeled with this access group).

## Masking Sensitive Data

Refer to [Masking Data](#) for instructions describing how to configure the system to mask sensitive data like a customer's social security number or bank account number. If your implementation intends to mask any of the information that appears in the [Customer Information Zone](#) please navigate to this zone's documentation for special instructions.

## Encrypting Sensitive Data

The product provides support for encrypting certain sensitive data, which may be necessary if your implementation wants to meet security standards such as those for credit card transactions, as specified by the Payment Card Industry Security Standards Council.

Please be sure that you are familiar with the information documented in [Database Encryption and Masking](#) before reading further.

The remaining details in this section provide information about the fields in the product that support encryption along with the suggested configuration for the **Encryption** feature configuration entry if your implementation opts to encrypt the data.

### External Account ID and Credit Card Number Encryption

If your implementation would like to encrypt credit card IDs, the following entry should be added to the Encryption feature configuration so that the data stored in the External ID column on the Account Automatic Payment table is encrypted:

```
table='CI_ACCT_APAY', field='EXT_ACCT_ID', encryptedField='ENCR_EXT_ACCT_ID'
```

---

**NOTE:**

- The External Account ID field also exists on other tables such as Auto Pay Clearing Staging table (CI\_APAY\_CLR\_STG) and Payment Event Upload Staging table (CI\_PEVT\_DTL\_ST) . Feature configuration options do not need to be configured for the External Account ID field on these tables as the field on these related tables is encrypted based on the feature configuration specified above for the Account Automatic Payment table (CI\_ACCT\_APAY).
- A customer's bank account ID or credit card number may also be stored in a column when an order is completed. A field encryption feature configuration for the Order Field table (CI\_ENRL\_FLD) does not need to be configured if the customer's bank account ID or credit card number is referenced on this table. The encryption for the field should be handled by a Column Reference - Preprocessing algorithm. The base product provides an Encrypt Account Auto Pay External Account Id Column Reference Value algorithm type for this purpose.
- A field encryption feature configuration option needs to be configured for each schema field to be encrypted that represents a customer's bank account ID or credit card number. If the value of an encrypted schema field will later be populated on or compared against an encrypted table field, the schema field and the table field must share the same key alias.

---

If your implementation is integrated with a self-service application and one time payment details are captured in Person Self-Service Payment Option (C1\_PER\_SS\_PAYOPT) , the product supports encryption of the Credit Card Number and External Account ID fields on this table. In addition, the product supports a hash representation of this fields for searching

purposes. To encrypt Credit Card Number and External Account ID, add the following entries to the Encryption feature configuration:

- **table='C1\_PER\_SS\_OPT', field='CREDIT\_CARD\_NBR', encryptedField='ENCR\_CREDIT\_CARD\_NBR',hashField='HASH\_CREDIT\_CARD\_NBR'**
- **table='C1\_PER\_SS\_OPT', field='EXT\_ACCT\_ID', encryptedField='ENCR\_EXT\_ACCT\_ID', hashField='HASH\_EXT\_ACCT\_ID'**

## Bank Account Number Encryption

If your implementation would like to encrypt the bank account number stored on the bank account table, the following entry should be added to the Encryption feature configuration:

**table='CI\_BANK\_ACCOUNT', field='ACCOUNT\_NBR', encryptedField='ENCR\_ACCOUNT\_NBR'**

## MICR ID Encryption

The product provides support for encrypting MICR ID associated with payments. In addition, the product supports capturing a hash representation of this field for searching purposes. This field is captured on three tables and entries should be added to the Encryption feature configuration for each as follows:

- **table='CI\_PEVT\_DTL\_ST', field='MICR\_ID', encryptedField='ENCR\_MICR\_ID', hashField='HASH\_MICR\_ID'**
- **table='CI\_PAY\_TNDR\_ST', field='MICR\_ID', encryptedField='ENCR\_MICR\_ID', hashField='HASH\_MICR\_ID'**
- **table='CI\_PAY\_TNDR', field='MICR\_ID', encryptedField='ENCR\_MICR\_ID', hashField='HASH\_MICR\_ID'**

---

**NOTE:** All configurations must share the same key alias.

---

## Person ID Number Encryption

The product provides support for encrypting an identifier associated with a person. In addition, the product supports capturing a hash representation of this field for searching purposes. Because the ID collection on Person includes an ID type, your implementation may decide to encrypt all IDs captured for the person or may choose to only encrypt IDs of one or more specific ID types. If you want to encrypt multiple ID types, you must configure a field encryption option type for each ID type. The following shows an example of an encryption feature configuration entry for encrypting an ID with the type "SSN":

**table='CI\_PER\_ID', field='PER\_ID\_NBR', encryptedField='ENCR\_PER\_ID\_NBR', hashField='HASH\_PER\_ID\_NBR', where='ID\_TYPE\_CD=SSN'**

---

**NOTE:**

- The Person ID Number also exists on the Order Person ID table (CI\_ENRL\_PER\_ID) table. Feature configuration options do not need to be configured for the Person ID Number field on this table as the field is encrypted based on the feature configuration specified above for the Person Identifier table (CI\_PER\_ID).
  - The Person ID Number may also be stored in a column when an order is completed. A field encryption feature configuration for the Order Field table (CI\_ENRL\_FLD) does not need to be configured if the Person ID Number is referenced on this table. The encryption for the field should be handled by a Column Reference - Preprocessing algorithm. The base package provides an Encrypt Column Reference Value algorithm type for this purpose.
  - A field encryption feature configuration option needs to be configured for each schema field to be encrypted that represents a Person ID Number. If the value of an encrypted schema field will later be populated on or compared against an encrypted table field, the schema field and the table field must share the same key alias.
-



## Company ID Encryption

The product provides support for encrypting the Company ID that is populated into automatic payment extract files. If your implementation would like to encrypt company IDs on the Auto Pay Route Type table (CI\_APAY\_RT\_TYPE), the following entry should be added to the Encryption feature configuration:

```
table='CI_APAY_RT_TYPE', field='CO_ID', encryptedField='ENCR_CO_ID'
```

In addition, if your implementation allows Company ID overrides by CIS Division, the following entry should be added to the Encryption feature configuration so that the Company ID on the CIS Division Route Type table (C1\_CIS\_DIV\_RTYP) is encrypted.

```
table='C1_CIS_DIV_TRYP', field='OVRD_CO_ID', encryptedField='ENCR_OVRD_CO_ID'
```

## Encrypting Legacy Data

If you enable encryption in an existing implementation, you should run the encrypt legacy batch controls to encrypt legacy data that persists in the database:

- F1-ENCRT: Encrypt Legacy Table Field Data
- F1-ENCRS: Encrypt Legacy Schema Field Data
- C1-ECRVL: Encrypt Legacy Order Field Col Ref Value

Before executing the batch processes, you must have a keystore file in the system to hold the keys for encrypting data and define an encryption feature configuration that contains the details for the fields you want to encrypt.

## Data Privacy Addendum

This section is an addendum to the general [Data Privacy](#) chapter. This addendum describes Object Erasure functionality that is specific to Oracle Utilities Customer to Meter.

## Customer Erasure

A customer's personal information can be erased from the system under certain circumstances - the most common of which is when the information is no longer necessary for the original purposes of which it was collected and processed. This is usually the case when a customer's accounts have been closed for some time and there is no other activity for that customer.

Erasure can be triggered automatically (e.g. as service agreements go into a final state) or manually (e.g. when a customer calls in to request for erasure).

## Automatic Trigger Of Customer Erasure

A person's eligibility for erasure can be automatically evaluated when key events occur on that person's accounts. These events include:

- Adding a service agreement
- Closing a service agreement
- Canceling a service agreement
- Reactivating a service agreement
- Accepting a proposal service agreement
- Declining a proposal service agreement
- Reopening a proposal service agreement

- Deleting a proposal service agreement

## Monitoring SA Triggers For Customer Erasure

The base product provides an MO Audit algorithm, Monitor SA Manage Erasure Events (C1-SAMNGEREV) that implementations need to plug in on the Service Agreement (SA) MO to enable automatic triggering of erasure.

Note that this algorithm simply creates a General Process record for the Person. This technique allows the system to perform the erasure evaluation (i.e. in the Manage Erasure Schedule algorithm) in batch. This is to minimize the number of times that the Manage Erasure Schedule algorithm is executed for the same Person. For instance, if the customer had one SA closed, another one canceled and another SA created, the erasure evaluation will only be executed once (i.e. when the C1-MNERP batch process runs) even if there were three SA events for that person.

The Manage Erasure Schedule for Person (C1-MNERP) plugin-driven batch process is provided to process the General Process records for managing person erasure. The Process Record algorithm on this batch process invokes the Manage Object Erasure (F1-ManageErasureScheduleDriver) business service. Refer to the C1-MNERP batch control in the application for more details.

## Manual Trigger Of Customer Erasure

A customer may call in to request an agent to erase him or her from the system.

The base product provides a Trigger Customer Erasure (C1-TrgCustEr) BPA script that users can configure as a favorite script in their User Preferences.

This script assumes that the user retrieves the Person before running the script – meaning, the Person is already in the current context. The script pulls in the Person ID and renders the information on the map, which also captures Erasure Date, Erasure Reason and Comments as additional inputs.

A Confirm action will invoke the same Manage Erasure Schedule processing that is executed in automatically triggered person erasures. If the customer is eligible for erasure, the Person and its associated Account(s) and Service Agreement(s) will be scheduled for erasure on the designated Erasure Date. Otherwise, an error will be displayed, indicating ineligibility for erasure.

Refer to the Trigger Customer Erasure (C1-TrgCustEr) BPA script in the application for more details about this script.

## The Person MO Controls Customer Erasure

A customer's eligibility for erasure is evaluated at the Person level. This means that only the Person maintenance object will specify a Manage Erasure Schedule algorithm. Eligibility criteria in this algorithm will check the status of the Person's Account(s) and Service Agreement(s) to determine whether or not these objects can be erased. Object Erasure Schedule records are added/updated/discarded, based on the outcome of the eligibility check.

## Manage Erasure Schedule Algorithm Person Erasure Evaluation

The base product supplies a Maintenance Object - Manage Erasure Schedule algorithm – i.e. Person Erasure Evaluation (C1-PEREREVAL) that determines Person Erasure eligibility based on the status of the service agreements (SAs). If all SAs are in some final state - e.g. Closed, Canceled, etc. - the Person is deemed eligible for erasure and the corresponding Object Erasure Schedule records are added. Otherwise, the Person is deemed ineligible for erasure. If a person that is already scheduled for erasure happens to have new activity - e.g. started a new SA, reactivated a Closed SA, any existing Object Erasure Schedule records for that Person and its Account(s) and SA(s) will be discarded.

## Persons, Accounts And Service Agreements Are Obfuscated

The following sections describe the erasure processing for Person, Account and Service Agreement information.

## Purge Versus Obfuscate

Purging involves physical deletion of a record. On the other hand, obfuscation involves updating certain fields in the table that are considered personally identifiable information (PII) – e.g. name, address, etc. The values of these fields are updated to blank or some value that is no longer identifiable to a person – e.g. the random-generated primary key of the Person record.

Base-supplied Person, Account and SA erasure logic performs obfuscation on the root tables of these maintenance objects (MOs). The reasons are:

- Purging could have impacts to external systems
- Purging might cause orphan data or invalid foreign key references within the system

However, base logic does purge most of the data in these MOs' child tables. The exceptions are characteristic tables and some SA child tables that do not contain PII.

Refer to the next sections for details on each object's obfuscation processing.

## Person, Account and Service Agreement Erasure BOs

The base product provides the following Object Erasure Business Objects (BOs):

- Person Erasure: C1-ErasureSchedulePerson
- Account Erasure: C1-ErasureScheduleAccoun
- Service Agreement Erasure: C1-ErasureScheduleSA

All are child BOs of the Erasure Root parent BO - F1-ErasureScheduleRoot. These BOs are delivered plugged in on their corresponding maintenance objects.

Refer to the Business Object configuration in the application for more details.

## Person, Account and Service Agreement Obfuscation Algorithms

The Person, Account and Service Agreement Erasure business objects include an Enter algorithm (on the Erased state) that is responsible for obfuscating data in the maintenance object's tables. The following sections describe each algorithm.

### Person Obfuscation

The Person Erasure (C1-ErasureSchedulePerson) BO is delivered with an enter algorithm on the Erased state - C1-PEROBJERS.

This algorithm performs the following:

- On the Person root table, updates the Address1, City and Postal fields with the PER\_ID value.

---

**NOTE:** These fields are search fields and are thus indexed.

---

- Deletes all records in the Person Seasonal Address table
- Deletes all records in the Person Identifier table
- In the Person Name table:
  - The primary name is retained and the name value is replaced with the PER\_ID value.

---

**NOTE:** Deletion of the primary name makes the Person record and its Account and SA records unsearchable through the user interface - e.g. via Control Central search.

---

- All other names are deleted
- Deletes all records in the Person Phone table
- Deletes all records in the Person Contact table
- Deletes all records in the Person-to-Person table
- Deletes all records in the Person Self-Service Payment Option table

---

**NOTE:** The base algorithm does not obfuscate nor delete any Person Characteristics because this data is implementation-specific. Implementations that store any personally identifiable information (PII) in this table - e.g. in adhoc characteristic values should add their specific obfuscation/delete logic for these characteristics.

---

## Account Obfuscation

The Account Erasure (C1-ErasureScheduleAccount) BO is delivered with an enter algorithm on the Erased state - C1-ACCTOBFS.

This algorithm performs the following:

- In the Account root table:
  - Removes the link to the Mailing Premise Id
  - Clears contents of the Account Data Area
- Deletes all Account Person records except the main Person.

---

**NOTE:** Deletion of the 'main' person makes the Account unsearchable through the user interface - e.g. via Control Central search.

---

- Updates the main Person's Address Source to Person
- Deletes all records in the Person Address Override table
- Deletes all records in the Account Auto Pay table
- Deletes all records in the Account Alerts table
- Deletes all records in the Account Messages table
- Deletes all records in the Account Credit Rating History table
- Deletes all records in the Account Debt Monitor Review Schedule table
- Deletes all records in the Non-Cash Deposit table
- Deletes all records in the Budget Review table
- Deletes all records in the Notification Preferences table and its child tables

---

**NOTE:** The base algorithm does not obfuscate nor delete any Account Characteristics because this data is implementation-specific. Implementations that store any personally identifiable information (PII) in this table - e.g. in adhoc characteristic values should add their specific obfuscation/delete logic for these characteristics.

---

## Service Agreement Obfuscation

The Service Agreement Erasure (C1-EraseScheduleSA) BO is delivered with an enter algorithm on the Erased state - C1-SAOBFSCTN.

This algorithm performs the following:

- On the SA root record, removes the link to the Characteristic Premise.
- Deletes all records in the SA/SP table and its child tables: SA/SP Field Activity and SA/SP Characteristics

---

**NOTE:** The base algorithm does not obfuscate nor delete any Service Agreement Characteristics because this data is implementation-specific. Implementations that store any personally identifiable information (PII) in this table - e.g. in adhoc characteristic values should add their specific obfuscation/delete logic for these characteristics.

---

## Configuring The System For Customer Erasure

The following are the steps to enable Customer Erasure:

- Plug in the Manage Erasure Schedule - Person Erasure Evaluation algorithm on the Person MO.
- Configure the Erasure Period option on each of the Person, Account and SA MOs.

---

**NOTE:** Note: The values for all three MOs should be the same, to ensure the Erasure Dates are the same on the resulting Object Erasure Schedule records.

---

- Plug in the Monitor SA Manage Erasure Events (C1-SAMNGEREV) Audit algorithm on the SA MO.
- If using the Trigger Customer Erasure (C1-TrgCustEr) script to manually trigger person erasure:
  - Configure values for the Erasure Reason lookup field DP\_CUST\_ERS\_RSN\_FLG.
  - Configure the C1-TrgCustEr BPA script as a Favorite Script in User Preferences.

## Notifying External Systems About Customer Erasure

When CCB is integrated with a meter data management system (such as Oracle Utilities Meter Data Management) and the Person and SA syncs are used to synchronize Contact and Usage Subscription information with corresponding Person and SA information, the meter data management needs to be notified when such information is already erased in CCB.

The following sync request BO schemas include a Customer Erased switch:

- MDM2 Person Sync Request: C1-MDM2PersonSyncRequest
- MDM2 SA Sync Request: C1-MDM2SASyncRequest

Logic on these BOs sets this switch to true if the related Person/SA has an Object Erasure Schedule record that is in the Erased state.

The meter data management system can use this switch to trigger its own erasure processing for Contact and Usage Subscription information. For an example, refer to the Data Privacy documentation for Oracle Utilities Meter Data Management.

Refer to the Business Object configuration in the application for more details.

## Defining Converted COBOL Program Options

The topics in this section describe the transaction that allows you to define the metadata for converted COBOL programs within the current environment's database.

---

**CAUTION:** Updating converted COBOL Programs requires technical knowledge of the system. This is an implementation and delivery issue and should not be attempted if you do not have previous experience.

---

### Converted COBOL Program - Main

Use this transaction to define converted COBOL program user exits for your system. Navigate to this page using **Admin > System > Converted COBOL Program > Search**.

#### Description of Page

The following describes fields that are relevant to defining the user exit code that a converted COBOL Program should use:

**Program Component ID** represents the internal ID that is given to the converted COBOL program component.

**Program Com Name** is the physical name of the converted COBOL program component.

**Template** is the template used to generate the converted COBOL program component.

**Location ID** (*for development purposes*)

**Table** (*for development purposes*)

**User Exit Program.** Specify if you have written user exit code for this converted COBOL program component.

**Development Status Flag.** Options include Note Generated and Not Regeneratable.

**Short Comments** provides a short description of the converted COBOL program component.

**Long Comments** provides more details of the converted COBOL program component.

The **Variable Information** grid (including Variable Name, Occurrence, Variable Sequence, Variable Value, and Variable Alternate Value) is *for development purposes only*.

### Advanced Search Options

The product offers an option to perform expanded / fuzzy searching in [Control Central](#) Search by Name and Address. The option is only available if your implementation has appropriately configured your database for fuzzy searching.

Refer to the DBA guide in the installation guide for details on setting up the database to support fuzzy searching. Note that there are some implementations where fuzzy searching will not be possible. For example, it's only available for implementations using the Oracle database. Additionally, not all languages are supported. Refer to the Oracle Database documentation for more information about fuzzy searching.

If your implementation has configured its database to enable fuzzy searching, you must also set up a [Feature Configuration](#) to indicate that feature is supported. Find the Feature Configuration record for the **General System Configuration** feature type. (It may need to be defined if it does not exist). Choose the option type **Enable Expanded Results** and define a value of **Y**.

# Integration

Oracle Utilities Customer to Meter provides tools to facilitate the integration with other systems. This section provides technical information needed by your implementers to accomplish this.

## CTI-IVR Integration

Oracle Utilities Customer Care and Billing provides tools to facilitate the integration with your Computer Telephony Integration/Interactive Voice Response (CTI/IVR) system. The interface provides the following functionality:

- The ability to launch Control Central for a particular account ID or phone number from an external application
- The ability to accept the next call, as dictated by the CTI software,
- The ability to perform an outbound phone call from within Oracle Utilities Customer Care and Billing

This document provides technical information needed by your implementers to fully integrate with your CTI/IVR system.

## CTI-IVR Integration Configuration

The integration with your Computer Telephony Integration/Interactive Voice Response (CTI/IVR) system requires the setup of master configuration data that controls the Next Caller and Automated Dialer functions.

To set up the CTI/IVR integration master configuration, navigate using **Admin > General > Master Configuration**. You are brought to an all-in-one portal with options to add/edit the CTI/IVR Integration master configuration record. Refer to the embedded help for more details on how each section in this record is configured.

## Launching The System From an External Application

The following section describes possible options to launch the system from an external system.

### Launching The Application Using a URL

You launch the application using a URL. With this option you can set the system to launch a script upon startup. You can also indicate to the system to automatically load an appropriate page (if this information is not part of the script).

The application includes a simple sample html page that can launch CCB Control Central Search by Phone Number or by Central Search Account Id. The page is called CTISample.HTM and is located in /cm\_templates.

---

**FASTPATH:**

Refer to [Launching A Script When Starting The System](#) for further information.

---

## Receiving the Next Caller in the Queue

If your CTI-IVR system allows users to request the next caller waiting in a queue, the system provides a mechanism to integrate with this functionality.

A BPA script called **Get Next Caller (C1-GtNxtClrC)** is available that can be used to request the next call waiting in an inbound queue managed by a CTI application.

When the **Get Next Caller** BPA is executed, it launches the **CTI Get Next Caller** and **Launch CTI** processing scripts that are defined in the CTI/IVR Integration master configuration. Your implementation creates the **CTI Get Next Caller** script that retrieves the next account in the queue. The base product supplies a sample **Launch CTI** BPA script that launches Control Central using the **C1-CCByAcct** BPA script and passing in the account that was returned by the **CTI Get Next Caller** script.

## Customize Integration to Your Next Caller Function

Your implementation needs to create a **CTI Get Next Caller** processing script that will be responsible for getting the next account in the queue, based on your integrated CTI application. The base-supplied **Launch CTI** processing script can be used to navigate to Control Central with the next caller's account passed in.

In order to integrate the next caller functionality with your CTI-IVR system, perform the following steps:

- Create your custom **CTI Get Next Caller** service script that retrieves the next account from the queue.
- Create a **Launch CTI** BPA script if your business rules require additional logic and/or need to launch a different page in the system..
- Plug in the **CTI Get Next Caller** and **Launch CTI scripts** on the CTI/IVR Integration master configuration.

## Initiating an External Call

This section describes the automated dialer functionality provided with the system as well as information about integrating with your own automated dialer.

## Overview of Automated Dialer

In order to initiate a call to a customer from within the system, a context menu item **Go To Automated Dialer** is available on the Person context menu. To call a customer displayed in the current context, choose this option from the person context menu and a window appears, showing a list of phone numbers defined for that person.

Select the desired phone number and click **Dial**.

---

### NOTE:

**Context Entry Secured.** The [navigation key](#) for this window `automatedDialer` refers to an application service to facilitate application security. If your installation does not support an integration with external dialer software, configure the security settings to ensure that users do not have access to the application service for this context entry.

---

## Technical Implementation of Automated Dialer

The popup window is implemented as a BPA script (**C1-LAutoDial**) that calls a configurable **Automated Dialer** BPA script that is responsible for retrieving and displaying person contacts and phone numbers (i.e. if the installation option is set to Use Legacy Person Phone and Email feature configuration option is set to 'Y'). The **C1-AutoDial** sample script provided with the system integrates to any soft phone protocol handler that launches a dialer based on overriding the "tel:" protocol from a browser, for example, Cisco IP Communicator. It launches a UI map to display the person contacts and phone numbers (i.e. if the feature option is set).



## Phone Dialer Configuration

If your implementation chooses to use the functionality provided with the system and integrate with a soft-phone dialer, plug in the base-supplied **C1-AutoDial** script in the CTI/IVR Integration master configuration.

## Customize Integration to Your Automated Dialer Software

In order to integrate with a different automated dialer software application, your implementers must create your own **Automated Dialer BPA** script, to call your specific dialer.

- Copy the **C1-AutoDial BPA** script and make the appropriate changes to integrate with your automated dialer (e.g. change the protocol from “tel:” to “callto:”.
- Plug in your custom Automated Dialer script on the CTI/IVR Integration master configuration.

## Customize Automated Dialer User Interface

Your implementation may choose to display a different user interface for the **Go To Automated Dialer** function than the one provided with the system. For example, perhaps there is more information that you would like to display in addition to the person's name and phone numbers. In order to do this, your custom **Automated Dialer** script needs to invoke a custom UI map that you create as follows:

- Copy the base-supplied **C1-AutomatedDialer** UI map and make the necessary changes.
- Invoke your custom UI map from your custom **Automated Dialer** .

## Analytics Integration Overview

Oracle Utilities Customer to Meter provides tools to facilitate the integration with Oracle Utilities Analytics.

## Analytics Configuration

This section describes functionality provided for integrating with Oracle Utilities Analytics (OUA).

- **Customer Analytics Configuration Portal**

Oracle Utilities Customer to Meter provides a Customer Analytics Configuration portal that holds information on the customer analytics configuration activities. This portal provides a summary of how much configuration has been set up, and also provides links and guidelines for the areas that need configuration, at the minimum, to successfully extract data from Oracle Utilities Customer Care and Billing to OUA. The following provides more information about this functionality.

1. **Customer Analytics Configuration Details** – These data load parameters are used to extract, load, and transform data from Oracle Utilities Customer Care and Billing to Oracle Utilities Analytics. These parameters are used to identify and/or filter data when loading them into the data warehouse. Refer to the *Oracle Utilities Customer Care and Billing* section in the **Configuring Oracle Utilities Analytics** chapter of the *Oracle Utilities Analytics Administration Guide* for detailed information on each extract parameter.
2. **Bucket Configuration List** – This is a summary of the bucket configurations that are needed to classify and group extracted data within Oracle Utilities Analytics. The bucket configurations provide the ability to readily report and analyze data by buckets, or groups. Refer to the *Oracle Utilities Customer Care and Billing* section in the **Configuring Oracle Utilities Analytics** chapter of the *Oracle Utilities Analytics Administration Guide* for detailed information on each bucket configuration supported by Oracle Utilities Customer Care and Billing.

- **Characteristic Mapping**

Oracle Utilities Customer Care and Billing has identified the objects for which characteristic extraction is supported. This includes mapping the source characteristic entity to the target dimension, and defining which target columns are allowed to be mapped for which target dimension. The following table shows the supported mapping.

Object	Supported Target Dimension	Supported Target Columns
Account Characteristic	Account Dimension	User Defined Fields 6 - 15
Person Characteristic	Person Dimension	User Defined Fields 1 - 6
Premise Characteristic	Premise Dimension	User Defined Fields 6 - 18
Premise Characteristic	Address Dimension	User Defined Fields 7 - 16
Service Agreement Characteristic	Service Agreement Dimension	User Defined Fields 9 - 19

## Meter Analytics Configuration Portal

The Meter Analytics Configuration portal holds information on the meter data analytics configuration activities. This portal provides a summary of how much configuration has been set up, and also provides links and guidelines for the areas that need configuration, at the minimum, to successfully extract data from Oracle Utilities Meter Data Management to OUA. The following provides more information about this functionality.

- **Analytics - Oriented Master Configuration:** These data load parameters are used to extract, load, and transform data from Oracle Utilities Meter Data Management to Oracle Utilities Analytics. They are used to identify and/or filter data when loading them into the data warehouse. Refer to the *Oracle Utilities Meter Data Management* section in the *Configuring Oracle Utilities Analytics* chapter of the *Oracle Utilities Analytics Administration Guide* for detailed information on each extract parameter
- **Analytics - Oriented Extendable Lookup List:** The meter data analytics related Extendable Lookup Business Objects are listed in this section. It provides a navigation link to the extendable Lookup Maintenance portal where the lookup values can be configured. Refer to the *Oracle Utilities Meter Data Management* section in the *Configuring Oracle Utilities Analytics* chapter of the *Oracle Utilities Analytics Administration Guide* for detailed information on meter data analytics related extendable lookups.
- **Service Point Configuration List:** This lists the service point types within the system and indicates for each whether or not the meter analytics configuration has been setup. It provides a navigation link to the service point type where the necessary configuration can be setup or modified. Refer to the *Oracle Utilities Meter Data Management* section in the *Configuring Oracle Utilities Analytics* chapter of the *Oracle Utilities Analytics Administration Guide* for further information.

## Batch Controls

Batch Code	Name / Description
<a href="#">D1-SPSDL</a>	Service Point Snapshot Download
<a href="#">D2-DUGDL</a>	Usage Subscription Usage Group Download
<a href="#">D2-MVREF</a>	Materialized View Refresh
<a href="#">D2-USGDL</a>	Service Point Usage Snapshot Download
<a href="#">D2-UUSDL</a>	SP Unreported Usage Snapshot Download
<a href="#">D2-VEEDL</a>	SP VEE Exception Snapshot Download

## References

Refer to the following documentation for more information about Oracle Utilities Analytics:

- *Oracle Utilities Analytics Admin Guide*
- *Oracle Utilities Analytics Dashboards for Oracle Utilities Customer Analytics, Revenue Analytics and Credit & Collections Analytics Metric Reference Guide*
- *Oracle Utilities Analytics Dashboards for Oracle Utilities Exception Analytics Metric Reference Guide*
- *Oracle Utilities Analytics Dashboards for Oracle Utilities Meter Data Analytics Metric Reference Guide*
- *Oracle Utilities Extractors and Schema for Oracle Utilities Customer Care and Billing Data Mapping Guide*
- *Oracle Utilities Extractors and Schema for Oracle Utilities Meter Data Management Data Mapping Guide*

## Self-Service Integration

The following sections describe functionality provided for the integration with self-service applications such as Oracle Utilities Customer Self Service (OUCSS).

### About Self-Service Tasks

Self-service tasks hold information about self-service operations that customers initiate from an integrated self-service application, such as Oracle Utilities Customer Self-Service (OUCSS).

A few examples of self-service tasks are:

- One time payments
- Account verification
- Start/Stop requests
- Auto pay setup
- Creating customer meter readings

Refer to the Oracle Utilities Customer Self-Service (OUCSS) documentation for more details on supported self-service operations.

The following sections highlight self-service integration functionality.

### Self-Service Task Type Defines Self-Service Task Behavior

Each type of self-service operation has specific processing requirements.

Self-service task type controls how a self-service task is processed. It defines the business object to use when creating the self-service task record. The business object defines the lifecycle of self-service task record.

The self-service task type can also specify common configuration data, such as settings for error handling.

### Creating Self-Service Tasks

The customer self-service application invokes inbound web services to create self-service tasks. The system supplies an inbound web service for each supported self-service operation.

Refer to the Oracle Utilities Customer Self-Service (OUCSS) documentation for more details on supplied inbound web services.

Each inbound web service references a service script that processes the specific self-service operation. Refer to the service script system data for processing details.

## Setting Up Self-Service Task Configuration

### Self-Service Integration Configuration

The integration with a self-service application such as Oracle Utilities Customer Self Service (OUCSS) requires the setup of master configuration data that controls the processing of your self-service operations.

To set up self-service integration master configuration, navigate using **Admin > General > Master Configuration**. Two master configurations are required:

- **CCB Self Service Integration:** This master configuration relates to the integration of customer data with a self service application.
- **MDM Self Service Master Configuration:** This master configuration is used for the integration of meter data with a self service application.

Refer to the embedded help for more details on how each section in these records is configured.

### Defining Self-Service Task Types

A self-service task type defines properties that control how a self-service task is processed.

Refer to [About Self-Service Tasks](#) for an overview of service task functionality.

To maintain the types applicable to your product, open **Menu > Self-Service > Self-Service Task Type**.

This is a standard [All-in-One portal](#).

The information captured on the self-service task type depends on the business objects supported by your product. Refer to the embedded help text for more information.

#### Where Used

Follow this link to open the data dictionary where you can view the tables that reference [FI\\_SVC\\_TASK\\_TYPE](#).

### Maintaining Self-Service Tasks

This section describes the functionality supported for viewing and maintaining self-service tasks.

Refer to [About Self-Service Tasks](#) for an overview of self-service task functionality.

Navigate using **Menu > Self-Service > Self-Service Task > Search**. You are brought to a query portal with options for searching for self-service tasks.

Once a self-service task record has been selected, you are brought to the maintenance portal to view and maintain the selected record.

The **Self-Service Task** zone provides basic information about a self-service task. Refer to the embedded help for more information.

### Configuring Rate Compare Usage Adjustment Profiles

This section describes the steps involved in setting up usage adjustment profiles for use with the Rate Compare feature in Oracle Utilities Customer Self- Service.

1. Create a characteristic type and values for each type of usage adjustment to be made available for rate comparison purposes. For example, if you wanted to allow adjustments for installation of solar panels, use of an energy-efficient

appliance, or use of an electric vehicle, you would create three characteristic types (one for each type of adjustment), and values for each option within each type (each type of appliance or electric vehicle supported).

2. Create profile (stand-alone) measuring components that correspond to each characteristic type value.
3. Create profile data for each measuring component. This is interval data that represents the impact of the usage adjustment on a customer's consumption.
4. Create a profile factor for each usage adjustment type.
5. Create factor values for each factor. These values correspond to the characteristic type value, and link characteristic type values to profile measuring components.
6. Create one (or more) **Profile Accumulation** usage calculation rules that will apply the usage adjustment profile to the customer's interval consumption when calculating usage for the rate comparison request.
7. Create entries in the CCB Rate Schedule extendable lookup to associate the usage calculation group that contains the "Profile Accumulation" usage calculation rule to a rate schedule.
8. Create entries in the Usage Adjustment Types extendable lookup for each usage adjustment type.
9. Set up the Rate Compare Configuration section of the MDM Self-Service Master Configuration to link usage adjustment factors and usage adjustment types to rate schedules Oracle Utilities Customer Care and Billing (defined in the CCB Rate Schedule extendable lookup).

## Characteristic Types

Create a characteristic type and values for each type of usage adjustment you wish to make available to customer self-service users. For example, to create a usage adjustment profile for use of an electric vehicle, you would create an "electric vehicle" characteristic type and define values for each type of electric vehicle users can select.

Example Characteristic Type:

- Characteristic Type: ELEC\_VEH
- Description: Electric Vehicles
- Type of Char Value: Predefined Value
- Characteristic Values:

Characteristic Value	Description
LEAF	Nissan Leaf
TESLA	Tesla Model S
VOLT	Chevrolet Volt

## Profile Measuring Components

Create profile measuring components for each characteristic type value. These measuring components will be used to store profile data for each type of usage adjustment.

**Note:** The base package does not include stand-alone measuring component/measuring component type business objects, but the demonstration database contains "Standalone Interval" and "Standalone Interval Measuring Component Type" business objects that can be used to create profile measuring components and types.

Example Profile Measuring Component Type:

- Measuring Component Type: KWH-PROFILE
- Description: KWH Profile
- Measuring Component Business Object: Standalone Interval (demo)

- Measurement Business Object: Measurement
- Service Type: Electric
- Allow Negative Consumption: Allowed
- Consumptive / Subtractive: Consumptive
- Seconds Per Interval: 01:00:00
- Value Identifiers:
- Value Identifier Type: Measurement
- Short-Hand Description: kWh
- UOM: Kilowatt-Hours

Example "Nissan Leaf" Profile Measuring Component:

- Measuring Component Type: KWH Profile
- Number of Digits Left: 5
- Number of Digits Right: 5
- Time Zone: US Pacific Time
- Status: Active
- How To Use: Additive
- External ID: Nissan Leaf

Example "Tesla Model S" Profile Measuring Component:

- Measuring Component Type: KWH Profile
- Number of Digits Left: 5
- Number of Digits Right: 5
- Time Zone: US Pacific Time
- Status: Active
- How To Use: Additive
- External ID: Tesla Model S

Example "Chevrolet Volt" Profile Measuring Component:

- Measuring Component Type: KWH Profile
- Number of Digits Left: 5
- Number of Digits Right: 5
- Time Zone: US Pacific Time
- Status: Active
- How To Use: Additive
- External ID: Chevrolet Volt

## Profile Data

Create profile data for each profile measuring component. This data represents the impact of the usage adjustment on a customer's consumption.

Note that this profile data can (and often will) include negative interval values to represent the difference in consumption applicable for the usage adjustment type. For example, if an energy- efficient electric clothes dryer uses an average of 30 kilowatt hours less per month than an average electric clothes dryer, profile data for that appliance might be a "straight line" hourly profile (a profile in which all intervals are of the same value) in which each value equals "0.042" (30 kWh per month divided by an average of 720 hours per month).

## Factors / Factor Values

Create a profile factor for each usage adjustment type. This factor should use the "Factor Characteristic Source N/A Algorithm" to derive the appropriate characteristic type value based on the factor value, and should reference the characteristic type created earlier.

Example Electric Vehicle Factor:

- **Factor:** ELECTRIC\_VEHICLE
- **Description:** Electric Vehicle
- **Factor Class:** Profile
- **Characteristic Source Algorithm:** Factor Characteristic Source N/A Algorithm
- **Factor Characteristic Type:** Electric Vehicle

Example "Nissan Leaf" Factor Value

- **Factor:** Electric Vehicle
- **Factor Characteristic Type:** Electric Vehicle
- **Factor Characteristic Value:** LEAF
- **Effective Date/Time:** 01-01-2014 12:00:00AM
- **Profile:** Nissan Leaf, KWH Profile

Example "Tesla Model S" Factor Value

- **Factor:** Electric Vehicle
- **Factor Characteristic Type:** Electric Vehicle
- **Factor Characteristic Value:** LEAF
- **Effective Date/Time:** 01-01-2014 12:00:00AM
- **Profile:** Tesla Model S, KWH - 60 Minutes

Example "Chevrolet Volt" Factor Value

- **Factor:** Electric Vehicle
- **Factor Characteristic Type:** Electric Vehicle
- **Factor Characteristic Value:** LEAF
- **Effective Date/Time:** 01-01-2014 12:00:00AM
- **Profile:** Chevrolet Volt / KWH - 60 Minutes

## Profile Accumulation Usage Calculation Group and Rule

Create a usage calculation group that contains a "Profile Accumulation" usage calculation rule. This rule will calculate usage by accumulating historical usage with profile data. based on a selected profile factor value.

**Note:** Profile Accumulation rules should use eligibility criteria to ensure they are only executed when the "Calculation Mode" on the usage transaction is set to "Hypothetical Calculation" (D2HC).

**Example:** Profile Accumulation Usage Calculation Rule

- **Usage Calculation Group:** Electric Residential Interval KWH
- **Usage Calculation Rule:** KWH\_PROFILE\_ACCUMULATION
- **Sequence:** 10
- **Description:** KWH Profile Accumulation
- **Category:** Usage Calculation
- **Vector Source Configuration:**
- **Vector Type:** Channels Linked to Usage Subscription
- **Unit of Measure:** Kilowatt-Hours
- **Time of Use:**
- **Service Quantity Identifier:**
- **Target SPI:** 01:00:00
- **Result Processing Configuration:**
- **Apply TOU Map to Derived Vector:** Yes
- **TOU Map:** Summer / Winter, 15 minute interval
- **Result Storage Configuration:**
- **Insert Primary SQ Entry:** Yes
- **Save Derived Vector:** No
- **Service Quantity Identifier:**
- **Extract Interval Data:** No

### **CC&B Rate Schedule Extendable Lookup**

Create an entry in the "CCB Rate Schedule" extendable lookup to associate the usage calculation group that contains the "Profile Accumulation" usage calculation rule to an applicable rate schedule in Oracle Utilities Customer Care and Billing.

Example CCB Rate Schedule extendable lookup:

- **Rate:** E-INT-RES
- **Description:** Electric Residential Interval Rate
- **Default Usage Calculation Group:** Electric Residential Interval KWH (E-INT-RES)

### **Usage Adjustment Types Extendable Lookup**

Create an entry in the "Usage Adjustment Type" extendable lookup for each type of usage adjustment that will be available to customer self-service users. These entries are used in the Rate Compare Configuration section of the Self-Service Master Configuration (see below).

Example Electric Vehicle entry:

- **Usage Adjustment Type:** ELEC\_VEHICLE
- **Description:** Purchase of Electric Vehicle
- **Override Description:** Purchase of Electric Vehicle
- **External Reference ID:** Purchase of Electric Vehicle



## MDM Self-Service Master Configuration - Rate Compare Configuration

Configure the "Rate Compare Configuration" section of the MDM Self-Service Master Configuration to associate usage adjustment factors and usage adjustment types with an applicable rate schedule in Oracle Utilities Customer Care and Billing (defined in the CCB Rate Schedule extendable lookup).

Example MDM Self-Service Master Configuration:

- **Factor Characteristic Type Indicating No Value Variation: N/A**
- **External Reference Factor Value Characteristic Type: External Reference ID**
- **Minimum Days of Usage Adjustment Data: 2**
- **Rate / Usage Adjustments:**
- **Rate:** Electric Residential - Interval KWH
- **Usage Adjustments:**
- Usage Adjustment Factor: Electric Vehicle
- Usage Adjustment Type: Purchase of Electric Vehicle

## Defining DataConnect Options

Oracle Utilities DataConnect facilitates data extraction from Oracle Utilities Customer to Meter for use in external applications; such as, analytics applications and energy management systems.

This section describes how Oracle Utilities DataConnect works and how to implement and configure the system to support data extract processing.

## DataConnect Data Extracts

Oracle Utilities DataConnect can be used to extract three types of data:

- **Master Data**  
(see [Master Data Extracts](#) for more information)
  - Service agreement, account, and person related information
  - Service point related information
  - Install event related information
- **Billing Data**  
(see [Billing Data Extracts](#) for more information)
- **Measurement Data**  
(see [Consumption Data Extracts](#) for more information)

The data extracted can be correlated in external systems using the service agreement and/or service point data that is included in each type of extract. All data extracts contain a combination of the following data elements that can be used for this correlation:

- **CCB Service Point ID:** The service point ID in Oracle Utilities Customer to Meter and/or
- **MDM Service Point ID:** The service point ID in Oracle Utilities Meter Data Management and/or
- **Service Agreement ID:** The service agreement ID in Oracle Utilities Customer to Meter

External systems receiving data extracted from the Oracle Utilities DataConnect facilities can use these IDs to associate billing data and measurement data to extracted master data.

## Master Data Extracts

Master data extracts are performed through the use of data synchronization, audit algorithms, business objects, and related batch processes.

Batch processes are used to create initial load extracts for service agreement / account / person, service point, and install event related master data. The initial load includes the historical data in the system (either all or a subset, depending on how the batch process is configured). Following the initial load, data synchronization requests are created when master data is added or changed.

## Master Data Extracts: Maintenance Object Audit Algorithms

Detecting changes in master data can be identified by audit algorithms on the following maintenance objects:

- Service Agreement
- Account
- Person
- Service Point (MDM Service Point)
- Install Event
- Device

The Generic Change Data Capture algorithm type (F1-GCHG-CDCP), which is provided in the base package, can be used to create audit algorithms for following maintenance objects:

- Service Agreement
- Service Point (MDM Service Point)
- Install Event

In addition,

- An **Account Change Data Capture (SA-Based) – Include Reactivated SAs** algorithm type (C1-ACCCDCSAR) is provided in the base package. This algorithm type can be used to create an audit algorithm on the Account maintenance object to determine if a service agreement sync request record is to be created for each of the account's non-closed, non-canceled service agreement(s). A change in a related account's details will instantiate a Service Agreement Extract Sync Request (of the type defined for the SA Sync Request BO algorithm parameter) if one does not already exist in the initial state for the service agreement. The base package also contains an algorithm (C1-ACCECDCSA) that is based on this algorithm type.
- A **Person Change Data Capture (SA-Based) – Include Reactivated SAs** algorithm type (C1-ACCCDCSAR) is provided in the base package. This algorithm type can be used to create an audit algorithm on the Person maintenance object to determine if a service agreement sync request record is to be created for each of the person's non-closed, non-canceled service agreement(s). A change in the main person details linked to the service agreement's account will instantiate a Service Agreement Extract Sync Request (of the type defined for the SA Sync Request BO algorithm parameter) if one does not already exist in the initial state for the service agreement. The base package also contains an algorithm (C1-PERECDCSA) that is based on this algorithm type.
- A **Device Change Data Capture (Install Event-Based)** algorithm type (D1-IEDV-CDCP) is provided in the base package. This algorithm type can be used to create an audit algorithm on the Device maintenance object to determine if an install event sync request record is to be created. A change in a related device's details will instantiate an Install Event Extract Sync Request (of the type defined for the "Install Event Sync Request BO" algorithm parameter) if one does not already exist in the initial state for the Install Event.

## Master Data Extracts: Business Objects and Algorithms

The maintenance object audit algorithms create data synchronization requests in the following manner:

- If the Generic Change Data Capture (F1-GCHG-CDCP) algorithm type (provided in the base package) is used, the synchronization requests are based on the Sync Request BO maintenance object options.
- Alternatively, if the base package supplied Maintenance Object – Audit algorithm types, which are outlined in the [Master Data Extracts: Maintenance Object Audit Algorithms](#) section are used, the synchronization requests are based on the Sync Request BO defined in the algorithm parameters.

Extraction of service agreements, service points and install events related information is supported by the following data synchronization business objects.

- **SA/Account/Person Sync for DataConnect (C1-ExternalRepoSASync):** used to extract service agreement / account / person related information. This business object should be defined as a value for the Sync Request BO option on the Service Agreement maintenance object.
- **SP Sync for DataConnect:** (D1-ExternalRepositorySPSync): used to extract service point information. This business object should be defined as a value for the "Sync Request BO" options on the Service Point maintenance object.
- **Install Event Sync for DataConnect:** (D1-ExternalRepositoryIESync): used to extract install event information. This business object should be defined as a value for the "Sync Request BO" options on the Install Event maintenance object.

These business objects use the following Pre-Processing algorithms to take initial data snapshots, and define the batch control used to extract data and export to a flat file:

- Capture SA-Based Initial Snapshot for DataConnect (C1-CEXTRCSAI)
- Capture SP Initial Snapshot for DataConnect (D1-SPEINISNP)
- Capture Install Event Initial Snapshot for DataConnect (D1-IEEINISNP)

These algorithms specify the batch control used for the extract process (see below).

The Sync Request Monitor batch control (F1-SYNRQ) monitors synchronization requests in the Pending state and executes Monitor algorithms that check for other pending related synchronization requests, and, if none, transitions them to the Determine if Sync Needed state.

Enter algorithms on the Determine If Sync Needed states verify if a synchronization is needed by capturing the final snapshot of the data and comparing it against the initial snapshot. If changes are detected, the final snapshots of the data are stamped on the synchronization requests for export.

- Capture SA-Based Final Snapshot for DataConnect (C1-CEXTRCSAF)
- Capture SP Final Snapshot for DataConnect (D1-SPEFNISNP)
- Capture Install Event Final Snapshot for DataConnect (D1-IEEFNISNP)

The Prepare Delimited Extract Data (Ignore Custom Sync Records) Enter algorithm (C1-PRPEXDNCU) or the Prepare Delimited Extract Data Enter algorithm (D1-PRPEXTDTA) on the Send Request state prepares and formats the data for extraction, and creates a general process record for the synchronization request (based on the batch control defined by the pre-processing algorithm).

## Master Data Extracts: Batch Controls

The master data extraction process uses a set of batch processes to create data synchronization requests and extract files.

The following batch processes are used to create initial synchronization requests:

- **SA-Based Initial Load for DataConnect (C1-SAEIL):** This batch control creates initial synchronization requests for service agreements / accounts / persons.

- **SP Initial Load for DataConnect (D1-SPEIL):** This batch control creates initial synchronization requests for service points.
- **Install Event Initial Load for DataConnect (D1-IEEIL):** This batch control creates initial synchronization requests for install events

The following batch processes are used to create extract files from synchronization requests.

---

**NOTE:** These batch processes should be run to create initial load data synchronization requests based on the Sync for DataConnect business objects.

---

- **SA-Based Extract for DataConnect (C1-SASYX):** This batch control creates extract file(s) for service agreements / accounts / persons related information.
- **SP Extract for DataConnect (D1-SPESR):** This batch control creates extract file(s) that contain service point information.
- **Install Event Extract for DataConnect (D1-IEESR):** This batch control creates extract file(s) that contain install event information.

These batch controls are defined as values for the Batch Control for Extract algorithm parameters on the Pre-Processing algorithms on the Sync for DataConnect business objects (see above).

Use the Batch Control portal for more information about these batch controls. The extract batch controls contain parameters that can be used to specify details (including path and file name for this file.) for a delimited flat file containing extracted data.

## Setting Up and Executing Master Data Extracts

Setting up master data extracts involves the following steps:

1. Add audit algorithms on the Service Agreement, Account, Person, MDM Service Point, Install Event, and Device maintenance objects.
  - a) Add the Generic Change Data Capture algorithm as an audit algorithm on the Service Agreement, MDM Service Point, and Install Event maintenance objects.
  - b) Add the Account Change Data Capture (SA-Based) - Include Reactivated SAs algorithm as an audit algorithm on the Account maintenance object.
  - c) Add the Person Change Data Capture (SA-Based) - Include Reactivated SAs algorithm as an audit algorithm on the Person maintenance object.
  - d) Add the Device Change Data Capture (Install Event-Based) algorithm as an audit algorithm on the Device maintenance object.
2. Add the DataConnect synchronization request business objects as Sync Request BO options on the Service Agreement, Service Point and Install Event maintenance objects.
3. Execute initial load batch processes related to service agreements, service points and install events.
4. Once the initial load synchronization has been executed, changes to service agreements, accounts, persons, service points, install events or related devices will trigger the creation of new synchronization requests and resulting extraction files.
5. Execute the sync request monitor process.
6. Execute the extract batch processes related to service agreements, service points and install events.

## Billing Data Extracts

When sending billing related data to an external system, both historical and current data needs to be extracted.

Historical data can be extracted as part of an initial load process, and only needs to be provided during initial setup of the integration. Historical data includes data history for all bill segments for a specified historical period that are:

- Linked to completed bills.
- Not linked to bills but are linked to frozen FTs that are linked to completed bills.

Current data should be extracted on a regular ongoing (or incremental) basis. However, in addition to sending current data, any billing corrections should be extracted as well.

Extraction of billing data is performed through use of data synchronization, post bill completion algorithms, business objects and related batch processes.

## Billing Data Extracts: Business Objects and Algorithms

Billing generates synchronization requests when bills complete through a Customer Class – Post Bill Completion algorithm. The Change Data Capture of Billing Data for DataConnect (C1-CAPBILLEX) algorithm type provided in the base package can be used to create a Customer Class – Post Bill Completion algorithm that creates a billing synchronization request record for each of the bill's bill segments if one does not exist in the initial state.

Billing related information extracts are supported by the following data synchronization business object.

- Billing Sync for DataConnect (C1-ExternalRepoBillingSync). This business object should be defined as an algorithm parameter on the algorithm based on the Change Data Capture of Billing Data for DataConnect (C1-CAPBILLEX) algorithm type.

This business object use the following Pre-Processing algorithm to take an initial data snapshot, and define the batch control used to extract data and export to a flat file. However, since billing data are always synched when it gets completed, no actual initial snapshot is taken. Instead, the parameters used for building the snapshots are taken and stored on the sync request record for later use when building the final snapshot.

- Capture Billing Data Initial Snapshot for DataConnect (C1-EXTRCBLIP)

The Sync Request Monitor batch control (F1-SYNRQ) monitors synchronization requests in the Pending state and executes Monitor algorithms that check for pending related synchronization requests, and, if none, transitions them to the Determine if Sync Needed state.

Enter algorithms on the Determine If Sync Needed states extract a final snapshot of the data if the billing related data is to be extracted and exported.

- Determine if the Billing Sync is Needed (C1-DSCANUSNS) - this is the algorithm that checks if there is a need to export the billing data. It will discard the synchronization request if one of the following is true:
  - The synchronization request is for a cancelled bill segment whose original usage has not been previously sent out.
  - The synchronization request has been marked for non-synchronization (such as, the bill segments related SA Type is not configured to be extracted on the Billing Data Configuration for DataConnect master configuration record).
- Capture Billing Data Final Snapshot for DataConnect (C1-CAPBILUSN) - this is the algorithm that captures the billing data information and stores it on the synchronization request.

If a single extract file that combines both the billing and master data information is preferred, the following algorithms can be used to capture the master data information of the bill. These algorithms should be plugged in on the Determine if Sync Needed state after the Capture Billing Data Final Snapshot for DataConnect algorithm.

- Capture Billing's SA Final Snapshot for DataConnect (C1-CEXTRCSA) - This is the algorithm that captures the service agreement, account and person information associated with the bill.
- Capture Billing's SP Final Snapshot for DataConnect (C1-CEXTRCSP) - This is the algorithm that captures the service point and premise information associated with the bill.
- Capture Billing's Installation Event Final Snapshot for DataConnect (X1-CEXTRCIE). This is the algorithm that captures install event information associated with the bill.

The Prepare Delimited Extract Data (Process All) Enter algorithm (C1-PRPEXDCUS) on the Send Request state prepares and formats the data for extraction, and creates a general process record for the synchronization request (based on the extract batch control defined by the pre-processing algorithm).

## Billing Data Extracts: Batch Controls

The billing data extraction process uses a set of batch processes to create data synchronization requests and extract files.

The following batch process is used to create initial synchronization requests:

- Billing Data Initial Load for DataConnect (C1-BLEIL): This batch control creates initial synchronization requests for bills.

This batch processes should be run to create initial load data synchronization requests based on the C1-ExternalRepoBillingSync business object.

The following batch process is used to create extract files from synchronization requests.

- Billing Data Extract for DataConnect (C1-BSYEX): This batch control creates extract file(s) for billing related information.

This batch control is defined as a value for the Batch Control for Extract algorithm parameter on the Pre-Processing algorithm on the C1-ExternalRepoBillingSync business object.

Use the Batch Control portal for more information about these batch controls. The extract batch controls contain parameters that can be used to specify details (including path and file name for this file) for a delimited flat file containing extracted data.

## Setting Up and Executing Billing Data Extracts

Setting up billing data extracts involves the following steps:

1. Configure the Billing Data Configuration for the DataConnect master configuration record. This is used to configure the UOM, TOU, and SQI of the SA Type's service quantity and charges that will be extracted. Additionally, you can also configure the UOM, TOU and SQI at the rate level.
2. Add the Change Data Capture of Billing Data for DataConnect (C1-CAPBILLEX) related post bill completion algorithm to the applicable customer classes.
3. Execute initial load batch processes related to billing data.
4. Once the initial load synchronization has been executed, current data should be extracted on a regular ongoing (or incremental) basis. In addition to sending current data, any billing corrections will be extracted as well (data related to bill segments not linked to bills but are linked to frozen FTs that are linked to completed bills).
5. Execute the sync request monitor process.
6. Execute the extract batch processes related to billing.

---

## Billing Data Configuration for DataConnect Master Configuration

The master configuration business object for Billing Data Configuration for DataConnect defines general configuration details for the DataConnect functionality. This is used to configure the UOM, TOU, and SQI of the SA Type's service quantity and charges that will be extracted. Additionally, you can also configure the UOM, TOU and SQI at the rate level.

Navigate using **Admin > General > Master Configuration**. In the Master Configuration list, scroll to Billing Data Configuration for DataConnect and click the add icon if there is no record yet or the edit icon to modify an existing record.

For more information about specific fields in the master configuration, refer to the embedded help.

## Consumption Data Extracts

When sending interval measurement usage data to an external system, both historical and current data needs to be extracted. Historical data can be extracted as part of an initial load process, and only needs to be provided during initial setup of the integration. Historical data should include data history for all active service points for a specified historical period. Current data should be extracted on a regular ongoing (or incremental) basis. However, in addition to sending current data, any historical corrections received by the system should be extracted as well.

### Extract Requests

There are several types of consumption extract requests:

- **Initial Load:** Initial load extract requests are created and submitted manually via the Consumption Extract Request portal. Consumption extract requests are based on a specified Consumption Extract Type (see below) and extraction date range. An initial load request must be created and submitted for each consumption extract type defined in the system.
- **Incremental / Ongoing (Current Data):** Incremental / ongoing extract requests can be manually created, but more often will be created via a batch process. The "Create Daily Consumption Extract Requests" batch control scans active consumption extract types and creates a request for each one that has Frequency of "Automated Daily." Ad-hoc incremental requests can be created and submitted manually if needed.
- **Historical Correction:** Historical correction extracts are created via batch process. Algorithms on the Finalized state of the initial measurement and measurement business objects determine if a finalized initial measurement or rederived values are historical corrections. These algorithms create records which are evaluated by a batch process which extracts the measurements for the related initial measurements.

### Consumption Extract Type

Consumption Extract Types define the specific parameters used when processing a consumption extract request. Consumption Extract Types control the service point type, type of measurement, and how the measurements are grouped into TOU periods if applicable. Consumption extract types also define the algorithm and batch processes to use when extracting data for different types of requests (initial load, incremental, and historical).

There are two consumption extract type business objects provided with the base package:

- **Consumption Extract Type (D2-ConsumptionExtractType):** This business object retrieves interval data and converts it to a specified Target UOM and Interval Size. This business object does not support TOU mapping.
- **Consumption Extract Type with TOU Mapping (D2-ConsumptionExtractTypeTOU):** This business object retrieves interval data, converts it to a specified Target UOM and Interval Size, and maps it to a specific TOU map prior to extraction.

### Historical Versus Current Data

The "Extract Through Date/Time" field on the Consumption Extract Type is used to differentiate between current data (the most recently extracted data) and historical corrections, and is set to the last date on which data was extracted for that extract type. For example, if data is extracted on June 1, 2015, the "Extract Through Date/Time" would be set to "June 1, 2015 12:00AM." If/when data is extracted the next day, "Extract Through Date/Time" would be updated to "June 2, 2015 12:00AM."

When evaluating data for extract:

- Interval data is considered current if its measurement date time is after the "Extract Through Date/Time".
- Interval data is considered a historical correction if its measurement date time is on or before the "Extract Through Date/Time".

Historical data changes to an initial measurement can be detected when it enters the Finalized state. If the initial measurement is determined to be for a historical period by comparing its end date/time against the "Extracted Through Date/Time" on the Consumption Extract Type, a general process record will be written for the initial measurement so that measurements for it can be extracted. In addition, re-derived values on final measurements can also trigger the creation of a general process record for related initial measurements.

The following algorithms are used in this process:

- The "Create General Process Record if IMD is Historical Correction" algorithm is used to determine if a finalized initial measurement data is a historical correction. If it is, the algorithm creates a general process record for the initial measurement. This algorithm is provided in the base package, but not specified on initial measurement business objects by default. This algorithm should be defined as an Enter algorithm on the Finalized state of the initial measurement business objects.
- The "Create General Process Record for Re-derived Values" algorithm creates general process records for initial measurements associated with re-derived values. Processing will proceed as if a historical correction came in through an initial measurement. This algorithm is provided in the base package, but not specified on measurement business object by default. This algorithm should be defined as an Enter algorithm on the Re-derive state of the final measurement business object.

## Consumption Extract Requests

Initial load and ongoing consumption extracts are created via Consumption Extract Requests. While extracts of these types can be created via adhoc submission of a batch job, requests are the preferred method for these types of consumption extracts.

The consumption extract request business object lifecycle includes logic that maintains and updates the "Extraction Through Date/Time" field on Consumption Extract Types, which is used to determine if daily requests should be created by the "Create Daily Consumption Extract Requests" batch control, and detect historical corrections.

A single business object is provided in the base package for consumption extract requests:

- **Consumption Request for DataConnect (D2-IntervalDataExtRepository):** This business object contains the information and lifecycle responsible for submitting the extract job, monitoring the run until it's finished, and then updating the Consumption Extract Type's "Extract Through Date/Time" on the Consumption Extract Type. This business object is based on the Request (F1-REQ) maintenance object.

The consumption extract process uses a set of base package algorithms to extract and format the interval data for export. These algorithms are specified in the "Algorithms" section on the Consumption Extract Type as appropriate. These algorithms can be configured to allow for extraction of data for frequently-read scalar measuring components as well as interval measuring components. Frequently-read scalar measuring components are defined as scalar measuring components whose Read Method is set to "Automatic Read." When extracting measurements for frequently-read scalar measuring components, scalar measurements are converted to interval measurements as part of the extraction process. This conversion uses the profile associated with the measuring component type. If no profile can be found, the interval data uses a flat line profile.

**Initial Load / Incremental / Ongoing Requests:** the following algorithms are used to extract and format interval data for initial load and incremental / ongoing requests:

- **Extract Initial Load/Ongoing Consumption for DataConnect (D2-IDEXTPRD):** This algorithm retrieves a service point's consumption for a given period and writes the results to a flat file.
- **Extract Initial/Ongoing Consumption and Apply TOU Map for DataConnect (D2-IDEXTPTOU):** This algorithm retrieves a service point's consumption for a given period, applies a TOU Map to the consumption, and writes the results to a flat file

**Historical Corrections:** the following algorithms are used to extract and format interval data for historical correction requests.



- **Extract Historical Correction Consumption for DataConnect (D2-IDEXTIMD):** This algorithm retrieves historical correction consumption for a service point and writes the results to a flat file.
- **Extract Historical Corrections and Apply TOU Map for DataConnect (D2-IDEXTITOU):** This algorithm retrieves historical correction consumption for a service point, applies a TOU map to the consumption, and writes the results to a flat file.

## Consumption Extract Requests - Batch Controls

The consumption extraction process uses a set of base package batch controls to extract and format the interval data for export.

- **Create Daily Consumption Extract Requests (D2-CRERQ):** This batch process scans for active Consumption Extract Types, and for each one that has Frequency of Automated Daily creates a pending request. This process should be scheduled to run daily (or at another regular interval).

The following sample batch controls are provided to extract and format interval data. Unique batch controls of each of these is required for each consumption extract type. You should create custom versions of the above batch controls for each consumption extract type in your implementation. Extract type-specific versions of these batch controls should be specified in the "Batch Control" section on the Consumption Extract Type as appropriate.

- **Initial Load/Ongoing Consumption Extract (D2-IDEPD):** This batch process extracts interval data for a specified period. This batch control uses the "Initial Load/Ongoing Extract Algorithm" defined on the Consumption Extract Type.
- **Historical Corrections Consumption Extract (D2-IDEHC):** This batch process extracts interval data for historical corrections. This batch control uses the "Historical Corrections Extract Algorithm" defined on the Consumption Extract Type.

Use the Batch Control portal for more information about these batch controls. The extract batch controls contain parameters that can be used to specify details (including path and file name for this file.) for a delimited flat file containing extracted data.

## Consumption Extract Requests - Setup Steps

### Example Setup Steps

Setting up consumption extracts involves the following steps:

1. **Create Consumption Request Types:** you should create a consumption request type for each unique type of request required by your implementation.
2. **Create Consumption Extract Types:** you should create a consumption extract type for each unique combination of output details (target UOM, target interval size, TOU map/template) and measurement selection criteria.
3. Add the "Create General Process Record if IMD is Historical Correction" historical correction algorithm as an Enter algorithm on the Finalized state of the initial measurement business objects.
4. Add the "Create General Process Record for Re-derived Values" historical correction algorithm as an Enter algorithm on the Finalized state on the measurement business object.
5. Create and submit initial load consumption extract requests for each consumption extract type you created earlier.
6. Set up batch processes for daily extract requests and historical corrections. Batch processing for consumption extracts should include the following:
  1. The **Create Daily Consumption Extract Requests (D2-CRERQ)** batch control should be configured to run on a regular (i.e. daily) schedule to create ongoing consumption extract requests.
  2. The **Request Monitor (Deferred) (F1-SUBRQ)** batch control should be used to monitor for pending requests and transition them to the "Submit Job" state.

3. **Historical corrections consumption extract batch controls** (based on D2-IDEHC, one for each consumption extract type), should be configured to run on a regular basis to check for and create historical correction extracts.

## Extract Flat File Formats

This section outlines the format of output flat files created by master and billing data extracts.

### Data Areas:

- C1-ExternalRepoSABasedSnapshot
- D1-ExternalRepositorySPSnapsh
- D1-ExternalRepositoryIESnapsh
- C1-ExternalRepoBillingSnapshot
- D2-IntervalDataExtRepoSnapshot (used for interval consumption extract)
- D2-IntervalDataExtRepoTOUSnap (used for interval consumption extract mapped to TOU periods)

Specifics for how the flat files are created are defined on batch controls and algorithms used by the extract process.

- **File Name and Path:** Parameters on batch controls define the file name, path, and other details about the output file.
- **File Size and Contents:** Batch controls for initial load/ongoing consumption requests include a parameter to specify the number of service points to be included in each file.

## Example Extract File

The following example illustrates comma-separated interval data extracts based on the Consumption Extract Snapshot data area:

```
19502793-60E-KMUS,714532246966,19502793-60E-KMSP,KWH, ,3,600,1.366,2015-01-01,07.00.00,No
19502793-60E-KMUS,714532246966,19502793-60E-KMSP,KWH, ,3,600,1.366,2015-01-01,08.00.00,No
19502793-60E-KMUS,714532246966,19502793-60E-KMSP,KWH, ,3,600,1.366,2015-01-01,09.00.00,No
19502793-60E-KMUS,714532246966,19502793-60E-KMSP,KWH, ,3,600,1.366,2015-01-01,10.00.00,No
19502793-60E-KMUS,714532246966,19502793-60E-KMSP,KWH, ,3,600,1.366,2015-01-01,11.00.00,No
19502793-60E-KMUS,714532246966,19502793-60E-KMSP,KWH, ,3,600,1.366,2015-01-01,12.00.00,No
19502793-60E-KMUS,714532246966,19502793-60E-KMSP,KWH, ,3,600,1.366,2015-01-01,13.00.00,No
```

## Business Flags

It is possible that information detected in one product may be useful or even critical to share with another product. The framework provides functionality for receiving information from an external system that acts as a type of flag or alert that may need investigation. This allows any system to store detected business flags in a common way and share that information with one or more other systems. See [Business Flags](#) for more information.

This section provides further information about business flags and their use in the system.

## Understanding Business Flags

Refer to [About Business Flags](#) in the *Oracle Utilities Framework Administration User Guide* for detailed information about the components of business flags.

Customer to Meter allows for business flags that typically represent situations, exist at a customer's service point, and are shared across external applications; such as, Oracle DataRaker, Oracle Utilities Mobile Workforce Management / Oracle Field Service Cloud, and Oracle Utilities Operational Device Management. The situations that a business flag can represent range from critical knowledge that requires manual analysis for resolution to purely informational notifications.

Sharing information allows users of each system to quickly understand the status of a service point (or device, or network location in some cases) as it relates to situations or insights that would benefit users of the system. For example, the advanced analytics system (Oracle DataRaker) may identify potential theft situations that should be investigated prior to releasing the next bills from CCB with usage transactions from MDM for the related service point's consumption.

The subsequent sections describe business flag functionality that is specific to the service point business flag, as implemented by this product.

When creating a new MDM device type there are the following options:

Name	Details	Business Object
Service Point Business Flag Type	Provides configuration for business flags associated to a service point. This type offers an ability to hold a business flag for manual analysis.	D1-SPBusinessFlagType
Service Point Monitor Business Flag Type	Provides configuration for business flags that should initiate service issue monitors and convey results of a field activity to the intended subscribers.	D1-SPMonitorBusinessFlagType

## Important Business Flag Business Object Options

Below are a list of business object options that are defined on the business flag business object associated to a given business flag type:

- **Valid Action:** identifies a BPA script that can be used to guide the user through an action that can be taken on a business flag. Note: this option should be paired with a business object lifecycle option of "Execution of Valid Actions Permitted" with a value of "true" for any lifecycle status that should support the execution of valid actions.

More detail about these options can be found by visiting a measuring component business object and inspecting the business object options.

## Business Flag Available Actions

Allowed actions are implemented as BPA scripts that will guide the user through a particular method of investigating or resolving the business flag. The following actions are supported:

- **Create Field Activity:** This will initiate a field activity associated to the business flag's service point. The type of field activity will be selected by the user.
- **Create Case:** This will initiate a case associated to the business flag's service point. The type of case will be selected by the user.
- **Create Notification:** This will initiate communication with the customer for the business flag's service point. The type of communication will be determined by the notification type selected by the user.
- **Create Service Issue Monitor:** This will initiate a Service Issue Monitor (SIM) process associated to the business flag's service point. The SIM type is identified on the Business Flag Type configuration. If there are already existing SIM records of this type for the service point, the most recent SIM process will be linked to the business flag.

## Business Flag Adding Available Actions

To extend the actions that are available to the user for investigating a business flag the following steps can be taken:

1. A new BPA script should be developed that provides the functionality for your particular business use case.
2. That BPA script will be added to the transactional business object for the business flag using the option type "Valid Action".

3. Edit the business flag type to include the newly created action in the “Allowed Actions” section of the business flag type.

## Making Allowed Actions Available

Allowed actions are only accessible on those business object statuses that have been configured to support them. To permit access to the available actions on a given status one must add a business object status option for the type “Execution of Valid Actions Permitted” with a value of “Y”.

## Business Flag Can Prevent Bills from Freezing

Some business flags, particularly those that require investigation, should place a hold on the billing process to prevent potentially incorrect bills from being issued to the customer. When certain types of business flags are present on a service point it indicates that there may be a problem with the reported usage that is underlying the bill and as such it may not be desirable to allow the billing process to complete until the investigation into that usage has been completed. For example, if the business flag indicated potential theft or abnormally high usage it may be preferable to delay issuing the bill until an investigation can be performed and the issue rejected or resolved.

This functionality can be enabled through configuration of the Prevent Bill Segment Freeze Due to Business Flag algorithm.

See algorithm type Prevent Bill Segment Freeze Due to Business Flag ( [C1-PRVBSFBF](#)) for more detail.

In MDM, Usage Transactions can also be prevented by configuring the *Valid Business Processes for Hold with Usage Processing* on the Service Point Business Flag Type.

## Field Activities Can Determine Business Flag Confidence

When a business flag results in a field activity being issued and a field team is sent to investigate the service point the result of that field activity investigation will determine the confidence of the business flag. This is done through the field remarks left by the field team. The field activity remarks can either be defined as confirming the business flag or rejecting it. By selecting the appropriate field activity remark the field team will conclude the investigation into the business flag and the final confidence will be updated as appropriate.

For those field activity remarks that should either confirm or reject the business flag the Business Flag Confidence Update algorithm type should be provided for the field activity remark - activation plug-in spot.

Refer to algorithm type **Assign Business Flag Final Confidence** ([D1-ABFFC](#)) for additional details.

## Configuring Business Flags

For information on configuring business flags, see [Business Flag Integration Configuration](#) in the Oracle Utilities Application Framework *Administrative User Guide*.

## Business Flags Can Require Analysis

For more serious situations a business flag can require manual analysis from a user. These types of business flags will generate a To Do when they are received from the external application. To resolve the To Do a user will investigate the service point based on the type of business flag present. Generally this investigation will result in the business flag being either confirmed or rejected. To reach the conclusion of whether the business flag should be confirmed or denied the user can be provided with a set of available actions that can be performed on the business flag.

See [C1-BFANL](#) for more information.

## Configuring Business Flag Integration

Oracle Utilities Meter Data Management includes the following components used when integrating with Oracle DataRaker:

### Master Configuration

The following master configurations are used to configure the sync process between MDM and Oracle DataRaker:

Master Configuration	Description
DataRaker Integration Master Configuration	This master configuration is used to enable deep linking into Oracle DataRaker. Multiple URL patterns are supported with an ability to provide substitution variables to satisfy the URL parameters (e.g. "&searchTech="). This also provides a mapping between Oracle Utilities Meter Data Management service types and the Oracle DataRaker point types.

### Service Provider Processing Methods

The following processing methods should be associated to the service provider configured for Oracle DataRaker:

Processing Role	Description
Business Flag Confidence Change	This role will identify the appropriate message to send when a business flag confidence has been changed (e.g. from Suspected to Confirmed). When not configured no message will be sent.
Business Flag Discarded Notification	This role will identify the appropriate message to send when a business flag has been discarded. When not configured no message will be sent.
Business Flag Field Work Details	This role will identify the appropriate message to send when a business flag has completed that initiated field work. When not configured no message will be sent.
Business Flag Added Notification	This role will identify the appropriate message to send when a business flag has been created from within Oracle Utilities Meter Data Management. When not configured no message will be sent.

### Extendable Lookups

The following extendable lookups should be reviewed for Oracle DataRaker:

Extendable Lookup	Description
Business Flag Standard Name	If Oracle DataRaker will be communicating business flags using a non-standard name provide an entry in the Valid External Name with the non-standard name for each standard name communicated by Oracle DataRaker.

## A Field Activity Can Determine Business Flag Confidence

When a business flag results in a field activity being issued and a field team is sent to investigate the service point the result of that field activity investigation will drive the resolution of the business flag. This is done through the field remarks

left by the field team. The field activity remarks can either be defined as confirming the business flag or rejecting it. By selecting the appropriate field activity remark the field team will conclude the investigation into the business flag and the final confidence will be updated as appropriate.

For those field activity remarks that should either confirm or reject the business flag the Business Flag Confidence Update algorithm type should be provided for the field activity remark – activation plug-in spot.

Please refer to algorithm type Business Flag Confidence Update ([C1-BSFLGCFUP](#)) for more detail.

## Business Flags Can Create Alerts

Some business flags have a high enough importance that they should be highlighted to any user that is viewing data for the service point the business flag is related to. Whether a business flag should create an alert is controlled on the business flag type. Furthermore, the appropriate algorithm must be configured in the “Installation Options – Framework” “Algorithms” page for the “Control Central Alert” system event.

The product delivers the algorithm type “Highlight Open Business Flags”

Please refer to algorithm type *Business Flag Confidence Update* ([C1-BSFLGCFUP](#)) for more detail.

## Customer Relationship Management Integration

Oracle Utilities Customer Care and Billing provides tools to facilitate the integration with customer relationship management applications such as Oracle Social Relationship Management (SRM).

The following sections describe this functionality.

### About Customer Relationship Requests

A customer relationship request is used to process requests that are initiated from an external customer relationship management system.

The following sections highlight customer relationship request functionality.

### Social Relationship Management Requests

Oracle Social Relationship Management (SRM) is an example of an external system that can initiate customer relationship requests.

Social network posts cover a vast range of topics, a number of which could be related to the users' concerns with their utility service. For example:

- A Facebook user could post on a community page about a power outage in a specific area.
- A Twitter user might post about specific problems with his/her utility service (*e.g.*, high bill complaints).

Social conversations of this nature can be monitored and managed via Oracle SRM. Oracle SRM's Engage module allows its users to see all social conversations, identify customer-specific issues and route the messages to the appropriate systems/channels.

Requests from social relationship management systems typically include:

- Information about the original posting on the social network/community (*e.g.*, author's identifier, link to the post, etc.).
- Information about the posting within the social relationship management system (*e.g.*, the user that sent the request to the utility, link to the post, etc.).
- Additional details that will help with processing/resolution (*e.g.*, customer/account numbers, address, bill IDs, etc.).

## Creating Customer Relationship Requests

Most customer relationship requests will be initiated from an external system.

The base product provides an Add Customer Relationship Request (C1-AddCustRR) inbound web service that can be used in a customer relationship management integration to create customer relationship request records. This inbound web service invokes a processing script that is configured in Customer Relationship Integration master configuration. The base product supplies an example of this processing script. It maps the inbound service's input data into the customer relationship request record. Refer to the C1-CreCustRR service script system data for processing details.

## Setting Up Customer Relationship Request Configuration

The following topics highlight the general configuration steps required to use customer relationship request functionality and to integrate with a customer relationship management application such as Oracle Social Relationship Management (SRM).

### Customer Relationship Management Integration Configuration

The integration with a customer relationship management application such as Oracle Social Relationship Management (SRM) requires the setup of master configuration data that controls the processing of your customer relationship requests.

To set up customer relationship integration master configuration, navigate using **Admin > General > Master Configuration**. You are brought to an all-in-one portal with options to add/edit the Customer Relationship Integration master configuration record. Refer to the embedded help for more details on how each section in this record is configured.

### Defining Customer Relationship Request Types

A customer relationship request type defines properties that control how a customer relationship request is processed.

Refer to [About Customer Relationship Requests](#) for an overview of customer relationship request functionality.

To maintain customer relationship request types, open **Admin > Integration > Customer Relationship Request Type > Search**.

This is a standard [All-in-One portal](#).

The information captured on the customer relationship request type depends on the business objects supported by your implementation. Refer to the embedded help text for more information.

#### Where Used

Follow this link to open the data dictionary where you can view the tables that reference [C1\\_CUST\\_REL\\_REQ\\_TYPE](#).

## Maintaining Customer Relationship Requests

This section describes the functionality supported for viewing and maintaining customer relationship requests.

Refer to [About Customer Relationship Requests](#) for an overview of customer relationship request functionality.

Navigate using **Menu > Integration > Customer Relationship Request > Search**. You are brought to a query portal with options for searching for customer relationship requests.

Once a customer relationship request record has been selected, you are brought to the maintenance portal to view and maintain the selected record.

The **Customer Relationship Request** zone provides basic information about a customer relationship request. Refer to the embedded help for more information.

The **Notes** zone allows users to capture additional notes to the customer relationship request.

## RightNow Knowledge Integration

Oracle Utilities Customer Care and Billing provides an integration with Oracle RightNow Knowledge that allows users to view frequently asked questions about business processes/functions that relate to the portal or page that they are currently viewing and/or working on.

The following sections describe this functionality.

### Displaying Frequently Asked Questions

The Oracle RightNow Knowledge application can be used to develop content for frequently asked questions about business processes. It also functions within the Oracle Customer Care and Billing application. The RightNow KnowledgeSyndication widget defines the interface for the retrieval of this content.

The Oracle Customer Care and Billing application provides a **Frequently Asked Questions** dashboard zone that uses the RightNow KnowledgeSyndication widget to retrieve content from a RightNow Knowledge base instance. This zone is context-sensitive.

Configuration data controls how information is displayed in the **Frequently Asked Questions** dashboard zone. Refer to [RightNow Knowledge Integration Configuration](#) for more details.

### RightNow Knowledge Integration Configuration

The integration with Oracle RightNow Knowledge requires the setup of master configuration data that controls how content from the RightNow Knowledge base is retrieved and presented on the **Frequently Asked Questions** dashboard zone. This configuration includes the following settings:

- The URL of the RightNow Knowledge base instance.
- The list of portals and pages for which the **Frequently Asked Questions** dashboard zone will display.
- Settings for each portal / page:
  - Search terms to pass to the RightNow KnowledgeSyndication widget. The base product supplies a number of common search term types. Implementation-specific search term types can be added.
  - Number of results/answers to display in the **Frequently Asked Questions** dashboard zone.

To set up the RightNow Knowledge Integration master configuration, navigate using **Admin > General > Master Configuration**. You are brought to an all-in-one portal with options to add/edit the RightNow Knowledge Integration master configuration record. Refer to the embedded help for more details on how each section in this record is configured.

## External Applications

### Understanding External Applications

External applications are applications and systems that are external to the Oracle Utilities meter data products, and can include customer information systems, outage management systems, or other types of applications.

External system service providers utilize processing methods to specify how the system sends and creates data used by the two applications. .

Refer to [Understanding Process Methods](#) for more information about processing methods.



## External Applications Impact Data Import and Export

External Applications are configured to identify how a particular external system communicates data with Oracle Utilities Meter Data Management. This includes:

- The identifier type used to locate devices and measuring components. These are used both on import and export of data.
- The date/time format used in various data imports (i.e. whether or not the date/time format includes time zone information).

Please refer to the embedded help for more information about these fields.

Each external application can be associated to an [external system](#) which is used to define the messages that can be sent to that service provider and how each message is sent.

## Configuring External Applications

This portal is used to display and maintain External Applications.

Refer to [Understanding External Applications](#) for more information.

You can access the portal from the **Admin > Integration > External Applications**.

The following zones may appear as part of the portal's **Main** tab page:

- **External Applications List:** This zone lists all External Application records. Broadcast a record to display the details of the selected record.
- **External Application:** This zone provides information about the selected External Application.
- **Processing Method List:** This zone provides the list of processing methods defined for the External Application.
- **Translation Method List:** This zone provides the list of translation methods defined for the External Application.
- **Inbound BOs Send By Service Provider:** This zone lists inbound Business Objects that are sent by this External Application. The identification is driven by the Business Object having a Business Object Option of type "Sent By Service Provider" that references the current External Application.

### Where Used

Follow this link to open the data dictionary where you can view the tables that reference [DI\\_SPR](#).

## Configuring Master Data Synchronization

Refer to [Customer To Meter Master Data Synchronization](#) for more information.

## Oracle Utilities Operational Device Management

### Overview

This section provides an overview of how Oracle Utilities Meter Data Management supports integrations with Oracle Utilities Operational Device Management. In an integration between Oracle Utilities Meter Data Management and Oracle Utilities Operational Device Management:

- Oracle Utilities Meter Data Management is typically considered the "system of record" for service points (asset locations) and device installation information (install events)

- Oracle Utilities Operational Device Management is typically considered the "system of record" for assets (devices)

Given this breakdown of data between the two systems, any integration between them must account for the passage of data between the two to ensure that each system can accurately perform its business functions. The integration between Oracle Utilities Meter Data Management and Oracle Utilities Operational Device Management is based on data synchronization between the two systems.

## Configuring Master Data Synchronization

The specific data synchronization flows supported between Oracle Utilities Meter Data Management (MDM) and Oracle Utilities Operational Device Management (ODM) include the following:

- **Asset-Device Synchronization:** As new assets are created or changed in ODM, corresponding devices must be created or changed in MDM
- **Service Point/Contact - Asset Location/Contact:** As Service Points and/or Operational Contacts for Service Points are created or changed in MDM, corresponding Asset Locations and Contacts must be created or changed in ODM
- **Install Events- Asset Location/Disposition:** As devices are installed/removed in MDM, corresponding changes to an asset's Disposition (location and status) must be made in ODM

This synchronization process is supported through a set of business objects, master configurations, batch controls, and pre-configured Inbound Web Services. Refer to the *Oracle Utilities Integration for Device Operations Implementation Guide* for more information about this integration and the data synchronization processes used by this integration.

## Master Configuration

The following master configurations are used to configure the sync process between MDM and ODM:

Master Configuration	Name / Description
Master Data Synchronization Configuration	Lists all foreign key references that need resolution. Each one should reference the view that contains the external key / production key cross-reference. For entities that undergo both the initial and the ongoing sync, two views are specified. For entities that undergo the ongoing sync, an external system / ID type mapping is specified to cater for entities that might be synchronizing from more than one external system.
Seeder Sync Request Master Configuration	Lists the maintenance objects (device, device configuration, etc.) that require synchronization. Each references the synchronization business object that needs to be instantiated when processing a synchronization request for that maintenance object. For maintenance objects that undergo both initial and the ongoing synchronization, two business objects are specified.
ODM Integration Master Configuration	Specifies the external system used to represent Oracle Utilities Operational Management, and the URL for the Oracle Utilities Operational Management application.  Also specifies the outbound message types used to send synchronization requests to Oracle Utilities Operational Management.

## Inbound Data Synchronization Business Objects

The integration between Oracle Utilities Meter Data Management and Oracle Utilities Operational Device Management uses the following inbound (to Oracle Utilities Meter Data Management) synchronization business objects:

Object Name	Business Object	Description
Device Ongoing Sync Request	D1-OngoingSyncRequestDevice	Used to synchronize devices in Oracle Utilities Meter Data Management based on assets created/updates in Oracle Utilities Operational Device Management.

## Outbound Data Synchronization Business Objects

The integration between Oracle Utilities Meter Data Management and Oracle Utilities Operational Device Management uses the following outbound (from Oracle Utilities Meter Data Management) synchronization business objects (based on the F1-SYNC REQ maintenance object)

Object Name	Business Object	Description
ODM Sync Request	D1-ODMContactSyncRequest	Used to synchronize contacts in Oracle Utilities Operational Device Management based on contacts created/updated in Oracle Utilities Meter Data Management
ODM Install Event Sync Request	D1-ODMInstallEventSyncRequest	Used to synchronize asset location/disposition in Oracle Utilities Operational Device Management based on install events created/updated in Oracle Utilities Meter Data Management
ODM SP Sync Request	D1-ODMSPSyncRequest	Used to synchronize asset locations in Oracle Utilities Operational Device Management based on service points created/updated in Oracle Utilities Meter Data Management

## Oracle DataRaker

This section describes integrations with Oracle DataRaker.

### Business Flag Integration

With the business flag integration with Oracle DataRaker:

- Either Oracle Utilities Meter Data Management or Oracle DataRaker can initiate a business flag
- Oracle Utilities Meter Data Management can notify Oracle DataRaker of a change in status of a business flag:
  - if a business flag in error has been discarded
  - if a business flag's confidence has been updated
  - with the results of field work initiated by a business flag

For additional details see [About Business Flags](#) in the Oracle Utilities Application Framework *Administrative User Guide*.

## Usage and Event Integration

Oracle Utilities Smart Grid Gateway adapters can be configured to publish initial measurement and device event data for use in Oracle DataRaker or other external systems. Published data is posted to a user-defined directory that Oracle DataRaker can monitor for import.

Initial measurement and device event data is published in the “native” data format (the format of the initial measurement and device event seeder business objects). This format includes normalized unit of measure, condition, and device event codes. See the *Oracle Utilities Smart Grid Gateway Adapter Development Kit Administrative User Guide* for more details about this format.

---

**NOTE:** Initial measurement data published via this feature is published prior to VEE processing. In addition, filtering can NOT be applied to initial measurement or device event data published via this feature.

---

## Configuring DataRaker Usage and Event Integration

Oracle Utilities Smart Grid Gateway adapters use OSB and BPEL components when publishing initial measurement and device event data for integration with Oracle DataRaker.

### OSB Projects

The following “CM” Oracle Service Bus projects are used to configure the integration between SGG and Oracle DataRaker:

Adapter	OSB Projects
Landis+Gyr	SGG-D3-USAGE-CM (used to publish usage)
	SGG-D3-EVENT-CM (used to publish device events)
NES	SGG-D4-USAGE-CM (used to publish usage)
	SGG-D4-EVENT-CM (used to publish device events)
MV90	SGG-D5-USAGE-CM (used to publish usage)
Sensus	SGG-D6-USAGE-CM (used to publish usage)
	SGG-D6-EVENT-CM (used to publish device events)
Silver Spring Networks	SGG-D7-SSNXML-CM (used to publish usage)
	SGG-D7-CSV-CM (used to publish device events)
Itron OpenWay	SGG-D8-ITRONXML-CM (used to publish usage)
	SGG-D8-EXCEPTION-CM (used to publish device events)
Adapter Development Kit	SGG-DG-SEEDER-CM (used to publish usage and device events)

The following components provided with these projects are used in publishing measurement data and device events to Oracle DataRaker:

- The **DataRakerBusinessService** business service is used to send data to a pre-configured JMS queue (defined as an Endpoint URI), from which the data will be published. This business service is specified in the EnvironmentSettings.xq file (see below).
- The **DataRakerServiceAccount** service account is used to define and maintain the user name and password needed to access the JMS queue defined in the **DataRakerBusinessService** business service.

## Enabling Data Publishing

Publishing initial measurement and device event data is enabled by referencing a publisher business service (DataRakerBusinessService) in the publishServices/service element in the EnvironmentSettings.xq files provided with the OSB projects listed above as follows:

```
<publishServices>
  <service>[publisherBusinessService]</service>
</publishServices>
```

## BPEL Composites

The SGGDRIntegration BPEL composite handles publishing the data to Oracle DataRaker or other systems.

## Configuring Publishing Output

The following parameters can be used to configure details of how the data is provided to Oracle DataRaker, including the directory where files are posted for Oracle DataRaker to consume, number of records per file, polling frequency, etc. These parameters are defined during installation. See the *Oracle Utilities Smart Grid Gateway Installation Guide* for more details about defining values for these parameters.

Parameter	Description	Default Value
SGG_DR_INT_QUEUE	JNDI name of queue to publish SGG payloads.  This is the JMS queue defined in the <b>DataRakerBusinessService</b> business service. This should NOT be changed.	DataRakerQueue
SOA_DR_PUBLISH_SIZE	The number of records (SGG payloads) to accumulate in a published file.	100
SOA_DR_FILE_SIZE	The maximum file size for the accumulated (SGG payloads) file in kilobytes.	524288
SOA_DR_ELAPSED_TIME	The period of time in second which, when exceeded, causes a new outgoing file to be created.	600
SOA_DR_POLLING_FREQ	The polling frequency in seconds of the staging directory for new files.	60
SOA_DR_STAGING_DIR	Mount point/directory for the staging directory for accumulated SGG payload files.  This is used internally and should NOT be changed.	/spl/sploutput/staging
SOA_DR_INTEGRATION_DIR	Mount point/directory from which Oracle DataRaker will consume the converted XML files.	/spl/sploutput/int

## Oracle Utilities Network Management System

## Outage Care Integration

The following section describes functionality provided for the integration between Oracle Utilities Customer Care and Billing and Oracle Utilities Network Management System.

### The Big Picture of Outage Care Integration

Oracle Utilities Customer Care and Billing is the central repository for customer information; for example, name, address, phone number, etc. Oracle Utilities Network Management System is the central repository for outage information; for example, outage calls, affected supply nodes, expected restoration time, etc.

In an integrated environment, each system provides information to the other system so that they can operate together seamlessly.

- The outage system uses the set of current customers to determine and manage outages to minimize their impact.
- The outage system is informed of outages captured in Oracle Utilities Customer Care and Billing.
- Oracle Utilities Customer Care and Billing uses the current status of an outage at a given premise for customer service.

### Customer Information Integration

The outage system needs information about current customers to determine and manage outages to minimize their impact. The current customer information in Oracle Utilities Customer Care and Billing must be made available in Oracle Utilities Network Management System. This can be done via data synchronization.

---

**FASTPATH:**

Refer to [The Big Picture of Sync Requests](#) for more information about synchronizing data.

---

### Interfacing Outage Calls

The following points describe the integration:

- Oracle Utilities Customer Care and Billing is able to record trouble calls for a particular service point that exists in the system, as well as for an unknown service point, i.e. a fuzzy call. For a fuzzy call, the caller must provide either a street intersection, or a street segment.
- When an outage call is created and sent to the external system, an algorithm on the outage call business object is responsible for creating an outbound message that's sent to the external system. This is a real-time synchronous interface between Oracle Utilities Customer Care and Billing and Oracle Utilities Network Management System.
- Oracle Utilities Network Management System processes the Calls table and creates Incidents.

---

**FASTPATH:**

Refer to the *Oracle Utilities Customer Care and Billing - Network Management System Integration Implementation Guide* for information about outage call integration.

---

### Outage Inquiry

Oracle Utilities Customer Care and Billing provides query transactions that can be used to make real-time synchronous calls to NMS and inquire on one of the following:

- Job History for a particular customer, service point, location or call identifier
- Call History for a particular customer, service point, location or call identifier
- Planned Outage Jobs for a particular service point

---

**FASTPATH:**

Refer to the *Oracle Utilities Customer Care and Billing - Network Management System Integration Implementation Guide* for information about outage query integration.

---

## Setting Up The System To Enable Outage Integration

The following section provides an overview of how to enable the integration between Oracle Utilities Customer Care and Billing and Oracle Utilities Network Management System.

### External System Setup

An external system must be setup in order integrate Oracle Utilities Network Management System. Once the external system is defined, specify this on the one NMS Integration feature configuration so the system knows which external system to use for outage queries.

### Define Outbound Message Types

The following outbound message types are required for the integration:

- An outbound message type is required for each of the outage queries available
  - Job History
  - Call History
  - Planned Outages
- Once the outbound message types are defined, specify this on the one NMS Integration feature configuration so the system knows which outbound message types to use for outage queries.
- In addition, an outage call outbound message type is required for sending outage calls to Oracle Utilities Network Management System. This outbound message type must be referenced on your outage call types.

### Define Characteristic Types

The following characteristic types must be defined to facilitate Outage integration:

#### Outage Group Code Characteristic Type

These characteristics are used to describe the outage problem.

- Create at least one pre-defined characteristic type
- For each characteristic type, define its list of valid values
- Include Service Task Type in the characteristic entity collection

---

**NOTE:**

**Characteristic Type Prefix.** The system attempts to build a dropdown list of your valid outage group codes when maintaining outage group types. To achieve this, all outage group code characteristic types must use the same prefix. This prefix must be defined on the NMS Integration feature configuration.

**Integration with Outage Management.** The outage codes must be defined in both Oracle Utilities Customer Care and Billing and the outage management system. Refer to your Oracle Utilities Network Management System documentation for information about defining the outage codes there.

---

**Contact Name Characteristic Type**

This is used to link the contact name of the caller associated with an outage call as a characteristic on the outage call.

- Create an ad-hoc [characteristic type](#)
- Include Service Task Type in the characteristic entity collection
- Specify this characteristic type on the one NMS Integration feature configuration using the Outage Call Contact Name Characteristic Type feature option

**Contact Number Characteristic Type**

This is used to link the contact number of the caller associated with an outage call as a characteristic on the outage call.

- Create an ad-hoc [characteristic type](#)
- Include Service Task Type in the characteristic entity collection
- Specify this characteristic type on the one NMS Integration feature configuration using the Outage Call Contact Number Characteristic Type feature option

**Call Identifier Characteristic Type**

This is used to link the call identifier supplied by the caller associated with an outage call as a characteristic on the outage call.

- Create an ad-hoc [characteristic type](#)
- Include Service Task Type in the characteristic entity collection
- Specify this characteristic type on the one NMS Integration feature configuration using the Outage Call Identifier Characteristic Type feature option

**Street Name Characteristic Type**

This is used to link location information supplied by the caller associated with a fuzzy trouble call as a characteristic on the outage call.

- Create an ad-hoc [characteristic type](#)
- Include Service Task Type in the characteristic entity collection
- Specify this characteristic type on the one NMS Integration feature configuration using the Outage Call Street Name Characteristic Type feature option

**Cross Street Name Characteristic Type**

This is used to link location information supplied by the caller associated with a fuzzy trouble call as a characteristic on the outage call.

- Create an ad-hoc [characteristic type](#)
- Include Service Task Type in the characteristic entity collection
- Specify this characteristic type on the one NMS Integration feature configuration using the Outage Call Cross Street Name Characteristic Type feature option

**Block Number Characteristic Type**



This is used to link location information supplied by the caller associated with a fuzzy trouble call as a characteristic on the outage call.

- Create an ad-hoc [characteristic type](#)
- Include Service Task Type in the characteristic entity collection
- Specify this characteristic type on the one NMS Integration feature configuration using the Outage Call Block Number Characteristic Type feature option

### City Characteristic Type

This is used to link location information supplied by the caller associated with a fuzzy trouble call as a characteristic on the outage call.

- Create an ad-hoc [characteristic type](#)
- Include Service Task Type in the characteristic entity collection
- Specify this characteristic type on the one NMS Integration feature configuration using the Outage Call City Characteristic Type feature option

### State Characteristic Type

This is used to link location information supplied by the caller associated with a fuzzy trouble call as a characteristic on the outage call.

- Create an ad-hoc [characteristic type](#)
- Include Service Task Type in the characteristic entity collection
- Specify this characteristic type on the one NMS Integration feature configuration using the Outage Call State Characteristic Type feature option

## NMS Integration - Feature Configuration

Create a [feature configuration](#) with the type NMS Integration. Populate entries for all the options.

---

**NOTE:**

**Only one.** The system expects only one NMS Integration feature configuration to be defined.

---

Configure the options for your interaction with the outage system.

---

**NOTE:**

Your implementation may define additional options types. You do this by adding new lookup values to the lookup field NMS\_OPT\_TYP\_FLG.

---

Option	Description
External System	This defines the external system used on outbound messages created when querying outage information in NMS from the outage management information portal page. Refer to <a href="#">Defining Service Order Options</a> for more information.  Only one value is allowed for this option.
Outbound Message Type - Call History	This defines the outbound message type used on outbound messages created when querying outage call history in NMS from the outage management information portal page. Refer to <a href="#">Defining Service Order Options</a> for more information.

	Only one value is allowed for this option.
Outbound Message Type - Job History	This defines the outbound message type used on outbound messages created when querying outage job history in NMS from the outage management information portal page. Refer to <a href="#">Defining Service Order Options</a> for more information. Only one value is allowed for this option.
Outbound Message Type - Planned Outages	This defines the outbound message type used on outbound messages created when querying planned outages in NMS from the outage management information portal page. Refer to <a href="#">Defining Service Order Options</a> for more information. Only one value is allowed for this option.
Outage Group Code Characteristic Type Prefix	The system uses this prefix to populate the outage group code dropdown list during trouble call processing. Refer to <a href="#">Defining Service Order Options</a> for more information. Only one value is allowed for this option.

## Schema Constants - Feature Configuration

Create a [feature configuration](#) with the type Schema Constants. Populate entries for all the options listed below.

**NOTE:**

**Only one.** The system expects only one Schema Constants feature configuration to be defined.

Configure the options for your interaction with the outage system.

**NOTE:**

Your implementation may define additional options types. You do this by adding new lookup values to the lookup field F1CN\_OPT\_TYP\_FLG.

Option	Description
<b>Outage Call Contact Name Characteristic Type</b>	This is used to link the contact name of the caller associated with an outage call as a characteristic on the outage call. Refer to <a href="#">Defining Service Order Options</a> for more information. Only one value is allowed for this option.
<b>Outage Call Contact Number Characteristic Type</b>	This is used to link the contact number of the caller associated with an outage call as a characteristic on the outage call. Refer to <a href="#">Defining Service Order Options</a> for more information. Only one value is allowed for this option.
<b>Outage Call Identifier Characteristic Type</b>	This is used to link the call identifier supplied by the caller associated with an outage call as a characteristic on the outage call. Refer to <a href="#">Defining Service Order Options</a> for more information. Only one value is allowed for this option.
<b>Outage Call Street Name Characteristic Type</b>	This is used to link the street name supplied by the caller associated with a fuzzy trouble call as a characteristic on the outage call. Refer to <a href="#">Defining Service Order Options</a> for more information.

	Only one value is allowed for this option.
<b>Outage Call Cross Street Name Characteristic Type</b>	This is used to link the cross street name supplied by the caller associated with a fuzzy trouble call as a characteristic on the outage call. Refer to <a href="#">Defining Service Order Options</a> for more information. Only one value is allowed for this option.
<b>Outage Call Block Number Characteristic Type</b>	This is used to link the block number supplied by the caller associated with a fuzzy trouble call as a characteristic on the outage call. Refer to <a href="#">Defining Service Order Options</a> for more information. Only one value is allowed for this option.
<b>Outage Call City Characteristic Type</b>	This is used to link the city supplied by the caller associated with a fuzzy trouble call as a characteristic on the outage call. Refer to <a href="#">Defining Service Order Options</a> for more information. Only one value is allowed for this option.
<b>Outage Call State Characteristic Type</b>	This is used to link the state supplied by the caller associated with a fuzzy trouble call as a characteristic on the outage call. Refer to <a href="#">Defining Service Order Options</a> for more information. Only one value is allowed for this option.

## Message Formats

Oracle Utilities Meter Data Management supports three core transactional data imports: Initial Measurement Data, Device Event Data, and Usage Transactions. To see the appropriate format for each of these imports please see the following:

- **Initial Measurement Data:** Please see the IMD Seeder (D1-IMDSeeder) business object for the appropriate format
- **Device Events:** Please see the Device Event Seeder (D1-DeviceEventSeeder) business object for the appropriate format
- **Usage Transactions:** Please see the Usage Transaction Seeder (D2-UsgTranSeeder) business object for the appropriate format\*

## Data Import - Message Driven Bean Configuration

### Overview

This section describes the steps for configuring the Message Driven Bean (MDB) feature of Oracle Utilities Meter Data Management and Oracle Utilities Smart Grid Gateway to listen to inbound JMS messages. This feature is used when importing IMDs and device events from head-end systems or when receiving Usage Transactions from CIS.

### JMS Configuration

JMS configuration involves setting up JMS queues which will received inbound usage readings and device events. The JMS queues need to be created first on the application server where the OSB component is deployed. This server is referred to as remote server in the sections below. In the following section the JMS queue on the remote server is assumed to be created with the name **DestinationQueueWatch-CM**.

Note: The JMS changes described in the following sections are not persistent during patches or upgrades. They will need to be re-created after applying any patches or upgrades to Oracle Utilities Smart Grid Gateway. It is recommended to keep a backup of the `$SPLBASE/splapp/config.xml` file.

## Create a new JMS Module

Log in to the Oracle Utilities Smart Grid Gateway Weblogic console and create a JMS Module with an appropriate name. Specify the following values for this JMS module:

- **Name:** the name of JMS module. For example, JMSModule-CM
- **Target:** the name of the target server where the Oracle Utilities Smart Grid Gateway application is running. This should be specified as myserver.

## Create a Foreign JMS Server

Create a Foreign JMS server under the JMS module created in the above step. Specify the following values for this foreign JMS server:

- **Name:** Name of the foreign server. For example, JMSFAServer-CM
- **Target:** This should be specified as myserver
- **JNDI Initial Context Factory:** This should be specified as weblogic.jndi.WLInitialContextFactory
- **JNDI Connection URL:** The URL of the server where OSB is deployed. For example: t3://osbserver:7001
- **JNDI Properties Credential:** Password for the OSB server user.
- **JNDI Properties:** The java.naming.security.principal additional property should be specified and set to the OSB server user. For example, java.naming.security.principal=weblogic

## Create a Foreign Destination

Create a Foreign destination for each remote queue. Specify the following values for this foreign destination:

- **Name:** Name of foreign destination. For instance, DestinationQueue-CM
- **Local JNDI Name:** Local JNDI name for the foreign JMS queue. For example, ForeignDestinationQueue-CM
- **Remote JNDI Name:** JNDI name of the queue on the remote server. For example, DestinationQueueWatch-CM

## Create a Remote Connection Factory

Create a remote connection factory for the foreign JMS server. Specify the following values for this remote connection factory:

- **Name:** Name of remote connection factory. For example, DestinationQueueConnectionFactory-CM
- **Local JNDI Name:** Local JNDI name for the Remote Connection Factory. For example, ForeignDestinationQueueConnectionFactory-CM
- **Remote JNDI Name:** JNDI name of the JMS Connection Factory on the remote server. For example, weblogic.jms.XAConnectionFactory

## Message Driven Bean Configuration

Configuration of message driven beans (MDB) involved modifying the **ejb-jar.xml** and **weblogic-ejb-jar.xml** configuration files delivered with Oracle Utilities Smart Grid Gateway. It is recommended that instead of modifying these files directly you create "Customer Modification" (CM) versions of these files to make changes to these configuration files. This ensures that your modifications are not overwritten by future application patches.

The following section describes the changes required in the CM files for configuring the MDBs to read from the foreign JMS queues set up in the steps above. This requires creating the following files under \$\$PLEBASE/templates:

- cm\_ejb-jar.xml.wls.jms\_1.include

- cm\_ejb-jar.xml.wls.jms\_2.include
- cm\_weblogic-ejb-jar.xml.jms.include.

**Note:** After making these changes the initialSetup script needs to be run and Oracle Utilities Smart Grid Gateway application needs to be redeployed. However the initialSetup script will overwrite the JMS configuration changes made in the steps above. So it is recommended to keep a backup of the \$SPLEBASE/splapp/config.xml file before running this script.

## Changes to cm\_ejb-jar.xml.wls.jms\_1.include

The following is an example of the cm\_ejb-jar.xml.wls.jms\_1.include file:

```
<message-driven>
  <description>MDB for DestinationQueue-CM</description>
  <display-name>DestinationQueueWatcher-CM</display-name>

  <ejb-name>DestinationQueueWatch-CM</ejb-name>

  <ejb-class>com.splwg.ejb.mdb.MessageProcessor</ejb-class>
  <messaging-type>javax.jms.MessageListener</messaging-type>
  <transaction-type>Bean</transaction-type>
  <message-destination-type>javax.jms.Queue</message-destination-type>
</message-driven>
```

The values specified in the above file include the following:

- **ejb-name:** This is the name of the MDB.

## Changes to cm\_ejb-jar.xml.wls.jms\_2.include

The following is an example of the cm\_ejb-jar.xml.wls.jms\_2.include file:

```
<assembly-descriptor>
  <security-role>
  <role-name>cisusers</role-name>
  </security-role>
  <container-transaction>
  <method>

  <ejb-name>DestinationQueueWatch-CM</ejb-name>

  <method-name>onMessage</method-name>
  </method>
  <trans-attribute>NotSupported</trans-attribute>
  </container-transaction>
</assembly-descriptor>
```

The values specified in the above file include the following:

- **ejb-name:** This is the name of the MDB

## Changes to cm\_ejb-jar.xml.wls.jms\_2.include

The following is an example of the cm\_weblogic-ejb-jar.xml.jms.include file:

```
<weblogic-enterprise-bean>
<ejb-name>DestinationQueueWatch-CM</ejb-name>

  <message-driven-descriptor>
  <pool>
  <max-beans-in-free-pool>5</max-beans-in-free-pool>
  <initial-beans-in-free-pool>1</initial-beans-in-free-pool>
  </pool>

<destination-jndi-name>ForeignDestinationQueue-CM</destination-jndi-name>
```

```
<connection-factory-jndi-name>ForeignConnectionFactory-CM</connection- factory-jndi-name>
</message-driven-descriptor>
</weblogic-enterprise-bean>
```

The values specified in the above file include the following:

- **ejb-name:** This should be the name of the MDB as specified in ejb-jar.xml
- **destination-jndi-name:** This should be the JNDI name of the foreign destination as provided in JMS module ' Foreign server ' Foreign destination ' Local JNDI name.
- **connection-factory-jndi-name:** This should be the JNDI name of the connection factory as provided in JMS module ' Foreign server ' Remote Connection Factory ' Local JNDI name.

## Notification Queue Configuration

Payload statistics and payload summary records must be submitted sequentially in order for them to be processed correctly. To prevent them from being processed at the same time, you should set the number of notification queue polling threads to

1. Follow these steps to configure the number of notification queue threads:

1. Log in to the WebLogic Server Administration Console.
2. Under Helpful Tools, click **Configure Applications**.
3. Click on **SPLService**.
4. Click on the NotificationQueue link. for the EJB that you want to configure.
5. Go to the Configuration tab.
6. In the Change Center, click **Lock & Edit**.
7. Specify the new value of polling threads in **Max Beans in Free Pool**.
8. Click **Save**.
9. Click **Release Configuration**.
10. Restart the OUAF WebLogic instance.

## The Conversion Tool

This section describes the Oracle Utilities Customer Care and Billing conversion tool.

### Introduction

When you're ready to convert data from your legacy system into Oracle Utilities Customer Care and Billing, you will have analyzed your CIS processing requirements according to your business and organizational needs and set up the control tables accordingly.

---

**FASTPATH:**

Refer to the **Administration Guide** for a complete discussion of the various control tables and the order in which they must be set up.

---

After the control tables are set up, you are ready to load data into the system from your legacy system. This conversion effort involves several steps as illustrated in the following diagram:

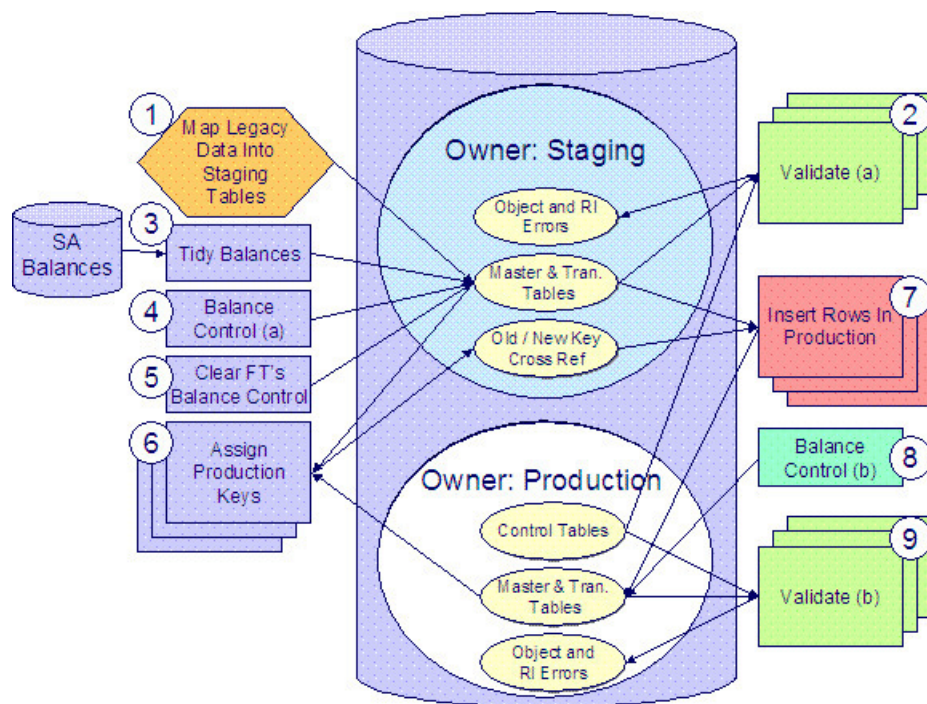

The following points briefly outline each of the above tasks:

- **Map Legacy Data Into Staging.** During this step, your legacy master data (e.g., account, person, premise, meter) and transaction data (e.g., bills, payments, meter reads) is migrated into the system. Notice that you are not migrating this data directly into production. Rather, your rows are loaded into tables that are identical to the production tables; they just have a different owner. Refer to [Appendix B - Multiple Owners In A Single Database](#) for information about table ownership.

**WARNING:**

The above diagram illustrates how the system is configured to support the conversion effort in the standard installation, i.e., the staging tables are in the same database as the production tables (each with a different owner). However, it is possible for the staging tables to be in a separate database. This option requires additional effort on your part (because you would have to copy the control tables from production into your staging database). Please refer to [Appendix B - Multiple Owners In A Single Database](#) for information about this alternative.

Mapping legacy data into the system is probably the most challenging part of the conversion process because the system is a normalized database (and most legacy applications are not).

- **Validate (a).** During the validation (a) step, the system validates the data you loaded into the staging tables. Two types of validation programs exist:
  - **Object Validation Programs.** Each of the system's master data objects (e.g., person, account, premise, meter, etc.) is validated using the same logic that is used to validate data added by users in your production system.
  - **Referential Integrity Validation Programs.** After you have successfully validated the master data objects, the referential integrity validation programs are executed to validate transaction data and to highlight "orphaned" rows. These programs check the validity of the foreign keys on all rows on all tables.

**NOTE:**

**Control tables from production.** It's important to notice that the validation programs validate your staging data using the control tables that have been set up in production. Refer to [Appendix B - Multiple Owners In A Single Database](#) for a description of how this works.

---

- **Tidy Balances.** During this step, the system creates adjustments that cause each SA's current and payoff balances to equal the desired balances. The desired balances are supplied on a flat file prepared by you.
- **Balance Control (a).** During this step, you run the balance control program and then verify that the balances that it generates are consistent with the balances in your legacy system.
- **Clear FT's Balance Control.** In the previous step, the system creates a balance control and links it to the FT's. If the balance control's balances are consistent with the amount of receivables being transferred into the system, you should run the Clear FT's Balance Control program. This program simply resets the Balance Control column on the FT so that the FT's can be included in a balance control (see the last step below) after they have been transferred to production.
- **Assign Production Keys.** During this step, the system allocates random, clustered keys to the rows in the staging database.
- **Insert Rows Into Production.** During this step, the system populates your production tables with rows from the staging. When the rows are inserted, their prime keys are reassigned using the data populated in the previous step.
- **Balance Control (b).** During this step, you run the balance control program against production. You do this to verify the balances in production are consistent with the values of receivables converted from your legacy application.
- **Validate (b).** During this step, you rerun the object validation programs, but this time against production. We recommend rerunning these programs to confirm that the insertion programs have executed successfully. We recommend running these programs in random sample mode (e.g., validate every 1000th object) rather than conducting a full validation in order to save time. However, if you have time, you should run these programs in full validation mode (to validate every object).

## Conversion Tool Steps

The following sections provide more details about the steps in the conversion process.

### Map Legacy Data Into Staging Tables

This section provides some high level discussion about mapping legacy data to the system's staging tables. Refer to [The Staging Tables](#) for details about the staging tables in the system.

---

**NOTE:**

**Recommendation.** You can use any method you prefer to load Oracle Utilities Customer Care and Billing data from your legacy application. However, we recommend that you investigate your database's mass load utility (as opposed to using insert statements) as the mechanism to load the staging tables. In addition, we strongly recommend that you disable the indexes on these tables before populating these tables and then enable the indexes after populating these tables.

---

**Populating Characteristic Tables.** There are many maintenance objects that include a characteristic table used to capture miscellaneous information about the object, e.g. Person, Account, Service Agreement, etc. Most of these tables include an indexed column used when searching by characteristic value called Search Characteristic Value. During conversion and depending on the type of characteristic, this column must be populated as follows:

- **Predefined:** Populate search characteristic value with the contents of the characteristic value column converted to upper case.



- Ad hoc: Populate search characteristic value with the first 50 bytes of the ad hoc characteristic value column converted to upper case.
- Foreign key: Populate search characteristic value by concatenating the values of each foreign key characteristic value column to a maximum of 50 bytes.

## A Note About Keys

The prime keys of the tables in the staging database are either system-assigned random numbers or they aren't. Those tables that don't have system-assigned random numbers have keys that are a concatenation of the parent's prime-key plus one or more additional fields.

Every table whose prime key is a system-assigned random number has a related table that manages its keys; we refer to these secondary tables as "key tables". The following points provide more information about the key tables:

- Key tables are used by programs that allocate new keys. For example, before a new account ID is allocated, the key assignment program checks the account key table to see if it exists.
- Key tables only have two columns:
  - The key of the object.
  - An environment ID. The environment ID identifies the database in which the object resides.
- Key tables are named the same as their primary table with a suffix of "\_K". For example:
  - The key table for CI\_ACCT is CI\_ACCT\_K
  - The key table for CI\_PREM is CI\_PREM\_K
- The name of every table's key table is defined under the Generated Keys column in the Table Names sections in [The Staging Tables](#).
- When you populate rows in tables with system-assigned keys, you must also populate a row in the related key table. For example, if you insert a row into CI\_ACCT, you must also insert a row into CI\_ACCT\_K. The environment ID of these rows must be the same as the environment ID on this database's [installation record](#).
  - When you populate rows in tables that reference this record as a foreign key, you must use the appropriate key to ensure the proper data relationships. For example, if you insert a row in CI\_SA for the above account, the ACCT\_ID column must contain the temporary account key.
- When you insert rows into your staging database, the keys do not have to be random, system-assigned numbers. They just have to be unique. A later process, [Allocate Production Keys](#), will allocate random, system-assigned keys prior to production being populated.

## Validate Information In The Staging Tables

During the first validation step, the system validates the data you loaded into the staging tables. Two types of validation programs exist:

- **Object Validation Programs.** The object validation programs validate each of the system's master data objects (e.g., person, account, premise, meter, etc.) and a limited number of transaction data objects (e.g., field activity, field order, etc.). Please note that these programs call the same programs that are used to validate data added by users in your production system.
- **Referential Integrity Validation Programs.** After the master data objects have been validated, the referential integrity validation programs are executed to validate transaction data and to highlight "orphaned" rows. These programs simply check the validity of the foreign keys on all rows on all tables.

The contents of this section describe how to execute the validation programs.

## Object Validation Programs

Each of the objects described under [Master Data](#) must be validated using the respective object validation program indicated in its Table Names section.

In a limited number of cases object validation is available for [Transaction Data](#) objects, where customers may convert transaction data that is still pending. For example, if you are converting pending field activities, you want to ensure that the data is valid. For these cases you may also be converting historic records. For example, in addition to the pending field activities you are converting completed field activities to keep a historic view. You may not want to perform validation on completed records. As a result the background processes provided for transaction data allow you to limit the validation to records in a give status.

We strongly recommend validating each object in the following steps:

- Execute each object's validation program in random-sample mode to highlight pervasive errors. When you execute a validation in random-sample mode, you are actually telling it to validate every X records (where X is a parameter that you supply to the job). Refer to [Submitting Object Validation Programs](#) for more information about the parameters supplied to these background processes.
- You can view errors highlighted by validation programs using the [Validation Error Summary](#) transaction.
- Correct the errors using SQL. Note, you can use the base package's transactions (e.g., Person Maintenance, Premise Maintenance, etc.) to correct an error if the error isn't so egregious that it prevents the object from being displayed on the browser.
- After all pervasive errors have been corrected; re-execute each object's validation program in all-instances mode to highlight elusive, one-off errors. Refer to [Submitting Object Validation Programs](#) for more information about the parameters supplied to these background processes.

---

### WARNING:

Whenever an object validation program is run, it is necessary to delete all previously recorded errors associated with its tables from the validation error table before it inserts new errors.

---

After the various object validation programs run cleanly, run the referential integrity validation programs as described in the next section.

---

### NOTE:

**Another use for these programs.** In addition to validating your objects after conversion or an upgrade, the validation programs are another use. Say for example, you want to experiment with changing the validation of a person and you want to determine the impact of this new validation on your existing persons. You could change the validation and then run the person validation object - it will produce errors for each person that fails the new validation.

---

## Submitting Object Validation Programs

The object validation programs that are described in the [staging tables](#) table names matrices are classic background processes as they can also be run against production data. You submit these processes in the same way you submit any background process in production.

## Referential Integrity Validation Programs

It's important to understand that only master data objects (e.g., persons, accounts, meters, premises, etc.) are validated by the object validation programs discussed above. This means that only master data objects will have their foreign keys checked for validity by the object validation programs. You must run the referential integrity programs to validate all other data.

The referential integrity validation programs highlight:

- Orphaned rows because orphan rows, by definition, don't reference an object.
- Invalid foreign keys on transaction data.

---

**NOTE:**

**Validating Transaction Data.** You may wonder why transaction data is not subject to the object validation routines. This is because: a) the production system only needs validation logic for master data because transaction data is not entered by users, and b) most conversions necessitate loading skeletal transaction data because the legacy system typically doesn't contain enough information to create accurate transactions in the system.

---

Each of the tables described under [Transaction Data](#) must be validated using the respective referential integrity validation program indicated in its Table Names section. We strongly recommend validating each table in the following steps:

- Execute each table's referential integrity validation program. Refer to [Submitting Referential Integrity Validation Programs](#) for more information about the parameters supplied to these background processes.
- You can view errors highlighted by this process using the [FK Validation Summary](#) transaction.
- Correct the errors using SQL (you cannot use the application to correct these types of errors).
- Rerun the referential integrity programs until no errors are produced.

---

**WARNING:**

Whenever you run a referential integrity validation program, it deletes all errors associated with its table from the referential integrity error table.

---

In order to highlight orphaned rows in the master data, run the referential integrity validation programs against all tables described under [Master Data](#) using the procedure described above.

When ALL referential integrity programs indicate the staging database is clean, you may now proceed to the next step - [tidy balances](#).

## Submitting Referential Integrity Validation Programs

The referential integrity validation programs described under [Master Data](#) and [Transaction Data](#) (in the Table Names matrices) are submitted using a batch driver program, CIPVRNVB, and this program is executed in the staging database. Please note that the referential integrity validation programs may also be run in the production environment on occasion, to determine the integrity of data in the production database.

You should supply the following parameters to this program:

- **Batch code.** The batch code associated with the appropriate table's referential integrity validation program. Refer to each table listed under [Master Data](#) and [Transaction Data](#) (in the Table Names matrices) for each referential integrity batch code / program.
- **Batch thread number.** Thread number is not used and should be left blank.
- **Batch thread count.** Thread count is not used and should be left blank.
- **Batch rerun number.** Rerun number is not used and should be left blank.
- **Batch business date.** Business date is the date supplied to the referential integrity validation programs and the date under which statistics will be logged.

- **Total number of commits.** Total number of commits is not used and should be left blank.
- **Maximum minutes between cursor re-initiation.** Maximum minutes between cursor re-initiation is not used and should be left blank.
- **User ID.** User ID is only used to log statistics for the execution of the batch job.
- **Password.** Password is not used.
- **Language Code.** Language code is used to access language-specific control table values. For example, error messages are presented in this language code.
- **Trace program at start (Y/N), trace program exit (Y/N), trace SQL (Y/N) and output trace (Y/N).** These switches are only used during QA and benchmarking. If trace program start is set to Y, a message is displayed whenever a program is started. If trace program at exist is set to Y, a message is displayed whenever a program is exited. If trace SQL is set to Y, a message is displayed whenever an SQL statement is executed.

## Recommendations To Speed Up Validation Programs

The following points describe ways to accelerate the execution of the validation programs:

- Ensure that statistics are recalculated after data has been inserted into the staging tables. For Oracle users, we strongly recommend using the Oracle-provided PL/SQL package to generate statistics rather than the analyze command.
- [Object validation programs](#) should be run multi threaded.
- Execute shorter running validation processes (e.g., less records) first so that the error data can be analyzed while other processes are busy running.
- [Referential integrity validation programs](#) run fairly quickly without much tuning. However, additional benefits are gained by running several programs at the same time.
- Remember that the [object validation programs](#) can be run in "validate every n th row". We recommend running these programs using a largish value for this parameter until the pervasive problems have been rectified.

## Tidy Balances

This background process creates adjustments that cause each SA's current and payoff balances to equal its balance in the legacy system (note: the batch control ID of CNV-BAL is used for this process).

### NOTE:

**Submitting this process.** You submit this process in the staging database. Refer to [Tidy Balances](#) for a description of this process and its parameters.

You supply the desired balances to this background process in a flat file in the following format:

Field	Size	Description
SA ID	X10	The unique identifier of the service agreement
Payoff Balance Sign	X1	Positive or Negative value indicates debit or credit balance respectively
Payoff Balance	N15.2	The SA's payoff balance (how much the customer really owes).
Current Balance New Charge Sign	X1	Positive or Negative value indicates debit or credit balance respectively

Current Balance - New Charge	N15.2	The amount of the SA's current balance that is considered a new charge, i.e., it hasn't started aging yet.
Current Balance Amount 1 Sign	X1	Positive or Negative value indicates debit or credit balance respectively
Current Balance - Amount 1	N15.2	The amount of the SA's current balance that is X days old (X is defined in the next field)
Age of Current Balance - Amount 1	N3	The number of days old the prior field is (if you keep your debt in "buckets" as opposed to knowing the exact number of days it has aged, you will have to choose an exact age). Set this value to zero if the value of amount 1 should be considered a "new charge" (i.e., it should only start aging when it is swept onto the next bill produced for the SA's account)
Current Balance Amount 2 Sign	X1	Positive or Negative value indicates debit or credit balance respectively
Current Balance - Amount 2	N15.2	The amount of the SA's current balance that is X days old (X is defined in the next field)
Age of Current Balance - Amount 2	N3	The number of days old the prior field is (if you keep your debt in "buckets" as opposed to knowing the exact number of days it has aged, you will have to choose an exact age)
Current Balance Amount 3 Sign	X1	Positive or Negative value indicates debit or credit balance respectively
Current Balance - Amount 3	N15.2	The amount of the SA's current balance that is X days old (X is defined in the next field)
Age of Current Balance - Amount 3	N3	The number of days old the prior field is (if you keep your debt in "buckets" as opposed to knowing the exact number of days it has aged, you will have to choose an exact age)
Current Balance Amount 4 Sign	X1	Positive or Negative value indicates debit or credit balance respectively
Current Balance - Amount 4	N15.2	The amount of the SA's current balance that is X days old (X is defined in the next field)
Age of Current Balance - Amount 4	N3	The number of days old the prior field is (if you keep your debt in "buckets" as opposed to knowing the exact number of days it has aged, you will have to choose an exact age)
Current Balance Amount 5 Sign	X1	Positive or Negative value indicates debit or credit balance respectively
Current Balance - Amount 5	N15.2	The amount of the SA's current balance that is X days old (X is defined in the next field)
Age of Current Balance - Amount 5	N3	The number of days old the prior field is (if you keep your debt in "buckets" as opposed to knowing the exact number of days it has aged, you will have to choose an exact age)

---

**NOTE:**

**Submitting this process.** You submit this process in the staging database. Refer to [Tidy Balances](#) for a description of this process and its parameters.

---

## Balance Control (a)

During this step, you run the balance control programs and then verify that the balances that it generates are consistent with the balances in your legacy system.

---

**NOTE:**

**Submitting this process.** You submit this process in the staging database. Refer to [The Big Picture of Balance Control](#) for more information about the balance control processes. Refer to [Balance Control](#) for information about the page used to view the balances generated by this process.

---

## Clear FT Balance Control

In the previous step, the system created a balance control and links it to the FT's. If the balance control's balances are consistent with the amount of receivables being transferred into the system, you should run the Clear FT's Balance Control program. This program simply resets the Balance Control column on the FT so that the FT's can be included in a balance control (see the last step below) after they have been transferred to production. Note: the batch control ID of CNV-BCG is used to request this process.

---

**NOTE:**

**Submitting this process.** You submit this process in the staging database. Refer to [Reset Balances](#) for a description of this process and its parameters.

---

## Allocate Production Keys

The topics in this section describe the background processes used to assign production keys to the staging data.

## The Big Picture of Key Assignment

It's important to understand that the system does not overwrite the prime-keys on the rows in the staging database, as this is a very expensive IO transaction. Rather, a series of tables exist that hold each row's old key and the new key that will be assigned to it when the row is [transferred into the production database](#). We refer to these tables as the "old key / new key" tables. The old key / new key tables are named the same as their primary table, but rather than being prefixed by "CI", they are prefixed by "CK". For example, the old key / new key table for CI\_ACCT is called CK\_ACCT.

The insertion programs that transfer the rows into the production database use the new key for the main record of the key along with any other record where this key is a foreign key. Note that the capability of assigning the new key to a foreign key applies to

- "True" foreign keys, i.e. where the key is a column in another table. For example, CI\_SA has a column for ACCT\_ID.
- FK reference characteristics. These are characteristics that define, through an FK reference, the table and the key that this characteristic represents.

The insertion programs are not able to assign "new keys" to foreign keys defined in an XML structure field (CLOB).

The key assignment programs listed under [Master Data](#) and [Transaction Data](#) (in the table names sections) are responsible for populating the old key / new key tables (i.e., you don't have to populate these tables). Because the population of the rows in these tables is IO intensive, we have supplied detailed instructions that will accelerate the execution time of these programs.

---

**NOTE:**

**Why are keys reassigned?** The conversion process allocates new prime keys to take advantage of the system's parallel processing and data-clustering techniques in the production system (these techniques are dependent on randomly assigned, clustered keys).

**Iterative conversions.** Rather than perform a "big bang" conversion (one where all customers are populated at once), some implementations have the opportunity to go live on subsets of their customer base. If this describes your implementation, please be aware that the system takes into account the existing prime keys in the production database before it allocates a new key value. This means when you convert the next subset of customers, you can be assured of getting clean keys.

**Program Dependencies.** The programs used to assign production keys are listed in the Table Names matrices. Most of these programs have no dependencies (i.e., they can be executed in any order you please). The exceptions to this statement are noted in [Program Dependencies](#).

---

## Submitting Key Assignment Programs

The key assignment programs described under [Master Data](#) and [Transaction Data](#) (in the Table Names matrices) are submitted using a batch driver program, CIPVRNKB, and this program is executed in the staging database. You should supply the following parameters to this program:

- **Batch code.** The batch code associated with the appropriate table's key assignment program. Refer to each table listed under [Master Data](#) and [Transaction Data](#) (in the Table Names matrices) for each key assignment batch code / program.
- **Batch thread number.** Thread number is not used and should be left blank.
- **Batch thread count.** Thread count is not used and should be left blank.
- **Batch rerun number.** Rerun number is not used and should be left blank.
- **Batch business date.** Business date is the date supplied to the key assignment programs and the date under which statistics will be logged.
- **Total number of commits.** Total number of commits is not used and should be left blank.
- **Maximum minutes between cursor re-initiation.** Maximum minutes between cursor re-initiation is not used and should be left blank.
- **User ID.** User ID is only used to log statistics for the execution of the batch job.
- **Password.** Password is not used.
- **Language Code.** Language code is used to access language-specific control table values. For example, error messages are presented in this language code.
- **Trace program at start (Y/N), trace program exit (Y/N), trace SQL (Y/N) and output trace (Y/N).** These switches are only used during QA and benchmarking. If trace program start is set to Y, a message is displayed whenever a program is started. If trace program at exist is set to Y, a message is displayed whenever a program is exited. If trace SQL is set to Y, a message is displayed whenever an SQL statement is executed.
- **Mode.** The proper use of this parameter will greatly speed up the key assignment step as described under [Recommendations To Speed Up Key Generation](#). This parameter has three values:

- If you supply a mode with a value of I (initial key generation), the system allocates new keys to the rows in the staging tables (i.e., it populate the respective old key / new key table).
- If you supply a mode with a value of D (resolve duplicate keys), the system reassigns keys that are duplicates.
- If you supply a mode with a value of B (both generate keys and resolve duplicates), the system performs both of the above steps. This is the default value if this parameter is not supplied.
- Please see [Recommendations To Speed Up Key Generation](#) for how to use this parameter to speed up the execution of these processes.

---

**NOTE:**

**Parallel Key Generation.** No key generation program should be run (either in mode I or B ) while another program is being run unless that program is in the same tier (see [Program Dependencies](#) for a description of the tiers).

---

- **Start Row Number.** This parameter is only used if you are performing conversions where data already exists in the tables in the production database (subsequent conversions). In an Oracle database the key assignment routines create the initial values of keys by manipulation of the Oracle row number, starting from 1. After any conversion run, a subsequent conversion run will start with that row number again at 1, and the possibility of duplicate keys being assigned will be higher. The purpose of this parameter is to increase the value of row number by the given value, and minimize the chance of duplicate key assignment.

## Recommendations To Speed Up Key Generation Programs

The following points describe ways to accelerate the execution of the key generation programs.

---

**NOTE:**

**Naming convention.** The convention "CK\_<table\_name>" is used to denote the old key / new key tables described under [The Big Picture of Key Assignment](#).

---

- Make the size of your rollback segments large. The exact size is dependent on the number of rows involved in your conversion. Our research has shown that processing 7 million rows generates roughly 3GB of rollback information.
  - Setup the rollback segment(s) to about 10GB with auto extend to a maximum size of 20GB to determine the high water mark
  - A next extent value on the order of 100M should be used.
- Make sure to turn off all small rollback segments (otherwise Oracle will use them rather than the large rollback segments described above).
- After the key assignment programs execute, you can reclaim the space by:
  - Keep a low value for the "minimum extent" parameter for the rollback.
  - Shrink the rollback segments and the underlying data files at the end of the large batch jobs.
- Compute statistics on the CK\_<table\_name> tables after every 50% increase in table size. Key generation is performed in tiers or steps because of the inheritance dependency between some tables and their keys. Although key generation for the tier currently being processed is performed by means of set-based SQL, computation of statistics between tiers will allow the database to compute the optimum access path to the keys being inherited from the **previous** tier's generation run. For Oracle users, we strongly recommend using the Oracle-provided PL/SQL package to generate statistics rather than the analyze command.
- Optimal use of the **Mode** parameter under [Submitting Key Assignment Programs](#).
  - Before any key assignments, alter both the "old key" CX\_ID index and the "new key" CI\_ID index on the CK\_<table\_name> tables to be unusable.



- Run all [key assignment tiers](#), submitting each job with MODE = "I".
- Rebuild the CX\_ID and CI\_ID indexes on the CK\_<table\_name>. Rebuilding the indexes using both the PARALLEL and NOLOGGING parameters will speed the index creation process in an Oracle DB. Statistics should be computed for these indexes.
- Run all key assignment tiers that were previously run in MODE = 'I', submitting each job with MODE = "D". This will reassign all duplicate keys.

## Insert Production Data

The topics in this section describe the background processes used to populate the production database with the information in the staging database.

## The Big Picture Of Insertion Programs

All insertion programs are independent and may run concurrently. Also note, all insertion programs can be run in many parallel threads as described in the next section (in order to speed execution).

## Submitting Insertion Programs

The insertion programs described under [Master Data](#) and [Transaction Data](#) (in the Table Names matrices) are submitted using a batch driver program, CIPVRNIB, and this program is executed in the staging database. You should supply the following parameters to this program:

- **Batch code.** The batch code associated with the appropriate table's insertion program. Refer to each table listed under [Master Data](#) and [Transaction Data](#) (in the Table Names matrices) for each insertion batch code / program.
- **Batch thread number.** Thread number contains the relative thread number of the process. For example, if you want to insert accounts into production in 20 parallel threads, each of the 20 execution instances receives its relative thread number (1 through 20). Refer to [Parallel Background Processes](#) for more information.
- **Batch thread count.** Thread count contains the total number of parallel threads that have been scheduled. For example, if the account insertion process has been set up to run in 20 parallel threads, each of the 20 execution instances receives a thread count of 20. Refer to [Parallel Background Processes](#) for more information.
- **Batch rerun number.** Rerun number is not used and should be left blank.
- **Batch business date.** Business date is the date supplied to the insertion programs and the date under which statistics will be logged.
- **Total number of commits.** This is the number of commits IN TOTAL that you want to perform. For example, if you have 1,000,000 accounts and you supply a value of 100; then a commit will be executed for approximately every 10,000 accounts.
- **Maximum minutes between cursor re-initiation.** This should only be populated if you want to override the default value of 15.
- **User ID.** User ID is only used to log statistics for the execution of the batch job.
- **Password.** Password is not used.
- **Language Code.** Language code is used to access language-specific control table values. For example, error messages are presented in this language code.

- **Trace program at start (Y/N), trace program exit (Y/N), trace SQL (Y/N) and output trace (Y/N).** These switches are only used during QA and benchmarking. If trace program start is set to Y, a message is displayed whenever a program is started. If trace program at exist is set to Y, a message is displayed whenever a program is exited. If trace SQL is set to Y, a message is displayed whenever an SQL statement is executed.

## Recommendations To Speed Up Insertion Programs

The following points describe ways to accelerate the execution of the insertion programs:

- Before running the first insertion program:
  - Rebuild the index on the prime key on the old key / new key table (i.e., those tables prefixed with "CK").
  - Re-analyze the statistics on the old key / new key table (i.e., those tables prefixed with "CK"). For Oracle users, we strongly recommend using the Oracle-provided PL/SQL package to generate statistics rather than the analyze command.
  - Alter all indexes on the production tables being inserted into to be unusable.
- After the insertion programs have populated production data, rebuild the indexes and compute statistics for these tables. For Oracle users, we strongly recommend using the Oracle-provided PL/SQL package to generate statistics rather than the analyze command.

## Run Balance Control Against Production

During this step, you rerun the balance control program, but this time against production. You do this to verify the balances in production are consistent with the values of receivables converted from your legacy application.

---

**NOTE:**

**Submitting this process.** You submit this process in the production database. Refer to [The Big Picture of Balance Control](#) for more information about the balance control processes. Refer to [Balance Control](#) for information about the page used to view the balances generated by this process.

---

## Validate Production

During this step, you rerun the [object validation programs](#), but this time in production. We recommend rerunning these programs to confirm that the insertion programs have executed successfully. We recommend running these programs in random sample mode (e.g., validate every 1000 th object) rather than conducting a full validation in order to save time. However, if you have time, you should run these programs in full validation mode (to validate every object). Please refer to the various "Table Names" sections above for the respective names of the programs to run.

## The Validation User Interface

The topics in this section describe the various pages that assist in the conversion effort.

## Validation Error Summary

Navigate to **Admin > Conversion > Validation Error Summary** to view validation errors associated with the objects defined in [Master Data](#).

### Description of Page

You can use **Table Name** to restrict errors to a specific object. If this field is left blank, all errors on all objects will be displayed.

The grid contains a separate row for each type of error. The following information is displayed:

- **Table Name** is the name of the main table associated with the object.
- **Message Category** and **Message Number** define the type of error. These fields are the unique identifier of the message that describes the error (the verbiage of this message is displayed in the **Message Text** column).
- **Count** contains the number of records with this error. Press the Go To button to see the individual records with the error.

## Validation Error Detail

This page is used to view validation errors of a given type associated with one of the objects defined in [Master Data](#). This transaction is not intended to be invoked from the **Admin** menu. Rather, drill into the validation details from [Validation Error Summary](#).

### Description of Page

Use **Table Name**, **Message Category**, and **Message Number** to define the object and the type of error you wish to display. The grid contains a separate row for each object with the given type of error. The following information is displayed:

- **Table Name** is the name of the main table associated with the object.
- **Record Identifier** is the unique identifier of the object with the error (e.g., the person ID, the account ID, the premise ID, etc.). Press the Go To button to transfer to the maintenance page associated with the object.
- **Message Category** and **Message Number** define the type of error. These fields are the unique identifier of the message that describes the error (the verbiage of this message is displayed in the **Message Text** column).

## FK Validation Summary

Navigate to **Admin > Conversion > FK Validation Summary** to view foreign key validation errors associated with the objects defined in [Master Data](#).

### Description of Page

You can use **Table Name** to restrict errors to a specific object. If this field is left blank, all errors on all objects will be displayed.

The grid contains a separate row for each type of error. The following information is displayed:

- **Table Name** is the name of the main table associated with the object.
- **Count** contains the number of records on this table that have this error.
- **Foreign Key Field Names 1 to 6** contain the names of the foreign keys contained on this table that have been found to be in error.
- **Foreign Key Values 1 to 6** contain the values within the foreign key fields that are found to be in error.

## FK Validation Detail

This page is used to view foreign key validation errors of a given type associated with one of the objects defined in [Master Data](#). This transaction is not intended to be invoked from the **Admin** menu. Rather, drill into the validation details from [FK Validation Summary](#).

### Description of Page

Use **Table Name** to specify the table you wish to view. The names and values of the foreign key fields on the table are displayed. The grid that follows contains the primary key values of this table's records that are in error. The following information is displayed:

- **Table Name** is the name of the main table.
- **FK Fields 1 to 6** are the names of the foreign keys contained in this table. Displayed alongside the key names are the values within these fields. These identify records on other tables to which this table's record is related. For example, the CI\_PREM\_GEO record identified by its displayed primary keys should be related to a Premise record with the Premise ID shown - it appears in this list only if there is something amiss with this relationship.

## The Staging Tables

This section describes the objects into which your legacy data is mapped. For each object, we provide the following:

- A data model.
- An indication of which tables have system-assigned keys.
- The physical table names.
- The name of the batch control to submit to validate the object.
- The name of the program (and related batch control) that validates each table for referential integrity.
- The name of the program (and related batch control) that performs key assignment for each table.
- The name of the program (and related batch control) that inserts the table's rows into production from staging.
- Suggestions to assist in the conversion process.

---

#### WARNING:

We recommend you read this document on a browser (or using Word under windows) so you can take advantage of the [Color Coding](#).

---

#### NOTE:

**Column details do not appear in this document.** When you're ready to examine an object's tables, use the hyperlinks in the respective Table Names section to transfer to the [data dictionary](#). The data dictionary will show you the required columns, the foreign keys (and their related tables), the source code of the program that validates the contents of the table, and a host of other information that will assist the conversion process.

---

#### WARNING:

In the data models that appear below, you will find a variety of entities that are classified as either a control table or a lookup table. Please refer to [Color Coding](#) for more information about how to recognize such an entity.

---

## A Note About Programs in the Table Names Matrices

For each object described in the master data and transaction data sections, there is a "table names" section that includes a matrix listing the name of each table that is part of the maintenance object. Included in the matrix is information about the

programs provided to perform object validation, referential integrity validation, key assignment and insertion. The following are some points about these programs:

- One object validation program exists for the entire set of tables for the maintenance object. The **Object Validation Batch Control** column indicates the batch control used to submit the object validation. Refer to [Submitting Object Validation Programs](#) for more information. Drilling down on the hypertext allows you to see more information about the batch control, including the program associated with it.
- A referential integrity validation program exists for every table whose key includes a parent key of another object. As described in [Submitting Referential Integrity Validation Programs](#), these programs are submitted using a driver supplied by the system where the batch code for the appropriate table is provided. (The driver then executes the program whose name matches the batch code). The **Referential Integrity Validation Batch Control** column indicates the table's batch control / program name.
- One key assignment program exists for the parent table for the maintenance object. As described in [Submitting Key Assignment Programs](#), these programs are submitted using a driver supplied by the system where the batch code for the appropriate table is provided. (The driver then executes the program whose name matches the batch code). The **Key Assignment Batch Control** column indicates the table's batch control / program name.
- An insertion program exists for every table for the maintenance object. As described in [Submitting Insertion Programs](#), these programs are submitted using a driver supplied by the system where the batch code for the appropriate table is provided. (The driver then executes the program whose name matches the batch code). The **Insertion Batch Control** column indicates the table's batch control / program name.

## Master Data

This section describes the various "master data" objects (e.g., person, account, meter, etc.) that must be created before you can convert transaction data.

---

**NOTE:**

**Key Assignment Dictates The Order Of Conversion.** The following contents are listed in the order in which the objects should be converted in order to maintain referential integrity.

---

## Person

Each customer must have a person and an account object. This section describes the person object. Refer to [Account](#) for details about the account object.

## Person Data Model

The following data model illustrates the person object.

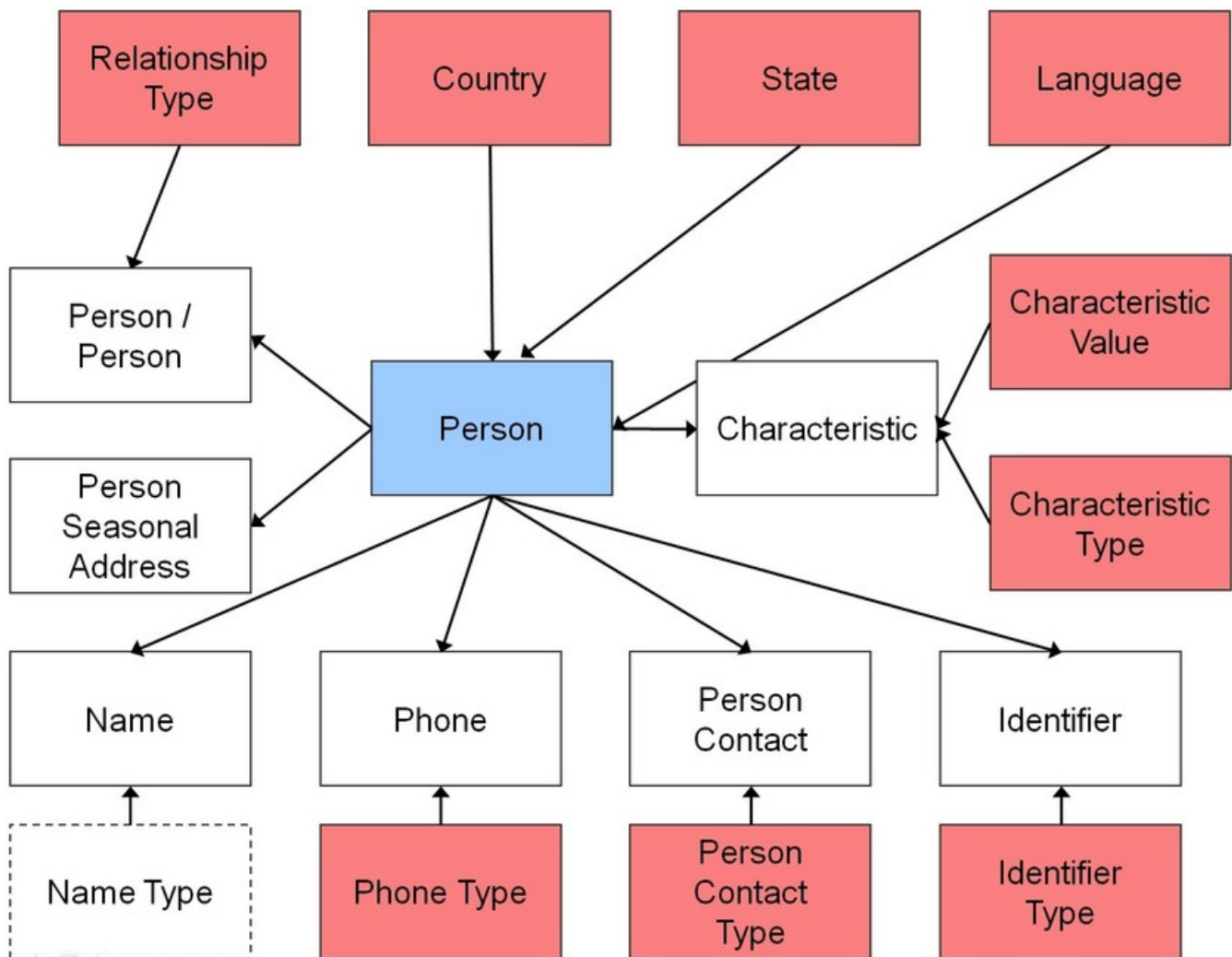

## Person Table Names

Data Model Name	Table Name	Generated Keys	Object Validation Batch Control	Referential Integrity Validation Batch Control	Key Assignment Batch Control	Insertion Batch Control
Person	CI_PER	Yes CI_PER_K	VAL-PER		CIPVPERK	CIPVPERI
Name	CI_PER_NAME	No. The key is PER_ID plus a sequence number.		CIPVPMNV		CIPVPMNI
Person / Person	CI_PER_PER	No. The key is PER_ID1, PER_ID2, relationship type and start date.		CIPVPEV		CIPVPEI

Phone	<a href="#">CI_PER_PHONE</a>	No. The key is PER_ID plus phone type.	CIPVPPHV	CIPVPPHI
Identifier	<a href="#">CI_PER_ID</a>	No. The key is PER_ID plus identifier type.	CIPVPIDV	CIPVPIDI
Characteristic	<a href="#">CI_PER_CHAR</a>	No. The key is PER_ID plus an edate and a char type.	CIPVPRCV	CIPVPRCI
Seasonal Address	<a href="#">CI_PER_ADDR_SEAS</a>	No. The key is PER_ID plus a sequence number.	CIPVPSAV	CIPVPSAI

## Person Suggestions

A person must have at least one row on the name table and at least one of the names must be marked as being the primary name.

A person must have at least one row on the identity table and at least one of the identities must be marked as being the primary ID.

The country and state are only necessary if the person has an override mailing address.

## Account

Each customer must have a person and an account object. This section describes the account object, refer to [Person](#) for details about the person object.

## Account Data Model

The following data model illustrates the account object.

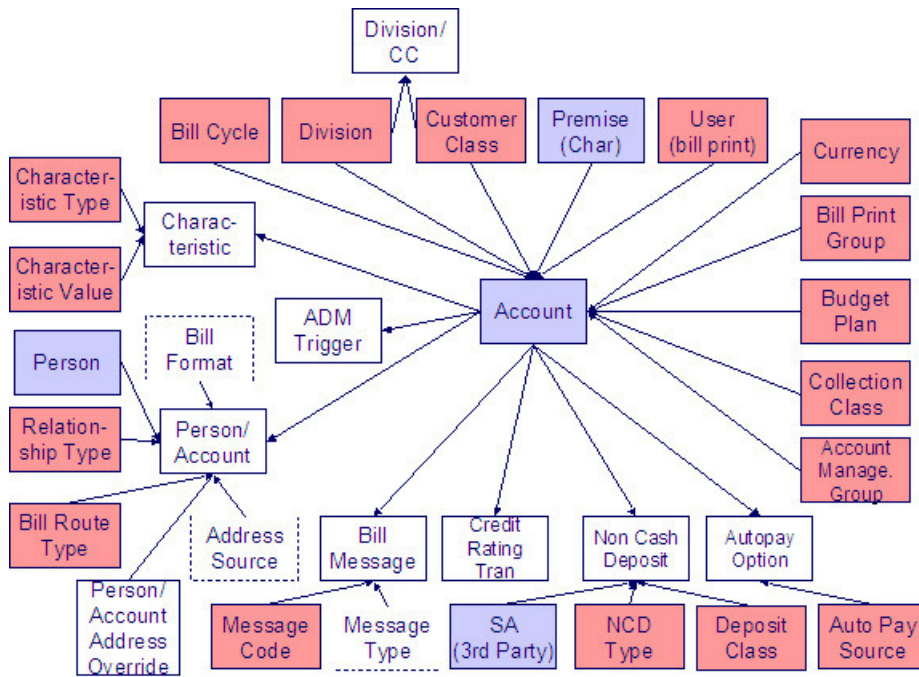

## Account Table Names

Data Model Name	Table Name	Generated Keys	Object Validation Batch Control	Referential Integrity Validation Batch Control	Key Assignment Batch Control	Insertion Batch Control
Account	CI_ACCT	Yes CI_ACCT_K	VAL-ACCT		CIPVACCK	CIPVACCI
Bill Message	CI_ACCT_MSG	No. The key is account ID plus bill message code.		CIPVMSGV		CIPVMSGI
Autopay Option	CI_ACCT_APAY	Yes CI_ACCT_APAY_K		CIPVAAPV	CIPVAAPK Has dependencies	CIPVAAPI
Characteristic	CI_ACCT_CHAR	No. The key is ACCT_ID plus an edate and a char type.		CIPVACHV		CIPVACHI
Person/Account	CI_ACCT_PER	No. The key is account ID plus person ID.		CIPVACPV		CIPVACPI
Person/Account Address Override	CI_PER_ADDR_OVRD	No. The key is Account ID plus Person ID		CIPVPAOV		CIPVPAOI
Non Cash Deposit	CI_NCD	No. The key is account ID plus seq number		CIPVNCDV		CIPVNCDI



Credit Rating Tran	<a href="#">CI_CR_RAT_HIST</a>	Yes <a href="#">CI_CR_RAT_HIST_K</a>	CIPVCRTV	CIPVCRRK Has dependencies	CIPVCRTI
ADM Trigger	<a href="#">CI_ADM_RVW_SCH</a>	No. The key is account ID plus date	CIPVARSV		CIPVARSI

## Account Suggestions

An account must have at least one row on the account / person table and at least one account / person must be marked as being the main customer. Please see column notes for the account / person table for inter-field validation in respect of the various switches (e.g., if main customer switch is on, then the person must also be financially responsible).

We recommend storing an ADM trigger ([CI\\_ADM\\_RVW\\_SCH](#)) for every account where the trigger date is the conversion date. This will cause the account to be reviewed by the [account debt monitor](#) when it next runs. We have supplied a dedicated batch process for this purpose that simply inserts a row in this table with the review date set equal to the current date. This will ensure that all converted accounts are reviewed after they are inserted into production. This program is named CIPVADMB and goes by the batch control ID of CNV-ADM.

If your legacy system has the equivalent of a credit rating or a cash only score, you should create credit rating transactions. The values you create need to be consistent with the beginning and threshold credit rating and cash-only points on the installation record or the account's CIS Division. Refer to the business process guide - customer information - how are credit rating transactions created for more information.

## Landlord

### Landlord Data Model

The following data model illustrates the landlord object.

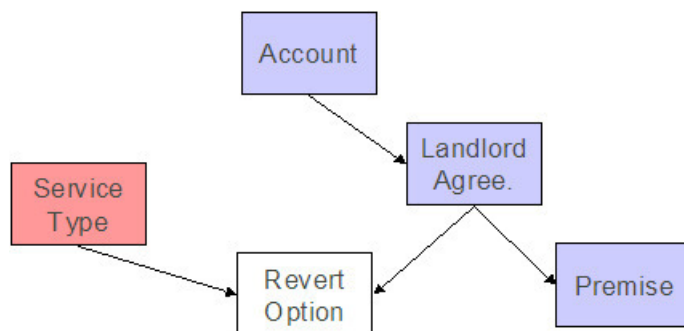

### Landlord Table Names

Data Model Name	Table Name	Generated Keys	Object Validation Batch Control	Referential Integrity	Key Assignment Batch Control	Insertion Batch Control

				Validation Batch Control	
Landlord	CI_LANLORD	Yes CI_LANLORD_K	VAL-LL		CIPVLNDK CIPVLNDI
Revert Option	CI_LL_DETAIL	No. The key is LL_ID plus service type		CIPVLLDV	CIPVLLDI

## Landlord Suggestions

N/A.

## Premise

### Premise Data Model

The following data model illustrates the premise object.

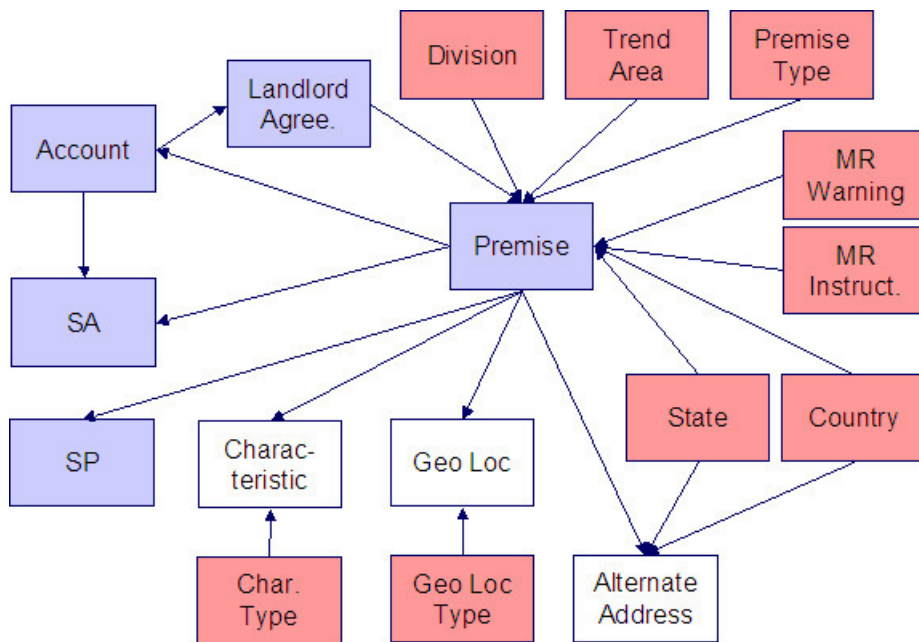

**NOTE:** Trend Area is not applicable for Oracle Utilities Customer to Meter.

### Premise Table Names

Data Model Name	Table Name	Generated Keys	Object Validation Batch Control	Referential Integrity	Key Assignment Batch Control	Insertion Batch Control
-----------------	------------	----------------	---------------------------------	-----------------------	------------------------------	-------------------------

			Validation Batch Control		
Premise	<a href="#">CI_PREM</a>	Yes <a href="#">CI_PREM_K</a> <a href="#">VAL-PREM</a>		<a href="#">CIPVPRMK</a>	<a href="#">CIPVPRMI</a>
				<a href="#">Has dependencies</a>	
Characteristic	<a href="#">CI_PREM_CHAR</a>	No. The key is PREM_ID plus an edate and a char type.	<a href="#">CIPVPCHV</a>		<a href="#">CIPVPCHI</a>
Geo Loc	<a href="#">CI_PREM_GEO</a>	No. The key is PREM_ID plus geo loc type.	<a href="#">CIPVPGOV</a>		<a href="#">CIPVPGOI</a>
Alternate Address	<a href="#">CI_PRM_ALT_ADDR</a>	Yes <a href="#">CI_PRM_ALT_ADDR_K</a>	<a href="#">CIPVAPAV</a>	<a href="#">CIPVAPAK</a>	<a href="#">CIPVAPAI</a>
				<a href="#">Has dependencies</a>	

## Premise Suggestions

N/A.

## Service Point

### Service Point Data Model

The following data model illustrates the service point object.

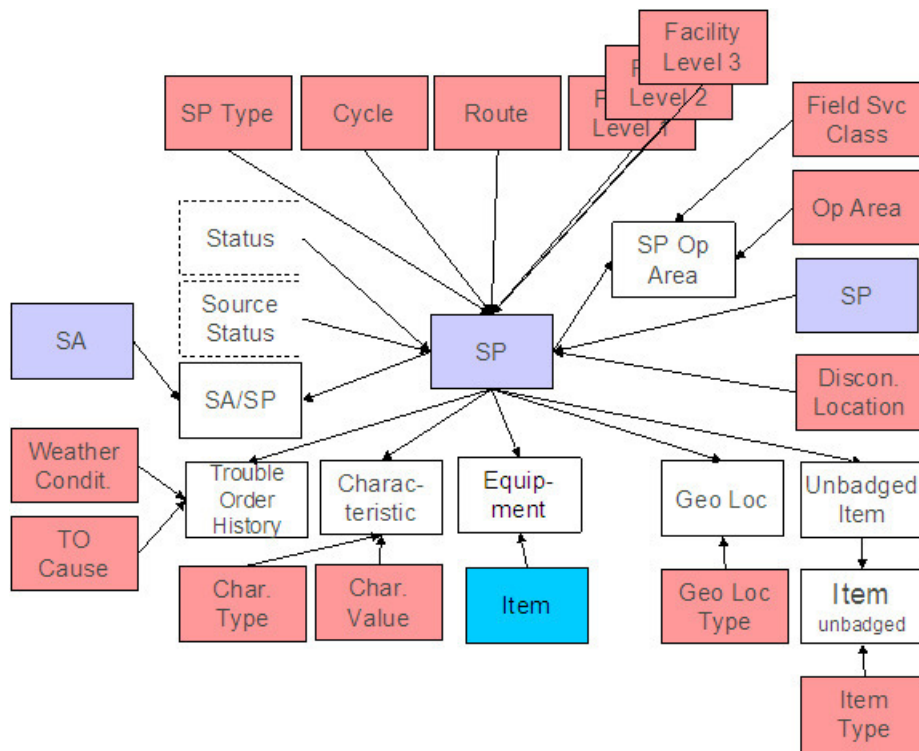

**NOTE:** Equipment, Facility Level,, Operation Area, and Service Class are not applicable for Oracle Utilities Customer to Meter

## Service Point Table Names

Data Model Name	Table Name	Generated Keys	Object Validation Batch Control	Referential Integrity Validation Batch Control	Key Assignment Batch Control	Insertion Batch Control
Service Point	<a href="#">CI_SP</a>	Yes <a href="#">CI_SP_K</a>	<a href="#">VAL-SP</a>		<a href="#">CIPVSPPK</a> <a href="#">Has dependencies</a>	<a href="#">CIPVSPPI</a>
Characteristic	<a href="#">CI_SP_CHAR</a>	No. The key is SP_ID plus an edate and a char type.		<a href="#">CIPVSPCV</a>		<a href="#">CIPVSPCI</a>
<i>Equipment</i> (not applicable to Oracle Utilities Customer Care and Billing )	<a href="#">CI_SP_EQ</a>	No. The key is service point ID plus equipment (service point) ID.		<a href="#">CIPVSEQV</a>		<a href="#">CIPVSEKI</a>
Geo Loc	<a href="#">CI_SP_GEO</a>	No. The key is service point ID plus geo type.		<a href="#">CIPVSPGV</a>		<a href="#">CIPVSPGI</a>

Unbadged Item	<a href="#">CI_SP_MULT_ITEM</a>	No. The key is SP_ID plus edate.		CIPVSPMV		CIPVSPMI
Item	<a href="#">CI_MULT_ITEM</a>	No. The key is SP_ID, edate and item type.		CIPVSMIV		CIPVSMII
SP Op Area (not applicable to Oracle Utilities Customer to Meter)	<a href="#">CI_SP_OP_AREA</a>	No. The key is SP_ID plus field service classification code		CIPVSPOV		CIPVSPOI
SA/SP	<a href="#">CI_SA_SP</a> (note, this table really belongs to the SA object, it is included here for completeness)	Yes <a href="#">CI_SA_SP_K</a>	CIPVSVAB	CIPVSAPV	CIPVSSPK <a href="#">Has dependencies</a>	CIPVSAPI

## Service Point Suggestions

N/A.

## Service Agreement

### Service Agreement Data Model

The following data model illustrates the service agreement object.

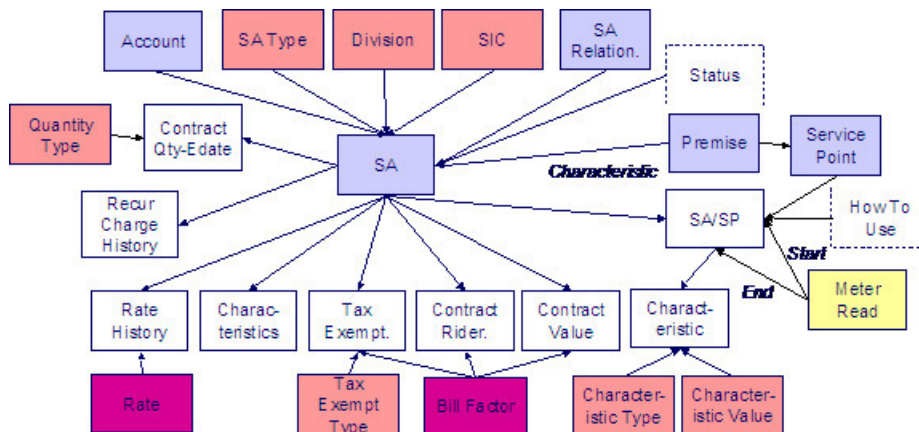

### Service Agreement Table Names

Data Model Name	Table Name	Generated Keys	Object Validation Batch Control	Referential Integrity Validation Batch Control	Key Assignment Batch Control	Insertion Batch Control
Service Agreement	<a href="#">CI_SA</a>	Yes <a href="#">CI_SA_K</a>	<a href="#">VAL-SA</a>		CIPVSVAK <a href="#">Has dependencies</a>	CIPVSAI
Characteristic	<a href="#">CI_SA_CHAR</a>	No. The key is SA_ID plus an edate and a char type.		CIPVSACV		CIPVSACI
Contract Quantity Edate	<a href="#">CI_SA_CONT_QTY</a>	No. The key is service agreement ID plus quantity type plus edate.		CIPVSAQV		CIPVSAQI
Message	<a href="#">CI_SA_MSG</a>	No. The key is service agreement ID plus Bill message code.		CIPVSMGV		CIPVSMGI
Recurring Charge	<a href="#">CI_SA_RCHG_HIST</a>	No. The key is service agreement ID plus edate.		CIPVSARV		CIPVSARI
SA Relationship	<a href="#">CI_SA_REL</a>	Yes <a href="#">CI_SA_REL_K</a>	<a href="#">VAL-SARL</a>	CIPVSRV	CIPVSRK <a href="#">Has dependencies</a>	CIPVSR
Rate History	<a href="#">CI_SA_RS_HIST</a>	No. The key is service agreement ID plus edate.		CIPVSAHV		CIPVSAHI
SA/SP	<a href="#">CI_SA_SP</a>	Yes <a href="#">CI_SA_SP_K</a>		CIPVSAPV	CIPVSSPK <a href="#">Has dependencies</a>	CIPVSAPI
SA/SP Characteristic	<a href="#">CI_SA_SP_CHAR</a>	No. The key is SA/SP Id plus char type plus effective date.		CIPVSSCV		CIPVSSCI
Tax Exempt	<a href="#">CI_SA_CONTERM</a> - this table is also used for the next 2 entities, the key contains <a href="#">CONTERM_TYPE_FLG</a> that controls the entity	No. This key is service agreement ID plus <a href="#">CONTERM_TYPE_FLG</a> plus <a href="#">BF_CD</a> plus <a href="#">START_DT</a>		CIPVSAOV		CIPVSAOI

Contract Rider	<a href="#">CI_SA_</a> <a href="#">CONTERM</a> - this table is also used for the previous and next entities, the key contains CONTERM_ TYPE_FLG that controls the entity	No. This key is service agreement ID plus CONTERM_ TYPE_FLG plus BF_CD plus START_DT	CIPVSAOV	CIPVSAOI
Contract Value	<a href="#">CI_SA_</a> <a href="#">CONTERM</a> - this table is also used for the previous 2 entities, the key contains CONTERM_ TYPE_FLG that controls the entity	No. This key is service agreement ID plus CONTERM_ TYPE_FLG plus BF_CD plus START_DT	CIPVSAOV	CIPVSAOI

## Service Agreement Suggestions

N/A.

## Contract Options

### Contract Options Data Model

The following data model illustrates the contract options objects.

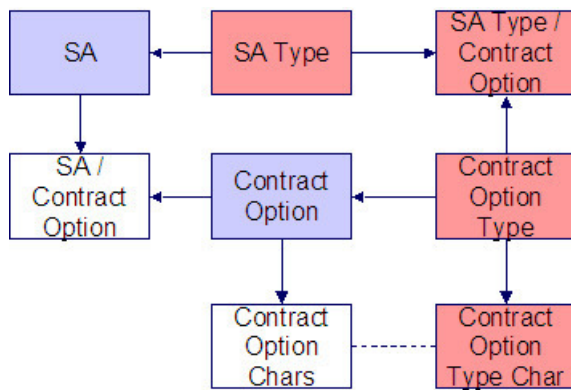

### Contract Options Table Names

Data Model Name	Table Name	Generated Keys	Object Validation Batch Control	Referential Integrity Validation Batch Control	Key Assignment Batch Control	Insertion Batch Control
Contract Option	<a href="#">CI_COP</a>	Yes <a href="#">CI_COP_K</a>	<a href="#">VAL-COP</a>		CIPVCOPK <a href="#">Has dependencies</a>	CIPVCOPI
Contract Option Language	<a href="#">CI_COP_L</a>	No. The key is CONT_OPT_ID plus language code		CIPVCOLV		CIPVCOLI
Contract Option Characteristics	<a href="#">CI_COP_CHAR</a>	No. The key is CONT_OPT_ID plus CHAR_TYPE_CD plus EFFDT		CIPVCCFV		CIPVCCAI
SA / Contract Option	<a href="#">CI_SA_COP</a>	Yes <a href="#">CI_SA_COP_K</a>		CIPVSCPV	CIPVSCP <a href="#">Has dependencies</a>	CIPVSCPI

## Contract Options Suggestions

N/A.

## Service Credit Membership

### Service Credit Membership Data Model

The following data model illustrates the Service Credit Membership objects.

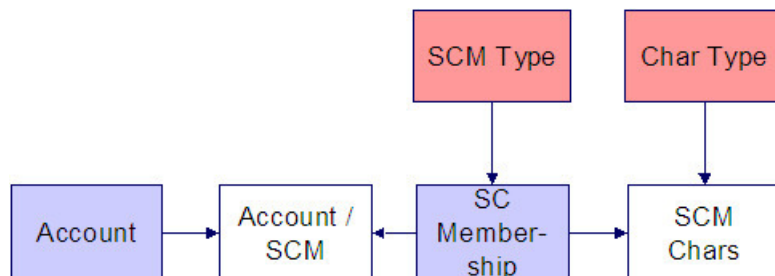

### Service Credit Membership Table Names



Data Model Name	Table Name	Generated Keys	Object Validation Batch Control	Referential Integrity Validation Batch Control	Key Assignment Batch Control	Insertion Batch Control
Service Credit Membership	CI_SCM	Yes CI_SCM_K	VAL-SCM	CIPVSCBV	CIPVSCMK	CIPVSCMI
Service Credit Membership / Account	CI_SCM_ACCT	No. The key is SCM_ID plus ACCT_ID.		CIPVSCAV		CIPVSCAI
Service Credit Membership Characteristics	CI_SCM_CHAR	No. The key is SCM_ID plus CHAR_TYPE_CD plus EFFDT.		CIPVSCCV		CIPVSCCI

## Service Credit Membership Suggestions

N/A.

## Declaration

### Declaration Data Model

The following data model illustrates the Declaration object.

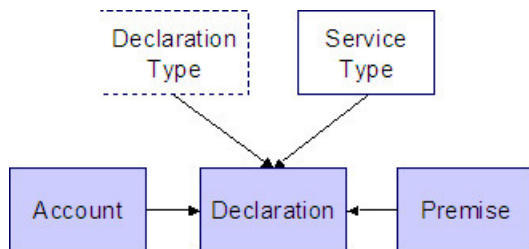

### Declaration Table Names

Data Model Name	Table Name	Generated Keys	Object Validation Batch Control	Referential Integrity Validation Batch Control	Key Assignment Batch Control	Insertion Batch Control
Declaration	CI_DCL	Yes CI_DCL_K	VAL-DCL		CIPVDCRK	CIPVDCRI

## Declaration Suggestions

N/A.

## Transaction Data

This section describes the tables in which your transaction data (e.g., bills, payments, meter reads, customer contacts, etc.) resides.

## SP / Meter History and On/Off Event

### SP / Meter Data Model

The following data model illustrates the service point / meter installation object.

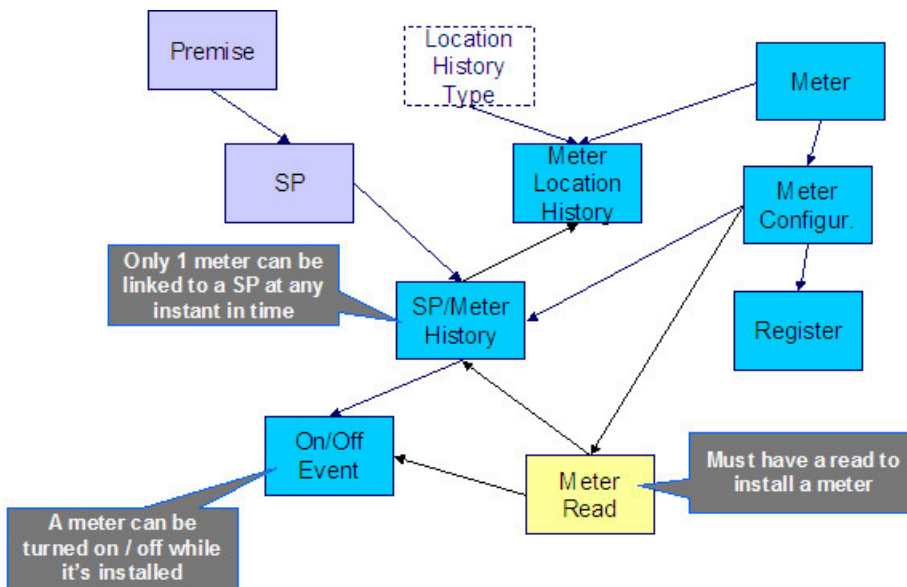

### SP / Meter Table Names

Data Model Name	Table Name	Generated Keys	Referential Integrity Validation Batch Control	Key Assignment Batch Control	Insertion Batch Control
SP/Meter History	CI_SP_MTR_HIST	Yes CI_SP_MTR_ HIST_K	CIPVSMHV	CIPVSMHK Has dependencies	CIPVSMHI

On/Off Event	<a href="#">CI_SP_MTR_EVT</a>	No. The key is meter history ID plus sequence number.	CIPVSMEV		CIPVSMEI
Meter Location History	<a href="#">CI_MTR_LOC_HIS</a>	Yes. <a href="#">CI_MTR_LOC_HIS_K</a>	CIPVMLHV	CIPVMLHK	CIPVMLHI

## SP / Meter Suggestions

In order to link a meter to a service point, you must

- Link the meter's meter configuration to the service point by inserting a record on the CI\_SP\_MTR\_HIST table.
- In addition, you must also create a CI\_SP\_MTR\_EVT record. Note the following about this record:
  - The value of the SP\_MTR\_EVT\_FLG should be I (for installation).
  - The value of the MTR\_ON\_OFF\_FLG should be 1 (on).
  - It must reference a read whose read date is the installation date. The reading can be a dummy value unless this customer has not been billed since the install date (i.e., the installation has taken place recently). In this situation, this read must be the true start read for the customer. Note, this read should also be linked to the SA/SP record associated with the SA that's linked to the SP as its start read.

## Bill

### Bill Data Model

This section contains information about the Bill's data model:

- Bill - Main
- Bill - Read Details
- Bill - FT
- Bill Characteristics
- Bill Messages, Bill Routing, and Bill Review Schedule

#### Bill - Main

The following data model illustrates the bill object.

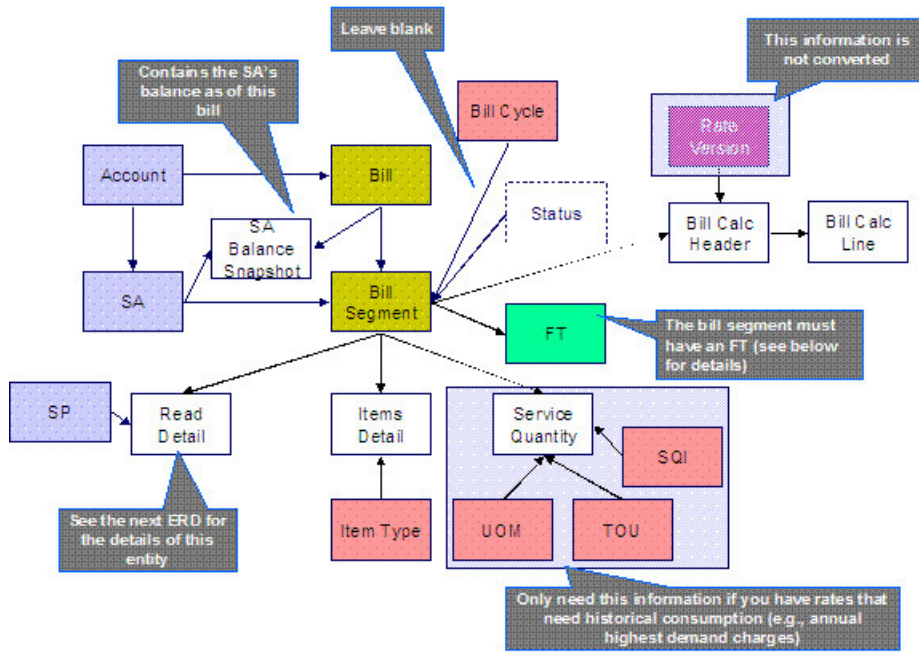

**Bill - Read Details**

The following data model illustrates the FK references on the read detail entity (a bill segment has one or more read details if the bill segment is associated with metered service).

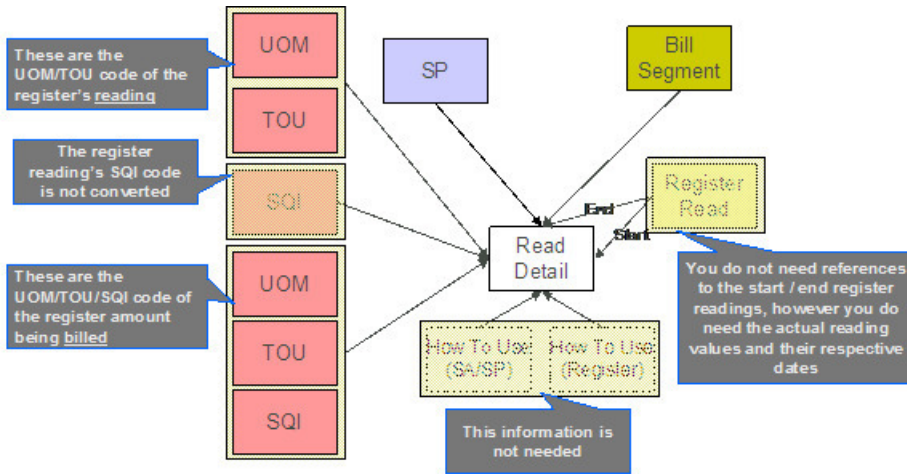

**Bill - FT**

The following data model illustrates the FT that must be associated with a bill segment.

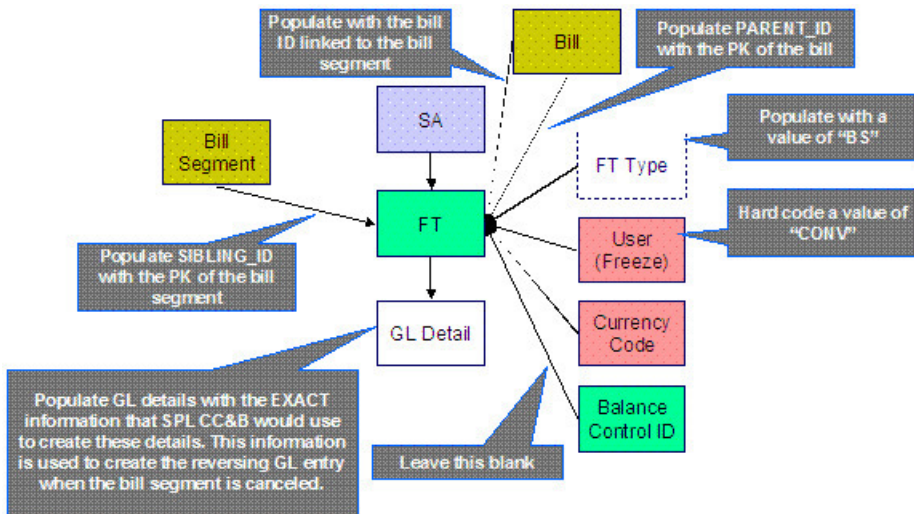

### Bill Characteristics

The following data model illustrates Bill Characteristics.

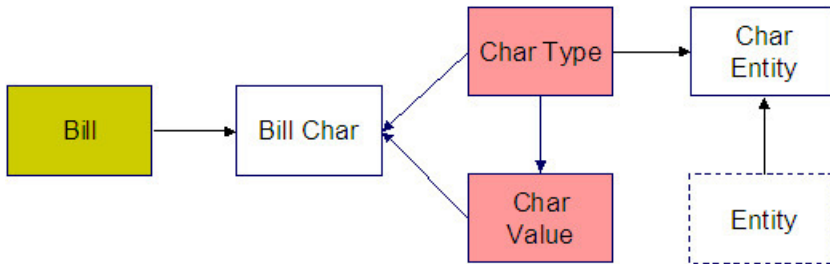

### Bill Messages, Bill Routing, and Bill Review Schedule

The following data model illustrates Bill Messages, Bill Routing, and Bill Review Schedule.

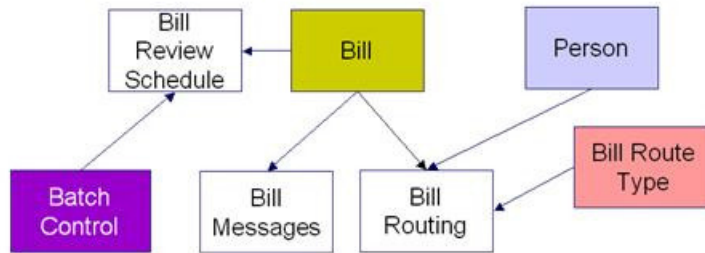

### Bill Table Names

Data Model Name	Table Name	Generated Keys	Referential Integrity Validation Batch Control	Key Assignment Batch Control	Insertion Batch Control
Bill	CI_BILL	Yes CI_BILL_K	CIPVLLV	CIPVBILK <a href="#">Has dependencies</a>	CIPVLLI
SA Balance Snapshot	CI_BILL_SA	No. The key is bill ID plus SA ID.	CIPVBSAV		CIPVBSAI

Bill Segment	<a href="#">CI_BSEG</a>	Yes <a href="#">CI_BSEG_K</a>	CIPVSEGV	CIPVBSGK <a href="#">Has dependencies</a>	CIPVSEGI
Calc Header	<a href="#">CI_BSEG_CALC</a>	No. The key is bill segment ID and a sequence number	CIPVBSCV		CIPVBSCI
Calc Lines	<a href="#">CI_BSEG_CALC_LN</a>	No. The key is bill segment ID, the header sequence number, and a sequence number	CIPVBSLV		CIPVBSLI
Read Detail	<a href="#">CI_BSEG_READ</a>	No. The key is bill segment ID, SP ID and a sequence number	CIPVSRRV		CIPVSRRI
Item Detail	<a href="#">CI_BSEG_ITEM</a>	No. The key is bill segment id and a sequence number	CIPVBSIV		CIPVBSII
Service Quantity	<a href="#">CI_BSEG_SQ</a>	No. The key is bill segment ID, uom code, tou code and SQI code	CIPVSQTV		CIPVSQTI
FT (financial transaction)	<a href="#">CI_FT</a>	Yes <a href="#">CI_FT_K</a>	CIPVFTFV	CIPVFTXK <a href="#">Has dependencies</a>	CIPVFTFI
FT GL (FT general ledger)	<a href="#">CI_FT_GL</a>	No. The key is FT ID and a GL sequence number	CIPVFTGV		CIPVFTGI
Characteristics	<a href="#">CI_BILL_CHAR</a>	No. The key is bill ID, char type code and a sequence number	CIPVBCHV		CIPVBCHI
Bill Messages	<a href="#">CI_BILL_MSGS</a>	No. The key is bill ID and bill message code.	CIPVBMLV		CIPVBMLI
Bill Routing	<a href="#">CI_BILL_ROUTING</a>	No. The key is bill ID and a sequence number	CIPVBLRV		CIPVBLRI
Bill Review Schedule	<a href="#">CI_BILL_RVW_SCH</a>	No. The key is bill ID, bill review date and batch code.	CIPVBRVV		CIPVBRVI

## Bill Suggestions

Most companies have found it impossible to load bill segment item, bill calculation header and lines with sufficient information and therefore these tables are not populated. See the comments in the above ERD's for more information.

Please populate the columns on the FT that's associated with the bill segment as follows:

- CUR\_AMT should be set equal to the bill segment amount

- PAY\_AMT should be set equal to the bill segment amount
- CRE\_DTTM should be set equal to the bill segment end date / time
- FREEZE\_SW should be "Y"
- FREEZE\_DTTM should be set equal to the bill segment end date / time
- ARS\_DT should be set equal to the bill segment end date
- CORRECTION\_SW should be "N"
- REDUNDANT\_SW should be "N"
- NEW\_DEBIT\_SW should be "N"
- NOT\_IN\_ARS\_SW should be set to "N"
- SHOW\_ON\_BILL\_SW should be set to "N"
- ACCOUNTING\_DT should be set to the current date
- SCHED\_DISTRIB\_DT should be left blank
- CURRENCY\_CD should be the currency on the installation record
- BAL\_CTL\_GRP\_ID should be left blank
- XFERRED\_OUT\_SW should be set to "Y"
- PARENT\_ID should be set to the bill ID
- SIBLING\_ID should be set to the bill segment ID
- Do NOT create any GL details for the FT. If GL details are converted, ensure they are populated with the EXACT information SPL CC&B would use to create them. This information is used to create the reversing GL entry when the bill segment is canceled.

## Payment

### Payment Data Model

The following data model illustrates the payment object.

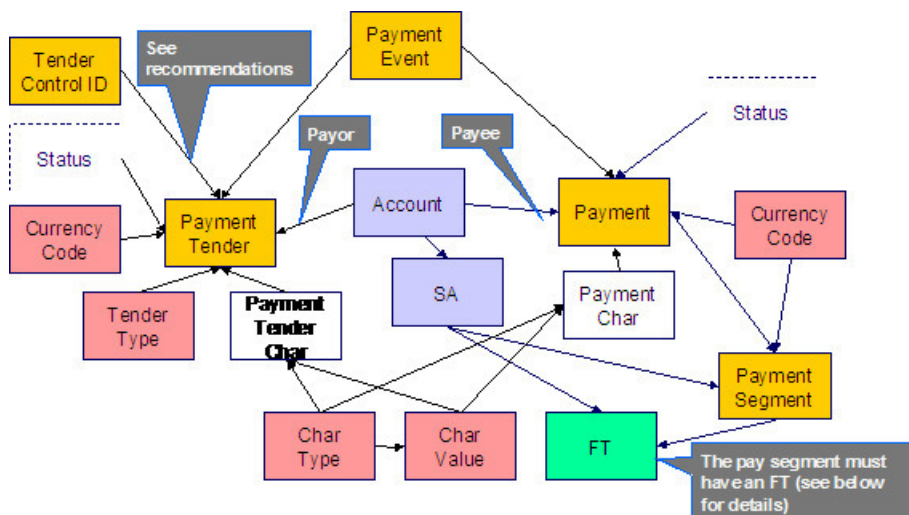



The following data model illustrates the FT that must be associated with a payment segment.

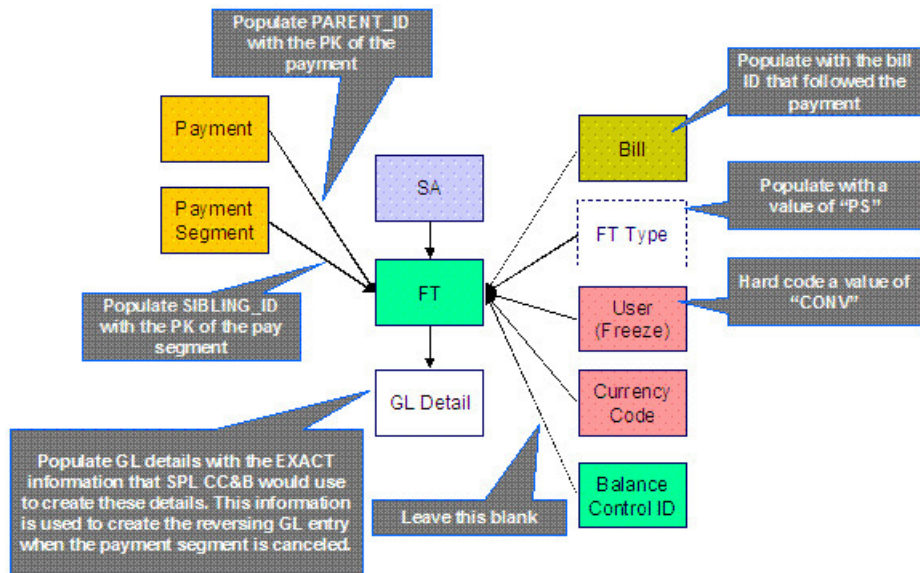

## Payment Table Names

Data Model Name	Table Name	Generated Keys	Referential Integrity Validation Batch Control	Key Assignment Batch Control	Insertion Batch Control
Payment	<a href="#">CI_PAY</a>	Yes <a href="#">CI_PAY_K</a>	CIPVPAYV	CIPVPAYK <a href="#">Has dependencies</a>	CIPVPAYI
Payment Event	<a href="#">CI_PAY_EVENT</a>	Yes <a href="#">CI_PAY_EVENT_K</a>		CIPVPYEK <a href="#">Has dependencies</a>	CIPVPYEI
Payment Event Characteristic	<a href="#">CI_PAY_EVT_CHAR</a>	No. The key is PAY_ EVENT_ID and a char type.	CIPVBLCV		CIPVBLCI
Payment Tender	<a href="#">CI_PAY_TNDR</a>	Yes <a href="#">CI_PAY_TNDR_K</a>	CIPVTNDV	CIPVTNDK <a href="#">Has dependencies</a>	CIPVTNDI
Payment Segment	<a href="#">CI_PAY_SEG</a>	Yes <a href="#">CI_PAY_SEG_K</a>	CIPVPSGV	CIPVPSGK <a href="#">Has dependencies</a>	CIPVPSGI
FT (financial transaction)	<a href="#">CI_FT</a>	Yes <a href="#">CI_FT_K</a>	CIPVFTFV	CIPVFTXK <a href="#">Has dependencies</a>	CIPVFTFI
FT GL (FT general ledger)	<a href="#">CI_FT_GL</a>	No. The key is FT id and a GL sequence number	CIPVFTGV		CIPVFTGI
Payment Tender Characteristic	<a href="#">CI_PAY_TNDR_CHAR</a>	No. The key is PAY_ TENDER_ID, plus a sequence number and a char type	CIPVTNCV		CIPVTNCI



Payment Characteristic	CI_PAY_CHAR	No. The key is PAY_ ID, plus a sequence number and a char type	CIPVPYCV	CIPVPYCI
---------------------------	-------------	---	----------	----------

---

## Payment Suggestions

We recommend that you use the system to create a single deposit control and link to it a single tender control using the PRODUCTION tables. The tender control should reference a tender source of "conversion". Use the prime key of the tender control as the foreign key on the tenders that you insert into the STAGING tables. This means you will have an invalid foreign key relationship on CI\_PAY\_TNDR (it will reference a tender control that doesn't exist).

After converting the payments:

- Re-access the tender control in production and enter the appropriate amounts (per tender type) to balance the tender control.
- Re-access the deposit control in production and enter the appropriate amounts to balance the deposit control.

Please populate the columns on the FT that's associated with the payment segment as follows:

- CUR\_AMT should be set equal to the payment segment amount
- PAY\_AMT should be set equal to the payment segment amount
- CRE\_DTTM should be set equal to the payment segment date / time
- FREEZE\_SW should be "Y"
- FREEZE\_DTTM should be set equal to the payment segment date / time
- ARS\_DT should be set equal to the payment segment date
- CORRECTION\_SW should be "N"
- REDUNDANT\_SW should be "N"
- NEW\_DEBIT\_SW should be "N"
- NOT\_IN\_ARS\_SW should be set to "N"
- SHOW\_ON\_BILL\_SW should be set to "N" on all payments other than payments that have been received since the last bill. For recent payments that you want to show on the next bill, this switch must be "Y"
- ACCOUNTING\_DT should be set to the current date
- SCHED\_DISTRIB\_DT should be left blank
- CURRENCY\_CD should be the currency on the installation record
- BAL\_CTL\_GRP\_ID should be left blank
- XFERRED\_OUT\_SW should be set to "Y"
- PARENT\_ID should be set to the payment ID
- SIBLING\_ID should be set to the payment segment ID
- Do NOT create any GL details for the FT. If GL details are converted, ensure they are populated with the EXACT information SPL CC&B would use to create them. This information is used to create the reversing GL entry when the payment segment is canceled.

# Adjustment

## Adjustment Data Model

### Adjustment Table Names

Data Model Name	Table Name	Generated Keys	Referential Integrity Validation Batch Control	Key Assignment Batch Control	Insertion Batch Control
Adjustment	<a href="#">CI_ADJ</a>	Yes <a href="#">CI_ADJ_K</a>	CIPVADJV	CIPVADJK <a href="#">Has dependencies</a>	CIPVADJI
Adjustment Characteristic	<a href="#">CI_ADJ_CHAR</a>	No. The key is ADJ_ ID and a char type.	CIPVADCV		CIPVADCI
Adjustment A/P Request	<a href="#">CI_ADJ_APREQ</a>	Yes <a href="#">CI_ADJ_ APREQ_K</a>	CIPVAPRV	CIPVAPRK <a href="#">Has dependencies</a>	CIPVAPRI
FT (financial transaction)	<a href="#">CI_FT</a>	Yes <a href="#">CI_FT_K</a>	CIPVFTFV	CIPVFTXK <a href="#">Has dependencies</a>	CIPVFTFI
FT GL (FT general ledger)	<a href="#">CI_FT_GL</a>	No. The key is FT ID and a GL sequence number	CIPVFTGV		CIPVFTGI
FT Process	<a href="#">CI_FT_PROC</a>	No. The key is FT id and a sequence number	CIPVFTPV		CIPVFTPI

### Adjustment Suggestions

Please populate the columns on the FT that's associated with the adjustment as follows:

- CUR\_AMT should be set equal to the adjustment amount
- PAY\_AMT should be set equal to the adjustment amount
- CRE\_DTTM should be set equal to the adjustment date / time
- FREEZE\_SW should be "Y"
- FREEZE\_DTTM should be set equal to the adjustment date / time
- ARS\_DT should be set equal to the adjustment date
- CORRECTION\_SW should be "N"
- REDUNDANT\_SW should be "N"
- NEW\_DEBIT\_SW should be "N"

- NOT\_IN\_ARS\_SW should be set to "N"
- SHOW\_ON\_BILL\_SW should be set to "N" on all adjustments other than adjustments that have been generated since the last bill. For recent adjustments that you want to show on the next bill, this switch must be "Y"
- ACCOUNTING\_DT should be set to the current date
- SCHED\_DISTRIB\_DT should be left blank
- CURRENCY\_CD should be the currency on the installation record
- BAL\_CTL\_GRP\_ID should be left blank
- XFERRED\_OUT\_SW should be set to "Y"
- PARENT\_ID should be set to the adjustment's adjustment type
- SIBLING\_ID should be set to the adjustment ID
- Do NOT create any GL details for the FT. If GL details are converted, ensure they are populated with the EXACT information SPL CC&B would use to create them. This information is used to create the reversing GL entry when the adjustment is canceled.

## Customer Contact

### Customer Contact Data Model

The following data model illustrates the Customer Contact object.

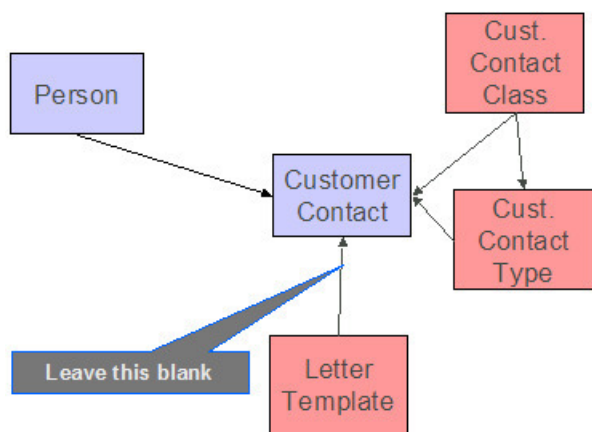

### Customer Contact Table Names

Data Model Name	Table Name	Generated Keys	Referential Integrity Validation Batch Control	Key Assignment Batch Control	Insertion Batch Control
Customer Contact	CI_CC	Yes <a href="#">CI_CC_K</a>	CIPVCSCV	CIPVCCTK <a href="#">Has dependencies</a>	CIPVCSCI

## Customer Contact Suggestions

N/A

## Field Activity

### Field Activity Data Model

The following data model illustrates the field activity object.

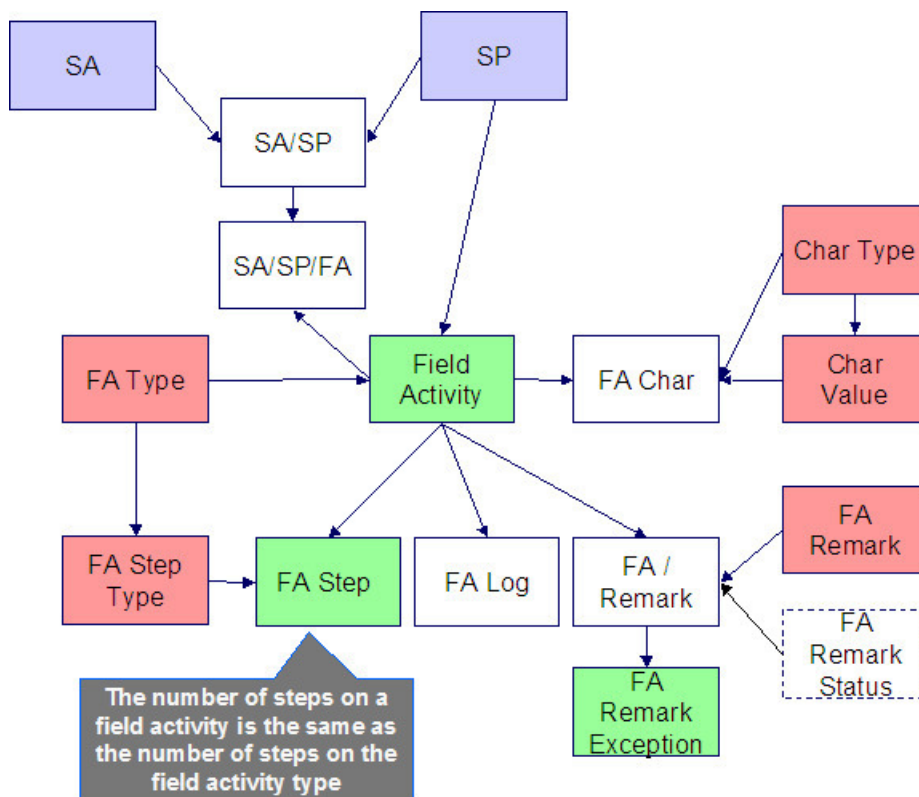

### Field Activity Table Names

Data Model Name	Table Name	Generated Keys	Object Validation Batch Control	Referential Integrity Validation Batch Control	Key Assignment Batch Control	Insertion Batch Control
Field Order	CI_FO	Yes <i>CI_FO_K</i>	VAL-FO	CIPVFORV	CIPVFORK	CIPVFORI

[Has dependencies](#)

Field Activity	<a href="#">CI_FA</a>	Yes <a href="#">CI_FA_K</a>	<a href="#">VAL-FA</a>	CIPVFACK	CIPVFACI
				<a href="#">Has dependencies</a>	
Step	<a href="#">CI_FA_STEP</a>	No. The key is FA_ID plus sequence number.		CIPVFSTV	CIPVFSTI
Not applicable to Customer to Meter					
Characteristic	<a href="#">CI_FA_CHAR</a>	No. The key is FA_ID plus CHAR_TYPE_CD plus sequence number.		CIPVFAHV	CIPVFAHI
Remarks	<a href="#">CI_FA_REM</a>	No. The key is FA_ID plus FA_REM_CD.		CIPVFARV	CIPVFARI
Log	<a href="#">CI_FA_LOG</a>	No. The key is FA_ID plus sequence number.		CIPVFALV	CIPVFALI
SA/SP/FA	<a href="#">CI_SA_SP_FA</a>	No. The key is SA/SP id and FA id.		CIPVSSFV	CIPVSSFI

## Field Activity Suggestions

N/A

## Contract Option Events

### Contract Option Events Data Model

The following data model illustrates the Contract Options objects.

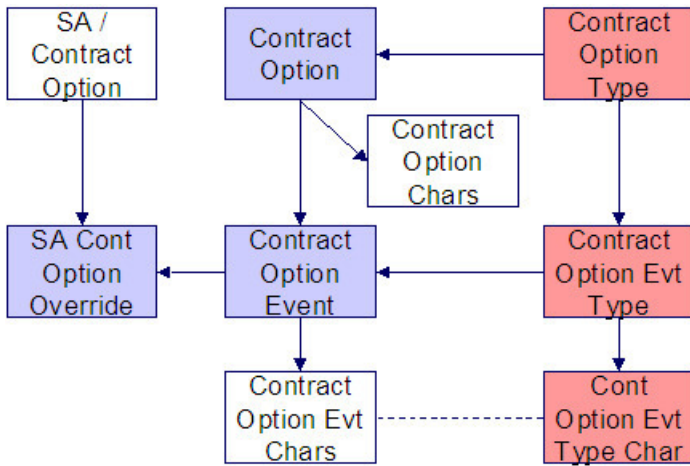

## Contract Option Events Table Names

Data Model Name	Table Name	Generated Keys	Object Validation Batch Control	Referential Integrity Validation Batch Control	Key Assignment Batch Control	Insertion Batch Control
Contract Option Event	CI_COP_EVT	Yes CI_COP_EVT_K	VAL-CEVT		CIPVCEVK Has dependencies	CIPVCEVI
Contract Option Event Characteristics	CI_COP_EVT_CHAR	No. The key is CONT_OPT_EVT_ID plus CHAR_TYPE_CD		CIPVCVCV		CIPVCVCI
SA Contract Option Override	CI_SA_COP_OVRD	No. The key is SA_CONT_OPT_ID plus CONT_OPT_EVT_ID plus OVRD_DTTM		CIPVSCOV		CIPVSCOI

## Contract Option Events Suggestions

N/A

## Bill Factor Value

## Bill Factor Value Data Model

The following data model illustrates the bill factor objects.

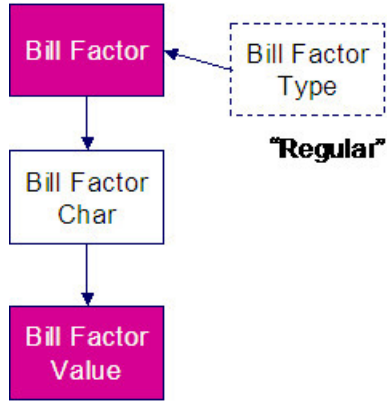

## Bill Factor Value Table Names

Data Model Name	Table Name	Generated Keys	Referential Integrity Validation Batch Control	Key Assignment Batch Control	Insertion Batch Control
Bill Factor Value	<a href="#">CI_BF_VAL</a>	No. The key is BF_ CD plus CHAR_ TYPE_CD plus CHAR_VAL plus TOU_GRP_CD plus EFFDT	CIPVBFVV		CIPVBFVI (Not threadable)

## Bill Factor Value Suggestions

N/A

## Bill Factor Interval Prices

### Bill Factor Interval Prices Data Model

The following data model illustrates the bill factor interval prices objects.

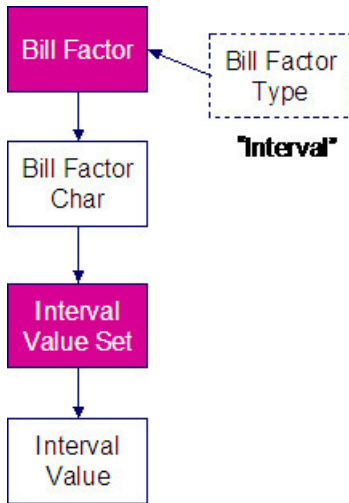

## Bill Factor Interval Prices Table Names

Data Model Name	Table Name	Generated Keys	Object Validation Batch Control	Referential Integrity Validation Batch Control	Key Assignment Batch Control	Insertion Batch Control
Interval Value Set	CI_INTV_VAL_SET	Yes CI_INTV_VAL_SET_K	VAL-IVS		CIPVIVSK	CIPVIVSI
Interval Value	CI_INTV_VAL	No. The key is INTV_VAL_SET_ID plus INTV_VAL_DTTM		CIPVITFV		CIPVITVI

## Bill Factor Interval Prices Suggestions

N/A

## Bill Factor TOU Pricing

### Bill Factor TOU Pricing Data Model

The following data model illustrates the bill factor TOU Pricing objects.



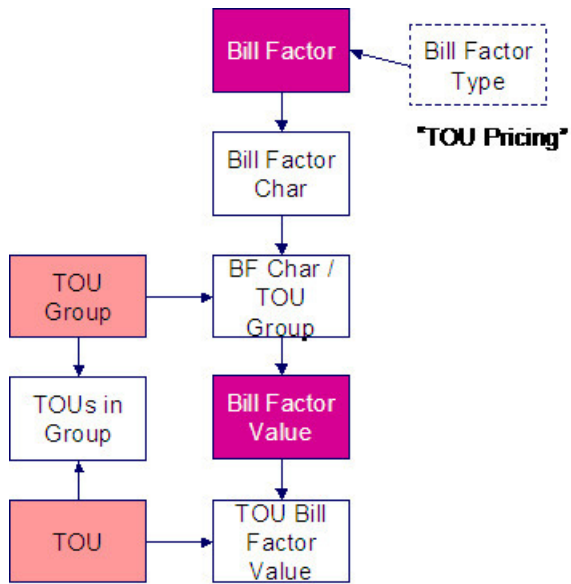

## Bill Factor TOU Pricing Table Names

Data Model Name	Table Name	Generated Keys	Referential Integrity Validation Batch Control	Key Assignment Batch Control	Insertion Batch Control
TOU Bill Factor Value	CI_TOU_BF_VAL	No. The key is BF_ CD plus CHAR_ TYPE_CD plus CHAR_VAL plus EFFDT plus TOU_ GRP_CD plus TOU_ CD	CIPVTBVV		CIPVTBVI (Not threadable)

## Bill Factor TOU Pricing Suggestions

N/A

## Service Credit Event

### Service Credit Event Data Model

The following data model illustrates the Service Credit Event objects.

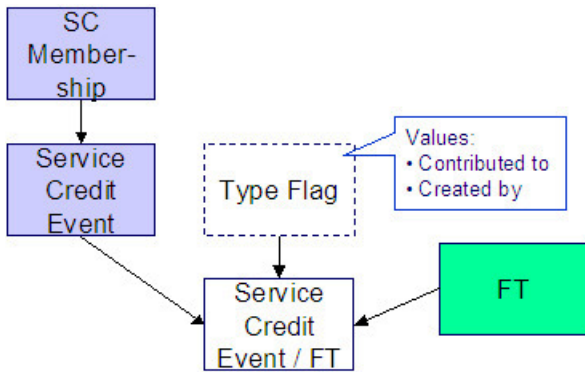

## Service Credit Event Table Names

Data Model Name	Table Name	Generated Keys	Referential Integrity Validation Batch Control	Key Assignment Batch Control	Insertion Batch Control
Service Credit Event	<a href="#">CI_SC_EVT</a>	Yes <a href="#">CI_SC_EVT_K</a>	CIPVSCVV	CIPVSCVK <a href="#">Has dependencies</a>	CIPVSCVI
Service Credit Event / FT	<a href="#">CI_SC_EVT_FT</a>	Yes <a href="#">CI_SC_EVT_ FT_K</a>	CIPVSCFV	CIPVSCFK <a href="#">Has dependencies</a>	CIPVSCFI

## Service Credit Event Suggestions

Loading the Service Credit Event FT data is optional. This data need only be converted if it exists in the legacy system and it is deemed necessary to include it.

## Non-Billed Budgets

### Non-Billed Budgets Data Model

The following data model illustrates the Non-Billed Budgets objects.

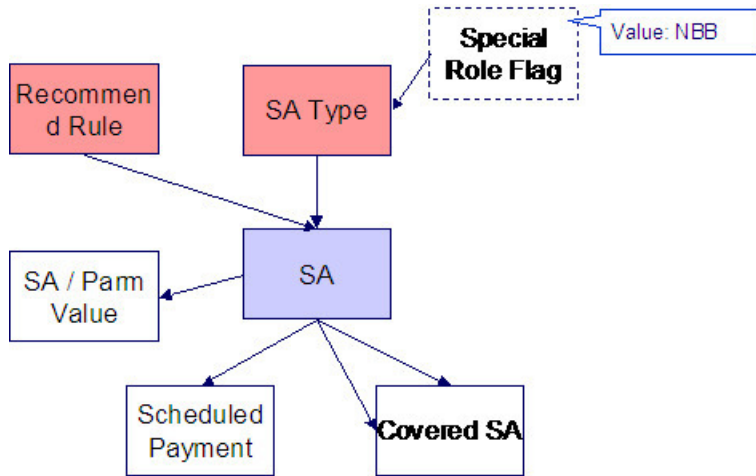

## Non-Billed Budgets Table Names

Data Model Name	Table Name	Generated Keys	Referential Integrity Validation Batch Control	Key Assignment Batch Control	Insertion Batch Control
NBB / Service Agreement	<a href="#">CI_NB_SA</a>	No. The key is SA_ ID plus CVRD_SA_ ID	CIPVNBSV		CIPVNBSI
NBB Scheduled Payments	<a href="#">CI_NB_SCHED_PAY</a>	Yes <a href="#">CI_NB_SCHED_PAY_K</a>	CIPVNSPV	CIPVNSPK <a href="#">Has dependencies</a>	CIPVNSPI
NBB / SA Parameters	<a href="#">CI_SA_NB_PARM</a>	No. The key is SA_ ID plus Sequence Number.	CIPVNPV		CIPVNPMI

## Non-Billed Budgets Suggestions

N/A

## Billable Charge

### Billable Charge Data Model

The following data model illustrates the Billable Charge objects.

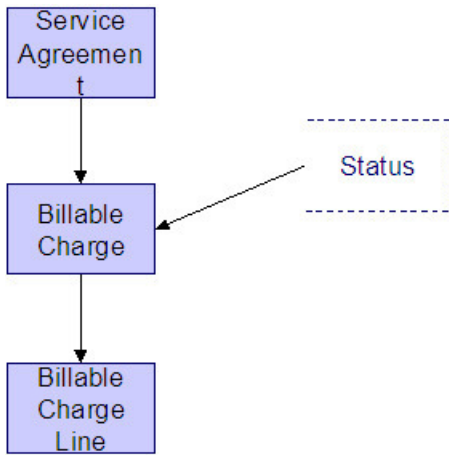

## Billable Charge Table Names

Data Model Name	Table Name	Generated Keys	Object Validation Batch Control	Referential Integrity Validation Batch Control	Key Assignment Batch Control	Insertion Batch Control
Billable Charge	CI_BILL_CHG	Yes. CI_BILL_CHG_K	VAL-BCHG	CIPVBCGV	CIPVBCGK	CIPVBCGI
Billable Charge Line	CI_B_CHG_LINE	No. The key is billable charge id and a sequence number		CIPVBCLV		CIPVBCLI

## Billable Charge Suggestions

N/A

## Collection Process

### Collection Process Data Model

The following data model illustrates the Collection Process objects.

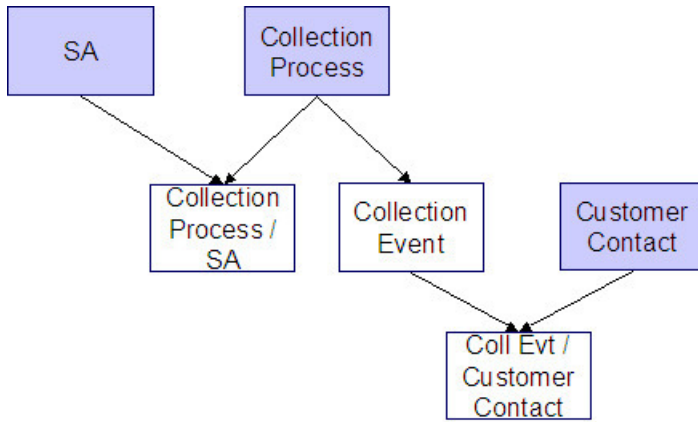

## Collection Process Table Names

Data Model Name	Table Name	Generated Keys	Object Validation Batch Control	Referential Integrity Validation Batch Control	Key Assignment Batch Control	Insertion Batch Control
Collection Process	<a href="#">CI_COLL_PROC</a>	Yes. <a href="#">CI_COLL_</a> <a href="#">PROC_K</a>	<a href="#">VAL-COLL</a>	CIPVCLPV	CIPVCLPK	CIPVCLPI
Collection Event	<a href="#">CI_COLL_EVT</a>	No. The key is collection process id and a sequence number.		CIPVCVNV		CIPVCVNI
Collection Process / Service Agreement	<a href="#">CI_COLL_</a> <a href="#">PROC_SA</a>	No. The key is collection process id and service agreement id.		CIPVCLSV		CIPVCLSI
Collection Event Customer Contact	<a href="#">CI_COLL_EVT_</a> <a href="#">CC</a>	No. The key is collection process id, a sequence number and the customer contact id.		CIPVCECV		CIPVCECI

## Collection Process Suggestions

N/A

## Severance Process

## Severance Process Data Model

The following data model illustrates the Severance Process objects.

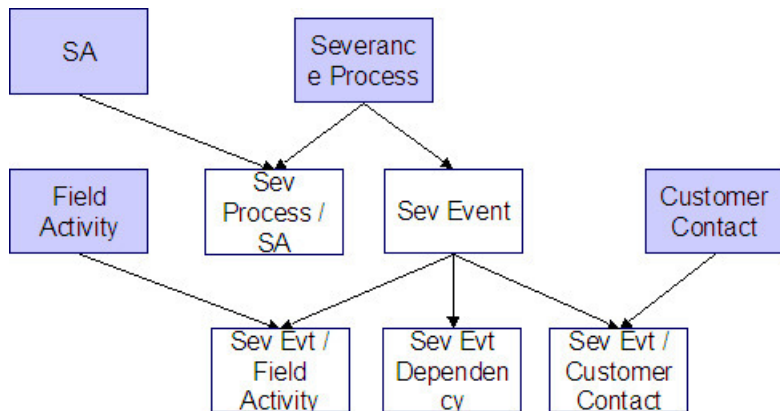

## Severance Process Table Names

Data Model Name	Table Name	Generated Keys	Object Validation Batch Control	Referential Integrity Validation Batch Control	Key Assignment Batch Control	Insertion Batch Control
Severance Process	CI_SEV_PROC	Yes. CI_SEV_PROC_K	VAL-SEVP	CIPVSEPV	CIPVSEPK	CIPVSEPI
Severance Event	CI_SEV_EVT	No. The key is severance process id and a sequence number.		CIPVSEVV		CIPVSEVI
Severance Event Customer Contact	CI_SEV_EVT_CC	No. The key is severance process id, a sequence number and the customer contact id.		CIPVSECV		CIPVSECI
Severance Event / Field Activity	CI_SEV_EVT_FA	No. The key is severance process id, a sequence number and field activity id.		CIPVSEFV		CIPVSEFI
Severance Event Dependency	CI_SEV_EVT_DEP	No. The key is severance process id, event sequence		CIPVSEDV		CIPVSEDI

number and  
a sequence  
number.

## Severance Process Suggestions

N/A

## Write Off Process

### Write Off Process Data Model

The following data model illustrates the Write Off Process objects.

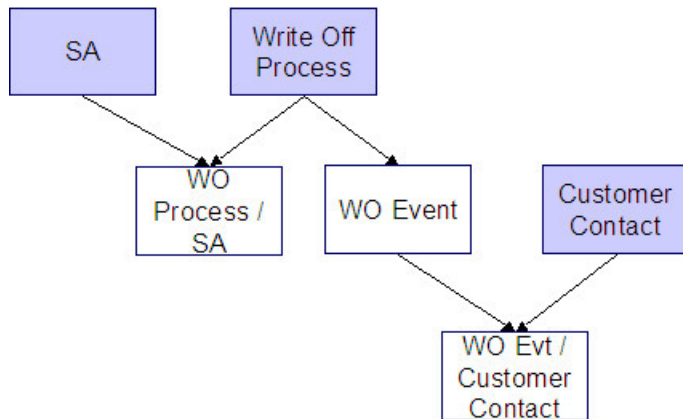

### Write Off Process Table Names

Data Model Name	Table Name	Generated Keys	Object Validation Batch Control	Referential Integrity Validation Batch Control	Key Assignment Batch Control	Insertion Batch Control
Write Off Process	CI_WO_PROC	Yes. CI_WO_PROC_K	VAL-WOP	CIPVWOPV	CIPVWOPK	CIPVWOPI
Write Off Process / Service Agreement	CI_WO_PROC_SA	No. The key is write-off process id and service agreement id.		CIPVWOSV		CIPVWOSI
Write Off Event	CI_WO_EVT	No. The key is write-off process id and		CIPVWOVV		CIPVWOVI

a sequence number.

Write Off Event / Customer Contact	<a href="#">CI_WO_EVT_CC</a>	No. The key is write-off process id, a sequence number and the customer contact id.	CIPVWOCV	CIPVWOCI
------------------------------------	------------------------------	---	----------	----------

## Write Off Process Suggestions

N/A

## Workflow Process

### Workflow Process Data Model

The following data model illustrates the Workflow Process objects.

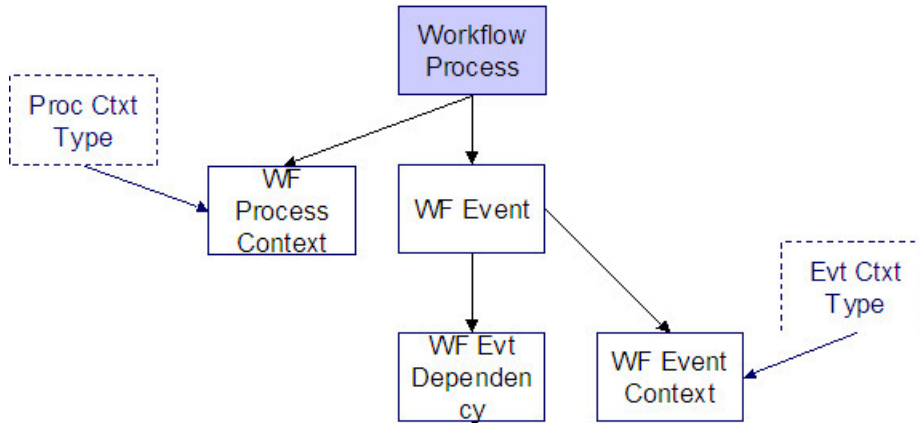

### Workflow Process Table Names

Data Model Name	Table Name	Generated Keys	Object Validation Batch Control	Referential Integrity Validation Batch Control	Key Assignment Batch Control	Insertion Batch Control
Workflow Process	<a href="#">CI_WF_PROC</a>	Yes. <a href="#">CI_WF_PROC_K</a>	<a href="#">VAL-WFP</a>	CIPVWPRV	CIPVWPRK	CIPVWPRI
Workflow Process Context	<a href="#">CI_WF_PROC_CTXT</a>	No. The key is workflow process id, workflow		CIPVWPCV		CIPVWPCI



		process context type and value.		
Workflow Event	CI_WF_EVT	No. The key is workflow process id and a sequence number.	CIPVWEVV	CIPVWEVI
Workflow Event Context	CI_WF_EVT_CTXT	No. The key is workflow process id, event sequence number, event context type and value.	CIPVWECV	CIPVWECI
Workflow Event Dependency	CI_WF_EVT_DEP	No. The key is workflow process id, event sequence number and a sequence number.	CIPVWEDV	CIPVWEDI

## Workflow Process Suggestions

N/A

## Collection Agency Referral

### Collection Agency Referral Data Model

The following data model illustrates the Collection Agency Referral object.

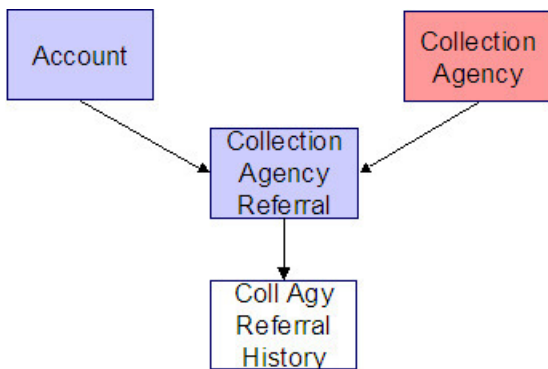

## Collection Agency Referral Table Names

Data Model Name	Table Name	Generated Keys	Referential Integrity Validation Batch Control	Key Assignment Batch Control	Insertion Batch Control
Collection Agency Referral	<a href="#">CI_COLL_AGY_REF</a>	Yes. <a href="#">CI_COLL_AGY_REF_K</a>	CIPVCARV	CIPVCARK	CIPVCARI
Collection Agency Referral History	<a href="#">CI_COLL_AGY_HIS</a>	No. The key is collection agency referral id and characteristic type code	CIPVARHV		CIPVARHI

## Collection Agency Referral Suggestions

N/A

## Program Dependencies

The programs used to assign production keys are listed under [Master Data](#) and [Transaction Data](#) (in the Table Names matrices). Most of these programs have no dependencies (i.e., they can be executed in any order you please). The only exceptions to this statement are illustrated in the following diagram.

The tiers in this diagram contain a box for each table whose key assignment program is dependent on the successful execution of other key assignment programs. The numbers that appear in the boxes describe the order in which these programs must be executed.

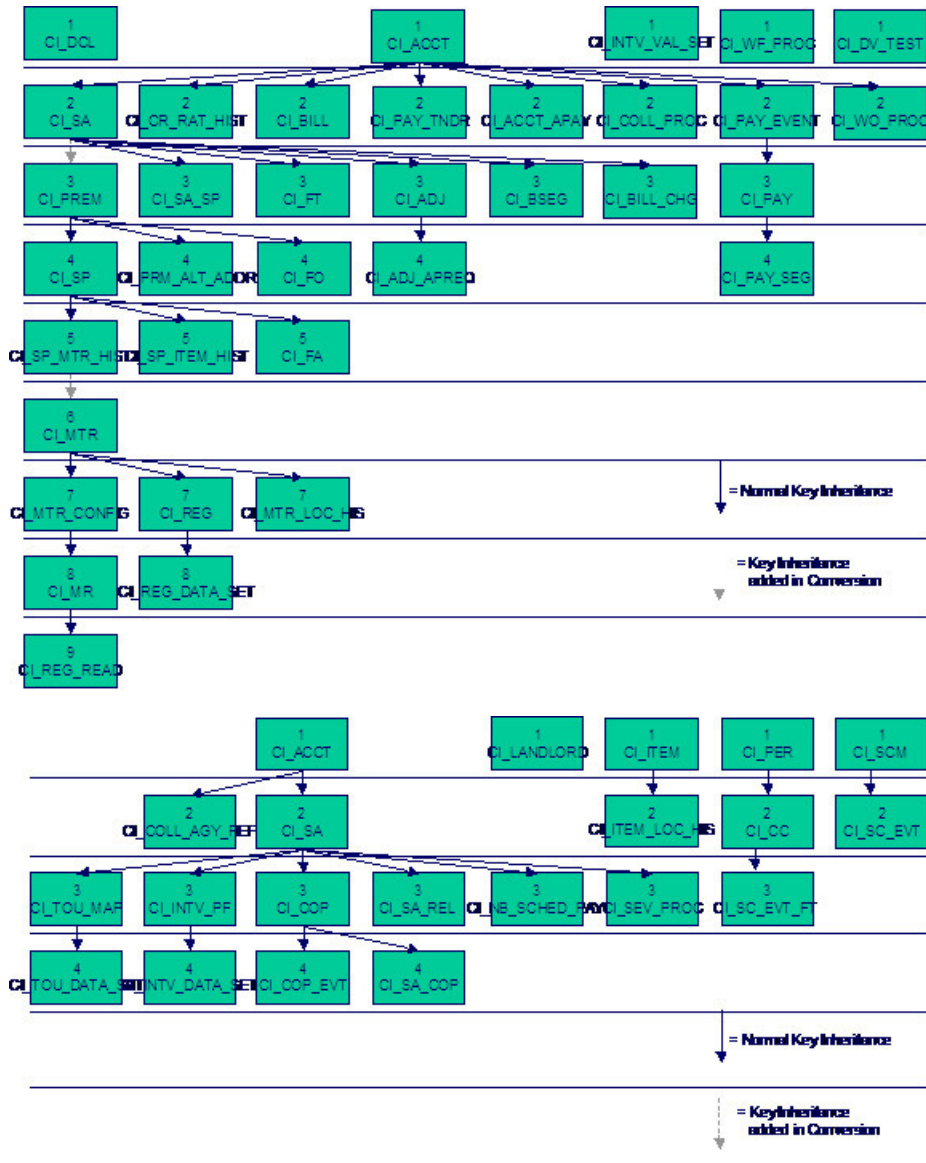

Please refer to the various "Table Names" sections above for the respective names of the programs to allocate each table's keys.

**WARNING:**

Prior to running the key generation program for a particular object, it is required that any previously generated keys be cleared from the key allocation tables and the key allocation temporary storage table. It is recommended that the key allocation tables be analyzed between runs to maximize performance.

## Appendix A - Entity Relationship Diagramming Standards

Because all data is stored in relational table, you need to be able to read diagrams that illustrate relationships between the various tables. The following entity diagram uses every diagramming notation used in the documentation:

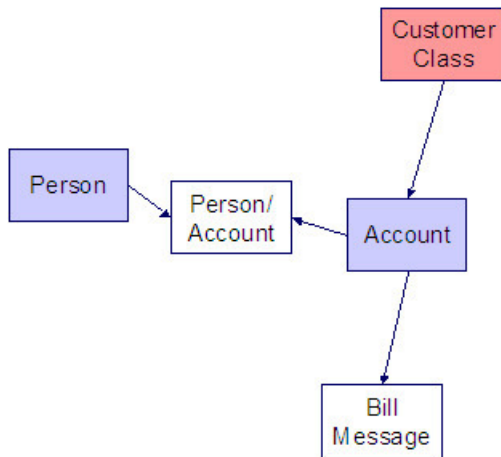

## Relationships

The solid line connecting the two entities that is terminated by an arrow represents a relationship between two entities. You read the relationship from the entity without the arrow to the entity with the arrow. For example in the following diagram, the line between Customer Class and Account illustrates that a Customer Class may have many Accounts, but an Account may be part of a single customer class.

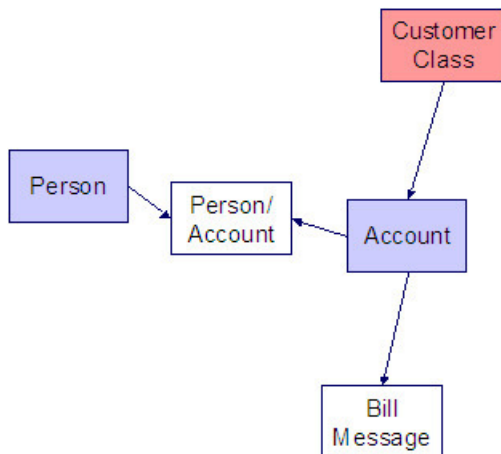

## Entity

Every box within the [Relationships](#) diagram represents an entity (i.e., a table). An entity may be a physical entity, such as a Person, or a logical construct, such as an Account.

## Color Coding













If you can view this document in color, you will notice that each entity is colored. The color indicates the "subsystem" which governs the entity. Know the governing subsystem is important because:

- The system's menu structure is subsystem-oriented (i.e., if you know the subsystem, you will know how to use the menus to navigate to the page used to view and update the entity).

- The system's documentation is subsystem-oriented (i.e., if you know the subsystem, you will know which chapter contains information about the entity).

Some entities are not color-coded (i.e., they are white). These entities do not have a dedicated page, as they are part of a parent entity. For example, the Person / Account entity above is related to the Account object and does not have its own page. You must display the parent entity in order to view such an entity. For example, if you want to look at Person / Account information, you must go to the Account page.

The following table describes the colors utilized in the documentation:

Color	Subsystem
	Customer Information
	Admin (Control) Table. These tables are referenced as foreign keys on master and transaction tables. We do not document the names of these tables in this document as the table names are easily accessible using the Table transaction.
	N/A - the entity is maintained in respect of a higher level entity.
	N/A - the values in these types of entities are defined in a special table referred to as the lookup table. In order to determine the valid values for a column that references a lookup table, use the name of the column as the search value on the Look Up user interface.
	Meter Management
	Meter Reading
	Rates
	Billing
	Financial Transaction
	Payment
	Field Order
	Adjustment

## Appendix B - Multiple Owners In A Single Database

In the schematic referenced in the [Introduction](#), you'll notice that there are two table owners in the system database. We refer to the first owner as "staging" and the second owner as "production".

The staging owner is linked to the tables into which you insert your pre-validated data. These tables have an owner ID of CISSTG.

**NOTE:**

**Multiple staging databases.** It is possible to have multiple staging databases. In this situation, each one would have a unique owner ID, e.g., CISSTG1, CISSTG2, etc.

The production owner is linked to the tables used by your production system. These tables have an owner ID of CISADM.

When the validation programs run against your staging data, they validate the staging data against the production control tables (and insert errors into the staging error table). This means that the SQL statements that access / update master and transaction data need to use the staging owner ( CISSTG ). Whereas the SQL statements that access control tables need to use the production owner ( CISADM ).

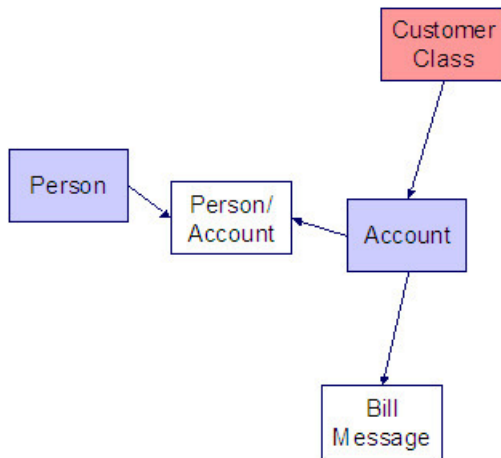

But notice that when these same programs run against production (Validate (b)), the SQL statements will never access the staging owner. Rather, they all point at the production owner.

This is accomplished as follows:

- A separate application server must exist for each owner. Each application server points at a specific database user ID.
- The database user ID associated with the staging database uses CISSTG as the owner for the master and transaction tables, but it uses CISADM as the owner of the production control tables.
- The database user ID associated with the production database uses CISADM as the owner for the master, transaction, and control tables.

You may wonder why we went to this trouble. There are several reasons:

- We wanted to reuse the validation logic that exists in the programs that validate your production data. In order to achieve this, these programs must sometimes point at the staging owner, and other times they must point at the production owner (and this must be transparent to the programs otherwise two sets of SQL would be necessary).
- We wanted to let you use the application to look at and correct staging data. This can be accomplished by creating an application server that points at your staging database with the ownership characteristics described above.
- We wanted the validation programs to be able to validate your production data (in addition to your staging data). Why would you want to validate production data if only clean data can be added to production? Consider the following scenarios:
  - After an upgrade, you might want to validate your production data to ensure your pre-existing user-exit logic still works.
  - You may want to conduct an experiment of the ramifications of changing your validation logic. To do this, you could make a temporary change to user exit logic (in production) and then run the validation jobs on a random sample basis.
  - You forget to run a validation program before populating production and you want to see the damage. If you follow the instructions in this document, this should never happen. However, accidents happen. And if they do, at least there's a way to determine the ramifications.

While the redirection of owner ID's is a useful technique for the validation programs, it cannot be used by the key assignment and production insert programs? Why, because these programs have to access the same tables but with different owners. For example, the program that inserts rows into the Person table must select rows from the staging version of the Person table and insert them into the production version of the Person table.

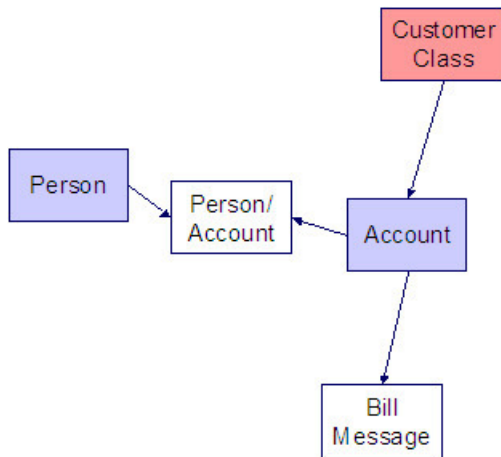

This is accomplished as follows:

- Views exist for each table that exists in both databases. These views have hard-coded the database owner CISADM (production). For example, there is a view called CX\_PER that points at person table in production.
- The key assignment and insertion programs use these views whenever then need to access production data.

## Appendix C - Known Oddities

Be aware that the following tables reference master data (e.g., persons, accounts). This means that if you look at them using a user ID that defaults ownership to the staging level, you will not be able to see the related master data (because the person / account doesn't exist in the staging owner's tables).

- Collection Agency. References a person.
- Service Provider. References a person and a service agreement.
- 3 rd Party Payor. References an account.
- Tender Source. References a suspense account.

## Defining Communication Options

### Device Event Types

### Understanding Device Event Types

#### Device Events

Device event types define properties common to specific types of events.

Device event types represent different types of events that can take place relative to a device. Examples of device events include power outages, power restoration, tampering alerts, and other events.

Device event types can be defined by the following attributes:

- **Standard Event Name:** the "standard" name of the event type. Device vendors may have their own specific names for device events. Only a single active device event type may be mapped to a given standard name at any time.
- **Device Event Category:** a category (defined as an Extendable Lookup) used to group device event types.
- **Reporting Category:** a category used to group device event types for reporting purposes.
- **Activity Type:** the activity type for activities created for device events of this type.

## Device Event Mapping

The first step to device event type configuration is defining the list of standard event names that will be processed by the system. This is done by populating the Standard Event Name extendable lookup (D1-StdEventNameLookup). More information about this extendable lookup can be found in [About Device Events](#).

With the fully defined list of Standard Event Names each head-end specific event name (which is also called an external event name) that the system will receive from a given head-end should be mapped to a standard event name. This mapping is configured using a device event mapping extendable lookup. Each head-end system should have its own extendable lookup to define event name mapping in order to prevent possible conflicts between mappings. Each of these business objects should be defined as a child of the parent business object Device Event Mapping (D1-DeviceEventMappingLookup).

For example, head-end systems A and B might both use the same event name, such as the code "1", but this event might need to be mapped to "outage" for head-end system A but "tamper" for head-end system B.

The device event mapping extendable lookup business object is configurable. Each Oracle Utilities Smart Grid Gateway adapter includes a device event mapping lookup business object for the supported head-end system.

Lastly, each device event type is associated to a standard name. This means that as each device event that is received will go through the following mapping steps:

1. The head end specific event name is mapped to a standard event name using the head end specific device event mapping extendable lookup
2. The standard event name is mapped to a device event type
3. The device event type is used to select the appropriate device event business object

## Device Event - Additional Processing

Certain device event business objects can be used to update master data as a result of device events received into the system. For example, when a utility's field worker arms a meter, the resulting device event can trigger an update to the device's arming status in the Oracle Utilities application. This processing is initiated by the Execute - Additional Processing system event

algorithm during the Additional Processing status of the business object's lifecycle.

The following base package business objects are configured to execute additional processing:

If a standard device event requires additional processing, the algorithms that execute the processing should be specified in the Additional Processing Algorithms list on the Standard Event Name extendable lookup for the event. The base package includes the additional processing algorithm Arm Meter ([D1-ARM-METER](#)).

Only a subset of base package device event business objects are configured to execute additional processing

Description	Business Object Name
Device Event Communication Response	D1-DeviceEventComResp
Standard Device Event	D1-StandardDeviceEvent

If additional processing is required for any business objects not listed above it can easily be added by configuring the algorithm Executer - Additional Processing System Event ([D1-EXTADDPRC](#)) in the Additional Processing status.



## Reader Remarks

Reader remark types define properties common to specific types of reader remarks.

Reader remarks are a type of device event used to capture and/or record specific events or circumstances encountered when a meter reader is manually reading scalar meters. Reader remark types represent the different types of remarks that meter readers can record. Examples of reader remark types include evidence of tampering, broken seals, damaged meter, dog on premises, and other notices.

When creating a new device type there are the following options:

Name	Details	Business Object
Reader Remark Type	Provides the configuration for a reader remark type	D1-ReaderRemarkType

## Field Activity Remarks

Field activity remark types define properties common to specific types of field activity remarks.

Field activity remarks are a type of device event used to capture and/or record specific events or circumstances encountered when a field worker is performing field work at a service point. Field activity remarks represent can represent situations that are found as well as actions that were taken in the field.

When creating a new device type there are the following options:

Name	Details	Business Object
Device Field Remark Type	Provides the configuration for a field activity remark type	D1-DeviceFieldRemarkType

## Configuring Device Event Types

This portal is used to display and maintain a Device Event Type.

Refer to [Understanding Device Event Types](#) for more information.

You can access the portal from the **Admin > Communication > Device Event Type**.

The following zones may appear as part of the portal's **Main** tab page:

- **Device Event Type List:** This zone lists all Device Event Type records. Broadcast a record to display the details of the selected record.
- **Device Event Type:** This zone provides information about the selected Device Event Type.

## Where Used

Follow this link to open the data dictionary where you can view the tables that reference [DI\\_DVC\\_EVT\\_TYPE](#).

## Activity Types

## Understanding Activity Types

Activities are records of a communication or event related to a device, measuring component, service point or other entity in the system. Examples of activities include smart meter command request, field activities, meter read downloads (for manually read meters) or the combined event of a "last gasp" and "power up" message sent by devices when they detects they experience an outage.

Each type of activity is assigned to an activity type category, please refer to About Activities for more information about the activity type categories supported by base product.

## Activities Orchestrate Communication

Certain types of activities such as request orchestrators, field activities, and command requests coordinate a large number of child transactions that represent the communication to and from an external application. The below diagram depicts a two way communication with an external system:

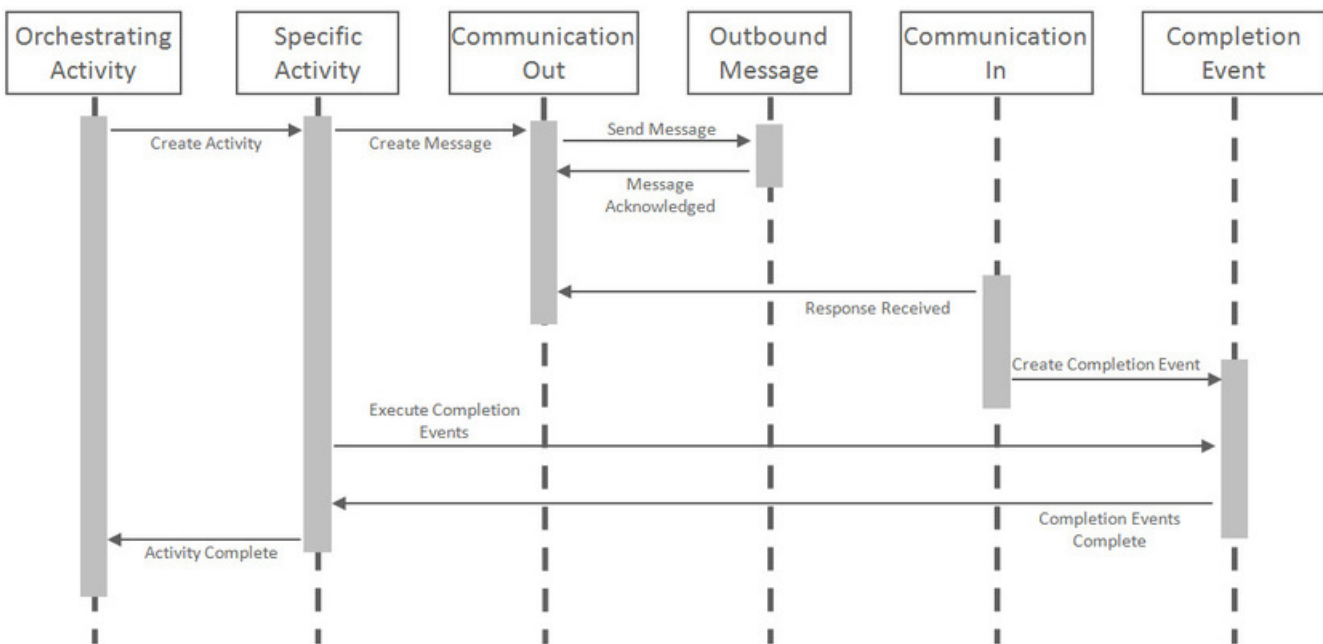

Each object in the sequence diagram has a distinct set of duties within the context of the communication:

- **Orchestrating Activity:** controls the overall intent of the communication. For example it may "Start Service" which would include initiating one-to-many specific activities to install the meter and begin the flow of the metered commodity to the service point.
- **Specific Activity:** can be initiated from an orchestrating activity or directly. These activities represent a single task to be carried out such as installing a meter or a remote disconnect smart meter command.
- **Communication Out:** orchestrates the communication to the external application and provides robust handling for any errors that might occur during that communication.
- **Outbound Message:** represents the message payload sent to the external system and the synchronous response.
- **Communication In:** orchestrates the handling of an asynchronous or unsolicited response from an external system.
- **Completion Event:** carries out the results of the communication. For example, in the case of a remote connect it would create the appropriate on off history entry for the device's installation event.

The below diagram involves many of the same objects but instead represents a one-way communication with an external system. All objects maintain the same duties described above with the addition of the communication out handling the synchronous response which contains the result of the message.

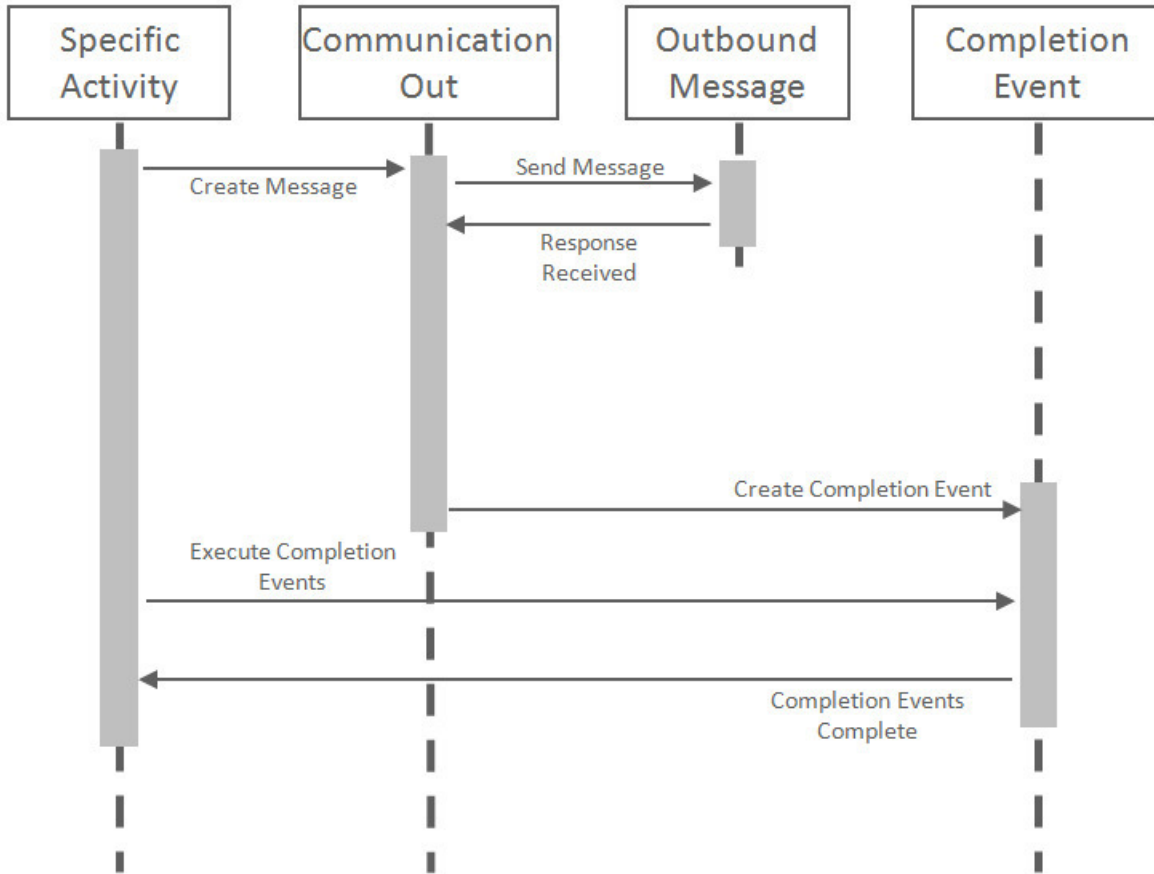

## Important Activity Type System Events

The activity type supports several business object algorithm system events that relate to calculating the consumption for measuring components of that type:

- **Customer-Device Compatibility:** receives information about the activity being analyzed and returns an indication of whether the customer and device are compatible. This system event is primarily used in service order management. See algorithm type Ensure Device-Usage Calculation Group Compatibility ([D2-ENSDVCCMP](#)) as an example.
- **Override Device / Task:** receives information about the activity such as whether the device is installed at a service point, whether the service point is connected, where it is disconnected (if applicable), and the installation event status override. Based on those inputs it should determine the output device configuration type as well as the field activity business object and field task type. This system event is primarily used in service order management. See algorithm type Evaluate Smart Meter Opt-Out for Device Installation ([D2-EVSMOPDV](#)) as an example.

## Configuring Activity Types

This portal is used to display and maintain a Activity Type.

Refer to Understanding Activity Types for more information.

You can access the portal from the **Admin > Communication > Activity Type**.

The following zones may appear as part of the portal's **Main** tab page:

- **Activity Type List:** This zone works differently than the typical zone that list types in that it displays both those activity types that have been configured as well as those activity types that have yet to be configured. Broadcast a record to display the details of the selected record.
- **Activity Type:** This zone provides information about the selected Activity Type

## Where Used

Follow this link to open the data dictionary where you can view the tables that reference [DI\\_ACTIVITY\\_TYPE](#).

# Communication Types

## Understanding Communication Types

Communication types define properties common to a specific type of communication. This single admin object covers both communication in and communication out types.

Communication types include types of communications between an application and an external system such as a head-end system or the work management system. These are outbound communications such as smart meter command requests or field activities as well as inbound communications such as a message response that indicates the results of a request.

Communication types typically provide configuration around exception handling:

- **To Do Type and Role:** identifies the To Do to be created when an error is encountered
- **Retry Frequency:** defines how often the communication should be retried. As many errors can be due to connectivity the ability to retry provides automatic resolution.
- **Maximum Retries:** provides an upper limit to the number of times a communication can be re-attempted
- Each communication type can have its own unique set of fields, please refer to the embedded help for that communication type for more details on those fields.

## Configuring Communication Types

This portal is used to display and maintain a Communication Type.

Refer to [Understanding Communication Types](#) for more information.

You can access the portal from the **Admin > Communication > Communication Type**.

The following zones may appear as part of the portal's **Main** tab page:

- **Communication Type List:** This zone works differently than the typical zone that list types in that it displays both those communication types that have been configured as well as those communication types that have yet to be configured. Broadcast a record to display the details of the selected record.
- **Communication Type:** This zone provides information about the selected Communication Type

## Where Used

Follow this link to open the data dictionary where you can view the tables that reference [DI\\_COMM\\_TYPE](#).

# Service Task Types

## Understanding Service Task Types

Service tasks types define properties common to specific types of service tasks.

Service task types represent types of tasks that can be performed by users of other Oracle Utilities applications, such as Oracle Utilities Customer Self Service or Oracle Utilities Network Management System. Examples of service tasks include self service meter reads, in which users enter their own meter reads via the Customer Self Service application, and service issue monitor types used when determining if service investigation is needed for a service point.

When creating a new record, the following options are available:

Name	Details	Business Object
Service Issue Monitor Type	The service issue monitor type defines the parameters for when a service investigative order should be created. It can also optionally define the completion parameters for that indicate the investigative order was successful in its purpose.	D1-ServiceIssueMonitorType
Self-Service Rate Compare Scenario Request Type	A simple description of a rate compare scenario request type.	D2-RateCompareScenarioRqstType
Self-Service Meter Read Task Type	Provides the default settings for meter reads created through self service.	D2-SSMeterReadTaskType

## Configuring Service Task Types

This portal is used to display and maintain a Service Task Type.

Refer to [Understanding Service Task Types](#) for more information.

You can access the portal from the **Admin > Customer > Service Task Type**

The following zones may appear as part of the portal's **Main** tab page:

- **Service Task Type List:** This zone lists all Service Task Type records. Broadcast a record to display the details of the selected record.
- **Service Task Type:** This zone provides information about the selected Service Task Type.

### Where Used

Follow this link to open the data dictionary where you can view the tables that reference [F1\\_SVC\\_TASK\\_TYPE](#).

## Defining Data Extract Options

### Analytics Configuration

This portal provides a bird's eye view of the configuration information for Oracle Utilities Analytics. It provides links and guidelines for the areas that need configuration to successfully run the extract transfer and load processes from Oracle Utilities Analytics.

Refer to the *Oracle Utilities Analytics Administration Guide* for more information.

You can access the portal from the **Admin > Analytics Configuration > Customer Analytics Configuration**

The following zones may appear as part of the portal's **Main** tab page

- **Bucket Configuration List.** This zone lists bucket configurations to set up.
- **BI-Related Business Objects Information.** This zone lists additional control entities to set up.

The following zones may appear as part of the portal's **OWB-Based ETL** tab page

- **Outbound Sync BOs and Algorithm List.** This zone lists business objects and algorithms involved in the extract process.
- **BI-Oriented Extendable Lookup.** This zone lists extendable lookups to set.
- **External Data Source Indicators List.** This zone lists the external identifiers of the various sources for your analytics data.

**Note:** Service Point business objects can make use of the following System Events:

- **Service Point Snapshot:** This system event defines the algorithm used to create a snapshot of the Service Point for use with Oracle Utilities Analytics. The Algorithm Entity for available algorithms is "SP (BO) - Snapshot."
- **Usage Snapshot:** This system event defines the algorithm used to create a usage snapshot of the Service Point for use with Oracle Utilities Analytics. The Algorithm Entity for available algorithms is "SP (BO) - Usage Snapshot."
- **Unreported Usage Analysis Snapshot:** This system event defines the algorithm used to create a snapshot of the Service Point's consumption since the last usage transaction for use with Oracle Utilities Analytics. The Algorithm Entity for available algorithms is "SP (BO) - Unreported Usage Analysis Snapshot."
- **SP VEE Exception Snapshot:** This system event defines the algorithm used to create a snapshot of VEE exceptions for the Service Point for use with Oracle Utilities Analytics. The Algorithm Entity for available algorithms is "SP (BO) - VEE Exception Snapshot."

## Consumption Extract Type

### Understanding Consumption Extract Type

The Consumption Extract Type controls which service point's measurements are extracted for Oracle Utilities DataConnect, what type of measurement is extracted, and how the measurements are grouped into TOU periods (if preferred).

The Consumption Extract Type also controls the request type used for creating Consumption Extract Requests of this type, how frequent automated requests are created for incremental extract, the batch jobs that are triggered for extracting data and the algorithms that extract, format, and write the data that is extracted.

Refer to the [Oracle Utilities DataConnect](#) integration section for more details on how this object is specifically put into use.

### Configuring Consumption Extract Type

This portal is used to display and maintain a Consumption Extract Type.

Refer to [Understanding Consumption Extract Types](#) for more information.

You can access the portal from the **Admin > Integration > Consumption Extract Type**.

The following zones may appear as part of the portal's **Main** tab page:

- **Consumption Extract Type List:** displays all of the Consumption Extract Types so you can choose the one you want to display in more detail
- **Consumption Extract Type:** shows the specific configuration for the selected Consumption Extract Type

## Where Used

Follow this link to open the data dictionary where you can view the tables that reference [DI\\_CONS\\_EXT\\_TYPE](#).

# Defining Aggregation Options

## Standard Aggregation

### Configuring an Out-of-the-box Aggregation

Aggregation calculations should be run on an as needed basis. This can include running the following batches:

- Scanning for new aggregation dimension ([D1-ADS](#)): This process is applicable if the system is configured to use aggregation dimension scanners to detect new aggregation dimensions (such as a service point referencing a new transformer for which an aggregator measuring component doesn't currently exist)
- Performing aggregation calculations ([D2-AGG](#)): this batch handles the summarization of measurement values in order to create aggregated measurements.

Note that aggregation calculations should precede usage transaction processing if aggregated values serves as input to the calculation of bill determinants.

Refer to the [About Aggregations](#) section of the *Oracle Utilities Meter Solution Business User Guide* for more information on this functionality. Refer to [Aggregation Measuring Component Types](#) for information on Measuring Component Types provided for aggregation.

### Understanding an Example Out-of-the-box Aggregation

The Oracle Utilities Meter Data Management base package includes an aggregation that aggregates measurement quantities for constituent measuring components based on postal code and service type dimensions. The table below outlines the types of objects used in this aggregation, based on the steps outlined above), and the specific objects for each type.

Dependency Order	Object Type	Base Package Example
1	Aggregator Measuring Component Business Object	D2-Aggregator (Aggregator - Postal and Service Type)
2	Aggregator Measuring Component UI Maps	Display: D2-AggMCDisp (Service Type and Postal Aggregator-Display) Maintenance: D2-AggMCMaint (Service Type and Postal Aggregator-Maintenance)
3	Aggregator Business Object Info Algorithm	D2-AMC-INFO (Service Type and Postal Aggregator - Information)
4	Find Constituent Measuring Components Algorithm	D2-DET-CMC (Find Constituent Measuring Components Based on Service Type and Postal)
5	Measuring Component Type	D2-AggregatorType (Aggregator Type)
6	Query Zone for Consumption Statistics Portal	D2-AGGMCQRY (Aggregator Search)
7	Dimension Scanner Activity Business Object	D2-ActivityAggDimScanner (Aggregator Creator - Postal / Service Type)
8	Dimension Scanner Activity UI Maps	Display: D2-AggDimScannerActDisp (Aggregator DS Activity-Display) Maintenance: D2- AggDimScannerActMaint (Aggregator DS Activity-Maintenance)

9	Dimension Scanner Activity Business Object Info Algorithm	D2-ADS-INFO (Aggregator Dimension Scanner Information)
10	Enter Algorithm for Scan State	D2-CRE-AGGMC (Aggregator MC Creation for Post Code and Service Type)
11	Activity Type	D2-ActivityTypeAggDimScanner (Aggregator Dimension Scanner Activity Type)

Refer to the [About Aggregations](#) section of the *Oracle Utilities Meter Solution Business User Guide* for more functional information.

## Creating a New Custom Aggregation

This section describes the overall process for creating a new custom Aggregation.

Refer to the [About Aggregations](#) section of the *Oracle Utilities Meter Solution Business User Guide* for more functional information.

### Execute the following steps:

1. Create a business object for the aggregator measuring component. This will flatten the dimensional value(s) into searchable characteristics. Whether this business object is a parent or a child of another aggregator business object depends on when periodic aggregation should occur:
  - a. If you want the periodic aggregation to occur when another aggregation occurs, it can be a child business object (meaning that it inherits the lifecycle (and therefore the deferred monitor) of the parent)
  - b. If you want to schedule its periodic aggregation independently from other aggregation business objects, this must NOT be a child business object as it will require its own deferred monitor (and deferred monitors can only be defined on parent business objects)
2. Create UI maps for the aggregator business object as follows:
  - a. One to display the aggregator measuring component (Display)
  - b. One to allow user to change / add a new one (Maintenance)

---

**NOTE:** A newer alternative to creating UI Maps would be to use UI Hints directly within the Business Object.

---

3. Create an info plug-in for the aggregator business object that concatenates together its dimension types and values.
4. Create a "Find Constituent Measuring Components" algorithm and plug it on the aggregator business object. This will be passed the aggregator measuring component and the from and to date/times. It will insert the constituent measuring component IDs and the respective from / to date-time of each onto a temporary table.
5. Create a measuring component type instance and reference the new aggregator measuring component business object (as well as the types of constituent measuring component types that should be aggregated).
6. Create a query zone for Consumption Statistics search to allow users to find the aggregator measuring component.

### Optional steps:

1. Create a business object for the dimension scanner activity. This should be a child business object of the base package dimension scanner business object.
2. Create UI maps for the activity business object, as follows:
  - a. One to display the dimension scanner activity (Display).
  - b. One to allow users to change/add a new one (Maintenance).



---

**NOTE:** A newer alternative to creating UI Maps would be to use UI Hints directly within the Business Object.

---

3. Create an info plug-in that will describe what it scans.
4. Create an Enter algorithm on the Scan state that finds distinct combinations of the dimensional values and creates new aggregator measuring components when new ones are detected.

---

**NOTE:** You can reuse the base package deferred monitor batch control called **Aggregation Dimension Scanner Monitor** ([DI-ADS](#)).

---

## Dynamic Aggregation

### Dynamic Aggregation Configuration Overview

Standard aggregation processing uses specific algorithms configured to work with a specified set of dimensions. For example, the base package Service Type and Postal aggregation uses specific algorithms for dimension scanning and finding constituent measuring components.

In contrast, dynamic aggregation uses dynamic queries for the dimension scanning, find constituents, and aggregation processes. These dynamic queries are based on configuration of administrative data, including:

- **Data Sources** define the source of data to be aggregated, such as measurement data from usage subscriptions linked to a service point, badged or unbadged items, or other sources of data.
- **Aggregation Measuring Component Types** define the most important properties of aggregation measuring components used to store aggregated data.
- **Aggregation Groups** define the ordering of a series of related aggregations and the schedule of aggregation.
- **Measuring Component Sets** define the dimensions and criteria by which aggregation will be performed.

### Aggregation Master Configuration

The Aggregation Master Configuration defines common parameters used with aggregation processing, including:

- Batch Controls used by the dimension scan and aggregation process, for both scheduled and adhoc execution.
- Details for how the system compares interval and billing data for the same set of customers in order to use only one source or other.

## Data Sources

### Understanding Data Sources

Data Sources define the source of data to be aggregated, such as measurement data from usage subscriptions linked to a service point, badged or unbadged items, or measuring component sets. Data sources also define configurations used when generating dynamic queries used by aggregation processing.

## Data Source Classes

Data sources are defined by classes, each of which is based on a specific business object, and determines the type of configuration used by aggregation processing. More specifically, the data types configured on the data source are used when generating dynamic queries used by aggregation processing.

The table below lists the data source classes and the business object and configuration options for each. Consult the embedded help for more information about the specific configuration options used by each data source class.

Data Source Class	Usage	Business Object	Configuration Options
Measurements from US Service Points	Used when aggregating data from measuring components linked to service points via a usage subscription.	D1-DataSourceMeasurements	Measuring Component Types
Badged Items	Used when aggregating data from badged items.	D1-BadgedItemsDataSource	Item Types
Billed Service Quantities	Used when aggregating data based on billed services quantities.	D1-DataSourceBilledSerQuantity	Usage Subscription Types
Measuring Component Sets	Used when aggregating data from measuring component sets. Data sources of this class are used with composite aggregation.	D1-DataSourceMCSet	Usage Subscription Types
Unbadged Items	Used when aggregating data from unbadged items.	D1-DataSourceUnbadgedItems	Item Types
Measurements from US Direct Links	Used when aggregating data from measuring components directly linked to a usage subscription.	D1-DataSourceMeasurementDirect	Measuring Component Types
Service Point Quantities	Used when aggregating data based on service point quantities.	D1-DataSourceSPQuantities	Service Point Quantity Types

## Data Source Template SQL

Data sources also provide template structured query language (SQL) used when generating dynamic queries used by aggregation processing. This template SQL is used as the basis for dynamic queries, and is extended by additional SQL generated from the data source configuration as well as configuration defined for measuring component sets, measuring components, and measuring component types that reference the data source. Template SQL is provided via the Data Source SQL (D1-DataSourceSQLLookup) extendable lookup. Values for this extendable lookup are used as the **Option Value** for the following business object options on the data source business object.

- **Dimension Scanner SQL:** The template SQL used when dimension scanning. This SQL is extended by the criteria, dimensions, and individually managed items configured on the measuring component sets being processed.
- **Find Constituents SQL:** The template SQL used when finding constituents. This SQL is extended by attributes defined on the aggregator measuring components being processed.
- **Aggregation SQL:** The template SQL used when performing aggregation. This SQL is extended by the value identifiers defined on the measuring component type of the aggregator measuring components being processed.

## Configuring Data Sources

This portal is used to display and maintain data sources.

Refer to [Understanding Data Sources](#) for more information.

You can access the portal from **Admin > Aggregation > Data Source**.

The following zones may appear as part of the portal's **Main** tab page:

- **Data Source List:** This zone lists all data source records. Broadcast a record to display the details of the selected record.
- **Aggregation Data Source:** This zone provides information about the selected data source.

### Where Used

Follow this link to open the data dictionary where you can view the tables that reference [D1\\_DATA\\_SRC](#).

## Configuring Data Source Template SQL

Template SQL used when generating dynamic queries used in aggregation processing is defined in the Data Source SQL (D1-DataSourceSQLLookup) extendable lookup. The base package data source business objects reference appropriate base package values from this extendable lookup.

For example, the **Aggregation SQL** option on the Measurements from US Service Points data source business object (D1-DataSourceMeasurements) references the “D1\_MSRMT\_FROM\_US\_SP\_MCTYPE\_SQL” value from the Data Source SQL extendable lookup.

If an implementation requires template SQL that differs from the base package, custom extendable lookup values can be created and referenced on the data source business object.

When creating custom template SQL, start from an existing extendable lookup value. Select the value that most closely matches your requirements and use the **Duplicate** function to create a copy, and edit the SQL as needed.

Use the following procedure to add a custom extendable lookup value to a data source business object.

1. Add a business object option of the appropriate type to the data source business object. For instance, if creating custom SQL for aggregation, add an **Aggregation SQL** option.
2. Enter a **Sequence** higher than the base package option.
3. Specify the custom extendable lookup value in the **Option Value** field.

## Dynamic Aggregation Measuring Component Types

### Understanding Dynamic Aggregation Measuring Component Types

Like other measuring component types, dynamic aggregation measuring component types define the most important properties of a measuring component. In this case, they define the properties of aggregator measuring components.

Measuring component types used by dynamic aggregation use many of the same attributes as other types of measuring components, but some attributes are used differently. Some attributes used specifically by dynamic aggregation include:

**Measuring Component Business Object:** This should be an aggregator measuring component business object, such as one of the following:

- Aggregator Interval (D1-AggregatorInterval)
- Aggregator Scalar (D1-AggregatorScalar)

- Aggregator Customer Quantities (D1-AggregatorCustomerQuantity)
- Aggregator Items Measuring Component (D1-AggregatorItems)

**Measurement Business Object:** Aggregated measurements can be based on either the Measurement (D1-Measurement) business object or the Aggregation Measurement (D1-AggregationMeasurement) business object (based on the Aggregation Measurement maintenance object).

**Data Source:** The source of the data that will be aggregated and the specific type of data that should be aggregated. Note that the **Service Type** of the data source, as determined by its associated objects (e.g. Measuring Component Type, Device Type, Service Point Type), must match the **Service Type** for this measuring component type.

**Value Identifiers:** These store the values of UOM, TOU, and SQI that identify the measurements to be aggregated. For each value identifier either the **Value Calculation Method** or **Value Derivation Algorithm** must be defined (not both). These define how measurement values are calculated or derived during aggregation processing.

Refer to [Understanding Measuring Component Types](#) for more information about measuring component types.

## Configuring Dynamic Aggregation Measuring Component Types

The **Measuring Component Type** portal is used to display and maintain dynamic aggregation measuring components.

Refer to [Understanding Dynamic Aggregation Measuring Component Types](#) for more information about dynamic aggregation measuring components.

---

Refer to [Configuring Measuring Component Types](#) for more information about working with measuring component types.

## Aggregation Groups

### Understanding Aggregation Groups

Aggregation Groups define the ordering of a series of related aggregations based on a set of configured Measuring Component Sets. Aggregation groups define the following attributes for aggregations performed for its Measuring Component Sets:

- The **Time Zone** for aggregated data
- **Aggregation Scheduling** can be based on either a Defined Lag, or a Processing Timetable.
  - **Defined Lag** scheduling uses the following parameters:
    - **Aggregation Cut Off Time:** The end time for aggregation calculations performed for Aggregation Measuring Components for Measuring Component Sets associated with the Aggregation Group. This is used to ensure a consistent end time for aggregation periods. This is especially useful when aggregating other aggregations.
    - **Aggregation Lag:** The number of days between the date on which aggregation calculations are performed and the end date of the aggregation period. This defines the time period between the aggregation calculation date and the aggregation horizon that serves to allow all measurements to arrive. This together with the Aggregation Horizon is used to determine the start and end dates of an aggregation period. For example, with an Aggregation Horizon of 5 and an Aggregation Lag of 2, aggregation calculations performed on January 9 would be for an aggregation period of January 3 through January 7. The next day (January 10), the aggregation period would shift to January 4 through January 8.
    - **Aggregation Horizon:** The number of days in the aggregation period for Aggregation Measuring Components for Measuring Component Sets associated with the Aggregation Group. This reflects the time period during which there's a potential change in measurement data for one or more of the measuring components associated with Aggregation Measuring Components. This together with the Aggregation Lag is used to determine the start and end dates of an aggregation period.

- **Processing Timetable** scheduling uses a Processing Timetable Type to drive aggregation schedule.

Aggregation groups can be used to perform aggregations for Analytical or Settlement purposes (defined by the Aggregation Category).

## Aggregation Group Runs

Aggregation group runs represent individual aggregation executions for an individual aggregation group. Aggregation group runs are used to capture the relevant details for an aggregation and track the status of the execution of the aggregation for each of the Measuring Component Sets for the aggregation group.

Aggregation group runs for a specific aggregation group are listed in the **Aggregation Group Run** zone on the **Aggregation Group** portal. This zone displays the following for each aggregation group run:

- Run Number
- Run Type (Scheduled vs. Ad Hoc)
- Status (Pending, In Progress, Completed, or Error)
- Aggregation Horizon Start
- Aggregation Horizon End
- Details

Details for a specific aggregation group run can be viewed by broadcasting the run in the **Aggregation Group Run** zone. The following is displayed for the selected run in the **Aggregation Group Run Details** zone:

- Sequence
- Measuring Component Set
- Initiation Method
- Batch Run

## Configuring Aggregation Groups

This portal is used to display and maintain aggregation groups.

Refer to [Understanding Aggregation Groups](#) for more information.

You can access the portal from **Admin > Aggregation > Aggregation Group**.

The following zones may appear as part of the portal's **Main** tab page:

- **Aggregation Group List:** This zone lists all aggregation group records. Broadcast a record to display the details of the selected record.
- **Aggregation Group:** This zone provides information about a selected aggregation group.
- **Aggregation Measuring Component Sets:** This zone lists measuring component sets associated with the selected aggregation group. Click **Resequence** to change the order of the measuring component sets in the aggregation group. Click **Add** to add a new measuring component set to the aggregation group.
- **Aggregation Group Run:** This zone lists individual aggregation runs performed for the selected aggregation group. Broadcast a record to display the details of the selected record. This zone displays up to 10 records. If there are more than 10 records, use the **Previous** and **Next** buttons to navigate between pages of records. Click **Add** to execute an ad hoc aggregation group run.
- **Aggregation Group Run Details:** This zone displays details for a selected aggregation group run.

## Where Used

Follow this link to open the data dictionary where you can view the tables that reference [DI\\_AGG\\_GROUP](#).

## Measuring Component Sets

### Understanding Measuring Component Sets

Measuring component sets are used to define the dimensions and criteria by which aggregation will be performed.

A measuring component set's **Measuring Component Type** defines the Measuring Component and Measurement Type to be used in capturing aggregation results, as well as the aggregation functions that will be used on the source transnational data and the Data Source that will identify where that transnational data will be retrieved from.

Measuring component sets are associated with an **Aggregation Group**, which controls when and how aggregation is processed. This includes the sequence in which the aggregation group's measuring component sets are processed, as well as the method by which aggregation processing is initiated for each (this information can be found in the **General Processing** section).

A measuring component set's **Measuring Component Set Class** defines the way in which the measuring component set is used in the aggregation process. Measuring component set classes are based on the measuring component set's business object, and can include:

- **Aggregation Foundation** measuring component sets are used to aggregate transactional data, such as measurements from service points linked via usage subscriptions or billed service quantities.
- **Aggregation Composite** measuring component sets are used to aggregate data from a set of other aggregations (which can be based on either foundation or other composite measuring component sets).
- **Adhoc** measuring component sets are used to aggregate data based on an adhoc, user-defined set of measuring components.

See **Foundation and Composite Aggregation** in [Dynamic Aggregation Processing](#) for more information.

### Dimensions, Criteria, and Individually Managed Items

The **Dimensions** and **Criteria** defined for the measuring component set are used by the dimension scanning process to identify individual aggregation measuring components that should be created. Measuring components are also created for each **Individually Managed Item** for which data matches the item's configuration.

- **Dimensions** identify the attributes by which data should be aggregated. Dimensions can include characteristics, identifiers, market participants, and values from specific tables and columns. For example, aggregating data by loss profile code, service point type and service provider would require defining dimensions for a Loss Profile Code characteristic, the Service Point Type column from the Service Point table, and the Service Provider column from the Device table.
- **Criteria** define the ways in which the dimensions are evaluated through a series of inclusions, exclusions, or both. For example, to aggregate data for the "AGG-E-COM" and "AGG-E-RES" service point types, but NOT for devices from the "ELEC" service provider, criteria could be defined to include both of service point type values and exclude the "ELEC" service provider.
- The criteria provided for **Individually Managed Items** is used to identify specific customers that should be aggregated in isolation from all other data that matches the **Dimensions** and **Criteria** defined for the measuring component set.

More specifically, the dimension scanning template SQL (derived from the data source) is extended by the **Dimensions**, **Criteria**, and **Individually Managed Items** configured on the measuring component set being processed.

Consult the embedded help for more information about the specific configuration options used by **Dimensions**, **Criteria**, and **Individually Managed Items**. The Source Type and Source Entity values are defined in the Aggregation Criteria Source Type (D1-CriteriaSourceTypeLookup) extendable lookup. Refer to [Configuring Aggregation Criteria Source Types](#) for more information about this extendable lookup.

The manner in which the criteria provided will be evaluated is defined in formulas configured in the **Criteria Processing** section. Consult the embedded help for more information about defining criteria processing formulas.

## Configuring Measuring Component Sets

This portal is used to display and maintain measuring component sets.

Refer to [Understanding Measuring Component Sets](#) for more information.

You can access the portal from **Admin > Aggregation > Measuring Component Set**.

The following zones may appear as part of the portal's **Main** tab page:

- **Measuring Component Set:** This zone displays details of a selected measuring component set.
- **Dimensions:** This zone lists the dimensions used to identify the attributes by which the aggregation should be analyzed. Note: Data in this zone is edited by clicking the **Edit** button in the **Measuring Component Zone**.
- **Criteria:** This zone lists the criteria that limits the data to be aggregated through a series of inclusions, exclusions, or both. Note: Data in this zone is edited by clicking the **Edit** button in the **Measuring Component Zone**.
- **Individually Managed Items:** This zone lists the criteria used to identify specific customers that should be aggregated in isolation from all other data that matches the dimensions and criteria defined for the measuring component set. Note: Data in this zone is edited by clicking the **Edit** button in the **Measuring Component Zone**.
- **Measuring Component Set Participants:** This zone displays the measuring components that are in the Measuring Component Set Participant table for the measuring component set. For each measuring component, this zone displays the most recent and last measurement date/times.

### Where Used

Follow this link to open the data dictionary where you can view the tables that reference [DI\\_MEASR\\_COMP\\_SET](#).

## Configuring Aggregation Criteria Source Types

The options in the **Source Type** and **Source Entity** drop-down lists used when configuring Dimensions, Criteria, and Individually Managed Items are defined in the Aggregation Criteria Source Type (D1-CriteriaSourceTypeLookup) extendable lookup. The measuring component set business objects reference this extendable lookup.

Each of the base package Source Type values (Characteristic, Identifier, Market Participant, and Table) are records in this extendable lookup. The Source Entity values for each of these are defined in the corresponding record.

For example, the “Table” Source Type defines the base package “Table” Source Entity values (Device, Device Event, Measuring Component, Service Point, Usage Subscription, and Usage), along with criteria path details for each (based on data source class).

If an implementation requires Source Type or Source Entity values that differ from the base package, custom extendable lookup values can be created.

When for creating custom values for this extendable lookup, start from an existing extendable lookup value. Select the value that most closely matches your requirements and use the **Duplicate** function to create a copy, and edit as needed.

## Configuration Step-by-Step

This section outlines the steps involved when configuring dynamic aggregation.

## **Create Device and Service Point Administrative Data**

Many of the objects used in dynamic aggregation reference other device- and service point-related administration data, such as measuring component types, service point types, usage subscription types, etc. Make sure this data is in place before configuring entities used with dynamic aggregation.

## **Create Data Sources**

Create data sources for each source of data from which data will be aggregated. Note that implementations can have multiple data sources of each class with different data type configuration (Measuring Component Types, Item Types, Usage Subscription Types, etc.). For example, an implementation with 15 measuring component types might want to aggregate data differently based on subsets of measuring component types. In this case, each subset of measuring component types could be defined on a different data source.

If applicable, create custom Template SQL extendable lookup values and add them to Data Source business objects as appropriate.

## **Create Aggregation Measuring Component Types**

Create the aggregation measuring component types that will be used to define the attributes of the measuring components that will be created during aggregation processing.

Aggregation measuring component types reference an appropriate Data Source. Continuing the example above, each subset of measuring component types (each defined on a separate data source) would require a separate aggregation measuring component type.

## **Create Aggregation Groups**

Create the aggregation groups that will be used to control aggregation processing, including aggregation groups for both foundation and composite aggregation processing.

Note: When initially creating aggregation groups, define only the basic data for each (name, category, and optional time zone). Add measuring component sets to aggregation groups when creating the latter in the next step.

## **Create Measuring Component Sets**

Create the measuring component sets that will define the “buckets” by which the aggregated data will be grouped.

Measuring component sets reference aggregation measuring component types and aggregation groups.

Create custom Source Type records (if applicable).

## **Revise Aggregation Groups (if needed)**

After creating measuring component sets, adjust the sequence of each within its aggregation group as appropriate. For example, this would be necessary if measuring component sets are created and added to aggregation groups in an order that differs from their intended sequence.

## **Extending Dynamic Aggregation**

The dynamic aggregation functionality provides extensive flexibility through configuration of data sources, measuring component types, and measuring component sets to handle complex aggregation requirements. However, some implementations may require functionality and configuration options beyond that provided in the base package. For instance, an implementation may need to aggregate data of a source and type not covered by the base package data sources or use different dimensions and criteria or queries for aggregation processing.



In circumstances like these, the dynamic aggregation functionality can be extended through use of the Oracle Utilities Application Framework's Configuration Tools (see [Configuration Tools](#)) and other options. This section outlines some of the possible approaches to extending this functionality.

**Data Source Business Objects:** If an implementation requires aggregation of a data type of source beyond those provided with the base package data source business objects, custom business objects can be created to support this requirement. Key considerations when creating custom data source business objects include:

- Configuration options such as “Sourced Measuring Component Types” or “Sourced Usage Subscription Types”
- Values for the “Aggregation SQL”, “Dimension Scanner SQL”, and “Find Constituents SQL” business object options from the Data Source SQL extendable lookup.
- Algorithms for the “Generate SQL For Data Source” system event that leverage the configuration options defined for the data source

**Data Source SQL Extendable Lookup Values:** If an implementation requires template SQL that differs from the base package, custom values for the Data Source SQL extendable lookup can be created and referenced on the data source business object. When creating custom template SQL, start from an existing extendable lookup value. Select the value that most closely matches the requirements and use the **Duplicate** function to create a copy, and edit the SQL as needed.

**Aggregation Measuring Component Type Business Objects:** If an implementation requires capturing data for measuring component types not provided in the base package, the base package aggregation measuring component type business objects can be extended as appropriate. Key considerations when creating custom measuring component type business objects include:

- Algorithms for the “Generate SQL For MC Type” system event that leverages the Value Identifiers and other information defined for the measuring component type

**Aggregation Measuring Component Business Objects:** If an implementation requires capturing data for measuring components not provided in the base package, the base package aggregation measuring component business objects can be extended as appropriate. Key considerations when creating custom measuring component business objects include:

- Algorithms for the “Generate SQL For Aggregator MC” system event that leverages the Value Identifiers and other information defined for the measuring component type
- Algorithms for the “Find Constituents” system event that uses the “Generate SQL for Aggregator MC” algorithm, data source configuration, and other configuration to find constituent data for aggregation
- Algorithms for the business object's “Active” state, including data aggregation and value derivation

**Measuring Component Set Business Objects:** If an implementation requires capturing data for measuring component sets not provided in the base package, the base package aggregation measuring component set business objects can be extended as appropriate. Key considerations when creating custom measuring component set business objects include:

- Algorithms for the “Generate SQL For MC Set” system event
- Algorithms for the business object's lifecycle states, as appropriate

**Aggregation Criteria Source Type Extendable Lookup Values:** If an implementation requires Source Type or Source Entity values for measuring component sets that differ from the base package, custom extendable lookup values can be created. When creating custom values for this extendable lookup, start from an existing extendable lookup value. Select the value that most closely matches the requirements and use the **Duplicate** function to create a copy, and edit as needed.

## Defining Consumption Synchronization Options

# Configuring Consumption Synchronization

---

**NOTE:** Refer to [Introduction to Consumption Sync](#) for additional functional information about how consumption synchronization works.

---

Keeping consumption synchronized between two measuring components that meter the same quantity but at different frequencies is a complicated task. As such the configuration for this process is diffuse and requires settings across several key areas of the system to be aligned. This section will help guide you through the process of configuring consumption synchronization.

The consumption synchronization process is really a collection of processes within Oracle Utilities Meter Data Management that all work together to ensure that quantities between related channels remain consistent:

- **Estimation VEE Rules:** several rules align consumption between related channels. These rules allow estimations to be refined based on higher quality measurements from a related channel. These rules are core to the consumption synchronization process. In simple scenarios where a few intervals are missing for an interval measuring component these rules are all that are necessary for synchronization with the related channel (note: it requires that the related channels data for that same time period has already been processed through to final measurements). For more information on these rules please visit the following sections:
  - Interval Adjustment from Scalar
  - Scalar Calculation from Interval
  - Scalar Proration
  - Sum Check
  - Final Measurement Validation

---

**NOTE:** Refer to [About IMD Estimations](#) for more information about these rules

---

- **Periodic Estimation:** both the interval and scalar variations of periodic estimation play an important role in consumption synchronization by ensuring that both channels of data are without gaps. In simple scenarios where one channel is missing data and the other is not periodic estimation is all that is require to produce synchronized consumption. It is important to note that this process itself does not perform estimations but rather it is responsible for creating estimation initial measurements to trigger the estimation VEE rules.
- **Consumption Synchronization Activities:** these activities work to fix alignment issues that occur when data for the related channels are processed out of order or when there are complex outage scenarios. These activities are created when higher quality data is received for one channel and the related channel has measurements that are eligible to be recalculated and adjusted to align the total consumption for the period across the two channels. It is important to note that this process itself does not perform estimations but rather it is responsible for creating estimation initial measurements to trigger the estimation VEE rules.

## Device Configuration Type

As a default the system will not generate consumption synch activities for related measuring components. Turning on consumption synchronization activities is done through a few key fields on the device configuration type:

- **Keep Consumption Reference MC in Sync:** defines if the related MCs should be kept in sync. It can be configured to provide a one way synchronization from primary to secondary or a two way synchronization between primary and secondary.
- **Minimum Condition to Sync Primary MC:** when the secondary measuring component can initiate synchronization of the primary this provides an ability to limit those situations to when the incoming data is of a minimum quality.

- **Sum Check VEE Exception Type:** provides further ability to limit initiation of synchronization. When configured the synchronization activities will only be created when the initial measurement being processed encounters a VEE exception of the type configured. More specifically, a sum check VEE exception which will indicate that the two channels are out of synch by a minimum tolerance amount. This can be used to avoid synchronization either when there is no difference between the channels or when there is only a small difference between the channels.

---

**NOTE:** Additional detail about these fields can be found in the embedded help for the device configuration type.

---

## Register Auto-Read Measuring Component Type

The configuration available for the register auto-read measuring component type has an indirect impact on the consumption synchronization process. This configuration is primarily intended to allow for a register to re-evaluate previously created estimations when new more accurate readings are received even when no related measuring components exist. Where this has impact to the consumption synchronization process is that when a new scalar reading is received after a period of estimation it will result in the time period for that new initial measurement being expanded into the past. This is because any estimates prior to this new higher quality initial measurement will be logically removed and the start reading for the initial measurement will in turn be the last non-estimated measurement prior to the initial measurement. This creates an initial measurement that spans the entire period for which estimations exist and as a result when a consumption synchronization activity is generated it will result in that same period of time being re-evaluated on the related measuring component.

This functionality is controlled by a few key fields on the register auto-read measuring component type:

- **Ignore Estimates as IMD Start Reading:** controls whether estimates directly previous to newly received incoming initial measurement should be logically removed when that newly received initial measurement data is non-estimated.
- **Flag Future Estimates as Do Not Use:** controls whether estimates that come directly after newly received incoming initial measurements should be logically removed when that newly received initial measurement data is non-estimated
- **Actuals or Corrections Initial Re-Estimation:** works in tandem with the above two fields. When either scenario results in measurements being logically removed this field, when turned on, will reset the last contiguous measurement date/time for the measuring component making it eligible once more for periodic estimation. With the end result being that those estimated measurements that were removed would recreated as new estimates.

## Measuring Components

In order for consumption synchronization to work it must know that two measuring components are related in a way that indicates they are measuring the same consumption. This is achieved by configuring the "Consumption Reference Measuring Component" field on the measuring component.

Not only does this establish the relationship but it also establishes which measuring component is considered to be primary and which is considered to be secondary.

A measuring component is considered to be secondary when it holds the relationship to the Consumption Check Measuring Component (the primary measuring component).

For example, consider the following related measuring components.

- Scalar Measuring Component: ER-SM-007 / 1 / Electric kWh Daily
- Interval Measuring Component: ER-SM-007 / 2 / Electric kWh 60min

If the scalar measuring component is the primary measuring component, it does NOT specify a "Consumption Reference Measuring Component", and the interval measuring component specifies the scalar measuring component as the "Consumption Reference Measuring Component".

If the interval measuring component is the primary measuring component, it does NOT specify a "Consumption Reference Measuring Component", and the scalar measuring component specifies the interval measuring component as the "Consumption Reference Measuring Component".

It is important to note that pending initial measurements for the secondary measuring component are processed by the [D1-IMD](#) batch process after the initial measurements for the primary measuring component. This ensures that the primary

measuring component's final measurements will be available to the secondary measuring component's initial measurements VEE process to provide better quality estimations and validations.

## Initial Load and Manual Initial Measurement Algorithms

Key to the consumption synchronization process are the algorithms that reside on initial load and manual initial measurements for both scalar and interval measuring components. These algorithms contain logic to identify final measurements on a related channel that are consumption synchronization eligible (typically estimated).

These algorithms allow definition of:

- The consumption synchronization activity created
- The condition range that defines consumption synchronization eligible final measurements

Please refer to the algorithm type descriptions for more information:

Algorithm Type	Description	Where used
D1-UPD-DTMC	Update Latest Measurement Date/Time on MC with Consumption Sync	D1-InitialLoadIMDInterval D1-ManualIMDInterval
D1-UDTSCMCRE	Update Latest Measurement Date/Time on Scalar MC with Consumption Sync	D1-InitialLoadIMDScalar D1-ManualIMDScalar

## Consumption Synchronization Activities

The consumption synchronization activities are initiated by initial measurements and are responsible for generating the appropriate estimation initial measurements to re-evaluate any consumption synchronization eligible final measurements for the related measuring component being processed.

These activities can be associated to one or more initiating initial measurements and are able to handle a broad combination of time periods which are not required to be contiguous.

If any generated estimation initial measurement does not finalize processing will be halted and details about the failed estimation initial measurement will be provided.

The following table identifies the catalogue of consumption synchronization activities:

Activity Type	Description	Activity Business Object
Related MC Consumption Sync - Scalar	This activity is generated to re-evaluate consumption sync eligible final measurements on scalar measuring components. One estimation initial measurement will be created per measurement needing to be re-evaluated.	D1-RelMCREScalar
Related MC Consumption Sync - Interval	This activity is generated to re-evaluate consumption sync eligible final measurements on interval measuring components. One estimation initial measurement will be created per contiguous set of interval measurements needing to be re-evaluated. Note the generated initial measurements will include non-consumption sync eligible final measurements which will help to feed into the estimation process to provide more accurate results.	D1-RelMCREInterval

Gap Period Consumption Sync

This activity will re-evaluate both measuring components in the relationship for a wider time period than the initiating initial measurement. Specifically the time period will be the total contiguous period of consumption sync eligible final measurements across both channels in the relationship.

D1-GapPeriodConsumpnSync

Each consumption synchronization activity has an algorithm that performs the core logic of the consumption synchronization process.

These algorithms allow definition of:

- The condition range that defines consumption synchronization eligible final measurements

Please refer to the algorithm type descriptions for more information:

Algorithm Type	Description	Where used
<a href="#">D1-RE-SCMC</a>	Scalar MC Consumption Sync	D1-RelMCREScalar
<a href="#">D1-RE-INTVMC</a>	Interval MC Consumption Sync	D1-RelMCREInterval
<a href="#">D1-GAPCSYNC</a>	Gap Period Consumption Sync	D1-GapPeriodConsumpnSync

## Periodic Estimation

The algorithm that initiates periodic estimation which is plugged in to the Smart Meter device business object has a key configuration setting related to consumption synchronization:

- **MC Type to Process First:** determines whether interval or scalar measuring components should be estimated first. This should be set to process whichever measuring component type is considered to be primary first.

Please refer to the algorithm type description for more information:

Algorithm Type	Description	Where used
<a href="#">D1-PERESTM</a>	Periodic Estimation	D1-SmartMeter

## Related Batch Controls

There are a few batches involved with Consumption Synchronization:

- **Related MC Consumption Sync ([D1-RMCRE](#)):** this processes any pending consumption synchronization activities.
- **Related MC Consumption Sync - Retry Act ([D1-RMCRR](#)):** this retries any consumption synchronization activities that fail to the Issue Detected state.

## Defining Dashboard Options

### Configuring the MDM Operational Dashboard

This section describes the process for configuring the MDM Operational Dashboard.

Refer to the [Using the MDM Operational Dashboard](#) section of the *Oracle Utilities Meter Solution Business User Guide* for a information on this functionality.

Configuration for the MDM Operational Dashboard is performed by adding or changing a Master Configuration. You can access the portal from the **Admin > General > Master Configuration**.

Once the Master Configuration search screen returns, configure both the **MDM Operational Dashboard Configuration** record. Use the Add button beside the record to configure for the first time. If a record has already been added, then click the Edit button instead. Use the embedded help to guide you through the meaning of each configuration field.

This dashboard also leverages a method of pre-staging data known as Statistics Snapshots. Refer to the *Framework Administrative User Guide* for more information on Statistics Snapshots. For additional information see [About Statistics](#) in the Oracle Utilities Application Framework *Administrative User Guide*.

A method for tracking Performance Targets (also known as Service Level Agreements) is available within the MDM Operational Dashboard as well. To understand how to set up Performance Targets, refer to [About Performance Targets](#) in the Oracle Utilities Application Framework *Administrative User Guide*. The Performance Targets you configure will then be leveraged on the **Batch Performance** and/or **Database** tabs of the MDM Operational Dashboard.

## Configuring the Customer Operational Dashboard

This section describes the process for configuring the Customer Operational Dashboard.

Refer to the [Using the Customer Operational Dashboard](#) section of the *Oracle Utilities Customer To Meter Business User Guide* for more information on this functionality.

Configuration for the Customer Operational Dashboard is performed by adding or changing a Master Configuration. You can access the portal from the **Admin > General > Master Configuration**.

Once the Master Configuration search screen returns, configure the **Customer Operational Dashboard Configuration** record. Use the Add button beside the record to configure for the first time. If a record has already been added, then click the Edit button instead. Use the embedded help to guide you through the meaning of each configuration field.

This dashboard also leverages a method of pre-staging data known as Statistics Snapshots. Refer to [About Statistics](#) in the *Oracle Utilities Application Framework Administrative User Guide* for more information.

A method for tracking Performance Targets (also known as Service Level Agreements) is also available in the Customer Operational Dashboard. To understand how to set up Performance Targets, refer to [About Performance Targets](#) in the *Oracle Utilities Application Framework Administrative User Guide*. The Performance Targets you configure will then be leveraged on the **Batch Performance** page of the Customer Operational Dashboard.

## Configuring the Service Order Operational Dashboard

This section describes the process for configuring the Service Order Operational Dashboard.

Refer to the [Using the Service Order Operational Dashboard](#) section of the *Oracle Utilities Meter Solution Business User Guide* for more functional information.

Configuration for the Service Order Operational Dashboard is performed by adding or changing a Master Configuration. You can access the portal from the **Admin > General > Master Configuration**.

Once the Master Configuration search screen returns, locate the **Service Order Management Master Configuration** record. Use the Add button beside the record to configure for the first time. If a record has already been added, then click the Edit button instead. The **Chart Options** section is the primary area for adding configuration that will affect the dashboard. Use the embedded help to guide you through the meaning of each configuration field.

## Configuring the Service Order Trends Dashboard

This section describes the process for configuring the Service Order Trends Dashboard.

Refer to the [Using the Service Order Trends Dashboard](#) section of the *Oracle Utilities Meter Solution Business User Guide* for more functional information.

Configuration for the Service Order Trends Dashboard is performed by adding or changing a Master Configuration. You can access the portal from the **Admin > General > Master Configuration**.

Once the Master Configuration search screen returns, locate the **Service Order Management Master Configuration** record. Use the Add button beside the record to configure for the first time. If a record has already been added, then click the Edit button instead. The **Chart Options** section is the primary area for adding configuration that will affect the dashboard. Use the embedded help to guide you through the meaning of each configuration field.

## Defining Measurement Reprocessing Options

### Configuring Measurement Reprocessing

This section describes the process for configuring Measurement Reprocessing.

Refer to the [About Measurement Reprocessing](#) section of the *Oracle Utilities Meter Solution Business User Guide* for more functional information.

#### Activity Type Configuration

Configuration for Measurement Reprocessing is performed by adding or changing an Activity Type. You can access the portal from the **Admin > Communication > Activity Type**.

Once the Activity Type search screen returns, locate the following records:

- **Measurement Reprocess Activity - Interval:** this Activity Type handles measurement reprocessing for interval Measuring Components.
- **Measurement Reprocess Activity - Scalar:** this Activity Type handles measurement reprocessing for scalar Measuring Components.

Use the Add button beside the record to configure for the first time. If a record has already been added, then click the Edit button instead. Use the embedded help to guide you through the meaning of each configuration field. By adding these Activity Types you are activating the process within Oracle Utilities Meter Data Management that will monitor changes to either the Measuring Component multiplier changes or Install Event installation constant. If either of these attributes change for a device, then a new Activity will be created that attempts to reprocess the measurements for the affected period.

#### Related Batch Controls

There are a few batches involved with Measurement Reprocessing:

- **Measurement Reprocessing Monitor (D1-MRAC):** this processes any new Measurement Reprocessing activities that are created.
- **Measurement Reprocessing - Retry Monitor (D1-MRER):** this retries any Measurement Reprocessing activities that fail to the Issue Detected state.

## Information Lifecycle Management (ILM)



# Understanding Information Lifecycle Management (ILM)

Information Lifecycle Management (ILM) is a separately licensable component of Oracle Utilities Customer to Meter that works in tandem with Oracle database feature of the same name.

For further background on the overall ILM process see the [Information Lifecycle Management](#) chapter of the Oracle Utilities Application Framework *Administrative User Guide*.

This section provides an overview of the components used by the Information Lifecycle Management functionality, including:

- ILM-Enabled Maintenance Objects: Single Retention Period
- ILM-Enabled Maintenance Objects: Multiple Retention Periods
- Adjusting Eligibility of Non-Final Transactions
- Archive Eligibility Hierarchy
- Multiple Retention Period Eligibility Crawling Strategies

Refer to the [Information Lifecycle Management](#) chapter of the Oracle Utilities Application Framework *Administrative User Guide* for general information about how ILM works with OUAF applications.

## ILM-Enabled Maintenance Objects: Single Retention Periods

The majority of Maintenance Objects support a single retention period. They can either inherit the system wide retention days that are configured on the ILM Configuration master configuration or they can have a retention period specified via the Maintenance Object option ILM Retention Period in Days.

For these objects either the Maintenance Object specific retention period or the system wide retention period will apply to all transactions.

## ILM-Enabled Maintenance Objects: Multiple Retention Periods

For several Maintenance Objects the retention period may vary based on the type of transaction. For example, initial measurement data for non-billed units of measure such as voltage might be archived much more rapidly than measurements that feed into the production of billing determinants.

These maintenance objects are differentiated from the single retention period maintenance objects in a few ways:

- The primary table for the entity has an additional column Retention Period (RETENTION\_PERIOD) that captures the retention period in days for each transaction. This value is populated based on the ILM Configuration - MDM master configuration.
- There is additional configuration available on the ILM Configuration -MDM master configuration to define multiple retention periods by maintenance object specific criteria
- Initial Measurement Data: retention periods can be specified by type of IMD (Interval vs Scalar), and primary UOM of the measuring component
- Device Events: retention periods can be specified by device event type category
- Activities: retention periods can be specified by activity type category
- There is a special ILM Crawler batch that supports crawling transactions by their specific retention periods
- A combination of each transactions ILM Date and Retention Period are considered when identifying records to evaluate for eligibility. Refer to batch controls ILM Crawler - Device Event ([D1-DECRL](#)), ILM Crawler - IMD ([D1-IMDCL](#)), or ILM Crawler - Activity ([D1-ACTCR](#)) for more details.



- There is an additional maintenance object option ILM Date Partition Months which feeds into the ILM Crawler batch to delay processing until all records on a partition would be eligible. This is explained later in this section under the header Multiple Retention Period Eligibility Crawling Strategies.

## Adjusting Eligibility of Non-Final Transactions

As delivered Oracle Utilities Customer to Meter maintenance objects allow non-final transactions to be eligible for archive. This is a logical approach when transactional data has a very long retention period (e.g. 3 year old non-final Initial Measurement Data is unlikely to have relevance and in many circumstances shouldn't be finalized).

If non-final transactions should not be eligible for archive this can be controlled at either the Maintenance Object (MO) or Business Object (BO) level:

- **MO - ILM Restrict By Status (Y/N):** Setting this to "Y" opts into the ability to restrict archiving by status, this is required to be set for either of the MO or BO level restrictions to be considered. To enforce the status it requires that either the **ILM Restrict By BO Final Status (Y/N)** or **ILM Final Status Field Value** options be configured as well.
- **MO - ILM Restrict By BO Final Status (Y/N):** Setting this to "Y" indicates the transactions for the MO must be in a final status to be eligible for ILM. A status is considered to be final based on the BO lifecycle configuration. This can be overridden by the BO option **Final Status Required for Archive (Y/N)**. This is only applicable for an MO that is maintained by business objects.
- **BO - Final Status Required for Archive (Y/N):** Setting this to "Y" indicates the transactions for this particular BO must be in a final status. This setting overrides the MO level **ILM Restrict By BO Final Status (Y/N)**.

The following table helps to illustrate how these three settings impact whether a given transaction must be in a final status:

• MO: ILM Restrict By Status	• MO: ILM Restrict By BO Final Status	• BO: Final Status Required for Archive	• Final Status Required for Eligibility?
• N	• Y	• Y	• N
• N	• Y	• N	• N
• N	• N	• Y	• N
• Y	• N	• N	• N
• Y	• Y	• N	• N
• Y	• Y	• Y	• Y
• Y	• N	• Y	• Y
• Y	• Y	• Not Provided	• Y
• Y	• N	• Not Provided	• N

**NOTE:** There are a few MOs that do not support the BO level setting. To best understand how these fields are interpreted for an MO refer to the detailed description of the algorithm plugged into the ILM Eligibility system event for the MO. For example, the generic ILM Eligibility Based on Status ([F1-ILMELIG](#)) algorithm does not support the BO level override option.

## CCB ILM Enabled MOs

The table below summarizes details of the eligibility algorithms for each maintenance object supported by ILM. The CCB MOs support only a single retention period and many CCB MOs do not support the BO level setting. Information on this table includes:

- **ILM Eligibility Algorithm Type:** The algorithm type description contains and specific consideration that are considered when determining if the record is eligible for ILM. Please review the algorithm type for the details including object cascading.
- **Restrict Status by:** If the framework ILM eligibility algorithm is used, the restricted status as delivered with the system are shown.

Maintenance Object	ILM Eligibility Algorithm Type	RestrictedStatus by
Adjustment	C1-ADJILMELG	N/A
Bill	C1-ILMELG-BL	N/A
Bill Segment	C1-ILMELG-BS	N/A
Billable Charge	F1-ILMELIG	Canceled
Usage	F1-ILMELIG	Not Restricted
Case	F1-ILMELIG	Closed
Order	F1-ILMELIG	Complete, Canceled
Field Activity	F1-ILMELIG	Complete, Canceled
Meter Read	C1-ILMELG-MR	N/A
Payment Event	C1-PEVILMELG	N/A
Customer Relationship Request	F1-ILMELIG	Not Restricted
Match Event	C1-MEVILMELG	N/A

## Archive Eligibility Hierarchy

The table below summarizes details of the eligibility algorithms for each Oracle Utilities Meter Data Management maintenance object supported by ILM. Information on this table includes:

- **Cascaded By:** Indicates how archiving for transactions for the maintenance object is initiated. For example, device events can be archived by themselves or as part of a related activity.
- **ILM Date Computation:** Indicates the type(s) of transactions that impact the calculation of the ILM Date for transactions for the maintenance object. "Itself" indicates that the ILM date is not impacted by other transactions.
- **Specific Eligibility Considerations:** Indicates specific considerations used by the eligibility algorithm.
- **Cascaded Transactions:** Indicates other transactions that are archived when transactions for the maintenance object are archived. For example, VEE exceptions are archived with initial measurements.

Maintenance Object	Cascaded By	ILM Date Computation	Specific Eligibility Considerations	Cascaded Transactions
Initial Measurement		Create date	VEE Exceptions must be eligible Associated Related MC Synchronization activity must be complete	VEE Exceptions

VEE Exception	Initial Measurement	Earlier of related Initial Measurement or VEE Exception Create Date	Related Service Issue Monitor must be complete	
Usage Transaction		The latest create date for all related usage transactions	All related usage transactions must be eligible for archiving	Related Usage Transactions
Device Event	Activity	Create date Superseded by paired event create date if earlier (where applicable)	Related paired events must be eligible Related service issue monitor must be complete Related activity must be complete	
Activity	Parent activity	Create date Superseded Device event, child activity, or completion event create date supersede (where applicable)	Cascaded transactions must be eligible Command requests must not be associated to a non-final service issue monitor Command requests must not be associated to an install event on off history entry	Child activities Device events Outbound communications Inbound communications Completion events
Outbound Communication	Activity	Create Date Superseded by initiating activity's create date (where applicable)		Inbound communication
Inbound Communication	Outbound Communication	Create date Superseded by initiating outbound communication create date (where applicable)		Device events

## Proactive Archive Eligibility for Transactional Data

Some types of transaction data, including Device Events, Initial Measurement Data, and Usage Transactions can be analyzed for archive eligibility as they are received rather than waiting until their retention period has expired. This means that these records are judged ready to be archived as they are created and do not need to be read, analyzed, and updated during the ILM crawling process. This greatly reduces the number of records to be crawled at the end of the retention period and shortens the window of time required for ILM crawling. This section outlines how the ILM Archive switch (ILM\_ARCH\_SW) is set to “Y” (Yes) for records of these types as part of their initial processing.

- **Device Events:**

- The ILM Archive switch is set to “Y” for device events that meet the following criteria:
  - No service issue monitors were created for the device event
  - The device event is not a paired device event
- The ILM Archive switch is set to “Y” for device events via the following algorithms:
  - Create Service Issue Monitor from Device Event (D1-DVCEVTSIM)

- Create Service Issue Monitor from Device Event for Paired Event (D1-PRDVEVSIM)
- **Initial Measurement Data:**
  - The ILM Archive switch is set to “Y” by default for initial measurements (this is a different approach than the other record types).
  - The ILM Archive switch is set to “N” for initial measurements that meet the following criteria:
    - A consumption synchronization activity has been created for the initial measurement
    - A service issue monitor initiated from a VEE exception related to the initial measurement
  - The ILM Archive switch is set to “N” for initial measurements that meet the above criteria via the following algorithms:
    - Update Latest Measurement Date/Time on Scalar MC with Consumption Sync (D1-UDTSCMCRE)
    - Update Latest Measurement Date/Time on MC with Consumption Sync (D1-UPD-DTMC)
    - Create Service Issue Monitor from VEE Exception (D2-VEEEXCSIM)
- **Usage Transactions:**
  - The ILM Archive switch is set to “Y” when a usage transaction enters the “Sent” or “Discarded” state (or the “Calculated” or “Discarded” states for a sub-usage transaction ) via the following algorithms:
    - Send Usage (D2-SEND-USG)
    - Set ILM Switch to ‘Y’ (D1-SETILMSWY)

## Multiple Retention Period Eligibility Crawling Strategies

When multiple retention periods are defined for a maintenance object each record will have its retention period written to the database at the time of record creation. This retention period is then used to identify when the record will be ready for eligibility evaluation (aka crawling).

---

**NOTE:** As specified in the Oracle Utilities Meter Data Management Database Administrator's Guide each unique retention period for the maintenance object will be a sub-partition within a given ILM date partition.

---

The system supports two methodologies for doing so:

- Evaluate Individual Records:
  - This is our default approach
  - This is the standard approach to evaluating ILM retention for all maintenance objects with a single retention period
  - The ILM date for each record will be compared against the current date less the retention period for that type of record. Simply stated, any records older than the retention period will be evaluated for eligibility.
  - In this option we will process a portion of a partition each day and only once we had processed the entire partition would the DBA be able to take an archiving action on the partition
  - This results in many visits to the partition to determine eligibility
  - The image below illustrates how the evaluate individual records method will crawl one day of records on a partition and sub-partition each day until the retention period for the last day of the partition had expired. All records would then be archived together when the last day of the partition was marked as eligible. This results in daily processing of small amounts of records but frequent visits to the partition.



- Evaluate the Entire Partition
- This option will be enabled by configuring the ILM Date Partition Months in the maintenance object options
- In this option all records on a ILM date partition retention period sub-partition will be evaluated at the same time.
- For example, for a monthly partitioning strategy in the month of January we would not evaluate any records in the January partition until January 31st had reached the end of its retention period.
- This means that we would evaluate the 1st through the 31st all at one time
- This option should typically result in a single visit to the partition to determine eligibility
- 
- The image below illustrates how the evaluate entire partition method will only crawl records from a given partition and sub-partition when all records on that partition are eligible to be evaluated. Therefore, when the last day of the partition is ready to be evaluated the entire partition will be evaluated. This results in periodic processing with, and in many cases, a single visit to the partition for ILM purposes.

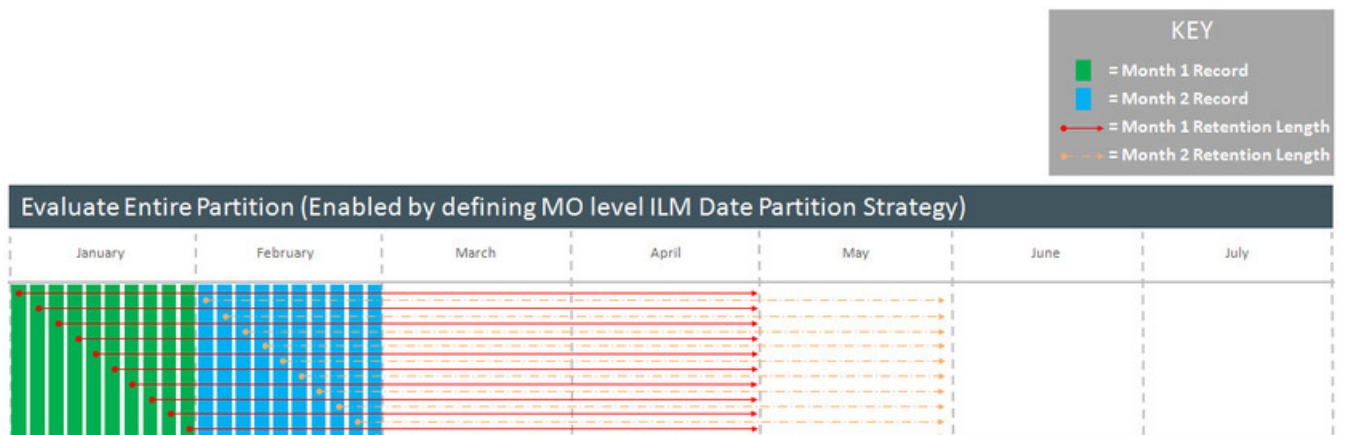

## Configuring Information Lifecycle Management (ILM)

For additional information on configuring ILM, see [Enabling ILM for Supported Maintenance Objects](#) in the Oracle Utilities Application Framework *Administrative User Guide*.

The tasks described in the OUAF guide must be applied in conjunction with the task of configuring the Oracle Utilities Meter Data Management specific master configuration.

You can access the portal from the **Admin > General > Master Configuration**.

Once the Master Configuration screen returns, locate the following record:

- **ILM Configuration - MDM:** this enables multiple retention periods to be configured for Initial Measurements, Device Events, and Activities.

## Related Eligibility Algorithms

There are a several Oracle Utilities Meter Data Management specific algorithms involved with ILM refer to the detailed description of the algorithm type of each algorithm for more information about the functionality each provides:

1. **ILM Eligibility - Activity (D1-ILMELGACT):** determines eligibility of Activities and cascades child Activities, Communication Out, Communication In, Device Events, and Completion Events.
2. **ILM Eligibility - Communication In (D1-ILMELGCI):** determines eligibility of Communication In.
3. **ILM Eligibility - Communication Out (D1-ILMELGCO):** determines eligibility of Communication Out and cascades Communication In.
4. **ILM Eligibility - IMD (D1-ILMELGIMD):** determines eligibility of Initial Measurement data and cascades VEE Exceptions.
5. **ILM Eligibility - Device Event (D1-ILMELGDE):** determines eligibility of Initial Measurement data and cascades VEE Exceptions.
6. **ILM Eligibility - Usage Transaction (D1-ILMELIGUT):** determines eligibility of Usage Transactions.
7. **ILM Eligibility - Usage Transaction Exception (D1-ILMELGUEX):** determines eligibility of Usage Transaction Exceptions.
8. **ILM Eligibility - VEE Exception (D1-ILMELGVEX):** determines eligibility of VEE Exceptions.

The following provides additional information beyond that provided in the ILM Eligibility - Activity (D1-ILMELGACT) algorithms' detailed descriptions on how specific activity types are handled:

- **Request Orchestration Activities:** Request orchestrations also archive any child activities that were created, and those child activities archive any child activities or data (completion events, device events, etc.).
- **Field Activities / Command Activities:** Field activities and command request activities are archived either as part of a request orchestration or by themselves. When a field activity/command request is archived, it also archives any of the following child transactions:
  - Update/Cancel Orchestrators
  - Communication Out
  - Communication In
  - Completion Event
- **Non-Dispatchable Activities:** Non-Dispatchable activities archived either as part of a request orchestration or by themselves. When a non-dispatchable activity is archived it also archives child completion events.
- **Orchestration Maintenance Activities:** Orchestration Maintenance activities are only archived by themselves if they do not have a related activity. When an orchestration maintenance activity is archived it also archives any of the following child transactions:
  - Communication Out
  - Communication In
- **Device Event Activities:** Presently device event activities are limited to outages which have an initiating and an ending device event. These types of activities cannot be archived until their related device events are either archived or ready to archive. However the device events do not have to wait for the activity to archive so the device events are not updated with the activity's ILM date.

- **Bulk Activities:** Bulk Activities are comprised of the Bulk Header and the Bulk Request/Response, and depending on how the header was created there will be one header to many bulk requests/responses. The Bulk Header will only be eligible for archive if all related Bulk Request activities are also eligible for archiving. All related bulk activities are archived together. Bulk activities also generate one-to-many command request activities. Those individual command activities are archived separately.
- **Payload Statistics Activities:** Payload Statistics activities can either be the Payload Summary record or the Payload Statistic record. Eligibility is based on the Payload Statistics activity, which is only be eligible for archiving if all the related Payload Summary and Payload Error activities are also eligible for archiving. These activities are only archived by themselves if they do not have a related activity. Otherwise both the payload statistics and the payload summary activities are archived at the same time.
- **Extract Request Activities:** These activities are used to request data from the head-end system on a periodic basis. Extract request activities should be in a final state prior to being archived.
- **Other Activities:** Other types of activities can be archived provided they do not require any special logic for handling for archiving purposes, such as checking for related data. These activity types can archive without checking related transactions:
  - Consumption Sync
  - Dimension Scanner
  - Error Activity
  - Measurement Quantity (deprecated)
  - Meter Read Download Activity
  - Suppression
  - Usage Transaction Correction Processor

In the event that your implementation uses custom activity types that require special handling, a custom algorithm should be created and added prior to the base package algorithm to preemptively handle the activity type category.

## Related Batch Controls

There are a several Oracle Utilities Meter Data Management specific batch controls involved with ILM:

1. **ILM Crawler - Activity (D1-ACTCR):** identifies and executes eligibility evaluation for Activities. This batch control supports multiple retention periods.
2. **ILM Crawler - Communication In (D1-CICRL):** identifies and executes eligibility evaluation for Communication In.
3. **ILM Crawler - Communication Out (D1-COCRL):** identifies and executes eligibility evaluation for Communication Out.
4. **ILM Crawler - Device Event (D1-DECRL):** identifies and executes eligibility evaluation for Device Events.
5. **ILM Crawler - IMD (D1-IMDCL):** identifies and executes eligibility evaluation for Initial Measurement Data. This batch control supports multiple retention periods.
6. **ILM Crawler - Usage Transaction Exception (D1-UEXCL):** identifies and executes eligibility evaluation for Usage Transaction Exceptions.
7. **ILM Crawler - Usage Transaction (D1-UTCRL):** Identifies and executes eligibility evaluation for Usage Transactions.
8. **ILM Crawler - VEE Exception (D1-VEXCL):** Identifies and executes eligibility evaluation for VEE Exceptions.

For additional details see the [Batch Processes](#) section the Oracle Utilities Application Framework *Administrative User Guide*.

# Defining Outage Storm Mode Options

## Configuring Outage Storm Mode

This section describes the process for configuring Outage Storm Mode.

---

**NOTE:** Refer to the [About Outage Storm Mode](#) section of the *Oracle Utilities Meter Solution Business User Guide* for more functional information.

---

### Master Configuration settings

Configuration for Outage Storm Mode is performed by adding or changing a Master Configuration. You can access the portal from the **Admin > General > Master Configuratio**

Once the Master Configuration search screen returns, locate the **MDM Master Configuration**. Use the Add button beside the record to configure for the first time. If a record has already been added, then click the Edit button instead. The **Estimation Eligibility For Widespread Outages** section is the primary section that needs to be configured for Outage Storm Mode to be enabled. Use the embedded help to guide you through the meaning of each configuration field.

### Setup Meter Communication Tracking Aggregation

As part of Outage Storm Mode, aggregations are performed to determine the percentage of meter communication that has occurred for an area. The following configuration supports this:

1. Access the portal for Measuring Component Type through **Admin > Device > Measuring Component Type**. Add a new Measuring Component Type using the **Meter Communication Tracking Aggregator Type** (D2-MtrCommTrckngAggregatorType) business object. Follow the embedded help provided for each section. Two areas listed below are crucial to preparing for this specific aggregation:
  - a. When selecting a Measuring Component Business Object for this record, choose the **Meter Communication Tracking Aggregator** Business Object.
  - b. For the Value Identifiers, there are a few metrics that are can be defined as listed on the [D2-AGG-MCTM Algorithm Type](#):
    - a. Read Percentage
    - b. Count of Received Measuring Components
    - c. Count of Total Measuring Components
2. Access the portal for Activity Type through **Admin > Communication > Activity Type**. Add a new record for the Meter Communication Tracking Dimension Scanner Activity Type.
3. Access the portal for Activity through **Main > Communication > Activity Type**. Add a new record for the Activity Type you defined in the prior step.

### Standard Event Name Configuration

If there is a desire to indicate that a widespread outage has ended for a device when it receives certain device events, the **Standard Event Name** Extendable Lookup can be used for this. You can access the portal from the **Admin > General > Extendable Lookup**

Any Device Event that should close out Estimation Suppression Activities must be configured with the "End Estimation Suppression" algorithm ([D2-EN-ESTSUP](#)) in the Additional Processing Algorithms section. This is often configured for "Power Up" events to indicate that normal power flow has resumed for the meter.



## Related Batch Controls

There are a few batches directly involved with Outage Storm Mode:

- **Dimension Scanner (D1-ADS)**: monitors the "Meter Communication Tracking Dimension Scanner" business object. New Aggregator Measuring Components will be created for every applicable Service Type, Postal Code, and Head End in the system.
- **Aggregation Monitor (D2-AGG)**: runs to execute the logic for the "Meter Communication Tracking Aggregator" Measuring Component. This logic will aggregate all meters for the defined Service Type, Postal Code, and Head End. Once the read percentage is found for that day then a measurement will be created for the Aggregator Measuring Component.
- **Estimation Suppression Monitor (D1-ESTSU)**: This batch monitors the Estimation Suppression activities for processing. This batch should be scheduled to run regularly so it can clean up Suppression Activities if they have ended.
- **Widespread Outage (D2-WSO)**: This batch queries the Meter Communication Tracking Aggregators to determine if any have experienced a widespread outage. For any actively in outage mode, then the batch will find all related Service Points and execute the logic on the algorithm plugged into the BO system event of "Estimation Suppression". It's recommended that D2-WSO be scheduled shortly after aggregation D2-AGG.

## Detailed Examples of Outage Storm Mode

### Scenario 1: Meter is marked estimation ineligible then received metered data with outage events

The following configuration settings should be assumed for this example:

Master Config option	Value
Check Widespread Outages	Yes
Read Percentage Days to Examine	7
Percent Drop From Norm - Estimation Ineligible	30.0%
Minimum Device Count For Ineligibility	100
Days Before Becoming Ineligible	0
Fill Missing Data With Zero	No
Days Before Filling Zero	
Maximum Estimation Ineligibility Days	3
Percent Within Norm - Resume Estimation	5.0%

Diagram:

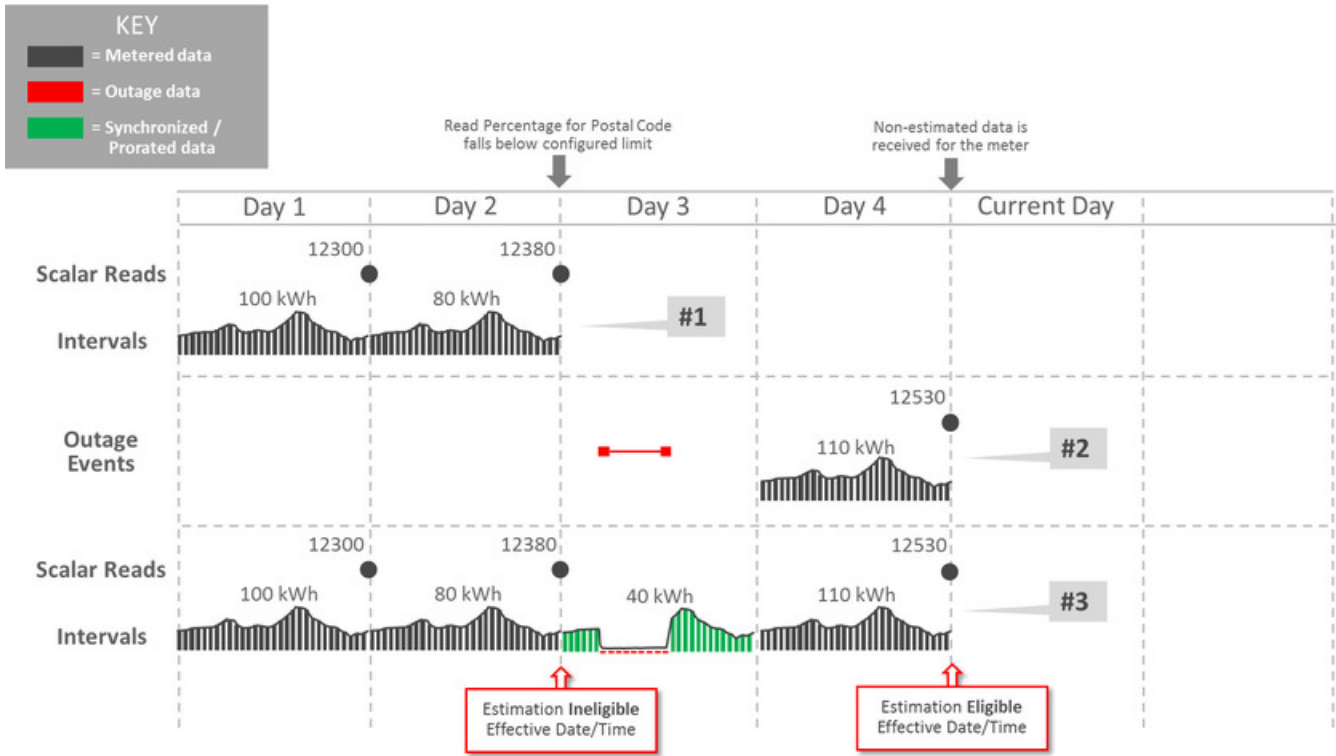

Explanation for diagram:

1. The meter was communicating consistently but then a widespread outage occurs in the same postal code so the meter has an estimation suppression created.
2. Two events are received...a Power Down event and a Power Up event. Also, Regular usage data is received from the meter. The reception of non-estimated data marks the meter as eligible for estimation again.
3. Oracle Utilities Meter Data Management estimates data and takes the two events into account. Intervals marked as outage and filled with zeros are created during the outage period by the D1-SMMTR batch.

## Scenario 2: Meter is marked estimation ineligible, is filled with zeros, then receives actual data

The following configuration settings should be assumed for this example:

Master Config option	Value
Check Widespread Outages	Yes
Read Percentage Days to Examine	7
Percent Drop From Norm - Estimation Ineligible	30.0%
Minimum Device Count For Ineligibility	100
Days Before Becoming Ineligible	0
<b>Fill Missing Data With Zero</b>	<b>Yes</b>
<b>Days Before Filling Zero</b>	<b>0</b>
Maximum Estimation Ineligibility Days	3
Percent Within Norm - Resume Estimation	5.0%

Diagram:

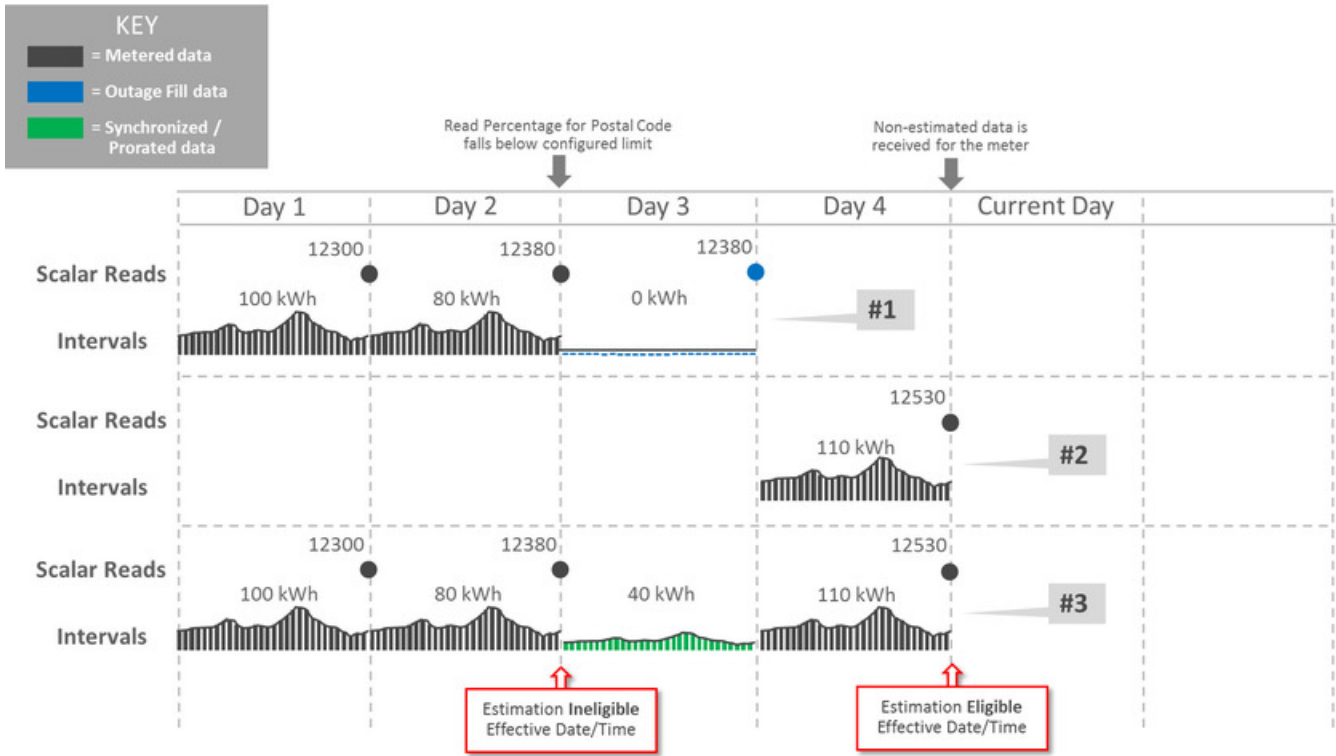

Explanation for diagram:

1. The meter loses communication and periodic estimation fills in outage intervals.
2. The meter reestablishes communication and sends in the latest readings and interval data.
3. Oracle Utilities Meter Data Management creates new data that's synchronized to fall in line with the new data from the meter by the Consumption Sync batch. This data replaces the outage measurements as it balances out to the scalar and interval data.