

Common Core - Electronic Messaging Service User Guide

## **Oracle Banking Payments**

Release 14.3.0.0.0

**Part No. F18473-01**

May 2019

Common Core - Electronic Messaging Service User Guide  
Oracle Financial Services Software Limited

Oracle Park

Off Western Express Highway  
Goregaon (East)  
Mumbai, Maharashtra 400 063  
India

Worldwide Inquiries:

Phone: +91 22 6718 3000

Fax: +91 22 6718 3001

[www.oracle.com/financialservices/](http://www.oracle.com/financialservices/)

Copyright © 2017, 2019, Oracle and/or its affiliates. All rights reserved.

Oracle and Java are registered trademarks of Oracle and/or its affiliates. Other names may be trademarks of their respective owners.

U.S. GOVERNMENT END USERS: Oracle programs, including any operating system, integrated software, any programs installed on the hardware, and/or documentation, delivered to U.S. Government end users are "commercial computer software" pursuant to the applicable Federal Acquisition Regulation and agency-specific supplemental regulations. As such, use, duplication, disclosure, modification, and adaptation of the programs, including any operating system, integrated software, any programs installed on the hardware, and/or documentation, shall be subject to license terms and license restrictions applicable to the programs. No other rights are granted to the U.S. Government.

This software or hardware is developed for general use in a variety of information management applications. It is not developed or intended for use in any inherently dangerous applications, including applications that may create a risk of personal injury. If you use this software or hardware in dangerous applications, then you shall be responsible to take all appropriate failsafe, backup, redundancy, and other measures to ensure its safe use. Oracle Corporation and its affiliates disclaim any liability for any damages caused by use of this software or hardware in dangerous applications.

This software and related documentation are provided under a license agreement containing restrictions on use and disclosure and are protected by intellectual property laws. Except as expressly permitted in your license agreement or allowed by law, you may not use, copy, reproduce, translate, broadcast, modify, license, transmit, distribute, exhibit, perform, publish or display any part, in any form, or by any means. Reverse engineering, disassembly, or decompilation of this software, unless required by law for interoperability, is prohibited.

The information contained herein is subject to change without notice and is not warranted to be error-free. If you find any errors, please report them to us in writing.

This software or hardware and documentation may provide access to or information on content, products and services from third parties. Oracle Corporation and its affiliates are not responsible for and expressly disclaim all warranties of any kind with respect to third-party content, products, and services. Oracle Corporation and its affiliates will not be responsible for any loss, costs, or damages incurred due to your access to or use of third-party content, products, or services.

---

# Contents

<b>1. Preface .....</b>	<b>1-1</b>
1.1 Introduction.....	1-1
1.2 Audience.....	1-1
1.3 Documentation Accessibility.....	1-1
1.4 Organization .....	1-1
1.5 Glossary of Icons.....	1-2
1.6 Related Documents .....	1-2
<b>2. EMS Maintenances .....</b>	<b>2-1</b>
2.1 Introduction.....	2-1
2.2 Message Media Control Maintenance .....	2-1
2.2.1 Maintaining Message Media Control .....	2-2
2.2.2 Specifying File Prefix .....	2-4
2.2.3 Saving Message Media Control Details.....	2-4
2.3 Media Maintenance .....	2-4
2.3.1 Maintaining Message Media Details .....	2-5
2.4 Message Queues Mapping Maintenance .....	2-7
2.4.1 Invoking Message Queue Mapping Maintenance Screen .....	2-8
2.5 Message Queue Maintenance.....	2-9
2.5.1 Maintaining Message Queues .....	2-9
2.6 SWIFT Message Notification Browser .....	2-10
2.6.1 Viewing SWIFT Notification Messages.....	2-10
2.7 SWIFT Net Service Definition.....	2-11
2.7.1 Invoking SWIFTNet Service Definition Screen .....	2-12
2.7.2 Viewing SWIFTNet Service Summary .....	2-13
2.8 SWIFT Local Authentication Maintenance .....	2-13
2.8.1 Invoking SWIFT LAU Maintenance Screen .....	2-13
2.8.2 Viewing SWIFT LAU Summary Details.....	2-15
2.8.3 Processing Outgoing SWIFT LAU .....	2-16
2.8.4 Processing Incoming SWIFT LAU .....	2-16
2.9 Mapping Rule Group .....	2-17
2.9.1 Invoking Rule Group Mapping Screen.....	2-17
2.9.2 Viewing Rule Group Mapping Summary.....	2-18
2.10 Defining Rule Group .....	2-18
2.10.1 Invoking Rule Group Definition Screen.....	2-19
2.10.2 Viewing Rule Group Summary .....	2-20
2.11 Routing Rule Definition.....	2-20
2.11.1 Invoking Routing Rule Definition Screen .....	2-21
2.11.2 Viewing Rule Definition Summary .....	2-23
2.12 Defining Protocol Parameter .....	2-24
2.12.1 Invoking Protocol Parameter Definition Screen .....	2-24
2.12.2 Viewing Protocol Parameter Definition Summary.....	2-25
2.13 File Transfer Adapter Connector Configuration.....	2-25
2.13.1 Invoking File Transfer Adapter Connector Configuration Screen .....	2-26
2.13.2 Viewing File Transfer Adapter Connector Configuration Summary.....	2-27
2.14 Distinguished Name Definition .....	2-28

2.14.1	<i>Invoking Distinguished Name Definition Screen</i> .....	2-28
2.14.2	<i>Viewing Distinguished Name Summary</i> .....	2-29
2.15	Defining Debulk Rule.....	2-29
2.15.1	<i>Invoking Debulk Rule Definition Screen</i> .....	2-30
2.15.2	<i>Viewing Debulk Rule Summary</i> .....	2-31
2.16	Connectivity Operation Manager .....	2-31
2.16.1	<i>Invoking Connectivity Operation Manager Screen</i> .....	2-32
2.17	Outbound File Browser.....	2-33
2.18	Inbound File Browser.....	2-34
2.19	Defining Bulk Preference.....	2-35
2.19.1	<i>Invoking Bulk Preference Definition Screen</i> .....	2-35
2.19.2	<i>Viewing Bulking Preference Definition Summary</i> .....	2-37
2.20	Bulk Monitor.....	2-38
<b>3.</b>	<b>Function ID Glossary</b> .....	<b>3-1</b>

---

# 1. Preface

## 1.1 Introduction

This manual is designed to help acquaint you with the Common Core Electronic Messaging Service module of Oracle FLEXCUBE.

The module supports various types of media. Besides standard media modes like Mail, Telex and SWIFT you can also use other media types supported by the Media Control System (MCS) installed at the node at which the database of your branch is installed. Oracle FLEXCUBE gives native support for media like Mail, Telex, and SWIFT using EMS as the MCS.

You can further obtain information specific to a particular field by placing the cursor on the relevant field and striking <F1> on the keyboard.

## 1.2 Audience

This manual is intended for the following User/User Roles:

Role	Function
Back office data entry clerk	Input functions for contracts
Back office managers/officers	Authorization functions
Product Managers	Product definition and authorization
End of Day operators	Processing during End of Day/Beginning of Day
Financial Controller/Product Managers	Generation of reports

## 1.3 Documentation Accessibility

For information about Oracle's commitment to accessibility, visit the Oracle Accessibility Program website at <http://www.oracle.com/pls/topic/lookup?ctx=acc&id=docacc>.





## 1.4 Organization

This manual is organized as follows:

Chapter	Description
Chapter 1	<i>Preface</i> gives information on the intended audience. It also lists the various chapters covered in this User Manual.
Chapter 2	EMS Maintenances explains the maintenance of various Messaging functions.
Chapter 3	<i>Function ID Glossary</i> has alphabetical listing of Function/Screen ID's used in the module with page references for quick navigation.

## 1.5 Glossary of Icons

This User Manual may refer to all or some of the following icons.

Icons	Function
	Exit
	Add row
	Delete row
	Option List

## 1.6 Related Documents

For further information on procedures discussed in the manual, refer to the Oracle FLEXCUBE manuals on:

- Common Procedures
- Accessibility

---

## 2. EMS Maintenances

### 2.1 Introduction

This chapter contains the following sections:

- [Section 2.2, "Message Media Control Maintenance"](#)
- [Section 2.3, "Media Maintenance"](#)
- [Section 2.4, "Message Queues Mapping Maintenance"](#)
- [Section 2.5, "Message Queue Maintenance"](#)
- [Section 2.6, "SWIFT Message Notification Browser"](#)
- [Section 2.7, "SWIFT Net Service Definition"](#)
- [Section 2.8, "SWIFT Local Authentication Maintenance"](#)
- [Section 2.9, "Mapping Rule Group"](#)
- [Section 2.10, "Defining Rule Group"](#)
- [Section 2.11, "Routing Rule Definition"](#)
- [Section 2.12, "Defining Protocol Parameter"](#)
- [Section 2.13, "File Transfer Adapter Connector Configuration"](#)
- [Section 2.14, "Distinguished Name Definition"](#)
- [Section 2.15, "Defining Debulk Rule"](#)
- [Section 2.16, "Connectivity Operation Manager"](#)
- [Section 2.17, "Outbound File Browser"](#)
- [Section 2.18, "Inbound File Browser"](#)
- [Section 2.19, "Defining Bulk Preference"](#)

### 2.2 Message Media Control Maintenance

The messages that are sent from and delivered to your bank are transmitted and received over sources that are external to Oracle FLEXCUBE. We shall call these external sources Media Control Systems (MCS).

In a distributed environment, the database of a branch is located in a node or server. The MCS of the messages are also installed in a node. Thus, while defining an MCS, you also need to indicate the node in which it is installed.

An MCS can handle only one media, hence you need to set up several media control systems for the various media types maintained for your bank. Apart from indicating the media type for an MCS, you can indicate separate directories from which Oracle FLEXCUBE should read and write incoming and outgoing messages for a given media.

You can maintain MCS details in the 'Message Media Control Maintenance' screen. The details that you specify in this screen control the medium of delivery and reception of messages.

This section contains the following topic:

- [Section 2.2.1, "Maintaining Message Media Control"](#)
- [Section 2.2.2, "Specifying File Prefix"](#)

- [Section 2.2.3, "Saving Message Media Control Details"](#)

## 2.2.1 Maintaining Message Media Control

You can invoke 'Message Media Control Maintenance' screen by typing 'MSDMGMCS' in the field at the top right corner of the Application tool bar and clicking on the adjoining arrow button.

If you are maintaining details of a new media control system click the 'New' button on the Application toolbar. The 'Message Media Control Maintenance' screen is displayed without any details.

If you are calling an MCS record that has already been defined, double-click a record of your choice from the summary screen. In the 'Summary' screen, all the media control system records that you have entered will be displayed in a tabular form.

The screen is as shown below:

You can capture the following details on this screen.

### **Delivery Type**

You can specify the delivery type here. Oracle FLEXCUBE gives you two options viz. Folder and Queue. Depending on the selection you make, you must specify the details in the corresponding fields as follows.

- Folder – If you choose 'Folder' as the delivery type, you must specify the In Directory and the Out Directory. Further, after selecting 'Folder', if you check the option 'Unix Swift Server' for a UNIX SWIFT server, then you must specify the Unix In-Directory and the Unix Out-Directory. For a Windows Server the In-Directory and Out-Directory must be maintained.
- Queue – If you select 'Queue' as the delivery type, you must specify In Queue, Out Queue and the type of queue – i.e. 'Microsoft Message Queue' or 'WebSphere Messaging Queue'.



## Media Control System

In Oracle FLEXCUBE, each media control system that you maintain is identified by a 15-character code called an MCS code. You can follow your own convention for devising this code.

The code that you assign an MCS should be unique as it is used to identify the external source.

## Node

A node is the Database instance on which Oracle FLEXCUBE is installed. On assigning a code to an MCS, you can indicate the node or server at which the MCS is located. A branch's database is located in a node and an MCS is also installed in a node. Thus, while defining an MCS, you need to indicate the node at which it has been installed.

## Media

You need to also specify the media for which your bank is using the MCS. For example, if you set up an MCS say 'MCSSWIFT' and indicate the media type as SWIFT, it indicates that Oracle FLEXCUBE can receive and transmit SWIFT messages through the MCS 'MCSSWIFT'.

The following diagram illustrates a typical MCS setup:

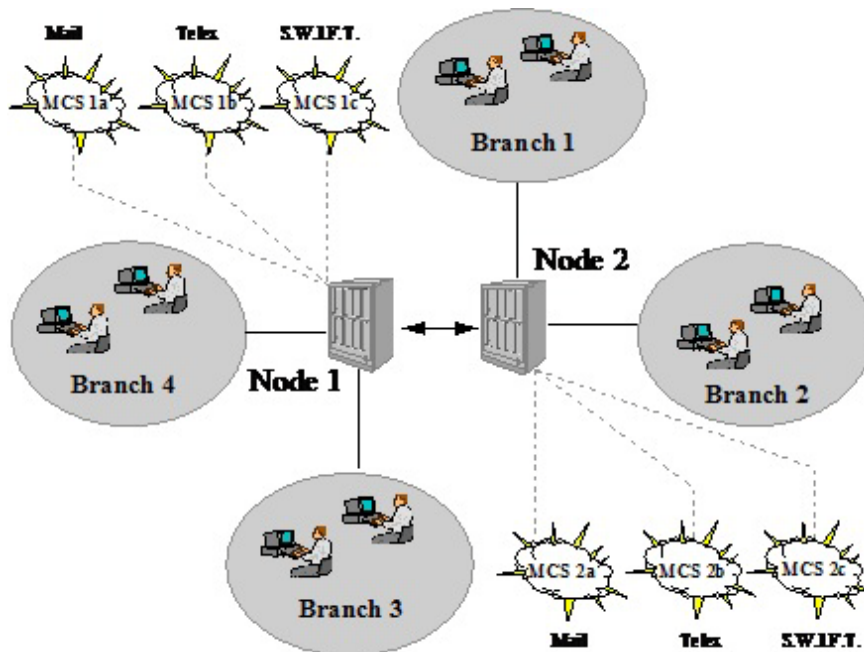

## Status

You need to indicate the status of an MCS. The status options available are:

- Active and
- Passive

It is only when an MCS is active that messages will be directed to it. If, for instance, an MCS located at the node in which your branch operates malfunctions, you can indicate that the MCS is passive. In this case, Oracle FLEXCUBE will not write into or read from the directories on the node. No message will be routed through a passive MCS.

## In Directory and Out Directory

If the Delivery Type is 'Folder' and the SWIFT server is a Windows server then apart from indicating the node on which an MCS is located, you should specify the full path of the

directories from which Oracle FLEXCUBE should read and write incoming and outgoing messages respectively.

#### **File Prefix**

For the MCS you are maintaining, you should identify the outgoing message files generated in a different media with unique prefixes. Enter the unique identifier in this field.

#### **In Queue**

If the Delivery type is Queue then you should enter the full path of the queue in the node or server into which the MCS should store the incoming message hand-off file. Oracle FLEXCUBE, by default, will pickup and read all incoming messages transmitted through the specified media from this queue.

#### **Out Queue**

Enter the full path of the queue in the node or server into which the message hand-off file from Oracle FLEXCUBE for the specified media should be stored. The MCS, which is also, located on the same node, will by default store the outgoing messages in this queue.

#### **Unix Swift Server**

At your bank, if the SWIFT server is on UNIX, check this option. Subsequently, in this screen, you should specify the default In and Out Directories for the SWIFT message hand-off files.

To continue with your normal banking operations you can connect to another node and indicate the directory on that node from which Oracle FLEXCUBE should read from and write into.

### **SWIFT Server on UNIX**

If the SWIFT server at your bank is on UNIX, you should indicate it in this screen. Subsequently, you should specify the default In and Out Directories for the SWIFT message hand-off files.

#### **Specifying the UNIX In-Directory**

You can specify the full path of the directory on the SWIFT server where you would like to store incoming SWIFT message files. Oracle FLEXCUBE will pickup and process all incoming SWIFT message files from this directory.

#### **Specifying the UNIX Out-Directory**

In this screen, you can also specify the directory on the SWIFT server where you would like to store outgoing SWIFT message hand-off files.

## **2.2.2 Specifying File Prefix**

For the MCS you are maintaining, you should identify outgoing message files generated in the media with unique prefixes. Oracle FLEXCUBE will automatically prefix outgoing message hand-off files for the MCS with the prefix that you specify.

## **2.2.3 Saving Message Media Control Details**

After you have made the mandatory entries, save the record. An MCS record that you have created should be authorized by a user, bearing a different Login ID, before the End of Day process (EOD) is run.

## **2.3 Media Maintenance**

This section contains the following topic:

- [Section 2.3.1, "Maintaining Message Media Details"](#)

## 2.3.1 Maintaining Message Media Details

You can invoke the 'Message Media Maintenance' screen by typing 'MSDMEDMT' in the field at the top right corner of the Application tool bar and clicking on the adjoining arrow button.

If you are maintaining details of a new media type, select 'New' from the Actions Menu, or click new icon on the toolbar. The 'Message Media Maintenance' screen is displayed without any details.

If you are calling a Message Media Maintenance record that has already been defined, double-click a record from the summary screen. In the 'Summary' screen, all the media maintenance records that you have entered will be displayed in a tabular form.

The screen is as shown below:

The screenshot shows the 'Media Maintenance' application window. The title bar reads 'Media Maintenance'. Below the title bar is a toolbar with 'New' and 'Enter Query' buttons. The main area contains several input fields: 'Media Code \*', 'Description \*', 'Media Number', 'Message Suffix', 'Message Terminator', 'Number of Characters', and 'Media Priority \*'. Below these fields are three checkboxes: 'Test Word Required', 'Stop Processing', and 'Padding Required'. A 'Compatible Media' section shows a table with one row containing 'Compatible Media \*'. At the bottom, there is a 'Fields' section with a table listing 'Maker', 'Date Time:', 'Mod No', 'Record Status', 'Checker', 'Date Time:', 'Authorization Status', and an 'Exit' button.

In this screen, you can maintain the following:

- The media types that can be used to transmit messages from and to your bank, and
- The compatible media for the media type you are maintaining.

For each media type that you maintain, you should indicate the following parameters:

### Indicating a Code to Identify a Media Type

In Oracle FLEXCUBE, each media type that you maintain is identified with a fifteen-character code called 'Media Code'. You can follow your own convention for devising this code. A Media Type could be SWIFT, Mail, Telex, ISO etc.

The code that you assign a media type should be unique as it is used to identify the media. When you need to indicate that a message should be transmitted through a particular media

type, you just need to specify the code assigned to the media type. The message will be routed automatically through the media.

You can enter a short description of the media type that you are maintaining. The description will help you identify the code that it represents.

### **Opting for Message Markers**

You can opt to append end-message markers to outgoing messages generated in a media. These markers are referred to as “Padding Characters” in Oracle FLEXCUBE. Padding characters would, typically, be a standard set of characters, probably repeated. The padding characters that you specify will be inserted, automatically, at the end of every outgoing message in the media. You can indicate the padding characters that mark the end of an outgoing message (in a specific media) in the Message Suffix field.

When defining a media, you can also capture the padding characters that mark the end of incoming messages in the media. The system identifies the end of an incoming message, in a file containing several messages, when it encounters the padding characters you have captured for a media type. Enter the padded characters that mark the end of incoming messages in a media in the Message Terminator field.

---

#### **Note**

For Message suffix to be used for Outgoing messages, the ‘Padding Required’ option should be selected.

---

### **Repeating a Set of Padding Characters**

If you opted to suffix an outgoing message with a set of padding characters, indicate in the ‘Number of Characters’ field the number of times the set should be repeated.

The padding characters will be suffixed to every outgoing message in the media as many times as you specify.

### **Halting the Processing of Messages**

At any time, you can opt to halt the processing of messages in a specific media. To halt the processing of incoming and outgoing messages in a media, invoke this screen and navigate to the maintenance record for the media, and choose the ‘Stop Processing’ option. When you save your changes to the record, Oracle FLEXCUBE will stop processing messages in the media.

### **Indicating the Compatible Media for a Media Type**

For each media type that you maintain, you can also indicate other media that are compatible. The format of compatible media should be similar.

For example, you are maintaining details for the media type 'mail'. You have indicated media type 'Fax' as compatible media.

In this case, whenever a message is faxed, it will be in the mail format defined for the message in the ‘Advice Format File Maintenance’ screen.

You can indicate compatible media by selecting the relevant media codes from the picklist available. To add compatible media for a media type, select the code that identifies the compatible media, and click add icon. To delete compatible media, select the codes that identify the media, and click delete icon.

---

**Note**

The compatible media that you indicate for a media type should have already been maintained as a media type.

---

**Setting the Priority**

While maintaining media types, you can set the usage priority for each media type that you maintain. Consequently, when dispatching messages to customers, the media type used for sending the message will be the one that is higher on the priority rating. For instance, let us assume that the following are the types of media that you bank uses to send advices to customers:

- SWIFT
- Mail
- Telex
- Fax
- ISO

You have assigned the following priority to each of these media types:

Media Type	Media Priority
SWIFT	2
Mail	1
Telex	4
Fax	3
ISO	5

When dispatching messages to customers, the system will, by default, select the media type in the ascending order of the priority that you have specified.

---

**Note**

The rating that you specify can be anything between 1 and 99. A rating of one would indicate that the usage of the particular media type is highest on the priority list; whereas, a rating of 99 indicates that the usage of the particular media type is of lowest priority.

---

**Saving the Record**

After you have made mandatory entries, save the record. A media maintenance record that you have created should be authorized by a user, bearing a different Login ID, before the End of Day processes are triggered. Click 'Exit' or 'Cancel' button to return to the application.

## 2.4 Message Queues Mapping Maintenance

This section contains the following topic:

- [Section 2.4.1, "Invoking Message Queue Mapping Maintenance Screen"](#)

## 2.4.1 Invoking Message Queue Mapping Maintenance Screen

For a combination of the following, you can specify the branch (queue) to which the message is to be routed:

- **Media** – represents the delivery media. Typically, your entry would be SWIFT.
- **BIC Code** - represents the receiver's BIC for which a message is to be routed to a specific queue in a particular branch. You can choose to specify the wildcard ALL entry in this field.
- **Message Type** - indicates the message type for which routing procedure is required. You can select the message type from the available adjoining list.
- **Currency** – indicates the currency of the incoming message. For example in an MT103 it would be from tag 32A. This is an additional parameter to determine the booking branch and queue. You can also choose to maintain the wildcard ALL entry.
- **Booking Branch** - indicates the branch in which incoming messages are routed. A set of all the branches having the same SWIFT BIC as that mentioned in the BIC code field is displayed in the option list.

This maintenance can be performed through the 'Message Queue Mapping Maintenance' screen. To invoke this screen, type 'MSDQMAP' in the field at the top right corner of the Application tool bar and click the adjoining arrow button.

The screenshot shows the 'Message Queue Mapping Maintenance' application window. At the top, there is a title bar with the text 'Message Queue Mapping Maintenance' and standard window controls. Below the title bar, there are two buttons: 'New' and 'Enter Query'. The main content area contains several input fields with red asterisks indicating they are required: 'Media \*', 'BIC Code \*', 'Currency \*', 'Booking Branch \*', 'Message Type \*', and 'Queue \*'. Below these fields is a 'Field Properties' section with a table containing columns for 'Maker', 'Date Time:', 'Mod No', 'Record Status', 'Checker', 'Date Time:', 'Authorization Status', and an 'Exit' button.

While processing MT700 and MT701 messages the System ensures the following:

- MT700 and MT701 are routed to the branch using the Incoming Routing specifications maintained in this screen
- For MT700, in case the branch of the corresponding MT701 is different from that of the MT700 it is re-aligned to the branch of the MT700
- MT701 messages are processed only after the receipt of MT 700

---

### Note

You can maintain the same BIC for the main branch as well as the sub-branch.

---

## 2.5 Message Queue Maintenance

This section contains the following topic:

- [Section 2.5.1, "Maintaining Message Queues"](#)

### 2.5.1 Maintaining Message Queues

All Incoming SWIFT and Non Swift Messages are routed through a messaging queue. You need to maintain different user queues to which incoming messages are directed. Users with appropriate rights are allowed to access a particular queue. All 798 incoming index messages 770,761,784 are also captured in this screen.

You can invoke the 'Message Queue Maintenance' screen by typing 'MSDQMNT' in the field at the top right corner of the Application tool bar and clicking the adjoining arrow button.

The screenshot shows the 'Message Queue Maintenance' application window. The window title is 'Message Queue Maintenance'. It features a menu bar with 'New' and 'Enter Query'. Below the menu bar is a section titled 'Queues' with a table containing two rows: 'Auto STP' and 'Collection Queue'. The 'Auto STP' row has a checked checkbox, and the 'Collection Queue' row has an unchecked checkbox. Below this is a section titled 'Swift Messages Queue' with a grid showing '1 Of 1' records. The grid has a header row with 'Message Code \*' and a search bar with a 'Go' button. At the bottom of the window is a status bar with fields for 'Maker', 'Checker', 'Date Time:', 'Mod No', 'Record Status', and 'Authorization Status', along with an 'Exit' button.

In this screen you can capture the following details for a queue:

- A name to identify the queue uniquely throughout the system.
- A short description of the queue
- Select 'Auto STP' to process SWIFT message automatically if it is part of any queue.
- The codes of various SWIFT and Non SWIFT messages that would be routed to this queue.
- Select collection queue flag if the unique queue you are maintaining here is a collection Queue.

---

#### Note

The codes of various SWIFT and Non SWIFT messages list in the grid is not applicable for the collection queue.

---

You can assign a message to more than one messaging queue. At the time of maintaining rules for a message (discussed in the subsequent sections of this document), you can select the appropriate queue for each rule from the list of queues to which the message is linked.

Select 'Add' from the Actions menu in the Application tool bar or click add icon to add a message to the queue being defined. To remove a message from the queue, Select 'Delete' from the Actions menu in the Application tool bar or click delete icon.

## 2.6 SWIFT Message Notification Browser

This section contains the following topic:

- [Section 2.6.1, "Viewing SWIFT Notification Messages"](#)

### 2.6.1 Viewing SWIFT Notification Messages

SWIFT provides the following two types of notification messages to Oracle FLEXCUBE:

- ACK/NACK acknowledgement messages indicating whether the message has been successfully delivered to SWIFTNet FIN service, from where it gets forwarded to the receiving system
- Delivery notification messages indicating whether the message was successfully delivered to the receiving system

You can access these notifications messages using 'SWIFT Message Notification Browser' screen. You can invoke this screen by screen by typing 'MSSNOTIB' in the field at the top right corner of the Application tool bar and clicking on the adjoining arrow button. The screen is as shown below:

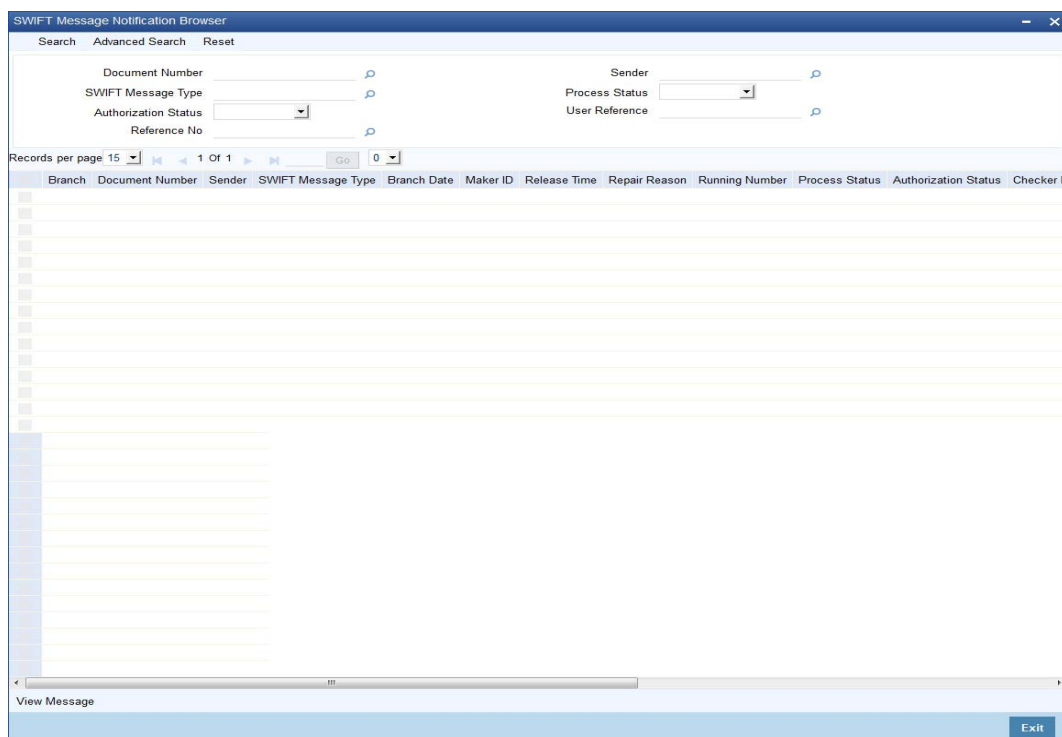

In the above screen, you can base your queries on any or all of the following parameters and fetch records:

- Document Number
- Sender
- Swift Message Type
- Process Status
- Auth Status



- User Reference
- Reference Number

Select any or all of the above parameters for a query and click 'Search' button. The records meeting the selected criteria are displayed.

System displays the following details pertaining to the fetched records:

- Branch
- Document Number
- Sender
- Swift Message Type
- Branch Date
- Maker ID
- Release Time
- Repair Reason
- Running Number
- Process Status
- Auth Status
- Checker DT Stamp
- Checker ID
- Message Reference
- Receiver
- User Reference
- Mod Number
- reference Number

A back-ground job running on this browser updates the outgoing browser with the ACK/NAK and the delivery status of the message. The sender MUR from SWIFT is used to match the corresponding outgoing browser record.

## **2.7 SWIFT Net Service Definition**

This section contains the following topic:

- [Section 2.7.1, "Invoking SWIFTNet Service Definition Screen"](#)
- [Section 2.7.2, "Viewing SWIFTNet Service Summary"](#)

## 2.7.1 Invoking SWIFTNet Service Definition Screen

You can invoke 'SWIFTNet Service Definition' screen by typing 'MSDSWTSR' in the field at the top right corner of the Application tool bar and clicking on the adjoining arrow button...

The screenshot shows the 'SWIFTNet Service Definition' application window. At the top, there is a 'New' button and an 'Enter Query' field. Below this is the 'Swift Net service Definition' section, which includes a 'Service Name' field (marked with a red asterisk) and 'Service Mode' radio buttons for 'Real Time(RT)' (selected) and 'Store And Forward (SnF)'. The screen is divided into two panes: 'Requestor DN Details' and 'Responder DN Details', each with a 'Go' button and a table for 'Requestor DN' and 'Responder DN' respectively. The bottom status bar includes fields for 'Maker', 'Date Time', 'Mod No', 'Record Status', 'Authorization Status', and an 'Exit' button.

You can specify the following fields:

### Service Name

Specify the SWIFTnet Service name.

### Service Mode

Select any one of the service modes.

- Real Time- Choose this button to send and receive messages real-time. Real Time option is selected by default.
- Store and Forward - Choose this button to send and receive messages by storing them in a location and then forwarding them accordingly.

### Request for DN

Specify the DN that send request to the service. You must provide at least one DN.

### Responder DN

Specify the DN that responds request to the service. You must provide at least one DN.

## 2.7.2 Viewing SWIFTNet Service Summary

You can invoke 'SWIFTNet Service Summary' screen by typing 'MSSSWTSR' in the field at the top right corner of the Application tool bar and clicking on the adjoining arrow button.

The screenshot shows a web application window titled "SwiftNet Service Definition Summary". At the top, there are buttons for "Search", "Advanced Search", and "Reset". Below these are two dropdown menus: "Authorization Status" and "Record Status", followed by a text input field for "Service Name". A pagination bar indicates "Records per page 15", "1 Of 1", and a "Go" button. The main content area is a table with three columns: "Authorization Status", "Record Status", and "Service Name". Each row in the table has a checkbox in the first column. An "Exit" button is located in the bottom right corner of the window.

You can search using one or more of the following parameters:

- Service Name
- Authorization Status
- Record Status

Once you have specified the search parameters, click 'Search' button. The system displays the records that match the search criteria for the following

- Service Name
- Authorization Status
- Record Status

## 2.8 SWIFT Local Authentication Maintenance

This section contains the following topics:

- [Section 2.8.1, "Invoking SWIFT LAU Maintenance Screen"](#)
- [Section 2.8.2, "Viewing SWIFT LAU Summary Details"](#)
- [Section 2.8.3, "Processing Outgoing SWIFT LAU"](#)
- [Section 2.8.4, "Processing Incoming SWIFT LAU"](#)

### 2.8.1 Invoking SWIFT LAU Maintenance Screen

You can maintain SWIFT authentication parameters in 'SWIFT LAU Maintenance' screen. This screen can be accessed from Head Office only. The EMS module refers SWIFT LAU maintenance data for calculating checksum for outbound and authentication of inbound messages. HMAC-SHA256 algorithm validation will be used to calculate the checksum and

ensure the integrity of messages exchanged with SWIFT. You can invoke this screen by typing 'MSDLAUMN' in the top right corner of the Application toolbar and clicking the adjoining arrow button.

Maker Checker	Date Time Date Time	Mod No	Record Status Authorization Status	Exit
------------------	------------------------	--------	---------------------------------------	------

You can specify the following in this screen:

### **Host Code**

Specify the host code. Alternatively, you can select the host code from the option list. The list displays all valid host codes maintained in the system.

### **Local Authentication Required**

Check this box to enable SWIFT local authentication in the bank. If this check-box is checked then all other parameters in this screen is mandatory.

### **Message Direction**

Choose the direction of the message based on the key maintained for Outgoing or Incoming SWIFT message.

### **Send Key**

#### **First Part**

Specify the first part of the key. The length of the key must be in sixteen hexadecimal characters

#### **Second Part**

Specify the second part of the key. The length of the key must also be in sixteen hexadecimal characters.

## 2.8.2 Viewing SWIFT LAU Summary Details

You can view SWIFT LAU maintenance details in the SWIFT LAU Summary screen. You can invoke this screen by typing 'MSSLAUMN' at the top right corner of the Application toolbar and clicking the adjoining arrow button.

The screenshot shows the 'SWIFT LAU Key Summary' application window. The interface includes a search bar with 'Search', 'Advanced Search', 'Reset', and 'Clear All' options. Below the search bar, there are filters for 'Case Sensitive', 'Authorization Status', 'Record Status', and 'Message Direction'. A 'Host Code' field is also present. The main area shows a table with columns: 'Authorization Status', 'Record Status', 'Host Code', 'Message Direction', 'Local Authentication Required', 'First Part', and 'Second Part'. The table is currently empty. At the bottom right, there is an 'Exit' button.

You can search using one or more of the following parameters:

- Authorization Status
- Record Status
- Host Code
- Message Direction

Once you have specified the search parameters, click 'Search' button. The system displays the records that match the search criteria for the following:

- Authorization Status
- Record Status
- Host Code
- Message Direction
- Local Authentication Required
- First Part
- Second Part

### 2.8.3 Processing Outgoing SWIFT LAU

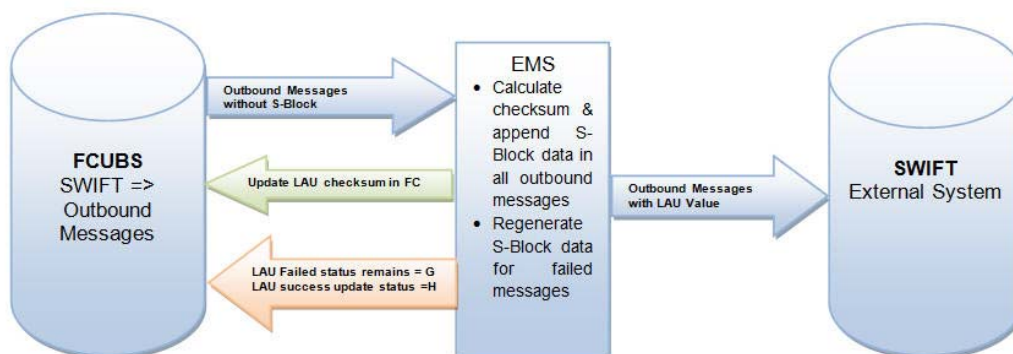

Outbound message workflow is explained below:

- Oracle FLEXCUBE generates the S-Block for all outbound SWIFT messages with message status 'Generated'.
- EMS module refers SWIFT LAU parameters in FLEXCUBE 'SWIFT LAU Maintenance' screen and applies HMAC-SHA256 algorithm to generate the checksum in S-Block for all outbound messages from FCUBS.
- For all outbound messages, EMS-generated checksum is appended in the S-Block of the message, and the same is updated in the 'SWIFT LAU' field of Outgoing Message Browser screen.
- Successful generation of S-Block data and message hand-off to out folder, will update the message status to 'Handoff'. If there is a failure in appending the S-Block data in the message, EMS will not update the message status to 'Handoff' in Outgoing Message Browser.
- The next handoff job of EMS picks-up the messages with status 'Generated', regenerates S-Block data, appends the same in the message, and updates the message status to 'Handoff' in Outgoing Message Browser.

### 2.8.4 Processing Incoming SWIFT LAU

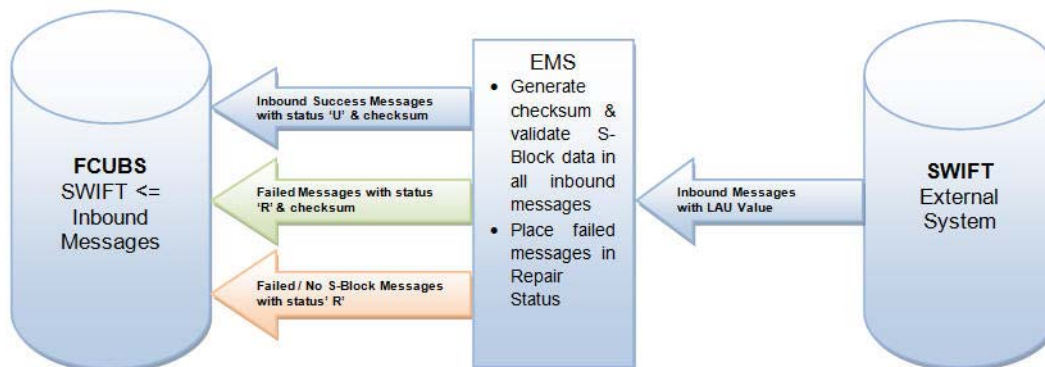

Inbound message workflow is explained below:

- You can validate inbound messages with the S-Block data. The checksum value is regenerated in EMS, based on SWIFT LAU parameters and HMAC-SHA256 algorithm.
- Regenerated checksum is compared with the checksum present in the received message, and further processing is carried out in FCUBS based on data verification.
- LAU checksum validated messages are uploaded into Incoming Message Browser with status 'Unprocessed', for FCUBS to create relevant contracts.

- The encrypted S-Block checksum values in the received messages are updated in the 'SWIFT LAU' field, and the checksum generated by EMS for all incoming messages are updated in 'LAU Validation' field of Incoming Message Browser.
- Messages that have failed in LAU checksum validation are uploaded into Incoming Message Browser with status 'Repair'.
- Messages with status 'Repair' in Incoming Message Browser will hold differences in checksum data present in SWIFT LAU and LAU Validation fields.
- Incoming messages without S Block is uploaded in incoming browser with status 'Repair', and data is not updated in SWIFT LAU field, while EMS generated checksum is updated in LAU VALIDATION field.

## 2.9 Mapping Rule Group

This section contains the following topic:

- [Section 2.9.1, "Invoking Rule Group Mapping Screen"](#)
- [Section 2.9.2, "Viewing Rule Group Mapping Summary"](#)

### 2.9.1 Invoking Rule Group Mapping Screen

You can invoke 'Rule Group Mapping' screen by typing 'MSDRLMAP' in the field at the top right corner of the Application tool bar and clicking on the adjoining arrow button..

You can specify the following fields:

#### **Rule Group Name**

Specify the unique rule group name.

#### **Module ID**

Specify the module that needs to be mapped to the created rule group.

## 2.9.2 Viewing Rule Group Mapping Summary

You can invoke “Rule Group Mapping Summary” screen by typing ‘MSSRLMAP’ in the field at the top right corner of the Application tool bar and clicking on the adjoining arrow button.

<input type="checkbox"/>	Authorization Status	Record Status	Module Identification	Rule Group Name
<input type="checkbox"/>				
<input type="checkbox"/>				
<input type="checkbox"/>				
<input type="checkbox"/>				
<input type="checkbox"/>				
<input type="checkbox"/>				
<input type="checkbox"/>				
<input type="checkbox"/>				
<input type="checkbox"/>				
<input type="checkbox"/>				
<input type="checkbox"/>				
<input type="checkbox"/>				
<input type="checkbox"/>				
<input type="checkbox"/>				
<input type="checkbox"/>				

You can search using one or more of the following parameters:

- Authorization Status
- Record Status
- Module ID

Once you have specified the search parameters, click ‘Search’ button. The system displays the records that match the search criteria for the following

- Authorization Status
- Record Status
- Module Identification
- Rule Group Name

## 2.10 Defining Rule Group

This section contains the following topic:

- [Section 2.10.1, "Invoking Rule Group Definition Screen"](#)
- [Section 2.10.2, "Viewing Rule Group Summary"](#)



## 2.10.1 Invoking Rule Group Definition Screen

You can invoke 'Rule Group Definition' screen by typing 'MSDRLGRP' in the field at the top right corner of the Application tool bar and clicking on the adjoining arrow button..

The screenshot shows the 'Rule Group Definition' application window. At the top, there is a 'New' button and an 'Enter Query' field. Below this, there are two input fields: 'Rule Group Name' (marked with a red asterisk) and 'Description'. To the right of the 'Description' field is a 'Go' button. Below the input fields is a table with three columns: 'Rule Name', 'Rule Description', and 'Priority'. The table is currently empty. Below the table, there is a 'Move to/Swap to' section with two buttons: 'Move' and 'Swap'. At the bottom of the window, there is a status bar with several fields: 'Maker/Checker', 'Date Time', 'Mod No', 'Record Status/Authorization Status', and an 'Exit' button.

You can specify the following fields:

### Rule Group Name

Specify the unique rule group name.

### Description

Enter a brief description of the rule group.

### Rule Name

Specify the rule name from the rule definition screen.

### Rule Priority

Specify the priority of the rule name.

### Move To/ Swap

Specify whether the priority must be swapped or moved.

### Move

Click the **Move** button to move the priority record.

### Swap

Click the **Swap** button to swap the priority record.

## 2.10.2 Viewing Rule Group Summary

You can invoke “Rule Group Summary” screen by typing ‘MSSRLGRP’ in the field at the top right corner of the Application tool bar and clicking on the adjoining arrow button.

Authorization Status	Record Status	Rule Group Name	Description
----------------------	---------------	-----------------	-------------

You can search using one or more of the following parameters:

- Authorization Status
- Record Status
- Rule Group

Once you have specified the search parameters, click ‘Search’ button. The system displays the records that match the search criteria for the following

- Authorization Status
- Record Status
- Rule Group Name
- Description

## 2.11 Routing Rule Definition

This section contains the following topic:

- [Section 2.11.1, "Invoking Routing Rule Definition Screen"](#)
- [Section 2.11.2, "Viewing Rule Definition Summary"](#)

## 2.11.1 Invoking Routing Rule Definition Screen

You can invoke 'Rule Definition' screen by typing 'MSDRLDFN' in the field at the top right corner of the Application tool bar and clicking on the adjoining arrow button..

Maker	Date Time:	Mod No	Record Status
Checker	Date Time:		Authorization Status

You can specify the following fields:

### Rule Name

Specify the unique rule name.

### Description

Enter a brief description of the rule name.

### Destination Type

Specify the type of destination to which the messages matching the rule criteria is being sent. Select any of the options given below:

- SWIFT Net Connectivity
- Bulker
- Folder
- Queue

### Folder Path

Specify the folder path if the destination is folder.

### Queue JNDI Name

Specify JNDI name of the Queue. This is mandatory if the destination type is Queue.

### Protocol Type

Specify the type of Protocol. Select from the following option:

- FTA
- MQHA

---

**Note**

This is mandatory if the destination is SWIFTNet.

---

**Protocol Name**

Specify the required protocol for the selected protocol.

**SWIFTNet Connectivity**

Specify the name of the connector if the destination type is SWIFTNet.

**Bulk Rule Name**

Specify the bulk rule name. Alternatively, you can select the bulk rule name from the option list. The list displays all valid values.

**Expression Section**

Specify the expression section

**Scope**

Specify the scope.

**Left Operand Type**

Select the left operand type.

**Left Operand Data Type**

Select the left operand data type.

**Left Operand**

Specify the left operand. Alternatively, select the left operand from the option list. The list displays all valid values.

**Operator**

Select the operator.

**Right Operand Type**

Select the right operand type.

**Right Operand Data Type**

Select the right operand data type.

**Right Operand**

Specify the right operand. Alternatively, select the right operand from the option list. The list displays all valid values.

**Scope**

Specify the scope.

**Logical Operators**

Select the logical operators from the drop-down list.

**Pre Defined Functions**

Select the pre defined functions from the drop-down list.

**Parameter Name**

Specify the parameter name.

**Parameter Value**

Specify the value of the parameter.

### Parameter Type

Specify the parameter type.

### Expression For

Select the expression from the drop-down list.

### Final Expression

Specify the final expression.

### Build Expression

Click Build Expression to build the expression.

## 2.11.2 Viewing Rule Definition Summary

You can invoke “Rule Definition Summary” screen by typing ‘MSSRLDFN’ in the field at the top right corner of the Application tool bar and clicking on the adjoining arrow button.

<input type="checkbox"/>	Authorization Status	Record Status	Rule Name	Rule Description	Rule Group Name	Destination Type
<input type="checkbox"/>						
<input type="checkbox"/>						
<input type="checkbox"/>						
<input type="checkbox"/>						
<input type="checkbox"/>						
<input type="checkbox"/>						
<input type="checkbox"/>						
<input type="checkbox"/>						
<input type="checkbox"/>						
<input type="checkbox"/>						
<input type="checkbox"/>						
<input type="checkbox"/>						
<input type="checkbox"/>						
<input type="checkbox"/>						
<input type="checkbox"/>						

You can search using one or more of the following parameters:

- Authorization Status
- Record Status
- Rule Name
- Rule Description
- Rule Group Name
- Destination Name

Once you have specified the search parameters, click ‘Search’ button. The system displays the records that match the search criteria for the following

- Authorization Status
- Record Status
- Rule Name
- Rule Description

- Rule Group Name
- Destination Type

## 2.12 Defining Protocol Parameter

This section contains the following topic:

- [Section 2.12.1, "Invoking Protocol Parameter Definition Screen"](#)
- [Section 2.12.2, "Viewing Protocol Parameter Definition Summary"](#)

### 2.12.1 Invoking Protocol Parameter Definition Screen

You can invoke 'Protocol Parameter Definition' screen by typing 'MSDPTPRM' in the field at the top right corner of the Application tool bar and clicking on the adjoining arrow button...

You can specify the following fields:

#### **Protocol Parameter Name**

Specify the name of the Protocol Parameter.

#### **Description**

Specify the description of the Protocol Parameter set.

#### **Protocol Type Mode**

The name of the protocol for which parameter list is defined. Select any of the option given below:

- FTA

#### **Parameters**

Specify the parameters for the protocol.

#### **Value**

Specify the value of the parameter.

## 2.12.2 Viewing Protocol Parameter Definition Summary

You can invoke “Protocol Parameter Definition Summary” screen by typing ‘MSSPTPRM’ in the field at the top right corner of the Application tool bar and clicking on the adjoining arrow button.

The screenshot shows a web application window titled "Protocol Parameter Definition Summary". At the top, there are buttons for "Search", "Advanced Search", and "Reset". Below these are two dropdown menus for "Authorization Status" and "Record Status", and a text input field for "Protocol Parameter Name" with a search icon. A pagination bar shows "Records per page 15", "1 Of 1", and a "Go" button with a dropdown for "0". The main area is a table with columns: "Authorization Status", "Record Status", "Protocol Parameter Name", "Description", and "Protocol Type". The table is currently empty. An "Exit" button is located in the bottom right corner.

You can search using one or more of the following parameters:

- Protocol Parameter Name
- Authorization Status
- Record Status

Once you have specified the search parameters, click 'Search' button. The system displays the records that match the search criteria for the following

- Protocol Parameter Name
- Description
- Authorization Status
- Record Status
- Protocol Type

## 2.13 File Transfer Adapter Connector Configuration

You have to create below folder structure for the Swiftnet connectivity:

1. Create a application base directory as per the path mentioned in the mstm\_ems\_system\_parameters (APP\_BASE\_DIR)
2. Create below folder structure in the application base directory:
  - payload\EMS\_OUT
  - xsl
3. In the Xsl folder copy all the xsl required for message transformation

This section contains the following topic:

- [Section 2.13.1, "Invoking File Transfer Adapter Connector Configuration Screen"](#)
- [Section 2.13.2, "Viewing File Transfer Adapter Connector Configuration Summary"](#)

## 2.13.1 Invoking File Transfer Adapter Connector Configuration Screen

You can invoke 'File Transfer Adapter Connector Configuration' screen by typing 'MSDFTACN' in the field at the top right corner of the Application tool bar and clicking on the adjoining arrow button...

Maker	Date Time:	Mod No	Record Status	Exit
Checker	Date Time:		Authorization Status	

You can specify the following fields:

### Operation Type

Select the type of connectivity. Choose between Inbound and Outbound.

### Host Code

Specify the host code.

### Parameter File Required

Check this box if FCM creates or receives a Parameter File corresponding to each and every data file in configured file directory along with data file.

### Data file LAU

Check this box if FCM calculates the LAU of Data File and puts the calculated value in parameter file.

### Parameter File LAU

Check this box if parameters defined at emission profile of SAG side are overridden by information in companion file.

### Allow Overriding on SAG Profile

Check this box if parameters defined at the emission profile of SAG side will be overridden by information in Companion file.

### File Directory

Specifies store details of emission directory for outbound connectivity and reception directory for inbound flow.

### Log Directory

Specifies the responses from SAG.



### Success Directory

For Outbound connectivity, Delivery notification response related to file transfer status from the SAG are placed in this directory. For inbound connectivity file transfer, success status files are placed in this folder.

### Debulk Required

Check this box, if debulk is required for inbound messages.

### Debulk Rule Name

Specifies the debulk rule name.

### Node

Specifies the node details. This is mandatory for inbound.

### Media

Specifies the media details. This is mandatory for inbound.

### Media Control System

Specifies the media control system. This is mandatory for inbound.

## 2.13.2 Viewing File Transfer Adapter Connector Configuration Summary

You can invoke “File Transfer Connector Configuration Summary” screen by typing ‘MSSFTACN’ in the field at the top right corner of the Application tool bar and clicking on the adjoining arrow button.

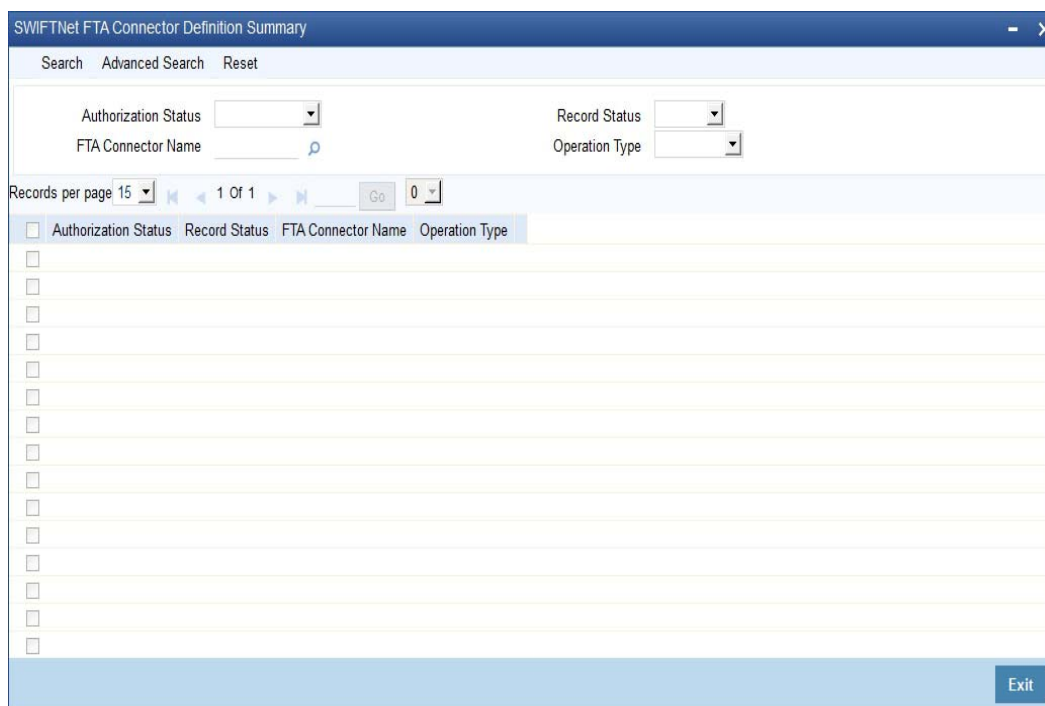

The screenshot displays a web-based application window titled "SWIFTNet FTA Connector Definition Summary". The interface includes a search bar at the top with options for "Search", "Advanced Search", and "Reset". Below the search bar, there are four dropdown menus: "Authorization Status", "Record Status", "FTA Connector Name", and "Operation Type". A pagination control shows "Records per page 15" and "1 Of 1" records, with a "Go" button and a "0" value. The main area contains a table with columns for "Authorization Status", "Record Status", "FTA Connector Name", and "Operation Type", each with a checkbox to its left. The table is currently empty. An "Exit" button is located in the bottom right corner of the window.

You can search using one or more of the following parameters:

- FTA Connector Name
- Operation Mode
- Auth Status
- Record Status

Once you have specified the search parameters, click 'Search' button. The system displays the records that match the search criteria for the following:

- FTA Connector Name
- Operation Mode
- Auth Status
- Record Status

## 2.14 Distinguished Name Definition

This section contains the following topic:

- [Section 2.14.1, "Invoking Distinguished Name Definition Screen"](#)
- [Section 2.14.2, "Viewing Distinguished Name Summary"](#)

### 2.14.1 Invoking Distinguished Name Definition Screen

You can invoke 'Distinguished Name Definition' screen by typing 'MSDDSTNM' in the field at the top right corner of the Application tool bar and clicking on the adjoining arrow button...

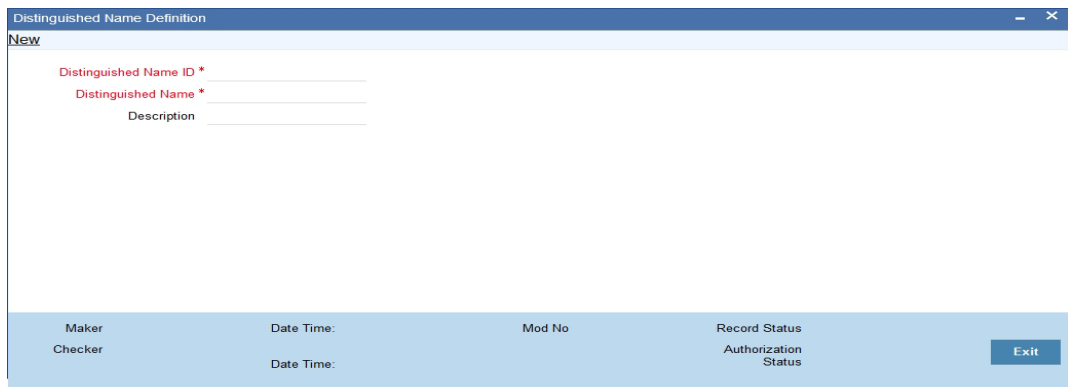

The screenshot shows a web application window titled "Distinguished Name Definition". The window has a "New" tab selected. The main content area contains three input fields with red asterisks indicating they are required: "Distinguished Name ID \*", "Distinguished Name \*", and "Description". The bottom of the window features a light blue footer with several fields: "Maker", "Date Time:", "Mod No", "Record Status", "Checker", "Date Time:", "Authorization Status", and an "Exit" button.

You can specify the following fields:

#### **Distinguished Name ID**

Specify the unique identification of the distinguished name.

#### **Distinguished Name**

Specify the distinguished name to identify the entity that sends or gets messages.

#### **Description**

Specify the description of the distinguished name.

## 2.14.2 Viewing Distinguished Name Summary

You can invoke “Distinguished Name Summary” screen by typing ‘MSSDSTNM’ in the field at the top right corner of the Application tool bar and clicking on the adjoining arrow button.

The screenshot shows a web application window titled "LBL\_DISTINGUISH\_SUMM". At the top, there are search options: "Search", "Advanced Search", and "Reset". Below this, there are two dropdown menus for "Authorization Status" and "Record Status". There are also two text input fields for "Distinguished Name ID" and "Distinguished Name", each with a magnifying glass icon. Below the search filters, there is a pagination bar showing "Records per page 15" and "1 Of 1". The main area contains a table with the following columns: "Authorization Status", "Record Status", "Distinguished Name ID", "Distinguished Name", and "Description". The table is currently empty. At the bottom right of the window, there is an "Exit" button.

You can search using one or more of the following parameters:

- Distinguished Name Id
- Distinguished Name
- Authorization Status
- Record Status

Once you have specified the search parameters, click ‘Search’ button. The system displays the records that match the search criteria for the following:

- Distinguished Name Id
- Distinguished Name
- Description
- Authorization Status
- Record Status

## 2.15 Defining Debulk Rule

This section contains the following topic:

- [Section 2.15.1, "Invoking Debulk Rule Definition Screen"](#)
- [Section 2.15.2, "Viewing Debulk Rule Summary"](#)

## 2.15.1 Invoking Debulk Rule Definition Screen

You can invoke 'Debulk Rule Definition' screen by typing MSDDEBRL' in the field at the top right corner of the Application tool bar and clicking on the adjoining arrow button...

The screenshot shows a web-based form titled "De Bulk Rule Definition". At the top left, there are "New" and "Enter Query" buttons. The form fields include: "Debulk Rule Name \*" (a required text input), "Payload Delimiter" (a text input), "Protocol" (a dropdown menu currently showing "MQHA"), "Decompression Required" (an unchecked checkbox), "Description" (a text input), and "Decompression Type" (a dropdown menu). At the bottom of the form, there are several status fields: "Maker", "Checker", "Date Time", "Mod No", "Record Status", and "Authorization Status". An "Exit" button is located in the bottom right corner.

You can specify the following fields:

### **De bulk Rule Name**

Specify the name of the debulk file.

### **Payload Delimiter**

Specify the delimiter between payloads.

### **Protocol**

Select the type of protocol.

### **Decompression Required**

Check this box if debulk processing requires decompression.

### **Decompression Type**

Select the type of decompression. Choose among the following:

- ZIP
- GZIP

## 2.15.2 Viewing Debulk Rule Summary

You can invoke “Debulk Rule Summary” screen by typing ‘MSSDEBRL’ in the field at the top right corner of the Application tool bar and clicking on the adjoining arrow button.

The screenshot shows a web application window titled "Debulk Rule Definition Summary". At the top, there are search options: "Search", "Advanced Search", and "Reset". Below this, there are four search filters: "Authorization Status" (a dropdown menu), "Record Status" (a dropdown menu), "Debulk Rule Name" (a text input field with a magnifying glass icon), and "Protocol" (a dropdown menu). A pagination bar shows "Records per page" set to 15, "1 Of 1" records, and a "Go" button next to a page number dropdown set to 0. Below the search filters is a table with a header row containing checkboxes and the following columns: "Authorization Status", "Record Status", "Debulk Rule Name", "Payload Delimiter", and "Protocol". The table body contains 15 empty rows, each with a checkbox in the first column. An "Exit" button is located in the bottom right corner of the window.

You can search using one or more of the following parameters:

- Authorization Status
- Record Status
- Debulk Rule Name
- Protocol

Once you have specified the search parameters, click ‘Search’ button. The system displays the records that match the search criteria for the following:

- Authorization Status
- Record Status
- Debulk Rule Name
- Payload Delimiter
- Protocol

## 2.16 Connectivity Operation Manager

This section contains the following topic:

- [Section 2.16.1, "Invoking Connectivity Operation Manager Screen"](#)

## 2.16.1 Invoking Connectivity Operation Manager Screen

You can invoke 'Connectivity Operation Manager' screen by typing 'MSDCNMGR' in the field at the top right corner of the Application tool bar and clicking on the adjoining arrow button...

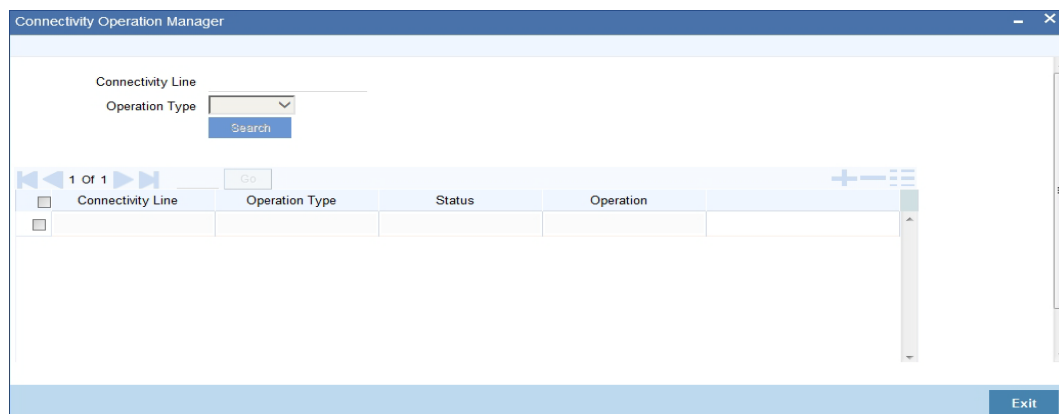

You can specify the following fields:

### **Connectivity**

Specify the required connectivity line.

### **Operation Type**

Select the type of operation.

### **Status**

Specify the display line status.

### **Start**

Click the Start button to start the connectivity line.

### **Stop**

Click the Stop button to start the connectivity line.

## 2.17 Outbound File Browser

You can use the outbound file browser for searching and viewing the outbound files. To invoke the screen, type 'MSSFLBRW' in the field at the top right corner of the application toolbar and click the adjoining arrow button.

The screenshot shows the 'Outbound File Browser' application window. It has a search bar at the top with 'Search', 'Advanced Search', and 'Reset' buttons. Below the search bar are several input fields for search criteria: File Reference Number, File Type, Generated Date, Handoff Status, File Status, Media, Network Code, and Module. A pagination bar shows 'Records per page: 15' and '1 Of 1'. Below the search fields is a table with columns: File Reference Number, File Type, Generated Date, Handoff Status, Receiver BIC, Sender BIC, File Format Type, File Status, Media, Network Code, File Name, and So. The table is currently empty. At the bottom right of the window is an 'Exit' button.

You can search for the records based on one or more of the following parameters:

- File name of the bulked file
- Bulk reference number
- Generated date
- Status
- Bulk preference

Once you have specified the above details, click 'Execute Query' button. The system displays the records that match the search criteria. You can double-click a record to view the details in the 'Outbound File Browser Details' (MSDFLBRW) screen.

You can view the following details in this screen.

- File name
- Bulk reference number
- File ID
- Generated date
- Generated time
- Status
- Bulk preference
- Number of transactions
- File size

You can resend the selected file from this screen using the 'Resend' button.

## 2.18 Inbound File Browser

You can use the inbound file browser for searching and viewing the inbound files. To invoke the screen, type 'MSSIFBRW' in the field at the top right corner of the application toolbar and click the adjoining arrow button.

The screenshot shows the 'Inbound File Browser Summary' application window. It includes a search bar with 'Search', 'Advanced Search', 'Reset', and 'Clear All' options. Below the search bar is a 'Case Sensitive' section with several search criteria: File Reference No, Received Date, Source Code, File Name, Host Code, Status, Media, and SWIFTNET Connector Name, each with a search icon. A navigation bar shows 'Records per page' set to 15, '1 Of 1' records, and a 'Go' button. Below this is a table with columns: File Reference No, Host Code, File Format Type, Received Date, Network Code, Status, Source Code, Media, File Name, and SWIFTNET. The table is currently empty. At the bottom, there is a 'View' section and an 'Exit' button.

You can search for the records based on one or more of the following parameters:

- File name
- Received date
- Status
- Logical file name
- Transaction ID
- File Act connector name

Once you have specified the above details, click 'Execute Query' button. The system displays the following details of records that match the search criteria.

- File name
- Received Date
- Received Time
- Status
- File Size
- Logical File Name
- Transaction Id
- FileAct Connector Name
- Error Code
- Error Parameter
- Error Description



## 2.19 Defining Bulk Preference

This section contains the following topic:

- [Section 2.19.1, "Invoking Bulk Preference Definition Screen"](#)
- [Section 2.19.2, "Viewing Bulking Preference Definition Summary"](#)

### 2.19.1 Invoking Bulk Preference Definition Screen

You can invoke 'Bulk Preference Definition' screen by typing 'MSDBLKRL' in the field at the top right corner of the Application tool bar and clicking on the adjoining arrow button...

You can specify the following fields:

#### **Bulk Preference Name**

Specify the name used for storing the Bulk Preference.

#### **Volume Based Trigger**

Check this box to configure volume based bulking.

#### **Maximum number of messages**

Specify the maximum number of messages that can be stored in a bulk file.

#### **Minimum number of messages**

Specify the maximum number of messages that can be stored in a bulk file.

#### **Maximum size in KB**

Specify the distinguished name to identify the entity that sends or gets messages.

#### **Minimum size in KB**

Specify the distinguished name to identify the entity that sends or gets messages.

#### **Size based Trigger**

Check this field to configure size based bulking.

#### **Scheduler Type**

Select the type of scheduler. Choose any one of the following:

- Time Based

- Frequency

**Start Time**

Specify the Start Time of the trigger. Enter the format in HH:MM format.

**End Time**

Specify the Start Time of the trigger. Enter the format in HH:MM format.

**Time Interval in Min**

Specify the interval of the repeat in MM format.

**Scheduling No**

Specify the scheduling sequence.

**Start Hour**

Specify the start hour of the scheduling sequence.

**Start Min**

Specify the start minute for frequency based scheduler.

**Bulk File Name Prefix**

Specify the prefix to indicate the name of the bulk file.

**Maximum size of a file of KB**

Specify the maximum size of a bulk file in KB.

**Payload Delimiter**

Specify the delimiter while bulking messages.

**Maximum settlement amount for a file**

Specify the maximum settlement for a file that must be considered while bulking messages.

**File Format**

Select the file that must be used while bulking messages.

**File Type**

Select the file type that must be used while bulking messages.

**Compression Required**

Check this box to indicate that file compression is required.

**Compression Type**

Specify the required type of compression.

**Destination Type**

Specify the type of destination.

- Folder
- Queue
- SwiftNet Connectivity

If destination is Swiftnet connectivity then a field swiftnet connectivity needs to be selected from LOV which gives the list of connectivity lines.

**Folder Path**

Specify the user defined destination folder path.

### Queue JNDI Name

Specify JNDI name of the Queue if the destination type is Queue.

### SwiftNet Connectivity

Select the swiftnet connectivity from the option list.

### Protocol Type

Select the type of Protocol.

- FTA

### Protocol Name

Specify the protocol name required for FTA protocol.

## 2.19.2 Viewing Bulking Preference Definition Summary

You can invoke “Bulking Preference Definition Summary” screen by typing ‘MSSBLKRL’ in the field at the top right corner of the Application tool bar and clicking on the adjoining arrow button.

Authorization Status	Record Status	Bulk Preference Name	Max Number of Messages	Size (in KB)	Bulk File Name Prefix	Maximum size of Bulk File (in KB)	Bulk Initiated

You can search using one or more of the following parameters:

- Bulking Preference Name
- Bulk Initiated
- Auth Initiated
- Record Status

Once you have specified the search parameters, click ‘Search’ button. The system displays the records that match the search criteria for the following:

- Bulking Preference Name
- Frequency
- Max Number of Messages
- Size (in KB)

- File Format
- Bulk Filename Prefix
- Maximum size of bulk file (in KB)
- Bulk Initiated
- Destination Type
- Auth Status
- Record Status

## 2.20 Bulk Monitor

You can monitor the messages and executions in bulk using 'Bulk Monitor' screen. To invoke this screen, type 'MSSBLKMN' in the field at the top right corner of the application toolbar and click the adjoining arrow button.

You can search for the records based on one or more of the following parameters.

- Execution start time
- Execution end time
- Bulk preference
- Status
- Number of files generated

Once you have specified the search parameters, click 'Execute Query' button. The system displays the following details of the records that match the filter criteria.

You can view the details of each record in the results. Double-click a record from the results to view the details in 'Bulk Monitor Detail' (MSDBLKMN) screen.

The screenshot shows a window titled "Bulk Monitor" with a list of fields for data entry or viewing. The fields are: Process Reference Number, Execution Start Date, Execution Start Time, Execution End Date, Execution End Time, Status, Bulk Preference Name, No Of Files Generated, Error Code, Error Parameter, and Error Description. Below the fields are two buttons: "Regenerate" and "Exit".

This screen displays the following details of the record.

- Process reference number
- Execution start date
- Execution start time
- Execution end date
- Execution end time
- Status
- Bulk preference name
- Number of files generated
- Error code
- Error parameter
- Error description

You can regenerate the files by clicking 'Regenerate' button. You can also bulk a selected bulk preference ad-hoc using 'Initiate Adhoc Bulking' button.

---

## 3. Function ID Glossary

### M

MSDBLKMN .....	2-39	MSDRLMAP .....	2-17
MSDBLKRL .....	2-35	MSDSWTSR .....	2-12
MSDCNMGR .....	2-32	MSSBLKMN .....	2-38
MSDDEBRL .....	2-30	MSSBLKRL .....	2-37
MSDDSTNM .....	2-28	MSSDEBRL .....	2-31
MSDFLBRW .....	2-33	MSSDSTNM .....	2-29
MSDFTACN .....	2-26	MSSFLBRW .....	2-33
MSDLAUMN .....	2-14	MSSFTACN .....	2-27
MSDMEDMT .....	2-5	MSSIFBRW .....	2-34
MSDMGMCS .....	2-2	MSSLAUMN .....	2-15
MSDPTPRM .....	2-24	MSSNOTIB .....	2-10
MSDQMAP .....	2-8	MSSPTPRM .....	2-25
MSDQMNT .....	2-9	MSSRLDFN .....	2-23
MSDRLDFN .....	2-21	MSSRLGRP .....	2-20
MSDRLGRP .....	2-19	MSSRLMAP' .....	2-18
		MSSSWTSR .....	2-13