

# XPLM<sup>®</sup>



## **Agile Product Lifecycle Management**

**MCAD Connectors for Agile Engineering Collaboration**

### **User Guide**

**V 3.6.2.1**

Oracle Part Number – F17192-02

April 2019

# Copyrights and Trademarks

## IMPORTANT NOTICE

This document contains information protected by copyright.

All rights are reserved, including the translation. No part of this documentation may be reproduced in any way (print, photocopy, microfilm or any other form) or processed, duplicated or distributed by use of electronic system without written permission of the company. The information contained in this documentation does not constitute any obligation on the part of the seller. The software described in this documentation is delivered under licensing contract which governs its use.

XPLM Solution is not liable for errors in this documentation.

All trademarks are the property of their respective owners.

### Contact Address (for Support Services see Preface chapter):

XPLM Solution GmbH  
Altmarkt-Galerie Dresden, Altmarkt 25  
D - 01067 Dresden, Germany  
[www.xplm.com](http://www.xplm.com)

XPLM Solution Inc.  
250 Commercial Street, Suite 520  
Worcester, MA 01608 USA

## CONTENT

---

Copyrights and Trademarks.....	2
What is New in MCAD Release 3.6 .....	8
Toolbox and Library Part Support .....	8
Strict CAD Modification Workflow.....	8
Find Number Mapping for Creo Parametric .....	8
IDF Import (Creo Parametric only).....	8
Starting the Agile PLM MCAD Connector .....	8
Menus and Toolbars .....	9
AutoVue Access from MCAD .....	16
Saving to Agile .....	16
Introduction.....	16
The EC Workspace .....	16
Using the Save Command.....	17
Checking In Design Structures .....	26
Multi-Select and Context Menus .....	26
Numbering Options .....	29
Accessing Agile Object via Links.....	30
Strict CAD Modification Workflow (ACW and ACE only) .....	31
Preferences Dialog.....	33
PLM Usage (PLM Mode) .....	34
Load Preferences .....	34
Activating and Deactivating the Load Preview Dialog .....	36
Save Preferences .....	36
Item and Publish Preferences.....	37
Class Preferences.....	40
Viewable Creation Preferences .....	41
Viewable File Creation Preferences.....	41
Property Value Preferences.....	42
Design Structures.....	43
Recursive Structures.....	44
Saving with Derived Files .....	44
Supported Viewable File Formats.....	45
Save with drawings .....	46
<i>Save Session</i> Command .....	46
Save with Configurations .....	46
Saving Commands Summary .....	46

Feature Tree Context Menu Items.....	47
Quick View .....	48
“Check In/Incorporate”, “Check out” and “Cancel Checkout” .....	48
Status Information .....	50
Information Displayed by Structure Browser Nodes .....	52
File Sync Status Mismatch .....	56
Loading from Agile.....	56
Introduction.....	56
Using the Load Command.....	58
Load Dialog .....	59
Multi-Select and Context Menus .....	63
Structure Resolution Options .....	66
Creating New Objects.....	68
Introduction.....	68
Using the Create Object Dialog.....	69
Details Pane.....	70
Preferences Pane (initially collapsed).....	72
Workspace Pane .....	73
Design and Item Properties Tables.....	73
Workspace Management .....	74
Introduction.....	74
Workspace name with Asian characters .....	74
Set Workspace During Load, Save or Object Creation.....	75
Archiving Complete Workspaces .....	76
CAD working directory vs. EC Workspaces .....	77
Workspaces on Save .....	77
Workspaces on Load.....	79
Workspaces on CAD Start .....	80
Using the Workspace Manager.....	80
Using the Workspace Manager CAD Session Tab .....	80
Multi-Select and Context Menus .....	82
Using the Workspace Manager Workspaces Tab .....	84
Search Field in the Workspace Manager .....	85
Multi-Select and Context Menus .....	86
File Sync Status Mismatch (Creo Connector Only) .....	88
Design File Release Process.....	89
Incorporating Design Objects .....	89
Assigning Design File Change Orders.....	89
Assigning File-Less Design Objects to Design Changes .....	90
Concurrent Engineering.....	90

Design File Release Process .....	93
Strict CAD Modification Workflow.....	93
Known Issue for Solid Edge.....	93
BOM Publishing .....	93
Introduction.....	94
Overview of the BOM Publishing Process.....	94
Using the Save Command with Publish Options.....	95
Details of the BOM Publishing Process.....	99
Configurations and Family Tables.....	101
Change Process For Parts.....	101
Mapping Find Numbers to the PLM BOM.....	101
Toolbox and Library Parts (ACW and ACE Only) .....	103
Property Mapping .....	104
Introduction.....	104
Types of Mapping .....	104
CAD Thumbnail Support .....	106
Thumbnails for Part and Assembly Families/Configurations.....	107
CAD specific Functionality .....	107
Callback/User Exits in CAD Menu -> Save As – Solid Edge.....	107
Handling of Part Families and Configurations .....	107
Numbering of Part Families and Configurations.....	108
Family Table Handling – Creo Parametric.....	108
Introduction.....	108
EC Web Connector User Interface (Design).....	108
"Save Family Table" Command.....	110
External Reference Handling – Creo Parametric .....	112
Introduction.....	112
EC Web Connector User Interface.....	112
Support for Suppressed Components – Creo Parametric.....	114
Simplified Representations – Creo Parametric.....	117
Using Agile Find Numbers – Creo Parametric.....	120
CGR File Handling – CATIA V5 .....	121
Introduction.....	121
Functionality Overview – Datamodel .....	121
Changes to existing commands .....	127
Configuration Handling – SolidWorks.....	128
Introduction.....	128
Functionality Overview.....	128
Sample Configuration Handling.....	129
Customizing the Configuration Properties .....	130

- Sample Master Configuration..... 133
- SolidWorks and Solid Edge External References to Assemblies .....134
- Save As Override Functionality – Solid Edge.....135
- IDF Import – Creo Parametric.....136
- Web Conferencing with MCAD.....137

# Preface

## Contacting Oracle Support Services

For Oracle Agile Engineering Collaboration support contact the Oracle Global Customer Support (GCS) via [www.oracle.com/support](http://www.oracle.com/support) or My Oracle Support via <https://support.oracle.com>.

## Accessibility of Code Examples in Documentation

Screen readers may not always correctly read the code examples in this document. The conventions for writing code require that closing braces should appear on an otherwise empty line; however, some screen readers may not always read a line of text that consists solely of a bracket or brace.

This documentation may contain links to web sites of other companies or organizations that xPLM Solution does not own or control. xPLM Solution neither evaluates nor makes any representations regarding the accessibility of these web sites.

## What is New in MCAD Release 3.6

### Toolbox and Library Part Support

The MCAD connector for SolidWorks now supports toolbox or library parts. This functionality allows users to utilize the native toolbox/library part functionality of the CAD system while retaining compatibility to the MCAD connector's workflow. Refer the *Toolbox and Library Parts (ACW and ACE Only)* chapter for details.

### Strict CAD Modification Workflow

Since release 3.6, the MCAD connectors for SolidWorks and Solid Edge support a strict modification workflow. This means, that CAD users are only allowed to modify PLM-known CAD files in case that they also hold the check out in Agile PLM. For details, refer the *Strict CAD Modification Workflow (ACW and ACE only)* chapter for details.

### Find Number Mapping for Creo Parametric

The *Transfer BOM find numbers* functionality previously only available for the MCAD connectors for SOLIDWORKS and Solid Edge is now also available for Creo Parametric. Unlike the corresponding functionalities for the other connectors, however, *Transfer BOM find numbers* requires some configuration and also allows for additional customizing and BOM table layouts. Refer the *Mapping Find Numbers to the PLM BOM* chapter for details.

### IDF Import (Creo Parametric only)

The MCAD connector for Creo Parametric now allows saving IDF files alongside the corresponding, imported Creo geometry files created by Creo's IDF import functionality. The IDF files are saved to Agile as viewable files in this case. Refer the *IDF Import – Creo Parametric* chapter for details.

## Starting the Agile PLM MCAD Connector

The MCAD Connector for Agile PLM is operated from within your CAD system environment. Your administrator provides you with a start-up command or icon that starts your CAD system with the MCAD Connector functions enabled.

---

**Note** In order to use Engineering Collaboration you must be a registered Agile user.

---

Starting with release 3.0, Engineering Collaboration MCAD connectors can work with the PLM

Design data model only. This chapter describes the use of EC with the Design data model.

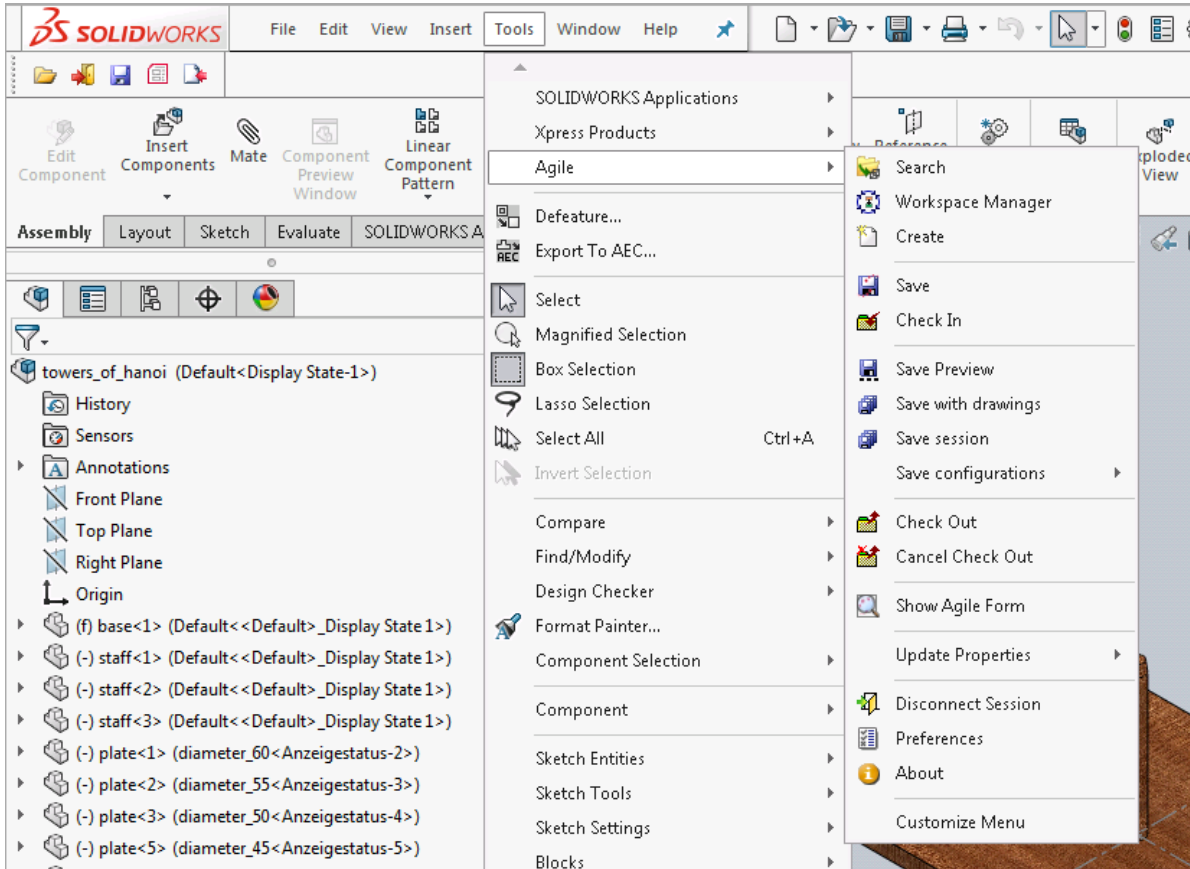
## Menus and Toolbars

When EC is enabled, you see an Agile menu in your menu bar, and optionally an Agile toolbar. Access to Engineering Collaboration functions is through this menu or toolbar.

**Table 1: EC Access Methods: According to the CAD System**

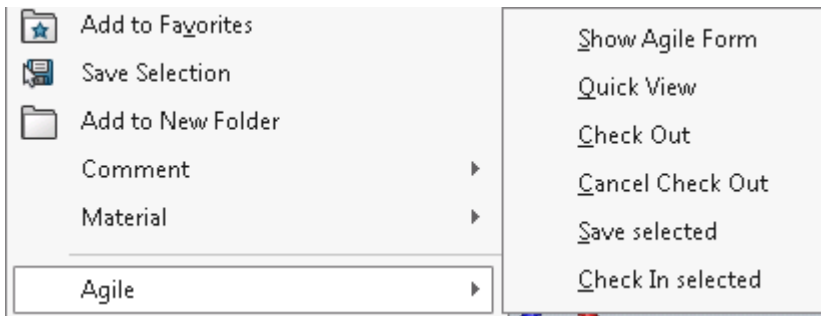
CAD System	EC Access Method
AutoCAD	Ribbon bar
Catia V5	Toolbars and menu
Creo Parametric	Menu and toolbar
Inventor	Ribbon bar
NX	Menu and toolbar
SolidWorks	Menu
SolidWorks 2015 and later	The CAD vendor changed the behavior of SW. Beginning with version 2015, add-in menus, such as the "Agile" menu, are displayed in the "Tools" sub-menu instead of the root menu bar.
Solid Edge	Ribbon bar

An example of both the Agile menu and toolbar is seen in the figure below:



**Figure 1: Example of both the Agile menu and toolbar**










The figure below shows a sample for the CAD context menu directly embedded into the CAD feature tree:













**Figure 2: An example of the CAD context menu directly embedded into CAD.**

The contents and functions of the Agile menu and toolbar, which are common to all connectors, are shown in the table below.

**Table 2: Agile Commands**

Command	System	Icon	Function
Search in Agile	All		Opens the Agile Web Client in Parametric Search mode in order to find a design to load into CAD. Note that the load function can be initiated directly from the web client using the <i>Load to CAD</i> function.
Workspace Manager	All		Opens the Workspace Browser window. Displays checkout and revision status of the current CAD model and all its components. Also allows changing checkout status, and creation and deleting of different workspaces. If a Part Family Generic is active in CAD, the status of the entire Part Family table is displayed.
Save	All		Saves files from the current CAD model and all its components into Agile, with no save Preview dialog using default save options.
Save Preview	All		Saves files from the current CAD model and all its components into Agile, with a dialog that allows the setting of save options.
Save Session	All		Saves files from the current CAD session into Agile, with a dialog that allows the setting of save options.
Save Family Table	Pro/E, NX		Allows the user to save an entire family table at once. With Pro/E, this process also validates the family table. The user is prompted if there are any errors with the validation process and a log file is created for review.
Check Out	All		Performs a Check Out on the selected CAD objects in PLM. In SolidWorks and Pro/E the options are in the CAD context menu.
Cancel Check Out	All		Cancel the Check Out on the selected CAD objects in PLM. In SolidWorks and Pro/E the options are in the CAD context menu.
Check In	All		Saves the current CAD model and its first level structure into Agile. Components of the selected object are not saved. In SolidWorks and Pro/E the options are in the CAD context menu.

Command	System	Icon	Function
Show Agile Form	All		Launches the Agile Web Client and displays the Agile form corresponding to the current CAD model. In SolidWorks and Pro/E the options are in the CAD context menu.
Transfer BOM find numbers	SolidWorks Solid Edge		Transfers BOM table find numbers from drawing BOM tables or drawing balloons to the BOM tab of the related <i>model</i> Item in Agile. Some MCAD connectors do not support this function for drawing files with multiple references models and/or multiple BOM tables.
Update Properties	All		Sets property (attribute) values in CAD based on values from Agile. Properties for the current CAD model and all its components are updated. The specific attributes to map are defined by your administrator in the configuration file.
Update Properties → First Level	All		Same as <i>Update Properties</i> , but only sets them for the current CAD model and the next lower level (typically used for setting drawing and model properties together).
Update Properties → Current	All		Same as <i>Update Properties</i> , but only sets them for the current CAD model.
Update Title Block	All		Sets text values in the CAD drawing title block based on values from Agile. The specific attributes to map are defined by your administrator in the configuration file.
Quick View	Solid Edge		Opens a popup dialog with the most important PLM-related information for the current CAD object. Also available in the CAD feature tree context menu, refer to chapter <i>Quick View</i> for details.
Open Native File	CATIA V5		Opens the native CATPart or CATProduct files for the selected CGR file(s).
Disconnect Session	All		Starts (or re-starts) the EC Web Connector. Usually the Web Connector is started automatically on demand.
About	All		Displays information about the current version of the CAD Connector.

### CAD Connector Functionality

In order to understand the details of the CAD Connector functionality, it is important to understand the overall process and how the data is stored in Agile. The figure below gives a high-level view of the process.

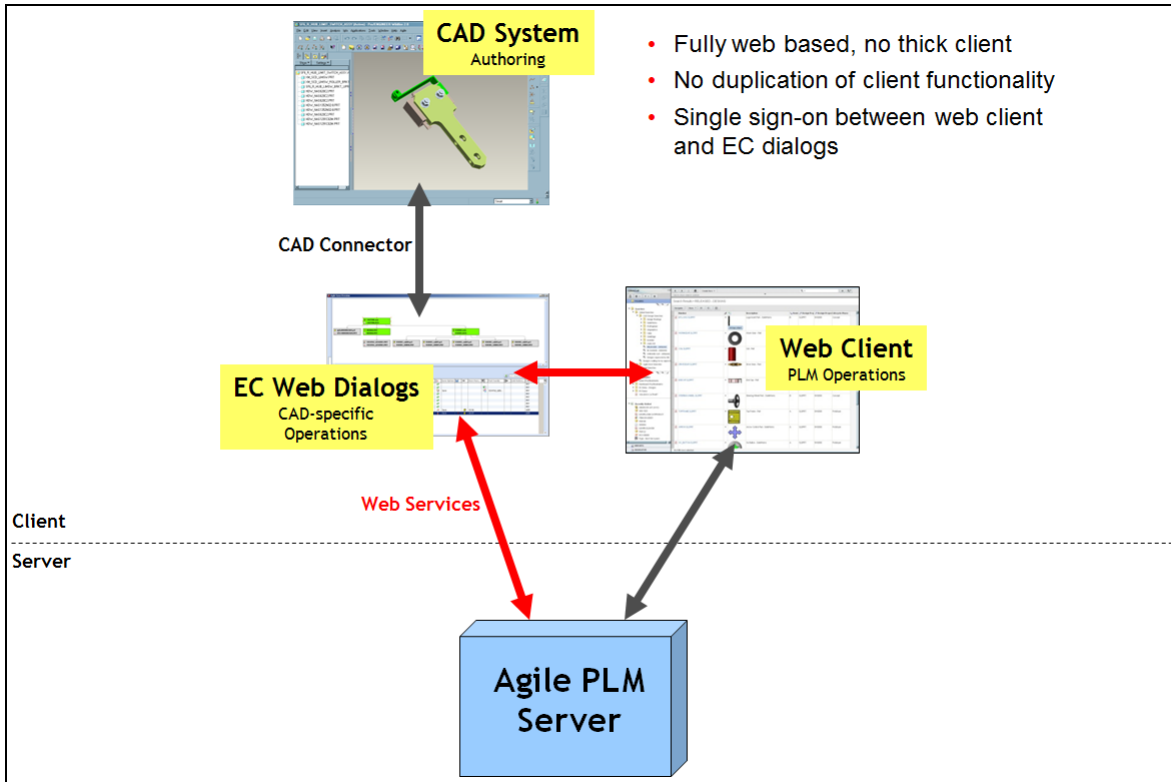
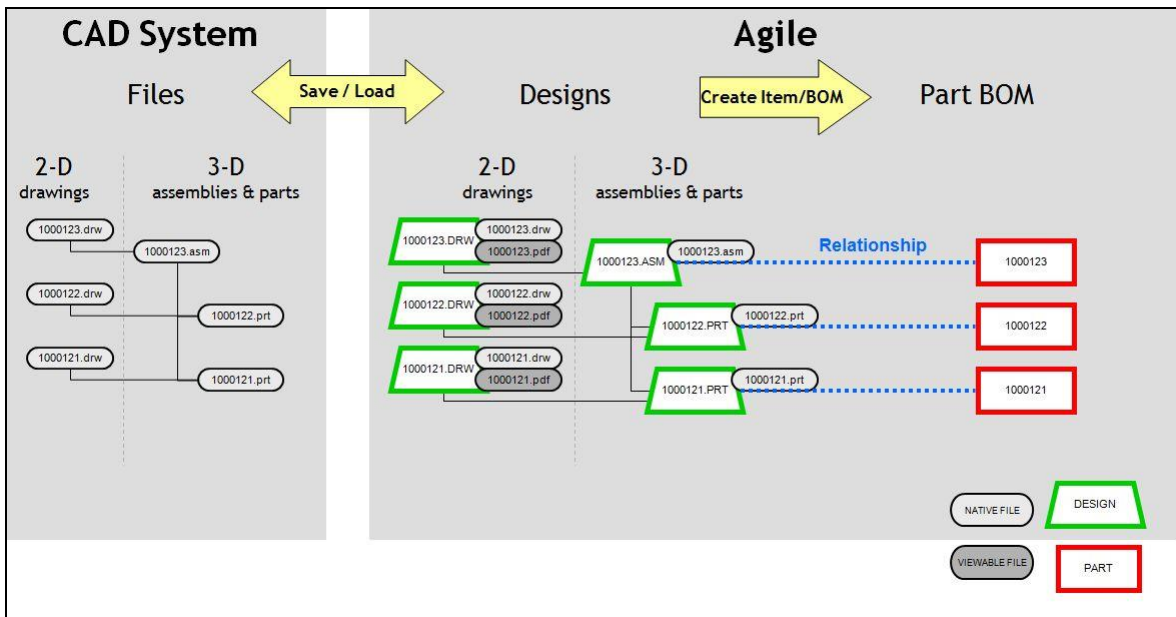


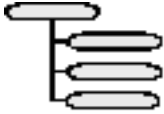
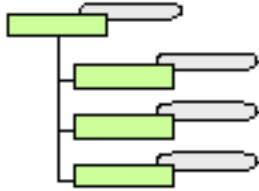
Figure 3: Agile Engineering Collaboration Process

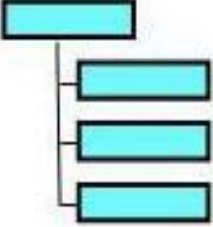


**Figure 4: EC concept**

One important concept is that EC creates two distinct structures inside Agile, one is the Design Structure, and the other is the Part BOM. Each of these is based on the CAD file structure that is created by the designer in the CAD system. The following table explains the purpose of each of these structures:

**Table 3: EC Structure types**

Structure Type	Data Type	How Created	Purpose
CAD File Structure 	Files	Created by building CAD models. The structure is known within the CAD files.	Defines the assembly structure of CAD models. Also used to structure the relationships between CAD drawings and the components on the drawing.
Design Structure 	Agile Design object, with attached files	Created using the EC Agile → Save command	Manages the CAD files within Agile, for saving and loading designs. The Design Structure matches the CAD file structure on a one-for-one basis.

Structure Type	Data Type	How Created	Purpose
Part BOM 	Agile Part object	Created using the EC <i>Agile</i> → <i>Save</i> command with publish option	The Part BOM represents the physical product that you are going to build. When the Part BOM is created by EC, the Design objects can be linked in a variety of ways to the Part BOM.

To create and modify these structures in Agile, the CAD Connectors have three main functions – Save, Load and Workspace Manager. Each function has its own dialog window in the EC Web Connector. These functions are *Save*, *Load*, and *Workspace Manager*. These functions are described in the following sections, followed by other miscellaneous functions.

## AutoVue Access from MCAD

MCAD dialogs now provide controls to directly access AutoVue. The AutoVue toolbar button which is available in the CAD and Workspace tab of the Workspace Manager allows users to easily access AutoVue displaying a certain CAD file, without having to access Agile PLM's web client first.



**Figure 5: AutoVue Toolbar Button**

## Saving to Agile

### Introduction

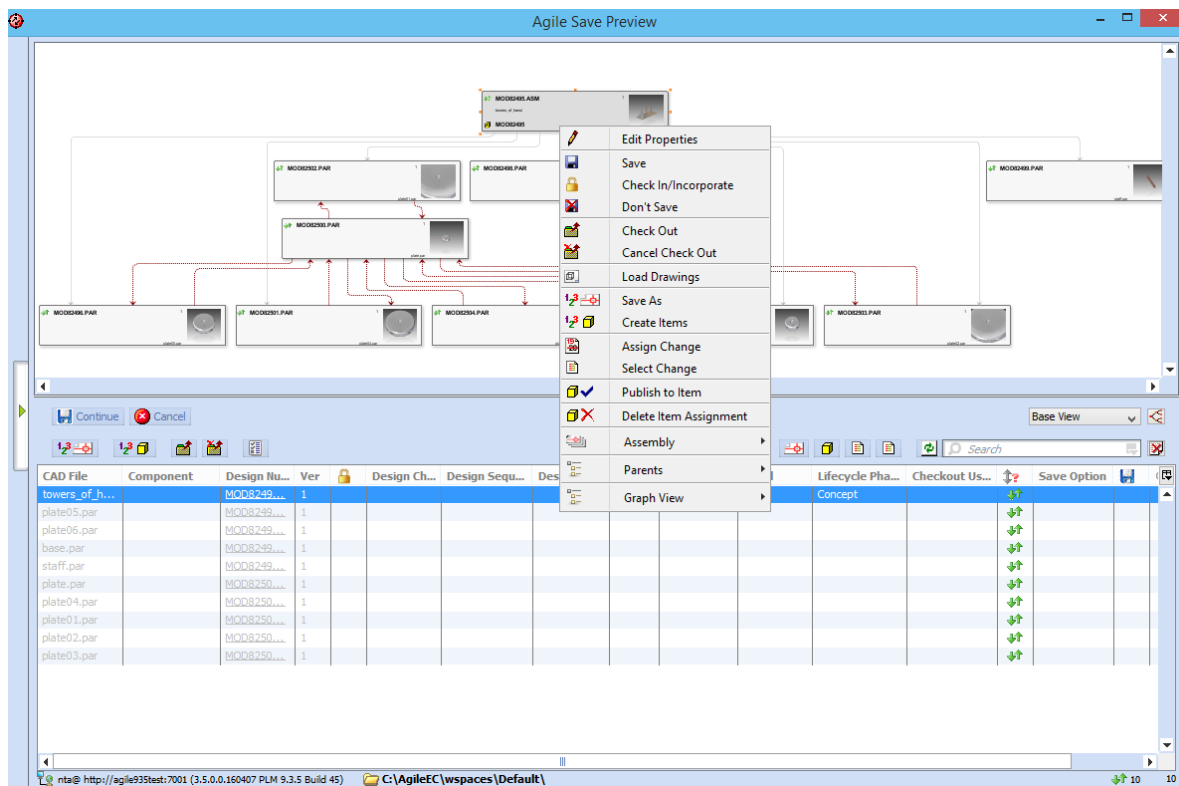
Saving into Agile, using the *Agile* → *Save* command, creates a Design Structure in Agile. This structure stores all CAD design files (Parts, Assemblies, Drawings, etc.) in a way that supports CAD work-in-progress design, and makes the data available to the rest of the organization, as privileges permit. It saves the current CAD model (whatever is in the active CAD window), including all lower-level components.

### The EC Workspace

When you work with Agile Engineering Collaboration you still have a local workspace directory where your CAD files reside. The location of this workspace directory is determined by your system administrator. This is where files are copied to when you use the Load command. If you use your CAD system's File → Save command, the files are saved into this workspace directory. You should use File → Save to save periodically as you normally would, to prevent data loss during your daily work. Use the Agile → Save command on a regular basis to secure your data within Agile, and to make it available to others.

## Using the Save Command

When you execute the *Agile* → *Save Preview* command, the Save dialog is displayed similarly to what is shown in the figure below.



**Figure 5: EC Save preview: Context Menu**

The Save dialog has two display areas. The top area displays the CAD structure information. Each node in this browser view contains the CAD filename, the assigned PLM Design number and PLM related information.

The bottom area displays the CAD attributes and some PLM attributes. The context menu is available in the list view and in the browser view. It contains the same menu items in both views

to control the save behavior.

After changing any options within the dialog (see below for details), click the *Continue* button to start the save process. When saving for the first time, AutoNumbers are assigned to each model depending on the related preferences setting (refer to chapter

*Preferences Dialog* on page 33 for details). Interactive mode can be used by double-clicking on a node or row in the dialog, which pops up a details dialog out of the left sidebar for the selected file, in order to capture property information needed for the initial save, as shown in the image below.

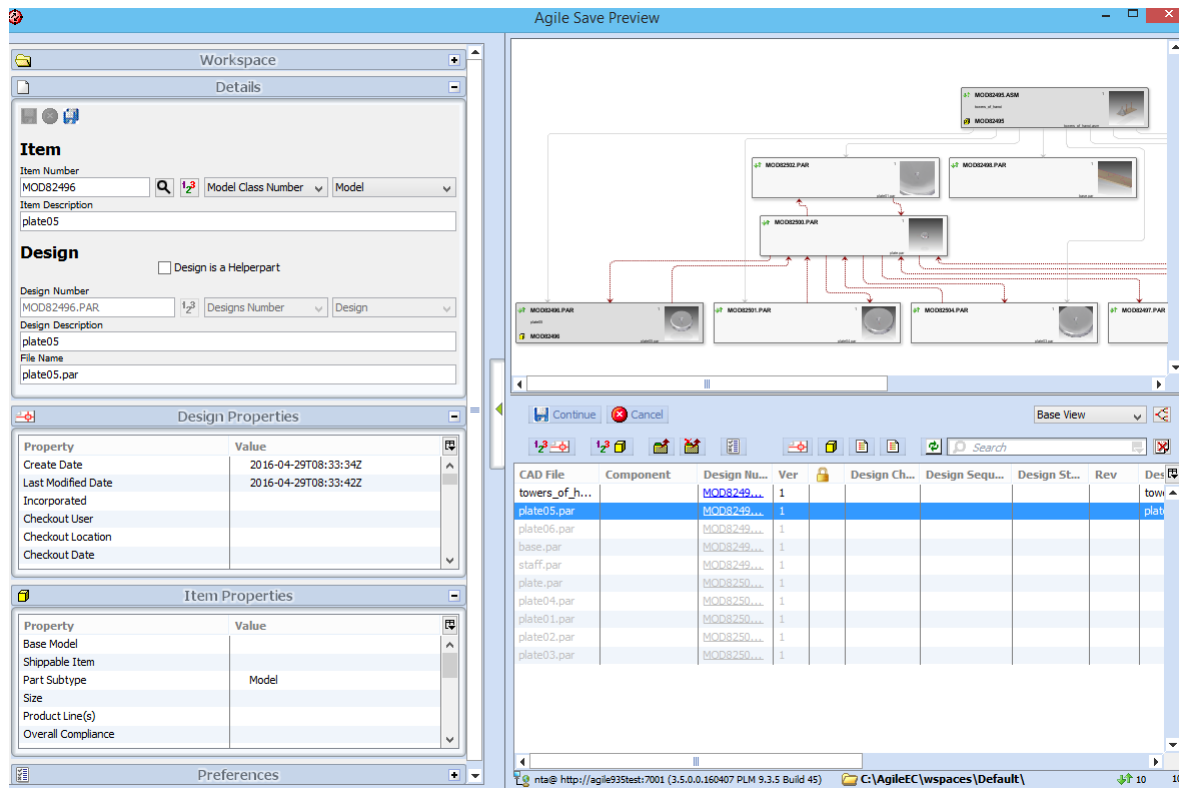
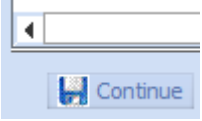











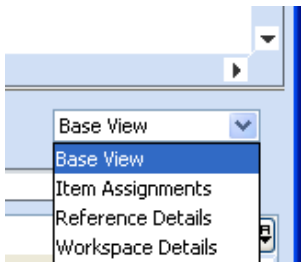




Figure 6: EC Save preview: Toolbar Options

Details of the Save dialog are shown in the table *Save Dialog Toolbar Options* and *Details of Save Dialog* below, and described in the tables *Toolbar Options* and *List Fields and Control*.

**Table 4: Save Dialog Toolbar Options**






<p><b>Start Save into PLM</b></p> 	<p>Starts the CAD Save procedure including upload of files and structure update in PLM.</p> <p>Related Drawings or Manufacturing objects get their number from the underlying 3D model in the case that there is only one model directly referenced. If there is no 1:1 relationship, a design AutoNumber is used.</p>
<p><b>Abort Save</b></p> 	<p>Closes the dialog and returns to CAD. Also closing the Window with the close button in the top right corner is supported.</p>
<p><b>Create new Design with AutoNumber (SaveAs)</b></p> 	<p>According to the preferences settings for creation of designs and parts, there are two options:</p> <ol style="list-style-type: none"> <li>1. The <i>Save As</i> preference is set to <i>Part and Design</i>: In this case the default Part AutoNumber source is used to assign new numbers to the selected designs. The system creates a design of the default Design subclass using this number plus the file extension. Additionally the system creates and links a Part of the default Part subclass with the same number, if the <i>Part Assignment</i> preference is set to <i>Create and Link</i>.</li> <li>2. The <i>Save As</i> preference is set to <i>Design only</i>. In this case the default Design AutoNumber source is used to assign new numbers to the selected designs, the default Design subclass is used. The system does not create or link Parts.</li> </ol> <p>Related Drawings or Manufacturing objects get their number from the underlying 3D model in the case that there is only one model directly referenced. If there is no 1:1 relationship, a design AutoNumber is used.</p>
<p><b>Assign Parts to Designs using Part AutoNumber</b></p> 	<p>The system uses the default Part AutoNumber to assign Parts to Designs that are not already linked to any Part. The system does not assign Parts to Drawings, Helper Parts or Manufacturing objects. Only the 3D model is linked to a Part.</p>
<p><b>Check Out</b></p> 	<p>Set checkout reservation for the selected components.</p>
<p><b>Cancel Check Out</b></p> 	<p>Cancel checkout reservation for the selected components.</p>







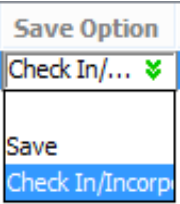






<p><b>Open Preferences</b></p> 	<p>Expands a dialog in the left sidebar which allows you to set the default Design sub-class and number, desired viewable file formats, and default property mappings. See the <i>Preferences Settings</i> section for details.</p>
<p><b>Refresh</b></p> 	<p>Updates the attribute contents of the dialog from PLM.</p>
<p><b>Show Design Web Form</b></p> 	<p>Launches the PLM Web Client Form for the selected Design.</p>
<p><b>Show Part Web Form</b></p> 	<p>If a Part is linked to the selected Design, the Part form is displayed in the Web Client.</p>
<p><b>Open Form for Item Change</b></p> 	<p>If a Part is linked to the selected Design and the Part has been assigned to a Change object, the Item Change form is displayed in the Web Client.</p>
<p><b>Open Form for Design Change</b></p> 	<p>If a Design File Change Order is assigned to the selected Design object, the Design Change form is displayed in the Web Client.</p>
<p><b>Attributes View Selector</b></p> 	<p>The view selector switches the visibility of attribute sets in the list area. The <i>Base View</i> contains the most important information for tracking the PLM checkout status and the assignment of a CAD file to a PLM design object. The <i>Item Assignments</i> view shows additional information about the Part assignment and the Part attributes. The <i>Reference Details</i> view displays specific information for parts with external references or part families. The <i>Workspace Details</i> view shows the complete local path settings in addition to the <i>Base View</i>.</p>
<p><b>Tree View Toggle</b></p> 	<p>The tree view selector switches the visibility of the structure browser on and off. By default the structure view is shown. The default is set by an administrator in CAXConfig.xml. Please refer to the <i>Administration Guide</i> for details.</p>
<p><b>Filter Modified Toggle</b></p> 	<p>The toggle filter view selector switches the visibility of non-modified files in the table on and off. By default all files are shown. The default is set by an administrator in CAXConfig.xml. Please refer to the <i>Administration Guide</i> for details.</p>




CAD File	Comp...	Design Num...	Ver	Design ...	Design Sequ...	Design Sta...	Rev	Description	Label	Lifecycle ...	Check...	Save Option	Type
towers...		MOD82495_A...	1					towers_of_...		Concept		Save Check In/Incorporate	ASM
plate0...		MOD82496_PAR	1										PAR
plate0...		MOD82497_PAR	1										PAR
base.par		MOD82498_PAR	1										PAR

Figure 7: Details of Save Dialog

Table 5: List Fields and Controls of the Base View

<b>CAD Object</b>	The CAD filename that is being saved.
<b>Number</b>	Number of the Design objects in Agile that contain the CAD file and any viewable files.
<b>Component</b>	Component type of the Design object in Agile.
<b>Version</b>	Version of the Design object. This number starts at 1 and increments by 1 for each check in.
<b>Is Incorporated</b> 	<p>Indicates, if a CAD file change is incorporated regarding the assigned Design File Change Order (DFCO). This column is empty, if not DFCO is assigned.</p> <ul style="list-style-type: none"> <li> The change is not incorporated on the Design Change. Saving with save option <i>Check In/Incorporate</i> implicitly incorporates the change.</li> <li> The change is incorporated on the Design Change, but the Change is not released.</li> <li> The change is incorporated on a Design Change, that is released.</li> </ul>
<b>Design Change</b>	Displays the number of the pending Design File Change Order currently assigned to this Design object.
<b>Rev</b>	The Revision of the Design object, which includes a major and minor component.
<b>Description</b>	Description of the Design object in Agile.
<b>Design Sequence</b>	Displays the <i>Design Sequence</i> of the related Design File Change Order. Empty, if not DFCO is assigned.
<b>Design Status</b>	Displays the Status of the related Design File Change Order. Empty, if the DFCO is released or no DFCO is assigned.
<b>Lifecycle Phase</b>	The lifecycle phase associated with the current Design version.
<b>Checkout User</b>	The name of the current checkout user, if any.
<b>File Status</b> 	<p>Indicates whether the file has been modified in CAD. If so, the Modified Flag icon displayed in the column, and the <i>Save Mode</i> is set to save the file.</p> <p>There are the following statuses:</p>

	<ul style="list-style-type: none"> <li> The object is new to PLM, the object is preselected for save</li> <li> The object is up to date with PLM, the object is deselected from save</li> <li> The object is known in PLM and is modified locally, the object is preselected for save</li> <li> The object is known in PLM and was modified by someone else in PLM, the object is deselected from save</li> <li> The object was modified in PLM and locally. The object is NOT preselected for save. The user decides whether to overwrite the changes in PLM or not.</li> <li> Unknown synchronization status. PLM ID exists in Agile PLM but the cache information is missing. User needs to resolve this by manually preselecting the save status. (Items with this status are not preselected by EC)</li> </ul>
<p><b>Save Mode</b></p> 	<p>Controls whether the file is saved or not, and in what mode. There are three possible options, that can be selected directly in the user interface:</p> <ul style="list-style-type: none"> <li>▫ <b>(blank)</b> – don't save</li> <li>▫ <b>Check In/Incorporate</b> – save and check in (release reservation)</li> <li>▫ <b>Save</b> – save, check in, and check out again</li> </ul> <p><b>Note:</b> <i>Check In/incorporate</i> is the only option that triggers publishing based on the preferences settings.</p>
<p><b>Save Status</b></p> 	<p>Indicates whether or not you have the ability to save this component into Agile, based on your privileges and the state of the object in Agile. If not, a <i>Stop Sign</i> icon is displayed in the column. If there is an action required, an exclamation mark is shown.</p> <p>Indicates the progress of the save operation as follows:</p> <ul style="list-style-type: none"> <li>✓ File has been successfully saved</li> <li>● No write privilege in PLM, save process is stopped at this point</li> <li> Checkout or SaveAs Action required, in order to save the file to PLM</li> <li>! In PLM a newer version is available. Checkout only if you want to overwrite the PLM version with the local version. You need to select the save option manually even if the object is marked as modified locally. If you don't want to overwrite, use the Save As command in order to assign a new Design object.</li> <li>✗ This sign explains the missing privileges in combination with the underlying icon. The privileges for checkout () , check in () and modify () are checked. If another user has checked out the object, the cancel checkout is disabled () .</li> </ul> <p>You can only use the <i>Save As</i> command to create a new Design object in PLM.</p>

	<p>You cannot overwrite the existing Design in PLM.</p> <p><b>(blank)</b> The file can be saved to PLM.</p>
<p><b>Part Assignment</b></p> 	<p>Indicates whether or not an Item is assigned to the Design</p> <ul style="list-style-type: none"> <li> Design does not get an Item assigned (Drawing, Helperpart, Manufacturing)</li> <li> Design is assigned to an Item object</li> </ul> <p><b>(blank)</b> Design is not assigned to an Item object</p>
<p><b>Item</b></p>	<p>This field indicates the Part Number:</p> <ul style="list-style-type: none"> <li>▫ When the Item is initially being created, this displays the pre-defined mapping of the Item Number field for this item. This can be changed in the interactive dialog.</li> <li>▫ Once the Item has been created, this field shows the Item Number that was used.</li> </ul>
<p><b>Rev</b></p>	<p>Current revision of the Item in Agile. Parentheses indicate a pending revision.</p>
<p><b>Change</b></p>	<p>This shows the ECO number that is assigned to this Item, to control the Item creation or update through the change process. If there are multiple pending changes, the desired change can be selected here.</p>
<p><b>Description</b></p>	<p>Description of the Item object in Agile.</p>
<p><b>Lifecycle Phase</b></p>	<p>The lifecycle phase associated with the current Item.</p>
<p><b>CAD Type</b></p>	<p>Shows the CAD file extension, which can be used for sorting.</p>

Details of the interactive Save Dialog are shown in the figure below and described in the following table.

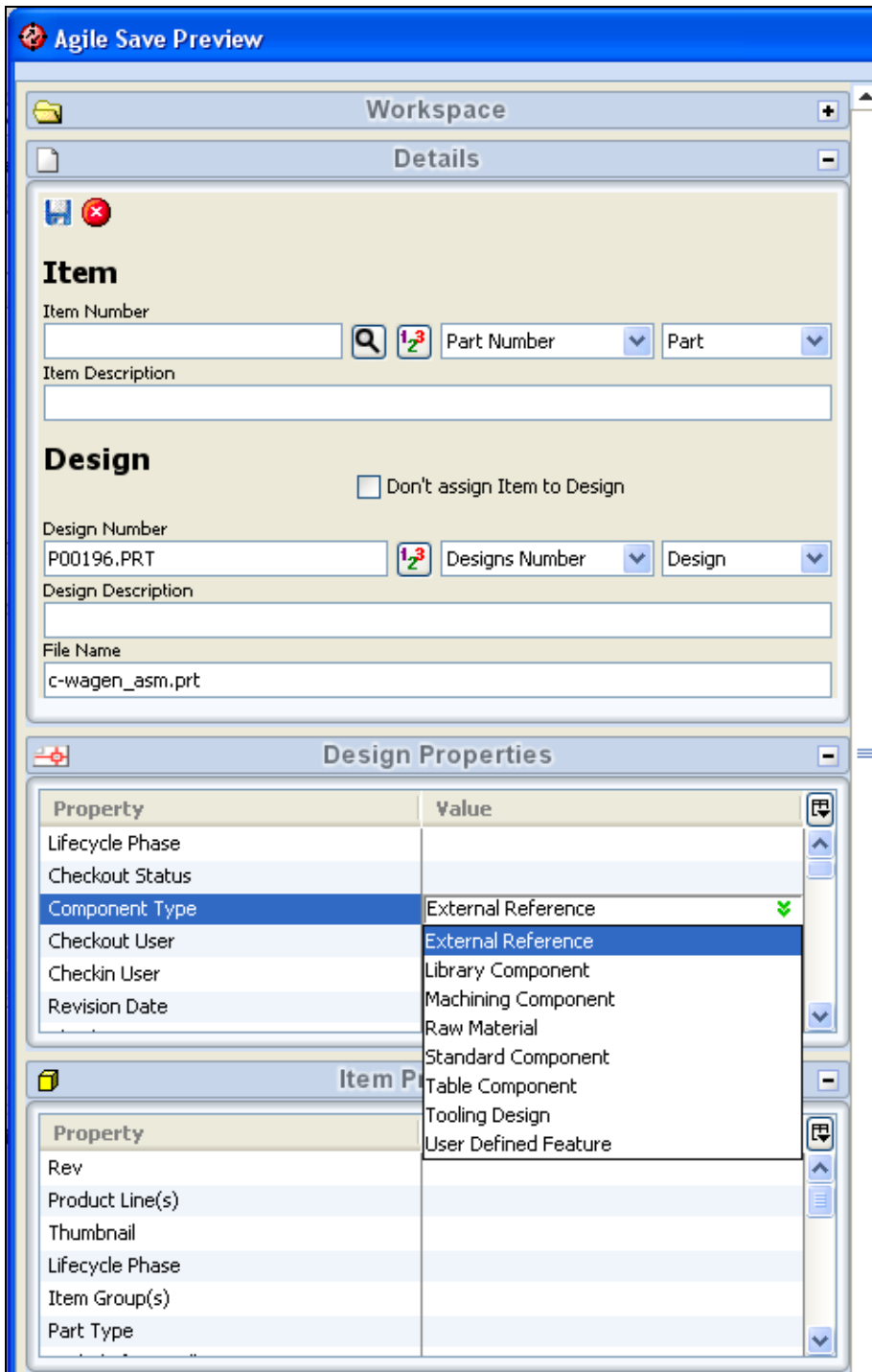

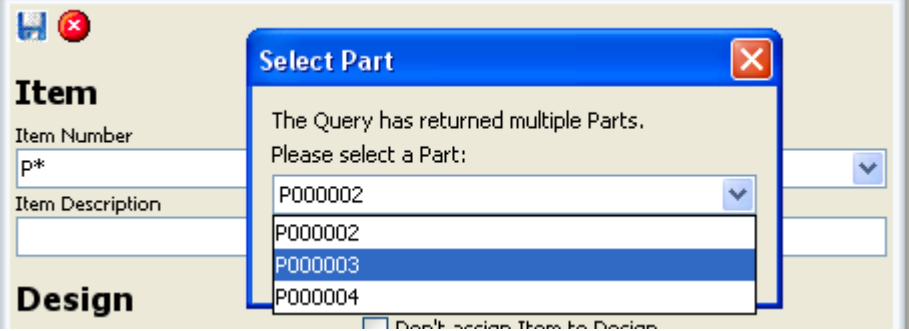




Figure 8: Agile Save Preview: Item Options

**Table 6: Details of the Interactive Save Dialog**

<p><b>Item Number</b></p>	<p>The Item Number is assigned to the Part. If no Design number is set, this value is also written to the Design Number field with the CAD file extension appended.</p>
<p><b>Item Description</b></p>	<p>The description of the Part item assigned to the Design.</p>
<p><b>Item Search</b> </p>	<p>This button executes a Part Search in PLM using the values entered in the Item Number and Item Description field. If there is one match, the found number is written into the Part Number field. If more than one match is found, a dialog pops up and the user can select the desired part from the list of found parts. This is used to assign the Design to an existing Part.</p> 
<p><b>Item AutoNumber Button</b> </p>	<p>If you click this button, it puts the next available auto number from the selected Part sub-class and Part auto number into the Item Number field.</p>
<p><b>Part sub-class</b></p>	<p>Selector which allows you to pick the Part sub-class to be used for saving this particular CAD file into Agile. This is for overriding the default value set in the main Preferences dialog.</p>
<p><b>Part AutoNumber</b></p>	<p>Selector for the Part auto number to be used for saving this particular CAD file into Agile. This is for overriding the default value set in the main Preferences dialog.</p>
<p><b>Design Number</b></p>	<p>The value that becomes the number assigned to the Agile Design that is being created.</p>
<p><b>Design Description</b></p>	<p>The value that becomes the description assigned to the Agile Design that is being created.</p>
<p><b>File Name</b></p>	<p>The CAD file name that is being saved into Agile.</p>
<p><b>Design AutoNumber button</b> </p>	<p>If you click this button, it puts the next available auto number from the selected Design sub-class and Design auto number, into the Design Number field.</p>

<b>Design sub-class</b>	Selector which allows you to pick the Design sub-class to be use for saving this particular CAD file into Agile. This overrides the default value set in the main Save dialog.
<b>Design AutoNumber</b>	Selector for the auto number to use for saving this particular CAD file into Agile. This overrides the default value set in the main Save dialog.
<b>Property / Value area</b>	This area displays, and allows editing, for other properties that are being set from CAD into Agile. Values may be pre-populated based on the settings in the Save Preferences dialog.

---

**Note** Your site most likely has pre-defined mappings for Number, Description, and other properties. You should check with your administrator to understand the allowable values to use. Also, these properties can be set as *Required*, meaning that you must enter a value before exiting the dialog.

---

## Checking In Design Structures

When saving CAD structures to Agile (e. g. drawings or assemblies containing at least one level of child elements), make sure take the dependencies of the CAD files, that are defined by internal file references, into account. The MCAD connector takes care of pointing out the existing references and dependencies and pre-selects dependent objects for saving when opening the Save Preview window. However, since users have the capability to explicitly specify, which CAD objects should be saved to Agile and which should not, it is possible to save incomplete structures. Thus, upon loading, some CAD objects might be displayed as missing or suppressed by the CAD system.

To prevent saving incomplete structures to Agile, users should make sure, that a referencing CAD object (means, a CAD object containing a structure) displayed as locally modified by the MCAD connector is always saved to Agile alongside all of its child objects which are displayed as either new or locally modified by the MCAD connector. Users should not reset the save option of the child objects in this case, since this would cause a referenced CAD object from now being saved to Agile.

## Multi-Select and Context Menus

Since you often have many items listed in the Save dialog, it is convenient to be able to set options for multiple items at a time. This is made possible by multi-select and context menus. The context menus are available in the browser view and in the list table as well.

The browser view provides functionality to select dependent assembly trees or parents beside the common multi-select functionality. The *Assembly* sub menu executes the operations for all children of a selected node recursively. The *Parents* sub menu executes the operations for all parents of the selected node recursively.

To multi-select, simply click within any item in the browser or list view, and either hold down on the left mouse button and drag the cursor, or use Shift-click or Control-click. Once you have selected the desired items, you can use the context menu (right mouse button) to execute any of the commands listed in the following table.

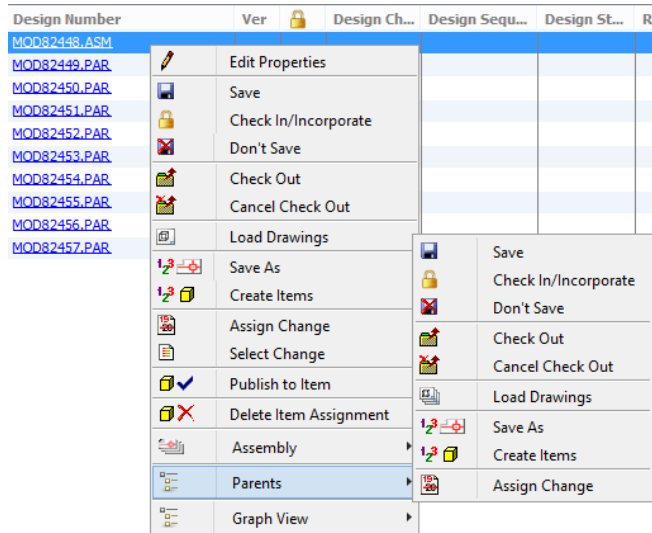


Figure 9: Save Dialog - Context Menu

Table 7: Save Dialog - Context Menu

Command	Description
<b>Edit Properties</b>	Edit Metadata of multiple selected objects in the sidebar. Multiple values are displayed as “***”. If all selected objects have the same value, the value is displayed. If the user wants to keep the values with no changes to the selected objects, the “***” can be used as a value in multiedit mode.
<b>Save</b>	Sets all selected objects to be saved, checked in, and checked out again.
<b>Check In/Incorporate</b>	Sets all selected objects to be saved and checked in.
<b>Don't Save</b>	Sets all selected objects NOT to be saved.
<b>Check Out</b>	Sets checkout reservation for currently selected objects.
<b>Cancel Check Out</b>	Cancels checkout reservation for currently selected objects.

<p><b>Save As</b></p>	<p>According to the preferences settings for creation of designs and parts there are two options:</p> <ol style="list-style-type: none"> <li>1. The <i>Save As</i> preference is set to <i>Part and Design</i>: The default AutoNumber source is used to assign new numbers to the selected designs. The system creates a design of the default Design subclass using this number plus the file extension. Additionally the system creates and links a Part of the default Part subclass with a new number, if the Part Assignment preference is set to <i>Create and Link</i>. If the Item and Design numbering is set up to be equal, then the Design number equals the Part number, plus the file extension.</li> <li>2. The <i>Save As</i> preference is set to <i>Design only</i>: In this case, the default Design AutoNumber source is used to assign new numbers to the selected designs. The default Design subclass is used. The system does not create or link Parts.</li> </ol> <p>Related Drawings or Manufacturing objects get their number from the underlying 3D model in the case that there is only one model directly referenced. If there is no 1:1 relationship, a Design AutoNumber is used.</p>
<p><b>Create Parts</b></p>	<p>The system uses the default Part AutoNumber to assign Parts to Designs which are not already linked to any Part. The system does not assign Parts to Drawings, Helper Parts or Manufacturing objects. Only the 3D model is linked to a Part.</p>
<p><b>Assign Change</b></p>	<p>Opens a dialog window allowing users to assign Item or Design Changes (e. g. ECOs, DFCOs) to the currently selected Design or Item object.</p>
<p><b>Select Change</b></p>	<p>If a Part with a Change is assigned to the selected Design, the Change Number is written into the Current Change field in the toolbar at the top of the list. This is to allow this same Change to be used for additional objects, using the Assign Change function above.</p>
<p><b>Publish to Item</b></p>	<p>Publish the latest checked in Design content and structure to the assigned Item.</p>
<p><b>Delete Item Assignment</b></p>	<p>Remove the relationship to the Item in PLM.</p>
<p><b>Assembly Sub Menu</b></p>	<p>Executes all contained actions for all children of the selected nodes.</p>
<p><b>Parents Sub Menu</b></p>	<p>Executes all contained actions for all parents of the selected nodes.</p>
<p><b>Graph View submenu</b></p>	<p>Performs different ways to show the selected objects and their children in the Workspace window.</p>

## Numbering Options

There are several numbering options that depend on the preference settings explained in the following chapters. Possible options for numbering of the filename, the Design number and the Part numbers are:

**Table 8: Numbering Options**

Filename	Design Number	Part Number	Creation Sequence
Don't Rename	Filename	Part AutoNumber	Design and Part together
Rename	Design AutoNumber +Ext	CAD Property	Design only
	Part Number + Ext	Existing (select)	
	CAD Property + Ext		
	Drawing Logic (get Model Number)		
	Helper Part Logic (get always a Design number)		

The valid combinations according to the preference settings and CAD Model types are:

**Table 9: Numbering Options: valid combinations**

CAD Type	Filename	Design Number	Part Number	CreationSequence
Model	Don't Rename	Filename	(any)	(any)
Model	(any)	Part Number + Ext	(any)	Drawing and Part together
Model	(any)	Design AutoNumber + Ext	(any)	(any)
Model	(any)	CAD Property + Ext	(any)	(any)
Drawing	(any)	Drawing logic	NONE	--
HELPERPART	(any)	Helper Part logic	NONE	--
Format	(any)	Helper Part logic	NONE	--
Manufacturing	(any)	Helper Part logic	NONE	--
Part Family	(any)	Helper Part logic	NONE	--

For Formats and Helperparts, the system does not create any Part. Only a Design AutoNumber is used regardless of the *SaveAs* preference setting.

### Accessing Agile Object via Links

Design, Item and Change objects in Agile can also be accessed directly from the MCAD dialogs. Instead of having to select a Design, Item or Change object and then open the corresponding web client page using a menu Item, some MCAD dialogs now provide direct links for accessing an Agile object. Selecting an object prior to accessing the web client is not necessary, in this case.

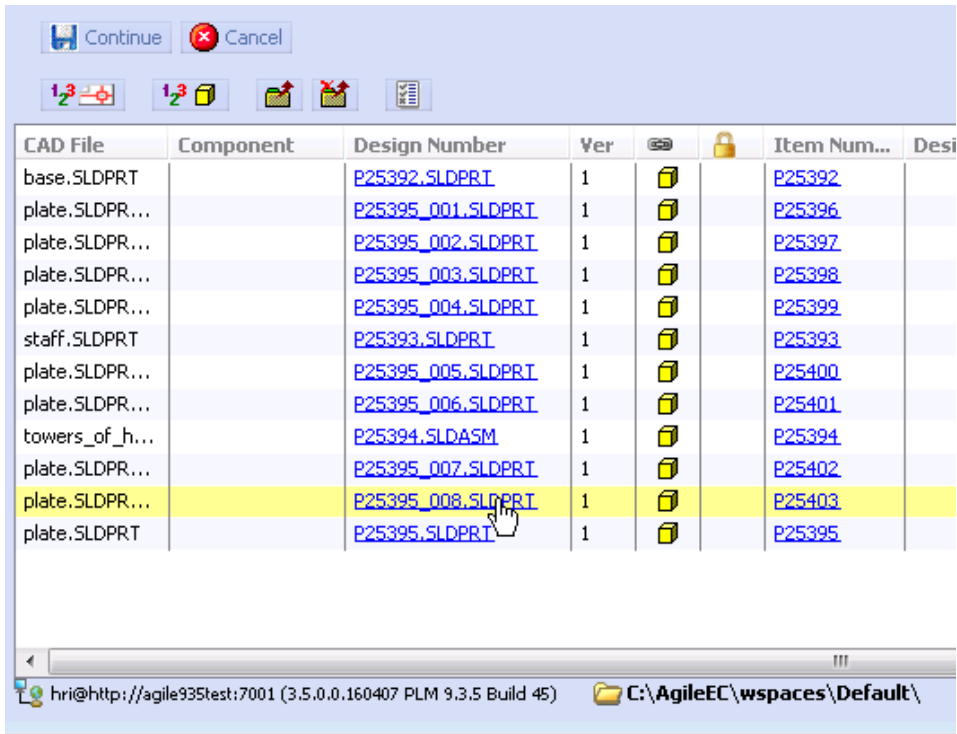


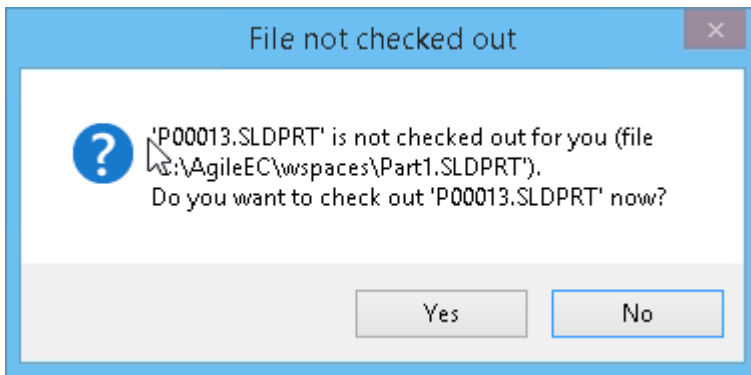
Figure 6: Save Preview Dialog with Links to Design and Item Objects

## Strict CAD Modification Workflow (ACW and ACE only)

Administrators may opt to activate the strict CAD modification workflow for the ACW or ACE integration (refer to Administration Guide, *Strict CAD Modification Workflow (ACW and ACE only)* chapter).

If activated, users are only allowed to modify Agile managed CAD objects if they hold the check out of that object in Agile. If not, the MCAD connector implicitly switches to the CAD systems read-only mode, preventing users from using modification features and/or preventing saving to the file altogether.

Should an error popup like the following appear when loading an Agile managed CAD object or when attempting to modify it, verify that you hold the check out. The popup dialog displayed allows to directly check out the object in question.



**Figure 7: Popup dialog of the ACW integration for non-checked out objects.**

# Preferences Dialog

The Preferences dialog is accessed from the CAD main menu or using the button in the Save or Load dialogs or by expanding the left sidebar and the contained preferences container, in addition it can be accessed from the Create Object dialog via expanding the preferences container.

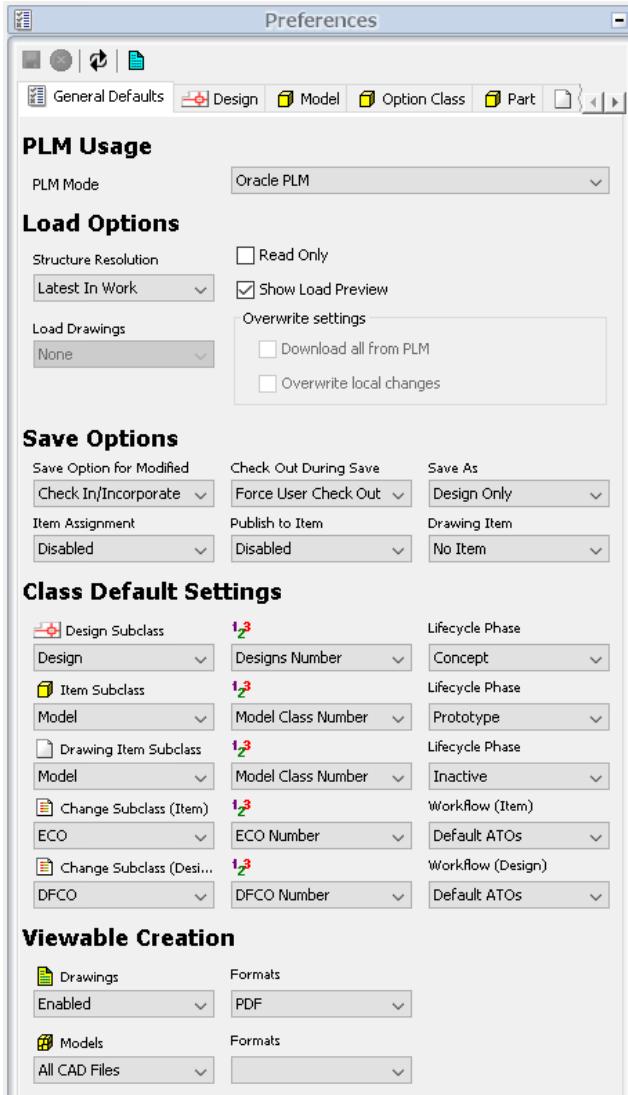


Figure 8: Preferences dialog

The *Load Options* define the behavior during load operations. The *Save Options* define the behavior during save operations. The *Class Default Settings* predefine the default subclasses and AutoNumbers to be used, if new Parts, Designs or Change Orders are created. However, if the Create Object dialog is used for object creation, the default settings concerning sub-classes and AutoNumbers is preferred over this one because the predefined sub-class of the template chosen

in that dialog. The Preferences dialog does not display inactive PLM sub-classes. The *Viewable Creation* defines the types of viewable files that are automatically created and attached in PLM along with the native file.

## PLM Usage (PLM Mode)

The PLM Mode drop-down list defines the mode of operation for the MCAD connector. Only MCAD administrators can see this option.

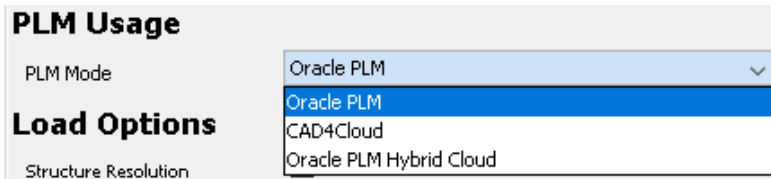


Figure 9: PLM Mode drop-down list

Table 10: Options available in the PLM Mode drop-down list

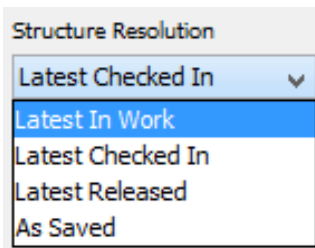
Oracle PLM	Normal connector behavior for Oracle Agile PLM.
CAD4Cloud	Alternative connector behavior when using Oracle PD Cloud. This mode of operation hides most Item related controls in the MCAD connector GUI and is intended to be used when using the MCAD connector to connect to PD Cloud via an Agile server. Item creation in PD Cloud is then taken over by Agile PLM.
Oracle PLM Hybrid Cloud	Works like Oracle PLM mode, but uses PD Cloud hyperlinks for the Item related controls of the MCAD connector's GUI instead of Agile PLM hyperlinks.

The MCAD connector needs to be restarted after changing the PLM Mode value.

The Fusion URL text field is used to define the URL that points to the PD Cloud service. The MCAD connector uses the URL given in this text field to navigate to Item objects stored in PD Cloud in *CAD4Cloud* and *Hybrid Cloud* modes.

## Load Preferences

The default structure resolution on load is configured using the *Structure Resolution on Load* preference. This defines which versions of children in design structures are used in an Assembly.



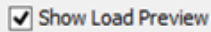
**Figure 10: Structure Resolution: available options**

**Table 11: The valid values and their meaning are:**

Latest in Work	Select the latest possible Design version of a component, including versions that are currently checked out by the current user.
Latest Checked In	Select the latest Checked In Design version of a component.
Latest Published	Select the latest Design version, which is a Part attachment.
As Saved	Select the Design version that was saved within the parent assembly.

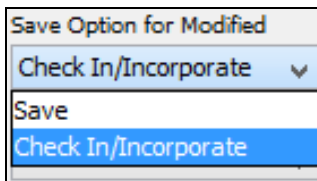
## Activating and Deactivating the Load Preview Dialog

Prior to this release, the Load Preview dialog was always displayed by MCAD when users initialized a load operation either from the MCAD connector itself or from the web client of Agile PLM. In release 3.5, the Load Preview dialog is switched off per default. Instead, the load process is initialized directly. Due to this, important option settings related to loading are now available in the Preferences dialog; refer chapter *Load Preferences* below. Users can opt to re-activate the Load Preview dialog using the *Show Load Preview* check box in the *Preferences* dialog.



**Figure 10: Show Load Preview Check Box**

## Save Preferences



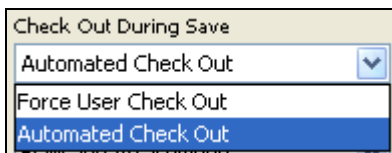
**Figure 11: Save Option for Modified: Available Default Save Options**

The default Save Option for modified files defines the preselected option in the save dialog. The valid options are:

**Table 12: Save Option for Modified: Available Default Save Options: Descriptions**

Save	The file is saved into the currently checked out Design version. Then the Design is checked in and then checked out again immediately. The Design remains checked out after save with an incremented version.
Check In/Incorporate	The file is saved into the currently checked out Design version and then the Design is checked in. If a pending Design Change is assigned, the <i>Incorporate</i> flag is implicitly set.

### Checkout during Save



**Figure 12: Checkout during Save: Available Options**

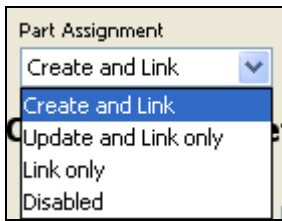
The checkout behaviour during save is controlled by this switch. The valid options are:

**Table 13: Checkout during Save: Available Options: Descriptions**

Force User Check Out	The user has to check out the Design in order to be able to save.
Automated Check Out	The Design is checked out automatically, when it is saved to PLM.

## Item and Publish Preferences

In order to achieve a transparent Part/Design creation and linking process, some defaults are required to control the simultaneous creation of Parts and Designs.

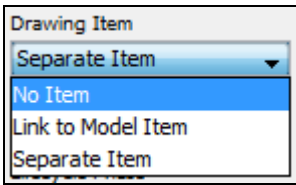


**Figure 13: Part Assignment Options**

The *Part Assignment* controls, whether or not Parts are created simultaneously. The options and their meanings are:

**Table 14: Part Assignment Options: Description**

Create and Link	This creates new Part objects, if a new Design is created. The Part is linked to the Design and the Part properties are also updated.
Update and Link only	This option does not create Parts. Existing Parts are linked to the Design and the Part properties are updated.
Link only	This option does not create or update Parts. Only the relationship link between the part and the design is created.
Disabled	Part assignment or creation is disabled completely.

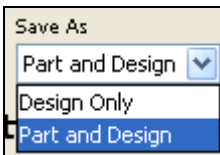


**Figure 14: Drawing Item Options**

The *Drawing Item* option controls whether or not an Item for a drawing is linked or created. The valid options and their meaning are:

**Table 15: Drawing Item Options: Description**

No Item	No Item is linked to the Drawing Design.
Link to Model Item	No Item is created for the Drawing Design but the Drawing Design is linked to the Model Item on the Relationships table in PLM.
Separate Item	An Item is created for the Drawing Design. The default class and AutoNumber are configured in the class configuration section for Drawing Items.



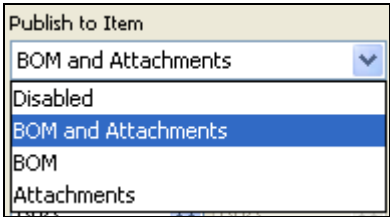
**Figure 15: Save As: Options**

The *Save As* option controls whether or not Parts are created during Save As of a CAD model. The valid options and their meanings are:

**Table 16: Save As: Options: Description**

Design Only	Design AutoNumber is used for new Design objects. No Part objects are created.
Part and Design	Part AutoNumber is used as the basis for new Design objects, with the CAD extension appended. Part objects are created if the Part Assignment option is set to "Create and Link". The Part objects get the

	same number as the Design objects.
--	------------------------------------



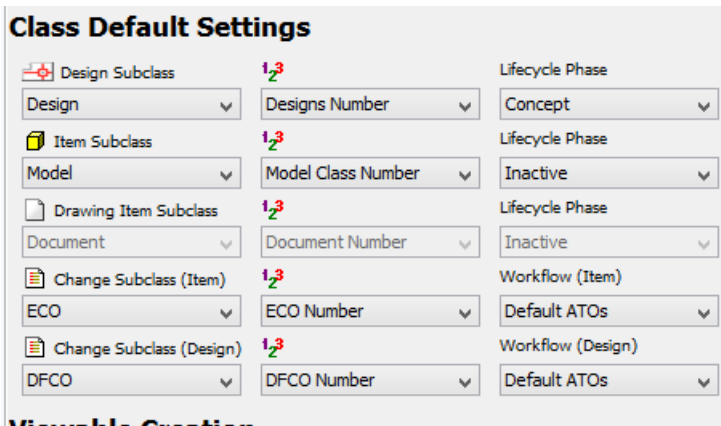
**Figure 116: Publish to Item: Options**

The *Publish to Item* option controls whether or not a Part BOM is created or updated, and the Design files are attached to the Part objects after the Design is checked in. The valid options and their meaning are:

**Table 17: Publish to Item: Options: Description**

Disabled	No Part BOM is updated and no attachments are updated.
BOM and Attachments	Part BOM is updated and the Design files are attached to the Parts.
BOM	Part BOM is updated. No Design files are attached.
Attachments	No Part BOM is updated. Design files are attached.

## Class Preferences



**Figure 17: Class Preferences**

This section defines the default sub-classes and default AutoNumber sources for all Parts, Designs and Change orders created by CAD integration. These settings are mainly used in save use cases. It is possible to customize the sub-classes and AutoNumber generators displayed in the Preferences dialog. Refer to the Administration Guide, chapter *Filtering Sub-Classes and AutoNumber Generators Displayed by the MCAD GUI*, for details.

## Viewable Creation Preferences

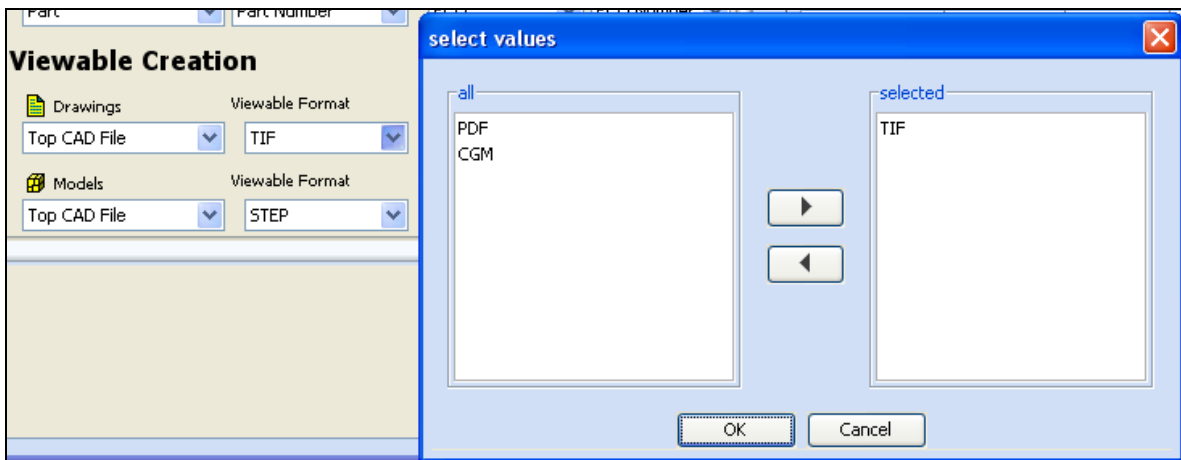


Figure 18: Viewable File Creation Preferences

## Viewable File Creation Preferences

The types of viewable files that are automatically created and attached in PLM along with the native file. This can be set independently for Drawings and Models (Parts and Assemblies), and can be set to generate the viewable files for all CAD files, only the top CAD file, or no CAD files. Also note that depending on the CAD system, additional configuration work may be necessary to automatically create the viewable files (please contact your administrator). The available Viewable Types are defined in the **CAXConfig.xml** in the viewables structure:

```

...
<Structure>
  <Name>Viewables</Name>
  <FieldCollection>
    <Field><Name>ViewablesDrawing</Name><Value>PDF;TIF;CGM</Value></Field>
    <Field><Name>ViewablesModel</Name><Value>CGR;WRL;STEP;IGES;3DXML;JT</Value></Field>
  </FieldCollection>
</Structure>
...

```

## Property Value Preferences

Each Design and Part class is represented in the preferences in order to configure the mapping of symbolic CAX properties to fields in PLM. The administrator can setup the mapping interactively. The preferences are saved into a MCAD-CONFIG FileFolder object in PLM if the current user is a member of the admin group. The values have to be set for each subclass independently. Additionally each field may get a value default mapping.

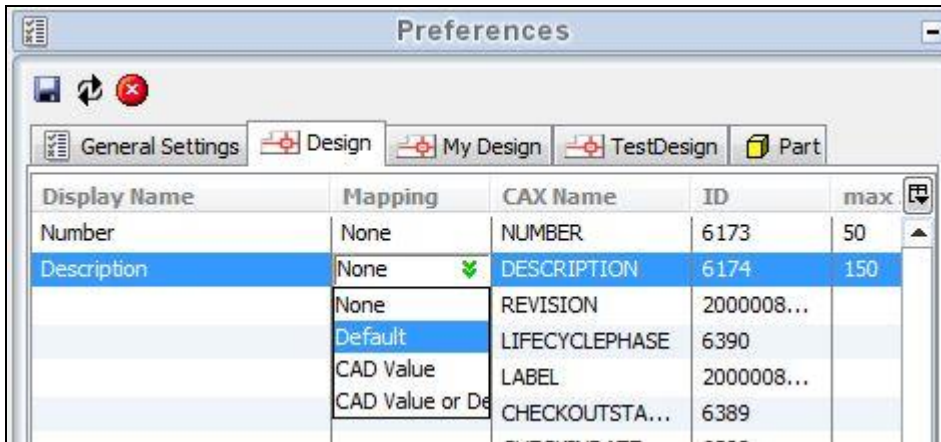


Figure 19: Property Mapping Preferences

**Property Value Preferences** – This section allows you to pre-define the properties that are mapped between CAD and PLM, as part of the save process. By setting these preferences appropriately, you can reduce the use of the interactive save dialog and speed up the save process. The four mapping options are:

Table 18: Property Mapping Preferences: Description

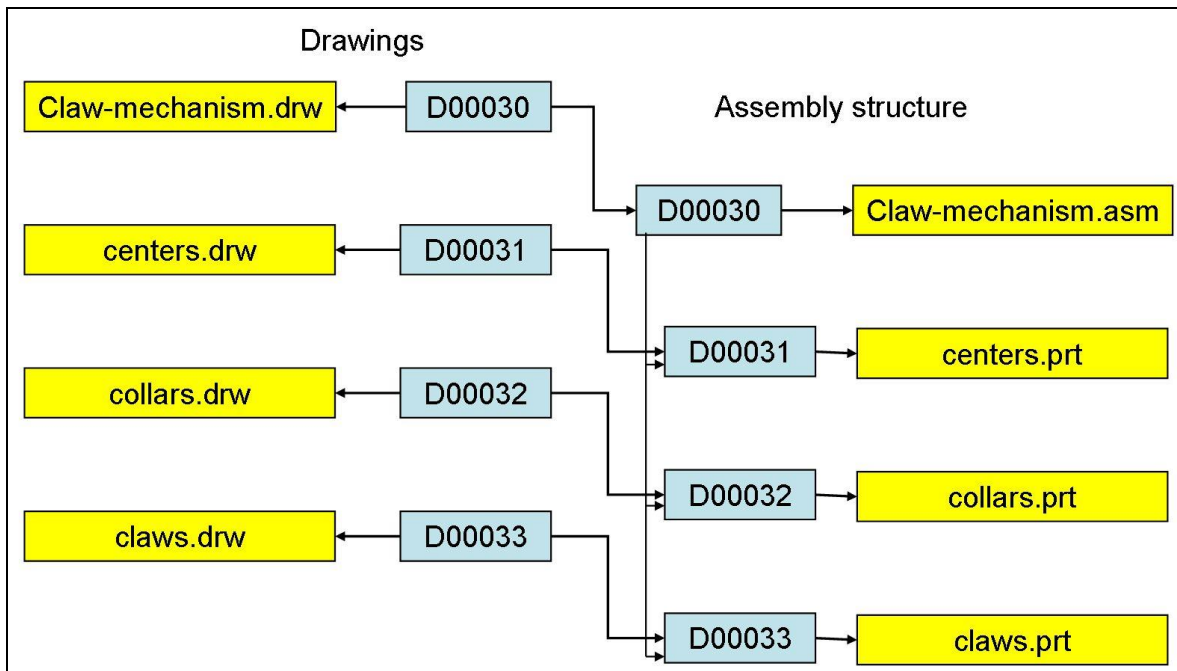
None	No value is to be set for this property.
Default	Use the value in the <i>Default</i> column.
CAD Value	Use the value defined in the CAD properties, based upon the mapping defined by your administrator.
CAD Value or Default	Use the value defined in the CAD properties, but if no value exists, then use the default value in the “Default” column.

## Design Structures

The MCAD integration’s save functions create Design structures in Agile to hold the CAD files. It is important to understand how these structures are set up in Agile. CAD designs consist mainly of three types of files – Parts, Assemblies, and Drawings. In terms of the design structure hierarchy, Parts are the lowest level. They are combined into parent Assemblies, which in turn are combined into higher-level Assemblies. Drawings are represented at a higher level than either Parts or Assemblies; essentially a Drawing is a *parent* of whatever Assembly or Part that is on the Drawing.

The figure below illustrates a case of a Creo Parametric five-part assembly, where each of the parts, and also the assembly, has corresponding drawings. The assembly (D00007) is the parent of all the parts, and each drawing is the parent of its respective assembly or part. It is important to keep this structure in mind when using EC operations like Save and Load, and also when browsing through design structure data in Agile.

For example, since the *Save* and *Load* commands work on a single structure at a time, you can save drawing D00008 and it saves assembly D00007 and the five parts, but not the five-part drawings (because they are not in the same tree structure – you would not see them within the BOM tab of D00008 in Agile). For this situation you can use the *Save Session* command, which includes all files active in the CAD session within the Save dialog.



**Figure 120: Design Structure Hierarchy**

Similar types of structures are used to store other specialty types of CAD files, such as Pro/E family

table generics and drawing format files. In each case, the connector is set up to recognize the files as being stored in these particular types of structures, so they must not be manually modified in Agile or errors may result.

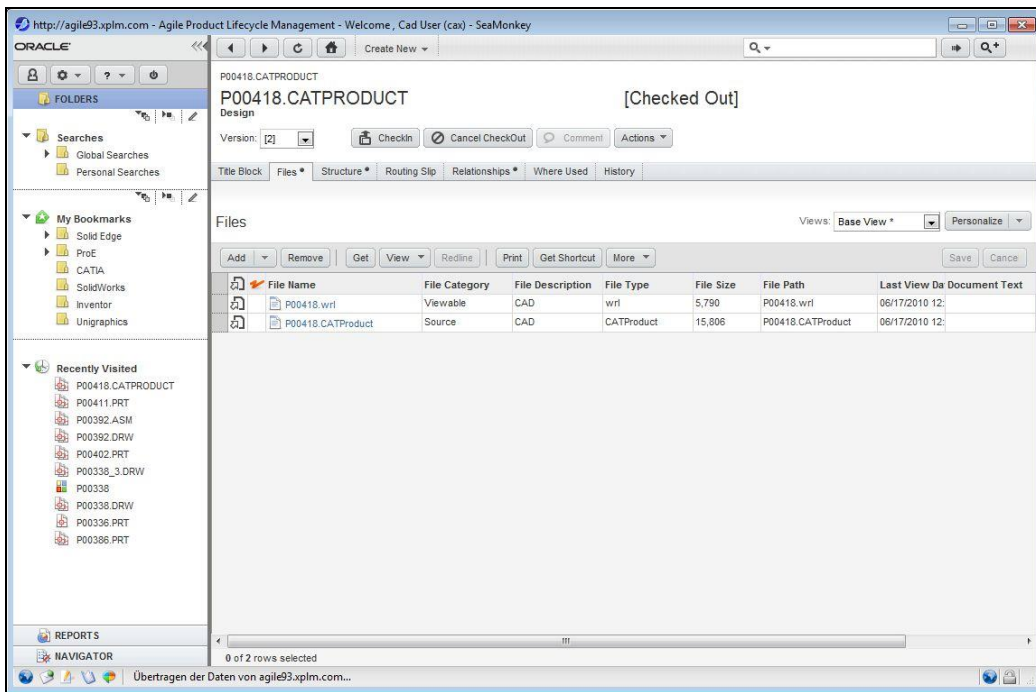
## Recursive Structures

Some CAD systems allow users to create recursive, means self- or circular referencing, assembly structures. Such structures can be saved to Agile PLM via the MCAD connector, since circular references are fully supported by the structure relationships table (*Structure* tab). Previous releases of the MCAD connector used the *Relationships* tab to store (potentially) recursive Design-Design relationships. Since MCAD 3.4 and Agile PLM 9.3.4 such references are saved in the *Structure* tab alongside any other Design-Design relationship.

## Saving with Derived Files

By configuring the *Save Preferences* dialog (see page [29](#)) you can set the system to save additional derived or viewable files, such as PDF or IGES, in combination with the regular save operation. The reason these operations are combined is to make sure that both the additional file and the native file(s) are in synch with each other. The additional files are attached to the same Agile Design object as the native CAD file. The available file format options within the *Save Preferences* menu are customizable for your site; your administrator configures this as appropriate.

The figure *Derived File Saved into Agile* shows an example of the results of using this function to generate a WRL file in addition to the native CATIA CAD file.



**Figure 131: Derived File Saved into Agile**

**Note** In addition to this function with the Agile menu, it is also possible to manually attach files to Agile Designs using the *Add* button on the Design’s form in the Agile Web Client.

## Supported Viewable File Formats

Each CAD system supports a limited number of **viewable file formats** that can be exported from the native CAD files. The following list contains the drawing and 3D model viewable file formats that can be exported out-of-the-box via the MCAD connectors for a particular CAD system, without needing additional software or licensing.

CAD System	Supported 2D Viewables	Supported 3D Viewables
CATIA V5	PDF	-
Creo Parametric, Creo elements/pro	PDF	STEP, X_T
Solid Edge	PDF	STEP, JT
SolidWorks	PDF	STP, X_T, IGS
AutoCAD	PDF	-
Inventor	PDF	STEP
NX	PDF	STEP, JT

## Save with drawings

In CAD use this function to perform an EC Save on the parent drawing. This is similar to as if the user opens the parent drawing in CAD and then performs an EC save. This might be the case, if the user is not working on the drawing but on the child CAD object, where each save must be performed on the drawing. This prevents overhead.

---

**Note** This function does not work, if the 1st level parent is not a drawing. References for drawings containing part family instances are only displayed correctly for the Solid Edge integration. Other MCAD integrations might display relationships from the drawing to each instance of the part family, regardless of whether such a relation indeed exists.

---

## Save Session Command

This command lists the entire contents of the current CAD session in the Save dialog, rather than just the components within the active model. This is useful especially when you have multiple drawings active in a session, because they can then be saved all at once.

## Save with Configurations

The “Save with configurations - *current*” save function displays the currently open file including all other part family instances which belong to the part family of this file within the Save Preview. If the currently open file is not an instance of a part family, this save function behaves as the normal Save Preview save function.

The option “Save with configurations - *all*” displays all part family instances of any part family within the current CAD file’s structure. Even non-lined part family instances are displayed in the Save Preview window.

## Saving Commands Summary

**Table 19: Saving Commands Summary**

	save CAD file	PREVIEW	Create Viewables	Check In	Publish
Save Preview	YES	YES	as set in pref	as set in pref	as set in pref
Save with defaults	YES	NO	as set in pref	as set in pref	as set in pref
Save with configurations	YES	YES	as set in pref	as set in pref	as set in pref
Quicksave	YES	NO	NO	NO	NO
Checkin/Incorporate	YES	NO	as set in pref	Always	as set in pref
Save	YES	NO	as set in pref	Always	as set in pref

## Feature Tree Context Menu Items

For some CAD systems, the MCAD connector provides context menu items in the CAD system's feature tree. Refer to **Fehler! Verweisquelle konnte nicht gefunden werden.** for illustration.

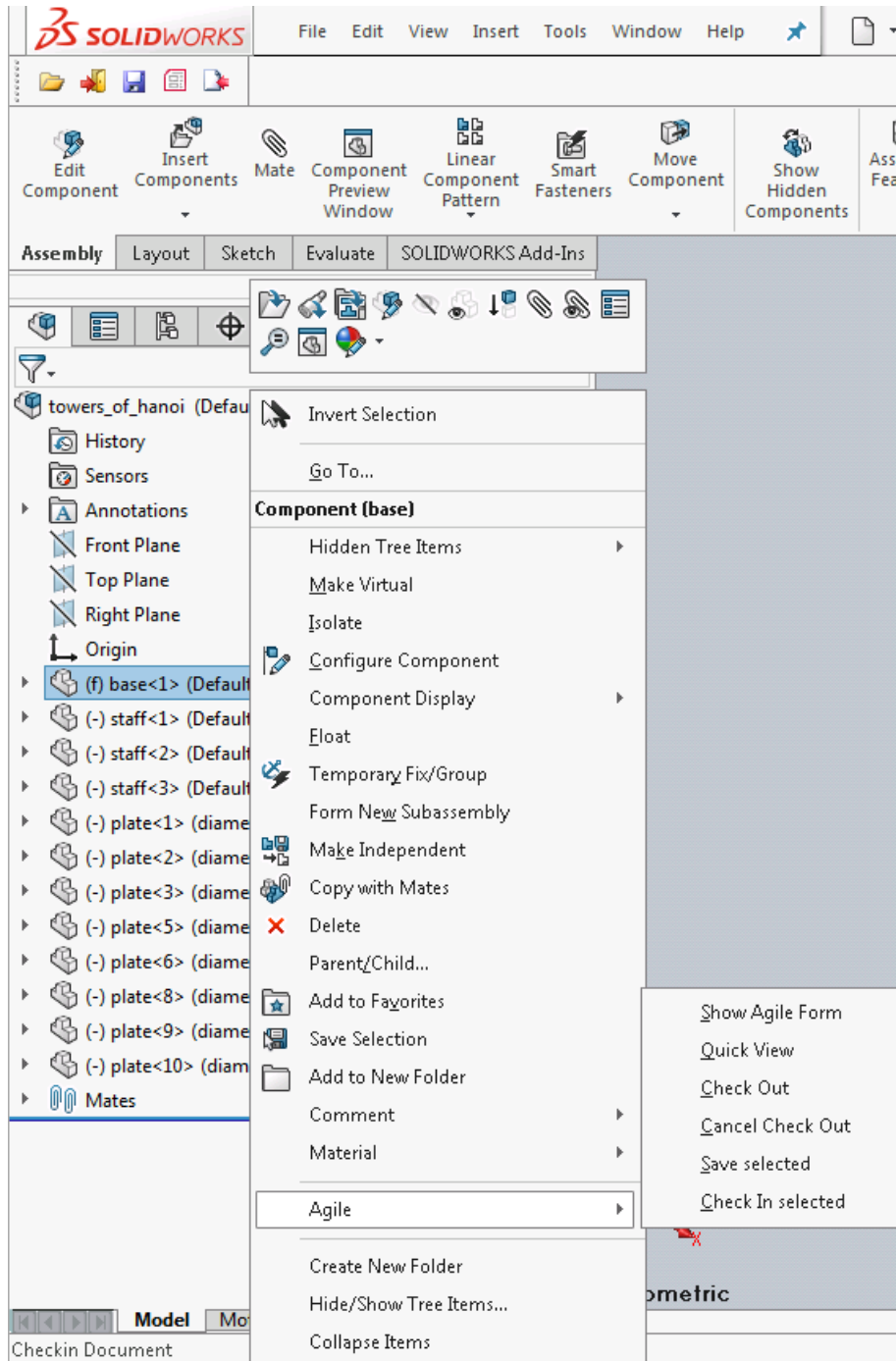
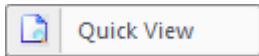


Figure 22: Context menu of the SolidWorks feature tree showing PLM-related menu items

## Quick View

The Quick View function provides the most important PLM-related information of a PLM-known CAD object in a popup dialog. Using the Quick View function it is possible to retrieve PLM-related information without needing to open Agile's web client.

The Quick View menu item is available for all MCAD connectors in the CAD system's feature tree (see Figure ).



**Figure 23: Quick View menu item in the feature tree context menu of Solid Edge.**

For the MCAD connector for Solid Edge, the Quick View menu item is also available in the main ribbon bar.

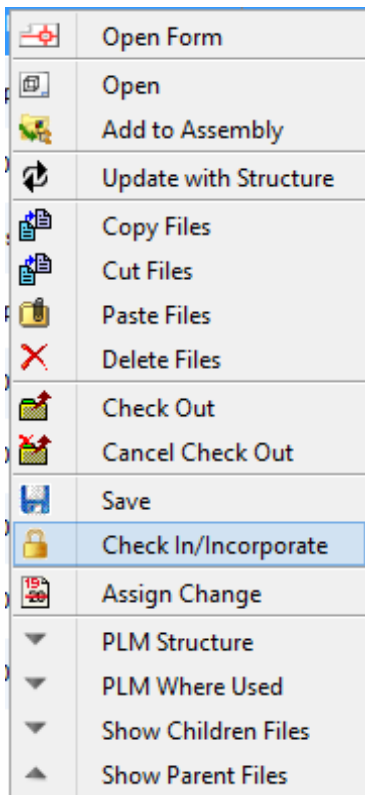
## “Check In/Incorporate”, “Check out” and “Cancel Checkout”

The menu item *Check In/Incorporate* provides a basic save functionality that transfers a single file, selected by the user, to Agile. The menu item is available in the context menu of the CAD system's feature tree (Creo Parametric and SolidWorks only, refer to **Fehler! Verweisquelle konnte nicht gefunden werden.**) or the *Agile* menu within the CAD system's main menu bar and in the context menu of the Workspace Manager (*Workspace* tab, refer to Figure 14).

The *Check In/ Incorporate* command saves the file being selected when execution the command to Agile. In comparison to the *Save* and *Save...* functions, the structure resolution is performed only one level deep when using *Check In/Incorporate*, the *Save Preview* window does not appear and a check in of the Agile Design object, to which the selected CAD file was transferred, is performed (so a new revision is created). The save options *Save* and *Increment*, available during normal save processes in the *Save Preview* window, are not supported by the *Check In/ Incorporate* functionality. In addition, only PLM-known CAD files can be saved to Agile using this functionality. The *Check In/Incorporate* function cannot be executed on files that have never been saved to Agile before.

This *Check In/Incorporate* command can be used to transfer and commit single files to Agile. For instance, if only a drawing has been changed which is part of a large assembly or if only selected nodes of a large assembly should be saved to Agile this functionality can be used to transfer just the modified files selected by the user.

If conflicts occur during a save process initialized using the *Check In/Incorporate* command (e. g. lack of privileges), the integration opens the *Save Preview* window allowing the user to manually resolve the conflicts.



**Figure 144: Context menu of the Workspace Manager showing the *Check In/Incorporate* command**

The “Check In/Incorporate” command does not open the Save Preview and performs the PLM update with the default preferences. The Save Option is always set to “Check In/Incorporate”. It saves the selected files if there is no privilege conflict in PLM. In case there are conflicts a Save Wizard is displayed to solve the conflicts by Ignore or Check Out single files and proceed or Cancel completely.

It is possible to reconfigure the *Check In/Incorporate* command to display the Save Preview window if executed. To do so, the *ShowBrowserOnCheckin* option setting contained within the *CAXConfig.xml* configuration file needs to be adjusted accordingly (refer to the *Administration Guide* for details). If the *Check In/Incorporate* command is configured to display the Save Preview window, the user is not able to select additional files for saving. The files related to the file selected for saving are greyed out while the files selected for check in/*Incorporate* are highlighted for saving (as shown in Figure 15).

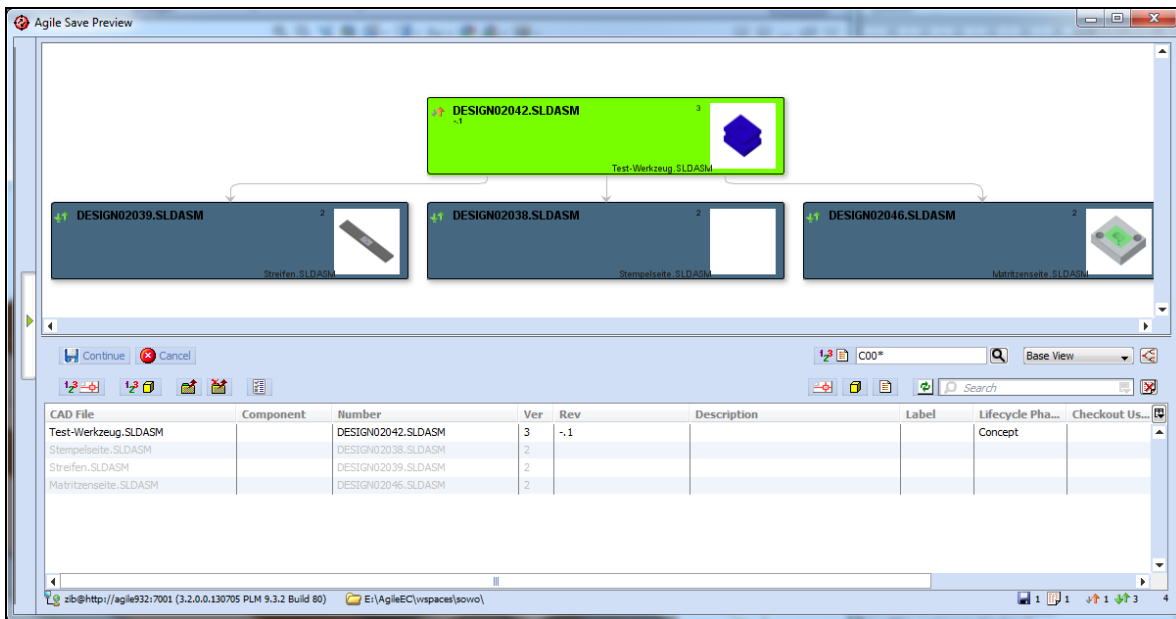


Figure 155: Example of the Save Preview window when opened by the Check In/Incorporate command

## Status Information

Status information is displayed at the bottom of the dialogs. Beside the current login and server connection, the current workspace and status information is shown.

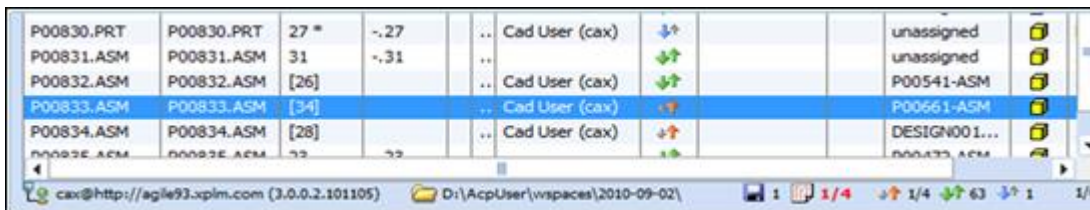
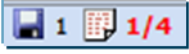

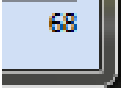


Figure 166: Status Information

Depending on the statuses and the user selection the status indicator shows the numbers of selected items for save or load. It also shows the number of resolved conflicts per status, highlighted in red bold numbers.

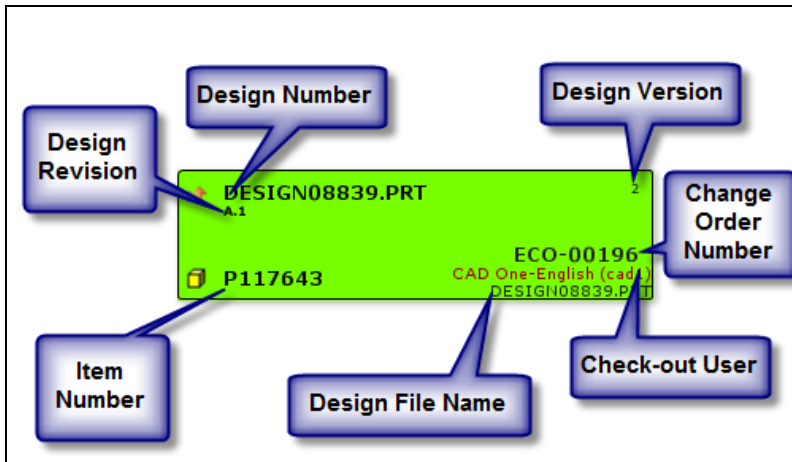
The status indicator is separated into 3 sections. From left to right:

**Table 20: Status Indicator**

<p><b>Main Section</b></p> 	<p>Shows how many files are selected for saving or loading and how many files are modified locally in summary. If the modified file shows up in red bold numbers, not all modified files are selected for saving. The sample shows that one out of 4 modified files is selected for saving.</p>
<p><b>Details Section</b></p> 	<p>Shows how many files of each status are contained in the list. If the numbers beside the icon show in red bold text, not all modified files of this status type are selected for saving.</p>
<p><b>Summary Section</b></p> 	<p>Shows the total object count in the list.</p>

## Information Displayed by Structure Browser Nodes

The node boxes in the browser view are rendered using an xhtml template and css stylesheet. By default the following information is shown inside the boxes.



**Figure 27: Structure Browser Nodes**

The background color of the boxes visualizes the status of the displayed files; an explanation of the colors is given in the following table:

**Table 21: Node Boxes Background Colors**

<b>Green</b>	The file is selected for saving meaning the Save Option column is not empty. This color displays in Save Preview window and the CAD Tab of the Workspace Manager. Note that there is no Save Option column in the Workspace Manager, the color Green only shows a correspondence with the Save Preview window (If this were open). The color also shows in the Load Preview window when the latest version is modified locally but Load option is set to “Keep local file”.
<b>Yellow</b>	The file is PLM unknown and the Save Option column is empty. This color displays only in the Save Preview window.
<b>Light Grey</b>	The PLM information has not been retrieved (LazyLoad) and the file is not modified locally or in PLM. This color displays in the Save Preview window and CAD Tab of the Workspace Manager. Selecting the file will change the color to reflect the synchronization status of the file, e. g. to dark grey or dark blue.

<b>Dark Grey</b>	The file is the same locally and in PLM. No save option is selected. This color displays in the Save Preview window, Load Preview window and CAD Tab of the Workspace Manager.
<b>Orange</b>	The latest version is modified locally. This color displays in the save Preview window when Save Option column is empty and in the Load Preview when Load Option is set to either "Open in CAD" or "Download file"; indicates a Load conflict in this case.
<b>Red</b>	A newer version is available in PLM, but the file is modified locally. This color displays in the Save Preview window and the CAD Tab of the Workspace manager. No save Option is selected.
<b>Dark Blue</b>	A newer version is available in PLM. This color displays in the Load Preview window, Save preview window and the CAD Tab of the workspace Manager. No Save Option selected.
<b>Light Blue</b>	The file is a "PLM where used" query result. This color only displays in the Load Preview and the CAD Tab of the Workspace Manager.

If thumbnail generation is enabled, a small thumbnail is shown for each CAD file displayed in the structure browser and a larger thumbnail flyout image is displayed if the user holds the mouse over a node or over the *file name* column in the Save Preview window (as shown in Figure). The flyout is enabled by default and can be disabled optionally (refer to the *Administration Guide* for details).

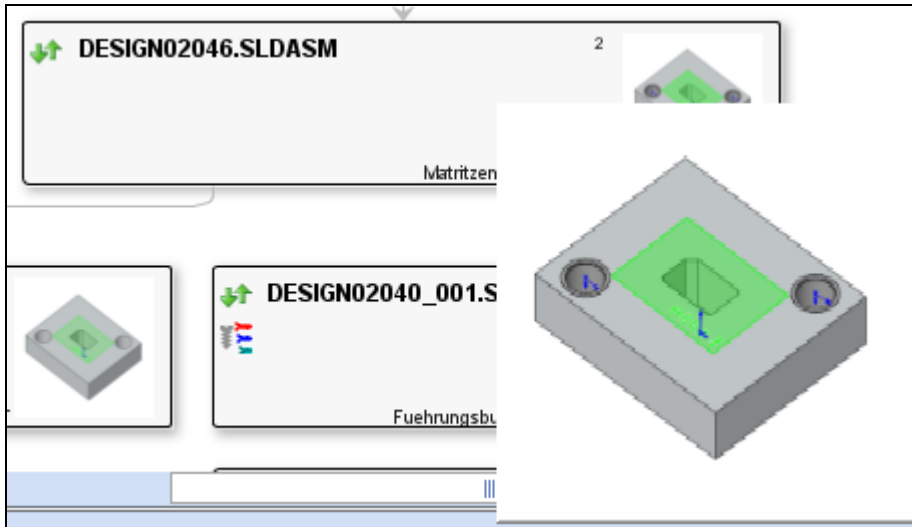
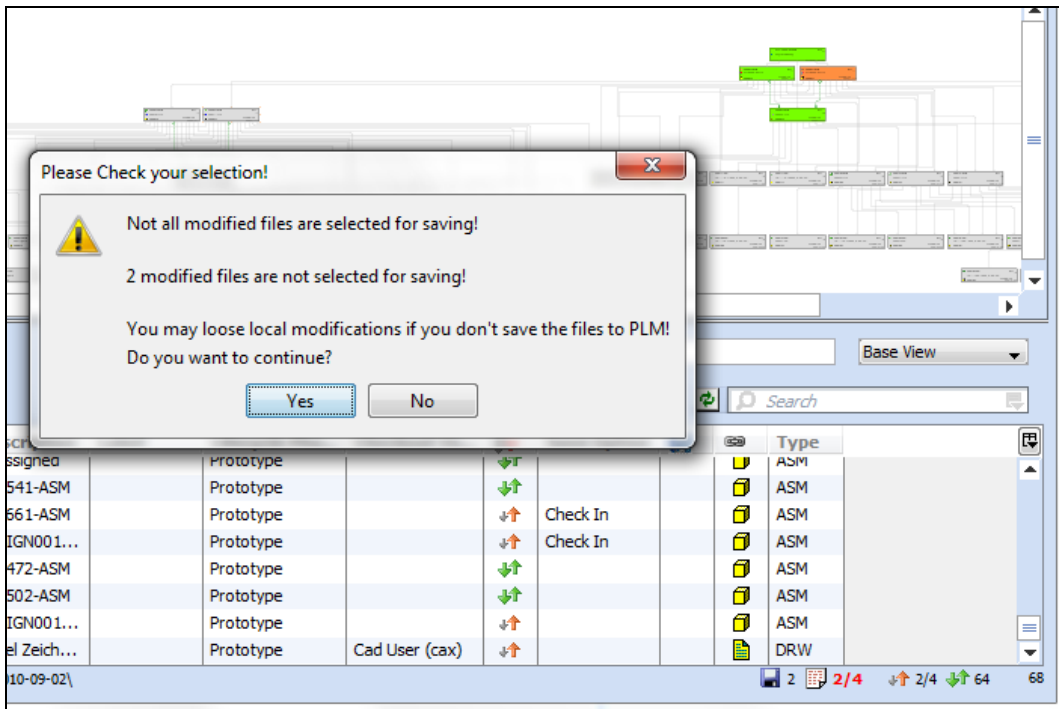


Figure 28: Thumbnail flyout

## Guided User Input

Corresponding to the status information additional checks being executed when the user hits the *Save* button in the *Save Preview*. If the user has no modified parts or not all local modified parts selected for saving, a message box is displayed to warn the user. The user can verify the selection again.



**Figure 2917: Save Preview: Saving: Warning Message**

There are four possible cases for a message box as shown below:

- Nothing is selected for save – The user must mark something for *Save* or *Check In/incorporate* in the save option column.
- Local modified file is not selected for save ( ↓↑ )
- Local modified file with a PLM conflict is not selected for save ( ⚡ ) – The user has to decide which objects shall be saved and which objects should not be overwritten in PLM.
- A file with unknown status is not selected for save ( ↓↑? ) – This can come up if CAD mapping defines the Design number (e.g. legacy data) and there is no local cache record available that can detect whether the file is actually in PLM or not. The user has to decide which objects shall be saved and which objects should not be overwritten in PLM.

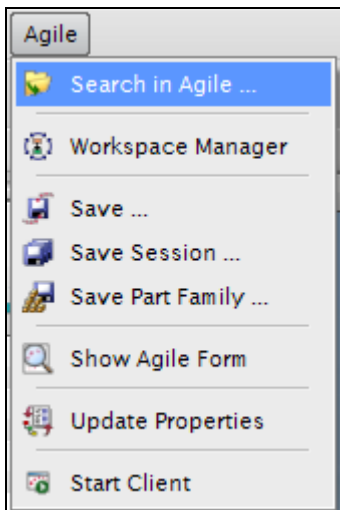
## File Sync Status Mismatch

For the ACP connector, it might happen, that the file sync status in the Workspace Manager and the Save Preview is not equal. For details, refer to chapter *File Sync Status Mismatch (Creo Connector Only)*.

# Loading from Agile

## Introduction

The loading process from Agile into CAD is executed using the Agile Web Client. The *Agile → Search in Agile...* command can be used to launch the Web Client's search functionality:



**Figure 30: Agile: Search in Agile...**

If the CAD system is running, however, the load function **does not need to be** initiated from the Agile menu in CAD. You can simply search within the Web Client to find the desired Design, and then use the *Load to CAD* function to send the design to CAD.

The load procedures retrieve previously saved CAD files in order to perform CAD work. Once the desired model is located and selected, the necessary files are extracted from Agile and placed in the designated workspace directory. The files extracted depend on the type of model selected, as follows:

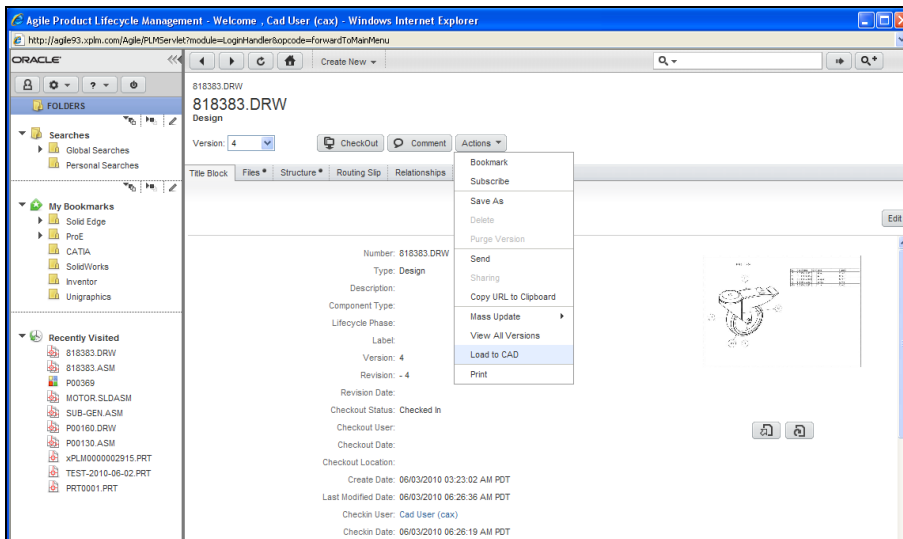
- **Part** – If a single part is selected, just that single Part file is loaded to the workspace directory.
- **Assembly** – If an assembly is selected, its file and all subordinate files (sub-assemblies and parts) necessary to build the assembly are extracted.

- **Drawing** – If a drawing is selected to load, its file and all subordinate files necessary to build the drawing (including all subordinate assemblies, sub-assemblies and parts) are extracted.

## Using the Load Command

To load *CAD* files from Agile into your CAD system, pick the *Load to CAD* command in the Web Client. The *Load to CAD* function is available in the following locations in the Web Client:

- In any search results that include Design objects, in the *More* menu
- From any Design object form, in the *Actions* menu
- From any Item Attachments tab, in the *More* menu



**Figure 181: Load to CAD Action**

This brings the EC Web Connector Load Preview forward, if configured, or directly initialized the load process.

## Load Dialog

The main purpose of this dialog is so that you can review which files and which versions of the files are being loaded. Additionally, you can see if anyone has any of the files checked out. Other possible operations are described below.

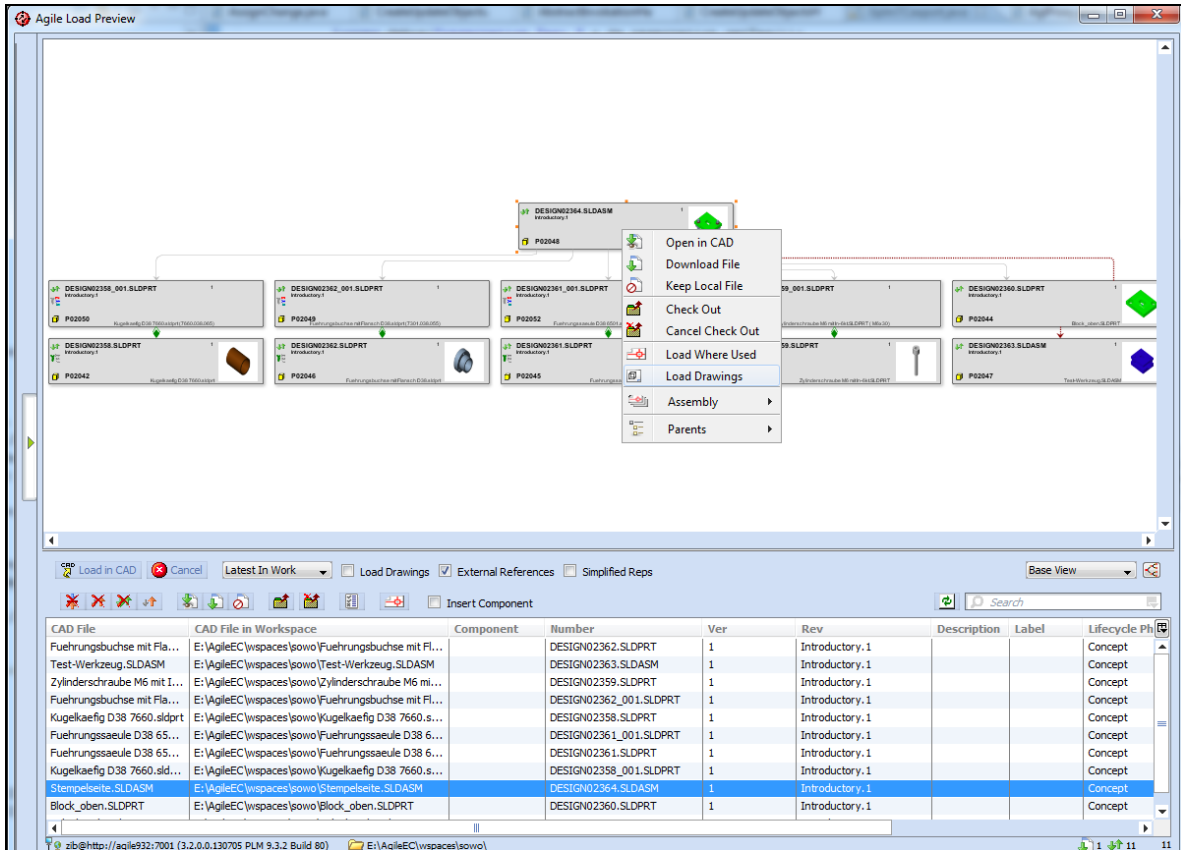
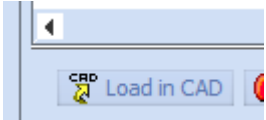
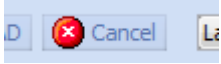
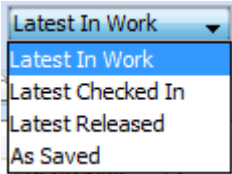
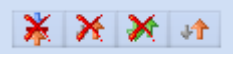














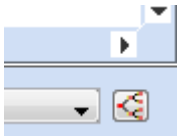
Figure 192: Agile Load Preview

**Note** Even if files are checked out by someone else, they are loaded using “Get” (e.g. load without checkout), so that you always have full access to the files necessary to bring up the model in CAD.

**Table 22: Load Dialog Toolbar Options**

<p><b>Load in CAD Button</b></p> 	<p>Start the download of files and open the files in CAD depending on the selected download options.</p>
<p><b>Cancel</b></p> 	<p>Cancel Load Preview and unlock CAD. Closing the Windows with the close button in the top right corner is supported.</p>
<p><b>Structure Resolution</b></p> 	<p>This selector defines the structure resolution used for retrieving components of Assemblies in PLM. The structure resolution re-runs if this option is changed. The default can be defined in the preferences <i>Structure Resolution on Load</i>.</p> <p><b>Latest In Work</b> – Use the latest version of a child design object.</p> <p><b>Latest Checked In</b> – Use the latest checked in version of a child design object.</p> <p><b>Latest Released</b> – Use the latest version of a child design, which is attached to a released Part.</p> <p><b>As Saved</b> – Use the child version from when the assembly was saved in PLM.</p>
<p><b>Load Drawings</b></p>	<p>If checked, the associated drawings are added to the list of files to load, by looking up the “Where Used” of the Designs. The structure resolution re-runs, if this option is changed.</p>
<p><b>Simplified Reprs</b></p>	<p>If checked, simplified representations are loaded to reduce CAD memory consumption. This feature is only supported with Creo Parametric.</p>

<p><b>Download Wizards</b></p> 	<p>These buttons provide a smart selection logic depending on the file status.</p>  Discard all local changes, where a newer version is available in PLM. The newer version is downloaded from PLM.  Discards all local changes and reloads the version from PLM.  Reload all local files from PLM, even if they are up to date.  Keep all local changes, no local changes are discarded.
<p><b>Download Options</b></p> 	<p>Sets the desired load option for selected components. Determines how the file is loaded from PLM to local disk. These options are automatically set by the system but they can be overridden by the user.</p>  Download the file to disk and display file in a CAD window  Download the file to disk  Do not download file to disk
<p><b>Checkout</b></p> 	<p>Set checkout reservation for the selected components.</p>
<p><b>Cancel Checkout</b></p> 	<p>Cancel checkout reservation for the selected components.</p>
<p><b>Preferences Button</b></p> 	<p>The preferences form pops out of the left sidebar.</p>
<p><b>Open Design Form</b></p> 	<p>Opens the Design object form in Agile Web Client.</p>

<p><b>Insert Component</b></p>	<p>If an Assembly is active in CAD, the element selected for load is inserted into the Assembly structure in CAD, rather than opened in a separate window. The capabilities and positioning dialogs depend on the CAD system. This option is not supported in all CAD tools. Administrators may make this check box invisible through an option setting (refer to the <i>Administration Guide</i> for details).</p>
<p><b>Add all Drawings</b></p>	<p>Checks all components within the Load dialog, and adds any related drawings to the Load dialog.</p>
<p><b>Tree View Toggle</b></p> 	<p>The tree view selector switches the visibility of the structure browser on and off. By default the structure view is shown. The default is set by an administrator in CAXConfig.xml. Please refer to the <i>Administration Guide</i> for details.</p>

CAD File	Component	Number	Ver	Rev	Description	Label	Lifecycle Pha...	Checkout Us...	↕?	↓	Type
sk1030098_...		DESIGN00...	1	-1	unassigned		Prototype		↕	↓	PRT
sk1030098_...		DESIGN00...	1	-1	Kühler		Prototype		↕	↓	PRT
sk1030098_...		DESIGN00...	1	-1	unassigned		Prototype		↕	↓	PRT
sk1030098_...		DESIGN00...	1	-1	unassigned		Prototype		↕	↓	PRT
sk1030098_...		DESIGN00...	1	-1	unassigned		Prototype		↕	↓	PRT

Figure 203: Load Dialog Object Table

Table 23: Fields in the Load Dialog

<p><b>CAD Object</b></p>	<p>The CAD file name.</p>
<p><b>Component</b></p>	<p>Component Type of the Design object in Agile.</p>
<p><b>Number</b></p>	<p>Number of the Design object in Agile.</p>
<p><b>Version</b></p>	<p>Version of the Design object. This number starts at 1 and increments by 1 for each check in.</p>
<p><b>Rev</b></p>	<p>The Revision of the Design object, which includes a major and minor component. Each version has a unique revision, which is controlled by the part revision logic.</p>
<p><b>Description</b></p>	<p>Description of the Document object in Agile.</p>
<p><b>Lifecycle</b></p>	<p>The lifecycle phase associated with the current Design version.</p>
<p><b>Checkout User</b></p>	<p>Current checkout user, if any.</p>
<p><b>[File Status]</b></p>	<p>Gives the status of the particular file, both in PLM and on the local disk.</p>

	The local file is exactly the same as what is in PLM.
	The file has been updated in PLM, and so is more recent than what is on local disk.
	The file has been modified locally, and so is more recent than what is in PLM.
	The file has been modified both on the local disk and in PLM.
	The file status cannot be determined.
<b>[Download Option]</b>	Determines, how the file is loaded from PLM to local disk.
	Load and display in a CAD window.
	Load but don't display.
	Do not load.
<b>CAD Type</b>	Shows the CAD file extension, which can be used for sorting.

## Multi-Select and Context Menus

Since you often have many items listed in the Load dialog, it is convenient to be able to set options for multiple items at a time. This is made possible by multi-select and context menus.

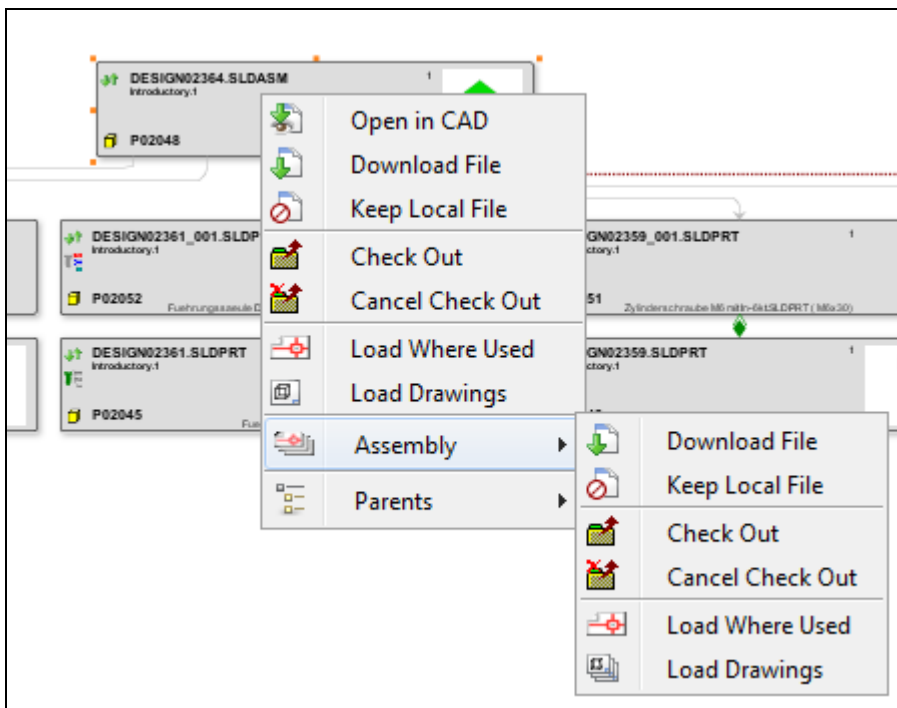
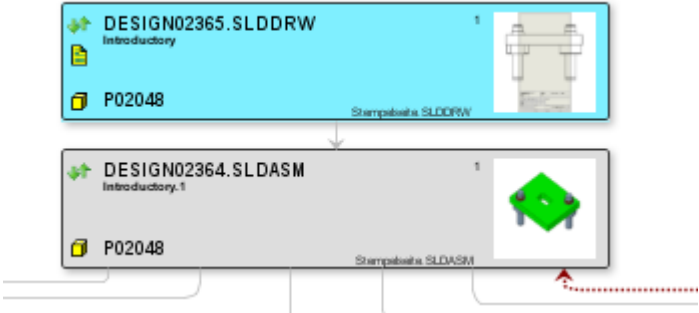


Figure 214: Multi-Select:Context Menus

Since the structure information is known, the *Assembly* sub-menu provides recursive functionality

to perform operations for all the children of the selected assembly.

To multi-select, simply click within any item in the window and either hold down on the left mouse button and drag the cursor, or use Shift-click or Control-click. Once you have selected the desired items, you can use the context menu (right mouse button) to execute any of the commands listed in the following table.

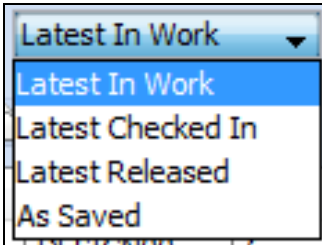
Command	Description
Open in CAD	Download and open the selected file in CAD.
Download File	Sets selected files to be retrieved to local disk.
Keep local File	Sets selected files to NOT be retrieved to local disk.
Check Out	Sets checkout reservation for currently selected objects.
Cancel Check Out	Cancels checkout reservation for currently selected objects.
Load Drawings	<p>Performs a Where Used query in PLM on the selected objects and filters related drawings. The resulting drawings are added to the Save Preview. The added drawings are highlighted in light blue.</p> 
Load Where Used	<p>Performs a where used query in PLM on the selected objects like the <i>Load Drawings</i> menu item except there is no filtering for drawings. The found referencing objects are added to the save preview. On the where used the Design relationships in PLM are scanned for referencing CAD objects like part families, external geometry, and similar, as well. The added objects are highlighted in light blue.</p>
Cancel Check Out	Cancels checkout reservation for currently selected objects.
Assembly submenu	Performs contained actions recursively for the selected object and all children.
Parents submenu	Performs contained actions recursively for the selected object and all its parents.

**Table 24: Load Dialog – Context Menu**

## Structure Resolution Options

The EC Web Connector provides full capability for loading any desired revision of the CAD files. This is done through a combination of two controls within the EC Web Connector UI:

**Structure Resolution Select Box:** The Structure Resolution select box has four choices, *Latest In Work*, *Latest Checked In*, *Latest Released* and *As Saved*.



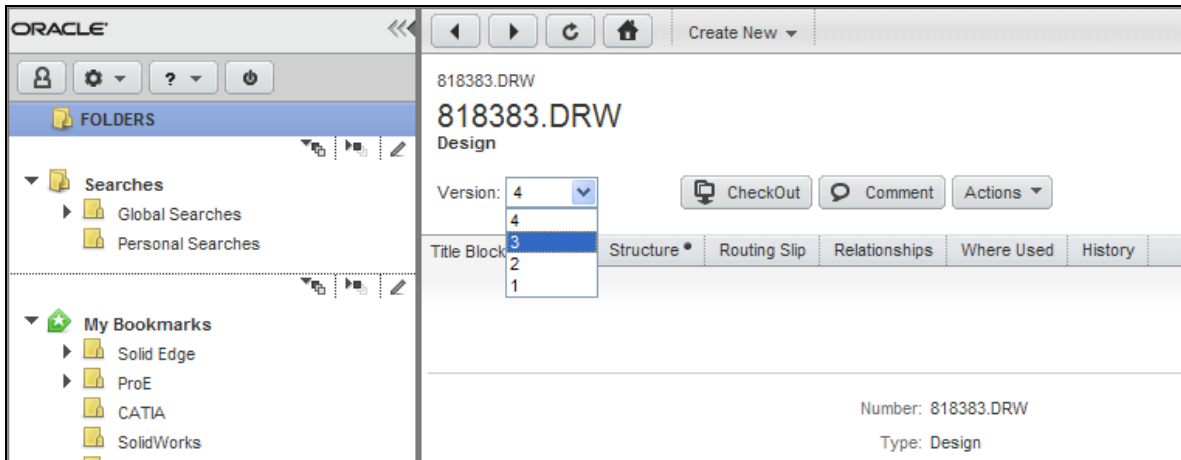
**Figure 35: Structure Resolution Select Box**

**Table 25: Structure Resolution Select Box: Description**

<p><b>Latest in Work</b></p>	<p>Starting with the selected object, each Design version in the structure, being checked out by you, is chosen to load. If there is no checked out version for a given Design, or if it is checked out by someone else the latest checked in version is chosen instead. This is the most up-to-date view you can get of the CAD design. It loads the latest version of each sub-assembly and component that can be extracted from the tree.</p>
<p><b>Latest Checked In</b></p>	<p>Starting with the selected object, each checked-in Design version in the structure is chosen to load. This is a good option when loading a CAD design from PLM in order to make a change, while ensuring that the latest version of all sub-assemblies and components are being loaded. Note that these versions may be more up-to-date than the versions with which the top assembly was actually saved.</p>
<p><b>Latest Released</b></p>	<p>Starting with the selected object, each Design version in the structure being attached to a released part is chosen to load. This is a good option when loading a CAD design out of PLM, in order to get a released assembly structure and ensuring that the latest released version of all sub-assemblies and components are loaded as well. Note that these versions may be more up-to-date than the versions with which the top assembly was actually saved.</p> <p>If no released version exists for a Design, the version that was saved to PLM together with its parent object is chosen (this is equal to what the structure resolution option “As Saved” would return).</p>

<p><b>As Saved</b></p>	<p>Starting with the selected object, each Design in the structure is loaded just the way it was saved into Agile. This is known as "Fixed" structure resolution, and that is what is shown in the Design Structure tab. This is useful for loading any version, current or past, just the way it was saved into PLM.</p>
------------------------	---

**Note** Note that with any of these options, if you want to load a past revision, you must execute the load directly from the Design object web form, not from the search results list. That is necessary because you need to be able to select the version of the top Design, as shown below.



**Figure 226: Version Selector – For use with “As Saved”**

Regardless of which load option you use, the Load dialog always displays the revision that is being loaded for each item. If this does not appear to be correct, it is always possible to cancel the process from the Load Dialog. Nothing is loaded in this case.

# Creating New Objects

## Introduction

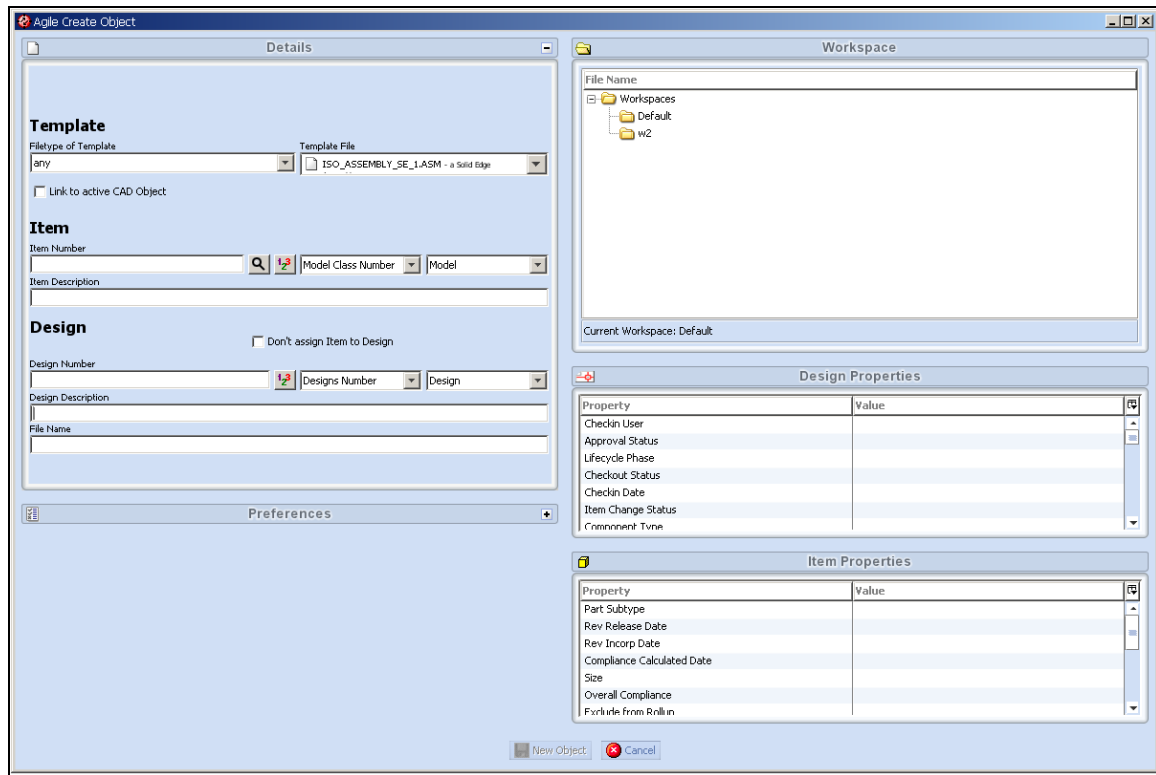
The Create Object frame is a dialog frame that enables the user to create new objects simultaneously in CAD and Agile9. The object creation is based on template files stored in PLM; the user can choose the template being used. The dialog can be opened with the *New* command in the ribbon or menu bar of the user's CAD. Depending on the CAD this command may appear in a submenu called *Agile*.

The basic workflow for creating new objects includes the following steps:

- Selection of a template using the Template File combo box
- Assignment of a design subclass to the object using the Design Subclass combo box (optional, the class having been pre-selected on template selection could be used as well)
- Assignment of a design number using the Design AutoNumbers combo box and the Design AutoNumbers button or manual input
- Assignment of an item (optional)
- If every necessary parameter is correctly entered the New Object button becomes clickable and can be used to finish object creation. That means, the selected template file are copied to the previously selected workspace directory on the user's machine and opened in the user's CAD. A corresponding Design object in PLM is created simultaneously.

## Using the Create Object Dialog

The Create Object dialog is subdivided into five sections. The first and most important among them is the *Details Pane* on the left hand side. This component contains the basic elements for object creation.

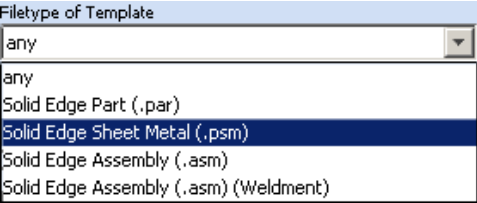
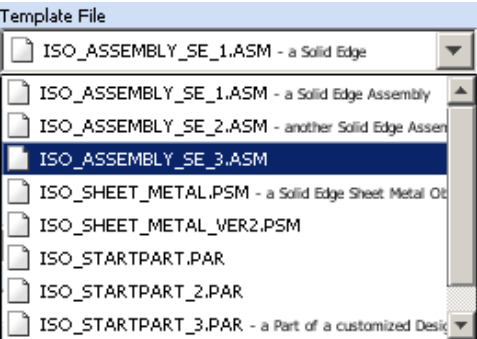




**Figure 237: Create Object dialog, used to create new objects**

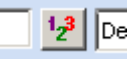
Other components in the Create Object dialog are the *Preferences Pane* (left hand side, collapsed in the figure), the *Workspace Pane* and the *Design* and *Item Properties* tables on the right hand side. These four components behave similar to the components used in the sidebar of the Save and Load Dialog, however, there are minor differences. For a detailed documentation of these components, please consult the appropriate sections for the Save and Load Dialog in this document. The following paragraphs explain the Details pane and the differences between the components used in the Create Object frame in comparison to the same components used in the Load respectively Save Dialog.

## Details Pane

**Table 26: User Interface Elements of the Details pane**

Element	Description
<p><b>Filetype of Template combo box</b></p> 	<p>Lets the user choose a file type for the templates displayed in the Template File combo box. The subtype is displayed in brackets behind its file type if templates with assigned subtypes are available for selection. If the <i>any</i> option is selected, all available templates are displayed. If an entry without a subtype is selected, all templates of that file type are displayed (no matter if they have a subtype assigned or not), if an entry with both a file type and a subtype is selected, only the templates of that file type <b>and</b> subtype are displayed.</p>
<p><b>Template File combo box</b></p> 	<p>Lets the user choose a template file from which a new CAD file can be created. The combo box displays the names of all suitable template files for the file type (or file type and subtype) selected in the Filetype of Template combo box and their description (if given in PLM).</p> <p><b>Note:</b> New objects can only be created if a valid file is selected in this combo box.</p>
<p><b>Item Subclass combo box</b></p>	<p>In this combo box the subclass of an item object in Agile9, which can be optionally created, can be chosen. This combo box is set inactive if no item should be created.</p>
<p><b>Item AutoNumber combo box</b></p>	<p>This combo box contains all available AutoNumber generators for the item subclass currently selected in the Item Subclass combo box.</p>

<p><b>Item AutoNumber button</b></p> 	<p>If this button is clicked, the next available number from the selected AutoNumber generator is inserted into the Item Number text field.</p>
<p><b>Item Search button</b></p> 	<p>This button executes a part search in PLM using the values entered in the Item Number text field and the Item Description text field. If there is one match, the found number is written into the Item Number text field. If more than one match is found, a dialog pops up and the user can select the desired part from the list of found parts. This function can be used to assign a design to an existing part.</p>
<p><b>Item Number text field</b></p>	<p>This text field is used to enter the item number of an item object in Agile9 that should be linked to the design object in case an item should be created at all.</p>
<p><b>Item Description text field</b></p>	<p>The description of the part item that is assigned to the design.</p>
<p><b>Design Subclass combo box</b></p>	<p>A combo box that enables the user to choose a design subclass for the object being created. When a template is selected in the Template File combo box, the pre-assigned design subclass of that template is pre-selected in this combo box. However, the user can choose every other available subclass if he wishes.</p>
<p><b>Item Description text field</b></p>	<p>The description of the part item that is assigned to the design.</p>
<p><b>Design AutoNumber combo box</b></p>	<p>This combo box contains all available AutoNumber generators for the design subclass currently selected in the Design Subclass combo box.</p>

<p><b>Design AutoNumber button</b></p> 	<p>If this button is clicked, the next available number from the selected AutoNumber generator is inserted into the Item Number text field.</p>
<p><b>Design Number text field</b></p>	<p>This text field is used to enter the design number of the design object in Agile9 that is being created simultaneously with the CAD file.</p> <p><b>Note:</b> New objects can only be created if this text field is not empty.</p>
<p><b>Design Description text field</b></p>	<p>The value that is used as the description assigned to the design object that is being created.</p>
<p><b>File Name text field</b></p>	<p>The CAD file name that is being saved into Agile.</p>
<p><b>New Object button</b></p>	<p>Creates a new object from the template being selected in the Template File combo box in CAD and creates a structure for that object in Agile9.</p> <p><b>Note:</b> This button remains deactivated as long as no template is chosen and no Design number is assigned. Both are required parameters.</p>
<p><b>Cancel button</b></p>	<p>Closes the Create Object frame without changing anything.</p>

### Preferences Pane (initially collapsed)

The Preferences Pane behaves much like the Preferences Pane in Save or Load Dialogs. The only difference is that changes in the Class Default Settings are automatically applied to the corresponding elements in the Details Pane, too. In detail that concerns the Design Subclass combo box, the Item Subclass combo box and the AutoNumbers combo boxes belonging to these. As well as the Details Pane the Preferences Pane can be collapsed to save screen space if needed. For further information on the Preferences Pane please refer to the paragraph

*Preferences Dialog* in this document.

## Workspace Pane

The Workspace Pane is used to select the workspace folder, there are no differences in behavior compared to Save and Load Dialogs. For further information on how to work with workspaces please consult the chapter *Workspace Management* in this documentation.

## Design and Item Properties Tables

These two properties tables are used to display design and item properties of the object that should be created. The "Value" column is usually editable and a few entries of the Design Properties may be preassigned depending on the selected template in the Template File combo box. A property is preassigned if a corresponding entry in the Agile form of the corresponding template object exists. Whenever a new template is selected in the combo box the predefined values of that template are loaded into the table. Above that there are no differences to the properties tables used in the sidebar of the Save and Load Dialogs.

# Workspace Management

## Introduction

In order to control updates to CAD files and the Design structures in Agile, the CAD Connectors provide the ability to manage the change process using the inherent capability in Agile. There are primary components to this capability:

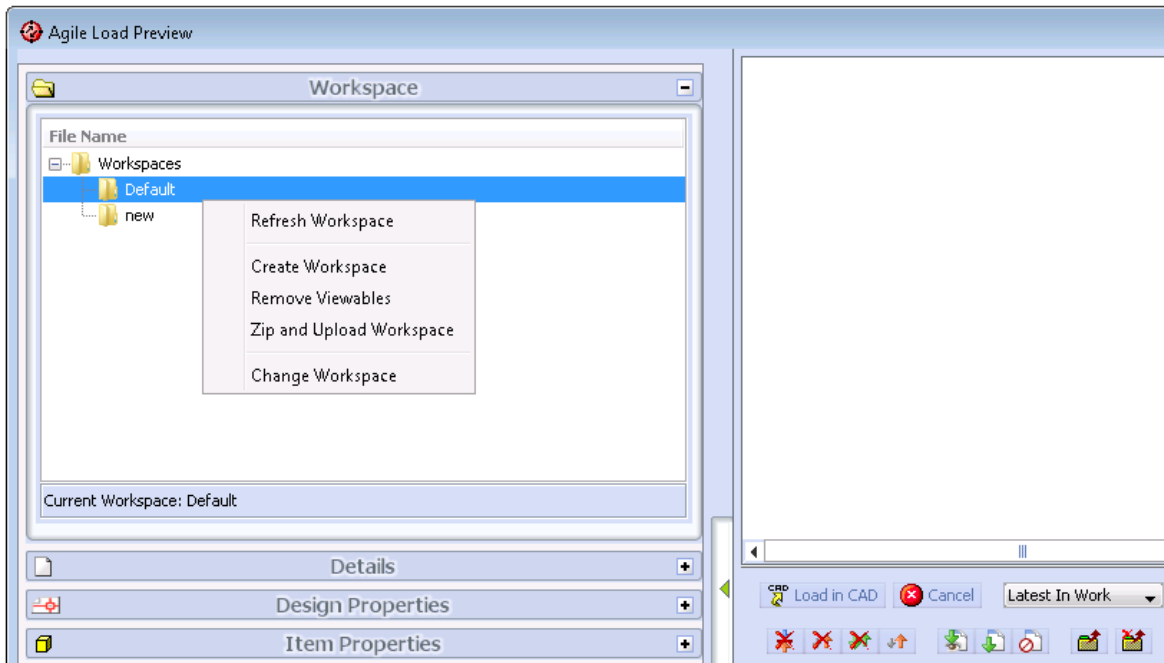
- Controlling the ability to update the files in Agile, using privileges, checkout reservation, and versioning.
- Controlling the change process workflow, using revisions and ECOs.

## Workspace name with Asian characters

Some CAD software, e.g. Creo Parametric and CATIA, do not support Asian characters for the name of the workspace. We recommend only using ASCII characters.

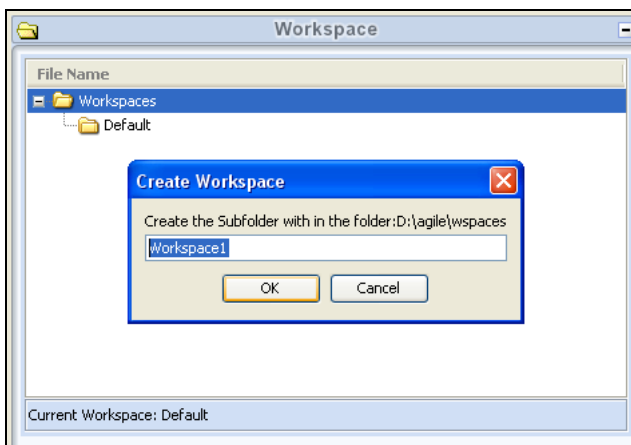
## Set Workspace During Load, Save or Object Creation

Expanding the left Sidebar in the Load or Save Preview you can select the Workspace area by clicking the plus sign beside the Workspace label. In the Create New frame the Workspace pane can be accessed directly. The Workspace pane enables you to create or select Workspaces, which correspond to folders on your local disk.



**Figure 24: Agile Load Preview**

You can create new workspaces using the context menu *Create Workspace* in the workspace tree structured view:



**Figure 39: Workspace: Create Workspace**

To set the workspace to be used for load, save or object creation you select the *Change Workspace* context menu pick. The current workspace is shown at the bottom of the Workspace pane.

During load, all downloaded files are copied to the currently selected workspace and loaded from there into CAD. Make sure your CAD environment is setup properly to pull the component files out of the same directory as the assembly.

During object creation, the newly created CAD file is saved to the current workspace as well.

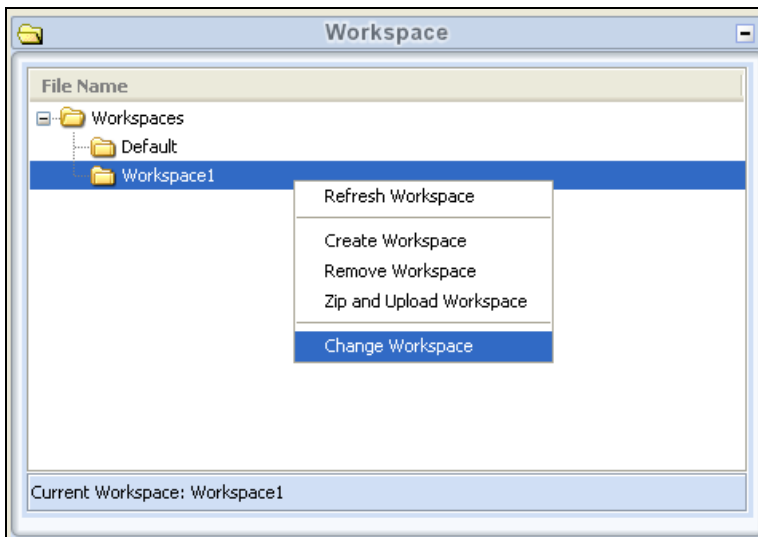


Figure 250: Workspace: Change Workspace

## Archiving Complete Workspaces

The *Zip and Upload* command can be used to compress a complete workspace, including all files and subdirectories. The zip file is uploaded to PLM in a Design object named with the Design AutoNumber defined in the *WorkspaceFolderAutoNumber* option setting in the CaxConfig.xml file. The created folder is linked to the bookmarks of the current login user.

The zipped file also contains the PLM cache information and can be used to save or transfer complete workspaces, including all CAD files and PLM related information. When extracted into a workspace on a different machine, the Workspace Manager imports the **cache.xml** file and can detect the correct PLM objects and versions corresponding to the local CAD files. **It is recommended that you extract complete workspaces into a new empty target workspace.**

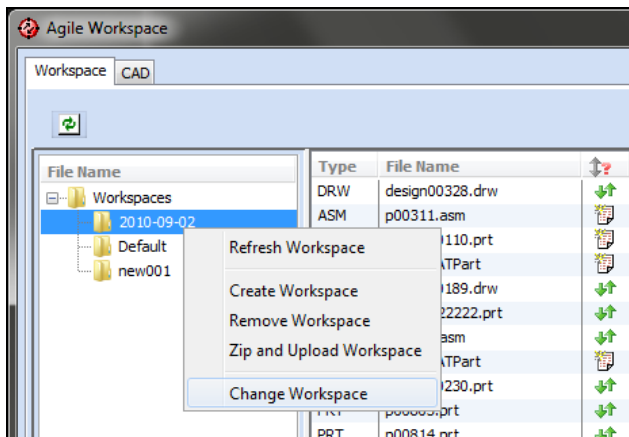
## CAD working directory vs. EC Workspaces

Be aware that changing the working directory of the CAD system like Creo Parametric and changing the EC Workspace are two different things and lead to different behaviour of the integration.

The working directory is the active directory in the CAD system, where the engineer is working. This directory is not necessarily the same directory where the CAD files loaded in session are located, because after load the working directory may be changed or some components are loaded from external library paths.

The EC workspace is a managed directory of the MCAD integration that can be displayed in the Workspace Manager. EC workspaces are located in a dedicated local area on disk defined by the environment setting CAX\_WORKSPACE\_ROOT. All directories below this root can be displayed in the EC Workspace Manager. External directories outside this root are not displayed, but the connector tracks the file status of any file independent from the path where it resides.

The best practice is to have both, the CAD working directory and the EC workspace, share the same folder location. This can be done using the *Change Workspace* command in the Workspace Manager. This also sets the current working directory in Creo Parametric respectively Creo Parametric to the same value.



**Figure 261: Workspace: Create Workspace**

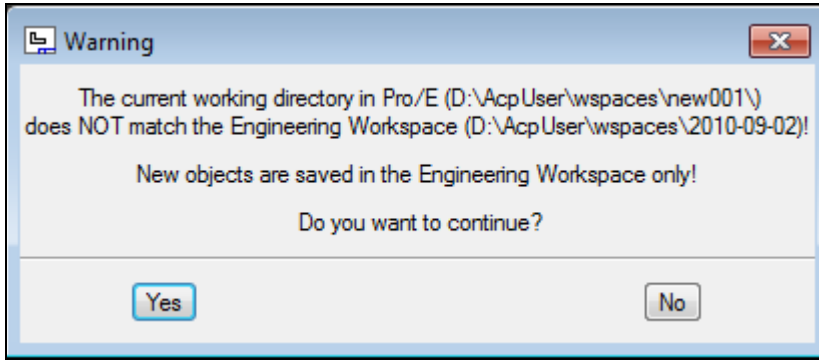
**Note** If the current working directory is changed in CAD manually, the EC Workspace is NOT changed!

## Workspaces on Save

In order to keep assembly integrity the location of files on disk are not changed during save. Only completely new files not stored on disk are saved into the active EC workspace.

**Note** Setting the current working directory in CAD has NO effect on where the new files go. Set the EC workspace to control where new files go during save to Agile.

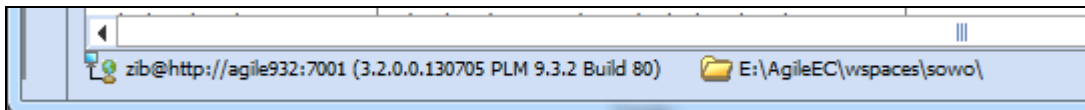
If the current working directory in Creo Parametric does not match the active EC workspace, a warning dialog is displayed to user:



**Figure 42: Warning Message: Current CAD working directory does not match with active EC workspace**

The user can now decide to continue and create new objects into the Engineering Workspace folder or to abort saving and reset the engineering workspace and the CAD working directory.

The current selected workspace can be seen in the bottom of the Save Preview Window.



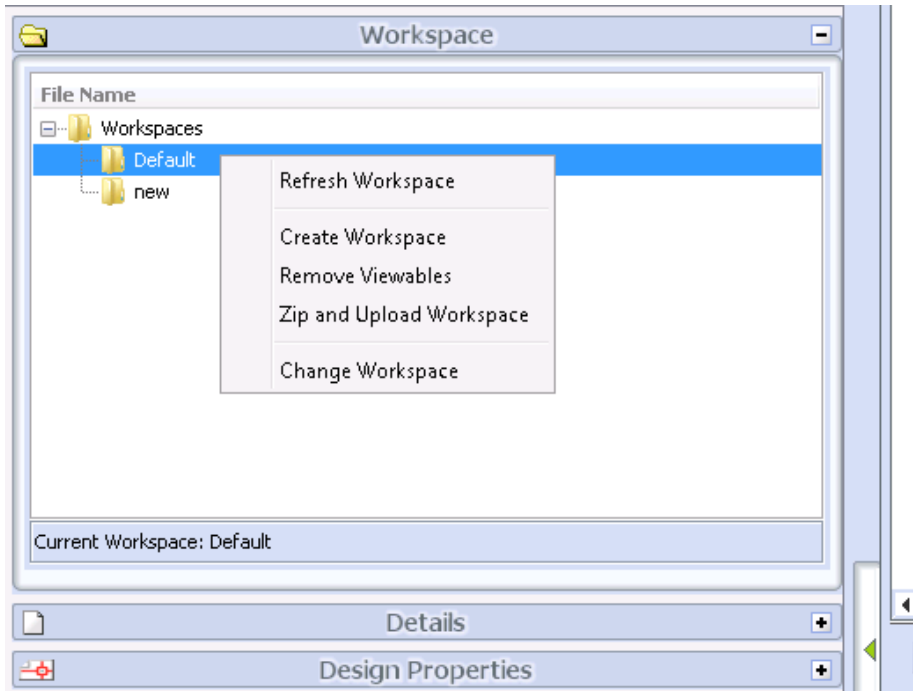
**Figure 273: Information of the Current Workspace at the bottom of the save preview window**

Even in the Save Preview the engineering workspace can be changed in the sidebar. **Changing it in the Save Preview does NOT reset the CAD working directory.** The current working directory in CAD is retained during save. It is reset to the same directory after saving as it was before saving. **If you intend to change both at once, use the Agile Workspace Manager before saving.**

If the CAD files are renamed during initial save and the file location is changed, the original file is retained. Viewables are generated in the active workspace of the CAD file

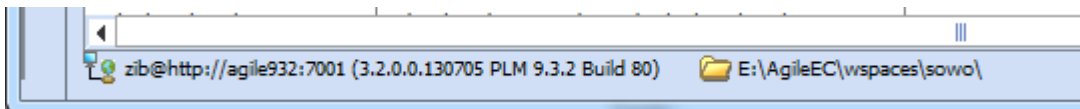
## Workspaces on Load

On load from Agile the target workspace can be selected using the *Change Workspace* command in the Workspace Manager or in the sidebar of the Load preview as shown below. On change of the current workspace, the file status checks are executed and the display is refreshed. Both commands also set the current working directory in CAD.



**Figure 28: Workspace Options on Load**

**Note** ATTENTION: Before changing the workspace, it is recommended that you clean the CAD session. The current selected workspace can be seen in the bottom of the Load Preview window. Find the information of the current workspace at the bottom of the save preview.



**Figure 45: Information of the Current Workspace at the bottom of the save preview window**

## Workspaces on CAD Start

The last workspace is stored in the **connect.properties** file in users AgileCache directory. During startup Creo Parametric scans this file for the workspace and sets the CAD working directory to the last workspace.

## Using the Workspace Manager

The *Agile → Workspace Manager* command is used to view and change the checkout status of the CAD files controlled by Agile and for the managed workspaces. The following figures and tables explain the commands available; how you use them to effectively manage the change process for the CAD designs is described following that.

### Using the Workspace Manager CAD Session Tab

After launching the Workspace Manager from CAD, the content of the current CAD session is shown in the CAD tab. Here you can perform PLM actions on the designs that are active in your CAD session.

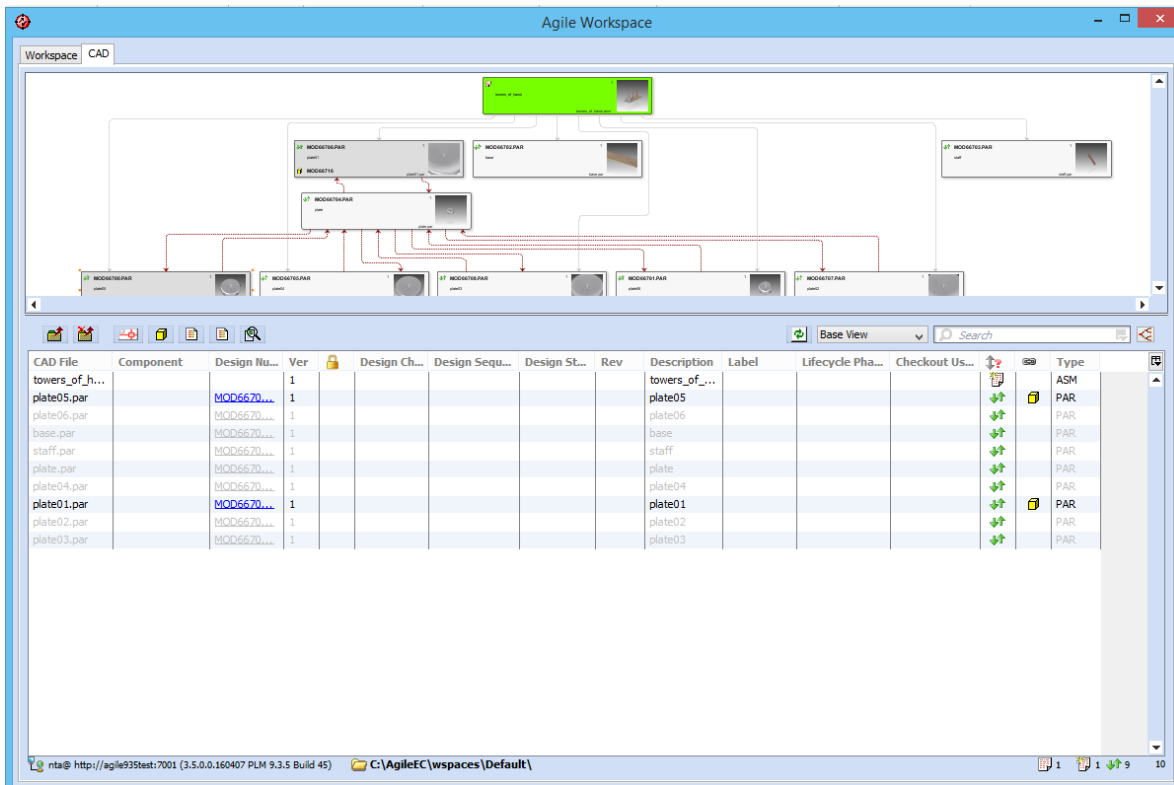








Figure 296: Workspace Manager - CAD Session Tab



**Figure 307: Session tab dialog**

Details of the CAD Session tab dialog are described in the tables below.

**Table 27: Session tab dialog: Description**

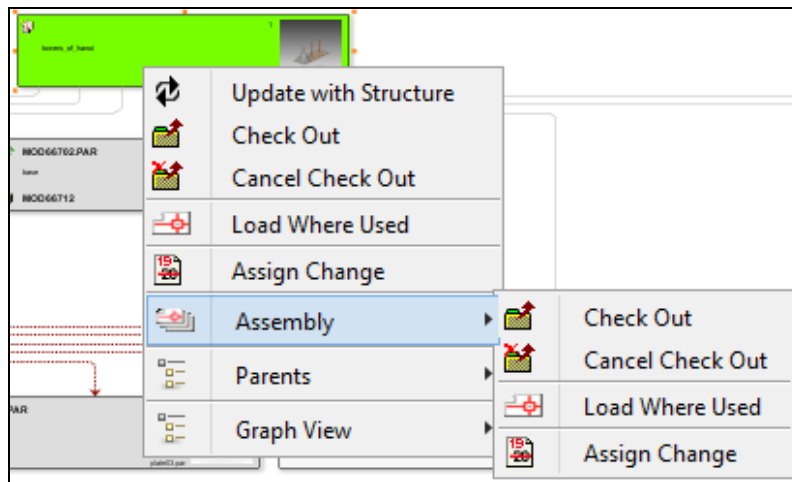
<p><b>Checkout</b></p> 	<p>Set checkout reservation for the selected components.</p>
<p><b>Cancel Checkout</b></p> 	<p>Cancel checkout reservation for the selected components.</p>
<p><b>Open Form for Design, Part or Change</b></p> 	<p>Opens the desired form in Web Client.</p>
<p><b>AutoVue</b></p> 	<p>Opens the AutoVue applet.</p>
<p><b>Refresh</b></p> 	<p>Updates the display from Agile.</p>
<p><b>Tree View Toggle</b></p> 	<p>The tree view selector switches the visibility of the structure browser on and off. By default the structure view is shown. The default is set by an administrator in CAXConfig.xml. Please refer to the <i>Administration Guide</i> for details.</p>

**Table 28: List Fields and Controls of the CAD Session Tab**

<p><b>CAD Object</b></p>	<p>The CAD filename.</p>
<p><b>Component</b></p>	<p>Component Type of the Design object in Agile.</p>
<p><b>Number</b></p>	<p>Number of the Design object in Agile.</p>
<p><b>Ver</b></p>	<p>Version of the Design object.</p>

<b>Rev</b>	The Revision of the Design object, which includes a major and minor component. Each version has a unique Revision, which is controlled by the part revision logic.
<b>Description</b>	Description of the Design object in Agile.
<b>Lifecycle Phase</b>	Lifecycle phase of the specific version.
<b>Checkout User</b>	The name of the current checkout user, if any.
<b>[File Status]</b>	Gives the status of the particular file, both in PLM and on the local disk.
↕↕	The local file is exactly the same as what is in PLM.
↓↕	The file has been updated in PLM, and so is more recent than what is on local disk.
↕↑	The file has been modified locally, and so is more recent than what is in PLM.
↕↕	The file has been modified both on the local disk and in PLM.
<b>[Part Assignment]</b> 📄	Indicates whether the file has a part assigned in Agile. If so, the part icon is displayed in the column.
<b>CAD Type</b>	Shows the CAD file extension, which can be used for sorting.

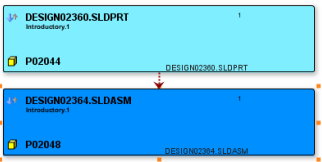
## Multi-Select and Context Menus



**Figure 318: Multi-Select and Context Menus**

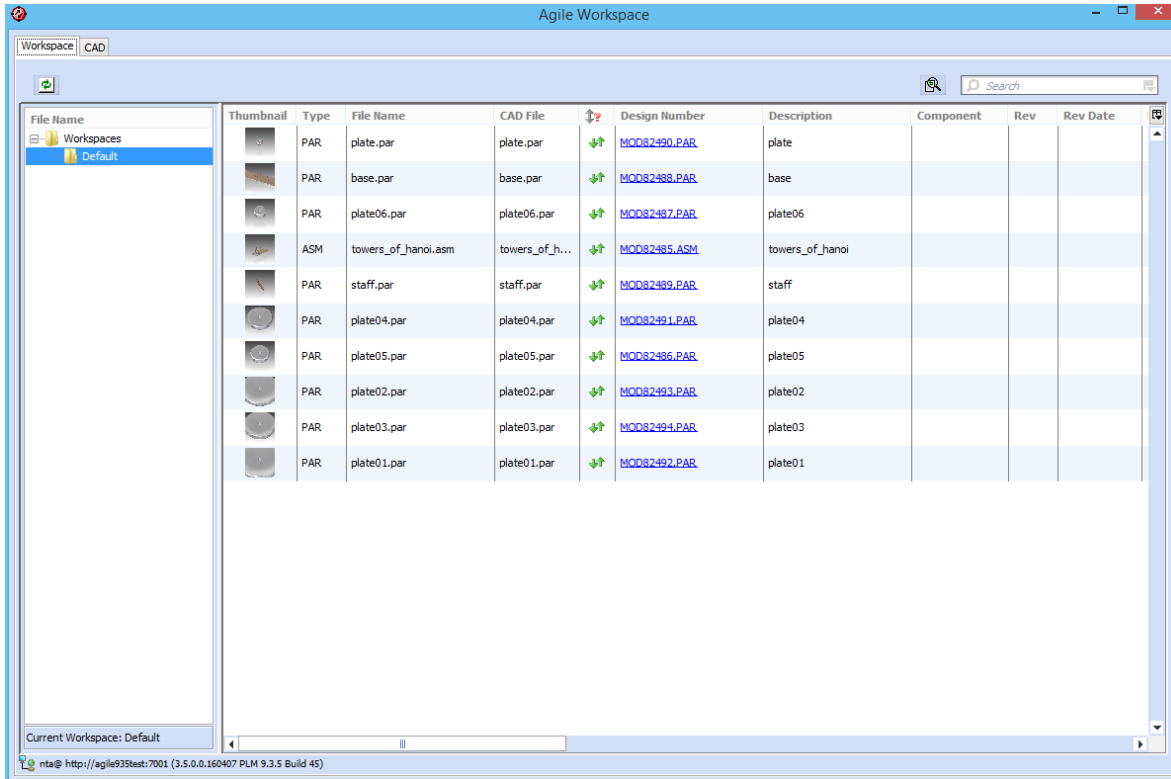
You can multi-select within the dialog to operate on more than one item at a time. Once you have selected the desired items, you can use the context menu (right mouse button) to execute any of the commands listed in the table below.

**Table 29: Multi-Select and Context Menus: Description**

Command	Description
<b>Update with Structure</b>	Starts the Load Preview from PLM in order to reload an assembly to the local disk
<b>Check Out</b>	Sets checkout reservation for currently selected objects.
<b>Cancel Check Out</b>	Cancels checkout reservation for currently selected objects.
<b>Load Where Used</b>	<p>Performs a where used query in PLM on the selected objects like the Load Drawings menu item except there is no filtering for Drawings. The found referencing objects are added to the save preview. On the where used also the Design relationships in PLM are scanned for referencing CAD objects like Part Families, external Geometry, and similar. The added objects are highlighted in light blue.</p> 
<b>Assembly submenu</b>	Performs contained actions recursively for the selected objects and all their children.
<b>Parents submenu</b>	Performs contained actions recursively for the selected objects and all their parents.
<b>Graph View submenu</b>	Performs different ways to show the selected objects and their children in the Workspace window.

## Using the Workspace Manager Workspaces Tab




The Workspaces tab is a CAD filtered view on your local disk and workspaces structure. For the CAD files, it displays the PLM information for each single file. The file status column displays the status of each local file, even if it is not loaded in CAD.






**Figure 4932: Workspace Manager – Workspaces Tab**

Details of the Workspaces tab dialog are described in the tables below.

**Table 30: List Fields and Controls of the Workspaces Tab**

<b>Thumbnail</b>	Shows the CAD thumbnail if available in the CAD file.
<b>CAD Type</b>	Shows the CAD file extension, which can be used for sorting.
<b>File Name</b>	Local CAD filename.
<b>[File Status]</b>	Gives the status of the particular file, both in PLM and on the local disk.
	The local file is exactly the same as what is in PLM.
	The file has been updated in PLM, and so is more recent than what is on local disk.
	The file has been modified locally, and so is more recent than what is in PLM.

	The file has been modified both on the local disk and in PLM.
<b>Number</b>	Number of the Design object in Agile.
<b>Description</b>	Description of the Design object in Agile.
<b>Component</b>	Component Type of the Design object in Agile.
<b>Revision</b>	The Revision of the Design object, which includes a major and minor component. Each version has a unique revision.
<b>PLM Version</b>	Latest version of the design in PLM.
<b>Local Version</b>	Corresponding PLM Version of the local file.
<b>Date</b>	An optional aate field, which can be associated to the version of the Design object.
<b>Checkout User</b>	The name of the current checkout user, if any.
<b>Checkout Date</b>	The date of the current checkout, if any.
<b>Modify Date</b>	Local modification date.
<b>Item Number</b>	The number of a related Part object in PLM.
<b>Rev</b>	The revision of the Part object.
<b>Path</b>	Full path information of the file.
<b>Size</b>	Local file size.
<b>Refresh</b> 	Updates the display from Agile.
<b>AutoVue</b> 	Allows users to easily access AutoVue displaying a certain CAD file, without having to access Agile PLM's web client first.

## Search Field in the Workspace Manager

The Workspace Manager contains a search field that can be used to filter the elements displayed in the Workspace Manager by certain, user-given search criteria. In the search field it is possible to define a data column (shown in Figure 33). The defined column is the one used for searching.

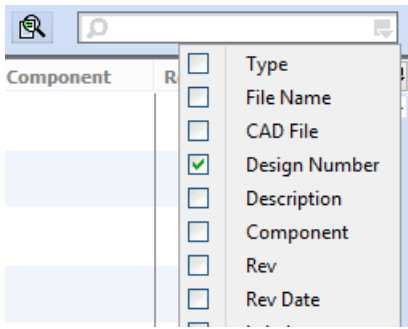


Figure 330: Selection of a search column in the Workspace Manager

## Multi-Select and Context Menus

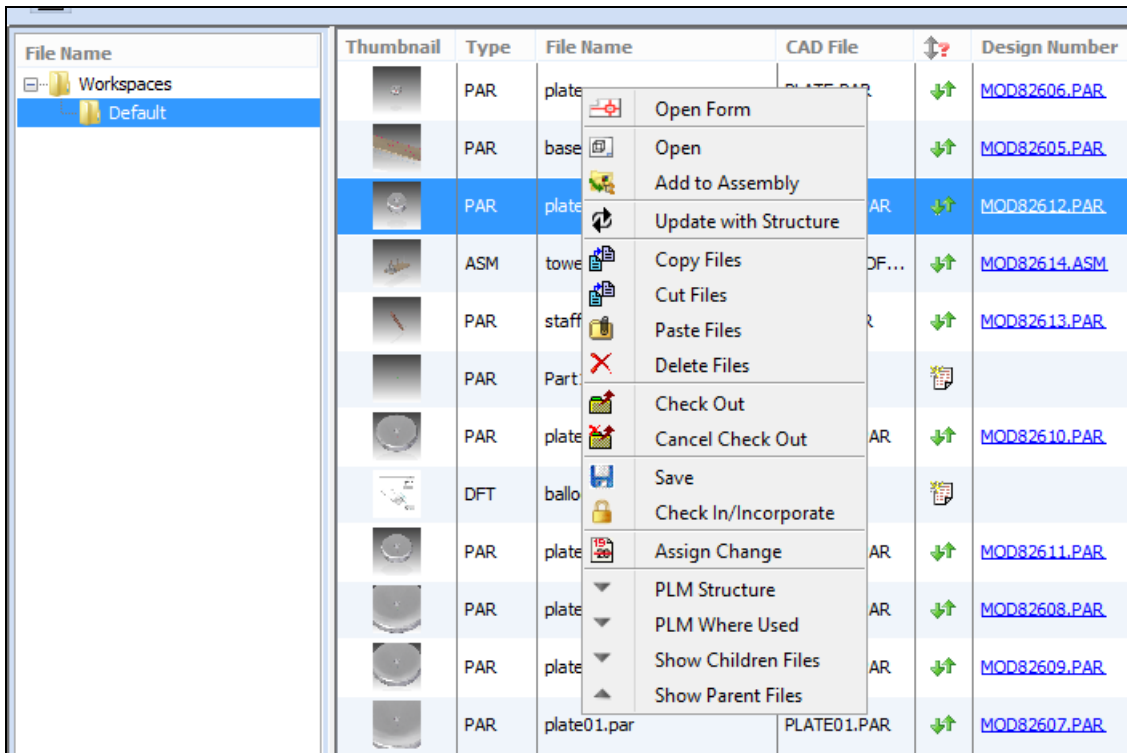
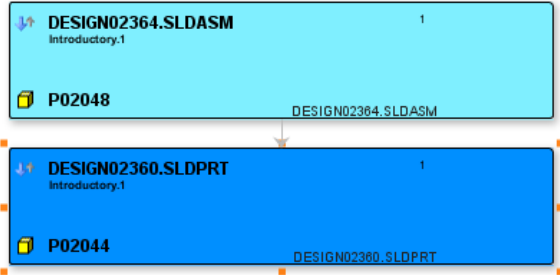


Figure 51: Multi-Select and Context Menus

You can multi-select within the dialog (CTRL+left mouse), to operate on more than one item at a time. Once you have selected the desired items, you can use the context menu (right mouse button) to execute any of the commands listed in the table below.

**Table 31: Context Menus of Workspace Manager**

Command	Description
<b>Open Form</b>	Open the Design form in Web Client.
<b>Open</b>	Open the selected file from disk in CAD and display it in a CAD window.
<b>Open non displayed</b>	Open the selected file from disk in CAD Session, but do not display a CAD window. <b>This is available for Pro/E and NX only.</b>
<b>Add to Assembly</b>	Open the selected file from disk in CAD and launch the add component dialog in CAD. <b>This is supported for Pro/E, Solid Edge and CATIA.</b>
<b>Update with Structure</b>	Performs a structure resolution in PLM and displays a load preview.
<b>Update File</b>	Updates the local file with the latest version from PLM. No structure resolution is executed to retrieve components.
<b>Copy Files</b>	Copies all selected files to a virtual clipboard, note that this is not the system clipboard.
<b>Cut Files</b>	Copies all selected files to a virtual clipboard. The selected files can then be removed from their original directory and moved to another directory using the <i>Paste Files</i> function. As long as <i>Paste Files</i> is not executed, the selected files remain visible.
<b>Paste Files</b>	<p>Inserts the files from the virtual clipboard to the workspace directory on which the <i>Paste Files</i> function is executed. If the files were sent to the clipboard with the <i>Cut Files</i> function, they are removed from their original directory and the clipboard. They, however, remain in place and on the clipboard if the <i>Copy Files</i> function was used.</p> <p>If there are files with similar file names in the destination directory the user is prompted for overwriting them. If the user denies, then the previously selected files are not removed even if the <i>Cut Files</i> function was used on them. Pasting files do not work if the files to be processed are removed from the source directory before the <i>Paste Files</i> function is used.</p>
<b>Delete Files</b>	Delete selected files and all local version copies from the current workspace directory.
<b>Check Out</b>	Check out the selected Design in PLM.
<b>Cancel Check Out</b>	Remove the check out of the selected Design in PLM.
<b>Save</b>	Saves files from the current CAD model to Agile, performing a check in and check out to increment the Design version.

<b>Check In/Incorporate</b>	Performs a single object/single level save to PLM. Sets the <i>Incorporate</i> flag, if the CAD file saved has a pending Design Change Order assigned.
<b>Assign Change</b>	Opens a dialog window allowing users to assign Item or Design Changes (e. g. ECOs, DFCOs) to the currently selected Design or Item object.
<b>PLM Structure</b>	Switch to the Structure Browser CAD tab and show the structure information from PLM for the selected file.
<b>PLM Where Used</b>	Switch to the Structure Browser CAD tab and show the where used parents information from PLM for the selected file. The Design structure where used and the Design relationships table is scanned for Objects referencing the current file. The found parents are highlighted in light blue.  
<b>Show Children Files</b>	In the Workspace Manager, this function highlights all child objects of the currently selected CAD file regardless of the actual version of these files.
<b>Show Parent Files</b>	In the Workspace Manager, this function highlights all parent objects of the currently selected CAD file regardless of the actual version of these files.

The *Open non displayed* command can be used for initial data load or to save multiple top level objects, like drawings, to PLM. The user can bring multiple objects into the CAD session and can then use the *Save Session* command in Pro/E to save everything in one save process.

---

**Note** ATTENTION: In order to create PDF for drawings in Pro/E the drawing must be displayed and regenerated in session. Otherwise no PDF is created.

---

## File Sync Status Mismatch (Creo Connector Only)

In the ACP connector, there are two different file change recognition functionalities implemented. While the Workspace Manager only uses the timestamp of the files, the Save Preview window uses the internal file modification flag provided by Creo Parametric for modification detection. If

there are modifications made to a Creo file and this file has not yet been saved, it might happen that the Save Preview and the Workspace Manager display a different sync status for the same CAD file. Saving the changes made to the Creo file to disk should solve this problem.

## Design File Release Process

Since MCAD version 3.5, the *Design File Release Process* of Agile PLM is supported by the MCAD connector. For details regarding this process, refer to the documentation of Agile PLM: [What's New in Agile Product Lifecycle Management \(E61170-01\), chapter 2, "Design File Release Process"](#).

## Incorporating Design Objects

The *Check In/Incorporate* save option of the MCAD connector implicitly incorporates a change of a Design object, if it has a pending Design Change Ordner (DFCO) assigned. If no DFCO is assigned, this save option only performs a save with check in to the Design object, to which it is applied. Note: Un-incorporate actions can only be performed via the web client, not via the MCAD connector.

## Assigning Design File Change Orders

Design File Change Orders can be created and assigned using the *Assign Change* dialog of the MCAD connector. This dialog allows creating and assigning Item Change Orders as well.

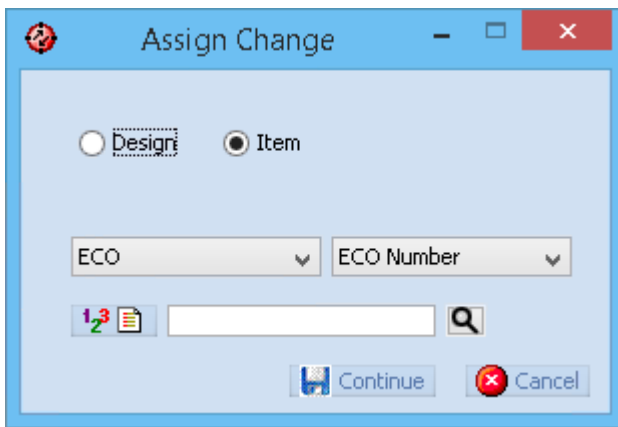

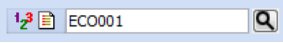
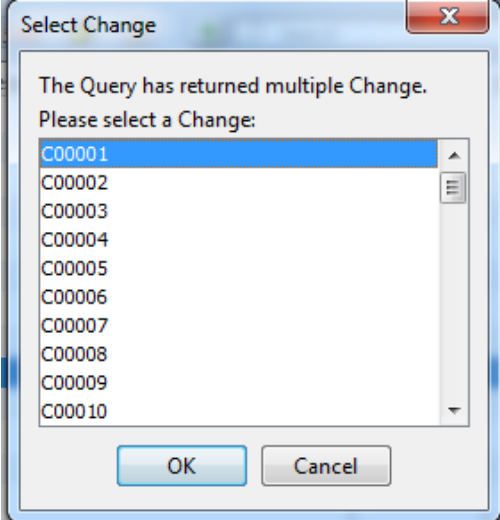


Figure 34: Assign Change Dialog

Table 32: Controls of the Assign Change Dialog

<p><b>Pull Change AutoNumber</b></p> 	<p>This button pulls a new number from the server using the default Change AutoNumber source. The number is displayed in the Current Part Change field. This Change can then be assigned to Parts using the <i>Assign Change</i> context menu command.</p>
--	--

<p><b>Current Change Number</b></p> 	<p>This field contains the current Change number. This number can be assigned to selected Parts using the <i>Assign Change</i> context menu command or reset using the <i>Select Change</i> context menu command. If a part gets attached to this change, the change is created in the default change subclass.</p> <p>If a number is entered manually to the change number field then the search button can be used to find matching changes in PLM. A search with wildcard (*) is supported. If more than one change is found in Agile, the user is prompted to select the appropriate one:</p>  <p>If only existing Change numbers are allowed in the system the connector can be configured to discard non-existing numbers. Refer to the <i>Administration Guide</i> on how to configure this verification in CAXConfig.xml.</p>
---	--

## Assigning File-Less Design Objects to Design Changes

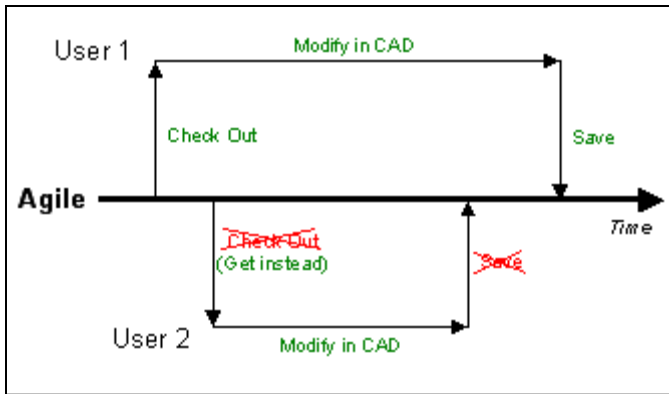
Design objects, which do not contain an actual CAD file (such as Creo or SolidWorks part family instances) cannot be assigned to a Design File Change Order. Only Design objects, which contain at least one actual CAD file in the *Files* tab, can be assigned. This is a limitation purported by Agile PLM.

## Concurrent Engineering

The EC Web Connector is specifically designed to support concurrent engineering, the ability for multiple designers to work on different portions of the same overall CAD Assembly at the same time. The most important consideration for concurrent engineering is that the ongoing changes by the designers be managed such that the files in the central repository (Agile) remain valid and up-

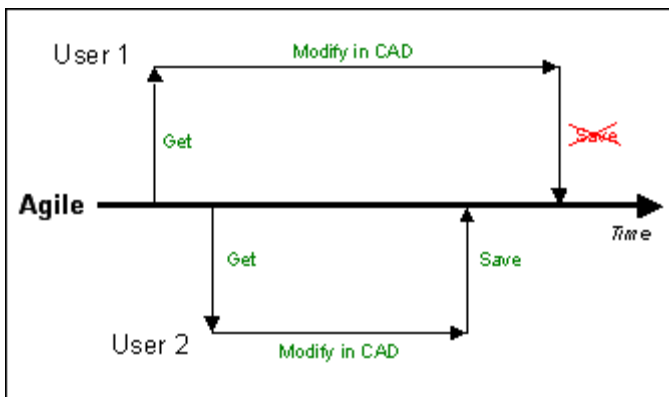
to-date.

The EC Web Connector makes use of two basic control mechanisms to manage concurrent engineering: *Check out* and *timestamp*. Check out is a reservation mechanism inside Agile that is used to prevent other users from saving changes to something you are changing. Timestamp is a mechanism that relies on a timestamp value stored on each Design object in Agile each time you save. If your timestamp is up-to-date, meaning that no one has made a change more recently than when you loaded the file, then you can save into Agile. The following diagrams illustrate the fundamental scenarios involving Check Out and Versioning.



**Figure 353: Scenario 1 – Check Out Reservation**

- User1 loads file from Agile using check out, and proceeds to modify in CAD.
- User2 attempts to load file from Agile using check out, but cannot since User1 already has it reserved. The file is loaded using *Get* instead.
- User2 modifies in CAD, then tries to save into Agile. Save is denied since User1 has checkout reservation
- User1 then tries to save, which is successful.



**Figure 364: Versioning**

- User1 loads file from Agile using *Get*, and proceeds to modify in CAD.
- User2 also loads file from Agile using *Get*, and proceeds to modify in CAD.
- User2 tries to save into Agile, which is successful (because there is no check out reservation)
- User1 then tries to save into Agile. Save is denied due to out-of-date version (file in Agile has been updated since User1 loaded it).

---

**Note** Both Check Out and Version status can be checked from the **Workspace Manager** dialog. If a name is listed in the **Checkout User** field, then the item is checked out. If the **Changed in Agile** column is flagged, the item is out-of-date.

**Note** All CAD files that are loaded from Agile into CAD are modifiable in the CAD system. That is, they are not loaded “Read-only”. The ability to modify the files in CAD, does not necessarily mean that you have the privileges to save into Agile.

---

A preferences setting called **Check Out During Save** determines how the check out and version mechanisms are used to control concurrent engineering for your site. Mainly it affects the conditions under which saving is allowed. If this option is set to *Force User Check Out*, then it is required to have check out reservation set for any Design that is to be saved. If it is set to *Automated Check Out*, then Designs can be saved and if not previously checked out, they are automatically checked out prior to saving.

For most companies the use of *Force User Check Out* is recommended, in order to insure that users are aware when other users are working on models. In addition, it is recommended to set the check out on the Design as early as possible, either when using the Load command or by using the Workspace Manager during your CAD design modification.

**Table 33: Agile Save Option**

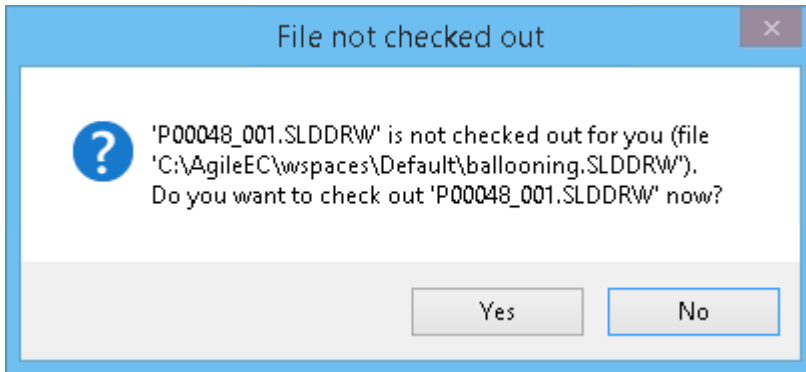
Checkout Status	Value of Save Option	
	Automated Checkout	Force User Checkout
Checked out by someone else	Do not allow Save	Do not allow Save
Not checked out, and out-of-date	Allow Save	Do not allow Save
Not checked out, but up-to-date	Allow Save	Do not allow Save
Checked out by current user	Allow Save	Allow Save

## Design File Release Process

To support Agile PLM's Design File Release Process, this MCAD release allows users to create and assign Design File Change Order objects in the MCAD dialogs. Design and Item Change Orders are assigned via the new Assign Change dialog of MCAD. This dialog replaces the previously existing Change assignment functionality. For details, refer chapter *Assigning Design File Change Orders*.

## Strict CAD Modification Workflow

The MCAD connectors for SolidWorks and Solid Edge can be configured to enforce a strict modification workflow. This workflow setting does not allow users to modify PLM-known CAD files, unless they have them checked out in Agile.



**Figure 37:** Example of an error message indicating that users do not have write access

If you should encounter the error message shown above, check out the Agile object corresponding to the CAD file you attempted to modify to gain write access.

## Known Issue for Solid Edge

Setting or removing the “read only” flag for a Solid Edge file works on file system level, but the GUI of Solid Edge does not immediately reflect the change. This means, that whenever a file transitions to or from the read-only status, users need to either re-open the file in question in Solid Edge, or switch to another file currently open in the CAD system and then back to the file previously worked on in order to correctly update the status of Solid Edge's GUI. This is a limitation of Solid Edge.

## BOM Publishing

## Introduction

BOM Publishing, using the *Agile* → *Save* command, is used to create or update Agile Product Structures based on CAD Design Structures. The Product Structure, or “Part BOM”, is the definition of your product that is passed to manufacturing. Since in many cases this structure closely resembles the structure of your CAD design, the BOM Publishing step can leverage this to decrease effort and increase accuracy.

## Overview of the BOM Publishing Process

The overall BOM Publishing process has four main steps, which are illustrated below. The first three steps can all be managed within only one save command depending on the preferences settings for the publish and part creation behavior. (See the *Item and Publish Preferences* section for details)

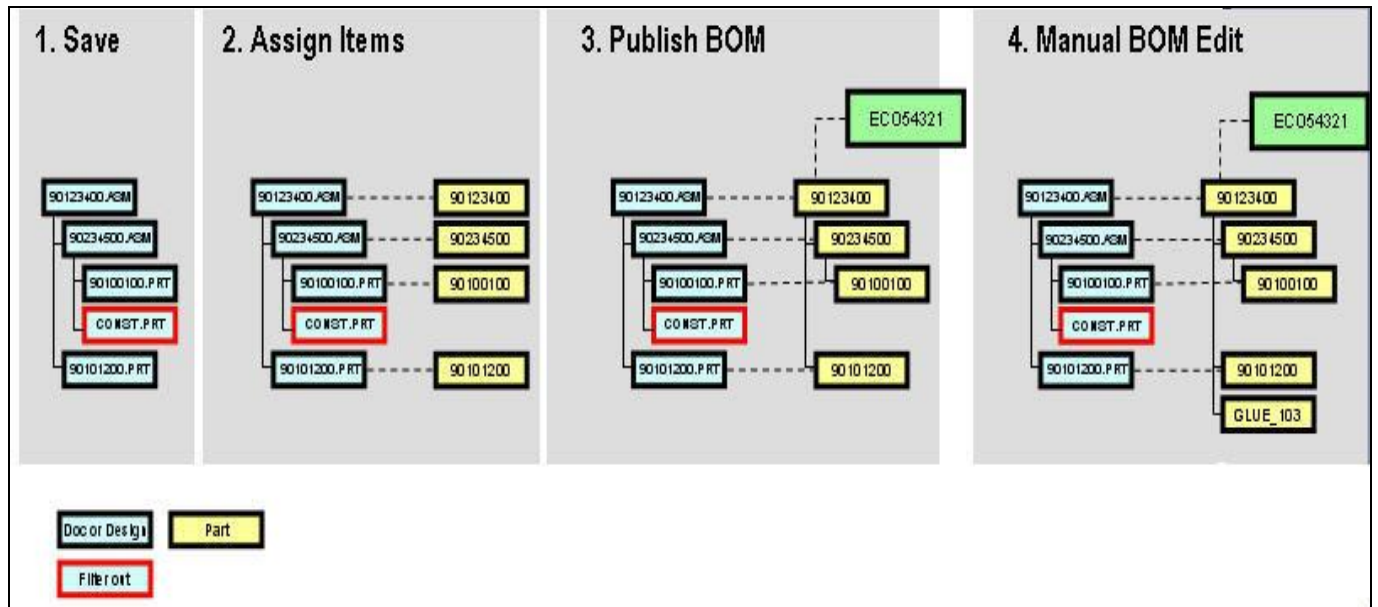


Figure 385: The BOM Publishing Process

Table 34: Bom Publishing Options

<p>Save</p>	<p>This step saves the Design structure into Agile PLM, using the <i>Agile</i> → <i>Save</i> command.</p>
-------------	---

<p><b>Assign Items</b></p>	<p>This step links each Design object to a corresponding item (typically a Part class object). This linking is done based on the type of mapping defined in your EC environment. For example, if your Design object is named “90123400.ASM” you may have a mapping defined to link this Design to a Part named “90123400” (as shown above). Alternatively, the Part number may be defined as a CAD property value, or simply a PLM AutoNumber. In any case, if the target Part number already exists, then the Assign function simply links the Design to this existing Part. If it does not exist, it creates it. The linking operation is accomplished using the Agile PLM <i>Relationships</i> tab, and the link applies across all Design versions and Part revisions. It is simply expressing that <i>this Part is related to that Design</i>.</p>
<p><b>Publish BOM</b></p>	<p>This step actually creates or updates the BOM structure for all the assigned Items, based on the corresponding Design structure. Additionally, it attaches specific Design file types to the Item, as configured by your administrator.</p>
<p><b>Manual BOM Edit</b></p>	<p>This step does not occur within the EC Web Connector. If necessary, manual BOM edits can be made using the normal Redline BOM capability in Agile PLM. Manual BOM edits are tracked independently and do not change upon subsequent BOM publish updates.</p>

## Using the Save Command with Publish Options

When you execute the *Agile* → *Save* command, the EC Web Connector pops forward, and displays a dialog similar to the Save dialog, as shown in the figure below. The *Item assignments* view inside the Save Preview displays the detailed information, which items are assigned, and which change order is active.

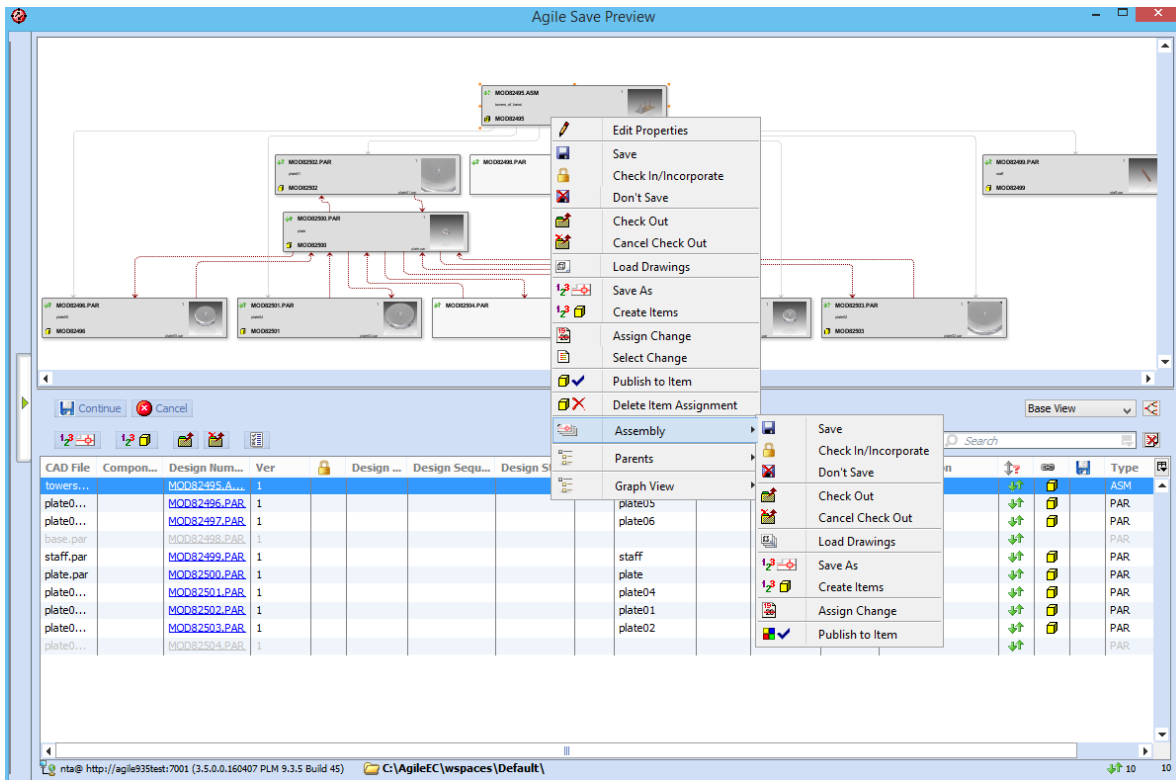


Figure 56: Save Dialog

From this starting point the user can execute the Assign function for all Designs using the *Assembly* → *Create Parts* button on the top level object, or for specific selected Designs using the *Create Parts* command on the context menu. During the assignment process, the user has the ability to interactively input Item attributes by double-clicking a node or row in the table (see figure below). After a Design object has been assigned, an icon appears in the *Assigned* column, and the Item number and other attribute information appear in the dialog.

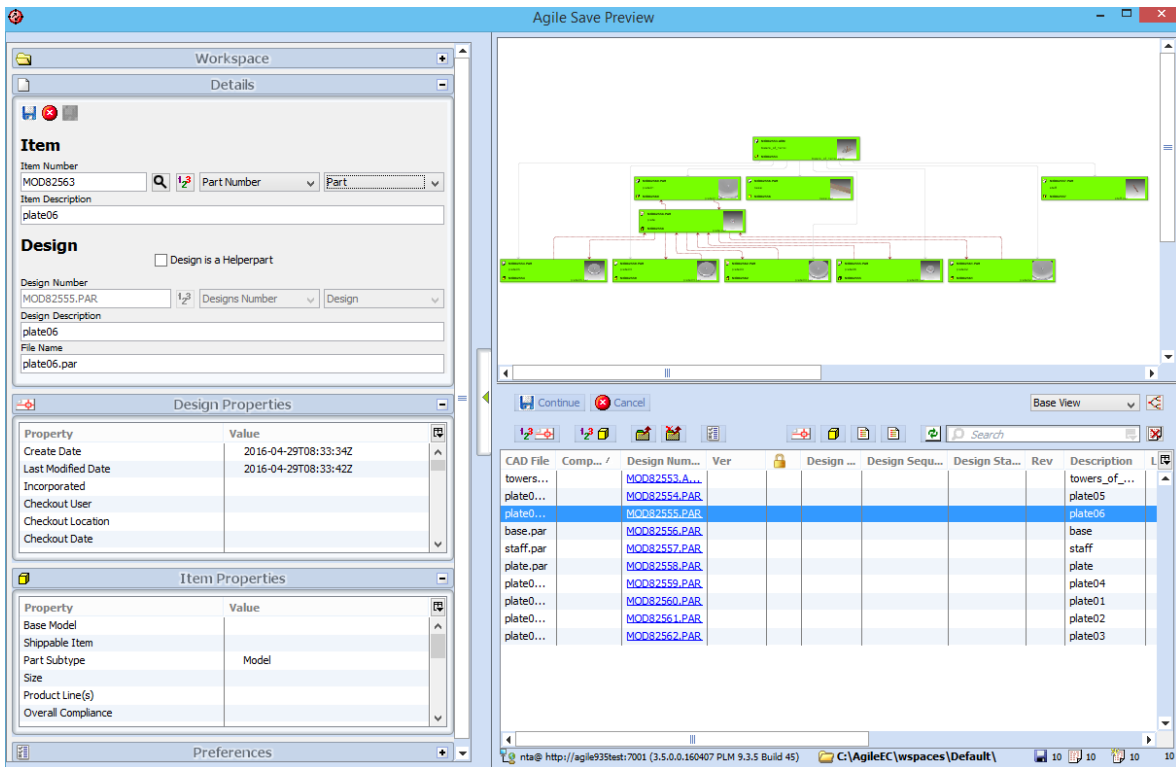
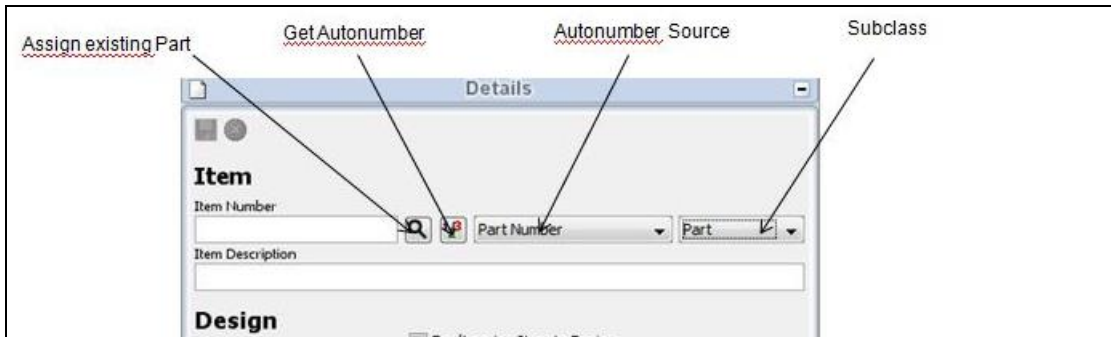


Figure 57: Assign Process

Once the assign process is finished, the user can use the *Save* button to complete the process. The Assign process can be automated during *Save As*, if the *Save As* preference is set to *Part and Design* and the *Part Creation* preference is set to *Create and Link*. Then the manual assignment step can be overridden.

Please refer to the *Save Section* in this manual for more information about the context menus and displayed tables.

Details of the interactive Create Part dialog are shown below.



**Figure 398: Interactive Create Part Dialog**

**Table 35: Interactive Create Part Dialog**

Number	The value that becomes the Number assigned to the Agile Part that is being created.
Description	The value that becomes the Description assigned to the Agile Part that is being created.
Filename	The CAD filename belonging to the Design, related to the Part being created.
AutoNumber Button	If you click the button, it puts the next available AutoNumber from the selected sub-class and AutoNumber, into the Number field.
Part sub-class	Selector that allows you to pick the Part sub-class to use for creating this Part in Agile. This is for overriding the default value set in the main Save dialog.
Part AutoNumber	Selector for the AutoNumber to use for creating this Part in Agile.
Property / Value Area	This area displays, and allows editing, for other properties that are being set from CAD into Agile. Properties can be either text or list values. Text values are simply typed in, while list values are selected from a list.

**Note** Your site most likely has pre-defined mappings for Number, Description, and other properties. You should check with your administrator to understand the allowable values to use. Also, these properties can be set as “Required”, meaning that you must enter a value before exiting the dialog.

## Details of the BOM Publishing Process

The following diagrams explain in detail how the data structures in PLM evolve as you go through the Save process with BOM Publishing enabled. It is important to understand the difference between 3D and 2D Designs, and how they are used to publish the BOM.

As a starting point, this diagram shows a typical Design structure containing both 3D and 2D files. Note that the 2D drawing objects are stored as parent objects of the corresponding 3D object, and that both 3D and 2D Designs can contain native and viewable file types.

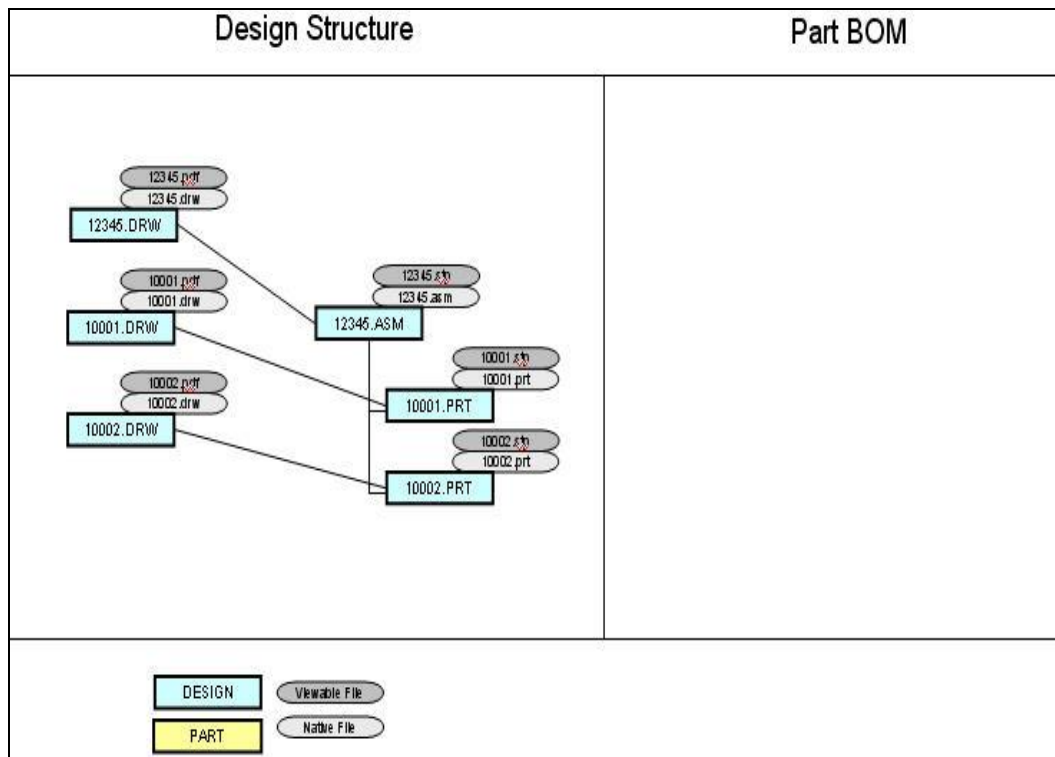
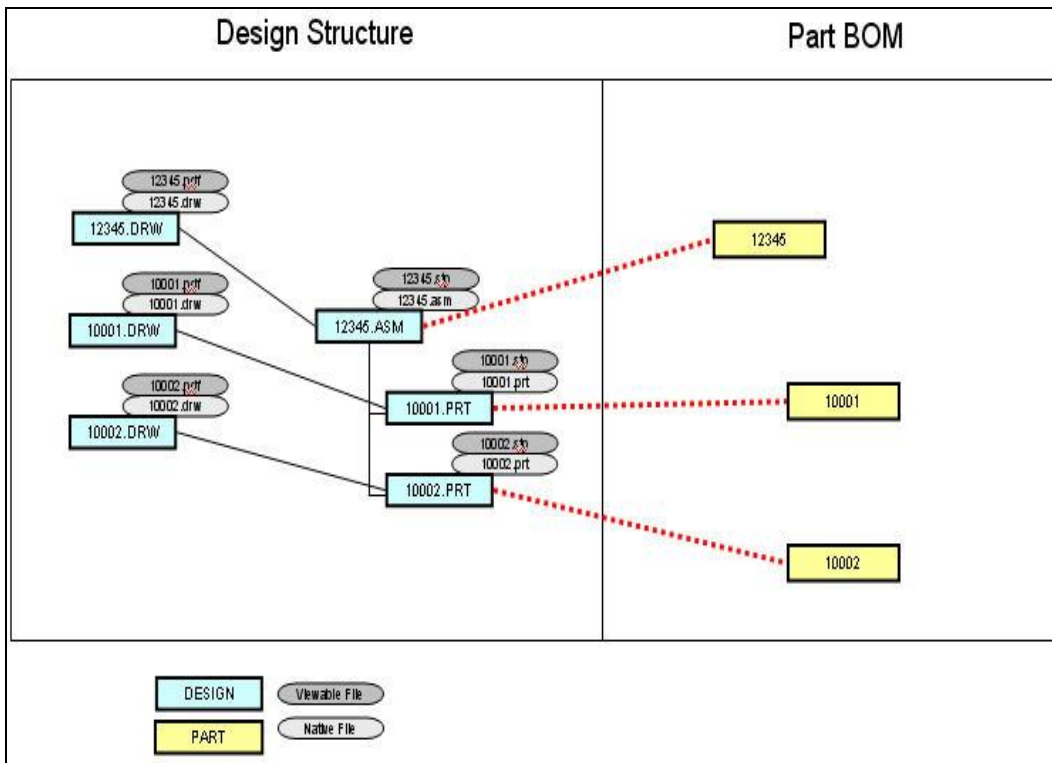


Figure 59: Details of BOM Publishing Process – Step 1

The next step is the assignment between the Design and the Part. It is important to recognize that the structure driving the BOM Publishing process on the Design side is the **3D structure**. This is because the 3D structure mimics in CAD the actual physical product. After the assignment process, the 3D Design is linked to the corresponding Part by a PLM Relationship. Note that at this time there is no BOM structure between the Parts (unless it existed already).



**Figure 60: Details of BOM Publishing Process – Step 2**

After the assignment, the next step is to publish. Not only does this create or update the BOM structure between the Parts, but it can also attach files from the Design objects to the Parts, depending on your preference settings. Note that files from the assigned 3D Design plus those from that object’s 2D Designs can be attached. This provides a powerful method to collect the necessary CAD files into the Part objects that are viewed throughout the organization.

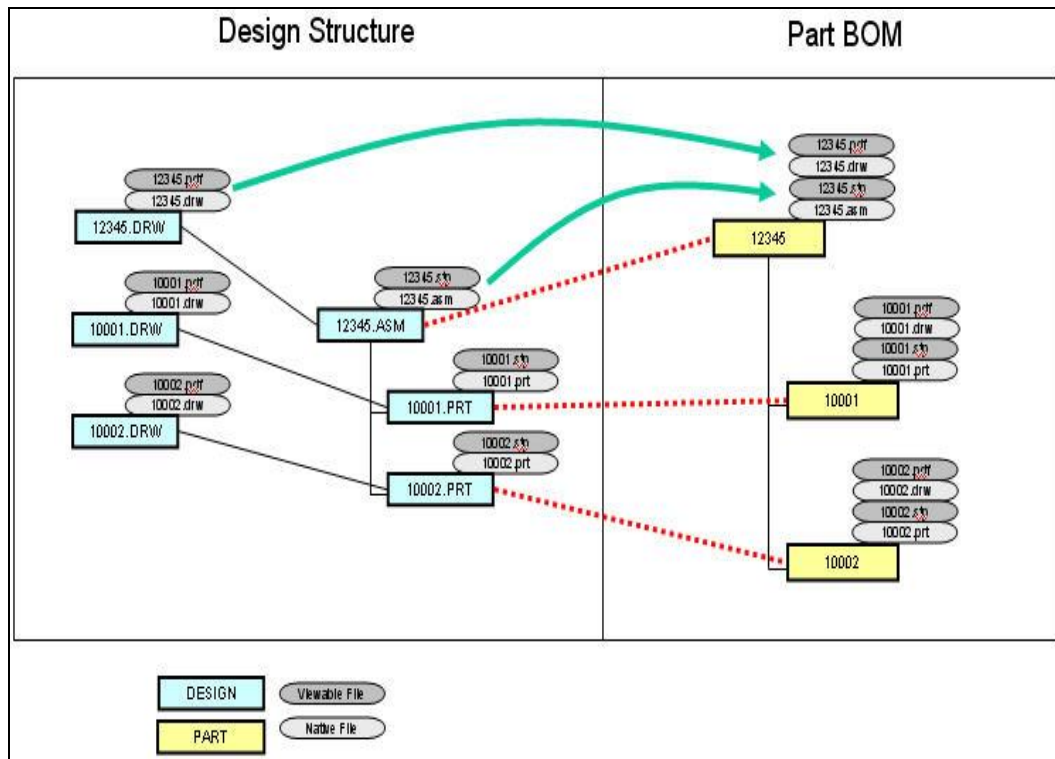


Figure 61: Details of BOM Publishing Process – Step 3

## Configurations and Family Tables

Pro/E has special capabilities for dealing with families of parts. In each case, the EC Web Connector creates correct BOM structures. Family table generics and instances are both maintained within the design structure. When using the publishing options within the Save command, a unique part is generated for each instance or generic that is directly referenced within an Assembly. No special parameter definition is required.

## Change Process For Parts

The Save command provides access to the ECO change process for Parts. While the process can be initiated from the EC Web Connector, most of the workflow takes place using the standard Agile Web Client.

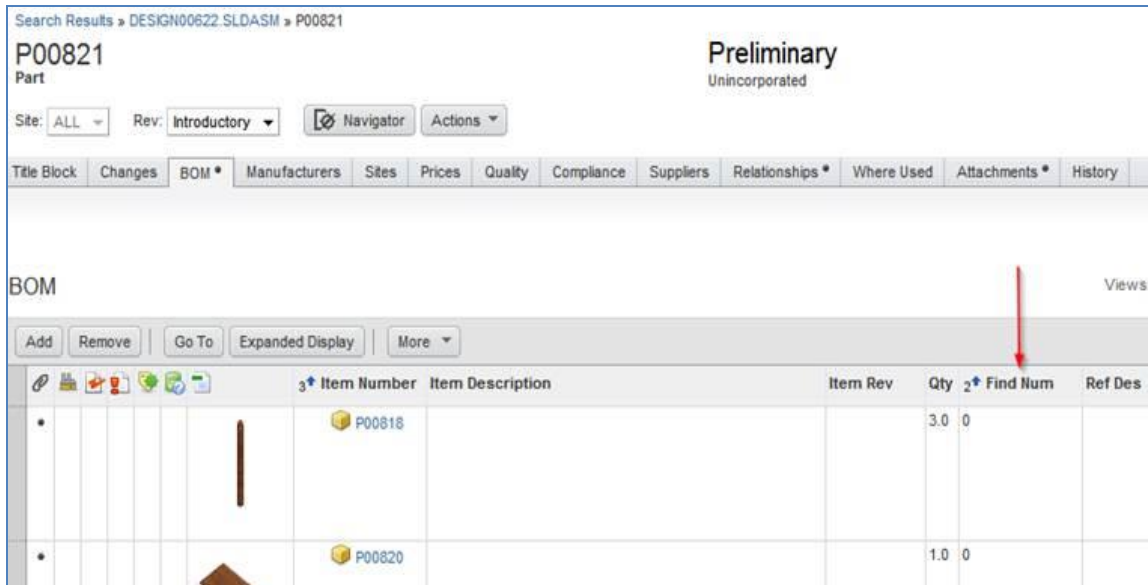
## Mapping Find Numbers to the PLM BOM

BOM find numbers are numbers assigned to BOM components in a BOM table visible in a CAD drawing.

This feature is only available for *SolidWorks*, *Creo Parametric* and *Solid Edge* and only within the

drawing context.

Find numbers can be transferred from CAD to the PLM using the “Transfer BOM find number” button from the main menu. The find numbers is available in the Agile client within the “Find Num” column under the “BOM” tab. It is only possible to run the find number transfer from CAD to PLM not the other way round.



**Figure 402: Find Number column**

Assuming that you already have a drawing with the corresponding BOM and it has already been saved into Agile with a Design and Item number. You can change the find number of each component in the BOM table if a CAD drawing and then transfer the data to PLM very easily. The first step is making double click on the number of the component in the BOM column in the CAD drawing that you want to change.<sup>1</sup> Make the change. Then, in order to transfer data from the CAD to PLM you should press “Transfer BOM find number” button from the main menu and follow the steps in the preceding paragraph.

Note: When you make a change, you should be careful that there is no space around the number, because the Agile client would not read this data correctly.

Note for Creo Parametric: Unlike the other CAD systems, after having activated the the “Transfer BOM find number” function, a suitable BOM table needs to be selected on the drawing from

<sup>1</sup> If you are working with Solid Works, an alert message box could appear saying “this cell value is parametrically linked to a part document..”, press “X” and close it).

which the MCAD connector populates the find numbers. There is a number of configurations that need to be adjusted based on the actual BOM table layout. For details, refer to the administration guide, *Creo Parametric Connector Administration* → *Transfer BOM Find Number Functionality* chapter.

Find numbers can not be transferred only by using a save function. The following restrictions apply:

- Only allow one BOM table on the drawing and do not support multiple BOM Tables (does not apply for Creo).
- Only allow views to ONE model, this includes part families/configurations (does not apply for Creo).
- Drawing must be PLM known.
- The BOM which is updated with the find numbers is the BOM displayed in the BOM tab of the drawing's model. This is the BOM tab, which is updated by the "Publish to Item" function.

## Toolbox and Library Parts (ACW and ACE Only)

Since release 3.6, the MCAD connector for SOLIDWORKS supports the *Design Library Toolbox*. CAD engineers can now use toolbox parts in SOLIDWORKS transparently.



**Figure 41: Design Library workspace in SOLIDWORKS**

Since release 3.6.2 this feature is also available for Solid Edge.

The MCAD connector takes care of saving and loading the parts to and from Agile. In order to optimize the workflow, the behavior regarding toolbox parts is different compared to non-toolbox components:

- Toolbox parts are not implicitly pre-selected for saving.
- No renaming (rename on load, rename on save) is applied to toolbox parts.
- No viewables are created for toolbox parts if viewable creation is active.

## Property Mapping

### Introduction

Properties (also known as parameters, attributes or metadata) are information stored as text strings that are associated with CAD data. Examples are part number, description, and author. The EC Web Connector supports bi-directional transfer of properties between CAD and Agile. In other words, you can enter a property in CAD and have it be put into Agile, or vice versa. Properties are useful in the definition and classification of your design data, and are also useful for searching. The specific mapping of properties at your site is defined in the configuration file by your system administrator.

### Types of Mapping

Multiple types of mappings are supported by the CAD Connectors. When mapping from CAD to Agile, there are two types of properties that can be mapped – system properties and user properties. System properties are not directly defined by the user, they are things like the filename and the CAD software version number, which can be saved as properties in Agile. User Properties are defined by the user with the following commands:

*Pro/E: Tools → Parameters*

*CATIA V5: Tools → Formula*

Property mapping supports the following types of Agile attributes:

Text, MultiText, List, and MultiList.

System properties and user properties are mapped into Agile Designs and Parts as part of the *Save* command.

Mapping from Agile into CAD is done using the *Update Properties* command. It can also be configured to occur automatically during the *Save* process. Properties from both the CAD Design

and the associated Part object can be mapped into CAD.

When working with drawings, there is another available command called *Update Title Block*. This updates properties just for the current drawing, not all subordinate models. In order to use properties within a Title Block, you need to define the text notes to be linked to properties, either within the drawing or within the part or assembly referenced on the drawing. This is standard CAD functionality. Figure below shows an example of properties used in notes within a Title Block.

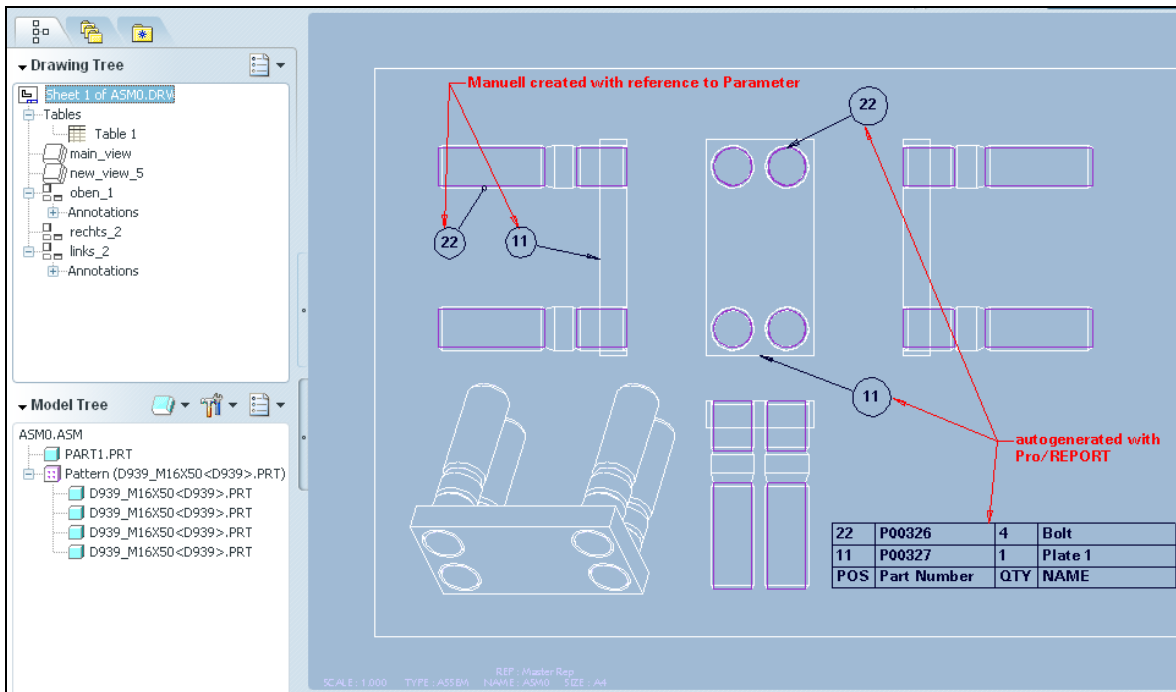
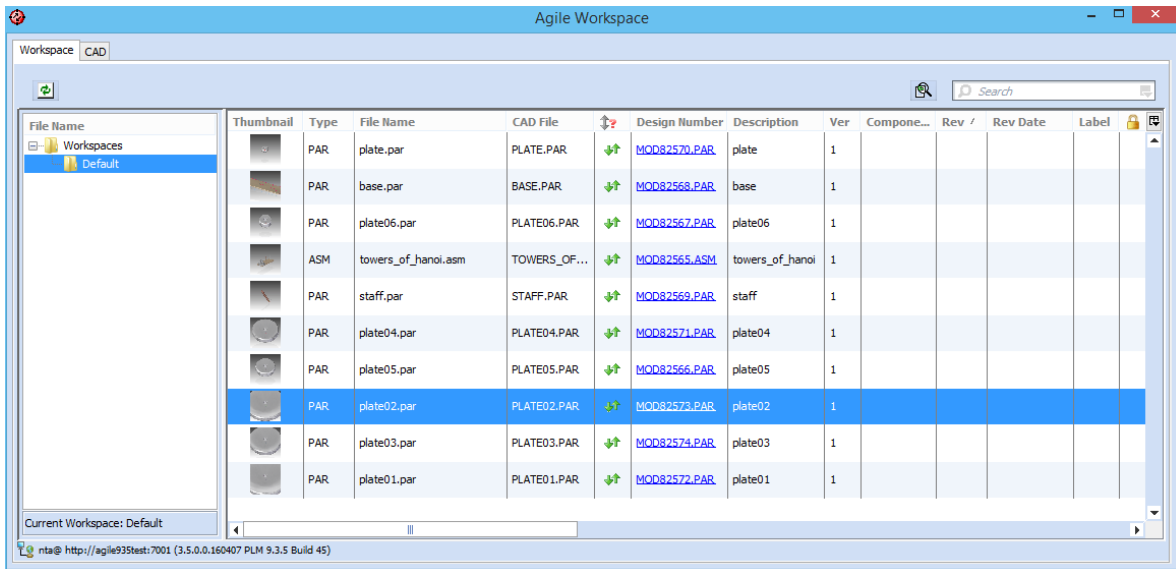


Figure 63: Properties used in Title Block

## CAD Thumbnail Support

Inside the webcomponents thumbnails are extracted from the CAD native file. The CAD systems store thumbnail views into the CAD binary data that are extracted using the same routines like the Windows Explorer is using. The minimum requirement is a Windows 7 or higher system. On Windows XP thumbnails aren't supported.

EC is not generating the thumbnail content. The dialogs extract the thumbnail from the CAD file. The thumbnail content is provided by the CAD vendors. Please refer to the documentation of your CAD tool how to enable thumbnail generation in the CAD files. Some CAD tools like Pro/E need additional viewing components installed or enabled (SolidWorks settings) on the local CAD client machine to provide this feature. The connector extracts the same thumbnail as you can see in the thumbnail view inside the Windows Explorer.



**Figure 424: Properties used in Title Block**

The thumbnails are held locally only and are shown inside the WorkspaceManager in small icons. A bigger flyout is shown on the small icon, on a node in the browser views or on the filename columns in the table views. In the Load Preview the thumbnail from PLM is downloaded if no local thumbnail is available. In all other dialogs only thumbnails generated locally are used.

Note: Please contact your system administrator how to setup the system to transfer the CAD thumbnails into PLM.

## Thumbnails for Part and Assembly Families/Configurations

As mentioned in the previous chapter, the content of the thumbnails used by MCAD is extracted from the thumbnail content provided by Windows, which is in turn defined by the CAD system. Due to differences between the data model of MCAD and the data model of the CAD systems, it may happen that thumbnails for part family, assembly family and configurations features are not adequately displayed in the MCAD dialogs. For part family, assembly family and configurations derived from *one* CAD file, as this is the case e. g. for *SolidWorks Configurations*, the thumbnails for *each* Design object of the part family, assembly family or configuration are derived from the instance currently active in the CAD file. This means, that the thumbnails are equal for all Design objects of the part family, assembly family or configuration and that the thumbnail only reflects the geometry of one of those objects.

## CAD specific Functionality

Some CAD Connector functionality is specific to certain connectors, because of unique capabilities in certain CAD tools. This section provides details on those specific functions.

### Callback/User Exits in CAD Menu -> Save As – Solid Edge

In CAD using the native “save as” function results in a new EC dialog box, where the user may chose between the native CAD “save as” and the EC Save As, where a PLM known Object is “copied” and referenced with a new PLM Design number. This PLM number is drawn or manually inserted in that dialog box. This function is similar to the “save as” function in the EC save preview (see chapter

Using the Save Command on page 17).

## Handling of Part Families and Configurations

Companies working with Pro/E or Solid Works use configurations and part families. Especially in Pro/E and in Solid Works there is no real file for configurations. The configurations can only change if the master file (Generic) is touched and modified. The selection logic inside the EC dialogs is like this:

The selection between the generic and the instances or configurations is transparent.

- If a Generic is **selected**, all instances in session are also **selected**.
- If a Generic is **deselected**, all instances are also **deselected**.
- If an Instance is **selected**, the related Generic is also **selected**.
- If an Instance is **deselected**, the related Generic is **NOT deselected**.

## Numbering of Part Families and Configurations

By default, the EC connectors treat configurations as regular files, so each configuration gets a unique number assigned in PLM. The numbers do not have to match between the generic and the instances from the PLM point of view.

Optionally, number of instances can derive from the generic number by adding a suffix. EC offers two options controlled by the switch FamilyInstanceNumbering in **CAXConfig.xml**:

- **GENERIC\_INDEX** – appends a counter to the generic number
- **GENERIC\_CONFIG** – appends the configuration name to the generic number

The resulting instance number is cut to 50 chars and any special characters are removed.

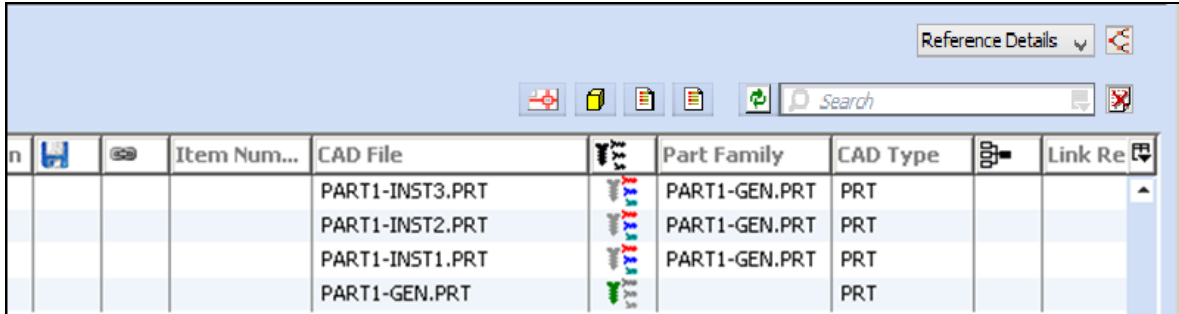
## Family Table Handling – Creo Parametric

### Introduction

Creo Parametric contains specialized functionality to manage families of parts and assemblies. This is called “Family Tables” in Creo Parametric. The Agile CAD Connectors for these two tools provide additional functionality within the EC Web Connector to display and manage part family information.

## EC Web Connector User Interface (Design)

In all main EC Web Connector dialogs – Save and LoadPreview, additional columns display the part family information in the *Reference Details View*. See Figure 3-3 for an example showing the Save dialog. If no family table parts are contained within the current CAD model, then the extra columns are not even displayed.



Item Num...	CAD File	Model Type	Part Family	CAD Type	Link Re
	PART1-INST3.PRT	[Instance Icon]	PART1-GEN.PRT	PRT	
	PART1-INST2.PRT	[Instance Icon]	PART1-GEN.PRT	PRT	
	PART1-INST1.PRT	[Instance Icon]	PART1-GEN.PRT	PRT	
	PART1-GEN.PRT	[Generic Icon]		PRT	

**Figure 65: Part Family Columns**

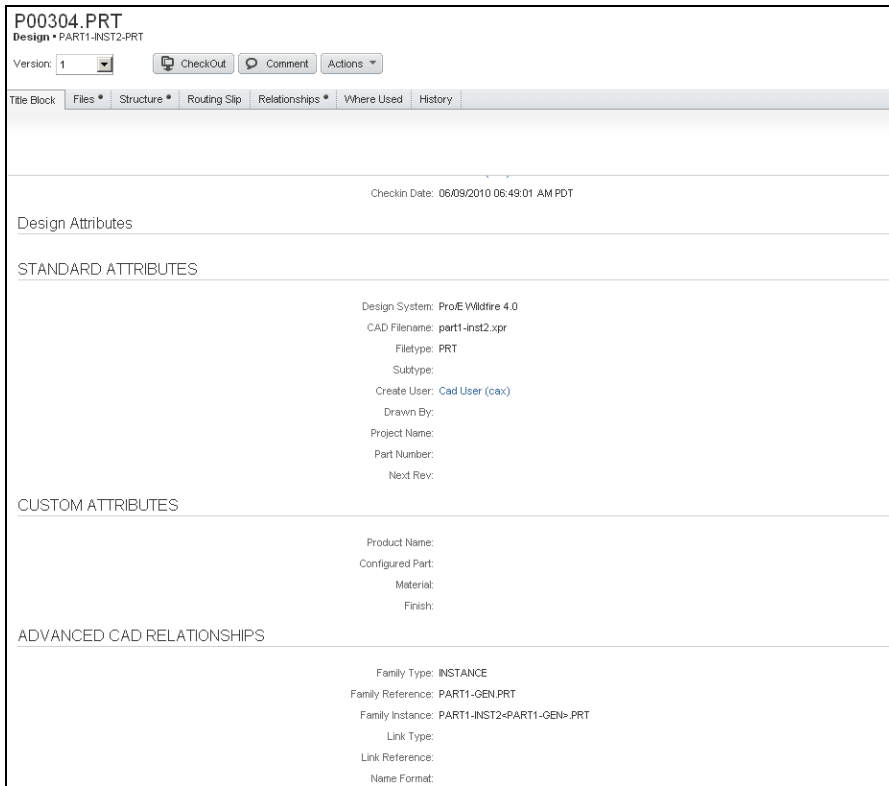
The additional columns are:

- *Model Type* – An icon column, where the icon indicates either an instance or a generic.
- *Part Family* – Lists filename of the Generic model.

A Generic is indicated by the *Generic* icon in the *Model Type* column, and nothing in the *Family Reference* column.

An Instance is indicated by the *Instance* icon in the *Model Type* column, and the Design number and filename of its corresponding Generic in the *Family Reference* column.

The information shown in these columns is also shown on the form of each object in the EC Web Connector, such as the *CAD Model Type* and *CAD Model Reference* shown in figure below (note that this form looks somewhat different in each customer environment). You can use these attributes to perform searches, for example, on instances or generics.



**Figure 66: CAD Model Type - CAD Model Reference**

The relationship between Generic and Instances is highlighted in the browser view with green dashed lines and special end nodes. Besides this, the Part Family indicators are displayed in the nodes and in the References list view.

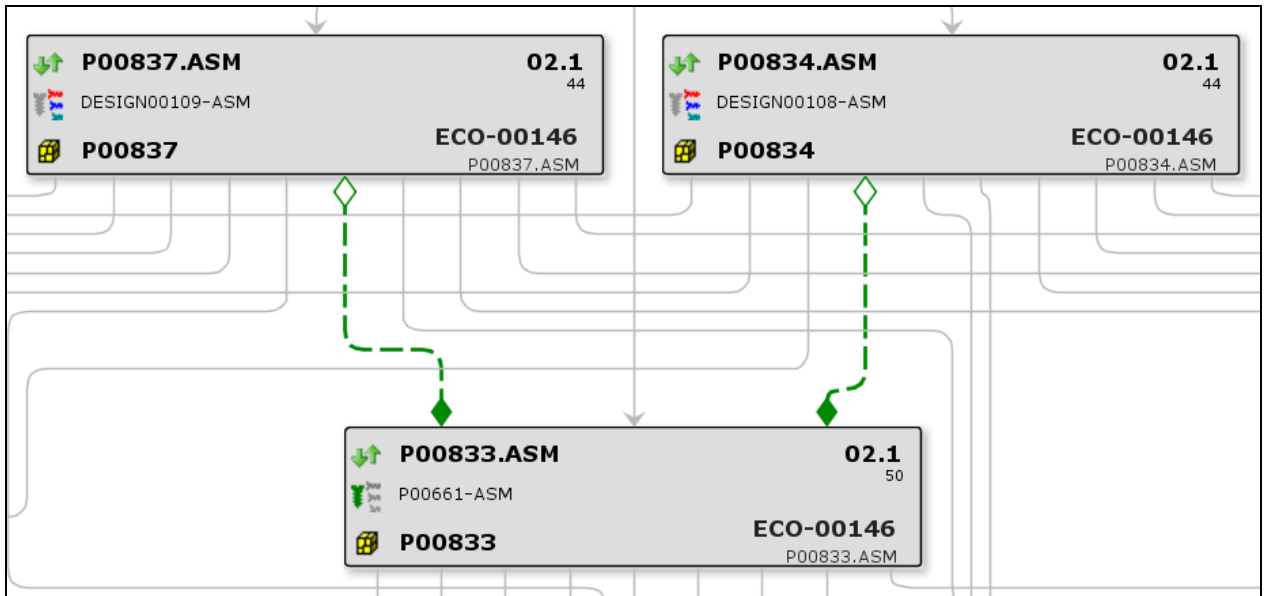


Figure 43: Family Table Relationships: Generic (bottom) and its two instances (top)

### "Save Family Table" Command

In the Agile menu within the CAD tool, there is a command called Save Family Table, which allows you to save an entire part family at once into Agile. It brings up the Save dialog containing the generic and all instances of a part family. In order to use this function, you must have a part family generic part or assembly active in your CAD session. This command allows the user to save or update all instances of a part family, including the generic all at once.

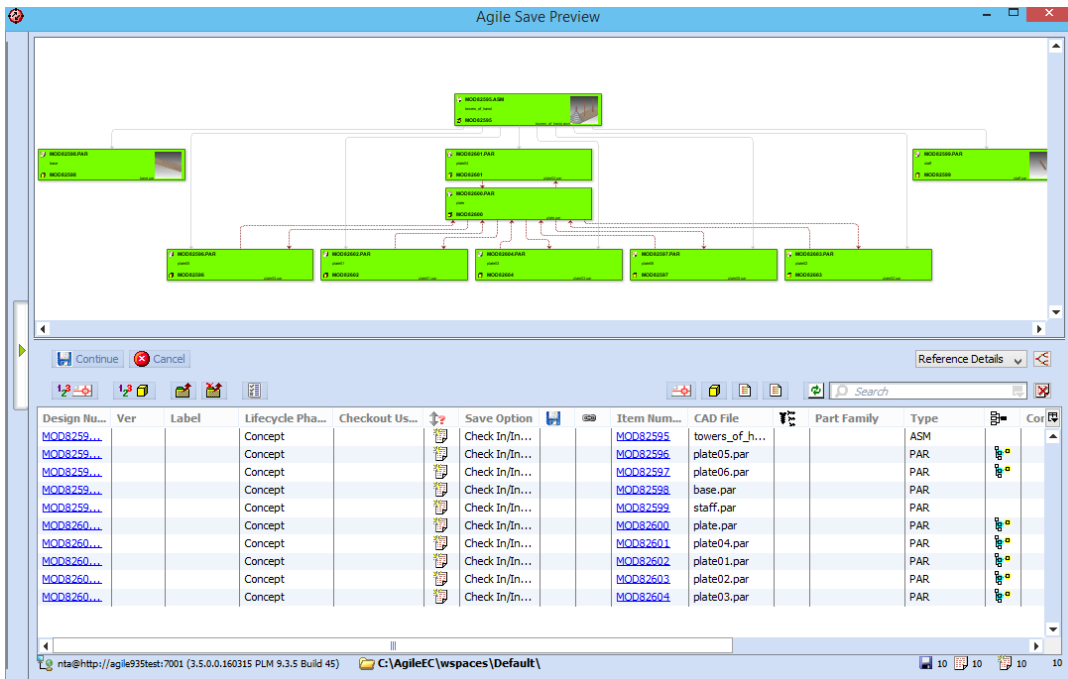


Figure 44: Save Family Table

When using Creo Parametric, this command also validates each instance and prompts you if there is an error with any of the instances. If there are any errors, the following dialog appears, and allows you to view the log file of errors (which is also stored in your log directory for further access). If you choose to continue, the contents of the Save CAD dialog contains only the properly validated instances.

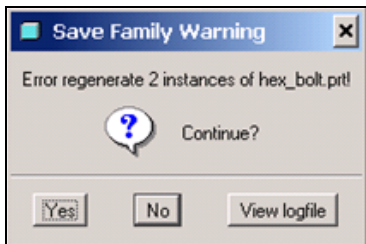


Figure 6945: Save Family Warning

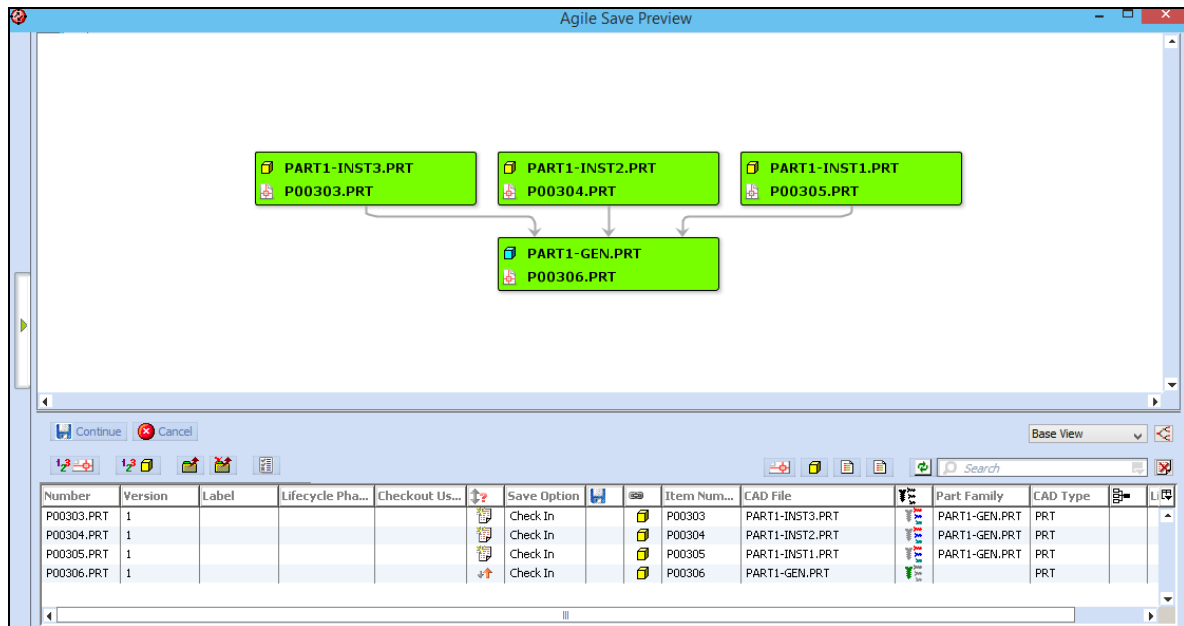
## External Reference Handling – Creo Parametric

### Introduction

Creo Parametric contains specialized functionality to manage external references such as copy geometry, publish geometry, merge/inheritance and shrinkwrap. The Agile CAD Connectors provide additional functionality within the MCAD connector to display and manage external reference information.

### EC Web Connector User Interface

In the EC Web Connector dialogs – Save and Load Preview, additional columns display in the *Reference Details View*. See the example below for an example showing the Save Preview dialog. If no external references are contained within the current CAD model, the extra columns are empty.



**Figure 70: External References (Save Preview)**

The columns are:

- Link Type – An icon column, the icon indicates that the file either contains reference geometry or is the referenced geometry.
- Link References – Lists the name(s) of the referenced model(s).

The information shown in these columns is also shown on the form of each object in the MCAD connector. You can use these attributes to perform searches, for example on merge reference

parts.

External references stored in Agile are fully supported in the Load process.

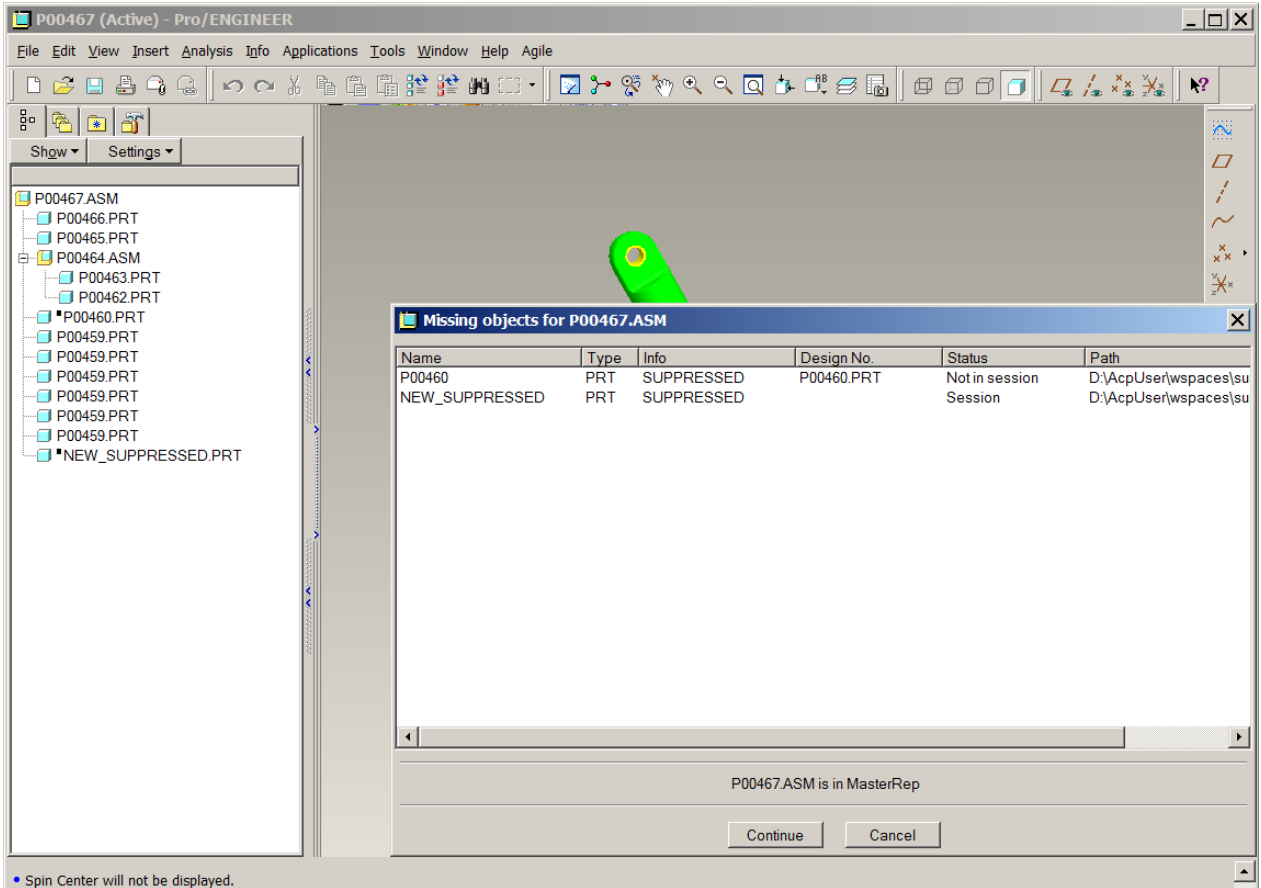
Load commands checkout the additional files. For automated loading the reference files in the Creo Parametric session you have to set the two config.pro settings:

RETRIEVE\_MERGE\_REF\_PARTS YES

RETRIEVE\_DATA\_SHARING\_REF\_PARTS YES

## Support for Suppressed Components – Creo Parametric

The Creo Parametric connector is extended to handle suppressed components when saving. Before saving the connector scans the structure of the current object and detects suppressed components. If suppressed components are found, an information dialog is shown.



**Figure 461: Suppressed Components**

If a suppressed component is found in PLM, it is not shown in the Save Preview. If a suppressed component is not found in PLM and it is in session, it is shown in the Save Preview and handled like an active component.

---

**Note** ATTENTION: Components not found in PLM and not in session, cannot be handled!

---

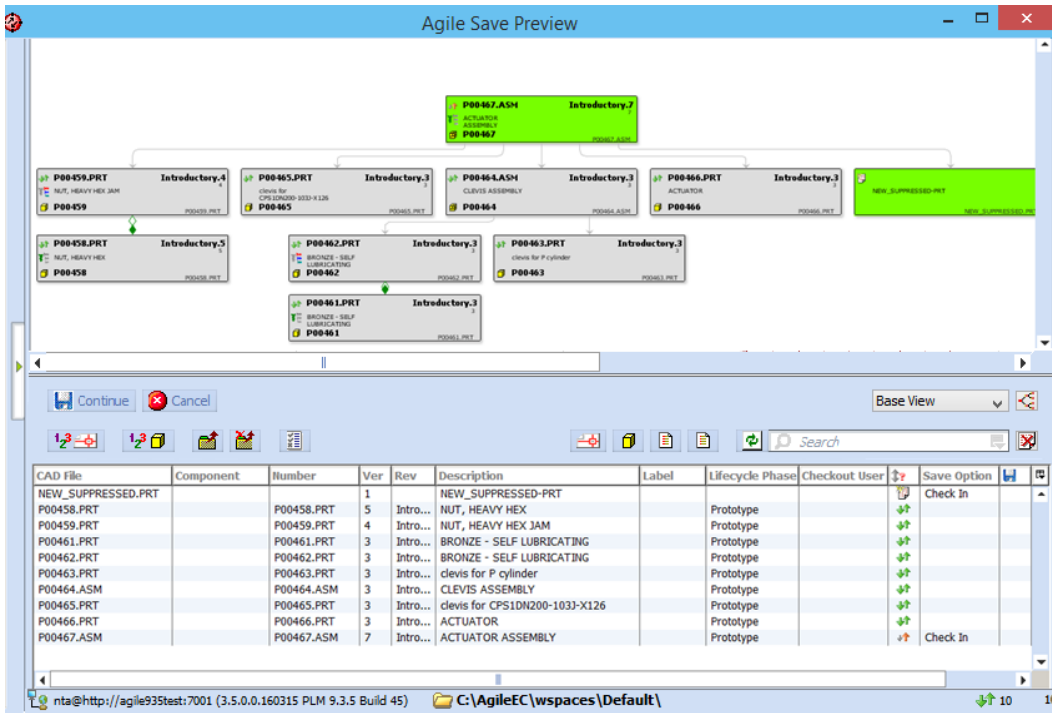


Figure 47: Save Preview: With suppressed elements

Suppressed components with a PLM Design number are built into the Design structure with a special identifier “CAX-PROE-SUP” and component information “SUPPRESSED”.

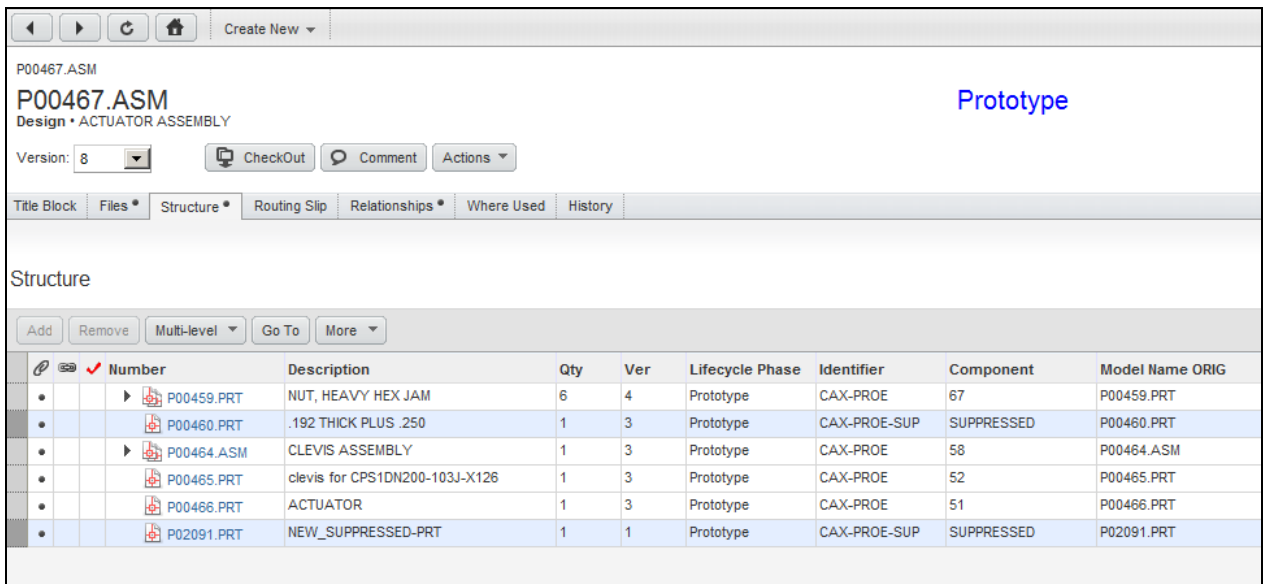


Figure 483: PLM View: With suppressed Components

Suppressed components are NOT BOM relevant and therefore filtered from the Item BOM during publish.

P00467.ASM » P00467

**P00467**  
Part • ACTUATOR ASSEMBLY

**Preliminary**  
Unincorporated

Site: ALL Rev: Introductory Navigator Actions

Title Block Changes BOM \* AML Sites Prices Quality Compliance Suppliers Relationships \* Where Used Attachments \* History

Your changes have been successfully saved.

**BOM**

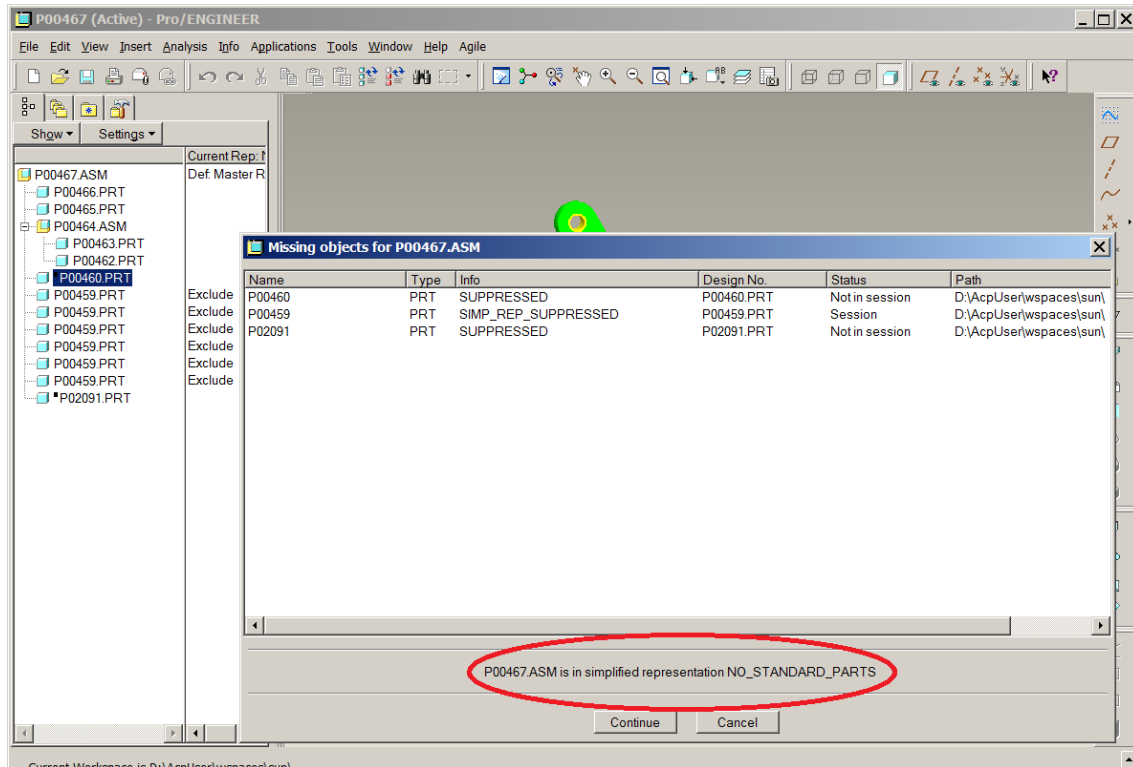
Add Remove Go To Expanded Display More

2* FN	3* Number	Description	Qty	UOM	Item Type	Rev	CADRelationship	CAD Filename	CAD Comp
10	• P00459	NUT, HEAVY HEX JAM	6.0	EA	Part		CAX-BOM	P00459.PRT	67
20	• P00464	CLEVIS ASSEMBLY	1.0	EA	Part		CAX-BOM	P00464.ASM	58
30	• P00465	clevis for CPS1DN200-103J-X126	1.0	EA	Part		CAX-BOM	P00465.PRT	52
40	• P00466	ACTUATOR	1.0	EA	Part		CAX-BOM	P00466.PRT	51

**Figure 494: PLM View: BOM: With suppressed Components**

## Simplified Representations – Creo Parametric

The handling of components suppressed by a simplified representation is similar to the handling of suppressed components. In addition, the information dialog shows the current simplified representation.



**Figure 505: Simplified Representation**

If a component suppressed by a simplified representation is found in PLM, it is not shown in the Save Preview. If a component suppressed by a simplified representation is not found in PLM and it is in session, it is shown in the Save Preview and handled like an active component.

**Note** ATTENTION: Components suppressed by a simplified representation not found in PLM and not in session, cannot be handled!

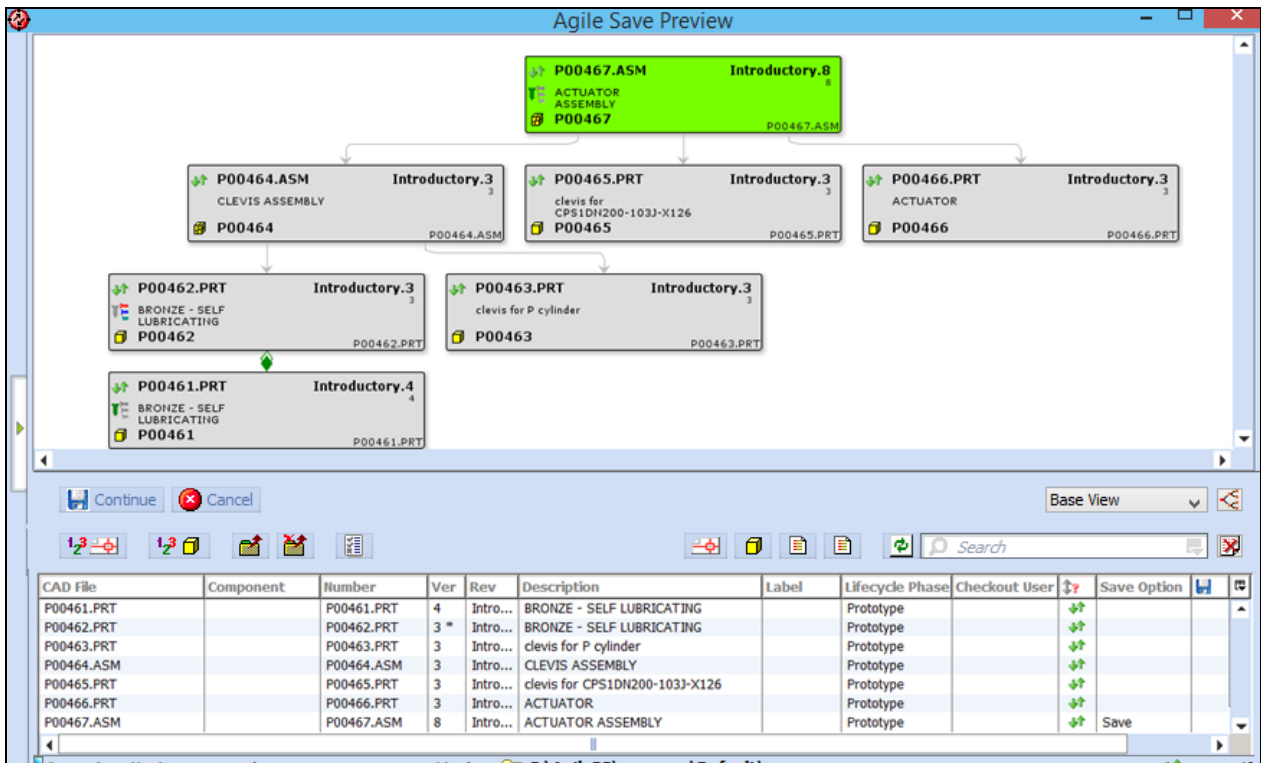


Figure 516: Save Preview: With “simplified representations” elements

**Note** Components suppressed by a simplified representation with a PLM design number are built into the Design structure like normal components (with identifier “CAX-PROE”) and component information “SIMP\_REP\_SUPPRESSED”.

P00467.ASM  
**P00467.ASM**  
 Design • ACTUATOR ASSEMBLY

Prototype  
[Checked Out]

Version: [9]

Title Block | Files | **Structure** | Routing Slip | Relationships | Where Used | History

Structure

Multi-level

	Number	Description	Qty	Ver	Lifecycle Phase	Identifier	Component	Model Name ORIG	Com
•	P00459.PRT	NUT, HEAVY HEX JAM	1	4 *	Prototype	CAX-PROE	SIMP_REP_SUPPRESSED	P00459.PRT	
•	P00460.PRT	.192 THICK PLUS .250	1	3	Prototype	CAX-PROE-SUP	SUPPRESSED	P00460.PRT	
•	P00464.ASM	CLEVIS ASSEMBLY	1	3	Prototype	CAX-PROE	58	P00464.ASM	
•	P00465.PRT	clevis for CPS1DN200-103J-X126	1	3	Prototype	CAX-PROE	52	P00465.PRT	
•	P00466.PRT	ACTUATOR	1	3	Prototype	CAX-PROE	51	P00466.PRT	
•	P02091.PRT	NEW_SUPPRESSED-PRT	1	1	Prototype	CAX-PROE-SUP	SUPPRESSED	P02091.PRT	

**Figure 527: PLM View: Structure: With "simplified represation" Components**

Components suppressed by a simplified representation are BOM relevant.

P00467.ASM » P00467

**P00467**  
 Part • ACTUATOR ASSEMBLY

Preliminary  
Unincorporated

Site: ALL Rev: Introductory

Title Block | Changes | **BOM** | AML | Sites | Prices | Quality | Compliance | Suppliers | Relationships | Where Used | Attachments | History

Your changes have been successfully saved.

BOM

Expanded Display

2* FN	3* Number	Description	Qty	UOM	Item Type	Rev	CADRelationship	CAD Filename	CAD Comp
10	P00459	NUT, HEAVY HEX JAM	6.0	EA	Part		CAX-BOM	P00459.PRT	67
20	P00464	CLEVIS ASSEMBLY	1.0	EA	Part		CAX-BOM	P00464.ASM	58
30	P00465	clevis for CPS1DN200-103J-X126	1.0	EA	Part		CAX-BOM	P00465.PRT	52
40	P00466	ACTUATOR	1.0	EA	Part		CAX-BOM	P00466.PRT	51

**Figure 538: PLM View: BOM With "simplified represation" Components**

## Using Agile Find Numbers – Creo Parametric

Agile Find Numbers can be used in Creo Parametric Drawings for BOM Balloons. For using duplicate find number refer to the *Administration Guide* for further settings within the PLM system.

P00328.DRW > P00328.ASM > P00328

**P00328**  
Part

Preliminary  
Unincorporated

Site: ALL Rev: Introductory Navigator Actions

Title Block Changes BOM AML Sites Prices Quality Compliance Suppliers Relationships Where Used Attachments History

Your changes have been successfully saved.

BOM Views: Base View \*

Add Remove Go To Expanded Display More

	2+ Fill	3+ Number	Description	Qty	UOM	Item Type	Rev	Lifecycle Phase	Notes
11	•	P00327	Plate 1	1.0	EA	Part		Preliminary	
22	•	P00326	Bolt	4.0	EA	Part		Preliminary	

**Figure 7954: Agile BOM with Find Numbers**

Find Numbers must be first input manually within the Part BOM in PLM. Once they are created, they can be accessed from Pro/E using either of these two options:

- Manually created balloons using the parameter "&AGILE\_FIND\_NO:att\_cmp".
- Automated balloons using Report Parameter "asm.mbr.cparam.AGILE\_FIND\_NO" in a repeat region.

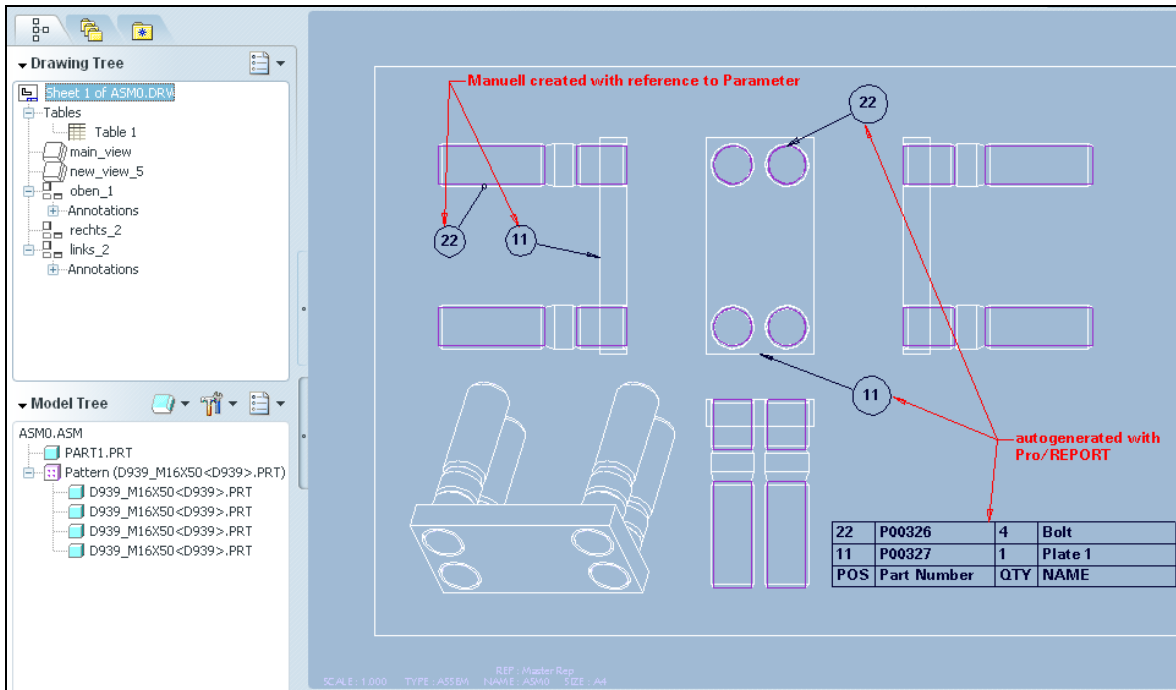


Figure 80: Find Numbers in Pro/E Balloons

## CGR File Handling – CATIA V5

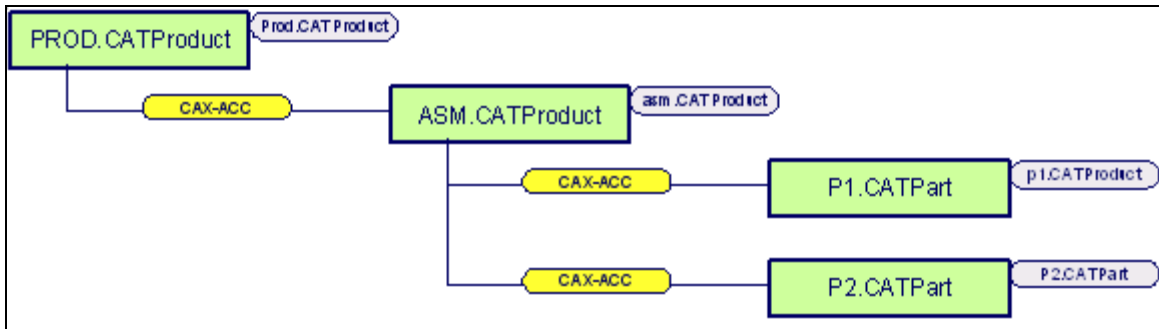
### Introduction

Companies working with CATIA V5 commonly use CGR (CATIA Graphics Representation) files to simplify the representation of parts and assemblies that they are working with. The CGR format provides better performance when dealing with geometry that does not need to be modified (such as customer-provided assemblies that tooling is built from). The Agile CATIA V5 connector supports the management of CGR files.

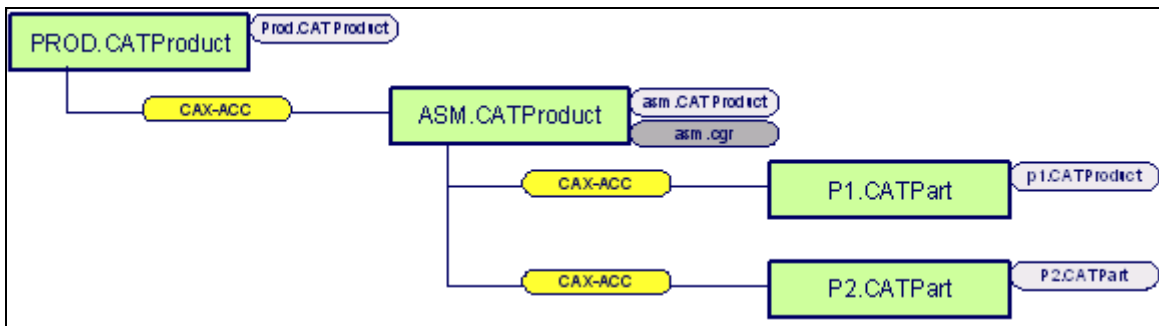
### Functionality Overview – Datamodel

In keeping with Agile standard methodology, which is that all representations of a given CAD model are stored together in a common Design record, both the native CATPart or CATProduct file

and the corresponding CGR file are stored in a common Design. Figure 1 shows the standard CATProduct structure, while Figure 2 shows the same structure with an added CGR file.

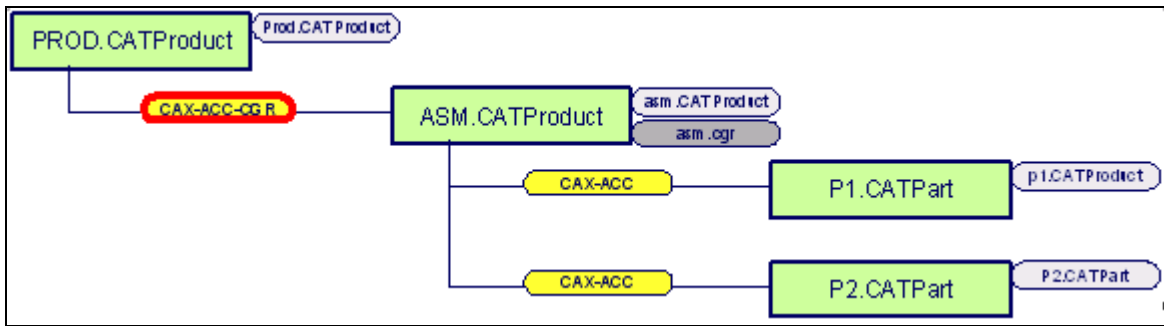


**Figure 81: Standard CATProduct Structure in PLM**



**Figure 552: Structure with both CATProduct and CGR in PLM**

The association between the CATProduct file and its corresponding CGR file is made through the new command *Save with CGR*. Once this has been done once, Agile knows that the two are associated. After that point, when the user uses the Load command to bring files from Agile into CATIA, the integration uses either the CGR or the native CATProduct, depending on whichever one was last saved (in its parent assembly) into Agile. This is “flagged” by a relationship attribute, denoted by the yellow bubble in figures 1 through 3. When the value is set to CAX-ACC by the Save command, upon subsequent loads the native CATProduct file is loaded. When the value is set to CAX-ACC-CGR, subsequent Load commands load the CGR instead. Note that this flag is set automatically by the Save command and should not be set manually by the user, or data corruption may result.



**Figure 83: Assembly flagged to load CGR rather than CATProduct**

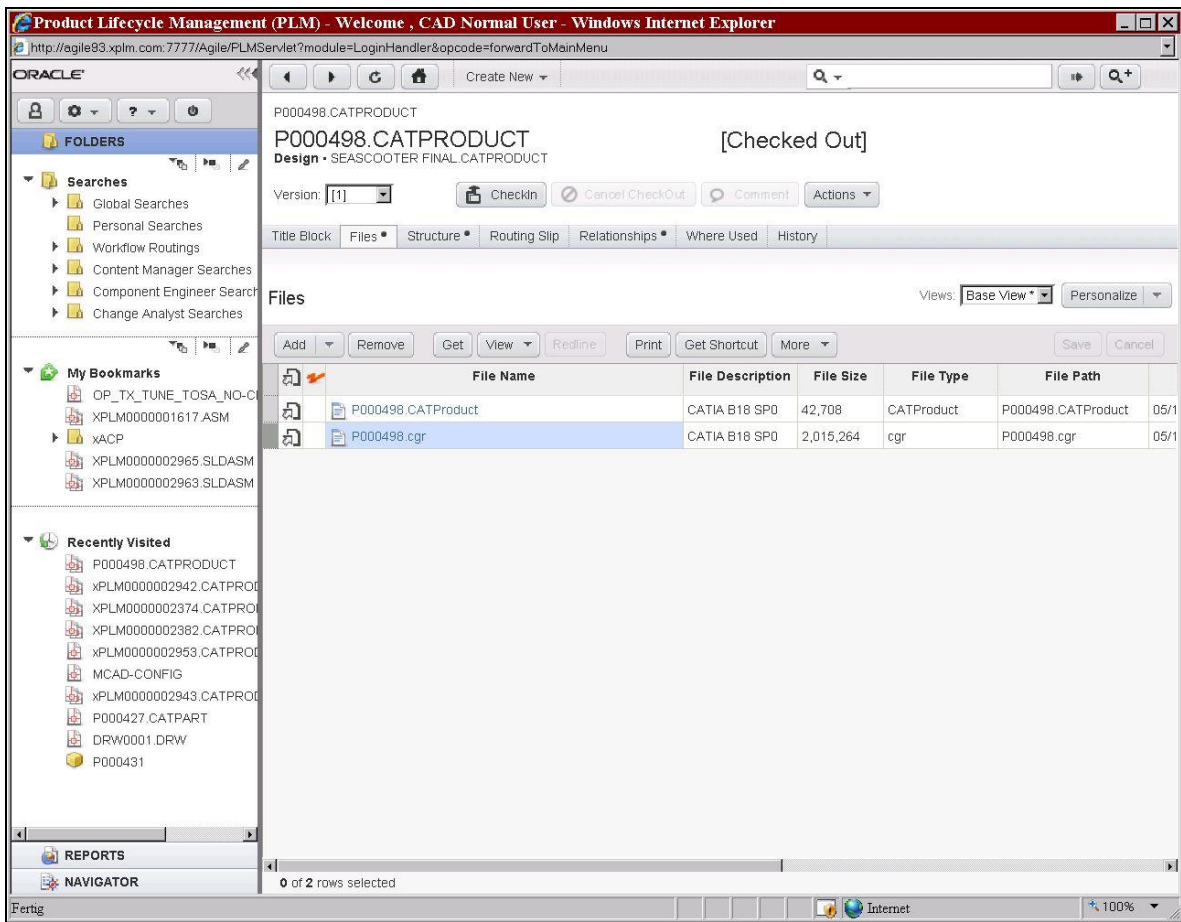


Figure 84: Document containing CGR file

The CATIA representation is shown in the next two figures:

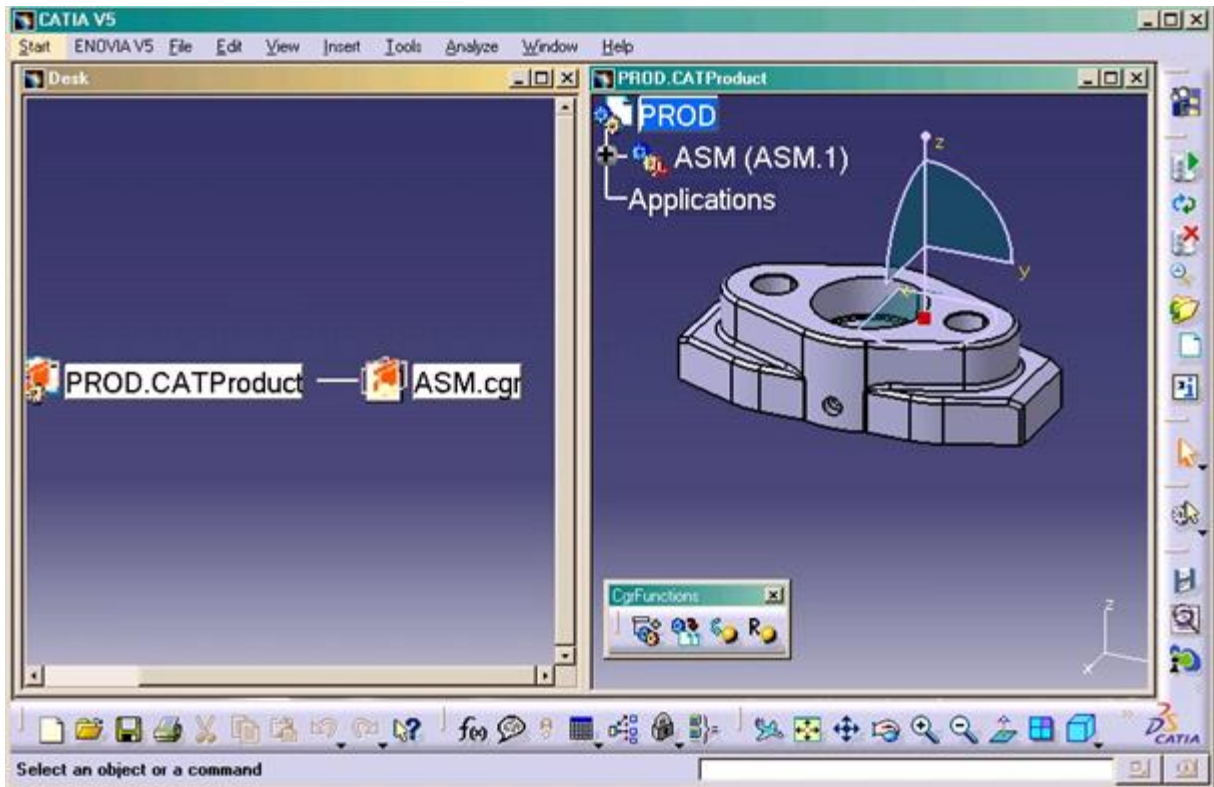
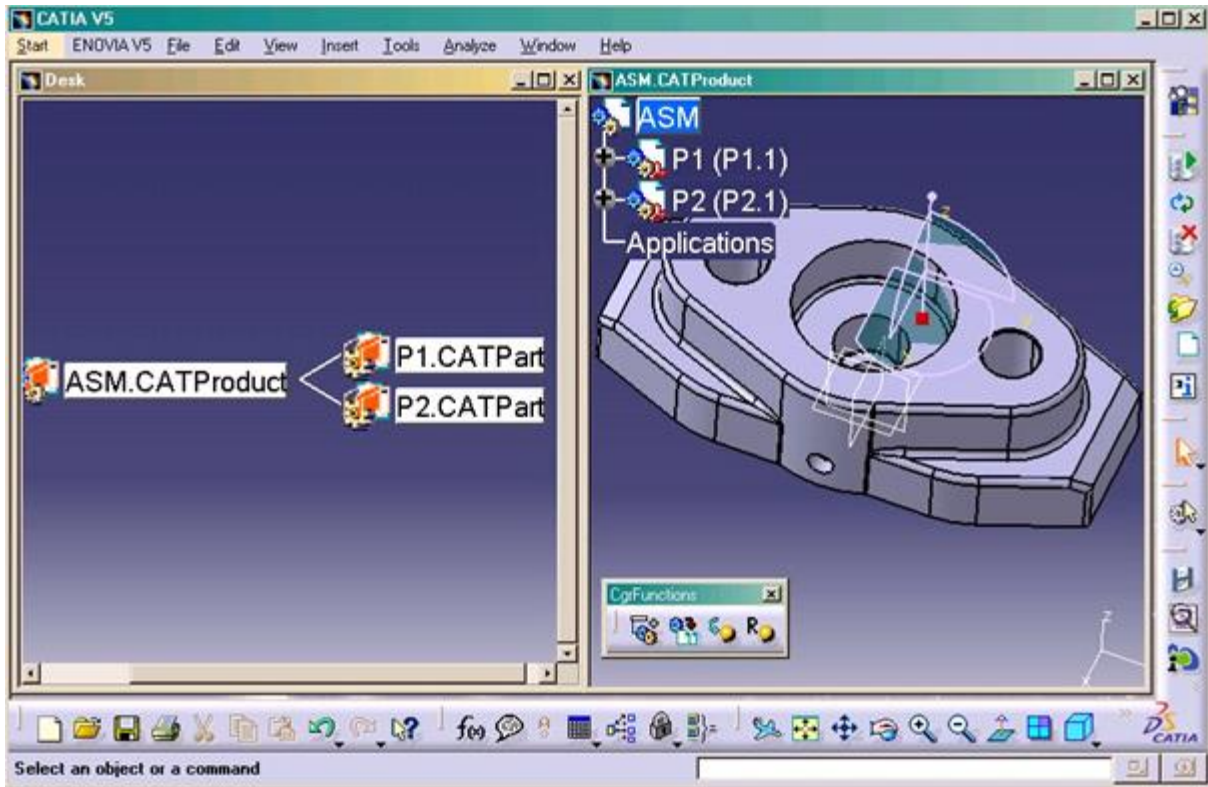


Figure 85: Screenshot from the Assembly PROD



**Figure 86: Screenshot from the Assembly ASM**

In order to provide this functionality, the existing Save and Load commands are modified, and four new commands are provided as follows:

**Insert CGR** – Adds a CGR model to the current CATProduct.

**Save with CGR** – Saves the CGR file along with the native CATPart or CATProduct file, and establishes the relationship between them.

**Open Native File** – Opens the native CATPart or CATProduct files for the selected CGR file(s).

**Reload CGR** – Updates the selected CGR file(s) with the latest version from PLM.

## Changes to existing commands

### **Save Command**

The Save command is modified such that when a CGR file is saved, the relationship attribute between it and its parent is set to CAX-ACC-CGR, indicating that the CGR is active in the parent assembly.




If a Design already has an associated CGR file, the CGR file is created and checked in automatically.

### **Load Command**

The Load command is modified such that when any assembly is loaded, the relationship attribute between each assembly and its children is checked to determine whether the CGR or the native CATProduct or CATPart is loaded.

### **CGR Commands**

**Table 36: CGR commands**

Button	Command	Description
	Save with CGR (AglSaveWithCgr)	This command creates or updates a CGR file from its corresponding native CATProduct or CATPart file, and then saves both files into a common PLM Design. This command associates the CGR and native files together, so that subsequent Save commands knows that the two are related.
	Open Native File (AglOpenCgrObjects)	This command allows the user to open the native CATProduct or CATPart file, that corresponds to one or more selected CGR files. This command is initiated by first selecting the CGR file(s) in the model tree, then clicking the command. The native files are opened in separate windows from the original CGR files. The user can then, for example, replace the CGR file with the native file.
	Reload CGR (AglReloadCgrObjects)	This command allows the user to update an existing CGR file with the latest version from PLM. This command is initiated by first selecting the CGR file(s) in the model tree, then clicking the command.

## Configuration Handling – SolidWorks

### Introduction

Companies working with SolidWorks use configurations for different purposes.

One purpose is to have alternate geometric representations for the same part for use in assemblies, like an expanded or collapsed spring. From PLM point of view, there is no need to store a Design object for each representation in PLM.

The second purpose is to create parameterized designs that drive dimensions, features or structures through configurations. From a PLM point of view each of these configurations represents a separate part and therefore needs a separate Design object in PLM.

### Functionality Overview

The SolidWorks connector offers a number of options that define CAD file properties that can be used to manipulate the way the connector treats configurations. The options can be defined in the file XPlmSolidWorksConnector.xml. By default the SolidWorks integration creates a Design object for each configuration in PLM if there is more than one configuration defined inside a SolidWorks file.

The option **ConfiguredDefault** defines, whether configurations in a SolidWorks model are saved to PLM as independent design objects. If the parameter ConfiguredDefault is set to true all configurations that are contained in a SolidWorks model are saved to PLM as design objects (that is the default behavior). If the parameter is set to false configurations, are not represented in PLM as separate design structures.

The options **ConfiguredProperty** and **ConfiguredProperty2** define the name of two CAD file properties that can be used to overwrite the setting that is defined by the **ConfiguredDefault** property if needed. Overwriting via these properties can be switched on and off by assigning the values defined by the options **ConfiguredValue\_Configured** and **ConfiguredValue\_NotConfigured** to the properties in the SolidWorks “Summary Information” window. Always use the tab “Custom” for the properties defined by the options **ConfiguredProperty** and **ConfiguredProperty2**. If a file has both of these properties assigned, the property of the option **ConfiguredProperty2** overwrites the property of the option **ConfiguredProperty**. For examples of the usage of these options refer to the chapter *Customizing the Configuration Properties*.

The configuration-specific parameter defined by the option **MasterConfigProperty** can link a specific configuration to a master configuration in the same part. Only for the master configurations a PLM object is created, all linked configurations are referenced to the master configuration. By default, the configuration-specific parameter MasterConfig is read. If this

parameter is set and references an existing configuration in the same part, the references master configuration is used in PLM. Otherwise, a separate Design object is created for the configuration in PLM. This supports the use case of having some alternate representations and real representations mixed within one configuration table.

The SolidWorks property names that control the behaviour described in the paragraphs above are configurable in the file `XPlmSolidWorksConnector.xml`:

```
<Field>
  <Name>ConfiguredProperty</Name>
  <Value>Configured</Value>
  <!--default is "Configured" -->
</Field>
<Field>
  <Name>MasterConfigProperty</Name>
  <Value>MasterConfig</Value>
  <!--default is "MasterConfig" -->
</Field>
```

### Sample Configuration Handling

The assembly contains two configurations of the same part. Each configuration is represented with a Design object in PLM.

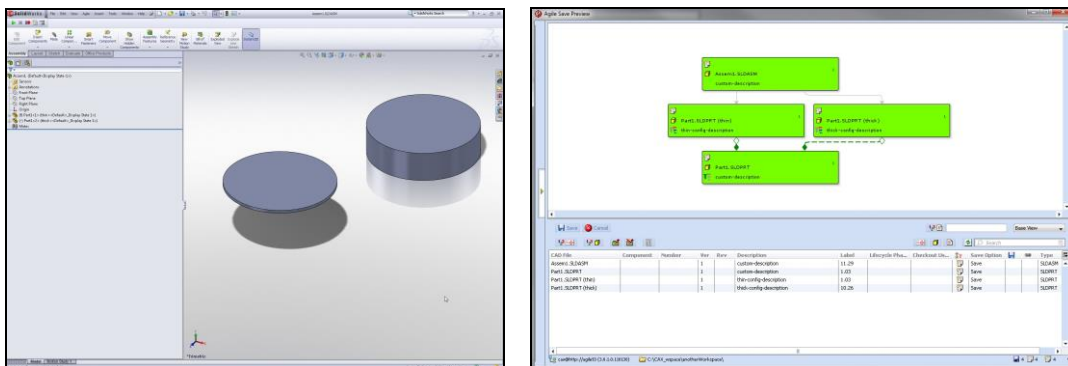


Figure 87: Configuration Handling in SolidWorks

During save the configuration specific properties are filled in.

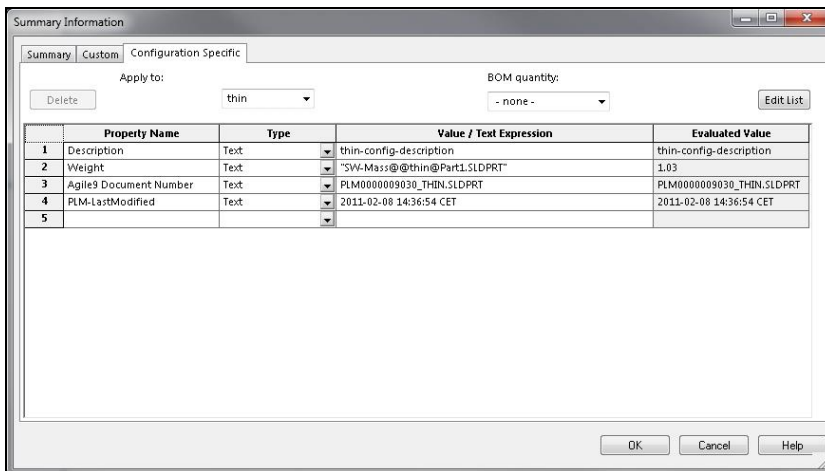


Figure 88: SolidWorks Configurations Specifics

The structure in PLM looks like this.

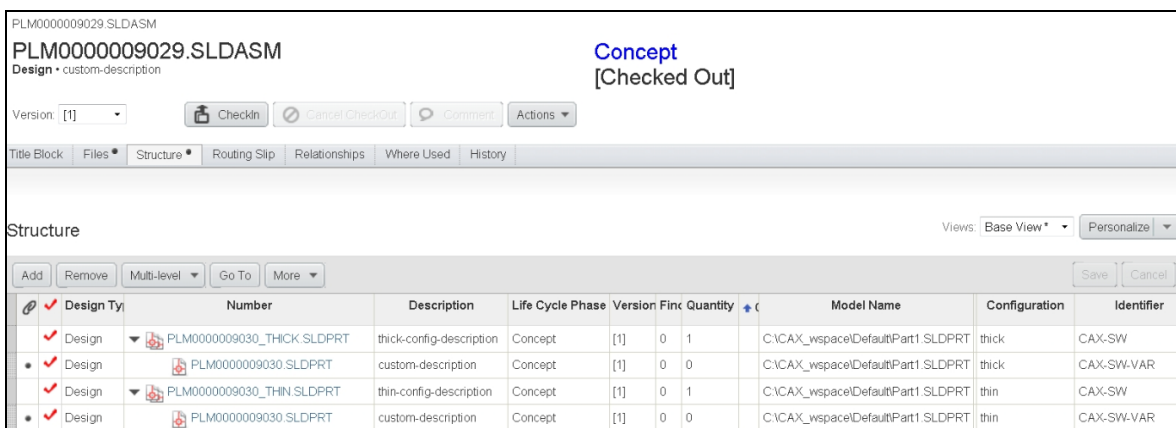


Figure 8956: PLM View: Structure: Configurations

## Customizing the Configuration Properties

The EC's behavior concerning configuration resolution can be customized using the parameters ConfiguredDefault, ConfiguredProperty and ConfiguredProperty2. This paragraph explains the usage of these properties in respect to customized configuration treatment.

Let us assume configurations of SolidWorks files are saved to PLM by default, that means the option ConfiguredDefault is set to true. If the user wants the EC to ignore configurations of a certain file for some reason, this is possible by using a user definable file property. First, the user must define the name of the file property that should be used and the values that can be assigned to that property. To do so, the name of the property must be entered in the value field of one of the following options found in the file XPlmSolidWorksConnector.xml:

<Field>

```
    <Name>ConfiguredProperty</Name>
    <Value>Configured</Value>
</Field>
```

Or

```
<Field>
    <Name>ConfiguredProperty2</Name>
    <Value>Configured2</Value>
</Field>
```

Let us assume we want to use the name `isConfigured` for the property that indicates configuration resolution. We would choose one of the available properties, e. g. `ConfiguredProperty` and enter the name `isConfigured` in the Value field. The result is the following:

```
<Field>
    <Name>ConfiguredProperty</Name>
    <Value>isConfigured</Value>
</Field>
```

In the same file the values that express if configurations should be resolved or not can be defined in the options

```
<Field>
    <Name>ConfiguredValue_Configured</Name>
    <Value>yes</Value>
</Field>
```

and

```
<Field>
    <Name>ConfiguredValue_NotConfigured</Name>
    <Value>no</Value>
</Field>
```

In this example we want the connector to resolve configurations if the value 1 is assigned to the property `isConfigured` and to suppress configurations if the value 0 is assigned. So we change the options in the `XPlmSolidWorksConnector.xml` accordingly:

```
<Field>
    <Name>ConfiguredValue_Configured</Name>
    <Value>1</Value>
</Field>
```

```
<Field>
    <Name>ConfiguredValue_NotConfigured</Name>
```

```
<Value>0</Value>  
</Field>
```

In SolidWorks we can now use the defined property by opening the Summary Information window and adding the property isConfigured to the “Custom” tab.

In case the “Custom” tab contains isConfigured = 1 any configuration of the respective CAD file is saved to PLM. Otherwise, if isConfigured = 0 is set in the Summary Information window the EC ignores any configuration. Using this property it is now possible to define if configuration resolution should be activated or not for every single file of an assembly.

## Sample Master Configuration

The assembly contains two configurations of the same part. One configuration is linked to the other configuration using the configuration-specific property MasterConfig. The example below links the configuration *thick* to *thin*.

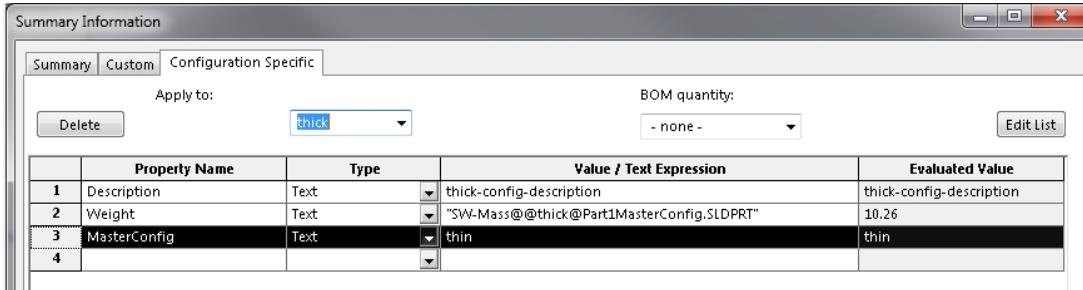


Figure 90: SolidWorks: Configuration Specifics

During the save process the two configurations are treated as one object. Only the master configuration (*thin*) is created in PLM. The Save Preview only shows the master configuration.

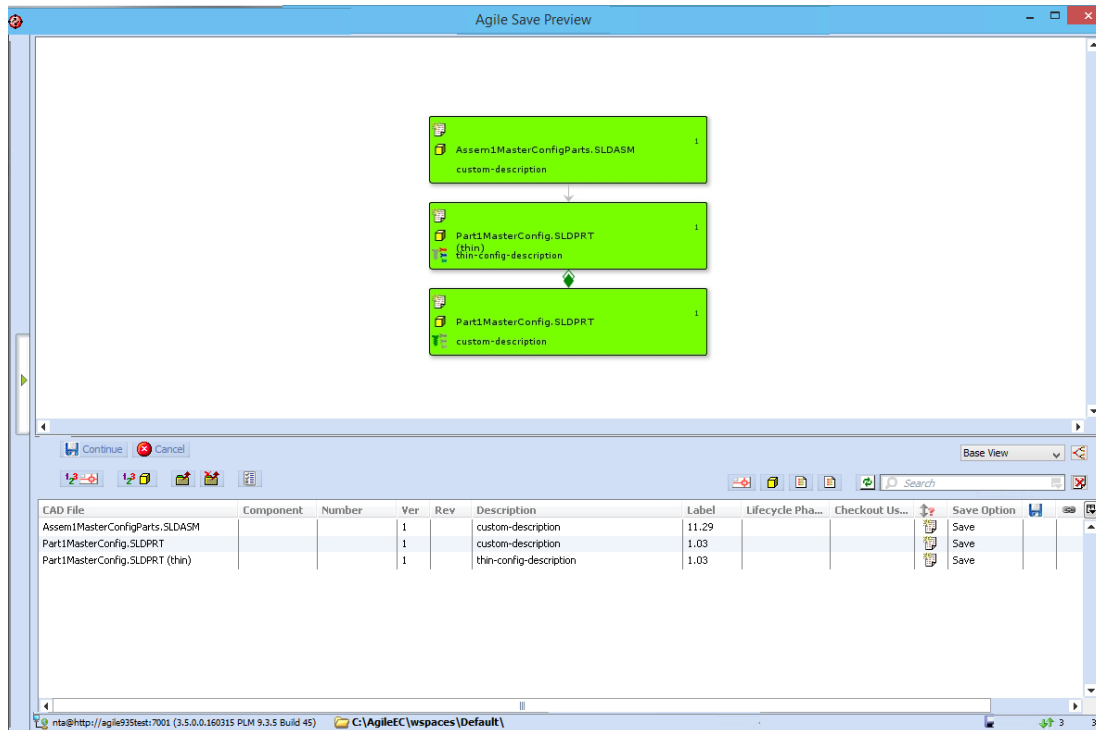
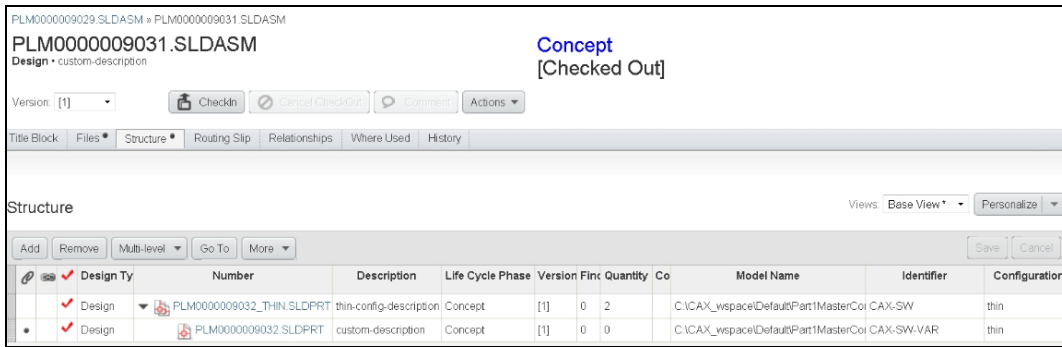


Figure 91: Save Preview: Configurations

The structure in PLM looks like this and sums up the quantity of *thick* and *thin*.

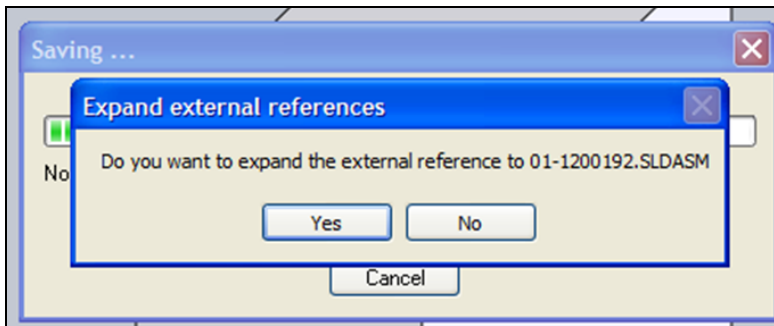


**Figure 92: Save Preview: Configurations**

## SolidWorks and Solid Edge External References to Assemblies

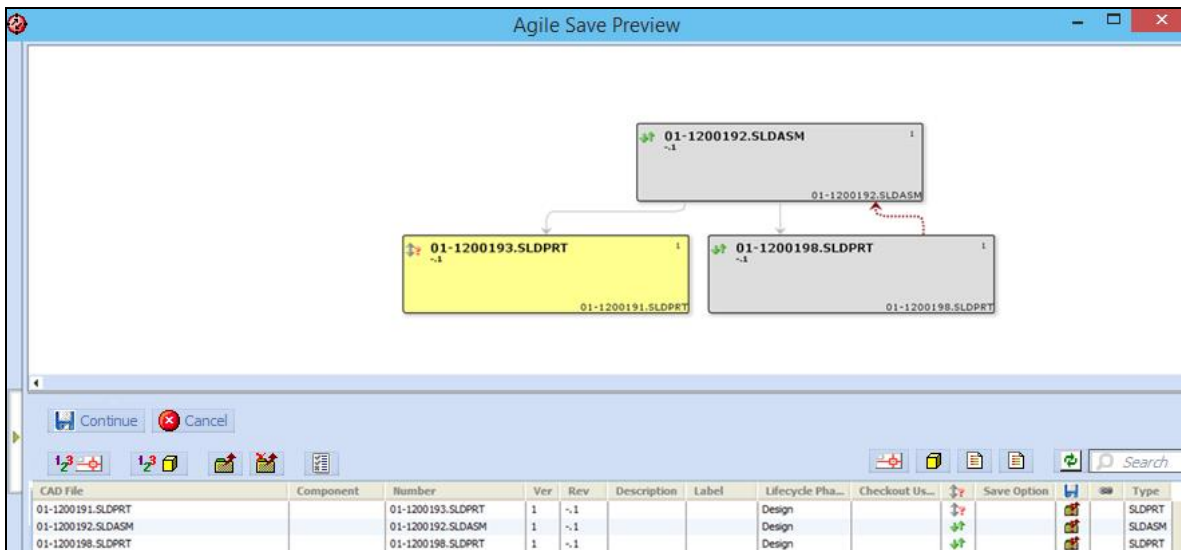
The structure of SolidWorks and Solid Edge assemblies is checked during save. If any missing component for SolidWorks is detected, these missing objects are listed in the save preview in an information message.

If an assembly is compressed (using Pack&Go) or if an assembly is referenced from another SolidWorks or SolidEdge part in an external reference, the structure of the referenced assembly is verified. If the assembly is already known as a PLM object, the user is asked whether he wants to expand the structure of the referenced assembly further. If the assembly is not known in PLM the structure is expanded without prompting the user.



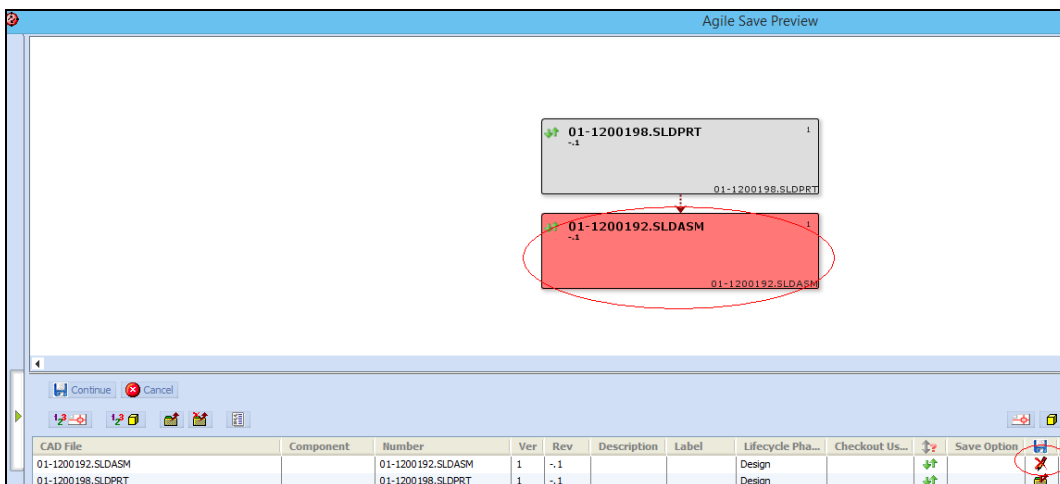
**Figure 93: External References Handling**

If the assembly structure is expanded further, the user is able to perform any normal save action on that assembly.



**Figure 57: Save Preview: expanded external References**

If the structure is not extracted further then the Assembly can't be saved into PLM. It can only be built into the PLM relationships of the referencing object. All actions on that assembly are forbidden.

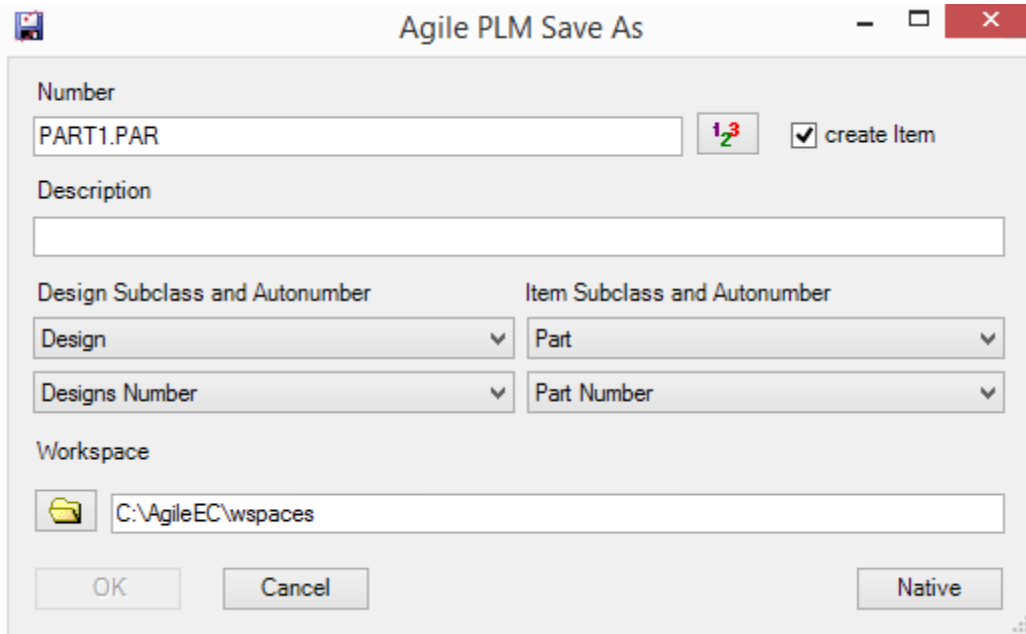


**Figure 58: Save preview: not expanded external References**

## Save As Override Functionality – Solid Edge

The MCAD connector for Solid Edge provides an override dialog which is displayed instead of the native Save As dialog provided by the CAD system. The MCAD connector's *Save As Override* dialog allows users to create PLM Design and Item objects while performing a Save As in Solid Edge.

The Save As override dialog is displayed whenever the native Solid Edge save as dialog would have appeared, for example when saving a Solid Edge file for the first time or when explicitly performing a save as. Be aware that the MCAD connector's *Save As Override* dialog requires the user to log in to Agile.



**Figure 59: Save As Override dialog**

The MCAD connector's *Save As Override* dialog also allows users to use the corresponding, native Solid Edge save as dialog instead of the override dialog. Switching to the native dialog is possible by pressing the *Native* button (refer to *Figure 59: Save As Override dialog*).

## IDF Import – Creo Parametric

IDF (Intermediate Data Format) is a data exchange format for ECAD and MCAD applications. Since release 3.6, the MCAD connector for Creo Parametric supports the IDF import feature of this CAD system. When importing IDF data, Creo creates the corresponding native geometry files (.prt, .asm) based on the IDF geometry definitions.

CAD engineers should make sure, that the .prt and or .asm files mentioned above have the same file name (but not the same file ending) as the IDF files from which they were created. If so, the MCAD connector saves the IDF files (with the file endings .emn and .emp) to Agile as viewables alongside the .prt and/or .asm files.

## **Web Conferencing with MCAD**

Web conferencing tools like Oracle Beehive and Cisco WebEx sometimes appear to freeze when the MCAD integration displays dialog windows. In this situation, no screen updates are performed anymore. The workaround for Beehive is to stop and restart sharing the desktop.

Microsoft Lync and Citrix GoToMeeting do not show any issues.