

**Oracle® Retail Merchandising**

Cloud Services Batch Schedule

Release 16.0.030

**F19826-01**

June 2019

F19826-01

Copyright © 2019, Oracle and/or its affiliates. All rights reserved.

Primary Author: Nathan Young

This software and related documentation are provided under a license agreement containing restrictions on use and disclosure and are protected by intellectual property laws. Except as expressly permitted in your license agreement or allowed by law, you may not use, copy, reproduce, translate, broadcast, modify, license, transmit, distribute, exhibit, perform, publish, or display any part, in any form, or by any means. Reverse engineering, disassembly, or decompilation of this software, unless required by law for interoperability, is prohibited.

The information contained herein is subject to change without notice and is not warranted to be error-free. If you find any errors, please report them to us in writing.

If this is software or related documentation that is delivered to the U.S. Government or anyone licensing it on behalf of the U.S. Government, then the following notice is applicable:

U.S. GOVERNMENT END USERS: Oracle programs, including any operating system, integrated software, any programs installed on the hardware, and/or documentation, delivered to U.S. Government end users are "commercial computer software" pursuant to the applicable Federal Acquisition Regulation and agency-specific supplemental regulations. As such, use, duplication, disclosure, modification, and adaptation of the programs, including any operating system, integrated software, any programs installed on the hardware, and/or documentation, shall be subject to license terms and license restrictions applicable to the programs. No other rights are granted to the U.S. Government.

This software or hardware is developed for general use in a variety of information management applications. It is not developed or intended for use in any inherently dangerous applications, including applications that may create a risk of personal injury. If you use this software or hardware in dangerous applications, then you shall be responsible to take all appropriate fail-safe, backup, redundancy, and other measures to ensure its safe use. Oracle Corporation and its affiliates disclaim any liability for any damages caused by use of this software or hardware in dangerous applications.

Oracle and Java are registered trademarks of Oracle and/or its affiliates. Other names may be trademarks of their respective owners.

Intel and Intel Xeon are trademarks or registered trademarks of Intel Corporation. All SPARC trademarks are used under license and are trademarks or registered trademarks of SPARC International, Inc. AMD, Opteron, the AMD logo, and the AMD Opteron logo are trademarks or registered trademarks of Advanced Micro Devices. UNIX is a registered trademark of The Open Group.

This software or hardware and documentation may provide access to or information about content, products, and services from third parties. Oracle Corporation and its affiliates are not responsible for and expressly disclaim all warranties of any kind with respect to third-party content, products, and services unless otherwise set forth in an applicable agreement between you and Oracle. Oracle Corporation and its affiliates will not be responsible for any loss, costs, or damages incurred due to your access to or use of third-party content, products, or services, except as set forth in an applicable agreement between you and Oracle.

#### **Value-Added Reseller (VAR) Language**

##### **Oracle Retail VAR Applications**

The following restrictions and provisions only apply to the programs referred to in this section and licensed to you. You acknowledge that the programs may contain third party software (VAR applications) licensed to Oracle. Depending upon your product and its version number, the VAR applications may include:

- (i) the **MicroStrategy** Components developed and licensed by MicroStrategy Services Corporation (MicroStrategy) of McLean, Virginia to Oracle and imbedded in the MicroStrategy for Oracle Retail Data Warehouse and MicroStrategy for Oracle Retail Planning & Optimization applications.
- (ii) the **Wavelink** component developed and licensed by Wavelink Corporation (Wavelink) of Kirkland, Washington, to Oracle and imbedded in Oracle Retail Mobile Store Inventory Management.
- (iii) the software component known as **Access Via**<sup>™</sup> licensed by Access Via of Seattle, Washington, and imbedded in Oracle Retail Signs and Oracle Retail Labels and Tags.
- (iv) the software component known as **Adobe Flex**<sup>™</sup> licensed by Adobe Systems Incorporated of San Jose, California, and imbedded in Oracle Retail Promotion Planning & Optimization application.

You acknowledge and confirm that Oracle grants you use of only the object code of the VAR Applications. Oracle will not deliver source code to the VAR Applications to you. Notwithstanding any other term or condition of the agreement and this ordering document, you shall not cause or permit alteration of any VAR Applications. For purposes of this section, "alteration" refers to all alterations, translations, upgrades, enhancements, customizations or modifications of all or any portion of the VAR Applications including all

reconfigurations, reassembly or reverse assembly, re-engineering or reverse engineering and recompilations or reverse compilations of the VAR Applications or any derivatives of the VAR Applications. You acknowledge that it shall be a breach of the agreement to utilize the relationship, and/or confidential information of the VAR Applications for purposes of competitive discovery.

The VAR Applications contain trade secrets of Oracle and Oracle's licensors and Customer shall not attempt, cause, or permit the alteration, decompilation, reverse engineering, disassembly or other reduction of the VAR Applications to a human perceivable form. Oracle reserves the right to replace, with functional equivalent software, any of the VAR Applications in future releases of the applicable program.



---

---

# Contents

<b>Send Us Your Comments</b> .....	vii
<b>Preface</b> .....	ix
Audience .....	ix
Documentation Accessibility .....	ix
Customer Support .....	ix
Review Patch Documentation .....	x
Improved Process for Oracle Retail Documentation Corrections .....	x
Oracle Retail Documentation on the Oracle Technology Network .....	xi
Conventions .....	xi
<b>1 Introduction to Merchandising Batch Processing</b>	
<b>Batch Processing</b> .....	1-1
Types of Batch Programs .....	1-1
Batch Window .....	1-2
Batch Schedule .....	1-2
<b>Merchandising Batch Schedule</b> .....	1-2
<b>Batch Schedule</b> .....	1-2



---

---

# Send Us Your Comments

Oracle Retail Merchandising Cloud Services Batch Schedule, Release 16.0.030

Oracle welcomes customers' comments and suggestions on the quality and usefulness of this document.

Your feedback is important, and helps us to best meet your needs as a user of our products. For example:

- Are the implementation steps correct and complete?
- Did you understand the context of the procedures?
- Did you find any errors in the information?
- Does the structure of the information help you with your tasks?
- Do you need different information or graphics? If so, where, and in what format?
- Are the examples correct? Do you need more examples?

If you find any errors or have any other suggestions for improvement, then please tell us your name, the name of the company who has licensed our products, the title and part number of the documentation and the chapter, section, and page number (if available).

---

---

**Note:** Before sending us your comments, you might like to check that you have the latest version of the document and if any concerns are already addressed. To do this, access the Online Documentation available on the Oracle Technology Network Web site. It contains the most current Documentation Library plus all documents revised or released recently.

---

---

Send your comments to us using the electronic mail address: [retail-doc\\_us@oracle.com](mailto:retail-doc_us@oracle.com)

Please give your name, address, electronic mail address, and telephone number (optional).

If you need assistance with Oracle software, then please contact your support representative or Oracle Support Services.

If you require training or instruction in using Oracle software, then please contact your Oracle local office and inquire about our Oracle University offerings. A list of Oracle offices is available on our Web site at <http://www.oracle.com>.





---

---

# Preface

This batch schedule document details the integrated cyclical processing schedules for the Oracle Retail Merchandising applications:

- Oracle Retail Merchandising System (RMS)
- Oracle Retail Invoice Matching (ReIM)
- Oracle Retail Pricing
- Oracle Retail Sales Audit (ReSA)
- Oracle Retail Allocation
- Oracle Retail Data Extractor (RDE)

This guide describes the periodic and ad hoc phases of batch processing, as well as pre- and post-processing dependencies.

## Audience

The audiences for this guide are as follows:

- Systems analysts and system operations personnel who need information about Merchandising processes, internally or in relation to systems across the enterprise
- Integrators and implementation staff who have the overall responsibility for implementing the Merchandising applications in their enterprise

## Documentation Accessibility

For information about Oracle's commitment to accessibility, visit the Oracle Accessibility Program website at <http://www.oracle.com/pls/topic/lookup?ctx=acc&id=docacc>.

### Access to Oracle Support

Oracle customers that have purchased support have access to electronic support through My Oracle Support. For information, visit <http://www.oracle.com/pls/topic/lookup?ctx=acc&id=info> or visit <http://www.oracle.com/pls/topic/lookup?ctx=acc&id=trs> if you are hearing impaired.

## Customer Support

To contact Oracle Customer Support, access My Oracle Support at the following URL:

<https://support.oracle.com>

When contacting Customer Support, please provide the following:

- Product version and program/module name
- Functional and technical description of the problem (include business impact)
- Detailed step-by-step instructions to re-create
- Exact error message received
- Screen shots of each step you take

## Review Patch Documentation

When you install the application for the first time, you install either a base release (for example, 16.0) or a later patch release (for example, 16.0.030). If you are installing the base release, additional patch, and bundled hot fix releases, read the documentation for all releases that have occurred since the base release before you begin installation. Documentation for patch and bundled hot fix releases can contain critical information related to the base release, as well as information about code changes since the base release.

## Improved Process for Oracle Retail Documentation Corrections

To more quickly address critical corrections to Oracle Retail documentation content, Oracle Retail documentation may be republished whenever a critical correction is needed. For critical corrections, the republication of an Oracle Retail document may at times not be attached to a numbered software release; instead, the Oracle Retail document will simply be replaced on the Oracle Technology Network Web site, or, in the case of Data Models, to the applicable My Oracle Support Documentation container where they reside.

This process will prevent delays in making critical corrections available to customers. For the customer, it means that before you begin installation, you must verify that you have the most recent version of the Oracle Retail documentation set. Oracle Retail documentation is available on the Oracle Technology Network at the following URL:

<http://www.oracle.com/technetwork/documentation/oracle-retail-100266.html>

An updated version of the applicable Oracle Retail document is indicated by Oracle part number, as well as print date (month and year). An updated version uses the same part number, with a higher-numbered suffix. For example, part number E123456-02 is an updated version of a document with part number E123456-01.

If a more recent version of a document is available, that version supersedes all previous versions.

## Oracle Retail Documentation on the Oracle Technology Network

Oracle Retail product documentation is available on the following web site:

<http://www.oracle.com/technetwork/documentation/oracle-retail-100266.html>

(Data Model documents are not available through Oracle Technology Network. You can obtain them through My Oracle Support.)

## Conventions

The following text conventions are used in this document:

<b>Convention</b>	<b>Meaning</b>
<b>boldface</b>	Boldface type indicates graphical user interface elements associated with an action, or terms defined in text or the glossary.
<i>italic</i>	Italic type indicates book titles, emphasis, or placeholder variables for which you supply particular values.
monospace	Monospace type indicates commands within a paragraph, URLs, code in examples, text that appears on the screen, or text that you enter.



---

---

# Introduction to Merchandising Batch Processing

This chapter is a brief introduction to Oracle Retail batch processing. It defines basic terms and concepts.

## Batch Processing

Batch processing is the execution of a group of batch programs (jobs). The results are returned without user intervention. Batch programs are commonly used for the following reasons:

- To process large volumes of transaction data
- To interface with external systems
- To perform internal maintenance

Batch programs can process very large quantities of data quickly and efficiently. Batch programs can perform some updates that could be performed through online transactions, but much more quickly and with less impact on system performance. Batch processing is usually scheduled for times when systems are idle or least busy.

Batch programs can be run automatically using batch scheduler software. The batch scheduler allows batch jobs to be set up in a specific order, with restrictions attached to any program as needed. If an error occurs with a batch program, an administrator must correct the error and manually rerun the batch program that failed.

## Types of Batch Programs

Oracle Retail batch programs are of several types:

- Upload programs bring data from external systems into the Oracle Retail database. For example, the sales upload program uploads daily transactions that occur at the point of sale (POS) for processing by the Oracle Retail Management System (RMS).
- Download programs extract data from RMS and format it so it can be used by external systems. For example, the posdnld program extracts new and changed information about an item/location for downloading to the point of sale.
- System maintenance programs perform tasks such as updating the system date. For example, the dtesys program increments the system date at the end of each batch cycle.

- Functional maintenance programs process data specific to a functional area. For example, the mrt.pc program creates individual transfers for an approved Mass Return Transfer.

## Batch Window

Because of the impact on production systems, it is not always possible to run batch programs during business hours; however, there is a window of opportunity during each day or night when online systems are not being used. This time frame is the batch window. For example, a retailer with stores throughout the continental U.S. might require its online systems to be available from 8 AM Eastern Standard Time, when its East Coast offices open, until 9 PM Pacific Standard Time, when its West Coast stores close. This allows an eight-hour batch window for processing all batch jobs.

## Batch Schedule

Order is critical when running batch programs. Some tasks need to be performed before others. A batch schedule ensures that every time batch processing is performed, the correct tasks are performed in the proper order.

For each individual user, the schedule is a suggested starting point for the installation. Some programs are specific to products that may not be installed, so these programs may not be used at all.

## Merchandising Batch Schedule

The integrated Merchandising batch schedule combines the batch schedules of all Merchandising applications.

The integrated Merchandising batch schedule combines the batch modules for the following applications:

- Oracle Retail Merchandising System (RMS)
- Oracle Retail Trade Management (RTM)
- Oracle Retail Sales Audit (ReSA)
- Oracle Retail Invoice Matching (ReIM)
- Oracle Retail Pricing
- Oracle Retail Allocation
- Oracle Retail Data Extractor (RDE)

## Batch Schedule

View the whole SaaS Batch Schedule below.

# Start Batch Cycle

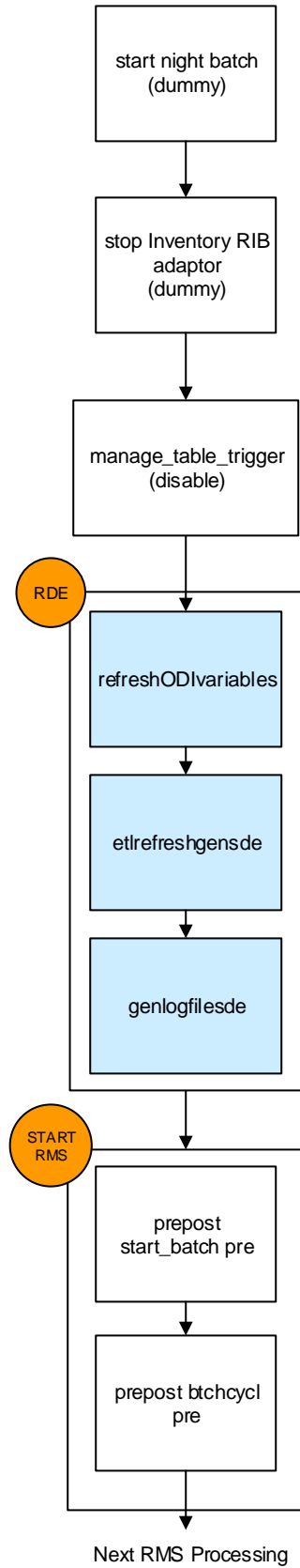
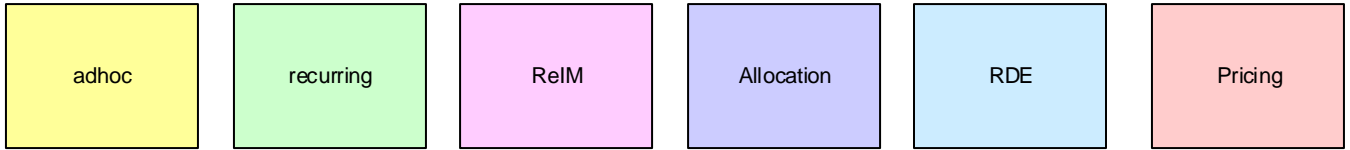





# RPAS and AIP

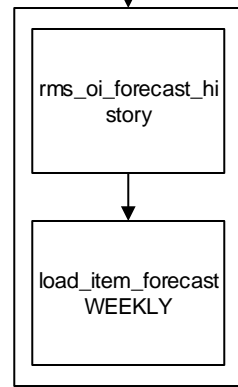
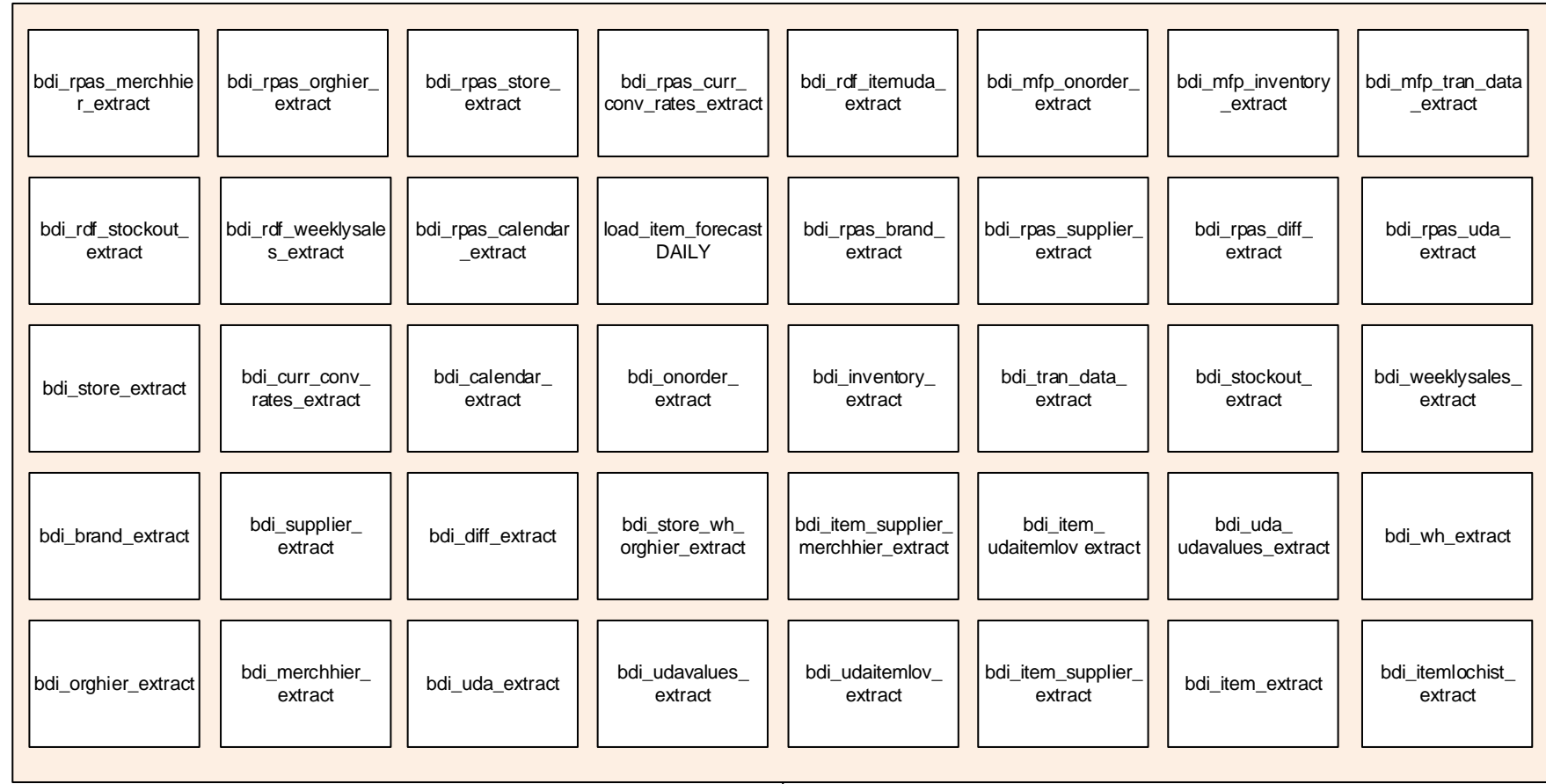

Next ReIM and Allocation

Back to RMS Processing

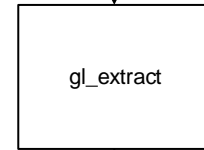

Back to RMS Processing

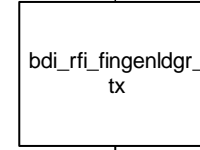

Back to RMS Processing

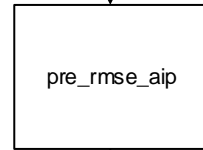

Next ReIM and Allocation

# ReIM and Allocation

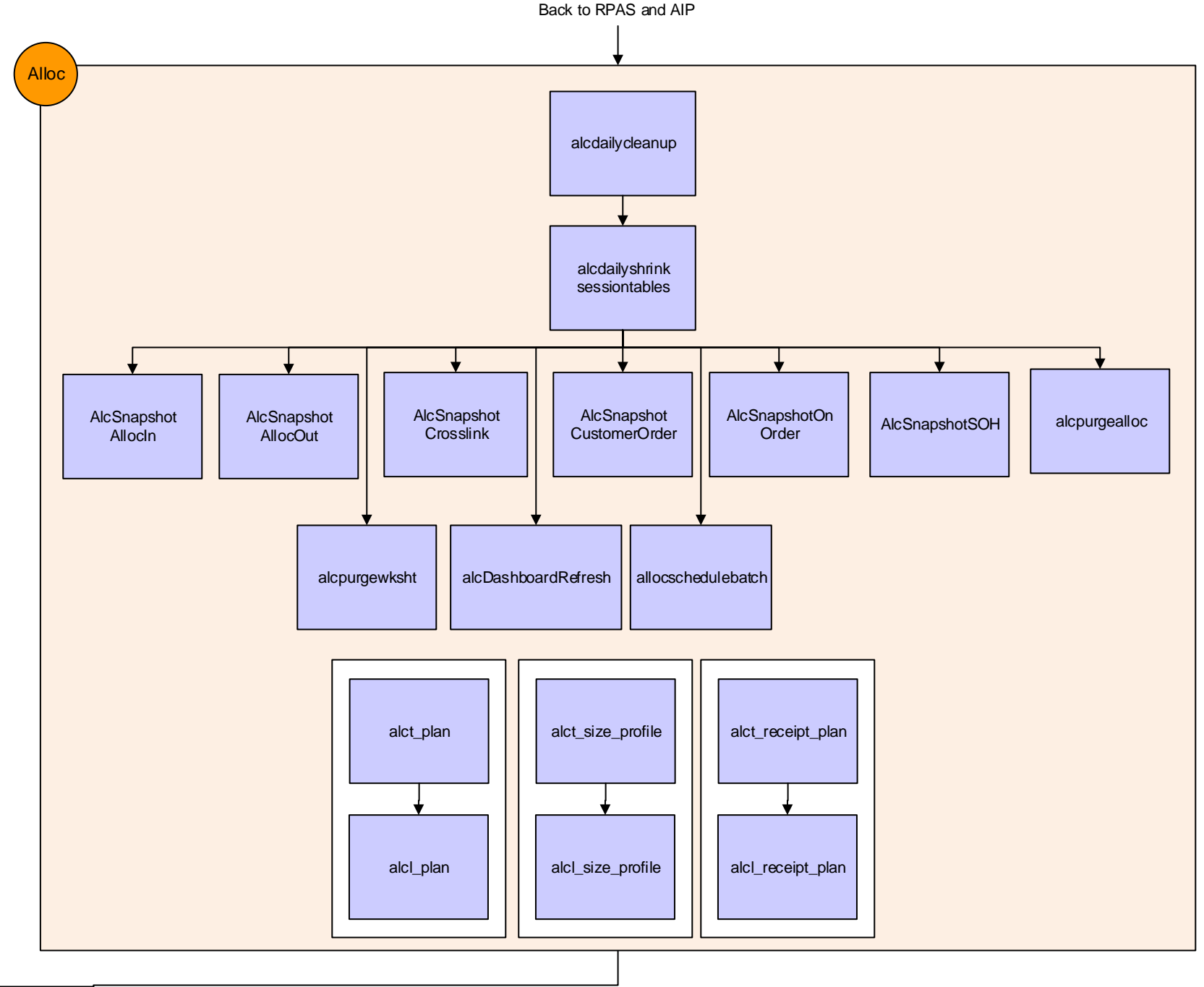
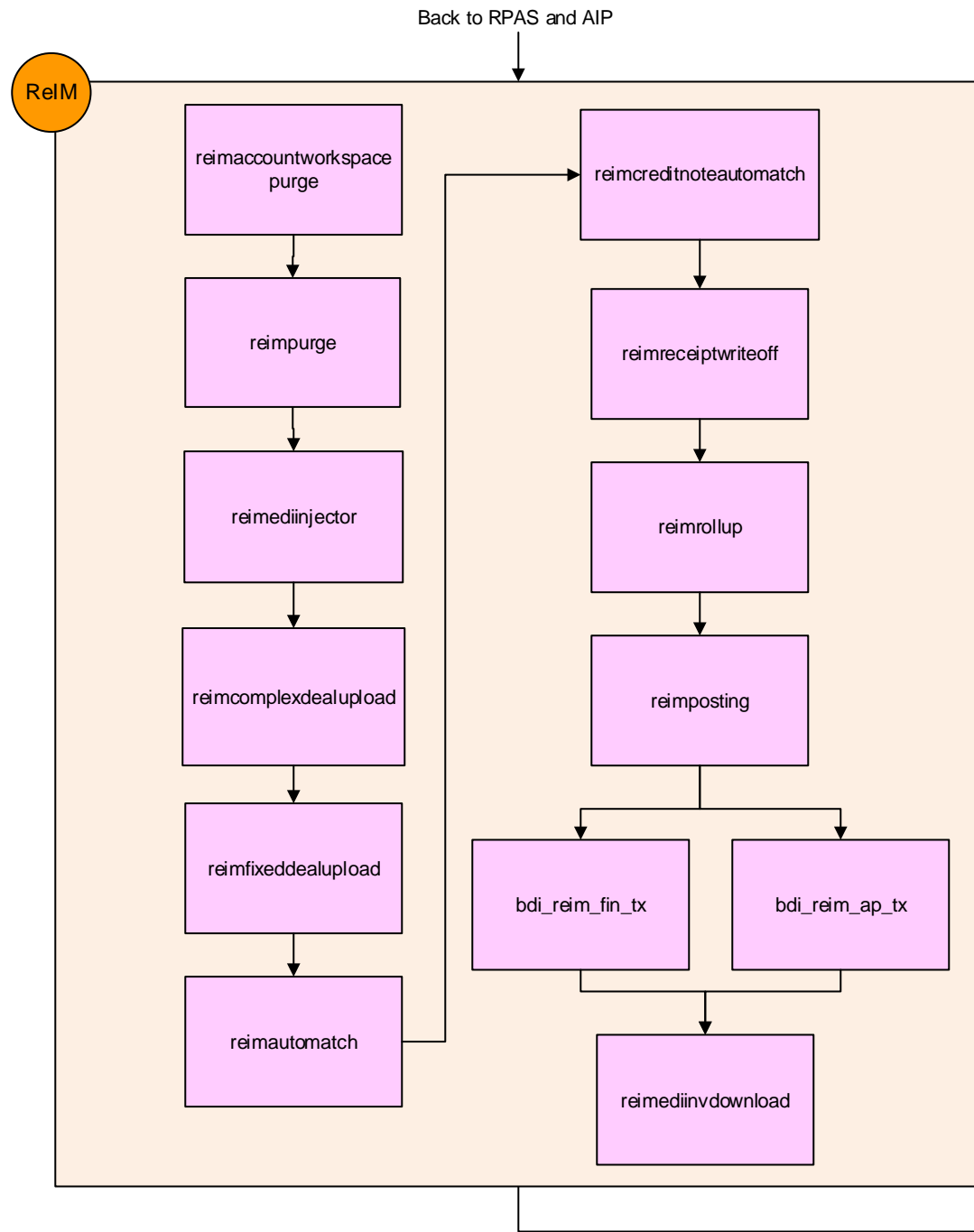

Next Pricing

# Pricing

Back to ReIM and Allocation

Pricing

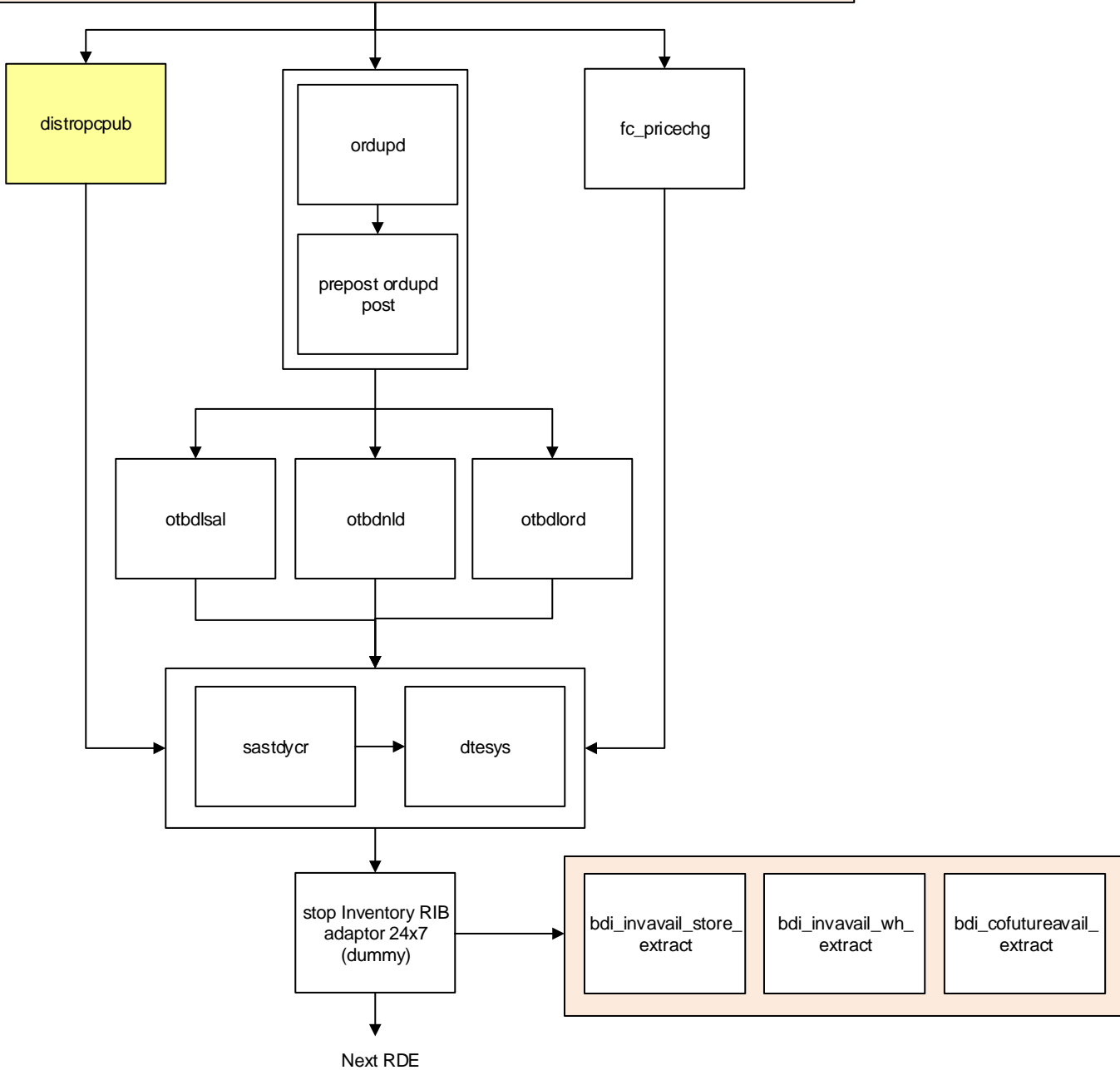
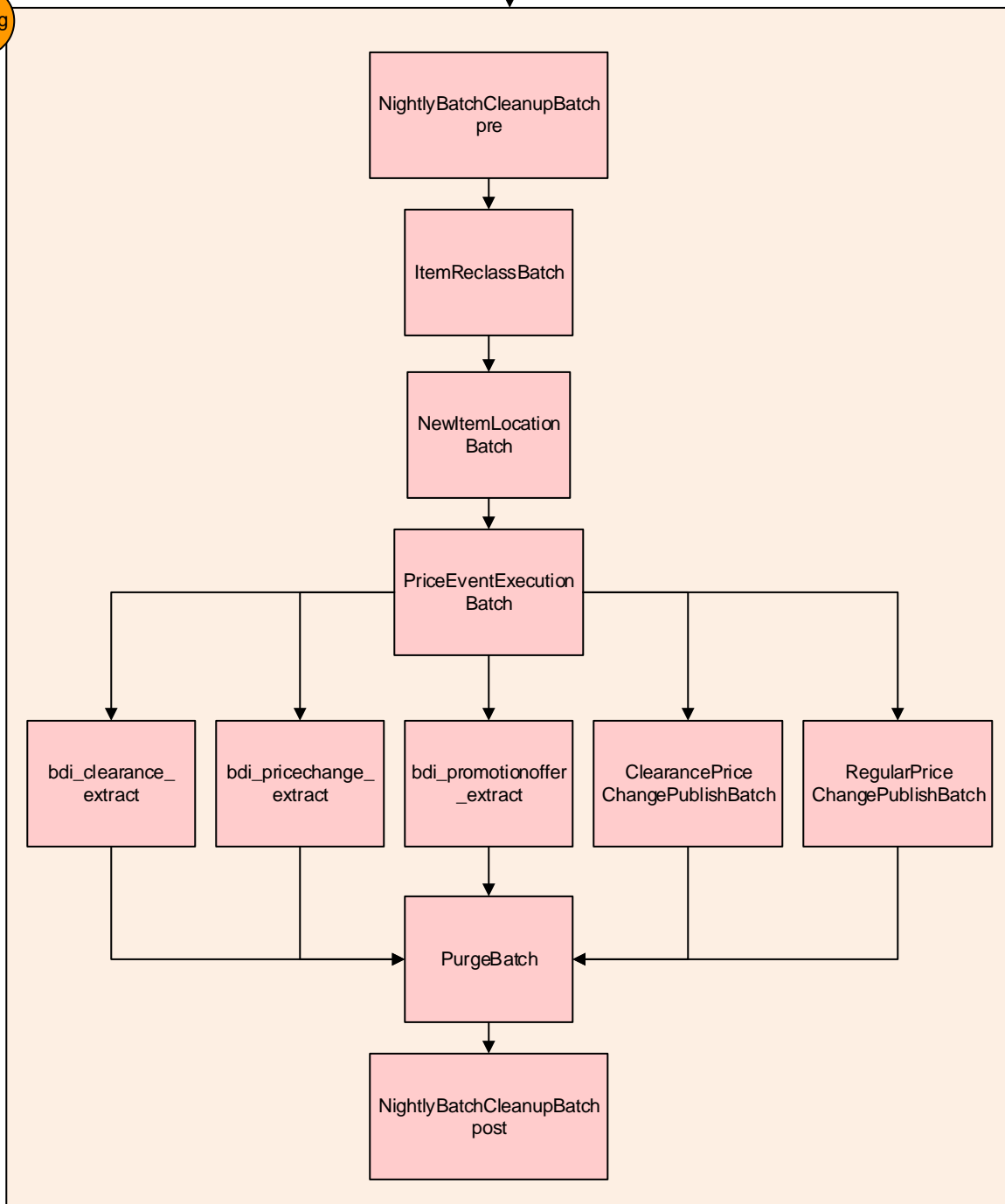



Back to Pricing

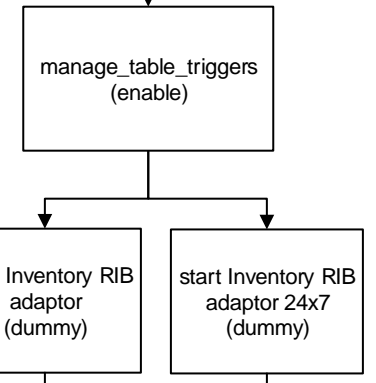
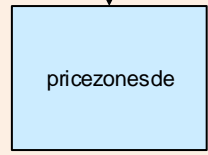
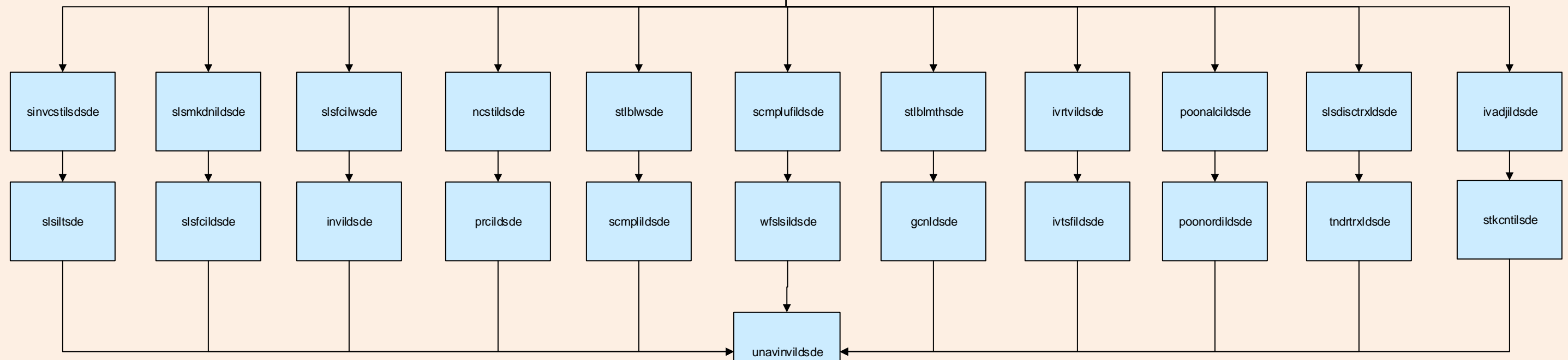
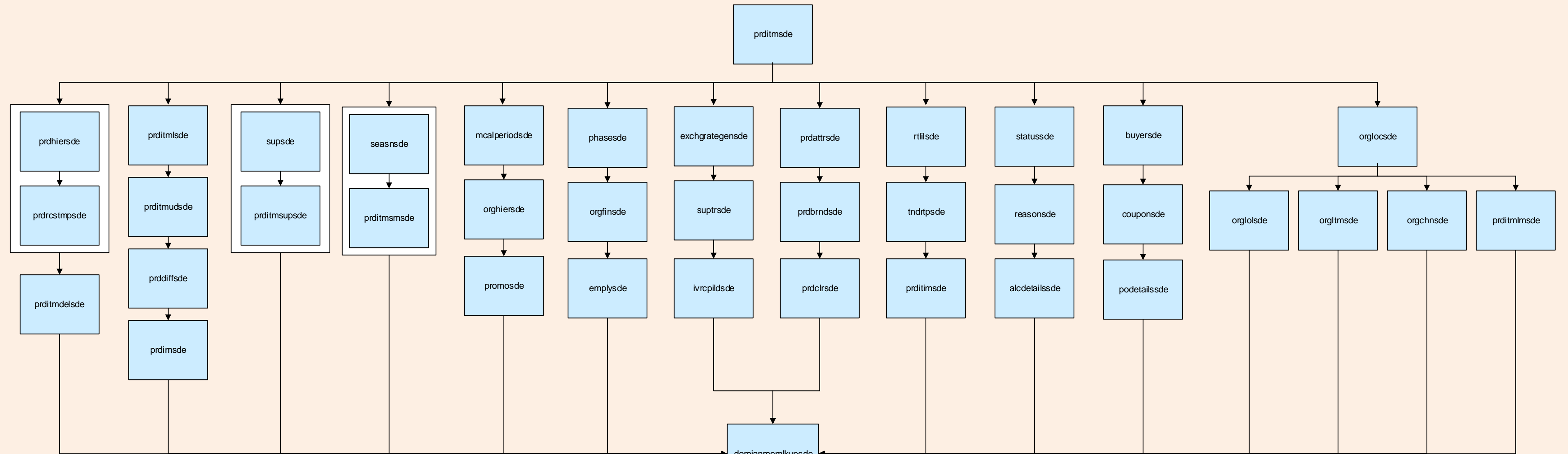

Next End Batch Cycle

## End Batch Cycle

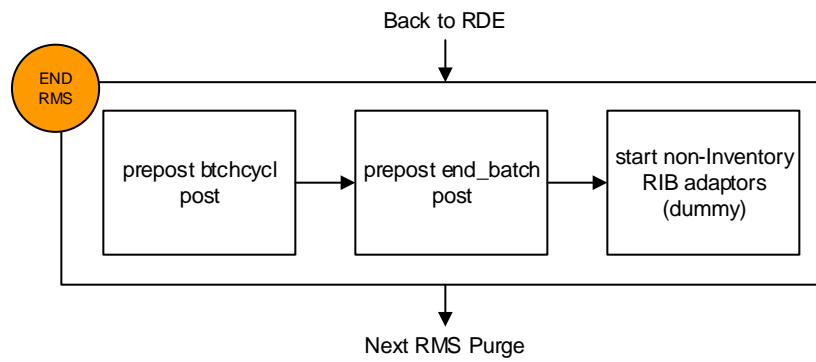

# RMS Purge

Back to End Batch Cycle

